

Fourier Series (2A)

- Fourier Series
-

Copyright (c) 2012 Young W. Lim.

Permission is granted to copy, distribute and/or modify this document under the terms of the GNU Free Documentation License, Version 1.2 or any later version published by the Free Software Foundation; with no Invariant Sections, no Front-Cover Texts, and no Back-Cover Texts. A copy of the license is included in the section entitled "GNU Free Documentation License".

Please send corrections (or suggestions) to youngwlim@hotmail.com.

This document was produced by using OpenOffice and Octave.

Fourier Series

$$f(x) = a_0 + \sum_{k=1}^{\infty} (a_k \cos kx + b_k \sin kx)$$

$$a_0 = \frac{1}{2\pi} \int_{-\pi}^{+\pi} f(x) dx$$

$$a_k = \frac{1}{\pi} \int_{-\pi}^{+\pi} f(x) \cos kx dx$$

$$b_k = \frac{1}{\pi} \int_{-\pi}^{+\pi} f(x) \sin kx dx$$

$$k = 1, 2, 3, \dots$$



one-sided spectrum
only positive frequencies

Trigonometric Identities

$$\cos \theta \cos \varphi = \frac{1}{2} (\cos(\theta - \varphi) + \cos(\theta + \varphi))$$

$$\sin \theta \sin \varphi = \frac{1}{2} (\cos(\theta - \varphi) - \cos(\theta + \varphi))$$

$$\sin \theta \cos \varphi = \frac{1}{2} (\sin(\theta + \varphi) + \sin(\theta - \varphi))$$

$$\cos \theta \sin \varphi = \frac{1}{2} (\sin(\theta + \varphi) - \sin(\theta - \varphi))$$

$$\frac{1}{2} (1 + \cos(\theta + \varphi)) \quad \text{when } \theta = \varphi$$

$$\frac{1}{2} (1 - \cos(\theta + \varphi)) \quad \text{when } \theta = \varphi$$

$$\frac{1}{2} (\sin(\theta + \varphi)) \quad \text{when } \theta = \varphi$$

$$\frac{1}{2} (\sin(\theta + \varphi)) \quad \text{when } \theta = \varphi$$

$$\int_{-\pi}^{+\pi} \cos n x \cos m x dx = 0 \quad (n \neq m)$$

$$\int_{-\pi}^{+\pi} \sin n x \sin m x dx = 0 \quad (n \neq m)$$

$$\int_{-\pi}^{+\pi} \sin n x \cos m x dx = 0$$

$$\int_{-\pi}^{+\pi} \cos n x \sin m x dx = 0$$

$$\int_{-\pi}^{+\pi} \cos n x \cos m x dx = \pi \quad (n = m)$$

$$\int_{-\pi}^{+\pi} \sin n x \sin m x dx = \pi \quad (n = m)$$

n, m : integer

Trigonometric Orthogonality

$$f(x) = a_0 + \sum_{k=1}^{\infty} (a_k \cos kx + b_k \sin kx)$$

$$a_0 = \frac{1}{2\pi} \int_{-\pi}^{+\pi} f(x) dx$$

$$a_k = \frac{1}{\pi} \int_{-\pi}^{+\pi} \underline{f(x) \cos kx} dx$$

$$b_k = \frac{1}{\pi} \int_{-\pi}^{+\pi} \underline{f(x) \sin kx} dx$$

$$k = 1, 2, 3, \dots$$

$$\int_{-\pi}^{+\pi} \cos nx \cos mx dx = 0 \quad (n \neq m)$$

$$\int_{-\pi}^{+\pi} \sin nx \sin mx dx = 0 \quad (n \neq m)$$

$$\int_{-\pi}^{+\pi} \sin nx \cos mx dx = 0$$

$$\int_{-\pi}^{+\pi} \cos nx \sin mx dx = 0$$

$$\int_{-\pi}^{+\pi} \underline{\cos nx \cos mx} dx = \pi \quad (n = m)$$

$$\int_{-\pi}^{+\pi} \underline{\sin nx \sin mx} dx = \pi \quad (n = m)$$

n, m : integer

$$a_k \leftarrow \underline{f(x) \cdot \cos kx} = a_0 \cdot \cos kx + \sum_{m=1}^{\infty} (a_m \underline{\cos mx \cdot \cos kx} + b_m \sin mx \cdot \cos kx)$$

$$b_k \leftarrow \underline{f(x) \cdot \sin kx} = a_0 \cdot \sin kx + \sum_{m=1}^{\infty} (a_m \cos mx \cdot \sin kx + b_m \underline{\sin mx \cdot \sin kx})$$

Period and Wavelength

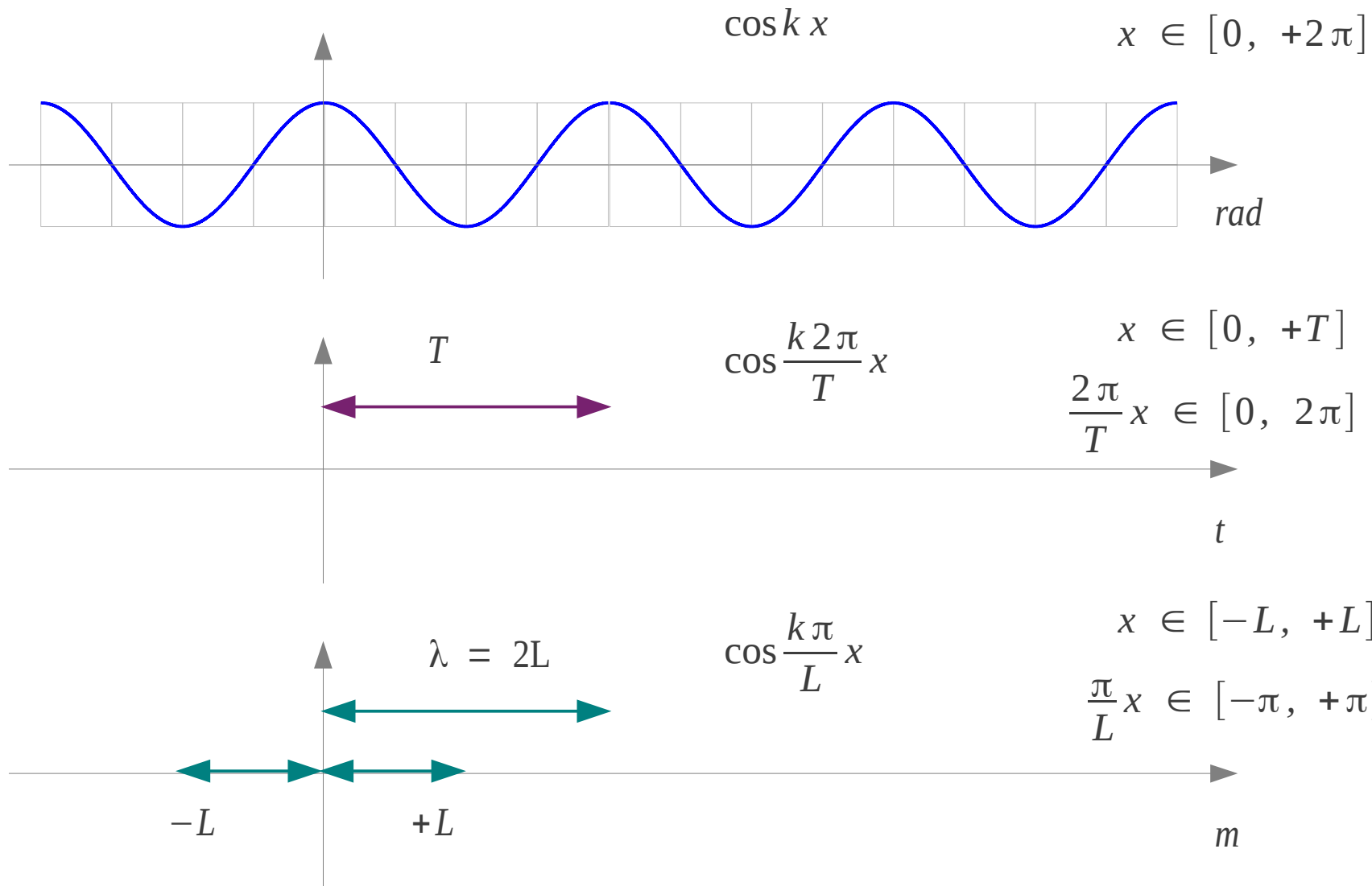

Any Period $2L$

$$g(v) = a_0 + \sum_{k=1}^{\infty} (a_k \cos kv + b_k \sin kv)$$

$$a_0 = \frac{1}{2\pi} \int_{-\pi}^{+\pi} g(v) dv$$

$$a_k = \frac{1}{\pi} \int_{-\pi}^{+\pi} g(v) \cos kv dv$$

$$b_k = \frac{1}{\pi} \int_{-\pi}^{+\pi} g(v) \sin kv dv$$

$k = 1, 2, \dots$

$$v: [-\pi, +\pi]$$

$$f(x) = a_0 + \sum_{k=1}^{\infty} \left(a_k \cos \frac{k\pi}{L} x + b_k \sin \frac{k\pi}{L} x \right)$$

$$a_0 = \frac{1}{2L} \int_{-L}^{+L} f(x) dx$$

$$a_k = \frac{1}{L} \int_{-L}^{+L} f(x) \cos \frac{k\pi x}{L} dx$$

$$b_k = \frac{1}{L} \int_{-L}^{+L} f(x) \sin \frac{k\pi x}{L} dx$$

$k = 1, 2, 3, \dots$

$$x: [-L, +L]$$

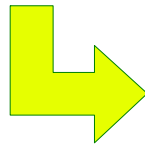

$$v = \frac{\pi}{L} x$$
$$dv = \frac{\pi}{L} dx$$

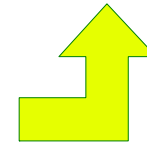

Any Period $2p$

$$f(x) = a_0 + \sum_{k=1}^{\infty} \left(a_k \cos \frac{k\pi}{L} x + b_k \sin \frac{k\pi}{L} x \right)$$

$$a_0 = \frac{1}{2L} \int_{-L}^{+L} f(x) dx$$

$$a_k = \frac{1}{L} \int_{-L}^{+L} f(x) \cos \frac{k\pi x}{L} dx$$

$$b_k = \frac{1}{L} \int_{-L}^{+L} f(x) \sin \frac{k\pi x}{L} dx$$

$k = 1, 2, 3, \dots$

$$x: [-L, +L]$$

$$f(x) = \frac{a_0}{2} + \sum_{n=1}^{\infty} \left(a_n \cos \frac{n\pi}{p} x + b_n \sin \frac{n\pi}{p} x \right)$$

$$a_0 = \frac{1}{p} \int_{-p}^{+p} f(x) dx$$

$$a_n = \frac{1}{p} \int_{-p}^{+p} f(x) \cos \frac{n\pi x}{p} dx$$

$$b_n = \frac{1}{p} \int_{-p}^{+p} f(x) \sin \frac{n\pi x}{p} dx$$

$n = 1, 2, 3, \dots$

$$x: [-p, +p]$$

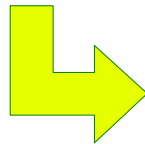

$$k \rightarrow n$$
$$a_0 \rightarrow \frac{a_0}{2}$$

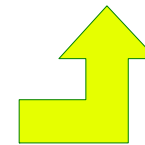

Time and Frequency

$$f(x) = a_0 + \sum_{k=1}^{\infty} \left(a_k \cos \frac{k\pi}{L} x + b_k \sin \frac{k\pi}{L} x \right)$$

$$a_0 = \frac{1}{2L} \int_{-L}^{+L} f(x) dx$$

$$a_k = \frac{1}{L} \int_{-L}^{+L} f(x) \cos \frac{k\pi x}{L} dx$$

$$b_k = \frac{1}{L} \int_{-L}^{+L} f(x) \sin \frac{k\pi x}{L} dx$$

$k = 1, 2, 3, \dots$

$$x: [-L, +L]$$

$$x(t) = a_0 + \sum_{k=1}^{\infty} \left(a_k \cos \frac{2\pi k}{T} t + b_k \sin \frac{2\pi k}{T} t \right)$$

$$a_0 = \frac{1}{T} \int_0^T x(t) dt$$

$$a_k = \frac{2}{T} \int_0^T x(t) \cos \frac{2\pi k t}{T} dt$$

$$b_k = \frac{2}{T} \int_0^T x(t) \sin \frac{2\pi k t}{T} dt$$

$k = 1, 2, \dots$

$$t: [0, T]$$

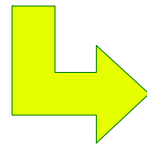

$$2L = T$$

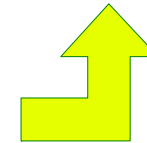

Continuous Time Periodic Signal $x(t)$

Harmonic Frequency

$$x(t) = a_0 + \sum_{k=1}^{\infty} \left(a_k \cos \frac{2\pi k}{T} t + b_k \sin \frac{2\pi k}{T} t \right)$$

$$a_0 = \frac{1}{T} \int_0^T x(t) dt$$

$$a_k = \frac{2}{T} \int_0^T x(t) \cos \frac{2\pi k t}{T} dt$$

$$b_k = \frac{2}{T} \int_0^T x(t) \sin \frac{2\pi k t}{T} dt$$

$k = 1, 2, \dots$

$$t: [0, T]$$

resolution frequency

n-th harmonic frequency

$$x(t) = a_0 + \sum_{k=1}^{\infty} \left(a_k \cos(2\pi k f_0 t) + b_k \sin(2\pi k f_0 t) \right)$$

$$a_0 = \frac{1}{T} \int_0^T x(t) dt$$

$$a_k = \frac{2}{T} \int_0^T x(t) \cos(2\pi k f_0 t) dt \quad k = 1, 2, \dots$$

$$b_k = \frac{2}{T} \int_0^T x(t) \sin(2\pi k f_0 t) dt \quad k = 1, 2, \dots$$

$$t: [0, T]$$

$$f_0 = \frac{1}{T}$$

$$f_n = n f_0 = n \frac{1}{T}$$

Radial Frequency

$$x(t) = a_0 + \sum_{n=1}^{\infty} (a_n \cos(k 2\pi f_0 t) + b_n \sin(k 2\pi f_0 t))$$

$$a_0 = \frac{1}{T} \int_0^T x(t) dt$$

$$a_k = \frac{2}{T} \int_0^T x(t) \cos(k 2\pi f_0 t) dt \quad k = 1, 2, \dots$$

$$b_k = \frac{2}{T} \int_0^T x(t) \sin(k 2\pi f_0 t) dt \quad k = 1, 2, \dots$$

$$t: [0, T]$$

linear frequency

angular (radial) frequency

$$x(t) = a_0 + \sum_{n=1}^{\infty} (a_n \cos(k \omega_0 t) + b_n \sin(k \omega_0 t))$$

$$a_0 = \frac{1}{T} \int_0^T x(t) dt$$

$$a_k = \frac{2}{T} \int_0^T x(t) \cos(k \omega_0 t) dt$$

$$b_k = \frac{2}{T} \int_0^T x(t) \sin(k \omega_0 t) dt$$

$$k = 1, 2, \dots$$

$$t: [0, T]$$

f

$$\omega = 2\pi f$$

Complex Fourier Series Coefficients

$$x(t) = a_0 + \sum_{k=1}^{\infty} (a_k \cos(k \omega_0 t) + b_k \sin(k \omega_0 t))$$

$$a_0 = \frac{1}{T} \int_0^T x(t) dt$$

$$a_k = \frac{2}{T} \int_0^T x(t) \cos(k \omega_0 t) dt$$

$$b_k = \frac{2}{T} \int_0^T x(t) \sin(k \omega_0 t) dt$$

$$k = 1, 2, \dots$$

$$t: [0, T]$$

Real coefficients

$$a_0, a_k, b_k, k = 1, 2, \dots$$

Complex coefficients

$$A_0, A_k, B_k, k = 1, 2, \dots$$

$$x(t) = A_0 + \sum_{k=1}^{\infty} (A_k e^{jk \omega_0 t} + B_k e^{-jk \omega_0 t})$$

$$A_0 = \frac{1}{T} \int_0^T x(t) dt$$

$$A_k = \frac{1}{T} \int_0^T x(t) e^{-jk \omega_0 t} dt$$

$$B_k = \frac{1}{T} \int_0^T x(t) e^{+jk \omega_0 t} dt$$

$$t: [0, T]$$

one-sided spectrum

only positive frequencies

two-sided spectrum

Both pos and neg frequencies

Euler Equation (1)

$$x(t) = a_0 + \sum_{k=1}^{\infty} (a_k \cos(k \omega_0 t) + b_k \sin(k \omega_0 t))$$

$$a_0 = \frac{1}{T} \int_0^T x(t) dt$$

$$a_k = \frac{2}{T} \int_0^T x(t) \cos(k \omega_0 t) dt$$

$$b_k = \frac{2}{T} \int_0^T x(t) \sin(k \omega_0 t) dt$$

$k = 1, 2, \dots$

$$e^{+j\omega t} = \cos \omega t + j \sin \omega t$$

$$e^{-j\omega t} = \cos \omega t - j \sin \omega t$$

$$\cos \omega t = \frac{e^{j\omega t} + e^{-j\omega t}}{2}$$

$$\sin \omega t = \frac{e^{j\omega t} - e^{-j\omega t}}{2j}$$

$$\begin{aligned} & a_k \cos(k \omega_0 t) + b_k \sin(k \omega_0 t) \\ &= a_k \frac{1}{2} (e^{jk\omega_0 t} + e^{-jk\omega_0 t}) + b_k \frac{1}{2j} (e^{jk\omega_0 t} - e^{-jk\omega_0 t}) \\ &= \frac{(a_k - jb_k)}{2} e^{jk\omega_0 t} + \frac{(a_k + jb_k)}{2} e^{-jk\omega_0 t} \\ &= A_k e^{jk\omega_0 t} + B_k e^{-jk\omega_0 t} \end{aligned}$$

$$x(t) = A_0 + \sum_{k=1}^{\infty} (A_k e^{jk\omega_0 t} + B_k e^{-jk\omega_0 t})$$

zero freq	→	A_0	=	a_0	}	only positive frequencies
pos freq	→	A_k	=	$\frac{1}{2} (a_k - jb_k)$		
neg freq	→	B_k	=	$\frac{1}{2} (a_k + jb_k)$		

Euler Equation (2)

$$x(t) = a_0 + \sum_{k=1}^{\infty} (a_k \cos(k \omega_0 t) + b_k \sin(k \omega_0 t))$$

$$a_0 = \frac{1}{T} \int_0^T x(t) dt$$

$$a_k = \frac{2}{T} \int_0^T x(t) \cos(k \omega_0 t) dt$$

$$b_k = \frac{2}{T} \int_0^T x(t) \sin(k \omega_0 t) dt$$

$$k = 1, 2, \dots$$

$$x(t) = A_0 + \sum_{k=1}^{\infty} (A_k e^{jk\omega_0 t} + B_k e^{-jk\omega_0 t})$$

zero freq	→	$A_0 = a_0$	} only positive frequencies
pos freq	→	$A_k = \frac{1}{2} (a_k - jb_k)$	
neg freq	→	$B_k = \frac{1}{2} (a_k + jb_k)$	

$$A_k = \frac{1}{T} \int_0^T x(t) (\cos(k \omega_0 t) - j \sin(k \omega_0 t)) dt$$

$$B_k = \frac{1}{T} \int_0^T x(t) (\cos(k \omega_0 t) + j \sin(k \omega_0 t)) dt$$



$$A_k = \frac{1}{T} \int_0^T x(t) e^{-jk\omega_0 t} dt$$

$$B_k = \frac{1}{T} \int_0^T x(t) e^{+jk\omega_0 t} dt$$

$$x(t) = A_0 + \sum_{k=1}^{\infty} (A_k e^{+jk\omega_0 t} + B_k e^{-jk\omega_0 t})$$



$$x(t) = \sum_{k=0}^{\infty} (A_k e^{+jk\omega_0 t} + B_k e^{-jk\omega_0 t})$$

Complex Fourier Series (1)

$$x(t) = a_0 + \sum_{k=1}^{\infty} (a_k \cos(k \omega_0 t) + b_k \sin(k \omega_0 t))$$

$$a_0 = \frac{1}{T} \int_0^T x(t) dt$$

$$a_k = \frac{2}{T} \int_0^T x(t) \cos(k \omega_0 t) dt$$

$$b_k = \frac{2}{T} \int_0^T x(t) \sin(k \omega_0 t) dt$$
$$k = 1, 2, \dots$$

$$x(t) = A_0 + \sum_{k=1}^{\infty} (A_k e^{jk\omega_0 t} + B_k e^{-jk\omega_0 t})$$

$$A_0 = a_0$$

$$A_k = \frac{1}{2} (a_k - jb_k)$$

$$B_k = \frac{1}{2} (a_k + jb_k)$$

$$k = 1, 2, \dots$$

$$x(t) = \sum_{k=0}^{\infty} (A_k e^{jk\omega_0 t} + B_k e^{-jk\omega_0 t})$$

$$A_k = \frac{1}{T} \int_0^T x(t) e^{-jk\omega_0 t} dt$$
$$k = 0, 1, 2, \dots$$

$$B_k = \frac{1}{T} \int_0^T x(t) e^{+jk\omega_0 t} dt$$
$$k = 1, 2, \dots$$

$$x(t) = \sum_{k=-\infty}^{+\infty} C_k e^{jk\omega_0 t}$$

$$C_k = \frac{1}{T} \int_0^T x(t) e^{-jk\omega_0 t} dt$$
$$k = -2, -1, 0, +1, +2, \dots$$

$$C_k = \begin{cases} A_0 & (k = 0) \\ A_k & (k > 0) \\ B_k & (k < 0) \end{cases}$$

Complex Fourier Series (2)

$$x(t) = \sum_{k=-\infty}^{+\infty} C_k e^{+jk\omega_0 t}$$

$$C_k = \frac{1}{T} \int_0^T x(t) e^{-jk\omega_0 t} dt$$

$$k = -2, -1, 0, +1, +2, \dots$$

$$x(t) = \sum_{k=-\infty}^{+\infty} C_k e^{+jk\frac{2\pi}{T}t}$$

$$C_k = \frac{1}{T} \int_0^T x(t) e^{-jk\frac{2\pi}{T}t} dt$$

$$k = -2, -1, 0, +1, +2, \dots$$

$$f(x) = \sum_{n=-\infty}^{+\infty} c_n e^{+jn\pi x/p}$$

$$c_n = \frac{1}{2p} \int_{-p}^{+p} f(x) e^{-jn\pi x/p} dx$$

$$n = -2, -1, 0, +1, +2, \dots$$

Square Wave CTFS (1)

Continuous Time Fourier Series

$$C_k = \frac{1}{T} \int_0^T x(t) e^{-jk\omega_0 t} dt \quad \longleftrightarrow \quad x(t) = \sum_{n=0}^{\infty} C_k e^{+jk\omega_0 t}$$

$$C_k = \frac{1}{T_0} \int_{-T_0/2}^{+T_0/2} x_{T_0}(t) e^{-jk\omega_0 t} dt$$

$$C_k T_0 = \int_{-T_0/2}^{+T_0/2} x_{T_0}(t) e^{-jk\omega_0 t} dt$$

$$= \int_{-T_0/2}^{+T_0/2} e^{-jk\omega_0 t} dt = \left[\frac{-1}{jk\omega_0} e^{-jk\omega_0 t} \right]_{-T/2}^{+T/2}$$

$$= -\frac{e^{-jk\omega_0 T/2} - e^{+jk\omega_0 T/2}}{jk\omega_0} = \frac{\sin(k\omega_0 T/2)}{k\omega_0/2}$$

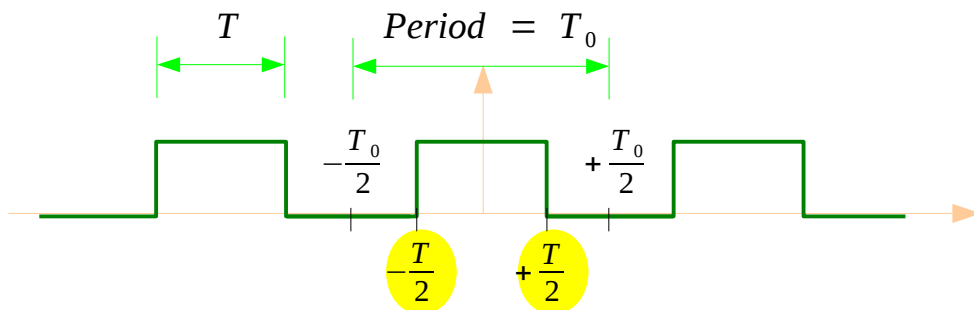

Fundamental Frequency

$$\omega_0 = \frac{2\pi}{T_0}$$

$$\omega_0 T_0 = 2\pi \quad \leftarrow \quad \frac{T_0}{T} = \frac{2}{1}$$

$$\omega_0 T = \pi$$

$$\omega_0 T = 2\pi \frac{T}{T_0}$$

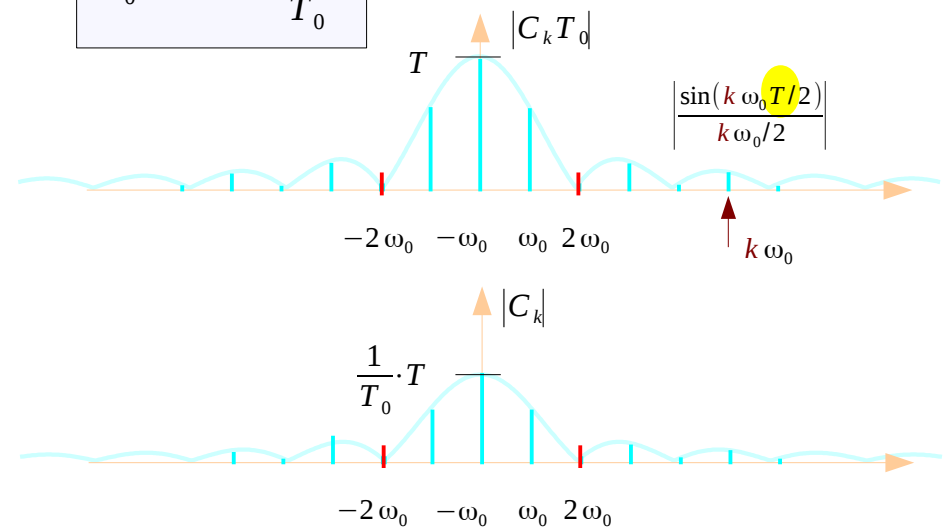

Square Wave CTFS (2)

$$C_k = \frac{1}{T_0} \cdot \frac{\sin(k \omega_0 T/2)}{k \omega_0/2} = \frac{1}{T_0} \cdot \frac{\sin(T k \omega_0/2)}{k \omega_0/2}$$

$$C_k = 0 \quad \rightarrow \quad \sin(k \omega_0 T/2) = 0$$

$$\sin\left(k \frac{2\pi T}{T_0} \frac{T}{2}\right) = 0 \quad \rightarrow \quad \sin(\pm n\pi) = 0$$

$$k = \pm n \frac{T_0}{T} \quad \rightarrow \quad \omega = k \omega_0 = \pm n \frac{T_0}{T} \omega_0$$

$$C_0 = \lim_{k \rightarrow 0} \frac{1}{T_0} \cdot \frac{\sin(T k \omega_0/2)}{k \omega_0/2}$$

$$C_0 = \lim_{k \rightarrow 0} \frac{1}{T_0} \cdot \frac{(T \omega_0/2) \cos(T k \omega_0/2)}{\omega_0/2} = \frac{T}{T_0}$$

$$\omega_0 = \frac{2\pi}{T_0}$$

$$\omega_0 \frac{T_0}{T} = \frac{2\pi}{T}$$

$$\omega_0 T = 2\pi \frac{T}{T_0}$$

$$C_k = \frac{1}{T_0} \cdot \frac{\sin(k \omega_0 T/2)}{k \omega_0/2}$$

$$C_0 = \frac{T}{T_0}$$

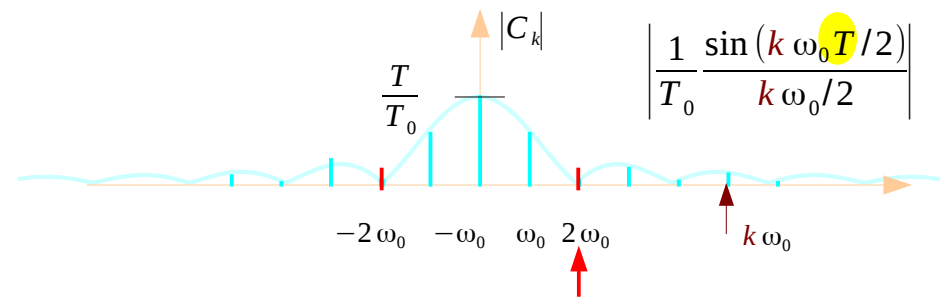
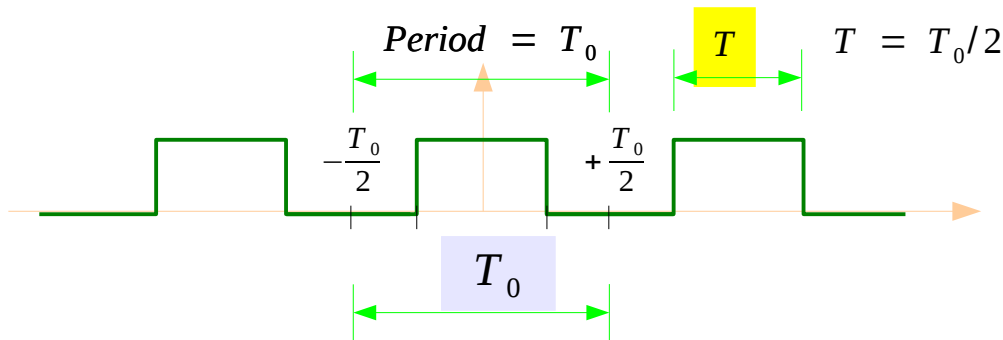

Square Wave CTFS (3)

$$C_k = \frac{1}{T_0} \frac{\sin(k\omega_0 T/2)}{k\omega_0/2}$$

$$C_0 = \frac{T}{T_0}$$

$$\omega_0 = \frac{2\pi}{T_0}$$

$$\omega_0 \frac{T_0}{T} = \frac{2\pi}{T}$$

$$\omega_0 T = 2\pi \frac{T}{T_0}$$

$$\omega = k\omega_0 = \pm n \frac{T_0}{T} \omega_0 \quad \rightarrow$$

$$C_k = 0 \quad \left(k = \pm n \frac{T_0}{T} \right) \quad \uparrow$$

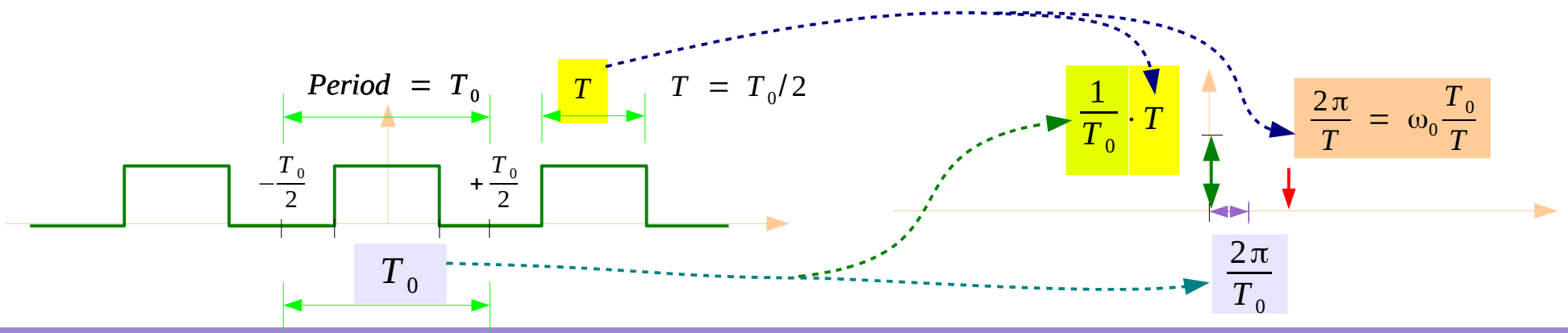
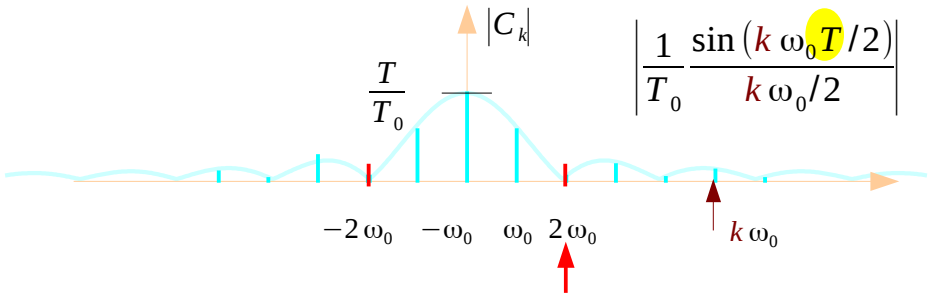

Square Wave CTFS (4)

Continuous Time Fourier Series

$$C_k = \frac{1}{T} \int_0^T x(t) e^{-jk\omega_0 t} dt \quad \longleftrightarrow \quad x(t) = \sum_{n=0}^{\infty} C_k e^{+jk\omega_0 t}$$

$$C_k = \frac{1}{T_0} \int_0^{+T_0} x_{T_0}(t) e^{-jk\omega_0 t} dt$$

$$C_k T_0 = \int_0^{+T_0} x_{T_0}(t) e^{-jk\omega_0 t} dt$$

$$\begin{aligned} &= \int_0^{+T} e^{-jk\omega_0 t} dt = \left[\frac{-1}{jk\omega_0} e^{-jk\omega_0 t} \right]_0^{+T} \\ &= -\frac{e^{-jk\omega_0 T} - e^0}{jk\omega_0} = \frac{1 - e^{-jk\omega_0 T}}{jk\omega_0} = \frac{1 - e^{-jk2\pi T/T_0}}{jk2\pi/T_0} \end{aligned}$$

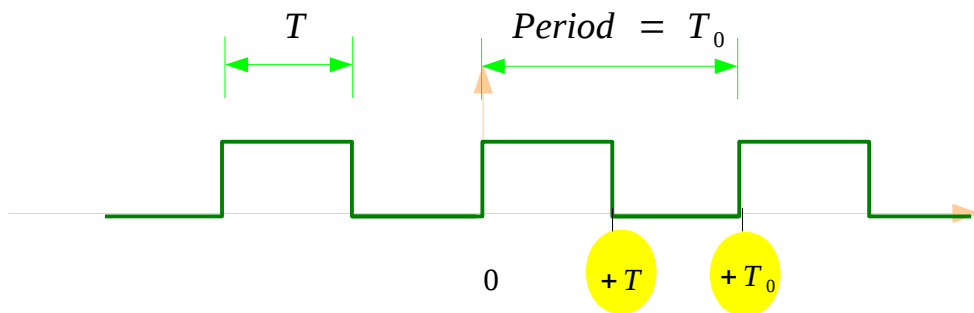

Fundamental Frequency

$$\omega_0 = \frac{2\pi}{T_0} \quad \omega_0 T_0 = 2\pi \quad \frac{T_0}{T} = \frac{2}{1}$$

$$\omega_0 T = \pi$$

$$\omega_0 T = 2\pi \frac{T}{T_0}$$

$$C_k T_0 = \frac{1 - e^{-jk2\pi T/T_0}}{jk2\pi/T_0} \quad \rightarrow \quad C_k = \frac{1 - (-1)^k}{j2\pi k}$$

$$C_0 T_0 = \int_0^{+T} e^{-j0\omega_0 t} dt = T \quad \rightarrow \quad C_0 = \frac{1}{2}$$

C_{-4}	C_{-3}	C_{-2}	C_{-1}	C_0	C_1	C_2	C_3	C_4
0	$\frac{-1}{j3\pi}$	0	$\frac{-1}{j\pi}$	$\frac{1}{2}$	$\frac{1}{j\pi}$	0	$\frac{1}{j3\pi}$	0

Square Wave CTFS (5)

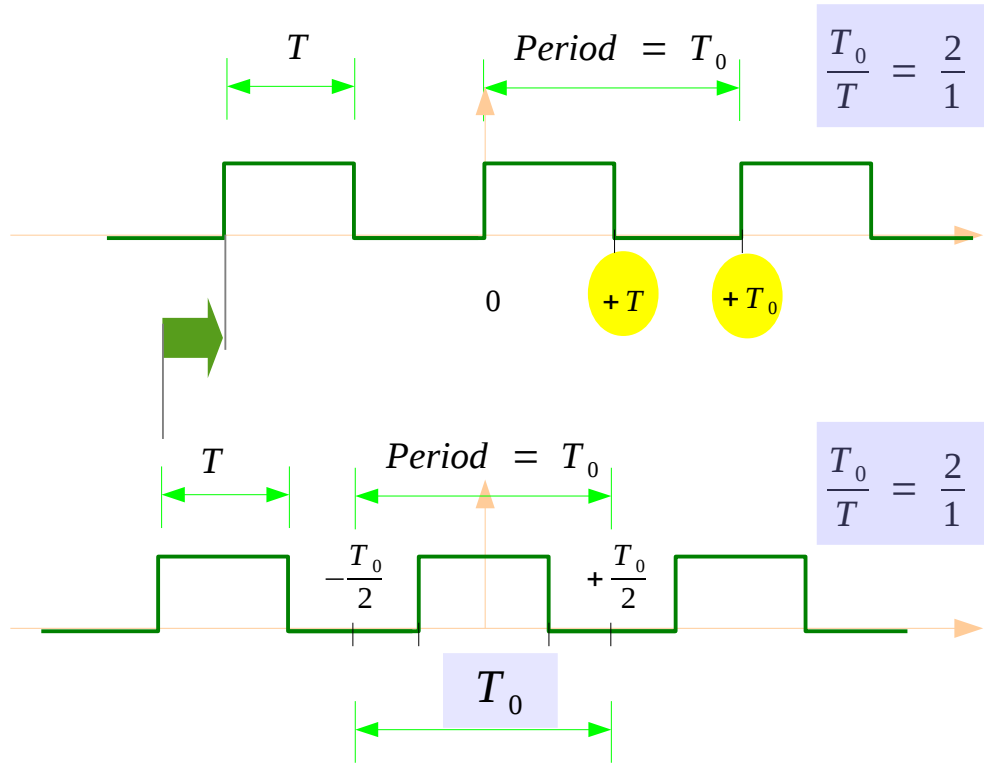

$$C_k = \frac{1 - e^{-jk2\pi T/T_0}}{jk2\pi}$$

$$C_0 = \frac{T}{T_0}$$

$$e^{+jk\omega_0 T/2}$$

$$C_k = \frac{1}{T_0} \cdot \frac{\sin(k\omega_0 T/2)}{k\omega_0/2}$$

$$C_0 = \frac{T}{T_0}$$

$$\frac{1}{T_0} \cdot \frac{\sin(k\omega_0 T/2)}{k\omega_0/2} = \frac{\sin(k\pi T/T_0)}{k\pi} = \frac{(e^{+jk\pi T/T_0} - e^{-jk\pi T/T_0})}{jk2\pi}$$

$$= e^{+jk\pi T/T_0} \left(\frac{1 - e^{-jk2\pi T/T_0}}{jk2\pi} \right) = e^{+jk\omega_0 T/2} \left(\frac{1 - e^{-jk2\pi T/T_0}}{jk2\pi} \right)$$

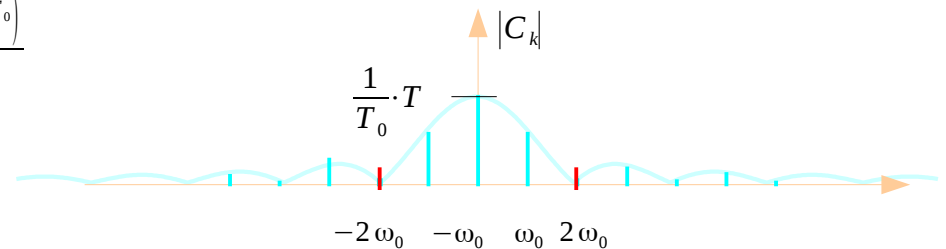

Fourier Cosine and Sine Series

$$f(x) = \frac{a_0}{2} + \sum_{n=1}^{\infty} a_n \cos \frac{n\pi}{p} x$$

$$a_0 = \frac{2}{p} \int_0^p f(x) dx$$

$$a_n = \frac{2}{p} \int_0^p f(x) \cos \frac{n\pi}{L} x dx$$
$$n = 1, 2, 3, \dots$$

$$f(x) = b_n \sin \frac{n\pi}{p} x$$

$$\frac{2}{p} \int_0^p f(x) \sin \frac{n\pi}{p} x dx$$
$$n = 1, 2, 3, \dots$$

Orthogonal Functions

Inner Product of Functions

$$(f_1, f_2) = \int_a^b f_1(x)f_2(x)dx$$

Orthogonal Functions

$$(f_1, f_2) = \int_a^b f_1(x)f_2(x)dx = 0$$

Orthogonal Sets

$$\{\Phi_0(x), \Phi_1(x), \Phi_2(x), \dots\} \quad \text{Orthogonal}$$

$$(\Phi_m, \Phi_n) = \int_a^b \Phi_m(x)\Phi_n(x)dx = 0, \quad m \neq n$$

Orthogonal Series Expansion

$$f(x) = c_0 \Phi_0(x) + c_1 \Phi_1(x) + \cdots + c_n \Phi_n(x) + \cdots$$

$$\begin{aligned} \int_a^b f(x) \Phi_m(x) dx &= c_0 \int_a^b \Phi_0(x) \Phi_m(x) dx + c_1 \int_a^b \Phi_1(x) \Phi_m(x) dx + \cdots + c_n \int_a^b \Phi_n(x) \Phi_m(x) dx + \cdots \\ &= c_0 (\Phi_0, \Phi_m) + c_1 (\Phi_1, \Phi_m) + \cdots + c_n (\Phi_n, \Phi_m) + \cdots \end{aligned}$$

$$\int_a^b f(x) \Phi_n(x) dx = c_n \int_a^b \Phi_n^2(x) dx \qquad c_n = \frac{\int_a^b f(x) \Phi_n(x) dx}{\int_a^b \Phi_n^2(x) dx} \qquad n = 0, 1, 2, \dots$$

$$f(x) = \sum_{n=0}^{\infty} c_n \Phi_n(x) \qquad f(x) = \sum_{n=0}^{\infty} \frac{(f, \Phi_n)}{\|\Phi_n\|^2} \Phi_n(x)$$

$$c_n = \frac{\int_a^b f(x) \Phi_n(x) dx}{\|\Phi_n(x)\|^2}$$

Generalized Fourier Series Expansion

Orthogonal with respect to a weight Functions

$$\int_a^b w(x) \Phi_m(x) \Phi_n(x) dx = 0 \quad m \neq n$$

$$c_n = \frac{\int_a^b w(x) f(x) \Phi_n(x) dx}{\|\Phi_n(x)\|^2}$$

$$\|\Phi_n(x)\|^2 = \int_a^b w(x) \Phi_n^2(x) dx$$

Inner Product Space

Hilbert Space real / complex inner product space

$$\langle f, g \rangle = \int_a^b f(t) \overline{g(t)} dt$$

complex conjugate

$$\langle y, x \rangle = \overline{\langle x, y \rangle}$$

linear

$$\langle a x_1 + b x_2, y \rangle = a \langle x_1, y \rangle + b \langle x_2, y \rangle$$

positive semidefinite

$$\langle x, x \rangle \geq 0$$

Norm

$$\|x\| = \sqrt{\langle x, x \rangle}$$

Cauchy-Schwartz Inequality

$$|\langle x, y \rangle| \leq \|x\| \|y\|$$

Orthogonality

$$x(t) = \sum_{k=-\infty}^{+\infty} C_k e^{jk\omega_0 t}$$

$$C_k = \frac{1}{T} \int_0^T x(t) e^{-jk\omega_0 t} dt$$

$$k = \dots, -2, -1, 0, +1, +2, \dots$$

fundamental frequency $f_0 = \frac{1}{T}$

$$\omega_0 = 2\pi f_0 = \frac{2\pi}{T}$$

n-th harmonic frequency $f_n = n f_0$

$$\omega_n = 2\pi f_n = \frac{2\pi n}{T}$$

$$\langle e^{jm\omega_0 t}, e^{jn\omega_0 t} \rangle = \int_0^T e^{j(m-n)\omega_0 t} dt = \begin{cases} 0 & (m \neq n) \\ T & (m = n) \end{cases} \quad m, n : \text{integer}$$

Inner Product Examples

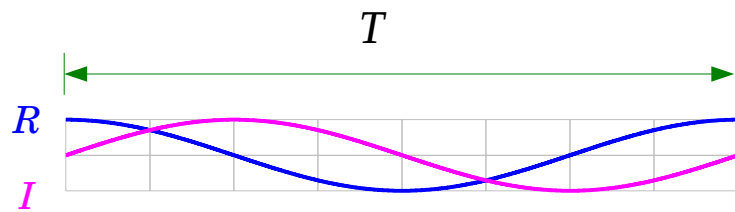

$$f_0 = 1/T$$

$$\omega_0 = 2\pi/T$$

$$\leftarrow e^{j1\omega_0 t}$$

$$\langle e^{j1\omega_0 t}, e^{j1\omega_0 t} \rangle = \int_0^T e^{+j(1-1)\omega_0 t} dt = T \quad \leftarrow$$



$$\langle e^{j1\omega_0 t}, e^{j-1\omega_0 t} \rangle = \int_0^T e^{+j(1+1)\omega_0 t} dt = 0 \quad \leftarrow$$

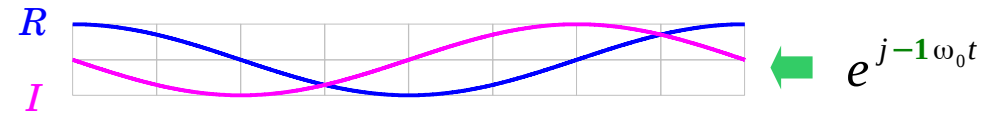

$$\langle e^{j1\omega_0 t}, e^{j2\omega_0 t} \rangle = \int_0^T e^{+j(1-2)\omega_0 t} dt = 0 \quad \leftarrow$$

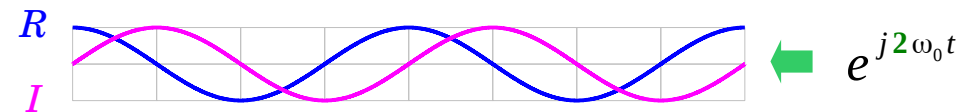

$$\langle e^{j1\omega_0 t}, e^{j-2\omega_0 t} \rangle = \int_0^T e^{+j(1+2)\omega_0 t} dt = 0 \quad \leftarrow$$

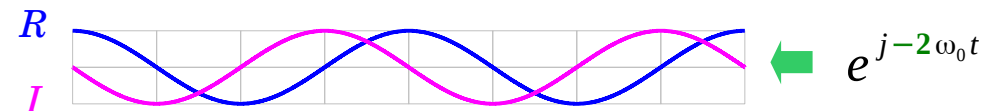

References

- [1] <http://en.wikipedia.org/>
- [2] <http://planetmath.org/>
- [3] M.L. Boas, “Mathematical Methods in the Physical Sciences”
- [4] D.G. Zill, “Advanced Engineering Mathematics”