

PrintSuite for iSeries



# Advanced Print Utility User's Guide



PrintSuite for iSeries



# Advanced Print Utility User's Guide

**Note!**

Before using this information and the product it supports, be sure to read the general information in "Notices" on page 133.

**Fourth Edition (May 2002)**

This edition applies to the licensed program *IBM PrintSuite for iSeries: Advanced Print Utility* (Program number 5798-AF2), and to all subsequent releases and modifications until otherwise indicated in new editions or technical newsletters. Be sure to use the correct edition for the level of the product.

Order publications through your IBM representative or the IBM branch office serving your locality. Publications are not stocked at the address given below.

The IBM Printing Systems Company welcomes your comments. A form for reader's comments is provided at the back of this publication. If the form has been removed, you may send your comments to the following address:

INFORMATION DEVELOPMENT  
IBM PRINTING SYSTEMS  
DEPARTMENT H7FE BUILDING 004M  
PO BOX 1900 BOULDER CO 80301-9191

If you prefer to send comments electronically, use one of the following methods:

- Internet: [printpub@us.ibm.com](mailto:printpub@us.ibm.com)
- Fax: 1-800-524-1519 within the U.S. or 1-303-924-6873 outside U.S.

**Internet**

Visit our home page at <http://www.ibm.com/printers>

When you send information to IBM, you grant IBM a nonexclusive right to use or distribute the information in any way it believes appropriate without incurring any obligation to you.

© **Copyright International Business Machines Corporation 1996, 2002. All rights reserved.**

US Government Users Restricted Rights - Use, duplication or disclosure restricted by GSA ADP Schedule Contract with IBM Corp.

---

# Contents

Figures . . . . . v

Tables . . . . . vii

**Purpose of this Publication . . . . . ix**

APU Enhancements . . . . . ix

Organization of the Manual . . . . . ix

---

## **Part 1. Understanding and Preparing to Use APU. . . . . 1**

### **Chapter 1. Introducing Advanced Print Utility . . . . . 3**

What is APU? . . . . . 3

What You Can Do with APU . . . . . 3

Why Use APU? . . . . . 4

Printing with and without APU . . . . . 4

    Printing without APU . . . . . 4

    Printing with APU . . . . . 5

APU formatting instructions . . . . . 6

Steps in Creating an APU Document . . . . . 7

    Step 1: Analyzing the Existing Application . . . . . 8

    Step 2: Locating Required AFP Resources . . . . . 9

    Step 3: Using APU to Create a Print Definition . . . . . 9

    Step 4: Printing with the Print Definition . . . . . 10

### **Chapter 2. Preparing to Use the Advanced Print Utility . . . . . 13**

APU Prerequisites and Options . . . . . 13

    Required . . . . . 13

    Recommended . . . . . 13

    Optional . . . . . 13

Initial APU Setup . . . . . 14

Font Installation Considerations . . . . . 16

Review Document Resource Requirements . . . . . 16

Using Fonts with APU . . . . . 18

    Outline Fonts . . . . . 20

    Custom Fonts . . . . . 21

Image Resources . . . . . 24

    How APU Works with Image Resources . . . . . 24

    Building Image Resources . . . . . 26

Overlay Resources . . . . . 26

    How APU Works with Overlays . . . . . 27

    Building Overlay Resources . . . . . 29

Bar Code Resources . . . . . 29

    Code 3 of 9 Bar Code Example . . . . . 30

    POSTNET (Postal Bar Code) Bar Code Example . . . . . 30

    How APU Works with Bar Codes . . . . . 30

---

## **Part 2. Creating Print Definitions with APU . . . . . 33**

### **Chapter 3. Building an APU Print Definition for a Single Page Format . . . 35**

Example of a Single-Page Format Document . . . . . 35

    Example of the SCS File to be Formatted . . . . . 35

    Example of the Formatted File . . . . . 36

Setting up a Basic Print Definition . . . . . 36

    Identifying Resources . . . . . 36

    Working with a Print Definition . . . . . 37

Further Defining the Print Definition . . . . . 38

Working with Copies . . . . . 40

    Selecting a Sample Spooled File . . . . . 42

    Page Layout Options . . . . . 42

    Defining Page Segments . . . . . 43

    Defining Overlays . . . . . 44

Mapping Field Data . . . . . 45

    Mapping a Field as Text . . . . . 47

    Using the Repeat Function . . . . . 48

    Mapping a Field at Multiple Locations . . . . . 49

### **Chapter 4. Building an APU Print Definition for Multiple Page Formats . . . 51**

Example of a Multiple Page Format Document . . . . . 51

Overview of Defining a Multiple Page Format Document . . . . . 54

    Initial Copy for Page Format One . . . . . 55

    Continuation Page Format . . . . . 55

Working with a Print Definition . . . . . 55

    Identifying Resources . . . . . 55

    Starting to Work on a Print Definition . . . . . 55

    Developing Your Print Definition . . . . . 56

    Defining Selection Fields . . . . . 59

Working with Copies . . . . . 60

    Defining the Page Layout . . . . . 61

    Specifying the Back Overlay . . . . . 62

Mapping Fields . . . . . 63

    Mapping Bar Codes . . . . . 64

    Defining Constant Data . . . . . 66

    Selecting Fonts . . . . . 66

    Defining Overlays . . . . . 68

Replicating the Contents of Copies . . . . . 69

Continuation Page Copies . . . . . 71

---

## **Part 3. Printing With APU . . . . . 77**

### **Chapter 5. Manual and Command Line Printing with APU . . . . . 79**

Methods of Printing with APU . . . . . 79

Manually Associating a Print Definition with a

Spooled File . . . . . 79

    Panel 1: Apply Print Definition . . . . . 80

    Panel 2: Apply Print Definition . . . . . 81

    Panel 3: Apply Print Definition . . . . . 82

Using the Apply Print Definition Command . . . . . 82

<b>Chapter 6. Automatic Printing with APU Monitor</b>	<b>83</b>
Introduction to the APU Monitor	83
Understanding How the APU Monitor Works	83
An Example of APU Monitor Processing	84
A Customer Environment	84
Implementing the Customer Requirements on the APU Monitor	85
Condition of the Output Queue after Processing	86
Configuring APU Monitor	87
Specifying the Queues APU is to Monitor	88
Configuring APU Monitor Action	89
Starting APU Monitor	97
Stopping APU Monitor	98
<hr/>	
<b>Part 4. Appendixes.</b>	<b>99</b>
<b>Appendix A. APU Samples.</b>	<b>101</b>
<b>Appendix B. User Exits</b>	<b>103</b>
Processing Phases	103
User Exit Before	103
User Exit Middle	104
User Exit After	105
Sample User Exit Program	106
<b>Appendix C. APU Helpful Hints</b>	<b>111</b>
APYPRTDEF Command	111
APU Defaults	111
Maximum APU Values	111

Print Definition Creation	111
Mapping Data	112
Copies and Page Formats	112
Duplex	113
Creating Sample Spool Files	113
Creating Your Own Copy of INVSCS	113
Recreating INVPRE and INVSCS	113

<b>Appendix D. AFP Resource Commands</b>	<b>115</b>
Creating Font Resources	115
Creating Overlay Resources	116
Creating Page Segment Resources	117

<b>Appendix E. Rotation Hints</b>	<b>121</b>
Methods of Rotating Text Data	121
General Rules	121

<b>Appendix F. Font Samples</b>	<b>123</b>
Times New Roman Medium	123
Helvetica Roman Bold	124
Courier	125

<b>Glossary</b>	<b>127</b>
-----------------	------------

<b>Notices</b>	<b>133</b>
Trademarks	133

<b>Index</b>	<b>135</b>
--------------	------------

## Figures

1. Flow of Data Through APU and OS/400 . . . . .	5	56. Super Sun Seeds Invoice - Page 3 . . . . .	54
2. APU Data Structure . . . . .	6	57. APU Main Menu Panel . . . . .	56
3. APU Concepts . . . . .	7	58. Create a Print Definition Panel . . . . .	56
4. Steps to Creating a Document. . . . .	8	59. Work with Multiple Page Formats panel	57
5. APU main menu panel. . . . .	10	60. Further Define your Print Definition panel	57
6. Set APU Defaults panel . . . . .	14	61. Select a Sample Spooled File panel. . . . .	58
7. Set Print Definition Attributes panel . . . . .	15	62. Set Print Definition Attributes (Screen 1) panel	58
8. Set Print Definition Attributes panel (Continued) . . . . .	16	63. Set Print Definition Attributes (panel 2) panel	59
9. Super Sun Seeds Invoice . . . . .	17	64. Define Selection Fields panel. . . . .	59
10. Select Field for Mapping panel . . . . .	18	65. Define Selection Field panel . . . . .	60
11. Map Text panel . . . . .	19	66. Define Selection Fields panel. . . . .	60
12. Select a Font panel . . . . .	19	67. Work with Copies panel . . . . .	61
13. Map Text panel . . . . .	20	68. Define a Copy panel . . . . .	61
14. Work with Fonts panel. . . . .	21	69. Set Page Layout Options panel . . . . .	62
15. Work with Fonts panel. . . . .	22	70. Back Overlay (Terms and Conditions) - INVBAC . . . . .	63
16. Display Font Details on Work with Fonts panel	22	71. Define Field Mapping panel . . . . .	64
17. Request Addition of the Special Font . . . . .	23	72. Map Bar Code panel . . . . .	65
18. Add the Special Font to APU . . . . .	23	73. Define Constants panel. . . . .	66
19. Super Sun Seeds Logo . . . . .	24	74. Create Constant Text panel . . . . .	66
20. Select a Page Segment panel . . . . .	25	75. Select a Font panel . . . . .	67
21. Define Page Segments panel . . . . .	25	76. Define Constants panel. . . . .	67
22. Super Sun Seeds Invoice . . . . .	27	77. Define Overlays panel . . . . .	68
23. Select an Overlay panel . . . . .	28	78. Sample INVALL Overlay . . . . .	68
24. Define Overlay Positionings panel . . . . .	28	79. Work with Copies panel . . . . .	69
25. Page Layout Options - Copy Level. . . . .	29	80. Suppression panel . . . . .	70
26. Code 3 of 9 Bar Code Example . . . . .	30	81. Repeating a Suppression panel . . . . .	70
27. POSTNET Bar Code Example . . . . .	30	82. Sample Packing List Showing Suppression	71
28. Map Bar Code panel . . . . .	31	83. Work with Page Formats panel . . . . .	72
29. Select a Bar Code Type panel . . . . .	31	84. Work with Page Formats panel . . . . .	72
30. Additional Bar Code Attributes . . . . .	32	85. Create with Copies panel . . . . .	73
31. Super Sun Seeds Invoice . . . . .	36	86. Define Selection Rules panel . . . . .	73
32. APU Main Menu panel . . . . .	37	87. Define a Rule panel. . . . .	74
33. Work with Print Definitions panel . . . . .	37	88. Define a Rule panel. . . . .	74
34. Create a Print Definition panel . . . . .	38	89. Define Selection Rules panel . . . . .	75
35. Define a Print Definition panel . . . . .	39	90. Select Spooled File . . . . .	79
36. Select a Sample Spooled File panel. . . . .	39	91. Apply Print Definition panel. . . . .	80
37. Set Print Definition Attributes panel 1. . . . .	40	92. Apply Print Definition panel. . . . .	81
38. Set Print Definition Attributes panel 2. . . . .	40	93. Apply Print Definition panel. . . . .	82
39. Work with Copies panel . . . . .	41	94. APU Monitor Processing Sequence. . . . .	84
40. Define a Copy panel . . . . .	41	95. APU Monitor before Processing. . . . .	85
41. Set Page Layout Options panel . . . . .	42	96. APU Monitor - Action Example. . . . .	86
42. Define Page Segment panel . . . . .	43	97. APU Monitor Example After Processing	86
43. Create Page Segment Positioning panel	44	98. APU Main Menu. . . . .	87
44. Define Overlay Positioning panel . . . . .	44	99. Work with APU Monitor . . . . .	88
45. Create an Overlay Positioning panel . . . . .	45	100. Add a New Output Queue . . . . .	88
46. Define Field Mapping panel . . . . .	45	101. Configure APU Monitor Action panel. . . . .	89
47. Select Function display. . . . .	46	102. Configure APU Monitor Action panel. . . . .	90
48. Map Text panel . . . . .	47	103. Define Selection for Input Spooled File panel	91
49. Define Field Mapping Completed panel	47	104. Define Action for Input Spooled File panel	92
50. Edit Text Mapping panel . . . . .	48	105. Action Example for Two Locations. . . . .	93
51. Repeat Function of Text Mapping panel	49	106. Spooled File Location after Processing . . . . .	94
52. Repeat Function of Text Mapping panel	50	107. Define Action for Output Spooled File panel	95
53. Mapping a Second Position panel . . . . .	50	108. Define Action for Output Spooled File panel	96
54. Super Sun Seeds Invoice - Page 1 . . . . .	52	109. APU Main Menu panel . . . . .	97
55. Super Sun Seeds Invoice - Page 2 . . . . .	53	110. Start APU Monitor panel . . . . .	97

111. Stop APU Monitor panel . . . . .	98	118. Create Temporary Resource File . . . . .	118
112. Create Temporary Resource File . . . . .	115	119. Copy Page Segment to Temporary File	118
113. Copy From PC Document (CPYFRMPCD) panel . . . . .	115	120. Create Page Segment (CRTPAGSEG) panel	118
114. Create Font Resource (CRTFNTRSC) panel	116	121. Rotation Hints . . . . .	121
115. Create Temporary Resource File panel	116	122. Times New Roman Medium . . . . .	123
116. Copying Overlay File from Folder . . . . .	117	123. Helvetica Roman Bold . . . . .	124
117. Create Overlay (CRTOVL) panel . . . . .	117	124. Courier Font Samples . . . . .	125



---

## Tables

1.	Field Mapping Values . . . . .	48	5.	Parameters Passed to the Middle User Exit	104
2.	Samples in the QAPU Library . . . . .	101	6.	Parameters Passed to the User Exit After the	
3.	APU Print Engine Processing Phases	103		AFPDS Spooled File has been Created . . .	105
4.	Parameters Passed to the Before Initialization				
	User Exit . . . . .	103			



---

## Purpose of this Publication

This publication helps you to use the IBM PrintSuite for iSeries Advanced Print Utility (APU). It focuses on the concepts of APU, using a series of application examples to demonstrate how APU works.

APU has extensive on-line help; we do not duplicate that information here. For details on the concepts of Advanced Function Presentation (AFP), refer to *iSeries Guide to AFP and PSF*, S544-5319.

---

## APU Enhancements

The following features have been made available by the current modification level of APU:

1. **Duplex Printing** is now available. Refer to “Page Layout Options” on page 42 for a description of how the capability is used, including restrictions on its use.
2. Fields in the SNA Character String (SCS) file can now be mapped to **multiple locations**. Refer to “Mapping a Field at Multiple Locations” on page 49.
3. **Outline fonts** are now included in the font set. Refer to “Outline Fonts” on page 20.
4. The APU Monitor has been enhanced to include **conditional processing** capabilities. Refer to Chapter 6, “Automatic Printing with APU Monitor” on page 83.

---

## Organization of the Manual

This manual is organized into three parts, as follows:

- **Part 1 - Understanding and Preparing to use APU**

The two chapters in this part introduce new APU users to the capabilities and features of APU:

1. **Introducing Advanced Print Utility** describes what you can do with APU.
2. **Preparing to use the Advanced Print Utility** describes tasks you need to perform before using APU. You are also given an orientation to using the APU panels.

- **Part 2 - Creating Print Definitions with APU**

Each of the two chapters in this part provides you with a procedure for creating a print definition. One chapter provides the procedure for creating a print definition for a single-page document; the other for a multiple page document. New APU users will find it useful to create a sample print definition using one of these procedures before creating a production-level print definition.

- **Part 3 - Printing with APU**

The material in this part describes the concepts and procedures for printing your documents once you have created a print definition.



---

## Part 1. Understanding and Preparing to Use APU

<b>Chapter 1. Introducing Advanced Print Utility</b>	3
What is APU?	3
What You Can Do with APU	3
Why Use APU?	4
Printing with and without APU	4
Printing without APU	4
Printing with APU	5
The Design Phase	5
The Production Phase	6
APU formatting instructions	6
Steps in Creating an APU Document	7
Step 1: Analyzing the Existing Application	8
Questions you need to Ask	8
Example of Sample Spooled File (Source Input Data)	8
Step 2: Locating Required AFP Resources	9
Step 3: Using APU to Create a Print Definition	9
Defining Page Formats	10
Defining Copies	10
Step 4: Printing with the Print Definition	10

<b>Chapter 2. Preparing to Use the Advanced Print Utility</b>	13
APU Prerequisites and Options	13
Required	13
Recommended	13
Optional	13
Initial APU Setup	14
Font Installation Considerations	16
Review Document Resource Requirements	16
Using Fonts with APU	18
Outline Fonts	20
Custom Fonts	21
Image Resources	24
How APU Works with Image Resources	24
Building Image Resources	26
Overlay Resources	26
How APU Works with Overlays	27
Building Overlay Resources	29
Bar Code Resources	29
Code 3 of 9 Bar Code Example	30
POSTNET (Postal Bar Code) Bar Code Example	30
How APU Works with Bar Codes	30



---

## Chapter 1. Introducing Advanced Print Utility

Use this chapter to gain an understanding of what the IBM PrintSuite for iSeries Advanced Print Utility (APU) can do for you, including:

- “What is APU?”
- “What You Can Do with APU”
- “Why Use APU?” on page 4
- “Printing with and without APU” on page 4
- “APU formatting instructions” on page 6
- “Steps in Creating an APU Document” on page 7

---

### What is APU?

Advanced Print Utility (APU) is part of the Advanced Function Presentation (AFP) PrintSuite family of document-creation systems that enables you to use SCS files as input to APU and then to transform that input to “full-page” electronic output, with pages that include electronic forms, image, bar codes, lines, boxes, and text in a variety of fonts.

APU provides an interactive design approach that is independent of the application program.

- The **input** to APU is the line-mode (SCS) output file that the line-of-business application creates.
- The **output** of APU is an AFP spooled file.

---

### What You Can Do with APU

Output specifications for iSeries application programs generate either SNA Character Stream (SCS) or AFP spooled files. APU works on SCS spooled files. SCS is a line-oriented datastream that for the most part uses preprinted forms to create the final document. With APU, you can eliminate the need for preprinted forms. Instead, you create a completely electronic document. With APU, you can:

- Create multi-copy documents, with each page customized
- Use data that is contained within a page to determine which of multiple output formats to use
- Remap any field that the input SCS pages contain (change position, font, orientation, color, and so on)
- Print application data in any of the standard bar code symbologies
- Add document elements such as electronic forms (overlays), images, lines, boxes, and constant text
- Place a new application into production for automatic processing
- Manage the production of input and output files, including the routing of different output files to different queues, printers, and output bins
- Implement user-defined programs that can address unique document or document distribution requirements

APU provides an interactive interface for defining new output applications. For simpler applications, APU provides a “fast path”. You use the current spooled file (SCS) interactively to redefine the formatting of application data.

---

## Why Use APU?

APU assists you in building AFP-compatible electronic output. Effective electronic output can provide significant benefits to an organization, particularly in the areas of information systems costs, process reengineering, and better communications, for example:

- Replacing preprinted multipart forms with electronic forms supplies significant cost savings.
  - You can print a variety of different forms one after the other without switching forms at the printer.
  - You can eliminate carbon forms by printing multiple copies of the same page, that includes the capability of varying the output on each copy.
  - You can eliminate storage space for preprinted forms because the forms are stored electronically rather than physically occupying office space.
  - You can change the form outside of the application program, and you do not need to scrap or reorder preprinted forms.
- Documents, whether printed, stored, or viewed, are critical to the workflow in any organization. The capabilities of electronic documents provide a wealth of opportunities to reengineer organizational processes. In fact, in many industries, document reengineering such as bar coding is a “must.” Coding an electronic document with bar code, optical character recognition (OCR), magnetic ink character recognition (MICR), and images enables you to easily integrate the document into the workflow.
- Electronic documents are more effective documents. Document elements, such as images, text, and overlays, allow you to compose a document that does a better job of communicating or marketing. Electronic flexibility, the ability to change a document dynamically down to the individual transaction level, provides a wide variety of application possibilities. Electronic documents project the image of a strong, professional organization.

For more information about the benefits of AFP, refer to *iSeries Guide to AFP and PSF*.

---

## Printing with and without APU

This section describes the situation in environments that do and do not use APU.

### Printing without APU

APU provides an application-independent, end-user approach to page and document formatting. Without APU, the application programmer can format pages using either specifications within the application program or DDS (Data Description Specifications), which is external to the application program. Formatting within the program (also called internally or program-described) only provides for line-oriented pages of output. Formatting with DDS (actually a part of the printer file) actually provides for comprehensive AFP pages and documents. There are DDS keywords not only for field positioning but also for every document element (overlay, image, font, bar code, and so on) found in complex application output.

Both these methods of formatting pages, however, are integrated with the application program. This is an advantage when you want to precisely customize each page based on logic or data within the program. This is a disadvantage when you would like to separate the processing of the application program from the complex formatting of each page. This is even a bigger disadvantage if there is no



access to the application program source code or no programming skills exist in-house to implement changes to output pages or documents.

## Printing with APU

Using APU requires no programming skills, enabling individuals with graphics and layout ability to design the appearance of the printed page and to easily make changes to printout appearance.

**Note:** Exact print results depend on the type of printer you have. Refer to *IBM Printing Systems: Printer Information, S544-5750*, for the specific capabilities of your printer.

Without AFP and APU, the application programmer codes all of the formatting information in the application program or printer file and runs the program to generate an output file. The output file is placed on a system spool and directed to a printer.

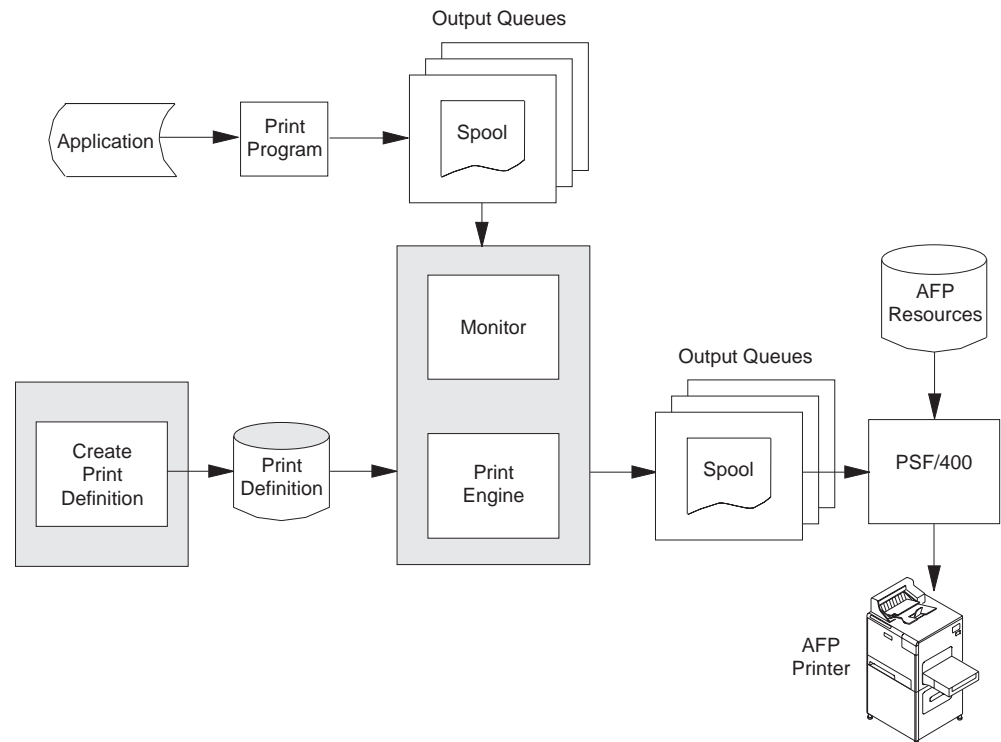

Figure 1. Flow of Data Through APU and OS/400

Figure 1 illustrates the processing flow of APU. There is a design phase and a production phase.

### The Design Phase

The new output application is defined in the design phase, which is done once (or when changes are required). You do this interactively. The spooled output file from the existing application is retrieved and used in the design process. The output of this design phase is a set of formatting rules that are stored in an APU print definition.

## The Production Phase

With the new print application designed, it is ready to be placed into production. You define the desired production characteristics to APU. These characteristics include how to identify the target spooled file, which print definition to use, what user-specific programs should be called during processing, and the disposition of both the input and output spooled files. With this information in place, you start the APU Monitor.

The APU Monitor automatically monitors iSeries output queues, looking for the specified spooled file. When that target file is identified, it is retrieved and passed to the APU print engine. The APU print engine uses the formatting instructions contained in the APU print definition to create a new AFP output file and place it in an output queue.

At this point, standard iSeries print management takes over. When the new file is to be printed, PSF/400 manages the printing process (including the retrieval and management document resources such as overlays, images, and fonts) to an IPDS printer. Alternatively, the new print file can be routed through Host Print Transform to an HP-PCL printer.

---

## APU formatting instructions

APU enables you to build a *print definition*, which is a set of instructions for formatting the data that is contained in a spooled print file. A print definition can contain one or more *page formats*, enabling you to change formatting instructions for different pages in the spooled file. Within the page format, you can define one or more *copies* of each input page. Figure 2 shows the relationship among these APU concepts.

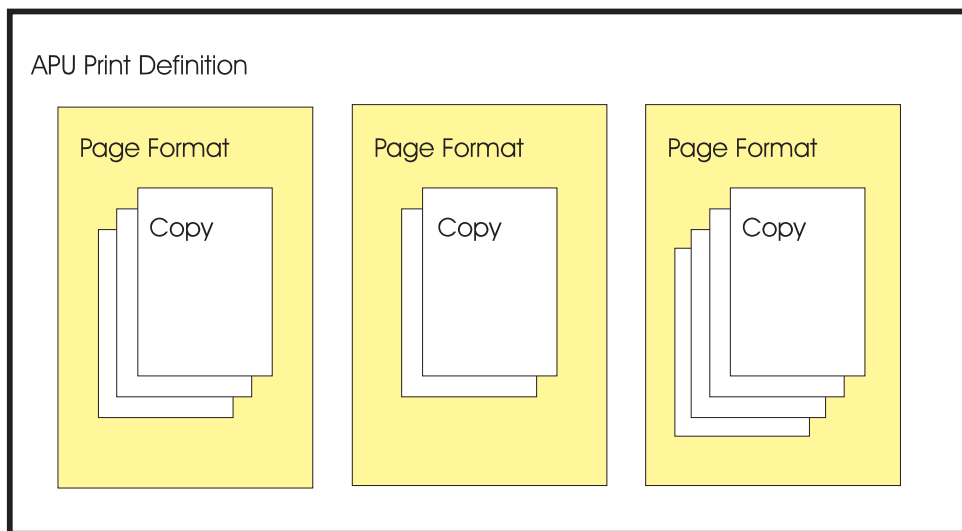

Figure 2. APU Data Structure

You can specify a single page format in a print definition, if all of the pages in your spooled file are formatted in the same way. An application that might require only one page format is a one-page form such as an invoice, where all of the fields on the form are predefined, and a second page is never required.

Even though you define only one page format in the print definition, you can still use the APU multiple copy function to produce different copies of the same page,

as would be done with hard copy multipart forms. You can, for example, suppress the price on the packing slip and print some inventory control information on the packing slip as a bar code.

When you use APU, each copy can be different. The same data can be printed at a different position, and different attributes can be used with each copy. For example, the customer address from an invoice can be placed on the right side of the first (“original”) copy and on the left side and in a different font on the second copy.

Applications requiring multiple page formats in the print definition might be

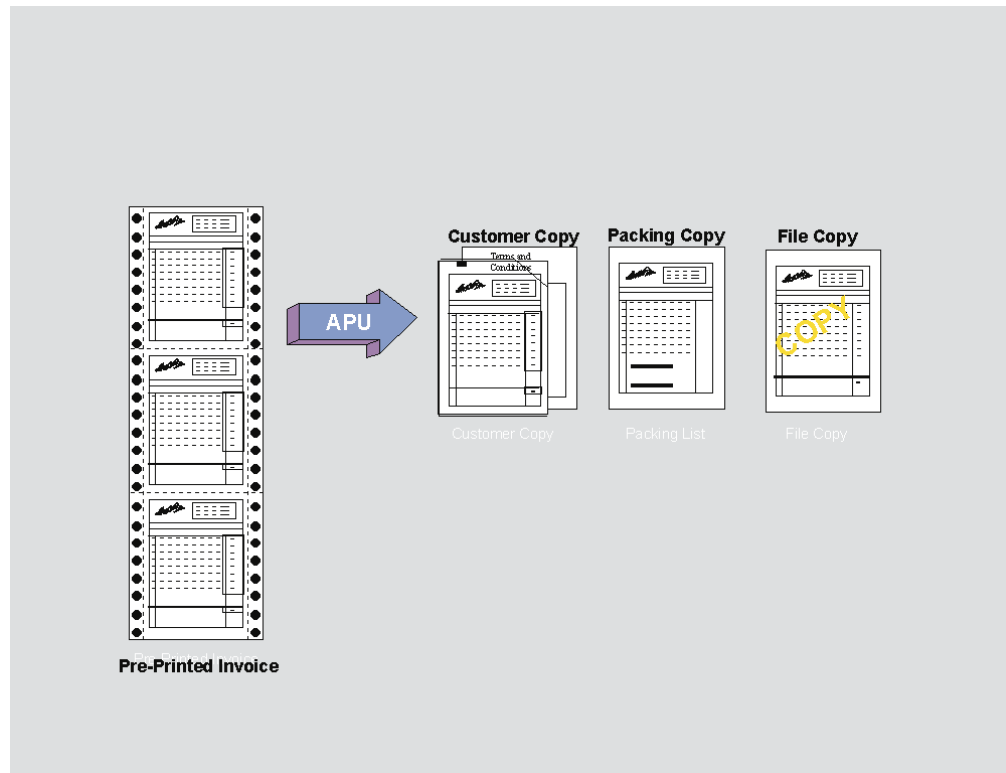

Figure 3. APU Concepts

billing statements that could have so many line items that two pages instead of one are required to list all of the items ordered. In this case, you would want to define one page format to be used for the first page of each customer bill and another page format to be used for those customers requiring a second page.

To determine what page format is used for each input data page, you define fields in the data that can be evaluated by APU. For example, if the input data contains a field with “PAGE *n* OF *m*” in it, you can specify that field to APU and have the contents of the *n* and *m* fields evaluated to determine if a second page format should be used.

---

## Steps in Creating an APU Document

To create a document that takes advantage of the functions that are provided by AFP and APU, you need to perform the tasks shown in Figure 4 on page 8.

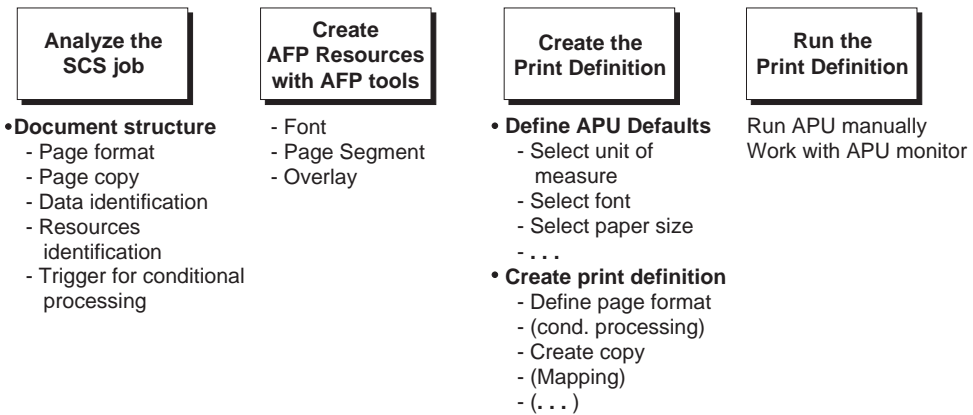

Figure 4. Steps to Creating a Document

## Step 1: Analyzing the Existing Application

### Questions you need to Ask

The first step in creating a document is to examine the contents of the current application program that is output by asking these questions:

- Is the application currently being printed on preprinted forms? If so, how complicated is the information on the preprinted forms? If the preprinted form contains only a few boxes and text strings, you might consider using the APU functions to include those items in the APU print definition. If the form is complex, you should probably use another program, such as the Overlay Utility in the Advanced Function Printing Utilities for iSeries program product, to create an electronic overlay. For more information, see Chapter 2, “Preparing to Use the Advanced Print Utility” on page 13.
- Is the application currently being printed on multipart forms? If so, do the forms all contain the same information, or is some of the data suppressed on some copies?
- Is the same page format used for all pages in the file? Could you improve the appearance of the output by using a different format for pages of different types, such as a different layout for the first output page than for subsequent continuation pages?
- If you want to use more than one page format in the AFP output, examine the contents of a spooled file that is produced by the application. What information is contained in the print data that APU can use to determine which page format is to be used for each type of output page?
- What fonts will you need to produce effective output?
- Would you like to add any image data to the output?
- Would you like to add any bar code data to the output?
- What type of AFP printer will you use to print the job? Some AFP printers do not support all of the AFP data stream objects, such as bar codes. Refer to *IBM Printing Systems: Printer Information, S544-5750*, for details about printer capabilities.

### Example of Sample Spooled File (Source Input Data)

An example of the sample spooled file (source input data) that you would use to build a print definition is given below:

LOS ARBOLES DEL MUNDO			SAME	
32483 ARBOL LANE				
MESA VERDE				
IL 54078-9390				
	141	31341	1/26/98	2/26/98
		1/26/98	N10	MICHELE GOODACRE
900 EA	00001200	ARBOLES DEL SUR	45.00	40,500.00
951 CT	11005011	LASSO RED SEEDS	892.23	48,510.73
46 DZ	11005014	SCARLET NANTES SEEDS	5.90	271.40
45 BZ	11005015	CHANTENAY SEEDS	2.19	98.55
951 PK	11005018	EARLY BANTAM SEEDS	.38	361.38
4 BX	11057893	AFRICAN DAISY, SEEDS	2.35	9.40
100 EA	31321655	SEMILLAS DEL SUS SOMBEROS	24.95	2,495.00
1000 BX	56413213	POT POT	7.65	7,650.00
98 PK	84512023	OREGON SPRING TOMATO SEED	.97	95.06

Thank You .....

Because you have ordered over \$500 of trees this year, on your next tree order you will receive a 10% discount.

\$99,991.52

2/26/98  
LOS ARBOLES DEL MUNDO  
32483 ARBOL LANE  
MESA VERDE  
IL 540789390

\$99,991.52

Page 1

**Note:** There are some restrictions on the spooled file to be copied. Refer to the help text for the copy spool file (CPYSPLF) command for details of these restrictions.

## Step 2: Locating Required AFP Resources

If your application analysis in Step 1 identified required overlays, images, or fonts, those print resources need to be available before you can proceed with the APU design function. APU does not create these print resources, but other IBM and vendor programs as available that do. Refer to Chapter 2, "Preparing to Use the Advanced Print Utility" on page 13.

## Step 3: Using APU to Create a Print Definition

After APU is installed, enter "GO QAPU/APU" on a command line to display the APU main menu, as shown in Figure 5 on page 10.

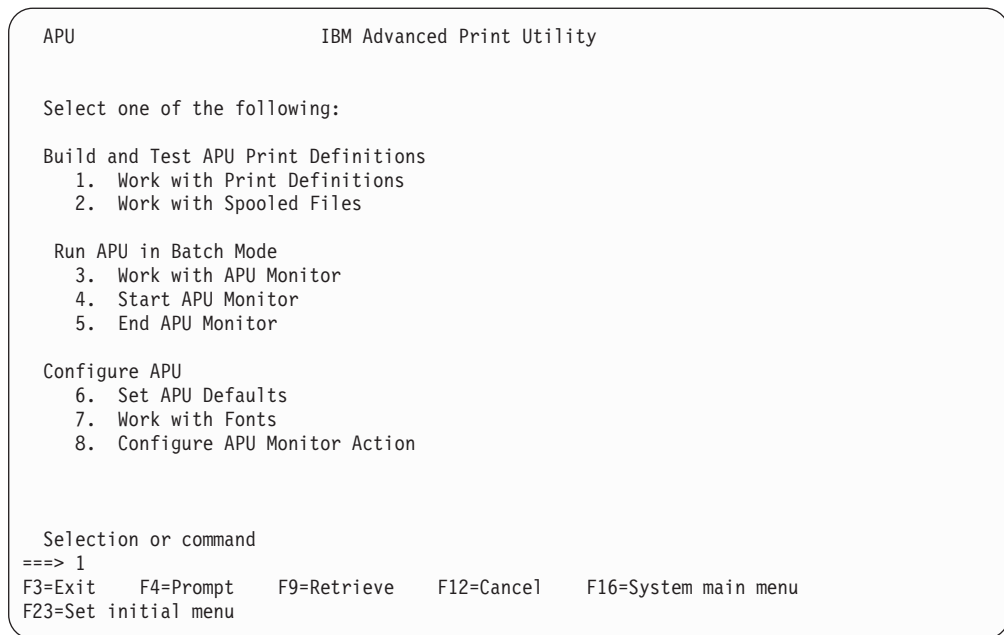

Figure 5. APU main menu panel

Initially, you may need to set the APU defaults if they were not previously set. For more information, see “Initial APU Setup” on page 14.

Creating a print definition includes defining page formats and defining copies. We describe these tasks in the sections that follow.

### Defining Page Formats

When you create a print definition, you must specify whether the print definition will contain one or more page formats. If your print definition will contain only one page format, APU uses a fast path to map the spooled file data and define other document resources such as overlays and images.

However, if your print definition will contain multiple page formats, you must define the fields in the spooled file that APU can use to determine which page format to use for each page of input data. See “Example of a Multiple Page Format Document” on page 51 for a detailed description of the panels in APU that you use for a print definition with multiple page formats.

After you have set up the conditions you want APU to use to select a page format, you can then specify the formatting instructions for each output copy.

### Defining Copies

A page format needs a minimum of one copy. APU provides the first \*ORIGINAL copy with all related default values. Before you create additional copies, you need to define or modify all elements common to all copies. All work that is done on the first copy can be reused by any additional copies.

## Step 4: Printing with the Print Definition

To test how your application output will appear with the new print definition applied, select **Work with Spooled Files** from the APU Main Menu. On that panel you can select an existing spooled file to which you can apply your print definition.

After you specify which print definition to apply, APU creates another spooled file and sends it to the output queue that you select. You will probably need to experiment some to get the data lined up with the electronic form or to refine the conditional tests that APU performs to select page formats.

When you have completed testing of the print definition, you are ready to put the application into production. This involves defining how the production process is to work, then starting the APU Monitor.

Use the **Work with APU Monitor** option on the APU Main Menu to define how the target spooled file is identified, which print definition(s) will be applied, any special user-specific processing that should be done, and the disposition of the input and output files when production processing completes.

Once these options are defined, the APU Monitor can be started. Use the **Start the APU Monitor** option on the APU Main Menu. At this point, the production process is automatic. When the target spooled file is identified, it is automatically selected and processed based on your definition. Refer to Chapter 6, “Automatic Printing with APU Monitor” on page 83 for detailed information.





---

## Chapter 2. Preparing to Use the Advanced Print Utility

Before building your first APU print definition, review the following installation and planning considerations:

- “APU Prerequisites and Options”
- “Initial APU Setup” on page 14
- “Font Installation Considerations” on page 16
- “Review Document Resource Requirements” on page 16
- “Using Fonts with APU” on page 18
- “Image Resources” on page 24
- “Overlay Resources” on page 26
- “Bar Code Resources” on page 29

---

### APU Prerequisites and Options

#### Required

Print Services Facility for iSeries (PSF for iSeries) is the AFP printing subsystem on OS/400. PSF for iSeries is used when AFP print files are to be printed on Intelligent Printer Data Stream (IPDS) printers. Since APU creates AFP output, PSF for iSeries is required to print APU applications to IPDS printers. AFP output files can also be printed on HP-PCL printers by using Host Print Transform (a component of OS/400) services. There are performance differences and print management differences between IPDS and PCL printing.

#### Recommended

AFP Font Collection provides comprehensive libraries of AFP fonts for use in APU applications. Standard document typefaces, such as Helvetica, Times New Roman, and Courier, are included in over 48 languages. The font libraries are provided in 240 dpi (dots per inch), 300 dpi, and outline formats, corresponding to different printer resolutions.

#### A note on Examples

The examples in this publication assume that you have read and write access to the QAPU library and to the resources it contains. You may need to contact your system administrator to get this authorization. If the QAPU resources have been moved, you may also need to obtain the name of the locally defined library name where these resources are stored.

#### Optional

**AFP Utilities for iSeries** consists of three utilities that complement APU applications:

- **Overlay Utility** provides the capability to create electronic forms.
- **Print Format Utility** enables you to create quick, specialized applications, such as bar coded labels.
- **Resource Management Utility** assists in managing overlay and image resources.

**Client Access for iSeries**, in addition to client/server support, integrates the AFP Workbench into the Windows or OS/2 client. This provides full graphical viewing

of AFP documents, as well as the ability to search, print, and fax what is viewed. In addition, the full AFP Workbench includes the **IBM AFP Printer Driver for Windows**. Use this standard Windows driver to create overlays and page segments from any Windows application.

**Non-IBM document product tools**, of which many exist, assist you in creating fonts, images, and overlays.

## Initial APU Setup

APU provides for several levels of default print settings:

- At the APU level
- At the print definition level
- At the copy level

At these levels, you can set print attributes and environment attributes, such as unit of measure, resource libraries, and default font family.

**Note:** You cannot set all attributes at all levels.

Use option **6** (Set APU Defaults) on the APU main menu to display the **Set APU Defaults** panel, which is shown in Figure 6.

**Note:** Refer to “APU Defaults” on page 111 for some helpful hints on setting APU defaults.

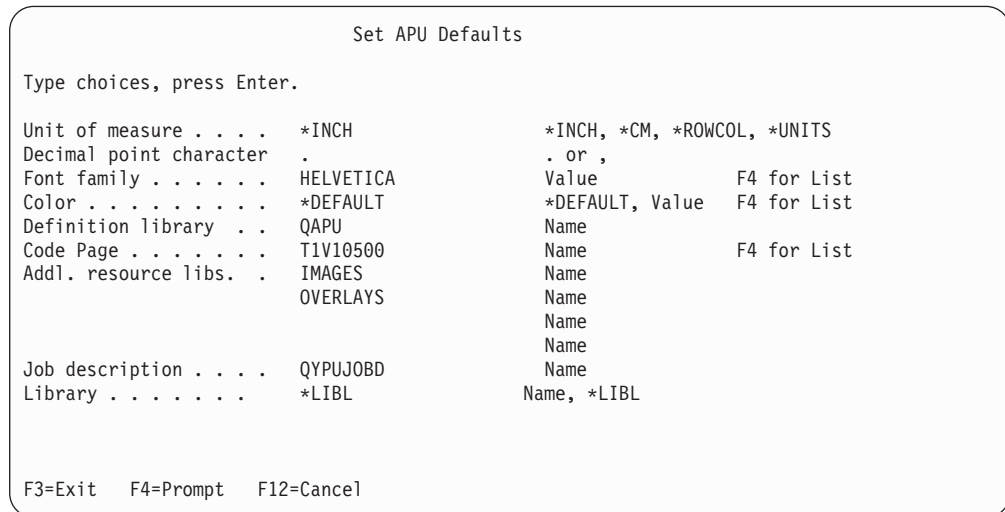

Figure 6. Set APU Defaults panel

The values that are shown above are the values APU will use unless they are superseded at print definition level or copy level print definition or copy level. The defaults selected in the example above are:

- Inches for unit of measure
- Helvetica for font family
- APUDATA as the library to store APU print definitions
- T1V10500 as the default code page (this is an international code page)

- For the Job description, we recommend that you use QYPUJOB in the QAPU library.

Two additional resource libraries, IMAGES and OVERLAYS, were also selected as defaults because APU looks in these libraries for document resources, such as page segments and overlays.

You can specify defaults when you first begin an APU print definition. This display is shown in Figure 7.

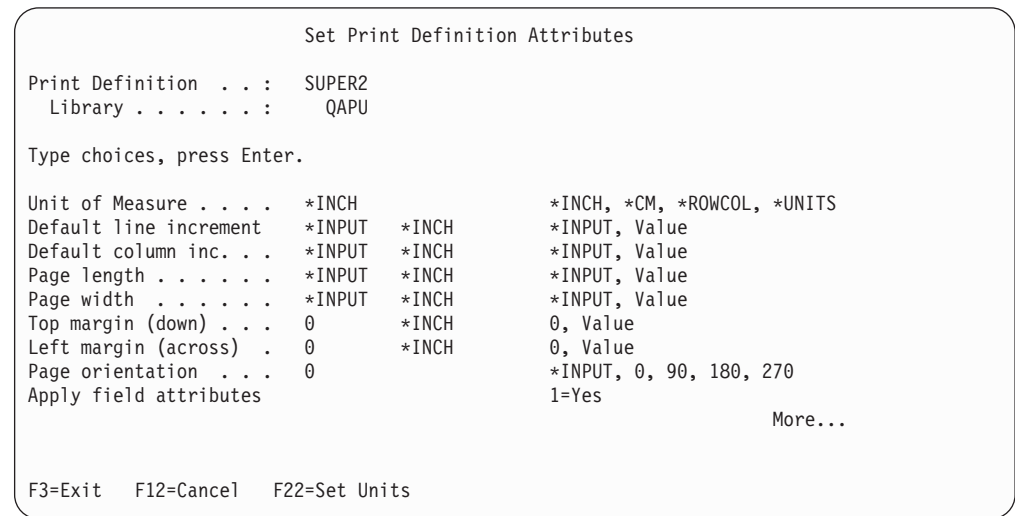

Figure 7. Set Print Definition Attributes panel

**Note:** When you specify \*INPUT for the **Page orientation** field, APU always attempts to create the output in Portrait mode by default. APU attempts to perform text rotation according to the values specified for the **Page length** and **Page width** fields.

The print definition defaults add page layout attributes such as page size, line and column increments, and margins.

The continuation of the panel is shown in Figure 8 on page 16:

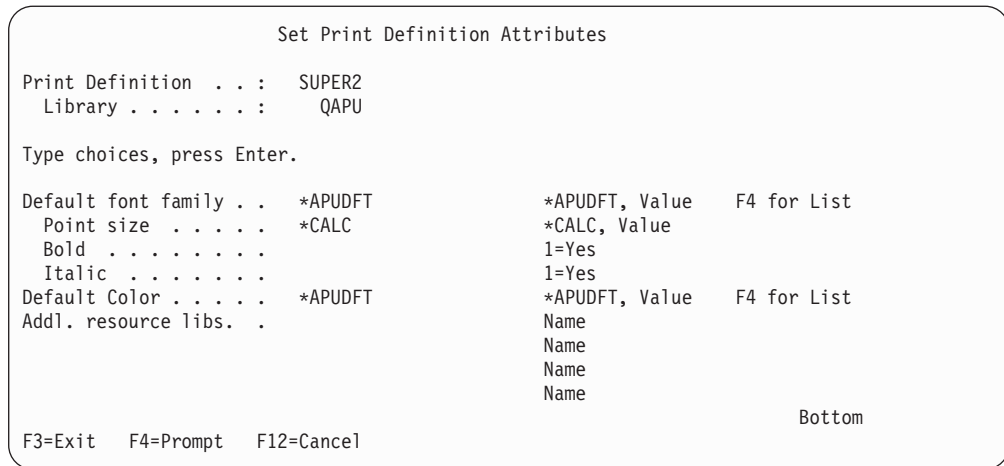

Figure 8. Set Print Definition Attributes panel (Continued)

When you define a copy, you can specify print attributes at this level as well. You can override print attributes or default to the attributes specified at the print definition or APU level.

## Font Installation Considerations

APU installation loads the APU software on to the iSeries and creates the QAPU library. During the installation process, APU builds the font database. APU provides a standard interface to the fonts on the system and must synchronize its database with the actual fonts that are resident on the system.

If you are adding AFP fonts to your system while you are installing APU, you should load the fonts prior to installing APU. If you add font libraries after installing APU, you will need to synchronize the font database again. To do this, issue the following command to run the synchronization program:

```
call qapu/qypusync
```

After APU is installed, you can access the APU Main Menu by entering **GO QAPU/APU**.

## Review Document Resource Requirements

APU creates complex electronic documents, combining many elements into each completed page. The building blocks of these electronic pages are electronic overlays, fonts, bar codes, and images (that are called page segments in AFP). The example below, output from an invoicing application for the Super Sun Seeds Company, illustrates those elements:

400 CPU Parkway Vegetation, NJ 55090		 <b>Super Sun Seeds</b> A Growth Company		Office: 555-499-2367 Fax: 555-415-9794	
LOS ARBOLES DEL MUNDO 32483 ARBOL LANE MESA VERDE IL 65478-9390		SAME		-- Sold To --                      -- Ship To --	
Customer Number:	141	Invoice Number:	31341	Invoice Date:	7/28/95
				Payment Date:	8/28/95
Ship Via:		Ship Date: 7/28/95		Terms: N10    Salesman: MICHELE GOODACRE	
Qty	UOM	Item #	Item Description	Price	Extension
1000	BX	56413213	POT POT	7.65	7,650.00
45	BZ	11005015	CHANTENAY SEEDS	2.19	98.55
900	EA	00001200	ARBOLES DEL SUR	45.00	40,500.00
98	PK	84512023	OREGON SPRING TOMATO SEED	.97	95.06
4	BX	11057893	AFRICAN DAISY, SEEDS	2.35	9.40
951	CT	11005011	LASSO RED SEEDS	892.23	48,510.73
46	DZ	11005014	SCARLET NANTES SEEDS	5.90	271.40
100	EA	31321655	SEMILLAS DEL SUS SOMBEROS	24.95	2,495.00
<i>Thank You . . . . .          Because almost half of          your order was Lasso Red          Seeds, you will receive          a 10% discount on your          next order.</i>					
Total Due					\$99,630.14
<i>Return this tear-off strip with your payment.</i> Payment is due by: 8/28/95			<i>Make Checks Payable to:</i> Amount Due is:		<b>Super Sun Seeds</b> \$99,630.14
LOS ARBOLES DEL MUNDO 32483 ARBOL LANE MESA VERDE IL 65478-9390					

Figure 9. Super Sun Seeds Invoice

You will note the many characteristics that make this invoice an effective document:

- Static sections of the page built into an overlay
- Company logo and accent image
- Use of a variety of fonts
- Use of bar coding — POSTNET for the zip code

The following sections use the Super Sun Seeds example to provide a close look at the key resources that comprise APU electronic documents: how they are used on the iSeries, how they are created, and how APU works with them.

## Using Fonts with APU

The examples in the remainder of this manual use the fonts in the AFP Font Collection. You should verify that you have these fonts available before going on. Your results may differ depending on the fonts defined on your system.

APU provides an interface that makes selecting fonts simple. During installation, APU determines which fonts (character sets) are on your system and loads them into this interface. APU distinguishes between IBM-supplied fonts and your own custom fonts.

Most common fonts are selected by font family, typeface (normal, bold, italic, and combinations), and point size. This is how APU selects fonts for your document. You can select fonts for constant text or for text from the application. The example below shows how to map application data to a new font.

To follow the examples provided in the remaining sections of this chapter, you will need a print definition and a sample spooled file.

- Refer to “Setting up a Basic Print Definition” on page 36 for instructions on how to create a print definition you will call MYPRTDEF.
- Refer to “Further Defining the Print Definition” on page 38 for instructions on how to select a sample spooled file called INVPRE.

Select option **12** (Work with...).

Select option **10** (Define) on the **Work with Copies** panel and then select **Define field mapping** on the **Define a Copy** panel to have the **Define Field Mapping** panel appear.

From the **Define Field Mapping** panel, use F14 to mark the beginning of the “Improved Printing Corp.” field and F15 to mark the end of the field. Once you have taken these two steps, the **Select Function** panel appears.

```
Define Field Mapping
Spooled file . . . . . : INVPRE           Page/Line . . . . . : 1/1
Control . . . . .      :                  Columns . . . . .   : 1 - 78
*...+...1...+...2...+...3...+...4...+...5...+...6...+...7...+...
: .....                               :
:                                     : Select Function :
:                                     :               :
: From Row / Column : 12 / 12 :
: Length . . . . . : 22 :
:                                     :
: Type option, press Enter. :
: 1=Select :
:                                     :
: Opt Function :
: 1 Map as Text :
: Map as Bar Code :
: Suppress :
:                                     :
F3=Exit          F11=Hide mapping      F12=Cancel
F15=End field    F16=Delete range
Mark end of field, press F15 or press F :.....
```

Figure 10. Select Field for Mapping panel

Select **Map as Text** to change the font that is used for the name. The **Map Text** panel appears.

```

Define Field Mapping
Spooled file . . . . . : INVPRE          Page/Line . . . . . : 1/1
:-----:-----:
:                               Map Text                               :
: Type choices, press Enter.                                         :
: From Row / Column : 12 / 12                                         :
: Mapping . . . . . : 1 / 1                                           :
: Length . . . . . : 22                                             :
: Position across . . 1.1      *INCH      Value                       :
: Position down . . . 2        *INCH      Value                       :
: Font family . . . . *PRTDEF      *PRTDEF, Value F4 for list :
:   Point size . . . .          *CALC, Value                       :
:   Bold . . . . .          1=Yes                                     :
:   Italic . . . . .        1=Yes                                     :
: Rotation . . . . . *DEFAULT      *DEFAULT, 0, 90, 180, 270 :
: Color . . . . . *PRTDEF      *PRTDEF, Value F4 for list :
:                               More... :
:-----:-----:
F4=Prompt          F12=Cancel
                  F22=Set Units

```

Figure 11. Map Text panel

Position the cursor on the **Font family** field, press F4 to have the font database displayed, then select the font you want.

```

Define Field Mapping
S :-----:-----:
C :                               Select a Font                               :
: :                               :                                     :
: : Font family . . . . . HELVETICA      Name, Generic*, *ALL :
: : Point size . . . . . *ALL           Value, *ALL           :
: : Bold . . . . .                   1=Yes, 0=No           :
: : Italic . . . . .                   1=Yes, 0=No           :
: :                               :                                     :
: : Type Options, press Enter.         :                                     :
: : 1=Select 5=Details                 :                                     :
: :                               :                                     :
: : Opt Font family      Size Style    :                                     :
: :                               :                                     :
: :   HELVETICA          11 Bold       :                                     :
: :   HELVETICA          11 Bold-Italic :                                     :
: :   HELVETICA          12 Normal     :                                     :
: :   HELVETICA          12 Italic     :                                     :
: :   1 HELVETICA        12 Bold       :                                     :
: :   HELVETICA          12 Bold-Italic :                                     :
: :                               :                                     :
: :                               More... :                                     :
: : F5=Refresh F12=Cancel              :                                     :
: :                               :                                     :
: :-----:-----:

```

Figure 12. Select a Font panel

Select Helvetica Bold in 12-point, and press Enter. The **Map Text** panel appears again.

```

Define Field Mapping
Spooled file . . . . . : INVPRE          Page/Line . . . . . : 1/1
:-----:-----:
:                               Map Text                               :
: Type choices, press Enter.                                         :
: From Row / Column : 12 / 12                                         :
: Mapping . . . . . : 1 / 1                                           :
: Length . . . . . : 22                                             :
: Position across . . 1.1      *INCH      Value                       :
: Position down . . . 2        *INCH      Value                       :
: Font family . . . . HELVETICA      *PRTDEF, Value F4 for list :
: Point size . . . . 12              *CALC, Value                       :
: Bold . . . . . 1                    1=Yes                               :
: Italic . . . . .                    1=Yes                               :
: Rotation . . . . . *DEFAULT          *DEFAULT, 0, 90, 180, 270 :
: Color . . . . . *PRTDEF             *PRTDEF, Value F4 for list::
:                               More.. :
:-----:-----:
F4=Prompt          F12=Cancel
                  F22=Set Units

```

Figure 13. Map Text panel

## Outline Fonts

The current modification level of the APU enables you to download outline fonts to IPDS printers. You must first install the fonts, then update the font database (with the call qapu/qypusync command) before you can take advantage of this technology.

Outline fonts are scaleable fonts. A scalable font represents each character by a mathematical vector that can resolve or scale the character to any size. The point size of outline fonts can be anything from 1 to 999.9. Instead of entering a point size, you may enter \*CALC to have the system calculate the point size using information that is derived from the spooled file.

When you look at the **Work with Fonts** panel that includes outline fonts, you will see \*V in the size field instead of a positive numeric value. The \*V indicates that the size of the font is variable, and hence that it is an outline font:



```

Work with Fonts
Domain . . . . . : *ALL          *USR, *SYS, *ALL

Type Options, press Enter.
  1=Add  2=Change  4=Delete  5=Details

Opt  Font family      Size  Style      Font
     char. set      Code page  Domai
-----
TIMES NEW ROMAN      30  Bold-Italic C0N500T0   *DEFAULT *SYS
TIMES NEW ROMAN      36  Normal     C0N200Z0   *DEFAULT *SYS
TIMES NEW ROMAN      36  Italic     C0N300Z0   *DEFAULT *SYS
TIMES NEW ROMAN      36  Bold       C0N400Z0   *DEFAULT *SYS
TIMES NEW ROMAN      36  Bold-Italic C0N500Z0   *DEFAULT *SYS
TIMES NEW ROMAN Out1 *V Normal     CZN200      *DEFAULT *SYS
TIMES NEW ROMAN Out1 *V Italic     CZN300      *DEFAULT *SYS
TIMES NEW ROMAN Out1 *V Bold       CZN400      *DEFAULT *SYS
TIMES NEW ROMAN Out1 *V Bold-Italic CZN500      *DEFAULT *SYS

F3=Exit  F5=Refresh  F12=Cancel

```

Figure 14. Work with Fonts panel

## Custom Fonts

APU enables you to add special or custom fonts. You might use a custom font when:

- A particular font is an organizational standard.
- You need a unique font for a specific application. For example, a marketing document could require large characters that are not found in the standard fonts.
- You have modified IBM-supplied font resources (character set or code page) to change a character bit pattern or code point.
- You want a special monospaced font for columnar data.

You can use Type Transformer, an optional part of the AFP Font Collection, and various non-IBM font products to build AFP fonts. For example, you can use Type Transformer to convert any Adobe Type 1 font to an AFP font. After a font resource is built on the client, it can be uploaded and created on iSeries. See Appendix D, “AFP Resource Commands” on page 115 for detailed instructions on transferring and creating font resources.

To make a new font resource available to APU, add it to the APU font database. Use option 7 on the APU Main Menu to select **Work with Fonts**.

```

Work with Fonts
Domain . . . . . : *ALL                *USR, *SYS, *ALL

Type Options, press Enter.
  1=Add  2=Change  4=Delete  5=Details

Font
Opt  Font family      Size  Style      char. set  Code page  Domain
   5  HELVETICA        10   Bold       C0H40000  *DEFAULT  *SYS
      HELVETICA        9    Bold-Italic C0H50090  *DEFAULT  *SYS
      HELVETICA        10   Normal    C0H20000  *DEFAULT  *SYS
      HELVETICA        10   Italic     C0H30000  *DEFAULT  *SYS
      HELVETICA        10   Bold       C0H40000  *DEFAULT  *SYS
      HELVETICA        10   Bold-Italic C0H50000  *DEFAULT  *SYS
      HELVETICA        11   Normal    C0H200A0  *DEFAULT  *SYS
      HELVETICA        11   Italic     C0H300A0  *DEFAULT  *SYS
      HELVETICA        11   Bold       C0H400A0  *DEFAULT  *SYS
      HELVETICA        11   Bold-Italic C0H500A0  *DEFAULT  *SYS
      HELVETICA        12   Normal    C0H200B0  *DEFAULT  *SYS
      HELVETICA        12   Italic     C0H300B0  *DEFAULT  *SYS

F3=Exit  F5=Refresh  F12=Cancel
More...

```

Figure 15. Work with Fonts panel

The APU font database is displayed, showing the Helvetica character sets. Select option 5 to look at an existing character set record.

The **Display Font Details** pop-up panel shows the structure of the font records.

```

Work with Fonts
Domain . . . . . : *ALL                *USR, *SYS, *ALL

Type Options, press Enter.
.....
:                               Display Font Details                               :
:                               :                                                 :
:  Font family . . . . . HELVETICA                                         :
:  Point size . . . . . 10                                               :
:  Style . . . . . Bold                                                 :
:                               :                                                 :
:  Font character set . . C0H40000                                         :
:  Text description . . . HELVETICA LATIN1-ROMAN BOLD 10-PT                 :
:                               :                                                 :
:  Code page . . . . . *DEFAULT                                           :
:                               :                                                 :
:  Domain . . . . . *SYS                                                 :
:                               :                                                 :
:  Press Enter to continue.                                              :
:                               :                                                 :
:  F12=Cancel                                                           :
:                               :                                                 :
:                               :                                                 :
:                               :                                                 :
.....

```

Figure 16. Display Font Details on Work with Fonts panel

Character set C0H40000 is Helvetica Latin1 Roman Bold 10-point. It uses the default code page (that is stored in the APU defaults). This is a system font, which means that it cannot be changed. Press Enter to return to the **Work with Fonts** panel.

```

Work with Fonts
Domain . . . . . : *ALL                *USR, *SYS, *ALL

Type Options, press Enter.
  1=Add  2=Change  4=Delete  5=Details

Opt Font family      Size Style      Font
1   SPECIAL          9  Bold      char. set  Code page  Domain
   HELVETICA        9  Bold-Italic C0H40090  *DEFAULT  *SYS
   HELVETICA        9  Bold-Italic C0H50090  *DEFAULT  *SYS
   HELVETICA       10  Normal     C0H20000  *DEFAULT  *SYS
   HELVETICA       10  Italic     C0H30000  *DEFAULT  *SYS
   HELVETICA       10  Bold       C0H40000  *DEFAULT  *SYS
   HELVETICA       10  Bold-Italic C0H50000  *DEFAULT  *SYS
   HELVETICA       11  Normal     C0H200A0  *DEFAULT  *SYS
   HELVETICA       11  Italic     C0H300A0  *DEFAULT  *SYS
   HELVETICA       11  Bold       C0H400A0  *DEFAULT  *SYS
   HELVETICA       11  Bold-Italic C0H500A0  *DEFAULT  *SYS
   HELVETICA       12  Normal     C0H200B0  *DEFAULT  *SYS
   HELVETICA       12  Italic     C0H300B0  *DEFAULT  *SYS
                                                More...

F3=Exit  F5=Refresh  F12=Cancel

```

Figure 17. Request Addition of the Special Font

On the **Work with Fonts** panel, add a new font family that is called “Special”.

```

Work with Fonts
Domain . . . . . : *ALL                *USR, *SYS, *ALL

Type Options, press Enter.
  1=Add  2=Change  4=Delete  5=Details

Opt Font family      Size Style      Font
1   SPECIAL          9  Bold      char. set  Code page  Domain
   HELVET .....
   HELVET :                               Add a Font :
   HELVET :                               :
   HELVET : Type choices, press Enter. :
   HELVET :                               :
   HELVET : Font family . . . . . SPECIAL      Value :
   HELVET : Point size . . . . . 10          Value :
   HELVET : Bold . . . . . 1                1=Yes :
   HELVET : Italic . . . . .                1=Yes :
   HELVET : Font character set . . C0440200  Name   F4 for list :
   HELVET : Code page . . . . .           Name   F4 for list :
   HELVET :                               :
   : F4=Prompt  F12=Cancel :
F3=Exit  F :                               :
:.....:

```

Figure 18. Add the Special Font to APU

Type in the font details for the “Special” font on the **Add a Font** panel. Press Enter to add the “Special” font to the database.

See “Creating Font Resources” on page 115 for more details on fonts and font usage.

---

## Image Resources

Image resources are a key component in creating advanced electronic print and presentation applications. In some cases, such as with accent images, the purpose is to improve the look and effectiveness of output. Images like logos and signatures are essential parts of a document. In other image applications, such as an integrated check image on bank statements, the image is an actual part of the application data.

Figure 19 shows the image, combined with data from the overlay, that is used for the Super Sun Seeds logo.



Figure 19. Super Sun Seeds Logo

### How APU Works with Image Resources

Images are called *page segments* in AFP. APU can place page segments anywhere in a document. It can place multiple page segments on the same page, and it can vary the page segments by page format or copy.

Select **Define Page Segments** on the **Define a Copy** panel, then select **1 (Create)** on the **Define Page Segments** panel, press Enter and then press F4 on the **Create a Page Segment Positioning** panel. The **Select a Page Segment** panel appears. This panel is used to select page segments with APU.

```

      Define Page Segments
.....
Prin :                               Select a Page Segment           :
Li  :                               :                               :
   : Page Segment . . . . . *ALL                Name, Generic*, *ALL   :
Type :                               :                               :
   1 : Type Options, press Enter.              :
   :   1=Select                                :
Opt  : Page                                    :
   1 : Opt Segment      Text description       :
   :                               :
   :   1 STRWNB        Strawberry, no box, 300-pe1  :
   :     SUNLOGO      Sun Seeds Logo, 300-pe1     :
   :     TREENB       Tree, no box, 300-pe1       :
   :                               :
   :                               :
   :                               :
   :                               Bottom :
   :                               :
   ;           F5=Refresh  F12=Cancel            :
F3=E :                               :
.....

```

Figure 20. Select a Page Segment panel

Based on the library specified, APU retrieves all available page segments. Select **STRWNB**, an accent image of a strawberry, for use on the Super Sun Seeds invoice.

```

      Define Page Segments
Print Definition . . . : MYPRTDEF           Page Format . . . . . : *DEFAULT
Library . . . . . : QAPU           Copy . . . . . : *ORIGINAL

Type options, press Enter.
  1=Create  2=Change  3=Copy  4=Delete

    Position  Position  Unit of  Page
  Opt across  down    measure segment
                   *INCH
                   *INCH  STRWNB
                                          Bottom

F3=Exit  F5=Refresh  F12=Cancel
STRWNB at position 2.5/6 created

```

Figure 21. Define Page Segments panel

The **Define Page Segments** panel shows the page segment positioning for this copy. The Super Sun Seeds logo was not selected for the invoice document. Instead, this page segment was designed into the overlay, so it does not need to be separately placed by APU.

**Note:** When you are positioning resources, remember that each resource has its own offset. Margin settings are not applied to page segments and overlay positions, and APU cannot rotate page segments and overlays. If you want to rotate page segments and overlays, you must recreate them in the desired rotation, then specify their correct placement on the page relative to the original page origin.

For example, if you have a page segment in the upper left hand corner of an 8 1/2 by 11-inch page in portrait mode, and you rotate the entire page 180 degrees, you will need to recreate your page segment with a rotation of 180 degrees also. You then will need to specify the new position of the rotated page segment relative to the original page origin; in this case, the lower right corner of the page.

## Building Image Resources

Creating page segments for APU print applications involves several steps, from scanning the source artwork to creating the page segment object. The steps are:

1. Scan the source image (ideally, camera-ready artwork).
2. Touch up the scanned image.

Many client-based software packages support image editing.

3. Convert the image file to IOCA format.

You can use the IBM AFP Printer Driver for Windows to create IOCA page segments from any Windows application. Many software packages support IOCA format.

4. Upload the IOCA file to the iSeries.
5. Compile the page segment object.

Resource Management Utility (RMU), a module of AFPU, provides a complete creation (with resizing and rotation) and printing function for page segments.

See Appendix D, “AFP Resource Commands” on page 115 for additional instructions on creating page segment resources on iSeries.

---

## Overlay Resources

An electronic form or overlay is a collection of constant or static data that is stored as an AFP resource and used primarily in place of preprinted forms.

An overlay can include some or all of the following elements:

- Vertical, horizontal, and diagonal rules
- Rules with different weights and thickness
- Boxes with and without shading
- Grids, arcs, and polygons
- Graphics or image, such as company logos
- Bar codes
- Text
  - Different inline directions and character rotations for text
  - Different fonts, including fonts that are not used in the print file

**Note:** Elements that are used in an overlay depend on the tool used to create the overlay.

Figure 22 on page 27 shows an example of an overlay.

400 CPU Parkway Vegetation, NJ 55000		 <b>Super Sun Seeds</b> A Growth Company		Office: 555-499-2367 Fax: 555-415-9794	
-- Sold To --				-- Ship To --	
Customer Number:	Invoice Number:	Invoice Date:	Payment Date:		
Ship Via:	Shipped Date:	Terms:	Salesman:		
Qty	UOM	Item #	Item Description	Price	Extension

This invoice overlay designed using IBM AFP Utilities/400

Figure 22. Super Sun Seeds Invoice

## How APU Works with Overlays

APU can place overlays on any page, in virtually any location. APU can place multiple overlays per page and control the placement of each overlay. APU enables you to specify one constant back overlay, that is, print an overlay by itself on a page without data (for example, a “terms and conditions” page on the back of an invoice). You can use overlays conditionally by varying which overlays print on each page format or copy.

Select **Define overlays** on the **Define a Copy** panel and then select **1 (Create)** on the **Define Overlay Positionings** panel. Press F4 on the **Create an Overlay Positioning** panel. The **Select an Overlay** panel appears.

```

Define Overlay Positionings
.....
Prin :                               Select an Overlay                               :
Li  :                               :                                               :
   : Overlay . . . . . INV*           Name, Generic*, *ALL                       :
Type :                               :                                               :
  1 : Type Options, press Enter.       :                                               :
   : 1=Select                           :                                               :
   :                                     :                                               :
Opt  :                               :                                               :
   : Opt Overlay   Text description      :                                               :
.... :                               :                                               :
   :      INVOICE   INVOICE OVERLAY w/o LOGOS  :                                               :
   : 1  INVAL     INVOICE: ALL ON ONE PAGE      :                                               :
   : T  INVBAC     SUPER SUN SEEDS T&C.         :                                               :
   :      INVST     INVOICE: FIRST PAGE         :                                               :
   : P  INVHEAD    INVOICE: FULL HEADER         :                                               :
   : P  INVHEAD2   INVOICE: MIDDLE PAGE HEADER  :                                               :
   : O  INVLST     INVOICE: LAST PAGE           :                                               :
   :      INVMID   INVOICE: MIDDLE PAGE         :                                               :
   :                                                     More... :
   : F  F5=Refresh  F12=Cancel                  :                                               :
   :                                               :                                               :
.....

```

Figure 23. Select an Overlay panel

Select the **INVALL** overlay. The **Define Overlay Positionings** panel reappears.

```

Define Overlay Positionings
Print Definition . . . : MYPRTDEF           Page Format . . . . . : *DEFAULT
Library . . . . . : QAPU                 Copy . . . . . : *ORIGINAL
Type options, press Enter.
  1=Create  2=Change  3=Copy  4=Delete
Position  Position  Unit of
Opt across  down    measure  Overlay
   0        0      *INCH   INVALL
                                               Bottom
F3=Exit  F5=Refresh  F12=Cancel

```

Figure 24. Define Overlay Positionings panel

The **Define Overlay Positionings** panel summarizes which overlays are used for this copy. After you have defined the overlay, return to the **Define a Copy** panel and select **Set Page Layout Options**.

At the copy level using the **Set Page Layout Options** panel, define a constant back overlay. In this case, enter **INVBAC** as the overlay.



```

Set Page Layout Options
Print Definition . . . MYPRTEDEF      Page Format . . . . . : *DEFAULT
Library . . . . . QAPU              Copy . . . . . : *ORIGINAL

Type choices, press Enter.

Input drawer . . . . . *DEFAULT          *DEFAULT, 1, 2, 3, 4
Default line increment *PRTDEF *CM      *PRTDEF, *INPUT, Value
Default Column inc. . . *PRTDEF *CM      *PRTDEF, *INPUT, Value
Page length . . . . . *PRTDEF *CM      *PRTDEF, *INPUT, Value
Page width . . . . . *PRTDEF *CM      *PRTDEF, *INPUT, Value
Top margin (down) . . . *PRTDEF *CM      *PRTDEF, 0, Value
Left margin (across) . . *PRTDEF *CM      *PRTDEF, 0, Value
Page orientation . . . . *PRTDEF          *PRTDEF, *INPUT, 0, 90...
Duplex printing . . . . .                1=Yes, 2=Tumble
Back overlay . . . . . INVBAC          *NONE, Name F4 for list
  Position across . . . . 0 *CM          0, Value
  Position down . . . . . 0 *CM          0, Value

F3=Exit F4=Prompt F12=Cancel F22=Set Units

```

Figure 25. Page Layout Options - Copy Level

**Note:** When you specify \*INPUT for the “Page orientation” field, APU always attempts to create the output in Portrait mode by default. APU attempts to perform rotation according to the values specified for the “Page length” and “Page width” fields.

### Building Overlay Resources

IBM provides many alternatives for creating electronic overlays to be used in AFP printing applications. The options differ both in cost and in function. You must evaluate your requirements to select what best suits your needs.

- Some of the options available include:
- Overlay Utility, part of AFP Utilities for iSeries
  - IBM AFP Printer Driver for Windows, part of Client Access for iSeries (and available separately as well)
  - PC-based forms design programs, such as IBM’s Infoprint Designer and those provided by ISIS, ELIXIR, and TRANSFORM/400
  - Forms transferred from other systems
  - Overlay services from IBM and other companies

See Appendix D, “AFP Resource Commands” on page 115 for additional instructions on creating overlays.

---

### Bar Code Resources

Using bar codes enables you to turn standard printed documents into readable and scannable transactions. For example, you can encode data with a bar code to be used in your application flow. In many cases, bar coding is becoming a requirement in business documents (such as POSTNET for zip codes) and for various vendor and supplier applications.

Bar codes represent characters by using sets of parallel bars of varying width and separation or varying heights. Combinations of bars and spaces form individual characters, which in turn represent a numeric or alphanumeric symbol that may be

a product, part, or publication number. Bar codes are designed to be read by a device called a bar code reader or scanner. The scanner must be compatible with the printed bar code symbology.

The following sections show examples of two bar codes: Code 3 of 9 and POSTNET.

## Code 3 of 9 Bar Code Example

Code 3 of 9 is a discrete bar code symbology because each character stands by itself and is separated from the others by a non-data space or intercharacter gap. Code 3 of 9 is constructed so that each character has 9 elements (count both bars and spaces, but do not count the intercharacter gap) with 3 of those elements being wide.

Figure 26 shows an example of the Code 3 of 9 bar code symbology.

Code 3 of 9



Figure 26. Code 3 of 9 Bar Code Example

## POSTNET (Postal Bar Code) Bar Code Example

The POSTNET bar code uses five bars to represent a digit. The data is based on the height of the bars instead of on their width. This symbology requires a check digit or a correction digit. POSTNET is a numeric bar code only with each digit that has 2 tall bars and 3 short bars.

Figure 27 shows an example of the POSTNET bar code symbology.

POSTNET ZIP



Figure 27. POSTNET Bar Code Example

## How APU Works with Bar Codes

APU provides comprehensive support for bar codes:

- Printing application data or constant data in bar code format
- Handling the 12 major bar code symbologies and their variations
- Full control over size and positioning
- Handling the special attributes of each bar code, such as human-readable information and check digits

In the following example, the zip code is remapped into a POSTNET bar code. From the **Define Field Mapping** panel, use F14 to mark the beginning of the zip code field and F15 to mark the end of the zip code field, then press Enter. The **Select function** pop-up panel appears. Select **Map as Bar Code** to see the following panel.



```
.....
:                               Map Bar Code                               :
: Type choices, press Enter.                                           :
: Bar code type . . . : 12 - POSTNET                                     :
: Bar code data . . . : 457892637                                       :
: Length . . . . . : 9                                               :
: POSTNET Type . . . : 2                                               :
:                               1-50                                       :
:                               1=ZIP Code,                               :
:                               2=ZIP+4 Code,                             :
:                               3=Advanced Bar Code,                     :
:                               4=Variable length data                   :
:                               Bottom                                     :
:                               :                                           :
: F12=Cancel                                                            :
.....
```

Figure 30. Additional Bar Code Attributes

---

## Part 2. Creating Print Definitions with APU

<b>Chapter 3. Building an APU Print Definition for a Single Page Format</b> . . . . .	35
Example of a Single-Page Format Document . . . . .	35
Example of the SCS File to be Formatted . . . . .	35
Example of the Formatted File . . . . .	36
Setting up a Basic Print Definition . . . . .	36
Identifying Resources . . . . .	36
Working with a Print Definition . . . . .	37
Further Defining the Print Definition . . . . .	38
Working with Copies . . . . .	40
Selecting a Sample Spooled File . . . . .	42
Page Layout Options . . . . .	42
Page Layout Options You can Set . . . . .	42
Setting up Duplexing . . . . .	42
Defining Page Segments . . . . .	43
Defining Overlays . . . . .	44
Mapping Field Data . . . . .	45
Mapping a Field as Text . . . . .	47
Using the Repeat Function . . . . .	48
Mapping a Field at Multiple Locations . . . . .	49
Mapping a Field the First Time . . . . .	49
Mapping a Field to a Second Position . . . . .	50
Multiple Mapping Restrictions . . . . .	50

<b>Chapter 4. Building an APU Print Definition for Multiple Page Formats</b> . . . . .	51
Example of a Multiple Page Format Document . . . . .	51
Overview of Defining a Multiple Page Format Document . . . . .	54
Initial Copy for Page Format One . . . . .	55
Continuation Page Format . . . . .	55
Working with a Print Definition . . . . .	55
Identifying Resources . . . . .	55
Starting to Work on a Print Definition . . . . .	55
Developing Your Print Definition . . . . .	56
Defining Selection Fields . . . . .	59
Working with Copies . . . . .	60
Defining the Page Layout . . . . .	61
Specifying the Back Overlay . . . . .	62
Mapping Fields . . . . .	63
Mapping Bar Codes . . . . .	64
Defining Constant Data . . . . .	66
Selecting Fonts . . . . .	66
Defining Overlays . . . . .	68
Replicating the Contents of Copies . . . . .	69
Continuation Page Copies . . . . .	71



---

## Chapter 3. Building an APU Print Definition for a Single Page Format

This chapter provides you with a detailed procedure you use to develop a print definition on OS/400 for a single-page document. Here is a summary of the steps described in this chapter:

- “Example of a Single-Page Format Document”
- “Setting up a Basic Print Definition” on page 36
- “Further Defining the Print Definition” on page 38
- “Working with Copies” on page 40
- “Mapping Field Data” on page 45

**Note:** Refer to “Print Definition Creation” on page 111 for some helpful hints on creating print definitions.

Refer to Chapter 4, “Building an APU Print Definition for Multiple Page Formats” on page 51 for the procedure for developing multiple-page format print definitions.

---

### Example of a Single-Page Format Document

Following are two illustrations.

- “Example of the SCS File to be Formatted” shows the SCS file to be transformed by APU
- “Example of the Formatted File” on page 36 shows the same file after it has been transformed into an AFP file by APU

### Example of the SCS File to be Formatted

```
IMPROVED PRINTING CORP                SAME
PERFORMANCE BOULEVARD
PRINTERSVILLE
CO 45789-2637
    100                31300                1/26/98                2/26/98
    BEST WAY          1/26/98                NET 30                YOUR PRINTER REP

1 CT  00000300  HIGH ALTITUDE WATERMELON                1.01                1.01
1 PK  01100517  SPARTAN SEEDS                2.39                2.39
9 PK  04569870  NORTHERN LITE BLUE SPRUCE                858.32                7,724.88
12 BX 11005004  BUSH GREEN SEEDS                2.50                30.00
12 CT 11005011  LASSO RED SEEDS                892.23                10,706.76
26 PK 11005018  EARLY BANTAM SEEDS                .38                9.88
5 BX  11057893  AFRICAN DAISY, SEEDS                2.35                11.75
1 PK  15975365  HEAVY OAK                129.09                129.09
33 BX 32746510  HOPS BREWING LIGHT                1.20                39.60
6 EA  46578913  SEED SURVEYING SITE                50.00                300.00
2 BX  56413213  POT POT                7.65                15.30
80 PK 65412384  SEED SCRUBBER                888.79                71,103.20
1 PK  84512023  OREGON SPRING TOMATO SEED                .97                .97
2 DZ  96325874  PINEAPPLE-ORANGE SEEDS                1.29                2.58
11 BX 98412006  BLACK BEAUTY ZUCCHINI                2.30                25.30
5 EA  98546320  FROZEN JUICE PROCESSOR                109.90                549.50
```

Thank You .....  
Because you have ordered  
over \$500 of seeds this

year, on your next seed  
order you will receive  
a 10% discount.

\$90,652.21

2/26/98  
IMPROVED PRINTING CORP  
PERFORMANCE BOULEVARD  
PRINTERSVILLE  
CO 457892637

\$90,652.21

## Example of the Formatted File

The formatted output that you want to produce is shown in Figure 31.



400 CPU Parkway Vegetation, NJ 55090		 <b>Super Sun Seeds</b> A Growth Company		Office: 555-499-2367 Fax: 555-415-9794			
IMPROVED PRINTING CORP PERFORMANCE BOULEVARD PRINTERSVILLE CO 45789-2637			SAME				
-- Sold To --			-- Ship To --				
Customer Number:	100	Invoice Number:	31300	Invoice Date:	1/22/98	Payment Date:	2/22/98
Ship Via: BEST WAY Shipped Date: 1/22/98 Terms: NET 30 Salesman: YOUR PRINTER REP							
Qty	UOM	Item	Item Description	Price	Extension		
1	CT	00000300	HIGH ALTITUDE WATERMELON	1.01	1.01		
1	PK	01100517	SPARTAN SEEDS	2.39	2.39		
9	PK	04569870	NORTHERN LITE BLUE SPRUCE	858.32	7,724.88		
12	BX	11005004	BUSH GREEN SEEDS	2.50	30.00		
12	CT	11005011	LASSO RED SEEDS	892.23	10,706.76		
26	PK	11005018	EARLY BANTAM SEEDS	.38	9.88		
5	BX	11057893	AFRICAN DAISY, SEEDS	2.35	11.75		
1	PK	15975365	HEAVY OAK	129.09	129.09		
33	BX	32746510	HOPS BREWING LIGHT	1.20	39.60		
6	EA	46578913	SEED SURVEYING SITE	50.00	300.00		
2	BX	56413213	POT POT	7.65	15.30		
80	PK	65412384	SEED SCRUBBER	888.79	71,103.20		
1	PK	84512023	OREGON SPRING TOMATO SEED	.97	.97		
2	DZ	96325874	PINEAPPLE-ORANGE SEEDS	1.29	2.58		
11	BX	98412006	BLACK BEAUTY ZUCCHINI	2.30	25.30		
5	EA	98546320	FROZEN JUICE PROCESSOR	109.90	549.50		
Thank You . . . . Because you have ordered over \$500 of seeds this year, on your next seed order you will receive a 10% discount.							
<b>Total Due</b>						<b>\$90,652.21</b>	
Return this tear-off strip with your payment. Payment is due by: 2/22/98				Make Checks Payable to: <b>Super Sun Seeds</b> Amount Due is: \$90,652.21			
IMPROVED PRINTING CORP PERFORMANCE BOULEVARD PRINTERSVILLE CO 457892637						Page 1	

Figure 31. Super Sun Seeds Invoice

## Setting up a Basic Print Definition

This section describes the basic steps involved in setting up a print definition.

### Identifying Resources

For the following procedure, you will use the following sample resources that are included in the QAPU library:

- An overlay that contains the lines, boxes, and shading that you want on the preprinted form. This overlay is called **INVALL** in the sample in the QAPU library.
- A page segment that contains the company logo. In the samples included in the QAPU library, this page segment is called **SUNLOGO**.



**Note:** The output depends on the fonts that are available on your system. Your output may not match the following examples.

## Working with a Print Definition

1. Type:

GO QAPU/APU

on the command line of any OS/400 panel.

2. APU displays its main menu, as shown in Figure 32:

```
APU                                IBM Advanced Print Utility

Select one of the following:

Build and Test APU Print Definitions
  1. Work with Print Definitions
  2. Work with Spooled Files

Run APU in Batch Mode
  3. Work with APU Monitor
  4. Start APU Monitor
  5. End APU Monitor

Configure APU
  6. Set APU Defaults
  7. Work with Fonts
  8. Configure APU Monitor Action

Selection or command
====> 1

F3=Exit   F4=Prompt   F9=Retrieve   F12=Cancel   F16=System main menu
F23=Set initial menu
```

Figure 32. APU Main Menu panel

3. Select option 1, **Work with Print Definitions**, from the APU main menu. **Work with Print Definitions** appears, as shown in Figure 33:

```
Work with Print Definitions

Library . . . . . QAPU                Name, *CURLIB

Type options, press Enter.
  1=Create  2=Change  3=Copy  4=Delete  5=Display contents
  6=Print contents  7=Rename  10=Define  12=Work with

Opt Name      Text
1

Bottom

F3=Exit  F5=Refresh  F12=Cancel
```

Figure 33. Work with Print Definitions panel

4. Type **1** in the option column in the first row, then press Enter to create a new print definition, as shown in Figure 34:

```

Work with Print Definitions
Library . . . . . QAPU          Name, *CURLIB
Type options, press Enter.
 1=Create  2=Change  3=Copy  4=Delete  5=Display contents
 6=Print contents  7=Rename 10=Define 12=Work with
Opt Name      Text
1
:
:          Create a Print Definition          :
:
: Type choices, press Enter.                 :
:
: Print Definition . . . SUNSD1              Name :
: Library . . . . . QAPU                    Name, *CURLIB :
: Multiple page Formats . *NO                *YES, *NO :
: Text . . . . . SSS One Page Format         :
:
: F12=Cancel                                :
:
F3=Ex :.....

```

Figure 34. Create a Print Definition panel

5. Type the name of the Print Definition.

**Note:** Use the TAB key to move from field to field.

6. Type or select the name of the library where you want to store the print definition.
7. Select **\*NO** for the Multiple Page Formats item.

**Note:** The application we are using as an illustration only requires a single page format.

8. Type in a description of the print definition.
9. Your entries should look something like those in Figure 34.
10. When you have completed all entries, press Enter. The program should return you to the previous panel and display a message like this on the bottom, left corner:

Print Definition *name* in *library* created

In addition, when you press Enter on the **Create a Print Definition** panel, the **Work with Print Definition** panel is refreshed to show SUNSD1 in the list of available print definitions.

---

## Further Defining the Print Definition

If you want, at this time you can select option **10** to further define the print definition. For example, you can select the spooled file or set print definition attributes.

To further define the print definition:

1. First, type **10** in the OPT column next to your newly-created print definition to access the **Define a Print Definition** panel, as shown in Figure 35:

```

Define a Print Definition
Print Definition . . . : SUNSD1
Library . . . . . : QAPU
Type options, press Enter.
1=Select
Opt  Function
      Select a sample spooled file
      Set print definition attributes

F3=Exit  F12=Cancel

```

Figure 35. Define a Print Definition panel

2. At this point, you have two options:
  - a. Type a **1** to access the **Select a sample spooled file** panel, as shown in Figure 36:

```

Select a Sample Spooled File
Output Queue . . . . . *QYPUOUTQ      Name, *ALL      F4 for list
Library . . . . . QAPU                Name, *LIBL
User . . . . . *ALL                    Name, *CURRENT, *ALL
Type choices, press Enter.
1=Select  5=Display
          File
Opt  File      Nbr  User      User Data  Queue      Sts  Total
      INVPRE   1   USER1    QYPUOUTQ  QYPUOUTQ  RDY  7
      1  INVSCS  1   USER1    QYPUOUTQ  QYPUOUTQ  RDY  6

F4=Prompt  F5=Refresh  F12=Cancel
Bottom

```

Figure 36. Select a Sample Spooled File panel

This panel allows you to specify a sample SCS spooled file that is to be transformed by APU. Type a **1** next to INVSCS to select a sample spool file.

- b. Type a **1** next to **Set print definition attributes** selection to access the panel, as shown in Figure 37 on page 40:

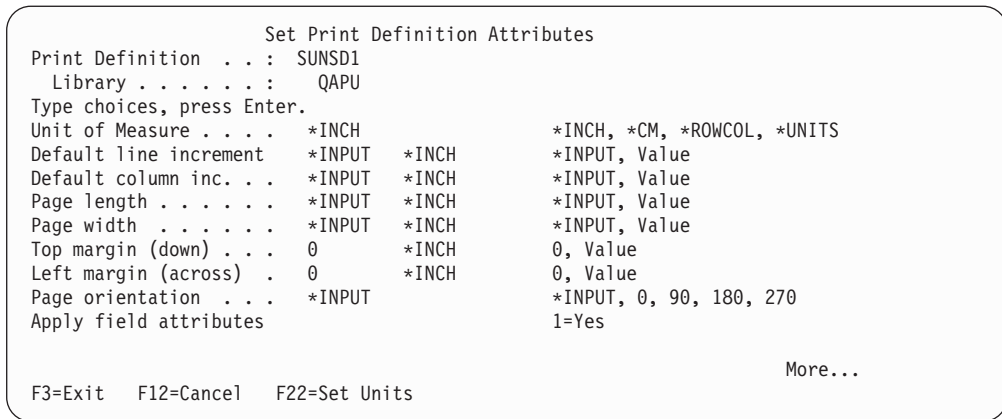

Figure 37. Set Print Definition Attributes panel 1

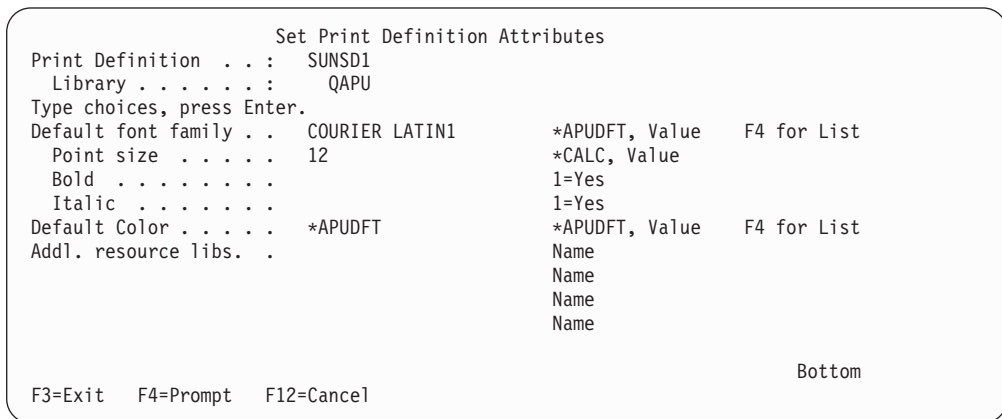

Figure 38. Set Print Definition Attributes panel 2

Press Enter until the **Work with Print Definitions** panel displays.

## Working with Copies

A page format needs a minimum of one copy. So, your next step is to examine the default values that APU has applied to the first, \*ORIGINAL copy and make any necessary changes.

1. Type **12** in the option column in the row containing SUNSD1, and the **Work with Copies** panel appears, as shown in Figure 39 on page 41:

```

                                Work with Copies
Print Definition . . . SUNSD1          Page Format . . . . . *DEFAULT
Library . . . . . QAPU

Type options, press Enter.
1=Create  2=Change  3=Copy  4=Delete  7=Rename
10=Define

Opt  Name          Text
    *ORIGINAL      Original (first copy)

                                Bottom

F3=Exit  F5=Refresh  F12=Cancel

```

Figure 39. Work with Copies panel

You do not need to create or name a page format; APU does that for you, naming the page format \*DEFAULT. APU automatically creates the first copy in the page format and names it \*ORIGINAL. You can rename it by selecting the rename option or leave it as it is.

- To begin defining the contents of the copy, type **10** in the option column in the row that contains the name \*ORIGINAL. Pressing Enter displays the **Define a Copy** panel, as shown in Figure 40:

```

                                Define a Copy
Print Definition . . . SUNSD1          Page Format . . . . . *DEFAULT
Library . . . . . QAPU          Copy . . . . . *ORIGINAL

Type options, press Enter.
1=Select

Opt  Function

    Select a sample spooled file
    Set page layout options
    Define field mapping
    Define constants
    Define boxes
    Define page segments
    Define overlays

F3=Exit  F12=Cancel

```

Figure 40. Define a Copy panel

You will use several options on this panel to define the formatting instructions for your output:

- You could use the **Select a sample spooled file** option to specify the name of the spooled file that contains the output of the billing application, but since you already specified this file in step 2a on page 39, you can skip this step.

- Select **Set page layout options** to specify the page size, orientation, and margins, as described in “Initial APU Setup” on page 14.
- Select **Define overlays** to name the overlay that you want merged with the application data on the page.
- Select **Define page segments** to include the company logo in the output.
- Select **Define field mapping** to map spooled file data to the output page.

Most of these steps are illustrated below. You can perform the steps in any order, as long as you select a sample spooled file first.

## Selecting a Sample Spooled File

Use the **Select a sample spooled file** option to specify the name of the spooled file that contains the output of the billing application.

**Note:** This action was performed previously in step 2a on page 39. This can be used to make changes to existing print definitions, rather than using the Define option.

## Page Layout Options

To set page layout options, type 1 next to that option to display the panel that is shown in Figure 41. This panel enables you to define page layout options for the \*ORIGINAL copy. These options include input drawer for this copy, page dimensions and options, and the use of a constant back overlay (back side overlay without application data).

```

Print Definition . . . SUNSD1
Library . . . . . QAPU
Type choices, press Enter.
Input drawer . . . . . *DEFAULT
Default line increment *PRTDEF *INCH
Default Column inc. . . *PRTDEF *INCH
Page length . . . . . 11 *INCH
Page width . . . . . 8.5 *INCH
Top margin (down) . . . 0 *INCH
Left margin (across) . . 0 *INCH
Page orientation . . . . 0
Duplex printing . . . . .
Back overlay . . . . . *NONE
  Position across . . . . *INCH
  Position down . . . . . *INCH
F3=Exit F4=Prompt F12=Cancel F22=Set Units

Set Page Layout Options
Page Format . . . . . : *DEFAULT
Copy . . . . . : *ORIGINAL
*DEFAULT, 1, 2, 3, 4
*PRTDEF, *INPUT, Value
*PRTDEF, *INPUT, Value
*PRTDEF, *INPUT, Value
*PRTDEF, 0, Value
*PRTDEF, 0, Value
*PRTDEF, *INPUT, 0, 90...
1=Yes, 2=Tumble
*NONE, Name F4 for list
0, Value
0, Value

```

Figure 41. Set Page Layout Options panel

### Page Layout Options You can Set

You can specify the following page layout options:

- The input drawer from which the paper is to be drawn
- Line and column increments for this page, such as six lines per inch for each line and ten characters per inch for each column
- Page length and width
- Page margins and orientation; in this example, all zeroes

### Setting up Duplexing

Notice that you can specify duplex printing.

You need to be aware of the capabilities and limitations of duplex printing:

### What Duplex Printing Does

1. Type **1** in the duplex printing field if you want simple duplex printing. The result will be that all second pages of the copy will be printed on the back side of the page. Enter a **2** to select tumble duplex.

### Restrictions

2. Duplex printing can be done only for consecutive pages of the same copy. **If more than one “copy” for a page format is required, duplex printing cannot be done because one copy never has two consecutive pages.**
3. If duplex printing is enabled (=1), then the **Back Overlay** field must be given a value of \*NONE, because you cannot print both an overlay and print text on the back side.

**Note:** Refer to “Duplex” on page 113 for some helpful hints on using duplex printing.

## Defining Page Segments

Select the **Define Page Segments** option to name and position the page segment that contains the company logo. The **Define Page Segments** panel is shown, as seen in Figure 42:

```
Define Page Segments
Print definition . . . SUNSD1      Page format . . . . . *DEFAULT
Library . . . . . QAPU          Copy . . . . . *ORIGINAL

Type options, press Enter.
1=Create 2=Change 3=Copy 4=Delete

      Position  Position  Unit of  Page
Opt across   Down     measure Segment
1                               *INCH

F3=Exit  F5=Refresh  F12=Cancel
```

Figure 42. Define Page Segment panel

Select option **1** to name a new page segment, then press Enter. Type the name of the page segment, STRWNB, and position it at the bottom of the page, as shown in Figure 43 on page 44:

```

Define Page Segments
Print Definition . . . : SUNSD1      Page Format . . . . . : *DEFAULT
Library . . . . . : QAPU          Copy . . . . . : *ORIGINAL
Type options, press Enter.
  1=Create  2=Change  3=Copy  4=Delete
    Position  Position  Unit of  Page
Opt across  down    measure segment
1
.....
:                Create a Page Segment Positioning                :
: Type choices, press Enter.                                         :
: Position across . . . . 3.6      *INCH  Value                      :
: Position down . . . . . 9        *INCH  Value                      :
: Page segment . . . . . STRWNB   Name    F4 for list                :
: F4=Prompt  F12=Cancel  F22=Set Units                               :
F3=E :.....

```

Figure 43. Create Page Segment Positioning panel

### Defining Overlays

Select the **Define overlays** option to name and position the overlay that you want to use to replace the preprinted form. The **Define Overlay Positionings** panel is shown in Figure 44:

```

Define Overlay Positionings
Print Definition . . . : SUNSD1      Page Format . . . . . : *DEFAULT
Library . . . . . : QAPU          Copy . . . . . : *ORIGINAL
Type options, press Enter.
  1=Create  2=Change  3=Copy  4=Delete
    Position  Position  Unit of
Opt across  down    measure Overlay
1
.....
F3=Exit  F5=Refresh  F12=Cancel

```

Figure 44. Define Overlay Positioning panel

Select option **1** to name a new overlay, then press Enter. Type the name of the overlay, INVALL, and where you want its top left corner to be positioned relative to the top left corner of the paper. Note the size of your overlay. If an overlay is too big, PSF for iSeries issues an error message when the job is printed, as shown in Figure 45 on page 45.



```

                                Define Overlay Positionings
Print Definition . . . : SUNSD1          Page Format . . . . . : *DEFAULT
Library . . . . . : QAPU              Copy . . . . . : *ORIGINAL

Type options, press Enter.
1=Create 2=Change 3=Copy 4=Delete

      Position  Position  Unit of
Opt across  down  measure  Overlay
1
.....
:                                Create an Overlay Positioning                                :
:                                                                                          :
: Type choices, press Enter.                                                                :
:                                                                                          :
: Position across . . . . 0          *INCH  Value                                          :
: Position down . . . . . 0          *INCH  Value                                          :
: Overlay . . . . . INVALL          Name    F4 for list                                     :
:                                                                                          :
: F4=Prompt  F12=Cancel  F22=Set Units                                                       :
:                                                                                          :
:                                                                                          :
:.....

```

Figure 45. Create an Overlay Positioning panel

If you want to use an overlay that is smaller than the page, you can change its location using the **Position across** and **Position down** fields. Assume that this overlay, INVALL, is designed to fill the whole page and should therefore be positioned at the origin of the paper (0,0).

## Mapping Field Data

Select the **Define Field Mapping** option to begin mapping the spooled file data to the output page. The **Define Field Mapping** panel is shown in Figure 46:

**Note:** Refer to “Mapping Data” on page 112 for some helpful hints on mapping data.

```

                                Define Field Mapping
Spooled file . . . . . : INVSCS          Page/Line . . . . . : 1/11
Control . . . . . : +10                Columns . . . . . : 1 - 78
*.....1.....2.....3.....4.....5.....6.....7.....
      IMPROVED PRINTING CORP          SAME
      PERFORMANCE BOULEVARD
      PRINTERSVILLE
      CO 45789-2637
          100          31300          1/22/98          2/22/98
          BEST WAY          1/22/98          NET 30          YOUR PRINTER RE

      1 CT  00000300  HIGH ALTITUDE WATERMELON          1.01          1.01
      1 PK  01100517  SPARTAN SEEDS          2.39          2.39
      9 PK  04569870  NORTHERN LITE BLUE SPRUCE          858.32          7,724.88
      More...
F3=Exit          F11=Hide mapping  F12=Cancel      F14=Start field
F15=End field    F16=Delete range  F20=Right

```

Figure 46. Define Field Mapping panel

Notice that the “header” of the panel displays the spooled file name, the page number, the line number, and the line you are currently dealing with (1/12, 2/12, and so on), and the number of columns currently displayed.

To define and map a field:

1. Position the cursor where you want the field to start in the spooled file and press F14. The rest of the line is highlighted.
2. Position the cursor where you want the field to end and press F15.
3. After you have defined the end of a field, the **Select Function** panel (in the following example, on the right side of panel) appears.

In this example, position the cursor under the I in IMPROVED and press F14. Then position the cursor under P in CORP and press F15, as shown in Figure 47:

```

Define Field Mapping
Spooled file . . . . . : INVSCS          Page/Line . . . . . : 1/11
Control . . . . . : +10                Columns . . . . . : 1 - 78
*.....1.....2.....3.....4.....5.....6.....7.....+...
IMPROVED PRINTING CORP          SAME
PERFORMANCE BOULEVAR.....
PRINTERSVILLE :                Select Function :
CO 45789-2637   :                :
:                : From Row / Column : 12 / 12 :
:                : Length . . . . . : 22      :
100             :                : 98
:                : Type option, press Enter. :
BEST WAY        :                : 1=Select : NTER RE
:                : Opt Function       :
1 CT 00000300 HIGH : 1 Map as Text      : 1.01
1 PK 01100517 SPAR : Map as Bar Code    : 2.39
9 PK 04569870 NORT : Suppress           : ,724.88
:                : More...           : ield
F3=Exit          F11=Hide ma : F12=Cancel
F15=End field    F16=Delete :

```

Figure 47. Select Function display

You can select from three options on the Select Function display:

- The **Map as Text** option enables you to specify formatting attributes and the position of the field on the printed page. You can place a field in up to four different positions on the page. Refer to “Mapping a Field at Multiple Locations” on page 49 for a description of this capability.
- The **Map as Bar Code** option enables you to print the field as a bar code. The data in this field must match the data you want represented in bar code. APU produces the bar code using Bar Code Object Content Architecture (BCOCA), which builds the bar code with all needed elements, such as HRI, Check Digit, and so on, depending on the bar code type.
- The **Suppress** option enables you to prevent the field from being printed.

**Note:** All of the original data prints “as is”, unless it is mapped as text, bar code, or suppressed. If you want a field to remain where it is, do not do anything to it.

## Mapping a Field as Text

In this example, select option **1** to map the customer name as text. When you select **Map as Text**, the **Map Text** panel appears, as shown in Figure 48:

```
Define Field Mapping
Spooled file . . . . . : INVSCS                Page/Line . . . . . : 1/1
.....
:                                         Map Text                                         :
: Type choices, press Enter.                                     :
: From Row / Column : 12 / 12                                     :
: Mapping . . . . . : 1 / 1                                       :
: Length . . . . . 22                                           :
: Position across . . 1.1          *INCH          Value        :
: Position down . . . 2            *INCH          Value        :
: Font family . . . . HELVETICA          *PRTDEF, Value  F4 for list :
: Point size . . . . 12                  *CALC, Value                               :
: Bold . . . . . 1                            1=Yes                             :
: Italic . . . . .                               1=Yes                             :
: Rotation . . . . . *DEFAULT              *DEFAULT, 0, 90, 180, 270 :
: Color . . . . . *PRTDEF                  *PRTDEF, Value  F4 for list :
:                                         More...                                         :
: F4=Prompt          F12=Cancel            :
:                                         F22=Set Units    :
.....
```

Figure 48. Map Text panel

In this example, you need to map the customer's name to print in bold and a larger font. This is the area that uses the HELEVTICA font, so you need to select that font. You also need to position the field on the page.

After you press Enter on the **Map Text** panel, the **Define Field Mapping** panel is updated to show that the field has been mapped, as shown in Figure 49:

```
Define Field Mapping
Spooled file . . . . . : INVSCS                Page/Line . . . . . : 1/11
Control . . . . .     +10                      Columns . . . . .   : 1 - 78
*...+...1...+...2...+...3...+...4...+...5...+...6...+...7...+...
2222222222222222222222222222                SAME
PERFORMANCE BOULEVARD
PRINTERSVILLE
CO 45789-2637
          100          31300          1/22/98          2/22/98
        BEST WAY          1/22/98          NET 30          YOUR PRINTER RE

  1 CT  00000300  HIGH ALTITUDE WATERMELON          1.01          1.01
  1 PK  01100517  SPARTAN SEEDS                         2.39          2.39
  9 PK  04569870  NORTHERN LITE BLUE SPRUCE          858.32        7,724.88
More...
F3=Exit          F11=Hide mapping    F12=Cancel      F14=Start field
F15=End field    F16=Delete range                    F20=Right
```

Figure 49. Define Field Mapping Completed panel

The field that you just mapped is shown in this panel as a string of **2s**. You can use the F11 key to toggle between showing the mappings and hiding the mappings, which shows only the data. If you need to change the mapping attributes or placement, you can position the cursor inside the area shown with **2s** and press Enter, which displays the **Edit Text Mapping** panel.

When you map a field, the mapping is displayed as follows:

Table 1. Field Mapping Values

1s	Bar code
2s	Text
4s	Suppression
1/2s	Bar code and text overlapped
1/4s	Bar code and suppression overlapped

**Note:** If you want to edit a field you have previously mapped more than once (for example, mapping both bar code and text, or both bar code and suppression for a field), position the cursor on the mapped field and press Enter. The **Edit Text Mapping** panel appears allowing you to choose which mapping you want to edit, as shown in Figure 50.

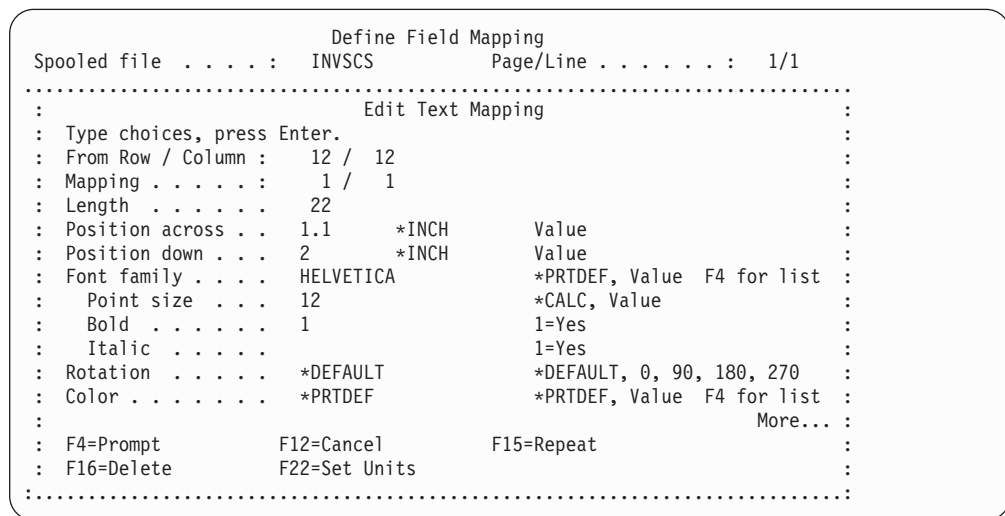

Figure 50. Edit Text Mapping panel

## Using the Repeat Function

In addition to changing the formatting attributes and position of the mapped data, you can also use the Repeat function on this display to copy the formatting attributes from the selected field to other fields. In this example, you want to use the same formatting attributes for the three address lines as you did for the customer name, so you can press F15 to open the **Repeat Text Mapping** panel.

```

Define Field Mapping
Spooled file . . . . . : INVSCS          Page/Line . . . . . : 1/1

Edit Text Mapping
Type choices, pr.....:
:
: Repeat Text Mapping
:
From Row / Colum :
Mapping . . . . . : From row / column . . : 12 / 12
Length . . . . . : Length . . . . . : 22
: Position across . . . : 1.1 *INCH
Position across : Position down . . . . : 2 *INCH
Position down . :
Font family . . : Type choices for repetitions, press Enter.
Point size . . :
Bold . . . . . : Starting row . . . . . 13 Value
Italic . . . . . : Number of repetitions . 3 Value
Rotation . . . . :
Color . . . . . : Starting position down 2.167 *INCH Value
: Line increment . . . . 0.167 *INCH Value
F4=Prompt :
F16=Delete : F12=Cancel
.....

```

Figure 51. Repeat Function of Text Mapping panel

Using the **Repeat Text Mapping** panel, you can repeat the text mapping you already defined for a field to other lines in the spooled file. To repeat the mapping you selected, specify the following on the **Repeat Text Mapping** panel:

- The first row in the spooled file that you want to apply the selected mapping to (13 in this example)
- The number of rows that you want the repeated mapping to apply to (3 in this example)
- The vertical print position where you want the first repeated mapping to be placed (2.167 in this example)
- The spacing between the repeated mappings (0.167 in this example)

You can continue to map the remainder of the data in the spooled file by using the steps that are described in this section. When you have mapped or suppressed all of the data in one page of the spooled file, you have completed the print definition for this application.

**Note:** You can use the **Print contents** option on the **Work with Print Definitions** panel to see a detailed summary of the mappings you have specified.

### Mapping a Field at Multiple Locations

APU includes the capability to map or position fields at more than one location. This section describes this capability.

#### Mapping a Field the First Time

When you begin to map a field, the “Map Text” panel will inform you that you are “Mapping 1/1”:

```

Define Field Mapping
Spooled file . . . . . : INVSCS          Page/Line . . . . . : 1/1
:
: .....
:                               Map Text
:                               :
: Type choices, press Enter.   :
: From Row / Column : 12 / 12      :
: Mapping . . . . . : 1 / 1       :
: Length . . . . . : 22           :
: Position across . . 1.1      *INCH Value
: Position down . . . 2        *INCH Value
: Font family . . . . HELVETICA *PRTDEF, Value F4 for list
: Point size . . . . 12        *CALC, Value
: Bold . . . . . 1            1=Yes
: Italic . . . . .           1=Yes
: Rotation . . . . . *DEFAULT  *DEFAULT, 0, 90, 180, 270
: Color . . . . . *PRTDEF     *PRTDEF, Value F4 for list
:                               More...
: F4=Prompt          F12=Cancel
:                   F22=Set Units
:
: .....

```

Figure 52. Repeat Function of Text Mapping panel

**Mapping a Field to a Second Position**

If you want to place the field at a different position, press the **PAGE-DOWN** key to re-display the above window. This time, however, the screen will say “Mapping 2/2”:

```

Define Field Mapping
Spooled file . . . . . : INVSCS          Page/Line . . . . . : 1/5
:
: .....
:                               Edit Text Mapping
:                               :
: Type choices, press Enter.   :
: From Row / Column : 12 / 12      :
: Mapping . . . . . : 2 / 2       :
: Length . . . . . : 22           :
:
: .....

```

Figure 53. Mapping a Second Position panel

Keep pressing Enter to exit.

**Multiple Mapping Restrictions**

The following restrictions apply to the multiple field location mapping function:

1. You can place the same field at four locations only; that is the first location and three additional locations.
2. You can change the length of the field in the first mapping only. You will not be allowed to change the field length for additional locations. Thus, you can only set the units for the first location, but not after that.
3. The F16 (Delete) function will delete all specifications if the first target location is shown; otherwise it will only delete one target location (2 to 4).

---

## Chapter 4. Building an APU Print Definition for Multiple Page Formats

This chapter provides you with a detailed procedure you use to develop a print definition with APU for a multiple-page format document. Here is a summary of the steps described in this chapter:

- “Example of a Multiple Page Format Document”
- “Overview of Defining a Multiple Page Format Document” on page 54
- “Working with a Print Definition” on page 55
- “Working with Copies” on page 60
- “Mapping Fields” on page 63
- “Replicating the Contents of Copies” on page 69
- “Continuation Page Copies” on page 71

**Note:** Refer to “Print Definition Creation” on page 111 for some helpful hints on creating print definitions.

Refer to Chapter 3, “Building an APU Print Definition for a Single Page Format” on page 35 for the procedure for developing single-page print definitions.

---

### Example of a Multiple Page Format Document

The Super Sun Seeds Company has an invoice with simple preprinted forms that allows the format of the continuation page to be different from the first page. This facilitates, among other things, a full invoicing heading section on page one, and an abbreviated heading on the following pages. Shown below is an example of the Super Sun Seeds invoice:

400 CPU Parkway  
Vegetation, NJ 55090



**Super Sun Seeds**  
A Growth Company

Office: 555-499-2367  
Fax: 555-415-9794

---

ORGANIC GARDEN SUPPLIES  
546 PRODUCE WAY  
GOLDENWATS  
CO 94523-4852

ORGANICS-ON-THE-MOVE  
3872 NATURE'S WAY  
NOCHEMS  
AK 49972-5341

---

Customer Number: 136

Invoice Number: 31336

Invoice Date: 1/22/98

Payment Date: 2/22/98

Office: 555-499-2367  
Fax: 555-415-9794

---

Ship Via: CLEAN TRK Shipped Date: 1/22/98 Terms: NET 30 Salesman: CHRIS SEEDER

ORGANICS-ON-THE-MOVE  
3872 NATURE'S WAY  
NOCHEMS  
AK 49972-5341

---

Qty	UOM	Item	Item Description	Price	Extension
90	CT	00000300	HIGH ALTITUDE WATERMELON	1.01	90.90
550	CT	00000300	HIGH ALTITUDE WATERMELON	1.01	555.50
100	EA	00001200	ARBOLES DEL SUR	45.00	4,500.00
25	EA	00231300	SEED ROASTER OVEN SET	199.99	4,999.75
150	PK	04569870	NORTHERN LITE BLUE SPRUCE	858.32	28,748.00
2	BX	11005000	FAVA SEEDS	3.90	7.80
2	BX	11005001	PURPLE TEEPEE SEEDS	4.44	8.88
52	BX	11005002	BUSH WAX SEEDS	2.00	104.00
52	BX	11005003	KINGHORN WAX SEEDS	2.13	110.76
8	BX	11005004	BUSH GREEN SEEDS	2.50	20.00
8	BX	11005005	BLUE LAKE GREEN SEEDS	4.00	32.00
2	BX	11005006	KINGHORN WAX SEEDS	3.00	6.00
2	CT	11005007	VENTURE GREEN SEEDS	1.50	3.00
100	CT	11005008	NORTHEASTERN FOLE SEEDS	1.29	129.00
100	CT	11005009	KENTUCKY BLUE SEEDS	2.10	210.00
58	CT	11005010	EARLY DWARF DANISH SEEDS	3.01	174.58
58	CT	11005011	LIASSO RED SEEDS	892.23	51,749.34
84	EA	11005012	BLUE MAX SAVY BEANS	1.23	103.32
84	DZ	11005013	MINGOR NANTES CARROT SEED	.87	73.08
10	DZ	11005014	SCARLET NANTES SEEDS	5.90	59.00
5	DZ	11005014	SCARLET NANTES SEEDS	5.90	29.50
10	BZ	11005015	CHAMTENAY SEEDS	2.19	21.90
63	BZ	11005016	TOUCHON SEEDS	2.83	178.29
65	BZ	11005016	TOUCHON SEEDS	2.83	183.95
2	PK	11005018	EARLY BANTAM SEEDS	.38	.76

---

**Total Due** Continued

ORGANICS-ON-THE-MOVE  
3872 NATURE'S WAY  
NOCHEMS  
AK 49972-5341

---

Return this tear-off strip with your payment. Make Checks Payable to: **Super Sun Seeds**  
Payment is due by: Amount Due is:

ORGANICS-ON-THE-MOVE  
3872 NATURE'S WAY  
NOCHEMS  
AK 49972-5341

---

Customer Copy Page 1

ORGANICS-ON-THE-MOVE  
3872 NATURE'S WAY  
NOCHEMS  
AK 49972-5341

---

Return this tear-off strip with your payment. Make Checks Payable to: **Super Sun Seeds**  
Payment is due by: Amount Due is:

ORGANICS-ON-THE-MOVE  
3872 NATURE'S WAY  
NOCHEMS  
AK 49972-5341

---

File Copy Page 1

ORGANICS-ON-THE-MOVE  
3872 NATURE'S WAY  
NOCHEMS  
AK 49972-5341

---

Return this tear-off strip with your payment. Make Checks Payable to: **Super Sun Seeds**  
Payment is due by: Amount Due is:

ORGANICS-ON-THE-MOVE  
3872 NATURE'S WAY  
NOCHEMS  
AK 49972-5341

---

Packing List Page 1

ORGANICS-ON-THE-MOVE  
3872 NATURE'S WAY  
NOCHEMS  
AK 49972-5341

Figure 54. Super Sun Seeds Invoice - Page 1



 <b>Super Sun Seeds</b> A Growth Company		400 CPU Parkway Vegetation, NJ 55090 Office: 555-499-2367 Fax: 555-415-9794																																																																																																																																										
ORGANIC GARDEN SUPPLIES 546 PRODUCE WAY GOLDENNOTS, CO 94523-4852 - Ship To -		ORGANICS-ON-THE-MOVE 3872 NATURE'S WAY NOCHEMS AK 49972-5341 - Ship To -																																																																																																																																										
Customer Number: 136 Ship Via: CLEAN TRK	Invoice Number: 31336 Shipped Date: 1/22/98	Invoice Date: 1/22/98 Payment Date: 2/22/98 Terms: NET 30 Salesman: CHRIS SEEDER																																																																																																																																										
<table border="1"> <thead> <tr> <th>Qty</th> <th>UOM</th> <th>Item</th> <th>Item Description</th> <th>Price</th> <th>Extension</th> </tr> </thead> <tbody> <tr><td>2</td><td>PK</td><td>11005019</td><td>NORTHERN PICKLING SEEDS</td><td>.39</td><td>.78</td></tr> <tr><td>90</td><td>PK</td><td>11005020</td><td>FRENCH PICKLING SEEDS</td><td>2.39</td><td>215.10</td></tr> <tr><td>100</td><td>BX</td><td>11057893</td><td>AFRICAN DAISY, SEEDS</td><td>2.35</td><td>235.00</td></tr> <tr><td>25</td><td>CT</td><td>12382910</td><td>SUCCATASH SEEDS</td><td>.38</td><td>9.50</td></tr> <tr><td>45</td><td>CT</td><td>13145340</td><td>SOUR GRAPE SEEDS</td><td>.15</td><td>6.75</td></tr> <tr><td>10</td><td>FT</td><td>15789342</td><td>BLUE BELLES, BRIGHT BLUE</td><td>18.57</td><td>185.70</td></tr> <tr><td>50</td><td>PK</td><td>15975365</td><td>HEAVY OAK</td><td>129.09</td><td>6,454.50</td></tr> <tr><td>25</td><td>EA</td><td>31321654</td><td>BELLSTAR SEEDS</td><td>7.88</td><td>197.00</td></tr> <tr><td>2</td><td>EA</td><td>31321654</td><td>BELLSTAR SEEDS</td><td>7.88</td><td>15.76</td></tr> <tr><td>25</td><td>DZ</td><td>32154657</td><td>PETERSBURG PALM TREE</td><td>34.90</td><td>872.50</td></tr> <tr><td>6</td><td>BZ</td><td>32165479</td><td>BLACK EYED BANANA</td><td>3.01</td><td>18.06</td></tr> <tr><td>45</td><td>BX</td><td>32746510</td><td>HOPS BREWING LIGHT</td><td>1.20</td><td>54.00</td></tr> <tr><td>10</td><td>CT</td><td>35456031</td><td>SUNNY SUNFLOWER SEEDS</td><td>1.23</td><td>12.30</td></tr> <tr><td>50</td><td>EA</td><td>35715924</td><td>SEED SIFTER SET</td><td>2,900.00</td><td>45,000.00</td></tr> <tr><td>18</td><td>EA</td><td>40113254</td><td>FRESH FRUIT CANNED CANNER</td><td>22.97</td><td>413.46</td></tr> <tr><td>6</td><td>BX</td><td>56413213</td><td>POT POT</td><td>7.65</td><td>45.90</td></tr> <tr><td>1000</td><td>PK</td><td>64132029</td><td>PITLESS PEACH SEEDS</td><td>.97</td><td>970.00</td></tr> <tr><td>500</td><td>EA</td><td>90978412</td><td>TREE TRIMMER TUBING</td><td>.20</td><td>100.00</td></tr> <tr><td>6</td><td>CT</td><td>94875081</td><td>EARLROUGE TOMATO SEEDS</td><td>.49</td><td>2.94</td></tr> <tr><td>45</td><td>BX</td><td>98412006</td><td>BLACK BEAUTY ZUCCHINI</td><td>.230</td><td>103.50</td></tr> <tr><td>5</td><td>EA</td><td>98546320</td><td>FROZEN JUICE PROCESSOR</td><td>109.90</td><td>549.50</td></tr> <tr> <td colspan="4" style="text-align: right;"><b>Total Due</b></td> <td>Continued</td> <td></td> </tr> </tbody> </table>		Qty	UOM	Item	Item Description	Price	Extension	2	PK	11005019	NORTHERN PICKLING SEEDS	.39	.78	90	PK	11005020	FRENCH PICKLING SEEDS	2.39	215.10	100	BX	11057893	AFRICAN DAISY, SEEDS	2.35	235.00	25	CT	12382910	SUCCATASH SEEDS	.38	9.50	45	CT	13145340	SOUR GRAPE SEEDS	.15	6.75	10	FT	15789342	BLUE BELLES, BRIGHT BLUE	18.57	185.70	50	PK	15975365	HEAVY OAK	129.09	6,454.50	25	EA	31321654	BELLSTAR SEEDS	7.88	197.00	2	EA	31321654	BELLSTAR SEEDS	7.88	15.76	25	DZ	32154657	PETERSBURG PALM TREE	34.90	872.50	6	BZ	32165479	BLACK EYED BANANA	3.01	18.06	45	BX	32746510	HOPS BREWING LIGHT	1.20	54.00	10	CT	35456031	SUNNY SUNFLOWER SEEDS	1.23	12.30	50	EA	35715924	SEED SIFTER SET	2,900.00	45,000.00	18	EA	40113254	FRESH FRUIT CANNED CANNER	22.97	413.46	6	BX	56413213	POT POT	7.65	45.90	1000	PK	64132029	PITLESS PEACH SEEDS	.97	970.00	500	EA	90978412	TREE TRIMMER TUBING	.20	100.00	6	CT	94875081	EARLROUGE TOMATO SEEDS	.49	2.94	45	BX	98412006	BLACK BEAUTY ZUCCHINI	.230	103.50	5	EA	98546320	FROZEN JUICE PROCESSOR	109.90	549.50	<b>Total Due</b>				Continued		ORGANICS-ON-THE-MOVE 3872 NATURE'S WAY NOCHEMS AK 49972-5341 - Ship To -
Qty	UOM	Item	Item Description	Price	Extension																																																																																																																																							
2	PK	11005019	NORTHERN PICKLING SEEDS	.39	.78																																																																																																																																							
90	PK	11005020	FRENCH PICKLING SEEDS	2.39	215.10																																																																																																																																							
100	BX	11057893	AFRICAN DAISY, SEEDS	2.35	235.00																																																																																																																																							
25	CT	12382910	SUCCATASH SEEDS	.38	9.50																																																																																																																																							
45	CT	13145340	SOUR GRAPE SEEDS	.15	6.75																																																																																																																																							
10	FT	15789342	BLUE BELLES, BRIGHT BLUE	18.57	185.70																																																																																																																																							
50	PK	15975365	HEAVY OAK	129.09	6,454.50																																																																																																																																							
25	EA	31321654	BELLSTAR SEEDS	7.88	197.00																																																																																																																																							
2	EA	31321654	BELLSTAR SEEDS	7.88	15.76																																																																																																																																							
25	DZ	32154657	PETERSBURG PALM TREE	34.90	872.50																																																																																																																																							
6	BZ	32165479	BLACK EYED BANANA	3.01	18.06																																																																																																																																							
45	BX	32746510	HOPS BREWING LIGHT	1.20	54.00																																																																																																																																							
10	CT	35456031	SUNNY SUNFLOWER SEEDS	1.23	12.30																																																																																																																																							
50	EA	35715924	SEED SIFTER SET	2,900.00	45,000.00																																																																																																																																							
18	EA	40113254	FRESH FRUIT CANNED CANNER	22.97	413.46																																																																																																																																							
6	BX	56413213	POT POT	7.65	45.90																																																																																																																																							
1000	PK	64132029	PITLESS PEACH SEEDS	.97	970.00																																																																																																																																							
500	EA	90978412	TREE TRIMMER TUBING	.20	100.00																																																																																																																																							
6	CT	94875081	EARLROUGE TOMATO SEEDS	.49	2.94																																																																																																																																							
45	BX	98412006	BLACK BEAUTY ZUCCHINI	.230	103.50																																																																																																																																							
5	EA	98546320	FROZEN JUICE PROCESSOR	109.90	549.50																																																																																																																																							
<b>Total Due</b>				Continued																																																																																																																																								
Return this tear-off strip with your payment. Make Checks Payable to: <b>Super Sun Seeds</b> Payment is due by: <b>Amount Due is:</b>		Office: 555-499-2367 Fax: 555-415-9794																																																																																																																																										
Customer Copy Page 2		ORGANICS-ON-THE-MOVE 3872 NATURE'S WAY NOCHEMS AK 49972-5341 - Ship To -																																																																																																																																										
Return this tear-off strip with your payment. Make Checks Payable to: <b>Super Sun Seeds</b> Payment is due by: <b>Amount Due is:</b>		Office: 555-499-2367 Fax: 555-415-9794																																																																																																																																										
File Copy Page 2		ORGANICS-ON-THE-MOVE 3872 NATURE'S WAY NOCHEMS AK 49972-5341 - Ship To -																																																																																																																																										
Return this tear-off strip with your payment. Make Checks Payable to: <b>Super Sun Seeds</b> Payment is due by: <b>Amount Due is:</b>		Office: 555-499-2367 Fax: 555-415-9794																																																																																																																																										
Packing List Page 2		ORGANICS-ON-THE-MOVE 3872 NATURE'S WAY NOCHEMS AK 49972-5341 - Ship To -																																																																																																																																										

Figure 55. Super Sun Seeds Invoice - Page 2

400 CPU Parkway Vegetation, NJ 55090		 <b>Super Sun Seeds</b> A Growth Company		Office: 555-499-2367 Fax: 555-415-9794	
ORGANIC GARDEN SUPPLIES 546 PRODUCE WAY GOLDENOATS CO 94523-4852		ORGANICS-ON-THE-MOVE 3872 NATURE'S WAY NOCHEMS AK 49972-5341		- Sold To - - Ship To -	
Customer Number: 136	Invoice Number: 31336	Invoice Date: 1/22/98	Payment Date: 2/22/98	Office: 555-499-2367 Fax: 555-415-9794	
Ship Via: CLEAN TRK		Shipped Date: 1/22/98	Terms: NET 30	Salesman: CHRIS SEEDER	
Qty	UOM	Item	Item Description	Price	Extension
Thank You . . . . . Because you have ordered over \$500 of fruit this year, on your next fruit order you will receive a 10% discount.					
<b>Total Due</b>				\$147,561.56	
Return this tear-off strip with your payment. Make Checks Payable to: <b>Super Sun Seeds</b> <b>Payment is due by:</b> 2/22/98 <b>Amount Due is:</b> \$147,561.56					
ORGANIC GARDEN SUPPLIES 546 PRODUCE WAY GOLDENOATS CO 945234852			. . . . . ordered it this xt fruit receive		
<b>Customer Copy</b>			Page 3		
Return this tear-off strip with your payment. Make Checks Payable to: <b>Super Sun Seeds</b> <b>Payment is due by:</b> 2/22/98 <b>Amount Due is:</b> \$147,561.56					
ORGANIC GARDEN SUPPLIES 546 PRODUCE WAY GOLDENOATS CO 945234852			. . . . . ordered it this xt fruit receive		
<b>File Copy</b>			Page 3		
Return this tear-off strip with your payment. Make Checks Payable to: <b>Super Sun Seeds</b> <b>Payment is due by:</b> 2/22/98 <b>Amount Due is:</b> \$147,561.56					
ORGANIC GARDEN SUPPLIES 546 PRODUCE WAY GOLDENOATS CO 945234852			. . . . . ordered it this xt fruit receive		
<b>Packing List</b>			Page 3		

Figure 56. Super Sun Seeds Invoice - Page 3

## Overview of Defining a Multiple Page Format Document

This section describes the overall set of steps you will take to define a multiple-page print definition. The specific procedure is provided beginning in “Working with a Print Definition” on page 55.

You will need to define two different page formats (one for page one and the second for the continuation pages) and then define the various copies within each page format. The steps to create the APU print definition are:

1. Create a print definition that is called INVOICE, and specify multiple page formats.
2. Select a sample spooled file (INVSCS).
3. Define print definition attributes, such as unit of measure, page size, margins, and so on.
4. Define the selection field in the sample spooled file that determines which page format to use. The page number is used to differentiate the page formats.
5. Define the rules for identifying a page format, based on the selection field.

## Initial Copy for Page Format One

APU automatically creates the initial copy for page format one (the default name for the copy is \*ORIGINAL). Define the details of that first copy, as follows:

1. Specify general page layout options that includes the constant (Terms and Conditions) back overlay (INVBAC)
2. Map data in the spooled file, such as the zip code to POSTNET bar code.
3. Add the constant text **Customer Copy** at the bottom
4. Place page one overlay (INVALL) on front
5. Define two additional copies, the packing list copy and file copy, by first copying the definition of the \*ORIGINAL copy
6. Change the packing list copy, suppressing pricing information and printing **Packing List** as constant text
7. Change the file copy, printing **File Copy** at the bottom

## Continuation Page Format

At this point, you have defined how page one and its copies will look. Because the page format for the continuation pages will have a very similar layout to page one, just copy the entire page format. The steps are:

1. Copy the page one format (PAGE1) to the second or continuation page format (PAGEN).
2. Make the appropriate changes to the copies within this PAGEN format, such as changing the front overlay used.

---

## Working with a Print Definition

### Identifying Resources

To use the following procedure, you will use the following sample resources that are included in the QAPU library:

- An overlay that contains the lines, boxes, and shading that you want on the preprinted form. This overlay is called INVALL in the sample in the QAPU library.
- A page segment that contains the company logo. In the samples that are included in the QAPU library, this page segment is called SUNLOGO.

### Starting to Work on a Print Definition

1. Start from the APU Main Menu. as shown in Figure 57 on page 56:

```

APU                               IBM Advanced Print Utility
Select one of the following:
Build and Test APU Print Definitions
  1. Work with Print Definitions
  2. Work with Spooled Files
Run APU in Batch Mode
  3. Work with APU Monitor
  4. Start APU Monitor
  5. End APU Monitor
Configure APU
  6. Set APU Defaults
  7. Work with Fonts
  8. Configure APU Monitor Action
Selection or command
===>
F3=Exit   F4=Prompt   F9=Retrieve   F12=Cancel   F16=System main menu
F23=Set initial menu
5798-AF4 (C) COPYRIGHT IBM CORP. 1996, 1997

```

Figure 57. APU Main Menu Panel

2. Select option **1** to create a print definition, as shown in Figure 58.

```

                                Work with Print Definitions
Library . . . . . QAPU                Name, *CURLIB
Type options, press Enter.
  1=Create  2=Change  3=Copy  4=Delete  5=Display contents
  6=Print contents  7=Rename  10=Define  12=Work with

Opt  Name      Text
  1  INVOICE

.....
:                               Create a Print Definition                               :
:                                                                                       :
:   Type choices, press Enter.                                                         :
:                                                                                       :
:   Print Definition . . .  INVOICE  Name                                             :
:   Library . . . . . QAPU      Name, *CURLIB                                         :
:   Multiple page Formats . *YES      *YES, *NO                                       :
:   Text . . . . . Super Sun Seeds Invoicing                                         :
:                                                                                       :
:   F12=Cancel                                                                                                                 :
:                                                                                       :
F3=Ex :.....

```

Figure 58. Create a Print Definition Panel

3. From the **Work with Print Definitions** panel, create a print definition that is called INVOICE. Define INVOICE as a print definition with multiple page formats, as shown in Figure 58.

### Developing Your Print Definition

1. When you have created the INVOICE print definition, select option **10** (Define) on the **Work with Print Definitions** panel to further define your print definition, as shown in Figure 59 on page 57.

```

Work with Print Definitions
Library . . . . . QAPU          Name, *CURLIB
Type options, press Enter.
 1=Create  2=Change  3=Copy  4=Delete  5=Display contents
 6=Print contents  7=Rename 10=Define 12=Work with

Opt  Name      Text
    APU1      APU Screen demo
10  INVOICE    Super Sun Seeds Invoice
                                           Bottom

F3=Exit  F5=Refresh  F12=Cancel

```

Figure 59. Work with Multiple Page Formats panel

2. The **Define a Print Definition** panel displays:

```

Define a Print Definition
Print Definition . . INVOICE
Library . . . . . QAPU
Type options, press Enter.
 1=Select
Opt  Function
 1  Select a sample spooled file
 1  Set print definition attributes
 1  Define selection fields for page formats
    Define selection rules for page formats

F3=Exit  F12=Cancel

```

Figure 60. Further Define your Print Definition panel

3. From this panel, indicate that you will select a sample spooled file. You can also define the print attributes at the print definition level.
4. First, select a sample spooled file. In this example, select the output (SCS format) called INVSCS, as shown in Figure 61 on page 58:

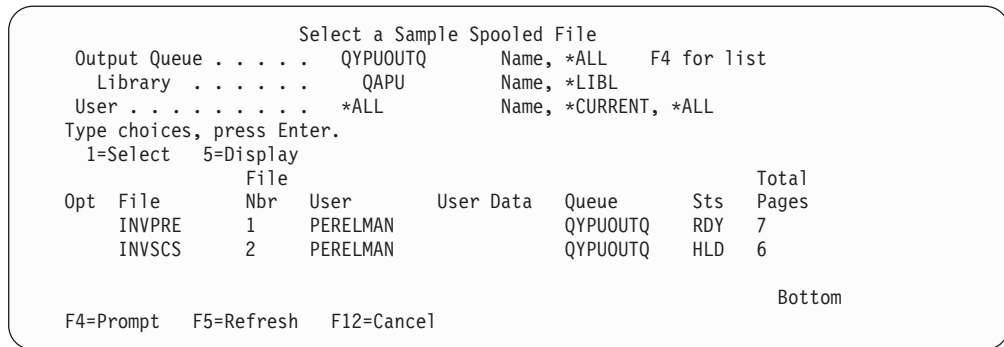

Figure 61. Select a Sample Spooled File panel

- Because the **Set print definition attributes** option was also selected on the **Define a Print Definition** panel, you are prompted for such attributes as page characteristics, default font family, and resource libraries, as shown in Figure 62:

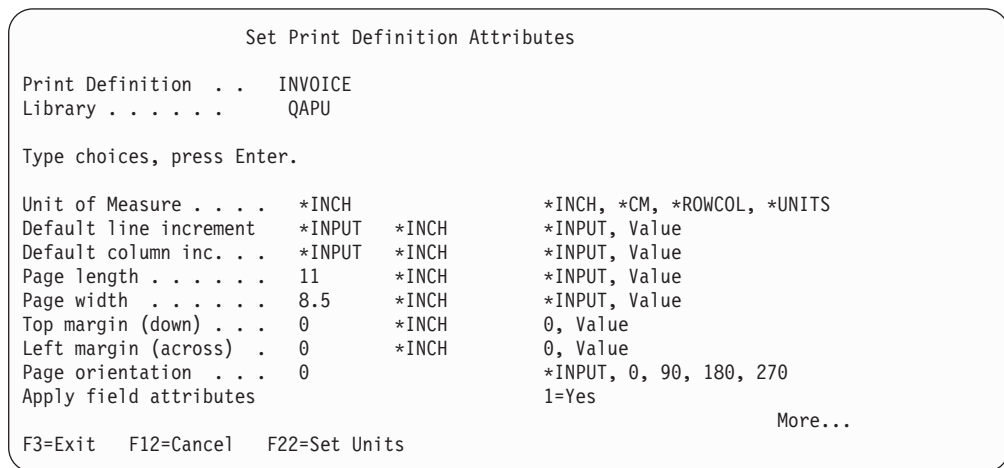

Figure 62. Set Print Definition Attributes (Screen 1) panel

**Note:** When you specify \*INPUT for the **Page orientation** field, by default APU always attempts to create the output in Portrait mode. APU attempts to perform rotation according to the values specified for the **Page length** and **Page width** fields.

- Specify **\*inch** for unit of measure. If you use a grid overlay with the input spooled file (an overlay that delineates row and columns), you can choose **\*ROWCOL** for unit of measure and just specify a row and column position when placing document elements. This does not provide the same level of precision as the other units, but for most applications it will be much easier.
- Page Down to Panel 2 and change the font:

```

Set Print Definition Attributes
Print Definition . . . : INVOICE
Library . . . . . : QAPU
Type choices, press Enter.
Default font family . . COURIER LATIN1      *APUDFT, Value   F4 for List
Point size . . . . . 12                    *CALC, Value
Bold . . . . .                               1=Yes
Italic . . . . .                               1=Yes
Default Color . . . . . *APUDFT            *APUDFT, Value   F4 for List
Addl. resource libs. .
                                     Name
                                     Name
                                     Name
                                     Name

Bottom

F3=Exit  F4=Prompt  F12=Cancel

```

Figure 63. Set Print Definition Attributes (panel 2) panel

## Defining Selection Fields

This is the continuation panel for setting the print definition attributes. After you have completed this panel, the **Define Selection Fields** panel appears. On this panel, you can view the sample spooled file (INVSCS) and define selection fields, as shown in Figure 64.

```

Define Selection Fields
Spooled file . . . . . : INVSCS           Page/Line . . . . . : 2/48
Control . . . . .      -1                Columns . . . . .   : 1 - 78
*...+...1...+...2...+...3...+...4...+...5...+...6...+...7...+...
      2 PK 11005018 EARLY BANTAM SEEDS           .38           .76
                                           Continued

Page 1
More...

F3=Exit      F11=Hide fields  F12=Cancel
F14=Start field  F15=End field
F20=Right

```

Figure 64. Define Selection Fields panel

The sample spooled file, INVSCS, displays.

1. Locate the page number field at the bottom of the first invoice for Organic Garden Supplies, and use F14 to mark the beginning of the field (two spaces before the “1”) and F15 to mark the end of the field (under the “1”). A pop-up panel shows the selected field, and gives it a default name (**F.063.073**). Note that the default name is based on the row and column location of the field, as shown in Figure 65 on page 60.

```

Define Selection Fields
Spooled file . . . . . : INVSCS          Page/Line . . . . . : 2/49
Control . . . . .      :                 Columns . . . . . : 1 - 78
*...+...1...+...2...+...3...+...4...+...5...+...6...+...7...+...

:.....:
:          Define Selection Field          :
: Type choices, press Enter.              :
: Starting Row / Column :   63 / 73      :
: Length . . . . .      :   3          Value :
: Name . . . . .        :   PAGEN       Name  :
: F12=Cancel           :               :
:.....:
:                                          Page 1
:                                          More...

F3=Exit          F11=Hide fields   F12=Cancel
F14=Start field  F15=End field     F20=Right
Mark end of field, press F15 or press F12 to cancel

```

Figure 65. Define Selection Field panel

2. Change the default field name to something more recognizable, such as **PAGEN**. Note that the page number field has changed to **000**, indicating that it is a defined field, as shown in Figure 66.

```

Define Selection Fields
Spooled file . . . . . : INVSCS          Page/Line . . . . . : 2/48
Control . . . . .      : +1          Columns . . . . . : 1 - 78
*...+...1...+...2...+...3...+...4...+...5...+...6...+...7...+...
      2 PK  11005018  EARLY BANTAM SEEDS          .38          .76
                                          Continued

:                                          Page 000
:                                          More...

F3=Exit          F11=Hide fields   F12=Cancel
F14=Start field  F15=End field     F20=Right

```

Figure 66. Define Selection Fields panel

3. Press F3 to exit.
4. Keep pressing Enter until the **Work with Print Definition** panel displays.

## Working with Copies

Inside page formats are copies.

**Note:** Refer to “Copies and Page Formats” on page 112 for some helpful hints on working with copies and page formats.

1. Select option **12 (Work with)** on the **Work with Page Formats** panel. The **Work with Copies** panel appears. You are now ready to work with the first copy of the PAGE1 page format, as shown in Figure 67 on page 61.



```

Work with Copies
Print Definition . . . INVOICE      Page Format . . . . . *DEFAULT
Library . . . . . QAPU

Type options, press Enter.
1=Create  2=Change  3=Copy  4=Delete  7=Rename
10=Define

Opt Name      Text
10 *ORIGINAL  Original (first copy)

F3=Exit  F5=Refresh  F12=Cancel
Bottom

```

Figure 67. Work with Copies panel

The first copy (\*ORIGINAL) of the print definition is automatically created. This first copy will be the **Customer Copy** of the Super Sun Seeds invoice.

## Defining the Page Layout

1. Select option **10** to define the page layout of this copy, as shown in Figure 68.

```

Define a Copy
Print Definition . . . : INVOICE      Page Format . . . . . : *DEFAULT
Library . . . . . : QAPU          Copy . . . . . : *ORIGINAL
Type options, press Enter.
1=Select
Opt  Function
    Select a sample spooled file
1   Set page layout options
1   Define field mapping
1   Define constants
    Define boxes
    Define page segments
1   Define overlays

F3=Exit  F12=Cancel

```

Figure 68. Define a Copy panel

The **Define a Copy** panel shows the composition elements that you can define for this copy.

2. Select the following items:
  - Set page layout options
  - Define field mapping
  - Define constants
  - Define overlays
3. Press Enter. The **Set Page Layout Options** panel appears, as shown in Figure 69 on page 62.

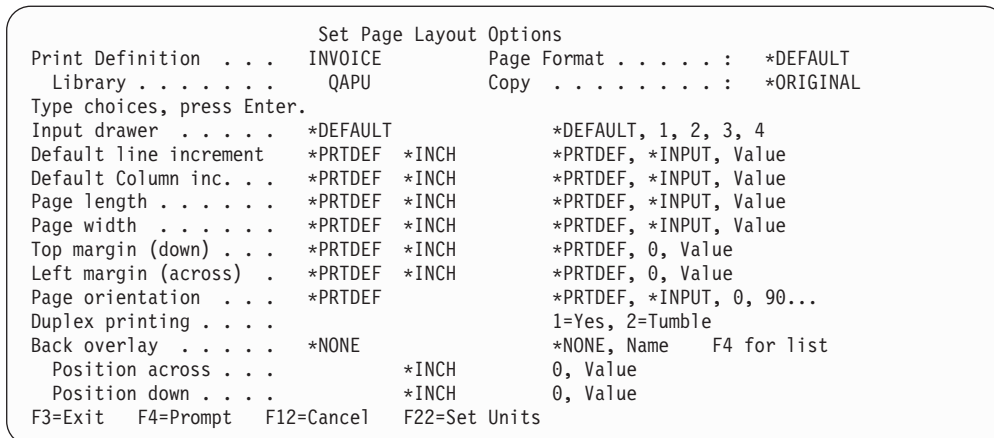

Figure 69. Set Page Layout Options panel

**Note:** When you specify \*INPUT for the **Page orientation** field, by default APU always attempts to create the output in Portrait mode. APU attempts to perform rotation according to the values specified for the **Page length** and **Page width** fields.

Many of these values default to \*PRTDEF, which points to values that are set for this print definition. However, these values can also be different, which means that an individual copy can have different orientation, margins, selections, and other characteristics.

You need to be aware of the capabilities and limitations of duplex printing:

#### What Duplex Printing Does

1. Type **1** in the duplex printing field, if you want simple duplex printing. The result is that all second pages of the copy are printed on the back side of the page. If you want tumble duplex, enter **2**.

#### Restrictions

2. Duplex printing can be done only for consecutive pages of the same copy. **If more than one “copy” is required for a page format, duplex printing cannot be done because one copy never has two consecutive pages.**
3. If duplex printing is enabled (=1), then the **Back Overlay** field must be given a value of \*NONE, because you cannot print both an overlay and print text on the back side.

**Note:** Refer to “Duplex” on page 113 for some helpful hints on using duplex printing.

## Specifying the Back Overlay

**Note:** If you are going to use duplexing, you cannot have a back overlay. Specify the Terms and Conditions overlay (INVBAC) as the back overlay. That overlay is shown below:

## Terms and Conditions

*The sale of the products described herein shall be governed by the terms and conditions contained in any written contract currently in effect between Buyer and Seller covering such sale. If there is no such contract, then Seller hereby offers to sell such products to Buyer only upon the terms set forth herein.*

1. *Seller's standard prices in effect at the time of shipment will govern the sale of the products described herein. Terms of payment on any approved order are net thirty (30) days from the date of invoice unless otherwise specifically stated. All shipments, unless specifically provided, shall be to the place of manufacture or warehouse location indicated herein. The price includes cost of packaging for domestic shipment, unless otherwise stated. An additional charge will be made for special domestic or export packing if this involves greater expense. Shipments will be insured at the expense of the Buyer unless Buyer specifically requests that shipments not be insured.*
2. *Seller reserves the right, among other remedies, to terminate this contract or suspend further deliveries under it in the event Buyer fails to pay for any shipment when same becomes due. Should Buyer's financial responsibility become unsatisfactory to Seller, cash payments or satisfactory security may be required by Seller for future deliveries and for goods theretofore delivered.*
3. *In addition to the purchase price, Buyer shall pay the Seller the amount of all taxes, excises or other charges (except taxes on or measured by net income) that Seller may be required to pay to any Government (national, state or local) with respect to the production, sale or transportation of any product delivered hereunder, except where the law otherwise provides. Sixty (60) days written notification must be given to make any changes to delivery schedule.*
4. *Seller warrants that products delivered hereunder will conform to the description on the face of this document and meet any specifications set forth or incorporated by reference herein and will be adequately contained, packaged and labeled and conform to any promises and affirmations of fact made on the container and label. Seller further warrants any such product against defects in workmanship or materials which develop or become evident within 12 (9 months CEI) after shipment of the product by Seller provided Seller's responsibility under this warranty shall be limited to the repair or Seller's election of the replacement of the defective product or component thereof and that said warranty is subject to the following exceptions and conditions:
  - (a) *All items claimed to be defective must be returned to Seller, transportation charges prepaid and will be returned to Buyer transportation charges collect unless found to be defective in which case Seller will pay all transportation charges.*
  - (b) *Seller's warranty will not apply to items which have been modified or repaired without Seller's written consent by persons other than Seller's authorized service personnel.**
5. *It should be noted that Seller has used the powerful tools of AS400 Advanced Function Printing to create Seller's invoice, and despite the above terms and conditions which are presently being read, the invoice is a very effective business document. Any attempt to mar the appearance of this invoice should be discouraged.*
6. *The validity, interpretation and performance of the terms hereof with respect to any product delivered (or to be delivered) hereunder shall be governed by the law of the State of Colorado. . .*
7. *No modification or waiver of the terms here of shall be binding upon Seller unless approved in writing by one of Seller's Officers or Marketing Managers or shall be affected by acknowledgment or acceptance of purchase order forms containing other or different terms whether or not signed by authorized representative of Seller. (a) Seller does not warrant items which have been damaged due to negligence or misuse.*
8. *THERE ARE NO EXPRESS WARRANTIES BY SELLER OTHER THAN THOSE SPECIFIED IN THIS PARAGRAPH. NO WARRANTIES BY SELLER (OTHER THAN WARRANTY OF TITLE AS PROVIDED IN THE UNIFORM COMMERCIAL CODE) SHALL BE IMPLIED OR OTHERWISE CREATED UNDER THE UNIFORM COMMERCIAL CODE, INCLUDING BUT NOT LIMITED TO WARRANTY OF MERCHANTABILITY IN OTHER RESPECTS THAN SPECIFIED IN THIS PARAGRAPH AND WARRANTY OF FITNESS FOR A PARTICULAR PURPOSE. Without limiting the generality of the foregoing, Buyer assumes all risk and liability for the results obtained by the use of any products delivered hereunder in combination with other articles or material in the practice of any process.*
9. *NO CLAIM of any kind with respect to any product specified herein, whether as to product delivered or for nondelivery of product and whether or not based on negligence, SHALL BE GREATER IN AMOUNT than the purchase price of the product in respect of which such claim is made. In no event shall either party be liable for special indirect or consequential damages whether or not caused by or resulting from the negligence of such party.*
10. *It is expressly understood that any technical advice furnished by Seller with reference to the use of its products is given gratis and Seller assumes no obligation of liability for the advice given or results obtained, all such advice being given and accepted at Buyer's risk.*
11. *In the event Buyer fails to fulfill Seller's terms of payment for the products specified herein, or in case Seller shall have any doubt at any time as to Buyer's financial responsibility, Seller may decline to make further deliveries except upon receipt of cash or satisfactory security.*

Figure 70. Back Overlay (Terms and Conditions) - INVAC

---

## Mapping Fields

After you have specified the Terms and Conditions overlay, you will then need to define field mapping for your output.

**Note:** Refer to “Mapping Data” on page 112 for some helpful hints on mapping data.

Press F3. The **Define Field Mapping** panel, shown in Figure 71 on page 64, appears.

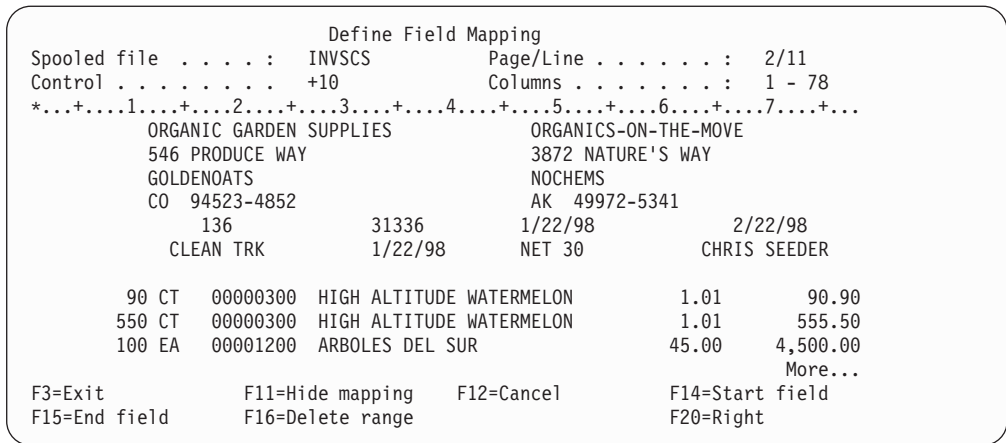

Figure 71. Define Field Mapping panel

APU displays the Super Sun Seeds invoice spooled file for data mapping. With data mapping, you can redefine how the application data is to be placed when printed. For the example we are using, we will describe the following:

- Mapping bar codes
- Defining constant data
- Defining Fonts
- Defining overlays

**Note:** If you want to map the same field to multiple locations, use the procedure that is described in “Mapping a Field at Multiple Locations” on page 49.

## Mapping Bar Codes

This section describes how to map bar codes.

1. First, the **Define Field Mapping** panel must be displayed, as shown in Figure 71.
2. To reprint the zip code in the name and address in POSTNET bar code, you first define the zip code field to APU. Use F14 to specify the beginning of the field and F15 to specify the end of the field.
3. Select what you want to do with the zip code field. In this case, map it as bar code.

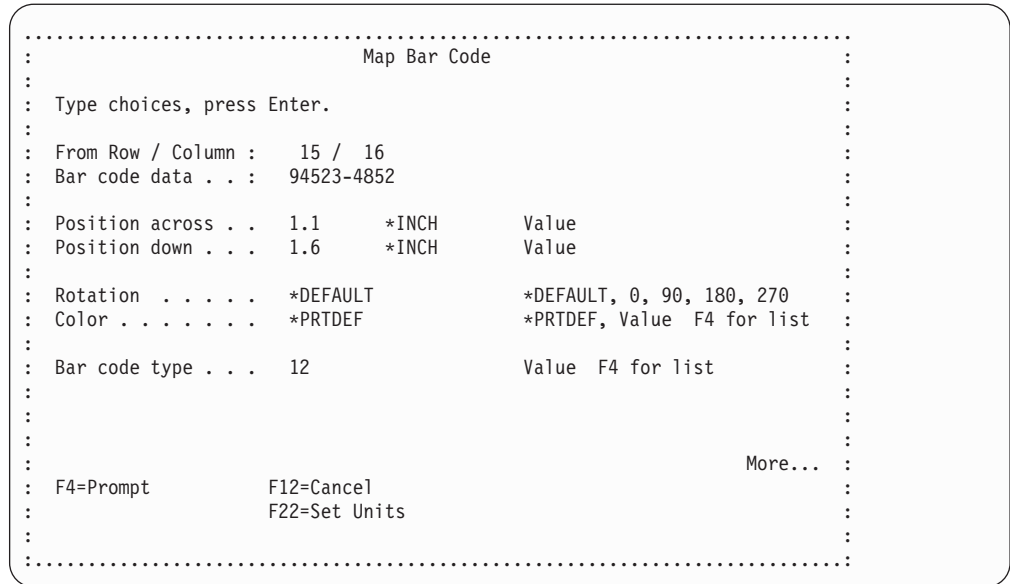

Figure 72. Map Bar Code panel

4. The **Map Bar Code** panel is a multi-panel pop-up used to select, define, and position the bar code. The zip code is at row 15, column 16, and the value is shown. Map it (make a copy of the zip code) in bar code to a position starting at 1.1 inches down and 1.6 inches across the paper. It could have also been positioned by row and column. In either case, it will appear just above the name and address. Position the cursor in the **Bar code type** field and press F4 to display a list of supported bar code types.
5. Select **12**, which is POSTNET, and Page Down to see additional optional bar code type information.

**Note:** To successfully print your POSTNET bar code mapping, you must specify the correct number of digits (5 or 9, for example) for the type of POSTNET bar code you selected.

Note that non-numeric characters, such as the dash that is contained in the ZIP + 4 code, are removed on the second panel for you.

6. Press Enter to return to the **Define Field Mapping** panel.
7. Press F3. The **Define Constants** panel appears, as shown in Figure 73 on page 66.

```

Define Constants
Print Definition . . . INVOICE      Page Format . . . . . *DEFAULT
Library . . . . . QAPU          Copy . . . . . *ORIGINAL

Type options, press Enter.
1=Create 2=Change 3=Copy 4=Delete

      Constant  Position  Position  Unit of
Opt  type      across   down      measure  Constant value
1   *TEXT

F3=Exit  F5=Refresh  F12=Cancel

```

Figure 73. Define Constants panel

## Defining Constant Data

Next, define the constant text **Customer Copy** to appear at the bottom of this copy. Specify a text type for this constant. You could also specify a constant bar code.

1. Select option **1**, enter a constant type of **\*TEXT**, then press Enter. The **Create Constant Text** panel appears, as shown in Figure 74.

```

Define Constants
.....
:                               Create Constant Text                               :
:                                                                                   :
: Type choices, press Enter.                                                       :
:                                                                                   :
: Position across . . 4.0      *INCH      Value                                   :
: Position down . . . 10.8     *INCH     Value                                   :
: Constant value . . Customer Copy                                                :
:                                                                                   :
:                                                                                   :
: Font . . . . . *PRTDEF      *PRTDEF, Value F4 for list                          :
: Point size . . . *CALC, Value                                                  :
: Bold . . . . . 1=Yes                                                    :
: Italic . . . . . 1=Yes                                                    :
: Rotation . . . . . *DEFAULT      *DEFAULT, 0, 90, 180, 270                       :
: Color . . . . . *PRTDEF      *PRTDEF, Value F4 for list                       :
:                                                                                   :
: F4=Prompt  F12=Cancel  F22=Set Units                                           :
:                                                                                   :
:                                                                                   :
:.....

```

Figure 74. Create Constant Text panel

2. Specify the text **Customer Copy** and position it 10.8 inches down and 4 inches across the paper.

## Selecting Fonts

1. Position the cursor in the **Font** field, and press F4. The font database appears.

### Outline Fonts

APU supplies Outline fonts in addition to other standard IBM fonts. Refer to “Outline Fonts” on page 20.

- For this example, select a Helvetica, 10-point, bold font as shown in Figure 75.

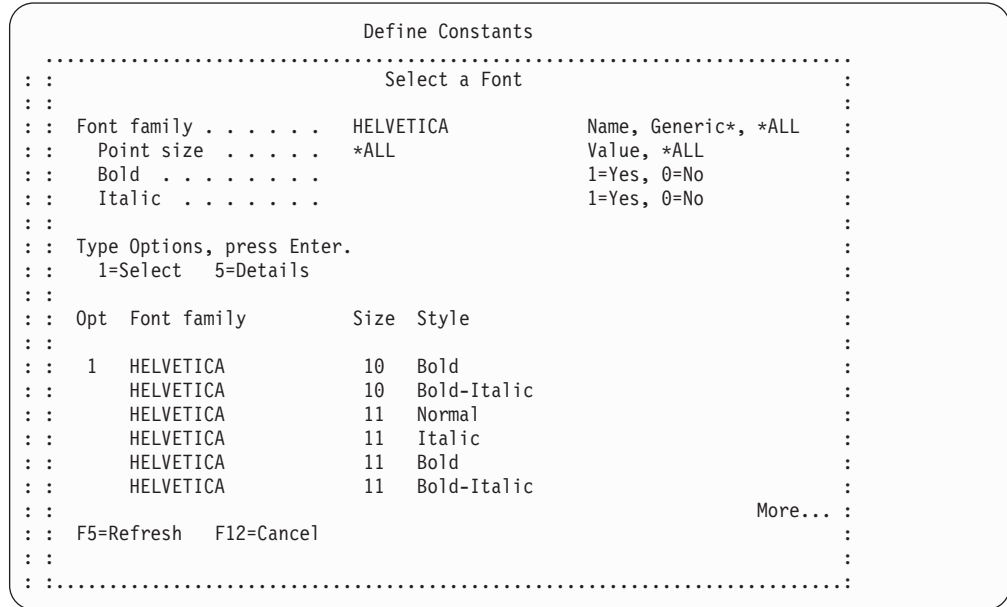

Figure 75. Select a Font panel

The **Select a Font** panel is a pop-up panel in which you specify a font family. You can manually type point size and type style selections, or you can select the font you want from the list of fonts in the bottom half of the display. In addition, you can use option 5 to display the details of a specific font.

- Press Enter. The **Create Constant Text** panel reappears. Press Enter. The **Define Constants** panel reappears, as shown in Figure 76.

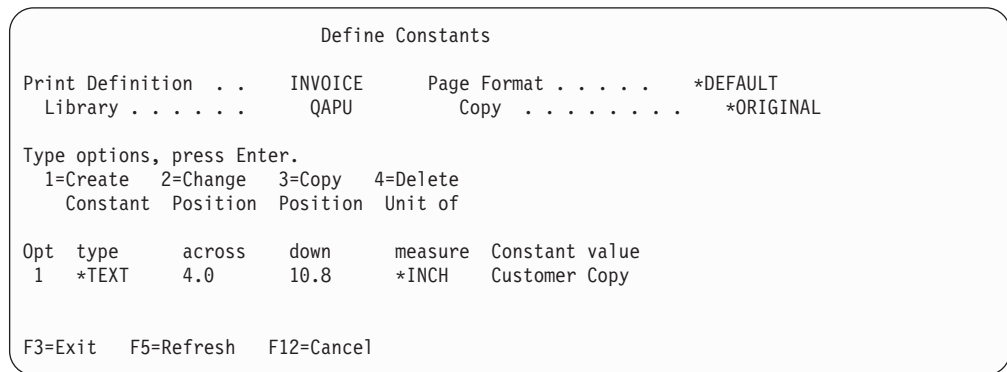

Figure 76. Define Constants panel

## Defining Overlays

1. Press F3. The **Define Overlays** panel appears, as shown in Figure 77.

```

Define Overlay Positionings
Print Definition . . . : INVOICE      Page Format . . . . . : *DEFAULT
Library . . . . . : QAPU          Copy . . . . . : *ORIGINAL
Type options, press Enter.
  1=Create  2=Change  3=Copy  4=Delete
Position  Position  Unit of
Opt across  down    measure  Overlay
1   0        0      *INCH  INVALL
      (There are no overlay positionings defined)

F3=Exit  F5=Refresh  F12=Cancel
  
```

Figure 77. Define Overlays panel

2. On the **Define Overlays** panel, select the Super Sun Seeds invoice overlay (INVALL) to be printed on this copy. A sample of the INVALL overlay is shown below:

400 CPU Parkway Vegetation, NJ 55090		 <b>Super Sun Seeds</b> A Growth Company		Office: 555-499-2367 Fax: 555-415-9794	
-- Sold To --			-- Ship To --		
Customer Number:	Invoice Number:	Invoice Date:	Payment Date:		
Ship Via:	Shipped Date:	Terms:	Salesman:		
Qty	UOM	Item #	Item Description	Price	Extension

This invoice overlay designed using IBM AFP Utilities/400

Figure 78. Sample INVALL Overlay



## Replicating the Contents of Copies

At this point, the composition of the customer copy has been defined. Press Enter until the **Work with Copies** panel appears again.

1. Select option **2** to change the text to Customer copy.
2. Select option **3** (copy) to replicate the contents of the customer copy to two additional copies: the Packing list and the File copy, as shown in Figure 79:

```

Work with Copies
Print Definition . . . : INVOICE      Page Format . . . . . : *DEFAULT
Library . . . . . : QAPU
Type options, press Enter.
  1=Create  2=Change  3=Copy  4=Delete  7=Rename
 10=Define
Opt  Name      Text
3   : .....:
   :                      Copy a Copy
   :                      :
   : Type choices, press Enter.
   : From Page Format . . . : *DEFAULT
   : From copy . . . . . : *ORIGINAL
   : To Page Format . . . . : *DEFAULT      Name
   : To copy . . . . . : FILE          Name
   : New text . . . . . : File Copy
   : F12=Cancel
   : .....:
F3=Ex
Copy

```

Figure 79. Work with Copies panel

3. Select option **10** to define these copies and change the constant text that is printed at the bottom to **Packing List** and **File Copy**, respectively.
4. To suppress the price information on the packing list copy (PACKING), select option **10** to define the packing list copy and bring up the sample spooled file with the field mapping function.
5. Use F14 and F15 to mark the first field in a column to be suppressed. In this example, the price field and extension field are suppressed from printing, as shown in Figure 80 on page 70.

```

Define Field Mapping
Spooled file . . . . : INVSCS Page/Line . . . . . : 2/17
Control . . . . . Columns . . . . . : 1 - 78
*...+...1...+...2...+...3...+...4...+...5...+...6...+...7...+...
      136          31336      1/22/98          2/22/98
      CLEAN TRK      1/22/98      NET 30          CHRIS SEEDER

      90 CT 00000300 HIGH ALTITUDE WATERMELON 44444444444444444444444444444444
      550 CT 00000300 HIGH ALTITUDE WATERMELON 1.01 555.50
      100 EA 00001200 ARBOLES DEL SUR 45.00 4,500.00
      25 EA 00231300 SEED ROASTER OVEN SET 199.99 4,999.75
      150 PK 04569870 NORTHERN LITE BLUE SPRUCE 858.32 28,748.00
      2 BX 11005000 FAVA SEEDS 3.90 7.80
      2 BX 11005001 PURPLE TEEPEE SEEDS 4.44 8.88
      52 BX 11005002 BUSH WAX SEEDS 2.00 104.00
      52 BX 11005003 KINGHORN WAX SEEDS 2.13 110.76
                                          More...
F3=Exit F11=Hide mapping F12=Cancel F14=Start field
F15=End field F16=Delete range F20=Right
Suppression at 24/58 created

```

Figure 80. Suppression panel

6. Press Enter.
7. Select the function to repeat the suppression. In this case, because an invoice can contain up to 31 line items on a page, repeat the suppression 30 times for the price field, as shown in Figure 81.

```

Define Field Mapping
Spooled file . . . . : INVSCS Page/Line . . . . . : 2/17
Control . . . . . Columns . . . . . : 1 - 78
*...+...1...+...2...+...3...+...4...+...5...+...6...+...7...+...
      136 .....
      CLEAN : Repeat Suppression :
      : From row / column . . : 24 / 58 :
      : Length . . . . . : 21 :
      90 CT 00 : :
      550 CT 00 : :
      100 EA 00 : Type choices for repetitions, press Enter. :
      25 EA 00 : :
      150 PK 04 : Starting row . . . . . 25 Value :
      2 BX 11 : Number of repetitions . 30 Value :
      2 BX 11 : :
      52 BX 11 : :
      52 BX 11 : :
F3=Exit : F12=Cancel :
F15=End field : .....
Suppression at 24/5

```

Figure 81. Repeating a Suppression panel

8. Repeat these steps to suppress the extension field. The packing list copy is shown below:

400 CPU Parkway Vegetation, NJ 55090		 <b>Super Sun Seeds</b> A Growth Company	Office: 555-499-2367 Fax: 555-415-0794		
ORGANIC GARDEN SUPPLIES 546 PRODUCE WAY GOLDENOATS CO 94523-4852		ORGANICS-ON-THE-MOVE 3872 NATURE'S WAY NOCHEMS AK 49972-5341			
-- Sold To --		-- Ship To --			
Customer Number: 136	Invoice Number: 31336	Invoice Date: 4/09/96	Payment Date: 5/09/96		
Ship Via: CLEAN TRK		Shipped Date: 4/09/96	Terms: NET 30		
Salesman: CHRIS SEEDER					
Qty	UOR	Item #	Item Description	Price	Extension
90	CT	00000300	HIGH ALTITUDE WATERMELON		
550	CT	00000300	HIGH ALTITUDE WATERMELON		
100	EA	00001200	ARBOLES DEL SUR		
25	EA	00231300	SEED ROASTER OVEN SET		
150	FK	04569870	NORTHERN LITE BLUE SPRUCE		
2	EX	11005000	FAVA SEEDS		
2	EX	11005001	PURPLE TEEPEE SEEDS		
52	EX	11005002	BUSH WAX SEEDS		
52	EX	11005003	KINGHORN WAX SEEDS		
8	EX	11005004	BUSH GREEN SEEDS		
8	EX	11005005	BLUE LAKE GREEN SEEDS		
2	EX	11005006	KINGHORN WAX SEEDS		
2	CT	11005007	VENTURE GREEN SEEDS		
100	CT	11005008	NORTHEASTERN POLE SEEDS		
100	CT	11005009	KENTUCKY BLUE SEEDS		
58	CT	11005010	EARLY DWARF DANISH SEEDS		
58	CT	11005011	LASSO RED SEEDS		
84	EA	11005012	BLUE MAX SAVOY BEANS		
84	DZ	11005013	MINCOR NANTES CARROT SEED		
10	DZ	11005014	SCARLET NANTES SEEDS		
5	DZ	11005014	SCARLET NANTES SEEDS		
10	EZ	11005015	CHANTENAY SEEDS		
63	EZ	11005016	TOUCHON SEEDS		
65	EZ	11005016	TOUCHON SEEDS		
2	FK	11005018	EARLY BANTAM SEEDS		
2	FK	11005019	NORTHERN PICKLING SEEDS		
90	FK	11005020	FRENCH PICKLING SEEDS		
100	EX	11057893	AFRICAN DAISY, SEEDS		
25	CT	12382910	SUCCATASH SEEDS		
45	CT	13145340	SOUR GRAPE SEEDS		
10	FT	15789342	BLUE BELLES, BRIGHT BLUE		
50	FK	15975365	HEAVY OAK		
25	EA	31321654	BELLSTAR SEEDS		
2	EA	31321654	BELLSTAR SEEDS		
					Continued

**Packing List**

This invoice overlay designed using IBM AFP Utilities/400

Page 1

*Figure 82. Sample Packing List Showing Suppression*

## Continuation Page Copies

At this point, you have defined all the copies within the first page format (PAGE1).

1. Now, return to the **Work with Page Formats** panel.
2. Rename \*DEFAULT to PAGE1.
3. Change text to PAGE1 format.
4. From this panel, select option **3** to make a copy of the PAGE1 page format, copies and all.
5. Select option **2** to change the text to Page 1 format.
6. Specify that the new page format will be called PAGEN, as shown in Figure 83 on page 72.

```

Work with Page Formats

Print Definition . . . : INVOICE
Library . . . . . : QAPU

Type options, press Enter.
1=Create 2=Change 3=Copy 4=Delete 7=Rename
12=Work with

Opt Name Text
3 .....:
: Copy a Page Format :
: : :
: Type choices, press Enter. :
: : :
: From Print Definition : INVOICE :
: From Page Format . . : PAGE1 :
: To Page Format . . . . PAGEN Name :
: New text . . . . . Page N Format :
: : :
: F12=Cancel :
F3=Ex :
Page :.....:

```

Figure 83. Work with Page Formats panel

7. Press Enter to return to the **Work with Page Formats** panel, as shown in Figure 84.

```

Work with Page Formats

Print Definition . . . : INVOICE
Library . . . . . : QAPU

Type options, press Enter.
1=Create 2=Change 3=Copy 4=Delete 7=Rename
12=Work with

Opt Name Text
12 PAGEN Page N Format
PAGE1 Page 1 Format

Bottom

F3=Exit F5=Refresh F12=Cancel
Copied Page Format PAGE1 to PAGEN

```

Figure 84. Work with Page Formats panel

8. Select option **12** to work with the **PAGEN** page format. The **Work with Copies** panel appears, as shown in Figure 85 on page 73.

```

Work with Copies
Print Definition . . . : INVOICE      Page Format . . . . . : PAGE1
Library . . . . . : QAPU
Type options, press Enter.
 1=Create  2=Change  3=Copy  4=Delete  7=Rename
10=Define
Opt  Name      Text
   *ORIGINAL  Customer Copy
   FILE       File Copy
   PACKING    Packing List

F3=Exit  F5=Refresh  F12=Cancel

Bottom

```

Figure 85. Create with Copies panel

9. The page format copy function has created the same three copies under the **PAGEN** page format. At this point, open these copies and make any changes to the page layout for the **PAGEN** pages. The principal difference between the copies is in the use of the different overlays.
10. Press Enter until the **Work with Print Definitions** panel appears.
11. Select option **10 Define a Print Definition** panel appears.
12. Select option **1 Define Selection Rules for Page Formats** panel appears.

```

Define a Print Definition
Print Definition . . . : INVOICE
Library . . . . . : QAPU
Type options, press Enter.
 1=Select
Opt  Function
     Select a sample spooled file
     Set print definition attributes
     Define selection fields for page formats
 1   Define selection rules for page formats

F3=Exit  F12=Cancel

```

Figure 86. Define Selection Rules panel

13. Using the **Define a Rule** panel, type the logic for identifying Page 1. If the value of **PAGEN** is **1**, then **APU** will select page format **PAGE1**, as shown in Figure 87 on page 74.

```

.....
:                                     Define a Rule                               :
:                                                                              :
: Type choices, press Enter.                                                :
:                                                                              :
: Rule number . . . . . : 10                                                :
:                                                                              :
: Condition 1 . . . . . IF                                                IF, blank :
: Field . . . . . PAGEN                                                Name     F4 for list :
: Test . . . . . *EQ                                                    *EQ, *NE, *GT...   :
: Field or 'Characters' . ' 1'                                         Value    F4 for list :
: Action . . . . . *USE                                                  *USE, *OMIT, *GOTO :
: Page format or rule . . PAGE1                                         Value    F4 for list :
:                                                                              :
: Condition 2 . . . . . AND, OR                                          :
: Field . . . . . Name     F4 for list :
: Test . . . . . *EQ, *NE, *GT...   :
: Field or 'Characters' . Value    F4 for list :
: Action . . . . . *USE, *OMIT, *GOTO :
: Page format or rule . . Value    F4 for list :
:                                                                              :
:                                                                              More... :
: F4=Prompt  F12=Cancel                                                :
:                                                                              :
:                                                                              :
.....

```

Figure 87. Define a Rule panel

**Note:** You do not have to type the logic for identifying pages greater than page one.

14. If the value of PAGEN is not 1, then APU will select page format PAGEN, as shown in Figure 88.

```

.....
:                                     Define a Rule                               :
:                                                                              :
: Type choices, press Enter.                                                :
:                                                                              :
: Rule number . . . . . : 20                                                :
:                                                                              :
: Condition 1 . . . . . IF                                                IF, blank :
: Field . . . . . PAGEN                                                Name     F4 for list :
: Test . . . . . *EQ                                                    *EQ, *NE, *GT...   :
: Field or 'Characters' . Value    F4 for list :
: Action . . . . . *USE                                                  *USE, *OMIT, *GOTO :
: Page format or rule . . PAGE1                                         Value    F4 for list :
:                                                                              :
: Condition 2 . . . . . AND, OR                                          :
: Field . . . . . Name     F4 for list :
: Test . . . . . *EQ, *NE, *GT...   :
: Field or 'Characters' . Value    F4 for list :
: Action . . . . . *USE, *OMIT, *GOTO :
: Page format or rule . . Value    F4 for list :
:                                                                              :
:                                                                              More... :
: F4=Prompt  F12=Cancel                                                :
:                                                                              :
:                                                                              :
.....

```

Figure 88. Define a Rule panel

15. After you have defined rules for PAGE1 and PAGEN, press Enter. The **Define Selection Rules** panel appears. On this panel, APU summarizes the current selection rules for the INVOICE print definition, as shown in Figure 89 on page 75.

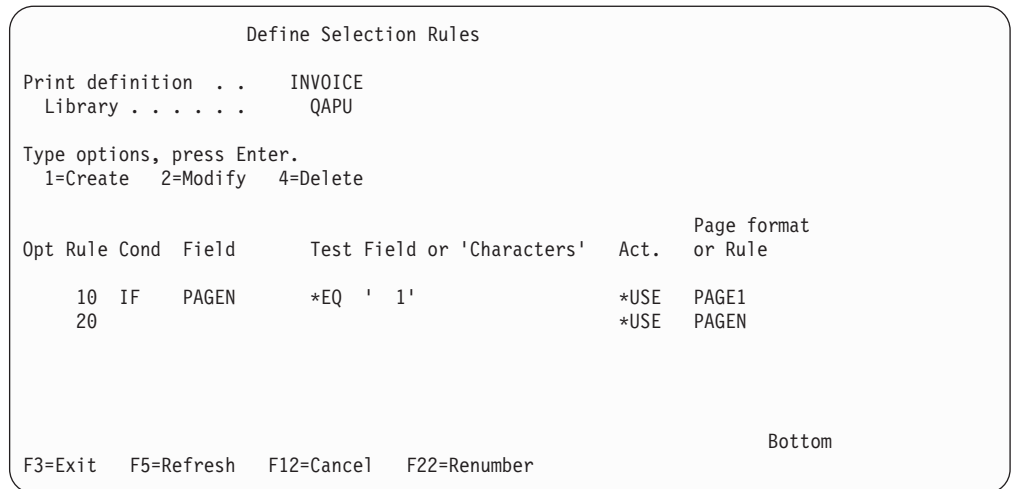

*Figure 89. Define Selection Rules panel*

16. After you have completed the selection rules, press F3 to return to the **Work with Print Definitions** panel.





---

## Part 3. Printing With APU

<b>Chapter 5. Manual and Command Line Printing with APU</b> . . . . .	79
Methods of Printing with APU . . . . .	79
Manually Associating a Print Definition with a Spooled File . . . . .	79
Panel 1: Apply Print Definition . . . . .	80
Panel 2: Apply Print Definition . . . . .	81
Panel 3: Apply Print Definition . . . . .	82
Using the Apply Print Definition Command . . . . .	82
<b>Chapter 6. Automatic Printing with APU Monitor</b>	83
Introduction to the APU Monitor . . . . .	83
Understanding How the APU Monitor Works . . . . .	83
An Example of APU Monitor Processing . . . . .	84
A Customer Environment. . . . .	84
Implementing the Customer Requirements on the APU Monitor. . . . .	85
Condition of the Output Queue after Processing	86
Configuring APU Monitor . . . . .	87
Specifying the Queues APU is to Monitor . . . . .	88
Configuring APU Monitor Action . . . . .	89
Initial Panel . . . . .	89
Creating an Action Group Entry . . . . .	89
Defining Selection for Input Spooled File . . . . .	90
Defining Action for Input Spooled File . . . . .	91
Defining Action for Output Spooled File. . . . .	92
An Example of this Processing Step . . . . .	92
Defining User Exit Before and Middle . . . . .	94
Defining User Exit After . . . . .	96
Starting APU Monitor . . . . .	97
Stopping APU Monitor . . . . .	98



---

## Chapter 5. Manual and Command Line Printing with APU

This chapter describes the methods of printing your print definition, and describes two of these three standard methods in detail:

- “Methods of Printing with APU”
- “Manually Associating a Print Definition with a Spooled File”
- “Using the Apply Print Definition Command” on page 82

---

### Methods of Printing with APU

You can use any of three methods to print with APU:

1. Manually associating a print definition with a specific spooled file. For manual printing, you just “apply” your print definition to a specific spooled file. Refer to “Manually Associating a Print Definition with a Spooled File”.
2. Using the Apply Print Definition command, which enables you to imbed an APU printing step within existing application procedures. Refer to “Using the Apply Print Definition Command” on page 82.
3. Using the APU Monitor to automatically identify the sample spooled file and run the conversion programs. This method is described in Chapter 6, “Automatic Printing with APU Monitor” on page 83.

---

### Manually Associating a Print Definition with a Spooled File

This process works as follows. Using your print definition, SUNSD1 or INVOICE, select option 2 from the APU Main Menu. The **Work with Spooled Files** panel appears.

```
                                Select a Sample Spooled File
Output Queue . . . . . QYPUOUTQ      Name, *ALL   F4 for list
Library . . . . . QAPU              Name, *LIBL
User . . . . . *ALL                 Name, *CURRENT, *ALL
Type choices, press Enter.
  1=Select  5=Display
Opt  File      Nbr  User      User Data  Queue      Sts  Total
      INVPRE   1   PERELMAN  QYPUOUTQ  RDY   7
      INVSCS   2   PERELMAN  QYPUOUTQ  HLD   6
                                           Bottom
F4=Prompt  F5=Refresh  F12=Cancel
```

Figure 90. Select Spooled File

You can display selected output queues and spooled files with this option, and then apply a print definition to the spooled file for example, INVSCS.

## Panel 1: Apply Print Definition

```

Apply Print Definition (APYPRDEF)
Type choices, press Enter.
SCS Spooled File . . . . . > INVSCS      Name
Job name . . . . . > QPADEV0016      Name, *
User . . . . . > JOHN                Name
Number . . . . . > 098677            000000-999999
SCS Spooled file number . . . . . > 10      1-9999, *ONLY, *LAST
Print Definition . . . . . > INVOICE     Name, *NONE, *SPOOLFILE
Library name . . . . . > QAPU          Name, *PRTDEFLIB, *LIBL
Run option . . . . . *NORMAL          *NORMAL, *NOCOPY, *REPRINT
Post processing SUCCESS:
SCS Spooled File . . . . . > *NONE      *HOLD, *NONE, *DELETE, *OUTQ
Output queue . . . . .                Name
Library name . . . . .                Name, *LIBL
Post processing FAILURE:
SCS Spooled File . . . . . > *NONE      *HOLD, *NONE, *DELETE, *OUTQ
Output queue . . . . .                Name
Library name . . . . .                Name, *LIBL
More...
F3=Exit  F4=Prompt  F5=Refresh  F12=Cancel  F13=How to use this display
F24=More keys

```

Figure 91. Apply Print Definition panel

APU will move the input spooled file to the output queue defined in the Success or Failure fields, depending on the result, and will place the file in one of the four status conditions shown above. \*HOLD is the default for both success and failure.

Some of the fields you should fill out include:

### Input Spooled File

Name of the input spooled (SCS) file to which a print definition is to be applied.

### Print Definition

Name of the print definition to be applied to the spooled file.

### Success or Failure

Specify what you want to happen to the input spooled file on success or failure.

Press the “Page Down” key to access the next panel.

**Note:** INVSCS can also be used with the SUPER and SUPER2 print definition samples that are in the QAPU library. INVPRE can be used with the AMASTER print definition, that is also in the QAPU library.

## Panel 2: Apply Print Definition

Make the entries you want. Press **F1** for descriptions of the fields. Here is a

```
Apply Print Definition (APYPRTDEF)
Type choices, press Enter.
User exit BEFORE:
  Program . . . . . *NONE      Name, *NONE
  Library Name . . . . .      Name, *LIBL
  User parameter . . . . .
User exit MIDDLE:
  Program . . . . . *NONE      Name, *NONE
  Library Name . . . . .      Name, *LIBL
  User parameter . . . . .
Device Name . . . . . *JOB      Name, *JOB
Output queue . . . . . *SPOOLFILE Name, *DEV, *SPOOLFILE
  Library Name . . . . .      Name, *LIBL
Spooled file name . . . . . *SPOOLFILE Name, *SPOOLFILE, *PRTDEF
User data . . . . . *SPOOLFILE Character value...
Form type . . . . . *SPOOLFILE Character value...
Hold spooled file . . . . . *NO      *NO, *YES
Save spooled file . . . . . *NO      *NO, *YES, *SPOOLFILE
                                          More...
F3=Exit  F4=Prompt  F5=Refresh  F12=Cancel  F13=How to use this display
F24=More keys
```

Figure 92. Apply Print Definition panel

description of some of the key fields:

### User exit BEFORE

Initializes the name of a program you want run before processing. Refer to “User Exit Before” on page 103.

### User exit MIDDLE

Name of a program you want to be run **after** the input spooled file has been copied to the input spool database. Refer to “User Exit Middle” on page 104.

### Device name

Name of the printer on which the output is to be printed.

### Output Queue

Name of the queue for the output file.

### Spooled file name

Name to be given to the output.

### User data

A user-defined parameter in the form of a character string to be placed on the output.

### Hold or Save

Specify what you want done with the spooled file after it is processed.

## Panel 3: Apply Print Definition

Make the entries you want. Press **F1** for descriptions of the fields. Key field entries

```
Apply Print Definition (APYPRDEF)
Type choices, press Enter.
Output bin . . . . . *SPOOLFILE  1-65536, *SPOOLFILE, *DEV
User exit AFTER:
  Program . . . . . *NONE          Name, *NONE
  Library Name . . . . .          Name, *LIBL
  User parameter . . . . .
                                                    Bottom
F3=Exit  F4=Prompt  F5=Refresh  F12=Cancel  F13=How to use this display
F24=More keys
```

Figure 93. Apply Print Definition panel

here are:

### Output bin

Where the output is to be placed.

### User exit AFTER

Name of a program you want to be run **after** the AFPDS output spooled file has been created. Refer to “User Exit After” on page 105.

---

## Using the Apply Print Definition Command

One method of starting APU is to use the Apply Print Definition (APYPRDEF) command. This is the same command that is called when you manually apply a print definition to a spooled file, working from the “Work with Spooled Files” option that is described in “Manually Associating a Print Definition with a Spooled File” on page 79.

**Note:** Refer to “APYPRDEF Command” on page 111 for some helpful hints on using the APYPRDEF command.

To use the apply print definition command, place the command within existing application procedures, such as a CL (Control Language) program. An example of the command is shown below:

```
APYPRDEF FILE(INVSCS) JOB(098677/JOHN/QPADEV0016) SPLNBR(10)+
PRTDEF(QAPU/INVOICE) SUCCESS(*NONE) FAILURE(*NONE) DEV(PRT3130)
```

This command selects the INVSCS spooled file from the currently running job (either batch or interactive) and starts APU printing, using the INVOICE print definition. The new AFP output is sent to the output queue that is associated with the PRT3130 printer device.

**Note:** The APYPRDEF command can also be used to run in batch.

---

## Chapter 6. Automatic Printing with APU Monitor

This chapter describes the third method of printing APU print definitions. (The other two methods are described in Chapter 5, “Manual and Command Line Printing with APU” on page 79.)

To give you an understanding of the operation of the APU Monitor, the following topics are described here:

- “Introduction to the APU Monitor”
- “Understanding How the APU Monitor Works”
- “An Example of APU Monitor Processing” on page 84
- “Configuring APU Monitor” on page 87

---

### Introduction to the APU Monitor

The APU monitor is part of APU and provides a good way to integrate APU print definitions into your environment. The first version of the monitor was limited in its capabilities. With the modification level, new functionality has been added to the APU Monitor.

The new monitor provides a major enhancement of APU with many new functions. It also removes some of the restrictions that were in the first version of the monitor, such as:

- The spooled file name and the APU print definition name no longer need to be the same
- In the earlier version of the APU Monitor, the SCS spooled file could only be set in the hold status
- The earlier version of the APU Monitor placed spooled files into one unique output queue

When using the new APU Monitor, you can:

- Define which elements are relevant for selecting the spooled file
- What is to be done with the original SCS spoolfile once APU Monitor processing is completed
- Control how APU Monitor processes your print definitions

---

### Understanding How the APU Monitor Works

In the new APU Monitor, you can specify values for the parameters that govern APU Monitor processing. These parameters are grouped together and called an “Action”.

There are three “Action” groups in the new APU Monitor. The Monitor processes these actions in the following sequence:

- Selection for input spooled file
- Action for input spooled file
- Action for output spooled file

**Note:** If an action group contains more than one action, the actions are processed in the order in which they are defined.

Figure 94 diagrams the sequence in which the APU Monitor processes the action groups.

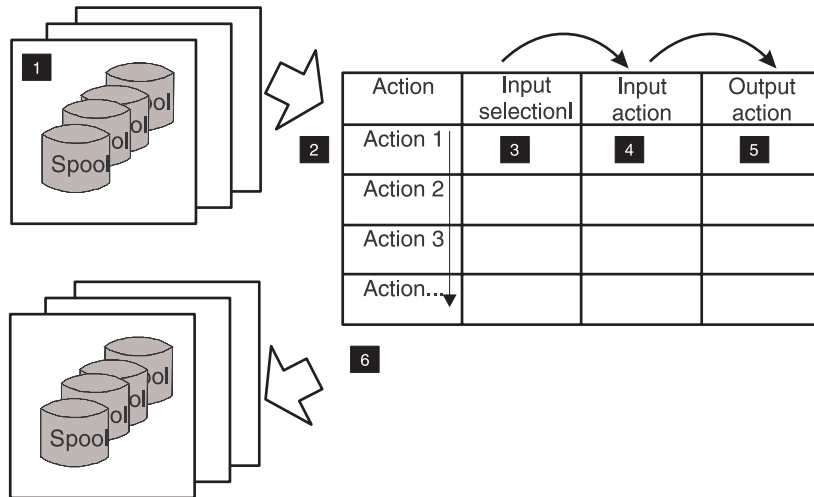

Figure 94. APU Monitor Processing Sequence

Here is an explanation of the steps shown in the diagram:

1. The monitor is invoked each time a spooled file arrives in a monitored output queue or if the spooled file status from a spool in a monitored queue changes to \*RDY. Spooled files with other status conditions are not processed.
2. The monitor checks the input selection from each action rule in a sequential manner.
3. As soon as a spooled file matches the action input selection, the input and output action are performed. Subsequent actions are ignored.
4. The input action is applied after the selection matches a spooled file. The action performed depends on whether or not APU is able to complete the job successfully.
5. You can define up to 16 output actions. This allows you, for example, to use several different APU print definitions for the same spooled file.
6. One or more spooled files are placed into one or more output queues.

## An Example of APU Monitor Processing

This section describes an example of how the concepts of the APU Monitor can be implemented in a customer environment.

### A Customer Environment

Assume that a customer wants to set up the following environment:

- Three different output types are needed, with each going to a different output queue (OUTQs).
- Two printers are available, and the monitor is to be set up with the following requirements:
  - System output (QSYSPRT) must not use an APU print definition.
  - All jobs in OUTQ1 must be sent to PRT01
  - All jobs in OUTQ2 and OUTQ3 must be sent to PRT02
  - Application jobs APP01 and APP02 must be sent with a print definition **SAMPLE** applied



- The application's original spooled files must be placed in the OUTQ called **SAVE**.
- The original QSYSPRT spooled files must be deleted.

The Figure 95 diagrams these customer requirements. The numbers in the figure are used to identify the sequence of notes provided following this diagram.

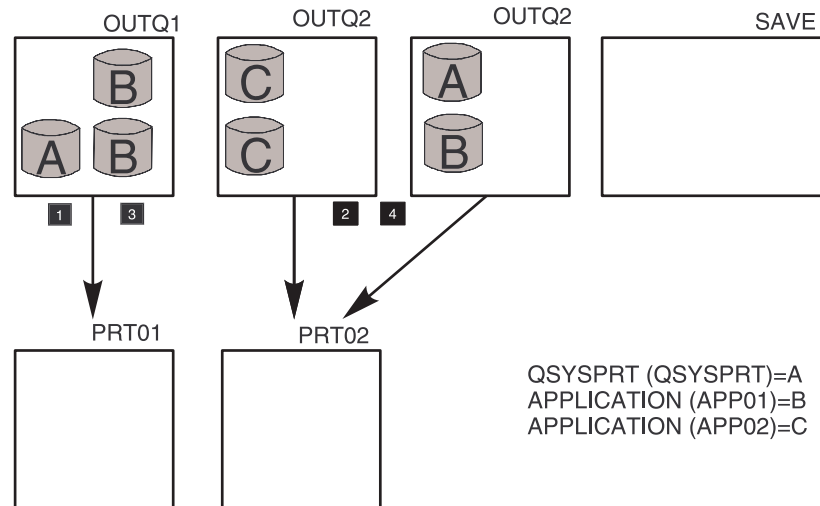

Figure 95. APU Monitor before Processing

#### Notes

1. All QSYSPRT spooled files from the OUTQ1 must be moved to OUTQ PRT01.
2. All QSYSPRT spooled files from all other OUTQs must be moved to OUTQ PRT02.
3. A print definition is to be applied to all application spooled files coming into OUTQ1. A new APU spooled file (the result of the APU processing) is to be placed in the output queue PRT01. The original SCS spooled file is moved into OUTQ SAVE.
4. A print definition is to be applied to all application spooled files coming into all other OUTQs. A new APU spooled file (the result of the APU processing) is to be placed in the output queue PRT02 for each original spooled file. The original SCS spooled file is to be moved into OUTQ SAVE.

## Implementing the Customer Requirements on the APU Monitor

In the example, we can define two groups of spooled files: the application spooled files and the QSYSPRT spooled files. Only the application spooled files need an APU print definition. In this case, we want to define actions for the application spooled files first and then the action for the QSYSPRT spooled files. So we can say that all spooled files that are not eligible for APU are moved following the QSYSPRT spooled file actions.

Figure 96 on page 86 shows which parameters must be defined for each action in the order of the action. The monitor takes the **Input selection** parameters of the first action to identify if the spool and selection match. If the input selection parameters do not match the spooled file, the monitor takes the next action. As soon as the input selection parameters match the spooled file, all action sequences such as **Input action** and **Output actions** proceed.

The numbers in the figure indicate the actions that correspond with Figure 96 .

Action	Input selection	Input action	Output action
1. Action for spool <b>3</b>	File = APP* OUTQ = Outq1	<b>5</b> Success = *outq OUTQ = SAVE Failure = *hold	Prtdf = Sample OUTQ = PRT01
2. Action for spool <b>4</b>	File = APP* OUTQ = *all	Success = *outq OUTQ = SAVE Failure = *hold	Prtdf = Sample OUTQ = PRT02
3. Action for spool <b>1</b>	File = *all OUTQ = Outq1	Success = *outq OUTQ = PRT01 Failure = *hold	Prtdf = *none
4. Action for spool <b>2</b>	File = *all OUTQ = *all	Success = *outq OUTQ = PRT02 Failure = *hold	Prtdf = *none

Figure 96. APU Monitor - Action Example

### Notes

1. Action for the application spooled files in OUTQ1
2. Action for all other application spooled files in all monitored OUTQs
3. Action for all other spooled files in OUTQ1
4. Action for all other spooled files in all other OUTQs

Many other options are possible for each action. You can decide, for example, to delete the original spooled files after processing or hold the spooled files.

## Condition of the Output Queue after Processing

In Figure 97, you can see the two QSYSPRT spooled files (A), that all the original application spooled files are in output queue **SAVE**, and that the new AFPDS spooled files (outcome from APU processing) are placed in the output queues **PRT01** and **PRT02**, depending on where the original was.

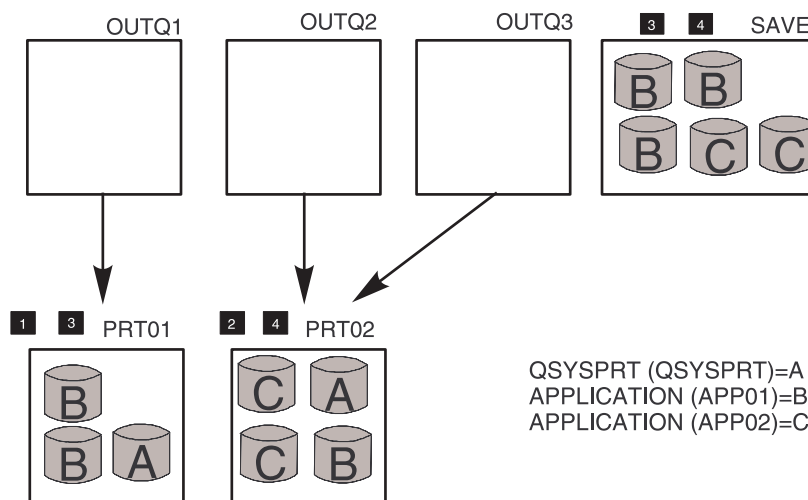

Figure 97. APU Monitor Example After Processing

### Notes

1. The QSYSPRT spooled file from OUTQ1 is in the output queue **PRT01**.

2. All QSYSPRT spooled files from the other OUTQs are in the output queue PTR02.
3. The original application SCS spooled files from OUTQ1 are in the output queue SAVE. New AFPDS spooled files have been placed in the output queue PRT01. This new spooled file is the result from APU after applying the print definition.
4. All other original application SCS spooled files from all other OUTQs are placed in the output queue SAVE. New AFPDS spooled files have been placed in the output queue PRT02. These new spooled files result from APU after applying the print definition.

**Note:** If the processing for one spooled file fails, the original spooled file stays in the output queue in status \*HOLD following the FAILURE parameter.

---

## Configuring APU Monitor

Before using APU Monitor, you must configure it. This section describes the APU panels that you use to configure the APU Monitor.

The following configuration steps are needed:

1. Specify the queues that APU Monitor is to monitor. Refer to “Specifying the Queues APU is to Monitor” on page 88.
2. Configure the APU Monitor actions. Refer to “Configuring APU Monitor Action” on page 89.
3. Start APU Monitor. Refer to “Starting APU Monitor” on page 97.
4. Stop APU Monitor when all jobs have been processed. Refer to “Stopping APU Monitor” on page 98.

These steps are performed from the APU Main Menu, shown in Figure 98.

```

APU                                IBM Advanced Print Utility

Select one of the following:

  Build and Test APU Print Definitions
    1. Work with Print Definitions
    2. Work with Spooled Files

  Run APU in Batch Mode
    3. Work with APU Monitor
    4. Start APU Monitor
    5. End APU Monitor

  Configure APU
    6. Set APU Defaults
    7. Work with Fonts
    8. Configure APU Monitor Action

Selection or command
===>

```

*Figure 98. APU Main Menu*

The following sections show you how to perform these tasks.

## Specifying the Queues APU is to Monitor

The first task to perform is to specify the queues (OUTQs) the APU Monitor is to monitor. You can add or remove OUTQs from the list. You need to add only the queue where the spooled file action is performed on an APU print definition. If a spooled file comes from other OUTQs, no processing on them is done by the APU Monitor. To specify the queues to be monitored, take the following steps.

1. Access option **3, Work with APU Monitor** at the APU Main menu.
2. The first panel that displays shows the set of currently monitored output queues:

```

Work with APU Monitor
APU Monitor status . : Active   The output queues in the list are
                               currently monitored by APU

Type options, press Enter.
  1=Add  4=Remove

  Output
Opt queue      Library  Text
---
  OUTQ1      QGPL      Input OUTQ1
  OUTQ2      QGPL      Input OUTQ2
  OUTQ3      QGPL      Input OUTQ3

F3=Exit  F5=Refresh  F12=Cancel

Bottom
  
```

Figure 99. Work with APU Monitor

3. If the output queue is all right, exit the function and go to “Configuring APU Monitor Action” on page 89. If you want to specify additional queues, enter a **1** in the top, leftmost row to add a new queue:

```

Work with APU Monitor
APU Monitor status . : Inactive The output queues in the list will be
                               monitored by APU, when the monitor is
                               started.

Type options, press Enter.
  1=Add  4=Remove
  Output
Opt queue      Library  Text
1
                               Add an Output Queue to the APU Monitor
Type choices, press Enter.
Output queue . . . . . Name   F4 for list
Library . . . . . *LIBL, Name
F4=Prompt  F12=Cancel

F3=E

Bottom
  
```

Figure 100. Add a New Output Queue

4. Enter the new output queue name, then enter the name of the library where the queue is stored.

## Configuring APU Monitor Action

To set up APU Monitor actions, you need to access item 8 on the APU Main menu, **Configure APU Monitor Action**. This selection displays an initial panel, followed by several additional panels.

This section describes each part of a Monitor action. Each action has the following three parts:

- Selection for input spooled file
- Action for input spooled file
- Action for output spooled file

The **Configure APU Monitor Action** display allows you to create, change, copy, and delete actions. Each action is performed in the sequence shown on the display by the APU print engine.

### Initial Panel

The **Configure APU Monitor Action** panel allows you to develop a table with selections and actions that the APU monitor and print engine have to perform. The initial panel allows a user to create, change, copy or delete action entries. The

Configure APU Monitor Action

Type options, press Enter.  
1=Create 2=Change 3=Copy 4=Delete

Opt	Sequence	Text
<u>1</u>	20	Qsysprt spool in all other OUTQ's
	30	QPJOB spool in OUTQ1
	40	QPJOB spool in all other OUTQ's
	50	All other spool in OUTQ1
	60	All other spool in all other OUTQ's

F3=Exit F5=Refresh F12=Cancel F22=Renumber Sequence

Figure 101. Configure APU Monitor Action panel

F22 key is used to renumber the entries automatically. The renumbering uses an increment of 10 unless the number of records is greater than 999. In that case the increment will be calculated depending on the number of records.

At runtime the monitor will retrieve the SCS spooled file attributes and try to find a matching entry. The monitor evaluates the entries in the order of the user-entered sequence numbers. As soon as the monitor finds a match, it processes the spooled file according to the rest of the information in the table. If it does not find a match in the table, a message is put into the monitor's joblog and the spooled file is not processed.

### Creating an Action Group Entry

To create an action group entry, proceed as follows.

1. Type **1** under the OPT column to create a new sequence number, as shown in Figure 102 on page 90.

```

                                Create Action Entry

Type choices, press Enter.

Sequence . . . . . 10                Number
Text . . . . . QSYSPRT spool in OUTQ1

Type options, press Enter.
1=Select

Opt  Function

1   Define selection for input spooled file
1   Define action for input spooled file
1   Define action for output spooled file

F12=Cancel

```

Figure 102. Configure APU Monitor Action panel

2. Type in a sequence number. APU Monitor uses this number to determine when to perform the test that is specified by the rule. If you want this test performed first, enter a number that is less than any previous rule number.
3. Type in a description of the rule.

**Note:** Note that a rule may apply to all three types of action groups.

4. Within an action entry a user can set up three separate or combined actions. Select the action to which the rule is to apply, by typing a **1** next to the item. Depending on what you selected, you will need to type in or select values for one or more panels. Go to the appropriate section for the action you selected:
  - “Defining Selection for Input Spooled File”
  - “Defining Action for Input Spooled File” on page 91
  - “Defining Action for Output Spooled File” on page 92

### Defining Selection for Input Spooled File

You use the first panel to define selection criteria for the input spooled file. In other words, you use this panel to select the SCS spooled file that will be processed as input. From this panel the user can decide what spooled file attributes the monitor should use to match an SCS spooled file with.

When the APU Monitor is running, it looks for a file or files with the attributes that are provided on this display. If APU finds a match between the attributes you enter here and an input spooled file, it processes both entries, **Action for Input** and **Action for Output Spooled**.

If you select **Define selection for input spooled file**, the following panel displays:

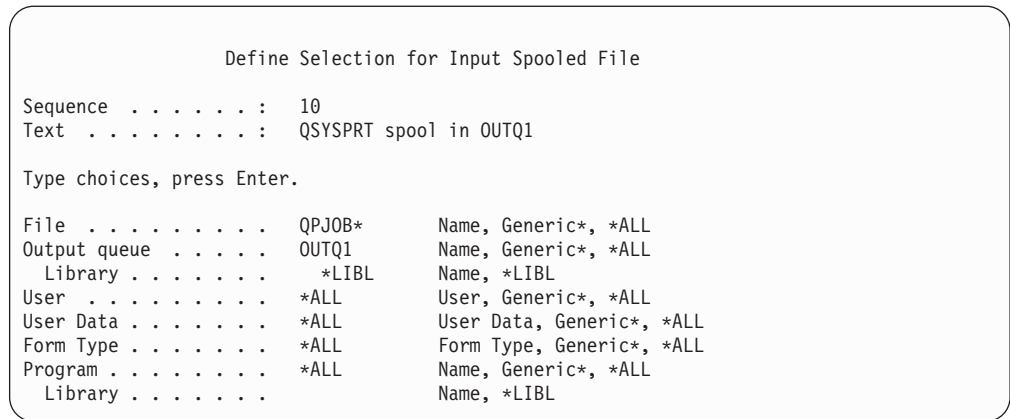

Figure 103. Define Selection for Input Spooled File panel

You enter values that APU uses to select the input spooled file. Following is a description of the values you can enter:

**Spooled file name**

This can be a specific name, a generic name, or \*ALL.

**Output queue/Library**

This can be a specific output queue, a generic name, or \*ALL.

**User** This can be a specific user, a generic set, or \*ALL.

**User Data**

This can be a specific entry in the user data field, generic data, or \*ALL.

**Form Type**

This can be a specific form, a generic form, or \*ALL.

**Program name/Library**

This can be a specific program, a generic program, or \*ALL.

When you run the APU Monitor, it looks for a file or files with the attributes that are provided on this panel. Note that all the attributes that are specified here are ANDed, so the effect of a set of attributes is to narrow a search.

If APU finds a match between the attributes you enter here and an input spooled file, it processes the next file it finds in one of the monitored queues, and the actions defined in the panels described in “Defining Action for Input Spooled File” and “Defining Action for Output Spooled File” on page 92 are performed.

If APU does not find a match between the selection criteria on the panel and the next spooled file, no action is taken.

**Defining Action for Input Spooled File**

With the **Define Action for Output Spooled File**, the detailed production processing of the input spooled file is configured. You can define up to 16 processing phases (called action groups). Within each of these action groups, the following processing can occur:

- Call the “before” user program
- Copy the input spooled file to a working database file
- Call the “middle” user program

- Transform the input database file to an AFP database file, using specified APU print definition
- Write the output AFP database file to the specified output queue
- Call the “after” user program

The **Define Action for Output Spooled File** display, consisting of two displays for each action group, provide for configuring the processing options. These options include the APU print definition, the user exit programs, the run option, and the output file options. Using multiple action groups, you can apply multiple APU print definitions to the same input spooled file, invoke user programs for unique processing, and define multiple, different output actions.

If you select **Define action for input spooled file**, the following panel displays:

Define Action for Input Spooled File

Sequence . . . . . : 10  
Text . . . . . : QSYSVRT spool in OUTQ1

Type choices for input spooled file after successful  
or failed processing respectively, press Enter.

Success . . . . .	*OUTQ	*NONE, *HOLD, *DELETE, *OUTQ
Output queue . . . . .	OUT1	Name
Library . . . . .	*LIBL	Name, *LIBL
Failure . . . . .	*HOLD	*NONE, *HOLD, *DELETE, *OUTQ
Output queue . . . . .		Name
Library . . . . .		Name, *LIBL

Figure 104. Define Action for Input Spooled File panel

APU will move the input spooled file to the output queue defined in the Success or Failure fields, depending on the result, and will place the file in one of the four status conditions shown above. \*HOLD is the default for both failure and success.

### Defining Action for Output Spooled File

The third thing a user can do in configuring APU monitor action is to define action for output spooled file. This is probably the most complicated portion. The user can enter information on two panels (which make up an action group) by describing tasks the print engine performs. The user can scroll through (or set up) a total of 16 separate actions groups to be performed. This makes it possible to process several print definitions against one SCS spooled file.

Before describing in detail the various parameters that could be set for this step, an extended example may help to clarify the concepts.

### An Example of this Processing Step

Imagine that you print at two different locations. You want to identify which invoice is for the local system and which one is for the second location. This is possible with the conditional option in the print definition. You must define two different print definitions. Each uses conditional processing to select which invoice will be in the new spooled file. (Each print definition produces one spooled file.)



For the monitor, the user must define two actions for output spooled files. Each action refers to one of the print definitions. At run time, the print engine runs both print definitions with a different Output Queue for each.

Action	Input selection	Input action	Output action 1/2	Output action 2/2
1. Action for spool <b>3</b>	File = APP* OUTQ = Outq1	Success = *outq OUTQ = SAVE Failure = *hold	<b>Prtdef = Sample</b> <b>OUTQ= PRT01</b>	<b>Prtdef=Sample2</b> <b>OUTQ=Paris</b> <b>5</b>
2. Action for spool <b>4</b>	File = APP* OUTQ = *all	Success = *outq OUTQ = SAVE Failure = *hold	<b>Prtdef = Sample</b> <b>OUTQ = PRT02</b>	<b>Prtdef= Sample2</b> <b>OUTQ= Paris</b> <b>6</b>
3. Action for spool <b>1</b>	File = *all OUTQ = Outq1	Success = *outq OUTQ = PRT01 Failure = *hold	Prtdef = *none	
4. Action for spool <b>2</b>	File = *all OUTQ = *all	Success = *outq OUTQ = PRT02 Failure = *hold	Prtdef = *none	

Figure 105. Action Example for Two Locations

### Notes

1. Action for the application spooled files in OUTQ1. An additional output action sequence is added.
2. A second print definition is applied with a different output queue.
3. Action for all other application spooled files in all monitored OUTQs.
4. An additional output section sequence is added. A second print definition is applied with a different output queue.
5. Action for all other spooled files in OUTQ1.
6. Action for all other spooled files in all other OUTQs.
7. If an empty or not correct output action is provided, the action for the Input SCS spooled file follows the failed procedure.

The next figure shows how the actions are executed from the monitor. Due to the conditional processing of the print definition, the application spooled file has been split into a local and remote output queue (designated as “Paris” in Figure 106 on page 94). The white spooled file represents that only the location dependent data is present.

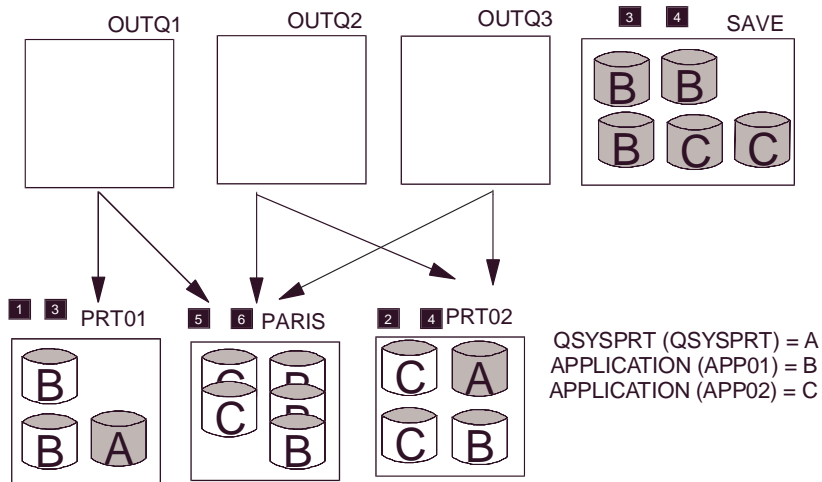

Figure 106. Spooled File Location after Processing

### Notes

1. The QSYSPRT spooled files from OUTQ1 are in PRT01 OUTQ.
2. All QSYSPRT spooled files from the other OUTQs are in PRT02 OUTQ.
3. All original application spooled files from OUT1 are placed in OUTQ SAVE after processing. A new AFPS spooled file has been placed in PRT01 for each spooled file formatted with the print definition "SAMPLE".
4. A second AFPDS spooled file formatted with the print definition "SAMPLE2" has been placed in the output queue "PARIS" for each spooled file.
5. All other original application spooled files from all other OUTQs are placed in OUTQ SAVE after processing. A new AFPS spooled file has been placed in PRT02 for each spooled file formatted with the print definition "SAMPLE".
6. A second AFPDS spooled file formatted with the print definition "SAMPLE2" has been placed in the output queue "PARIS" for each spooled file.

### Defining User Exit Before and Middle

If you select **Define** action for output spooled file, the following panel displays:

```

                                Define Action for Output Spooled File
Sequence . . . . . : 10
Text . . . . . : QSYSPRT spool in OUTQ1
Action . . . . . : 1 / 1
Panel . . . . . : 1 / 2

Type choices, press Enter.

User exit before . . . *NONE                Name, *NONE
Library . . . . .      Name, *LIBL
User parameter . . .   Value
Print Definition . . . SAMPLE              Name, *SPOOLFILE, *NONE
Library . . . . .      *PRTDEFLIB          Name, *PRTDEFLIB, *LIBL
Run option . . . . .  *NORMAL              *NORMAL, *NOCOPY, *REPRINT
User exit middle . . . *NONE                Name, *NONE
Library . . . . .      Name, *LIBL
User parameter . . .   Value
Output device . . . . . *JOB                Name, *JOB
Output queue . . . . . PRT01              Name, *DEV, *SPOOLFILE
Library . . . . .      *LIBL                Name, *LIBL
====>
F12=Cancel                    F15=Next action

```

Figure 107. Define Action for Output Spooled File panel

On this panel, you specify the name, library, and user-defined parameter for the program that APU is to call before, during, or after processing. The default is \*NONE. Refer to Appendix B, “User Exits” on page 103 for details about the user exits.

The Print Definition lines contain values for the library where the print definition is stored, and for the “Run Option.”

Following are the values that could be entered for Run Option:

**Ignored**

If you specify \*NONE on the print definition field, any value you place here is ignored.

**\*NORMAL**

This is the default entry. If only one action (of 16) is defined, \*NORMAL is the only valid value for the field, so the value must be \*NORMAL for the first (or only) action.

**\*NOCOPY**

This value is valid only if specified for the second (or later) action group. It allows different print definitions for the same spooled file.

**\*REPRINT**

This value is valid only if specified for the second (or later) action. This value is used if you want to apply the same print definition multiple times on the same spooled file.

In the output device field, you specify the name of the device on which the spooled file is to be printed. The value \*JOB gets APU to place the output spooled file in the out-queue of the current device.

The output queue field contains the name of the output queue where the spooled file is to be placed. \*SPOOLFILE tells APU to place the output file in the same

output queue where the input spooled file was found. \*DEV has APU place the file into the output queue of the device specified in the Output Device field.

### Defining User Exit After

This panel is used to specify what is to be done **after** processing a file.

```

                                Define Action for Output Spooled File
Sequence . . . . . : 10
Text . . . . . : QSYSVRT spool in OUTQ1
Action . . . . . : 1 / 1
Panel . . . . . : 2 / 2

Type choices, press Enter.

File . . . . . *SPOOLFILE          Name, *PRTDEF, *SPOOLFILE
User Data . . . . . *SPOOLFILE      User Data, *PRTDEF, *SPOOLFILE
Form Type . . . . . *SPOOLFILE      Form Type, *PRTDEF, *SPOOLFILE
Hold . . . . . *NO                  *YES, *NO
Save . . . . . *NO                  *YES, *NO, SPOOLFILE
Output bin . . . . . *DEV            1-65536, *DEV, *SPOOLFILE
User exit after . . . . *NONE        Name, *NONE
Library . . . . .                Name, *LIBL
User parameter . . . .                Value

                                Bottom
F12=Cancel                      F15=Next action

```

Figure 108. Define Action for Output Spooled File panel

**File** The File field is the name of the output spooled file. Use \*PRTDEF if you want the output spooled file to have the same name as the print definition. Use \*SPOOLFILE if you want the output spooled file to have the same name as the input spooled file.

#### User Data

The User Data field specifies the character string that is attached to the output file. \*PRTDEF tells APU to set the value of this field to the name of the processed print definition. \*SPOOLFILE tells APU to set this character string value to the data string of the input spooled file.

#### Form Type

The Form Type field names the form type of the output spooled file. \*PRTDEF tells APU to set the form type to the name of the processed print definition. \*SPOOLFILE sets the form type of the output file to the form of the input file.

**Hold** The Hold field holds a value specifying the status that the output spooled file is top have. \*NO sets the value to READY; \*YES sets the value to HELD.

**Save** The Save field specifies what happens to the output spooled file: \*NO does not save the file; \*YES saves the file. \*SPOOLFILE does to the output spooled file what was done to the input spooled file.

#### Output Bin

The Output Bin field is the name of the output bin of the printer. \*DEV puts the file in the bin that is specified by the printer device description. \*SPOOLFILE is used to specify the output bin of the input spooled file.

### User exit after

The User exit after field contains the name, library, and user defined parameter for the program to be called by APU after the output spooled file has been created.

## Starting APU Monitor

Begin at the APU Main menu, as shown in Figure 109:

```
APU                                IBM Advanced Print Utility
Select one of the following:
Build and Test APU Print Definitions
  1. Work with Print Definitions
  2. Work with Spooled Files
Run APU in Batch Mode
  3. Work with APU Monitor
  4. Start APU Monitor
  5. End APU Monitor
Configure APU
  6. Set APU Defaults
  7. Work with Fonts
  8. Configure APU Monitor Action
Selection or command
===>
F3=Exit   F4=Prompt   F9=Retrieve   F12=Cancel   F16=System main menu
F23=Set initial menu
5798-AF4 (C) COPYRIGHT IBM CORP. 1996, 1997
```

Figure 109. APU Main Menu panel

Select **4. Start APU Monitor** to display the panel shown in Figure 110:

```
APU                                IBM Advanced Print Utility
APU
Select one of the following:
Build and Test APU Print Definitions
-----
Start APU Monitor

Number of active monitor jobs . . . . . : 0
Number of monitor jobs in job queue(s) . . . . . : 0

Type choices, press Enter.

Job description . . . . . QYPUJOB    Name
Library . . . . . *LIBL          Name, *LIBL, *CURLIB
-----
===>
F3=Exit   F4=Prompt   F9=Retrieve   F12=Cancel   F16=System main menu
F23=Set initial menu
```

Figure 110. Start APU Monitor panel

Type in the job description and the library where it is stored, then press Enter to start the monitor. On pressing Enter, you return to the Main menu, and a message appears on the bottom of the panel telling that APU Monitor is started.

---

## Stopping APU Monitor

To stop the APU Monitor, return to the APU main menu and select **5. End APU Monitor**:

```
APU                                IBM Advanced Print Utility
Select one of the following:
  Build and Test APU Print Definitions
    1. Work with Print Definitions
    2. Work with Spooled Files
  Run APU in Batch Mode
    3. Work with APU Monitor
    4. Start APU Monitor
    5. End APU Monitor
  Configure APU
    6. Set APU Defaults
    7. Work with Fonts
    8. Configure APU Monitor Action
Selection or command
===>
F3=Exit   F4=Prompt   F9=Retrieve   F12=Cancel   F16=System main menu
F23=Set initial menu
1 jobs ended, 1 jobs canceled
```

Figure 111. Stop APU Monitor panel

---

## Part 4. Appendixes





---

## Appendix A. APU Samples

To help you become familiar with APU, the following sample materials have been provided in the QAPU library:

*Table 2. Samples in the QAPU Library*

<b>Name</b>	<b>Type</b>
AMASTER	Print definition example to be used with INVPRE.
GRID	Overlay
GRID1	Overlay
INVALL	Overlay
INVBAC	Overlay
INVFAST	Overlay
INVHEAD	Overlay
INVHEAD2	Overlay
INVLST	Overlay
INVMID	Overlay
INVPRE	Sample spooled file (in QYPUOUTQ)
INVSCS	Sample spooled file (in QYPUOUTQ)
QCLSRC	Contains a sample user exit
QDDSRC	DDS for use with the RPG sample program (INVSCS)
QOVL SRC	Overlay Source
QRPGSRC	Contains an RPG sample program to build INVSCS in the user's OUTQ. Refer to "Creating Sample Spool Files" on page 113.
QYPUOUTQ	Output Queue
SAM3006	Overlay
SEEDCUST	Seed company customer master PF
SEEDDETL	Super Sun Seeds invoicing LF
SEEDDETP	Super Sun Seeds invoicing PF
SEEDITEM	Seed company item master PF
STRWNB	Page segment
SUNLOGO	Page segment
SUPER	Print definition example to be used with INVSCS
SUPER2	Print definition example to be used with INVSCS
TREENB	Page segment



---

## Appendix B. User Exits

This appendix describes the user exits that are referred to in “Defining User Exit Before and Middle” on page 94 and “Defining User Exit After” on page 96.

---

### Processing Phases

Following is a description of the processing phases the APU print engine goes through in general and when processing the user exits:

*Table 3. APU Print Engine Processing Phases*

Step	Description	Modified Version Program Name	Pre-Modification Equivalent
1	Call the user exit program “before”	EXTBEF	None
2	Set up the internal environment using the print definition.	INZENV	INZENV
3	Create the internal spool database using the CPYSPLF command.	CPYSPLF	CPYSPLF
4	Call the “middle” user exit.	EXTMID	None
5	Process the input file and create an AFPDS output database.	GENAFP	GENAFP
6	Convert the database to the spooled file using the PRTAFPDTA command.	PRTAFPDTA	PRTAFPDTA
7	Call the “after” user exit program.	EXTAFT	None
8	Perform post-processing action on the SCS spooled file.	INPACT	None

---

### User Exit Before

The USER EXIT BEFORE program includes the library the program is in and a 20 character user parameter to be passed to the exit program. This program (phase EXTBEF) will be executed before the print engine starts to initialize (phase INZENV, which sets up the internal environment such as variables, tables, and so on) using the print definition.

Following is the parameter structure passed by the APU print engine if a user exit is called for BEFORE processing is initialized:

Table 4. Parameters Passed to the Before Initialization User Exit

INFILE	Name of the Input spooled file
INNBR	File number of the input spooled file
INTYPE	Input type of spooled file (*SCS, *IPDS, *AFPDS, etc.)
JOBUSR	Input creating job&csq;s user
JOBNAM	Input creating job&csq;s name
JOBNBR	Input creating job&csq;s number
INOQNM	Input-output queue name
INOQLB	Input-output queue library
INUSDT	Input user data string
INFORM	Input form type
INOBIN	Input outbin
INPGNM	Input creating program name
INPGLB	Input creating program library
PRTDEF	Empty
PRTDLB	Empty
SUCFLG	Empty
OTFILE	Empty
OTOQNM	Empty
OTOQLB	Empty
OTHOLD	Empty
OTSAVE	Empty
OTUSDT	Empty
OTFORM	Empty
OTOBIN	Empty
USRPRM	Value from the User Parameter (before) field

---

## User Exit Middle

A USER EXIT MIDDLE program includes the library the program is in and a 20 character user parameter to be passed to the exit program. This program (phase EXTMID) will be run after the print engine copies the input spooled file to the input spool database. (This occurs in the CPYSPL phase, which creates the internal spool database using the CPYSPLF command.)

Following is the parameter structure passed by the APU print engine if a user exit is called **after** the input spooled file has been copied to the input spool database:

Table 5. Parameters Passed to the Middle User Exit

INFILE	Name of the Input spooled file
INNBR	File number of the input spooled file
INTYPE	Input type of spooled file (*SCS, *IPDS, *AFPDS, etc.)
JOBUSR	Input creating job&csq;s user
JOBNAM	Input creating job&csq;s name
JOBNBR	Input creating job&csq;s number
INOQNM	Input-output queue name
INOQLB	Input-output queue library
INUSDT	Input user data string
INFORM	Input form type
INOBIN	Input outbin
INPGNM	Input creating program name
INPGLB	Input creating program library
PRTDEF	Name of the print definition that will be applied
PRTDLB	Library of the print definition that will be applied
SUCFLG	Empty
OTFILE	Empty
OTOQNM	Empty
OTOQLB	Empty
OTHOLD	Empty
OTSAVE	Empty
OTUSDT	Empty
OTFORM	Empty
OTOBIN	Empty
USRPRM	Value from the User Parameter (before) field

---

## User Exit After

A USER EXIT AFTER program includes the library the program is in and a 20 character user parameter to be passed to the exit program. This program (that is run for the EXTAFT phase) will be run after the print engine creates the AFPDS output spooled file, which is done during the PRTAFP phase that converts the database to spooled file using the PRTAFPDTA command.

Following is the parameter structure passed by the APU print engine if a user exit is called **after** the AFPDS output spooled file has been created:

Table 6. Parameters Passed to the User Exit After the AFPDS Spooled File has been Created

INFILE	Name of the Input spooled file
INNBR	File number of the input spooled file
INTYPE	Input type of spooled file (*SCS, *IPDS, *AFPDS, etc.)
JOBUSR	Input creating job&csq;s user
JOBNAM	Input creating job&csq;s name
JOBNBR	Input creating job&csq;s number
INOQNM	Input-output queue name
INOQLB	Input-output queue library
INUSDT	Input user data string
INFORM	Input form type
INOBIN	Input outbin
INPGNM	Input creating program name
INPGLB	Input creating program library
PRTDEF	Name of the print definition that will be applied
PRTDLB	Library of the print definition that will be applied
SUCFLG	*YES or *NO depending on success or failure
OTFILE	Name of the AFPDS output spooled file created
OTOQNM	Out-queue name of the created AFPDS output spooled file
OTOQLB	Library name of the created AFPDS output spooled file
OTHOLD	*YES or *NO depending on the Hold flag of the created AFPDS output spooled file
OTSAVE	*YES or *NO depending on the Save flag of the created AFPDS output spooled file
OTUSDT	User data string of the created AFPDS output spooled file
OTFORM	Form type of the created AFPDS output spooled file
OTOBIN	Outbin of the created AFPDS output spooled file
USRPRM	Value from the User Parameter (after) field

## Sample User Exit Program

The following Control Language (CL) program provides a framework for using the before, middle, and after user exits within APU production processing. This program is provided in the QCCSRC file in the QAPU library.

```

/*****/
/* NAME:                QYPUEXTSMP                               */
/*                                                              */
/* DESCRIPTIVE NAME:    APU SAMPLE EXIT PROGRAM FOR APYPRTDEF   */
/*                    5798-AF4 (C) COPYRIGHT IBM CORP. 1997    */
/*                                                              */
/* FUNCTION:           This sample program demonstrates the     */
/*                    new exit points in the APYPRTDEF command. */
/*                                                              */
/*****/

PGM          PARM(&EXPARM)

                /* Exit program parameter string                */

```

```

DCL      VAR(&EXPARM)    TYPE(*CHAR) LEN(512)

          /* Type of exit point (*BEFORE,*MIDDLE,*AFTER) */
DCL      VAR(&EXTYPE)    TYPE(*CHAR) LEN(10)

          /* Name of input spooled file */
DCL      VAR(&EXINFILE)  TYPE(*CHAR) LEN(10)

          /* Name of input spooled file number */
DCL      VAR(&EXINNBR)   TYPE(*CHAR) LEN(10)

          /* Input Printer device type */
DCL      VAR(&EXINTYPE)  TYPE(*CHAR) LEN(10)

          /* Input Jobs User */
DCL      VAR(&EXJOBUSR)  TYPE(*CHAR) LEN(10)

          /* Input Jobs Name */
DCL      VAR(&EXJOBNAM)  TYPE(*CHAR) LEN(10)

          /* Input Jobs Number (alpha) */
DCL      VAR(&EXJOBNBR)  TYPE(*CHAR) LEN(06)

          /* Input Outq Name */
DCL      VAR(&EXINOQNM)  TYPE(*CHAR) LEN(10)

          /* Input Outq Library */
DCL      VAR(&EXINOQLB)  TYPE(*CHAR) LEN(10)

          /* Input User data */
DCL      VAR(&EXINUSDT)  TYPE(*CHAR) LEN(10)

          /* Input Form type */
DCL      VAR(&EXINFORM)  TYPE(*CHAR) LEN(10)

          /* Input out-bin */
DCL      VAR(&EXINOBIN)  TYPE(*CHAR) LEN(10)

          /* Input Program Name */
DCL      VAR(&EXINPGNM)  TYPE(*CHAR) LEN(10)

          /* Input Program Library */
DCL      VAR(&EXINPLB)   TYPE(*CHAR) LEN(10)

          /* Print Definition Name */
DCL      VAR(&EXPRTDEF)  TYPE(*CHAR) LEN(10)

          /* Print Definition Library */
DCL      VAR(&EXPRTDLB)  TYPE(*CHAR) LEN(10)

          /* Success flag (*YES, *NO, *ACTIVE) */
DCL      VAR(&XSUCFLG)   TYPE(*CHAR) LEN(10)

          /* Name of output spooled file */
DCL      VAR(&EXOTFILE)  TYPE(*CHAR) LEN(10)

          /* Output Outq Name */
DCL      VAR(&EXOTOQNM)  TYPE(*CHAR) LEN(10)

          /* Output Outq Library */
DCL      VAR(&EXOTOQLB)  TYPE(*CHAR) LEN(10)

          /* Output Hold Flag (*YES, *NO) */
DCL      VAR(&EXOTHOLD)  TYPE(*CHAR) LEN(10)

          /* Output Save Flag (*YES, *NO) */
DCL      VAR(&EXOTSAVE)  TYPE(*CHAR) LEN(10)

```

```

DCL          /* Output User data                               */
VAR(&EXOTUSDT) TYPE(*CHAR) LEN(10)

DCL          /* Output Form type                               */
VAR(&EXOTFORM) TYPE(*CHAR) LEN(10)

DCL          /* Output out-bin                                */
VAR(&EXOTOBIN) TYPE(*CHAR) LEN(10)

DCL          /* User specified parameter for exit pgm        */
VAR(&EXUSRPRM) TYPE(*CHAR) LEN(20)

DCL          /* Reserved for future use                       */
VAR(&RESERVED) TYPE(*CHAR) LEN(246)

/*****
/*
/* STEP 1:           Split parameter structure into single fields
/* -----
/*
/*
*****/

STEP1:
CHGVAR      VAR(&EXTYPE)      VALUE(%SST(&EXPARM 001 010))
CHGVAR      VAR(&EXINFILE)    VALUE(%SST(&EXPARM 011 010))
CHGVAR      VAR(&EXINNBR)     VALUE(%SST(&EXPARM 021 010))
CHGVAR      VAR(&EXINTYPE)    VALUE(%SST(&EXPARM 031 010))
CHGVAR      VAR(&EXJOBUSR)    VALUE(%SST(&EXPARM 041 010))
CHGVAR      VAR(&EXJOBNAM)    VALUE(%SST(&EXPARM 051 010))
CHGVAR      VAR(&EXJOBNBR)    VALUE(%SST(&EXPARM 061 006))
CHGVAR      VAR(&EXINOQNM)    VALUE(%SST(&EXPARM 067 010))
CHGVAR      VAR(&EXINOQLB)    VALUE(%SST(&EXPARM 077 010))
CHGVAR      VAR(&EXINUSDT)    VALUE(%SST(&EXPARM 087 010))
CHGVAR      VAR(&EXINFORM)    VALUE(%SST(&EXPARM 097 010))
CHGVAR      VAR(&EXINOBIN)    VALUE(%SST(&EXPARM 107 010))
CHGVAR      VAR(&EXINPGNM)    VALUE(%SST(&EXPARM 117 010))
CHGVAR      VAR(&EXINPGLB)    VALUE(%SST(&EXPARM 127 010))
CHGVAR      VAR(&EXPRTDEF)    VALUE(%SST(&EXPARM 137 010))
CHGVAR      VAR(&EXPRTDLB)    VALUE(%SST(&EXPARM 147 010))
CHGVAR      VAR(&EXSUCFLG)    VALUE(%SST(&EXPARM 157 010))
CHGVAR      VAR(&EXOTFILE)    VALUE(%SST(&EXPARM 167 010))
CHGVAR      VAR(&EXOTOQNM)    VALUE(%SST(&EXPARM 177 010))
CHGVAR      VAR(&EXOTOQLB)    VALUE(%SST(&EXPARM 187 010))
CHGVAR      VAR(&EXOTHOLD)    VALUE(%SST(&EXPARM 197 010))
CHGVAR      VAR(&EXOTSAVE)    VALUE(%SST(&EXPARM 207 010))
CHGVAR      VAR(&EXOTUSDT)    VALUE(%SST(&EXPARM 217 010))
CHGVAR      VAR(&EXOTFORM)    VALUE(%SST(&EXPARM 227 010))
CHGVAR      VAR(&EXOTOBIN)    VALUE(%SST(&EXPARM 237 010))
CHGVAR      VAR(&EXUSRPRM)    VALUE(%SST(&EXPARM 247 020))
CHGVAR      VAR(&RESERVED)    VALUE(%SST(&EXPARM 267 246))

/*****
/*
/* STEP 2:           Analyze type of calling exit point in APYPRTDEF
/* -----
/*
/*
*****/

STEP2:
IF          COND(&EXTYPE = *BEFORE) THEN(GOTO +
CDDLBL(STEP3_BEF))

IF          COND(&EXTYPE = *MIDDLE) THEN(GOTO +
CDDLBL(STEP3_MID))

```



```

IF          COND(&EXTYPE = *AFTER) THEN(GOTO +
              CMDLBL(STEP3_AFT))

GOTO       CMDLBL(STEP4)

/*****
/*
/* STEP 3:          Perform specific commands depending on calling      */
/* -----          exit point in APYPRDEF                               */
/*
/*
/*****

/*****
/*
/*          SAMPLE CODE FOR *BEFORE                                     */
/*****
STEP3_BEF:
  SNDMSG    MSG('APU starts to process' *BCAT &EXJOBUSR +
                *TCAT ''s' *BCAT 'spooled file' *BCAT +
                &EXINFILE *TCAT '.' *CAT &EXINNBR *BCAT +
                'type' *BCAT &EXINTYPE *BCAT 'from output +
                queue' *BCAT &EXINOQLB *TCAT '/' *CAT +
                &EXINOQNM) TOUSR(*SYSOPR)

  GOTO      CMDLBL(STEP4)

/*****
/*
/*          SAMPLE CODE FOR *MIDDLE                                     */
/*****
STEP3_MID:
  SNDMSG    MSG('APU starts to generate AFP data using +
                print definition' *BCAT &EXPRDLB *TCAT +
                '/' *CAT &EXPRDEF *TCAT '. (FYI: The +
                parameter at runtime for the program +
                which sent the message to you was -->' +
                *CAT &EXUSRPRM *CAT '<--') TOUSR(*SYSOPR)

  GOTO      CMDLBL(STEP4)

/*****
/*
/*          SAMPLE CODE FOR *AFTER                                     */
/*****
STEP3_AFT:
  IF          COND(&EXSUCFLG = *YES) THEN(GOTO +
              CMDLBL(AFT_SUCC))
  ELSE       CMD(GOTO CMDLBL(AFT_FAIL))

AFT_SUCC:
  SNDMSG    MSG('APU successfully created the AFPDS +
                spooled file' *BCAT &EXOTFILE *BCAT 'in +
                the output queue' *BCAT &EXOTOQLB *TCAT +
                '/' *CAT &EXOTOQNM *BCAT 'with the flags +
                HOLD(' *CAT &EXOTHOLD *TCAT ') SAVE(' +
                *CAT &EXOTSAVE *TCAT ')') TOUSR(*SYSOPR)

  GOTO      CMDLBL(STEP4)

AFT_FAIL:
  SNDMSG    MSG('WARNING: The AFP data stream which was +
                created by APU could not be printed with +
                the PRTAFPDTA command. (FYI: APU used +
                print definition' *BCAT &EXPRDLB *TCAT +

```

```
'/' *CAT &EXPRTDEF *BCAT 'for' *BCAT +  
&EXJOBUSR *CAT ''s' *BCAT 'spooled file' +  
*BCAT &EXINFILE *TCAT '.' *CAT &EXINNBR +  
*BCAT 'type' *BCAT &EXINTYPE *BCAT 'from +  
output queue' *BCAT &EXINOQLB *TCAT '/' +  
*CAT &EXINOQNM *TCAT ')') TOUSR(*SYSOPR)
```

```
GOTO CMDLBL(STEP4)
```

```
/*****  
/*  
/* STEP 4: Return to APYPRTDEF and continue processing */  
/* ----- */  
/* */  
/*****/
```

```
STEP4:  
RETURN  
ENDPGM
```

---

## Appendix C. APU Helpful Hints

---

### APYPRTDEF Command

When you are applying a print definition to a spool file using the APYPRTDEF command, a line appears on the bottom left of the display as an indicator of the processing phases. The line contains 3 asterisks(\*\*\*) in eight different positions. Refer to “Processing Phases” on page 103.

---

### APU Defaults

- When initially setting APU defaults, we recommend that you ensure that any libraries where code pages exist have been added to your current library list. Command line capability does not exist within APU to add any libraries from this display.
- An administrator must ensure that enough library list entries are available during APU execution for the additional resources listed in the “Set APU Defaults” panel.

---

### Maximum APU Values

Because APU builds structure into the document design, some limitations exist on those structural elements, as shown below.

APU Function	Maximum Value
Input page width	250 characters
Input page length	127 lines
Number of selection rules per print definition	99
Number of selection fields per print definition	600 (including constants in rules)
Number of page formats per print definition	99
Number of copies per page format	99
Number of text mappings and suppressions per line	250
Number of text constants per copy	250
Number of bar code mappings and bar code constants per copy	750
Number of different font character sets per copy	32
Number of boxes per copy	99
Number of page segments per copy	99
Number of overlays per copy	99

---

### Print Definition Creation

- When you are creating a print definition and have selected a sample spool file, remember that you are selecting a spool file for reference purposes only. This spool file may or may not be the actual spool file that is specified for the print definition for printing.

- Initially, the additional resource libraries field entries in the “Set Print Definition Attributes” panel are copied from the APU defaults. If a user overrides any of these resources on this panel, APU will only use these overridden resources. APU does NOT concatenate these overridden resources with entries that might have been specified in the APU defaults initially.
- You must ensure that a sufficient number of user library list entries exist when you are adding additional resources on the “Set Print Definition Attributes” display.
- If you create a print definition with two page formats, ensure that you code rules to handle both pages. APU does not assume an implied else statement to print a second page format. For example, to ensure pages that other than ‘Page 2’ will print, code:
 

```
IF PG2ONLY *EQ 'Page 2' *USE PG2
                                *USE *DEFAULT
```
- You can specify MULTIPLE PAGE FORMATS = \*YES, and only have one page format, but RENAMING the \*DEFAULT page format may not produce any output. If APU does not find a rule that refers to the RENAMED page format, APU attempts to find \*DEFAULT as the page format to use, and because it would not find \*DEFAULT, APU assumes \*OMIT, does not print any copies contained within the RENAMED page format, and prints only the original input spooled file. To fix this, you can do one of the following:
  - Rename the Page Format back to \*Default
  - Define a rule to \*USE the new page format name

---

## Mapping Data

- Try to map a total area; don’t leave spaces between columns. This provides better performance.
- If you increase the line increment and utilize the repeat function, you could cause an error by trying to create data off the logical page. This should be considered when requesting rotation also.
- If you increase the line increment, you should also ensure the starting position down value is correct, it is not automatically recalculated for you; otherwise, your data may not be positioned in respect to other data on the page.
- You cannot place two constants on the same origin. If you feel that this is absolutely necessary to do this, you can trick the system by changing the unit of measure to UNITS, and just increment the origin by 1 unit. By doing this, the origin looks the same on different printers due to the rounding of pel placements they perform.

---

## Copies and Page Formats

- Take a lot of space; eliminate unused page formats or copies to speed up processing.
- We recommend that you determine that the first change is how you want it before continuing on with copies or page formats copied from first changes; otherwise, each copy/page format that was made would have to be modified rather than just the original.
- APU processes copies in alphabetical name order. For example, if you had two copies (PGE1 & PGB), and you want PGE1 associated with the first copy, you could rename PGE1 to PGA, so it is first alphabetically.

---

## Duplex

- When you enable duplex printing on the “Set Page Layout Options” display, specify \*NONE for Back Overlay on this display because APU cannot print text that includes overlays, page segments, and boxes on the front side of a duplexed sheet and then print an overlay on the back side of that duplexed sheet.
- You can only specify duplex printing for consecutive pages of the same copy. When you are printing different copies, you cannot specify duplex printing.

---

## Creating Sample Spool Files

The QRPGRSRC member INVSCS has already been compiled in the QAPU library. It is called INVSCS \*PGM.

### Creating Your Own Copy of INVSCS

If you would like to create your own copy of INVSCS in your own OUTQ, issue the following commands from the command line:

```
ADDLIB QAPU
CALL PGM(QAPU/INVSCS)
RMLIB QAPU
```

### Recreating INVPRE and INVSCS

If you would like to recreate the INVPRE and INVSCS files in the QYPUOUTQ, issue the following commands from the command line:

```
ADDLIB QAPU
CALL PGM(QAPU/QYPUCSPLF)
RMLIB QAPU
```



---

## Appendix D. AFP Resource Commands

This appendix describes how to build iSeries resource objects from font, overlay, and page segment files that are created on a client system. If you are using the Overlay Utility (part of AFPU) for overlays, you will not need the overlay commands. The Overlay Utility builds overlays directly on the OS/400. If you are using the Resource Management Utility (also part of AFPU), it provides the functions that are needed to build page segments.

---

### Creating Font Resources

The following section describes how to create font resources.

1. Create a temporary resource file as shown below. From an iSeries command line, issue the CRTPF command to create a file to receive the PC resources. The “Create Physical File (CRTPF)” panel appears.

```
                                Create Physical File (CRTPF)
Type choices, press Enter.
File . . . . . FILE          > TEMPPF
Library . . . . .           > QTEMP
Source file . . . . . SRCFILE QDSSRC
Library . . . . .           *LIBL
Source member . . . . . SRCMBR *FILE
Record length, if no DDS . . . RCDLEN 32766
Generation severity level . . . GENLVL 20
Flagging severity level . . . . FLAG 0
File type . . . . . FILETYPE *DATA
Member, if desired . . . . . MBR *FILE
Text 'description' . . . . . TEXT 'Temporary File'
                                                    Bottom
F3=Exit F4=Prompt F5=Refresh F10=Additional parameters F12=Cancel
F13=How to use this display F24=More keys
```

Figure 112. Create Temporary Resource File

2. Transfer the font resource to the temporary resource file.

```
                                Copy From PC Document (CPYFRMPCD)
Type choices, press Enter.
From folder . . . . . FROMFLR resource
To file . . . . . TOFILE tempf
Library . . . . .           qtemp
From document . . . . . FROMDOC newfont.fnt
To member . . . . . TOMBR *FIRST
Replace or add records . . . . MBROPT *REPLACE
Translate table . . . . . TRNTBL *none
Library . . . . .           *none
Format of PC data . . . . . TRNFMT *notext
                                                    Bottom
F3=Exit F4=Prompt F5=Refresh F12=Cancel F13=How to use this display
F24=More keys
```

Figure 113. Copy From PC Document (CPYFRMPCD) panel

3. Create the Font Resource. Use the CRTFNTRSC command to create an iSeries font resource.

```

                                Create Font Resource (CRTFNTRSC)
Type choices, press Enter.
Font resource . . . . . FNRSC          newfont
Library . . . . .                *CURLIB
File . . . . . FILE                tempff
Library . . . . .                qtemp
Member . . . . . MBR                *FNTRSC
Text 'description' . . . . . TEXT      'New Character Set'
                                                    Bottom
F3=Exit  F4=Prompt  F5=Refresh  F10=Additional parameters  F12=Cancel
F13=How to use this display  F24=More keys

```

Figure 114. Create Font Resource (CRTFNTRSC) panel

## Creating Overlay Resources

The following section describes how to create overlay resources.

1. Create a temporary resource file as follows. From an iSeries command line, issue the CRTPF command to create a file to receive the PC resources. The “Create Physical File (CRTPF)” panel appears.

```

                                Create Physical File (CRTPF)
Type choices, press Enter.
File . . . . . FILE                > TEMPPF
Library . . . . .                > QTEMP
Source file . . . . . SRCFILE      QDDSSRC
Library . . . . .                *LIBL
Source member . . . . . SRCMBR     *FILE
Record length, if no DDS . . . . RCDLEN 32766
Generation severity level . . . . GENLVL 20
Flagging severity level . . . . FLAG  0
File type . . . . . FILETYPE       *DATA
Member, if desired . . . . . MBR    *FILE
Text 'description' . . . . . TEXT    'Temporary File'
                                                    Bottom
F3=Exit  F4=Prompt  F5=Refresh  F10=Additional parameters  F12=Cancel
F13=How to use this display  F24=More keys

```

Figure 115. Create Temporary Resource File panel

2. Transfer the overlay file from the folder by using the CPYFRMPCD command:



```

Copy From PC Document (CPYFRMPCD)
Type choices, press Enter.
From folder . . . . . FROMFLR      resource
To file . . . . . TOFILE          tempff
Library . . . . .                  qtemp
From document . . . . . FROMDOC    newov1.oly
To member . . . . . TOMBR         *FIRST
Replace or add records . . . . . MBROPT *REPLACE
Translate table . . . . . TRNTBL   *none
Library . . . . .                  *notext
Format of PC data . . . . . TRNFMT
                                           Bottom
F3=Exit  F4=Prompt  F5=Refresh  F12=Cancel  F13=How to use this display
F24=More keys

```

Figure 116. Copying Overlay File from Folder

3. Create the Overlay. Use the CRTOVL command to create an iSeries overlay:

```

Create Overlay (CRTOVL)
Type choices, press Enter.
Overlay . . . . . OVL            newov1
Library . . . . . *CURLIB
File . . . . . FILE            tempff
Library . . . . . qtemp
Member . . . . . MBR          *OVL
Data type . . . . . DATATYPE   *AFPDS
Text 'description' . . . . . TEXT 'New Overlay'
                                           Bottom
F3=Exit  F4=Prompt  F5=Refresh  F10=Additional parameters  F12=Cancel
F13=How to use this display  F24=More keys

```

Figure 117. Create Overlay (CRTOVL) panel

An alternative to using the individual steps that are described above is to build and use the OVERLAY command. Refer to the *iSeries Guide to AFP Printing and PSF* for details.

## Creating Page Segment Resources

The following section describes how to create page segment resources.

1. Create a temporary resource file as follows. From an iSeries command line, issue the CRTPF command to create a file to receive the PC resources. The “Create Physical File (CRTPF)” panel appears.

```

                                Create Physical File (CRTPF)
Type choices, press Enter.
File . . . . . FILE          > TEMPPF
Library . . . . .           > QTEMP
Source file . . . . . SRCFILE QDSSRC
Library . . . . .           *LIBL
Source member . . . . . SRCMBR *FILE
Record length, if no DDS . . . RCDLEN 32766
Generation severity level . . . GENLVL 20
Flagging severity level . . . . FLAG 0
File type . . . . . FILETYPE *DATA
Member, if desired . . . . . MBR *FILE
Text 'description' . . . . . TEXT 'Temporary File'
                                                    Bottom
F3=Exit F4=Prompt F5=Refresh F10=Additional parameters F12=Cancel
F13=How to use this display F24=More keys

```

Figure 118. Create Temporary Resource File

2. Transfer the page segment file to the temporary resource file by using the CPYFRMPCD command.

```

                                Copy From PC Document (CPYFRMPCD)
Type choices, press Enter.
From folder . . . . . FROMFLR resource
To file . . . . . TOFILE tempf
Library . . . . .           qtemp
From document . . . . . FROMDOC newimg.psg
To member . . . . . TOMBR *FIRST
Replace or add records . . . . MBROPT *REPLACE
Translate table . . . . . TRNTBL *none
Library . . . . .           *notext
Format of PC data . . . . . TRNFMT
                                                    Bottom
F3=Exit F4=Prompt F5=Refresh F12=Cancel F13=How to use this display
F24=More keys

```

Figure 119. Copy Page Segment to Temporary File

3. Create the page segment by using the CRTPAGSEG command.

```

                                Create Page Segment (CRTPAGSEG)
Type choices, press Enter.
Page segment . . . . . PAGSEG newimg
Library . . . . .           *CURLIB
File . . . . . FILE tempf
Library . . . . .           qtemp
Member . . . . . MBR *PAGSEG
Text 'description' . . . . . TEXT 'New Page Segment'
                                                    Bottom
F3=Exit F4=Prompt F5=Refresh F10=Additional parameters F12=Cancel
F13=How to use this display F24=More keys

```

Figure 120. Create Page Segment (CRTPAGSEG) panel

Fill in the fields as as shown in the panel above to create an iSeries page segment.

You can automate the above process by using the SEGMENT command. Refer to the *iSeries Guide to Advanced Function Presentation and Print Services Facility* for details.



---

## Appendix E. Rotation Hints

---

### Methods of Rotating Text Data

Figure 121 shows the methods in which text data can be rotated.

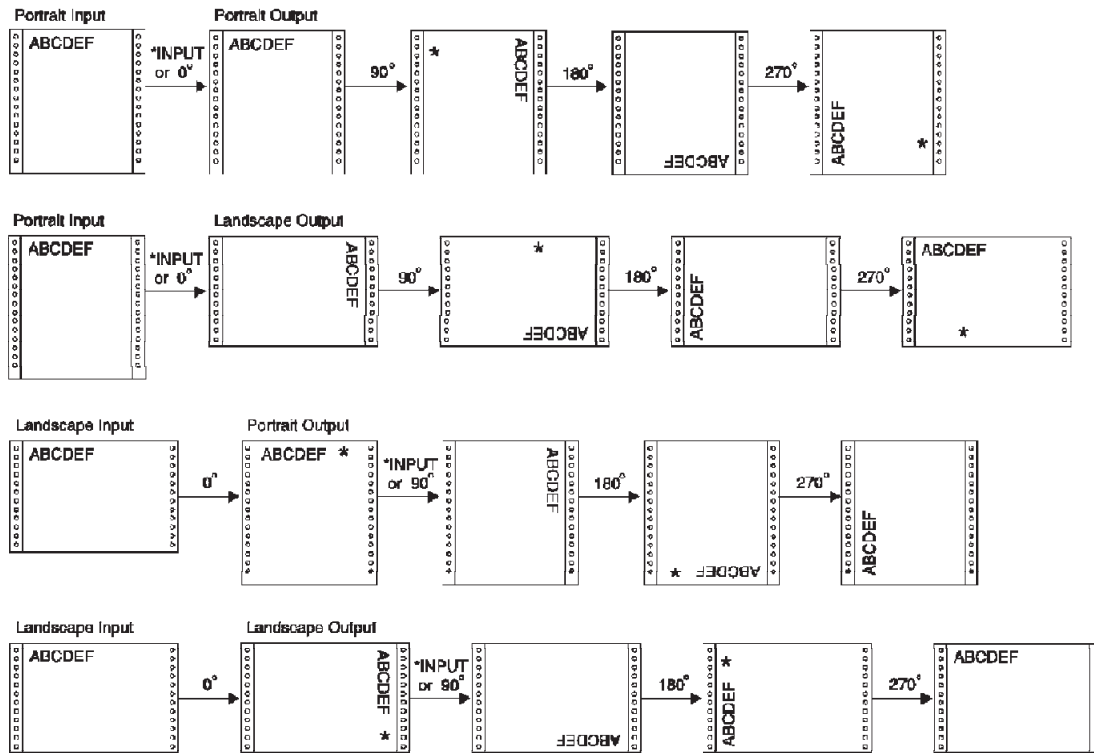

Figure 121. Rotation Hints

**Note:** Asterisks in the figure above indicate where text can be truncated on certain rotated pages if page length or page width values are not considered. Text can always be truncated on all output pages if line increment values force data to be greater than the page length.

---

### General Rules

The general rules APU follows when rotating data are:

1. APU always attempts to create output in Portrait mode and attempts rotation based upon the page length and page width (orientation) of the original selected sample spool file.
2. When overriding input or default rotation values, use the following guidelines to avoid text truncation or object positioning problems.
  - Specifying a rotation of 0 or 180 degrees, ensure the page length value is greater than the page width value.

- Specifying a rotation of 90 or 270 degrees, ensure the page width value is greater than the page length value.

---

## Appendix F. Font Samples

This appendix presents a sampling of various fonts provided by IBM.

---

### Times New Roman Medium

FONT NAME	Point Size	Character Set
Times New Roman Medium 6pt	6	CON20060
Times New Roman Medium 7pt	7	CON20070
Times New Roman Medium 8pt	8	CON20080
Times New Roman Medium 9pt	9	CON20090
Times New Roman Medium 10pt	10	CON20000
Times New Roman Medium 11pt	11	CON200A0
Times New Roman Medium 12pt	12	CON200B0
Times New Roman Medium 14pt	14	CON200D0
Times New Roman Medium 16pt	16	CON200F0
Times New Roman Medium 18pt	18	CON200H0
Times New Roman Medium 20pt	20	CON200J0
Times New Roman Medium 24pt	24	CON200N0
Times New Roman Medium 30pt	30	CON200T0
Times New Rom Med 36pt	36	CON200Z0

Figure 122. Times New Roman Medium

**Note:** The outline font is CZN200.

---

## Helvetica Roman Bold

FONT NAME	Point Size	Character Set
Helvetica Roman Bold 6pt	6	C0H40060
Helvetica Roman Bold 7pt	7	C0H40070
Helvetica Roman Bold 8pt	8	C0H40080
Helvetica Roman Bold 9pt	9	C0H40090
Helvetica Roman Bold 10pt	10	C0H40000
Helvetica Roman Bold 11pt	11	C0H400A0
Helvetica Roman Bold 12pt	12	C0H400B0
Helvetica Roman Bold 14pt	14	C0H400D0
Helvetica Roman Bold 16pt	16	C0H400F0
Helvetica Roman Bold 18pt	18	C0H400H0
Helvetica Roman Bold 20pt	20	C0H400J0
Helvetica Roman Bold 24pt	24	C0H400N0
Helvetica Roman Bold 30pt	30	C0H400T0
Helvetica Rom Bld 36pt	36	C0H400Z0

Figure 123. Helvetica Roman Bold

**Note:** The outline font is CZH400.



---

## Courier

FONT NAME	Point Size	Character Set
Courier Roman Medium 7pt	7	C0420070
Courier Roman Medium 8pt	8	C0420080
Courier Roman Medium 10pt	10	C0420000
Courier Roman Medium 12pt	12	C04200B0
Courier Roman Medium 14pt	14	C04200D0
<b>Courier Roman Medium 20pt</b>	20	C04200J0
<b>Courier Roman Bold 7pt</b>	7	C0440070
<b>Courier Roman Bold 8pt</b>	8	C0440080
<b>Courier Roman Bold 10pt</b>	10	C0440000
<b>Courier Roman Bold 12pt</b>	12	C04400B0
<b>Courier Roman Bold 14pt</b>	14	C04400D0
<b>Courier Roman Bold 20pt</b>	20	C04400J0
<i>Courier Italic 7pt</i>	7	C0430070
<i>Courier Italic 8pt</i>	8	C0430080
<i>Courier Italic 10pt</i>	10	C0430000
<i>Courier Italic 12pt</i>	12	C04300B0
<i>Courier Italic 14pt</i>	14	C04300D0
<i>Courier Italic 20pt</i>	20	C04300J0
<b><i>Courier Italic Bold 7pt</i></b>	7	C0450070
<b><i>Courier Italic Bold 8pt</i></b>	8	C0450080
<b><i>Courier Italic Bold 10pt</i></b>	10	C0450000
<b><i>Courier Italic Bold 12pt</i></b>	12	C04500B0
<b><i>Courier Italic Bold 14pt</i></b>	14	C04500D0
<b><i>Courier Italic Bold 20pt</i></b>	20	C04500J0

Figure 124. Courier Font Samples

**Note:** The outline font is CZ4200, CZ4300, CZ4400, or CZ4500.



---

## Glossary

### A

**ACIE.** AFP Conversion and Indexing Facility. An AFP program you can use to convert a print file into a MO:DCA-P document, to retrieve resources used by the document, and to index the file for later retrieval and viewing.

**addressable point.** Any point in a presentation surface that can be identified by a coordinate from the coordinate system of the presentation medium. See also pel.

**Advanced Function Presentation (AFP).** A set of licensed programs that use the all-points-addressable concept to print data on a wide variety of printers or display data on a variety of display devices. AFP also includes creating, formatting, archiving, viewing, retrieving, and distributing information.

**Advanced Function Presentation data stream.** A presentation data stream that is processed in the AFP environment. MO:DCA-P is the strategic AFP interchange data stream. IPDS is the strategic AFP printer data stream.

**Advanced Function Printing Utilities for iSeries (AFP Utilities).** An IBM licensed program that includes a group of utilities that work together to provide Advanced Function Printing on iSeries.

**Advanced Print Utility (APU).** Part of the AFP PrintSuite family of application enablers that allow end-users to migrate existing application to advanced electronic documents.

**AFP.** Advanced Function Presentation.

**AFP API.** Advanced Function Presentation Application Programming Interface

**AFPDS.** A synonym for the composed page, MO:DCA-P-based data stream interchanged in AFP environments.

**AFP Utilities for iSeries (AFP Utilities).** Advanced Function Printing Utilities for iSeries (AFP Utilities)

**AFP Workbench for Windows.** A platform for the integration of AFP enabling applications and services. The Viewer application is a Workbench application that runs under WIN-OS/2 or Microsoft Windows.

**all-points addressable (APA).** The capability to address, reference, and position text, overlays, and images at any defined point (pel) on the printable area of the paper. See page mode.

**American National Standard Code for Information Interchange.** A standard code, using a coded character set consisting of 7-bit coded characters (8-bits, including the parity check), that is used for information interchange among data processing systems, data communication systems, and their associated equipment. The ASCII set consists of control characters and graphic characters.

**APA.** All points addressable.

**APA printers.** Devices that are all points addressable; in other words, devices that print with picture elements on the printing medium at any valid location on a sheet of paper.

**application program.** A program written for or by a user that applies to the user's work, such as a program that does inventory control or payroll.

**application programmer.** A programmer who is responsible for writing programs for specific applications. The application programmer takes application data and writes programs to print it on line and AFP printers.

**Application System/400.** The hardware on which the OS/400 operating system runs.

**APU.** Advanced Print Utility

**APU Monitor.** A program that, when processed, applies print definitions to selected spooled files so that the spooled files are automatically converted to AFP printer files.

**architecture.** The set of rules and conventions that govern the creation and control of data types such as text, image, graphics, font, fax, color, audio, bar code, and multimedia.

**ASCII.** American National Standard Code for Information Interchange

### B

**bar code.** A code representing characters by sets of parallel bars of varying thickness and separation that are read optically by transverse scanning.

**baseline.** In a font, the imaginary line on which successive characters are aligned in the inline direction.

**batch.** (1) A group of records or data processing jobs that are brought together for processing or transmission. (2) Pertaining to activity involving little or no user action. Contrast with interactive.

**batch environment.** The environment in which noninteractive programs are run. The environment schedules their processing independently of their submitter. Contrast with interactive environment.

**Bar Code Object Content Architecture (BCOCA).**

## C

**character.** (1) A symbol that is used in printing. For example, a letter of the alphabet, a numeral, a punctuation mark or any other symbol that represents information. (2) A byte of data.

**character graphic.** The visual representation of a character, defined by toned or untoned picture elements (pels). An untoned pel (a reverse character) is visually represented by the toned pels around it.

**character increment.** The distance the current print position is increased by printing the current character graphic.

**character rotation.** The alignment of a character relative to the baseline that is measured in degrees in a clockwise direction. Examples are 0°, 90°, 180°, and 270°.

**code page.** A font component that associates code points and character identifiers. A code page also identifies how undefined code points are handled.

**code point.** A 1-byte code that represents one of 256 potential characters.

**continuous-forms paper.** A series of connected forms that feed continuously through a printer. The connection between the sheets is perforated to allow the user to tear them apart. Before printing, the sheets are folded in a stacked arrangement, with the folds along the perforations. (Note that some continuous forms are in rolls and are not folded.) Contrast with cut-sheet paper.

**copy.** The specification level of an APU print definition where most layout work, such as specifying page layout options, selecting and placing images, and defining constants and boxes, is done.

**cut-sheet paper.** Paper that is cut into separate sheets before being printed on. Contrast with continuous-forms paper.

## D

**database.** A set of data, part or the whole of another set of data that consists of at least one file, and that is sufficient for a given purpose or for a given data-processing system.

**DDS.** Data Description Specifications

**data set.** Synonym for file.

**data stream.** (1) All data transmitted through a data channel in a single read or write operation. (2) A continuous stream of data elements being transmitted, or intended for transmission, in character or binary-digit form, using a defined format. (3) Records sent to PSF from the spooled files and the resource libraries.

**direction.** The print position of data on a logical page, line, or field. The ultimate reference point for all direction controls on a page is the hardware origin. Secondary and tertiary reference points are possible as well, allowing more than one print direction on a page.

**duplex printing.** Pertaining to printing on both sides of a sheet of paper. Contrast with simplex printing.

## E

**electronic overlay.** Synonym for overlay.

**external formatting.** Controls for the placement of data on the page that are embedded outside the actual application program.

## F

**field.** In a record, a specified area used for a particular class of data; for example, a group of character positions that are used to enter or display wage rates on a screen.

**font.** A family or assortment of characters of a given size and style; for example, 9-point Sonoran Serif roman medium.

**font administrator.** A person who is responsible for installing and maintaining the fonts that are stored in computer resource libraries.

**font metrics.** Measurement information that defines individual character values such as height, width, and space as well as overall font values such as the average and maximum heights and widths of characters. Font metrics can be expressed in specified fixed units, such as pels, or in relative units that are independent of both the resolution and size of the font.

**form.** (1) The paper on which output data is printed by a line printer or a page printer. (2) A physical sheet of paper. See preprinted form.

**form definition.** A resource that defines the characteristics of the form which include overlays to be used (if any), text suppression, the position of page data on the form, and the number and modifications of a page. Contrast with page definition.

**format.** (1) A specified arrangement of such things as characters, fields, and lines, that are usually used for

displays, printouts, or files. (2) To arrange such things as characters, fields, and lines. (3) (v.) To prepare a document for printing in a specified format.

**formatter.** A computer program that prepares a source document for printing.

**forms designer.** A person who is responsible for designing electronic or preprinted forms that are readable, usable, and attractive. The forms designer usually has training in graphics design and in the presentation of information.

## G

**GDDM.** Graphical Data Display Manager. An IBM licensed program containing utilities for creating, saving, editing, and displaying visual data such as page segments, charts, images, vector graphics, composites (of text, graphics, and images), and scanned data.

**graphic.** Image, text, or a combination of both that can be placed on the printed page.

**graphics designer.** A person who is responsible for the design and appearance of graphics used in a company's documents. The graphics designer has experience in graphics design as well as in using computers to create graphics.

## H

**host-based computer.** (1) In a computer network, a computer that provides end users with services such as computation and databases and that usually performs network control functions. (2) The primary or controlling computer in a multiple-computer installation.

**human readable information (HRI).** Symbols that can be understood by humans, as distinct from those that cannot (such as bar codes).

## I

**image.** A pattern of toned and untoned pels that form a picture.

**impact printer.** A device in which printing results from mechanical impacts. Contrast with nonimpact printer.

**index.** (1) A process of segmenting a spooled file into uniquely identifiable groups of pages (a named collection of sequential pages) for later retrieval. (2) A process of matching reference points within a file and creating structured field tags within the MO:DCA-P document and the separate index object file.

**interactive.** Pertaining to an application in which entries call forth a response from a system or program,

as in an inquiry system. An interactive system might also be conversational, implying a continuous dialog between the user and the system. Interactive systems are usually communicated with through terminals, and respond immediately to commands.

## L

**LAN.** Local area network

**LAN administrator.** A person responsible for installing, configuring, and maintaining Local Area Networks on which are installed workstations and printers.

**library.** A file or a set of related files; for example, a page definition library that contains one or more page definition files.

**licensed program.** A utility that performs a function for the user and usually interacts with and relies on system control programming or some other IBM-provided control program. A licensed program contains logic related to the user's data and is usable or adaptable to meet specific requirements.

**line data.** Data prepared for printing on a line printer such as an IBM 3800 Model 1 Printing Subsystem. Line data is usually characterized by carriage-control characters and table reference characters. Contrast with MO:DCA-P data.

**line-data print file.** A file that consists of line data, optionally supplemented by a limited set of structured fields.

**line printer.** A device that prints a line of characters as a unit.

**lines per inch (lpi).** (1) A unit of measurement for the specification of baseline placement. (2) A measure of the number of lines per vertical inch of paper.

**logical page.** A presentation space. One or more object areas or data blocks can be mapped to a logical page. A logical page has specifiable characteristics, such as size, shape, orientation, and offset and is rectangular in shape. Orientation and offset are specified relative to a medium coordinate system.

**lpi.** Lines per inch.

## M

**magnetic ink character recognition (MICR).** Recognition of characters printed with ink that contains particles of a magnetic material.

**metafile format.** OS/2 graphics data that is produced by Presentation Manager applications such as IBM CAD, CorelDRAW, or Aldus Pagemaker.

**MICR.** Magnetic ink character recognition.

**Mixed Object Document Content Architecture (MO:DCA-P).** A strategic, architected, device-independent data stream for interchanging documents.

**mixed-pitch font.** A font that simulates a proportionally spaced font. The characters are in a limited set of pitches (for example, 10 pitch, 12 pitch, and 15 pitch).

**monospaced font.** A font in which the graphic characters have a uniform character increment. Synonymous with uniformly spaced font. Contrast with proportionally spaced font.

**multiple-up printing.** The printing of more than one page on a single surface of a sheet of paper.

## N

**nonimpact printer.** A device in which printing is not the result of mechanical impacts; for example, heat—sensitive printers, electrostatic printers, photographic printers. Contrast with impact printer.

## O

**object format.** The format of AFP resources required for use by PSF. Contrast with source format.

**offset stacking.** A function that allows the printed output pages to be offset for easy separation of the print jobs.

**Operating System/2 (OS/2).** An IBM licensed program that can be used as the operating system for the PS/2 processor series.

**Operating System/400 (OS/400).** An IBM licensed program that can be used as the operating system for the iSeries processor series.

**orientation.** (1) The angle between the top or bottom edge of the page and the baselines within a column that is measured in a clockwise direction. (2) The rotation of an element relative to a fixed reference.

**outline font.** A font whose graphic character shapes are defined mathematically rather than by raster patterns.

**output device.** A machine used to print, display, or store the result of data processing.

**overlay.** A resource that can contain text, image, graphics, and bar code data. An overlay is electronically created in the host processor, stored in a library, and can be merged electronically with variable data on a sheet during printing. See also preprinted form and forms flash.

**Overlay Generation Language/370 (OGL/370).** An IBM licensed program used to create overlays.

## P

**page.** A collection of data that can be printed on a physical sheet of paper.

**page definition.** A resource that contains a set of formatting controls for printing logical pages of data. Includes controls for number of lines per printed sheet, font selection, print direction, and mapping individual fields in the data to positions on the printed sheets.

**page format.** (1) A subset of a page definition that contains controls governing the arrangement of text on a page. (2) In APU, the object that contains all of the instructions for formatting a print job. A print definition can name one or more page formats.

**page mode.** The mode of operation in which the printer can accept a page of data at a time from a host processor to be printed on an all-points addressable output device. Data may consist of pages that are composed of text, images, overlays, or page segments.

**page printer.** Any of a class of printers that accepts MO:DCA-P pages, constructed of composed text and images, among other things. Contrast with line printer.

**Page Printer Formatting Aid.** An IBM licensed program that you can use to create and store form definitions and page definitions.

**page segment.** A resource that contains composed text and images, prepared before formatting and included during printing.

**pel.** The smallest area that can be individually toned on a printing medium or on a display surface.

**pel density.** The number of pels per unit of linear measurement.

**physical page.** The side of a sheet of paper that is to be printed on.

**pica.** A unit of about 1/6 inch used in measuring typographical material.

**picture element.** An element of a raster pattern about which a toned area on the photoconductor might appear. See also raster pattern. Synonym for pel.

**pitch.** A unit of measurement for the width of a printed character, reflecting the number of times a graphic character can be set in 1 linear inch; for example, 10-pitch has 10 graphic characters per inch. Uniformly spaced fonts are measured in pitch. Contrast with point.

**plotter.** An output unit that presents data in the form of a two-dimensional graphic representation.

**point.** In printing, a unit of about 1/72 of an inch used in measuring typographical material. Each pica contains 12 points.

**point size.** The height of a font in points.

**postprocessing option.** A hardware device that attaches to the output side of a printer; for example, an envelope stuffer, binder, or stapler.

**PostScript.** A page description language with interactive graphics capabilities that was developed by Adobe Systems, Incorporated.

**preprinted form.** A sheet of paper that contains a preprinted design of constant data. Variable data can be merged on such a form.

**preprocessing option.** A hardware device that attaches to the input side of a printer; for example, a paper-roll feed or multiple input bins.

**print data set.** Synonym for print file.

**print definition.** Contains instructions for transforming simple SCS print output to advanced AFP output. A print definition includes the specifications for remapping existing print data, defining and creating different page formats and copies, and adding document elements such as overlays, images, fonts, bar codes, and constants.

**print file.** A file created by an application program that contains the actual information to be printed and some of the data that controls the format of the printing. Print files can contain MO:DCA-P data, line data, or a combination of MO:DCA-P and line data.

**print job.** The data to be printed that is submitted to Print Services Facility by the user.

**Print Services Facility (PSF).** An IBM licensed program that produces printer commands from the data sent to it.

**printer driver.** A program that passes commands and resources with a data stream from the system spool to tell the printer how to print the page.

**proportionally spaced font.** A font in which the characters have different character increments. Graphic character widths vary with the size of each graphic character. This allows for even spacing between printed characters and eliminates excess space around narrow characters, such as the letter i. Contrast with uniformly spaced font.

## R

**raster font.** (1) A font created by a series of pels (picture elements) arranged in scan lines to form an image. (2) A font in which the characters are defined directly by the raster bit map.

**raster graphics.** Computer graphics in which a display image is composed of an array of picture elements (pels) arranged in rows and columns. Contrast with vector graphics.

**raster pattern.** A series of picture elements (pels) in scan lines to form an image. See also page segment.

**record.** A collection of related data or words, treated as a unit; for example, in stock control, each invoice could constitute one record.

**remote printer.** A device that prints in a location away from the centralized data processing center.

**resource.** A collection of printing instructions and sometimes data to be printed consisting entirely of structured fields. A resource can be stored as a member of a library and can be called for by Print Services Facility when needed. Coded fonts, font character sets, code pages, page segments, overlays, form definitions, and page definitions are all resources.

**resource library.** (1) A collection of related files. (2) A place to store resources such as form definitions, page definitions, page segments, fonts, and overlays.

**rotation.** The number of degrees a character is rotated relative to the print direction. One of four directions that define the orientation of text relative to a sheet, page, overlay, text block, or page segment.

## S

**scanner.** A device that examines a spatial pattern one part after another and generates analog or digital signals corresponding to the pattern. Scanners are often used in mark sensing, pattern recognition, or character recognition.

**SCS.** See SNA character string (SCS)

**segment.** See page segment.

**simplex printing.** Printing on only one side of the paper. Contrast with duplex printing.

**SNA.** Systems Network Architecture (SNA)

**SNA character string (SCS).** In SNA, a data stream composed of EBCDIC controls, optionally intermixed with end-user data, that is carried within a request/response unit.

**software.** Programs, procedures, rules, and any associated documentation pertaining to the operation of a system. Contrast with hardware.

**source format.** The format of an AFP resource, other than fonts, used by AFP resource management programs. Contrast with object format.

**spooling (simultaneous peripheral operation online).** (1) The use of auxiliary storage as a buffer storage to reduce processing delays when transferring data between peripheral equipment and the processors of a computer. (2) The reading of input data streams and the writing of output data streams on auxiliary storage devices, concurrently with job execution, in a format convenient for later processing or output operations.

**syntax.** The rules and keywords that govern the use of a programming language.

**system printer.** The printer that is used for any printed output that is not specifically directed to another printer.

**system programmer.** A programmer who is responsible for writing programs for the functions of the computer operating system and who has a thorough knowledge of the operating system. The system programmer installs and maintains AFP software in the System/390 environment.

**Systems Network Architecture (SNA).** In IBM networks, the description of the layered logical structure, formats, protocols, and operational sequences that are used for transmitting information units through networks, as well as controlling the configuration and operation of networks.

## T

**terminal.** A device that is usually equipped with a keyboard and some kind of display, capable of sending and receiving information over a communication channel.

**text.** A graphic representation of information on an output medium. Text consists of alphanumeric characters and symbols that are arranged in paragraphs, tables, columns, or other shapes.

**text-formatting program.** A program that determines the manner in which data will be placed on a page.

**text orientation.** A description of the appearance of text as a combination of inline and baseline directions and character rotation.

**Transmission Control Protocol/Internet Protocol (TCP/IP).** A set of communications protocols that support peer-to-peer connectivity functions for both local and wide area networks.

**type family.** A collection of fonts of a common type face that vary in size and style.

**type font.** Type of a given size and style; for example, 10-point Sonoran Serif roman medium.

**type face.** A collection of fonts all having the same style, weight, and width; each font differs from the others by point size or type family.

**typographic font.** A typeface originally designed for typesetting systems. Contrast with mixed-pitch font, uniformly spaced font. Synonym for proportionally spaced font.

## U

**underscore.** A line printed under a character. To underline.

**uniformly spaced font.** A font in which the characters have the same character increment. Synonymous with monospaced fonts. Contrast with proportionally spaced font and typographic font.

## V

**variable data.** (1) In programming languages, a language object that may take different values, one at a time. The values of a variable are usually restricted to a certain data type. (2) A quantity that can assume any of a given set of values. (3) Used to represent a data item whose value can be changed while the program is running. Contrast with constant data.

**vector.** In computer graphics, a directed line segment.

**vector graphics.** Computer graphics in which display images are generated from display commands and coordinate data. Contrast with raster graphics.

## W

**word processing.** The entry, modification, formatting, display, and printing of text on personal computers, microprocessors, and stand-alone word processors.



---

## Notices

References in this publication to products or services of IBM do not suggest or imply that IBM will make them available in all countries where IBM does business or that only products or services of IBM may be used. Noninfringing equivalents may be substituted, but the user must verify that such substitutes, unless expressly designated by IBM, work correctly. No license, expressed or implied, to patents or copyrights of IBM is granted by furnishing this document. You can send license inquiries, in writing, to the IBM Director of Licensing, IBM Corporation, 500 Columbus Avenue, Thornwood, NY 10594, USA.

Licensees of this program who wish to have information about it for the purpose of enabling: (1) the exchange of information between independently created programs and other programs (including this one) and (2) the mutual use of the information, which has been exchanged, should contact: IBM Corporation, Printing Systems Company Legal Department, Mail Drop 002S, Boulder, Colorado 80301 USA. Such information may be available, subject to appropriate terms and conditions, including in some cases, payment of a fee.

---

## Trademarks

This publication uses the following terms that are trademarks or registered trademarks of the IBM Corporation:

- Advanced Function Presentation
- AFP
- AFP Printer Driver for Windows
- AFP Utilities for iSeriesAFP Workbench
- iSeries
- BCOCA
- Client Access for iSeries
- IBM
- Intelligent Printer Data Stream
- IPDS
- MO:DCA-P
- Operating System/2
- OS/400
- Print Services Facility for AIX
- Print Services Facility for OS/2
- Print Services Facility for iSeries
- PrintSuite for iSeries
- PrintManager
- PSF/2
- PSF for iSeries
- PSF for AIX

The following terms are trademarks of other companies as listed:

- Adobe and Type 1 are trademarks of Adobe Systems, Inc.
- Elixir is a trademark of Elixir Technologies Corporation.
- ISIS is a trademark of ISIS Holding AG.
- PCL, HP-PCL, and Hewlett-Packard are trademarks of Hewlett-Packard Corporation.
- Windows is a trademark of Microsoft Corporation.



---

# Index

## A

- accessing APU 16
- Actions, Monitor
  - action for input spooled file 83
  - action for output spooled file 83
  - creating 89
  - creating groups 89
  - for output file 92
  - for print engine 89
  - how they are processed 83
  - input spooled file for 91
  - selection for input spooled file 83
  - setting up 89
  - types of 90
- Adobe Type 1, type transformer for 21
- AFP
  - advantages of 4
  - Font Collection 13
  - optional utilities for APU 13
  - Overlay Utility for APU 13
  - Print Format Utility for APU 13
  - Printer Driver for Windows 29
  - printing with 5
  - printing without 4
  - Resource Management Utility for APU 13
  - resources
    - commands 115
    - creating font 115
    - creating overlay 116
    - creating page segment 117
    - image 24
    - image, building 26
    - locating required 9
    - overlay 26
    - viewing AFP documents from windows 13
- AFP Utilities for iSeries
  - components 13
- APU defaults 111
- APU Monitor
  - actions to perform 89
  - benefits of the new monitor 83
  - Configure APU Monitor Action 89
  - configuring 87
  - creating action group entry 89
  - defining action for input spooled file 92
  - defining action for output spooled file 94
  - example of processing 84
  - how the monitor works 83
  - how used by APU 79
  - how uses formatting instructions 6
  - introduction to 83
  - printing with 83
  - processing sequence 84
  - putting print definitions into production with 11
  - queues to monitor 88
  - queues, adding 88

- APU Monitor (*continued*)
  - restrictions on the old monitor 83
  - selecting input spooled file with 90
  - setting up 89
  - starting 97
  - stopping 98
  - the output queue after monitor processing 86
  - user exits for 103
  - using with Host Print Transform 6
  - what it does 6
- APU, accessing 16
- APYPRDEF 82, 103, 111

## B

- back overlay 43
- bar code resources 29
- bar codes
  - BCOCA architecture for 46
  - Code 3 of 9 30
  - how APU works with 30
  - mapping in print definition 64
  - POSTNET (Postal Bar Code) 30
  - rotating 30
  - specifying in print definitions 64
- building image resources 26

## C

- commands
  - APYPRDEF 79, 80, 81, 82, 103, 111
  - APYPRDEF, exit points 106
  - CPYFRMPCD 115, 116, 118
  - CPYSPLF, restrictions on 9
  - CRTFNTRSC 116
  - CRTOVL 117
  - CRTPAGSEG 118
  - CRTPF 115, 116, 117
  - for AFP resources 115
  - OVERLAY 117
  - PRTAFPDATA 105
  - SEGMENT 119
- conditional overlay use in APU 27
- constant data 66, 112
- constant data, tricks for using 112
- control language program for user exits 106
- copies
  - building initial copy for page format one 55
  - continuation page 55
  - continuation pages 71
  - creating for single-page formats 40
  - defining 10
  - each can be different 7
  - making multiple 6
  - replicating 69
  - working with 60
- CPYFRMPCD 115, 116, 118

- CPYSPLF command, restrictions on 9
- CPYSPLF print engine processing phase 103
- CRTFNTRSC 116
- CRTOVL 117
- CRTPAGSEG 118
- CRTPF 115, 116, 117
- custom fonts 21

## D

- data
  - mapping 45
  - mapping, suggestions 112
- defaults for APU 111
- document creation
  - analyze existing application 8
  - design phase 5
  - locate required AFP resources 9
  - printing a print definition 10
  - production phase 6
  - resource requirements 16
  - steps involved 7
  - using APU to create print definition 9
- document resources
  - image 24
  - image, building 26
  - overlay 26
  - overview 16
- duplex printing 42, 62
- duplex printing restrictions 42, 62
- duplex printing, hints 113

## E

- electronic forms
  - defining for print definition 44
  - elements 26
  - options for building 29
  - specifying back 62
  - specifying in print definitions 68
- ELIXIR 29
- exits, print options for user 95
- exits, processing phases for user 103
- exits, user 95, 103
- EXTAFT print engine processing phase 103, 105
- EXTBEF print engine processing phase 103
- EXTMID print engine processing phase 103, 104

## F

- Fast Path
  - for simple applications 3, 10
- field mapping 48
- fields
  - defining 46

- fields (*continued*)
  - defining selection 59
  - editing 48
  - for user exits 81
  - four options for mapping 46
  - mapping 46, 63
  - mapping as text 47
  - mapping at multiple locations 49
  - mapping restrictions 50
  - mapping the first time 49
  - mapping to a second position 50
  - naming 60
  - page numbering 59
  - positioning 46, 47
  - repeat mapping 48
- fields, leaving as is 46
- fields, suppressing 46
- font libraries
  - adding 16
- font samples 123
  - Courier 125
  - examples of 123
  - Helvetica Roman Bold 124
  - Times New Roman Medium 123
- fonts
  - custom 21
  - downloading outline 20
  - HELVETICA for bar codes 47
  - installation considerations 16
  - outline 20
  - required for APU 13
  - samples of 123
  - specifying in print definitions 66
  - using with APU 18
- fonts, Adobe Type 1 21
- fonts, display details of 22
- formats, multiple page 7
- formatting instructions for APU 6

## G

- GENAFP print engine processing
  - phase 103

## H

- Host Print Transform, for HP-PCL 6, 13
- HP-PCL, printing APU output on 6
- HP-PCL, printing with Host Print Transform 13

## I

- identifying resources for print definitions 36
- image resources 24
- Infoprint Designer 29
- INPACT print engine processing
  - phase 103
- input spooled file, defining actions for 91
- INZENV print engine processing
  - phase 103
- IOCA format, converting images to 26
- IOCA page segments, creating on Windows 26

- IPDS printers, and PSF for iSeries 13
- ISIS 29

## M

- mapping
  - a field at multiple locations 49
  - a field the first time 49
  - a field to a second position 50
  - bar codes 64
  - constant data 66
  - data options 46
  - field data 45
  - fields as text 47
  - mapping data as text 48
  - restrictions on 50
- multiple location field mapping 49
- multiple page formats 7

## O

- OCR-A font 47
- outline fonts 20
- output file, defining actions for 92
- OVERLAY 117
- overlay, back 43, 55
- overlay, front 55
- overlay, positioning 44, 45
- overlays
  - building 29
  - defining for print definitions 44
  - how APU works with 27
  - rotating 9
  - using conditionally in APU 27
- overlays, defining 44

## P

- page formats 112
  - defining 10
  - making multiple 7
  - need one copy 10
  - suggestions 112
  - which one to use 7
- page orientation, default 29
- page segments
  - building 26
  - creating with RMU 26
  - defining for print definition 43
  - positioning in APU documents 24
  - rotating 26
  - using printer driver for Windows 26
  - using with APU 24
- page segments, steps to create 26
- parameters
  - APYPRDEF 79
  - defining selection for input spooled file 90
  - for user exit after 105
  - for user exit before 103
  - for user exit middle 104
- positioning overlays 44
- print definitions
  - accessing function on OS/400 37
  - APUDATA, library for 14
  - associating with a spooled file 79

- print definitions (*continued*)
  - back overlays 62
  - building for single-page formats 35
  - building initial copy for page format 55
  - building multiple page formats 51
  - building multiple page print definition 54
  - continuation pages 55
  - create panel 38
  - creating headers for 38
  - defining a copy 41
  - defining overlay positioning 44
  - defining overlays for 44
  - defining page segment positioning 43
  - defining page segments for 43
  - defining selection fields 59
  - example, single page format 35
  - example, two page format 51
  - hints 111
  - mapping bar codes 64
  - mapping fields at multiple locations 49
  - mapping print data 45
  - multiple field mapping restrictions 50
  - multiple location field mapping 49
  - repeat field mapping 48
  - set attributes 39
  - specifying constant data 66
  - specifying fonts in 66
  - specifying page layout 42
  - suppressing data in 70
  - using with apply command 82
  - work with copies 40
- print engine phases
  - after phase 105
  - CPYSPLF 103
  - defining actions to 94
  - EXTAFT 103
  - EXTAFT phase 105
  - EXTBEF 103
  - EXTBEF phase 103
  - EXTMID 103
  - EXTMID phase 104
  - GENAFP 103
  - INPACT 103
  - INZENV 103
  - middle phase 104
  - phases for user exits 103
  - processing phases 103
  - PRTAFP phase 105
  - PRTAFPDTA 103
  - user exit processing 103
- print options for user exits 95
- printing
  - with a print definition 10
  - with and without APU 4
  - with APU 79
- processing phases of print engine 103
- PRTAFPDTA print engine processing phase 103
- PSF for iSeries, required for IPDS 13

## Q

- queues to monitor 88
- QYPUEXTSMP, exit program for  
APYPRTDEF 106
- QYPUSYNC program  
used to add font libraries 16

## R

- resources, identifying 55
- RMU, creating page segments with 26
- rotating
  - bar codes 30
  - page segments 26
  - pages 14
  - pages in a print definition 58
- rotating pages 29
- rotating text 26
- rotating text data 121
- rotating text data, hints for 121

## S

- scalable fonts 20
- SCS files
  - as output of iSeries 3
  - file to be transformed by APU 35
  - how APU Monitor works with 89
  - remapping fields in 3
  - restrictions on spooled files 9
  - select spooled file for APU  
Monitor 90
  - selecting file to be transformed by  
APU 57
  - specifying file to be transformed by  
APU 39
  - transformed by APU into AFP 3
  - using interactively 3
  - what APU works on 3
  - what it is 3
- spooled files
  - associating a print definition with 79
  - define action for input 92
  - defining action for output 94
  - selecting a sample 42
  - selecting input file 90
- suppressing data 46, 48, 49, 55, 69, 70

## T

- Transform for iSeries 29
- Type Transformer
  - convert Adobe Type 1 fonts 21
- type transformer, for Adobe fonts 21

## U

- user exit
  - before phase 103
  - control language program example  
for 106
  - CPYSPL phase 104
  - for APU Monitor 103
  - parameters for user exit after 105
  - parameters for user exit before 103

- user exit (*continued*)
  - parameters for user exit middle 104
  - print options 95
- user exits 103
- user exits, processing phases for 103
- using APU to create a print definition 9

## W

- Windows
  - AFP Printer Driver for 29
  - AFP Workbench 13
  - creating page segments from 26
  - printer driver for 14
  - rotating page segments with 26
  - viewing AFP documents from 13
- working with image resources 24



---

## Readers' Comments — We'd Like to Hear from You

PrintSuite for iSeries  
Advanced Print Utility  
User's Guide

Publication No. S544-5351-03

Overall, how satisfied are you with the information in this book?

	Very Satisfied	Satisfied	Neutral	Dissatisfied	Very Dissatisfied
Overall satisfaction	<input type="checkbox"/>	<input type="checkbox"/>	<input type="checkbox"/>	<input type="checkbox"/>	<input type="checkbox"/>

How satisfied are you that the information in this book is:

	Very Satisfied	Satisfied	Neutral	Dissatisfied	Very Dissatisfied
Accurate	<input type="checkbox"/>	<input type="checkbox"/>	<input type="checkbox"/>	<input type="checkbox"/>	<input type="checkbox"/>
Complete	<input type="checkbox"/>	<input type="checkbox"/>	<input type="checkbox"/>	<input type="checkbox"/>	<input type="checkbox"/>
Easy to find	<input type="checkbox"/>	<input type="checkbox"/>	<input type="checkbox"/>	<input type="checkbox"/>	<input type="checkbox"/>
Easy to understand	<input type="checkbox"/>	<input type="checkbox"/>	<input type="checkbox"/>	<input type="checkbox"/>	<input type="checkbox"/>
Well organized	<input type="checkbox"/>	<input type="checkbox"/>	<input type="checkbox"/>	<input type="checkbox"/>	<input type="checkbox"/>
Applicable to your tasks	<input type="checkbox"/>	<input type="checkbox"/>	<input type="checkbox"/>	<input type="checkbox"/>	<input type="checkbox"/>

Please tell us how we can improve this book:

Thank you for your responses. May we contact you?  Yes  No

When you send comments to IBM, you grant IBM a nonexclusive right to use or distribute your comments in any way it believes appropriate without incurring any obligation to you.

---

Name

---

Address

---

Company or Organization

---

Phone No.



Fold and Tape

Please do not staple

Fold and Tape



NO POSTAGE  
NECESSARY  
IF MAILED IN THE  
UNITED STATES

# BUSINESS REPLY MAIL

FIRST-CLASS MAIL PERMIT NO. 40 ARMONK, NEW YORK

POSTAGE WILL BE PAID BY ADDRESSEE

IBM Corporation  
Information Development  
IBM Printing Systems  
Department H7FE Building 004M  
Boulder, CO or 80301-9817



Fold and Tape

Please do not staple

Fold and Tape







Program Number: 5798-AF2



Printed in the United States of America  
on recycled paper containing 10%  
recovered post-consumer fiber.

S544-5351-03

