

AS/400 Advanced Series



Internetwork Packet Exchange (IPX**) Support

Version 4

AS/400 Advanced Series



Internetwork Packet Exchange (IPX**) Support

Version 4

Note

Before using this information and the product it supports, be sure to read the general information under "Notices" on page 181.

First Edition (August 1997)

This edition applies to the licensed program IBM Operating System/400 (Program 5769-SS1), Version 4 Release 1 Modification 0, and to all subsequent releases and modifications until otherwise indicated in new editions.

Make sure that you are using the proper edition for the level of the product.

Order publications through your IBM representative or the IBM branch serving your locality. If you live in the United States, Puerto Rico, or Guam, you can order publications through the IBM Software Manufacturing Solutions at 1-800-879-2755. Publications are not stocked at the address given below.

IBM welcomes your comments. A form for readers' comments may be provided at the back of this publication. You can also mail your comments to the following address:

IBM Corporation
Attention Department 542
IDCLERK
3605 Highway 52 N
Rochester, MN 55901-7829 USA

or you can fax your comments to:

United States and Canada: 1-800-937-3430
Other countries: 1-507-253-5192

If you have access to the Internet, you can send your comments electronically to IDCLERK@RCHVMW2.VNET.IBM.COM; IBMMAIL, to [IBMMAIL\(USIB56RZ\)](mailto:IBMMAIL(USIB56RZ)).

When you send information to IBM, you grant IBM a nonexclusive right to use or distribute the information in any way it believes appropriate without incurring any obligation to you.

© **Copyright International Business Machines Corporation 1997. All rights reserved.**

Note to U.S. Government Users — Documentation related to restricted rights — Use, duplication or disclosure is subject to restrictions set forth in GSA ADP Schedule Contract with IBM Corp.

Contents

About IPX Support (SC41-5400)	ix
Who Should Read This Book	ix
Conventions and Terminology Used in This Book	ix
Task Indicator	ix
Note Indicator	x
Tip Indicator	x
Prerequisite and Related Information	x
Information Available on the World Wide Web	x
Internetwork Packet Exchange Networks and Protocols—Introduction	1
Networks	1
Internetwork Communications	2
Serving	2
What is Internetwork Packet Exchange (IPX) Support?	2
History of Internetwork Packet Exchange (IPX)	3
Introduction to IPX Protocols	3
Upper Protocol Layers	5
Simple Network Management Protocol (SNMP)	5
Sockets Interface	5
Transport Protocol Layer	7
Sequenced Packet Exchange (SPX)	7
Multiprotocol Transport Networking Architecture (MPTN)	8
Network Protocol Layer	8
Internetwork Packet Exchange (IPX) Protocol	8
Routing Information Protocol (RIP)	9
Service Advertising Protocol (SAP)	9
NetWare Link Services Protocol (NLSP)	9
Lower Layer Protocols	9
Relationship among the IPX Functions	9
IPX Network	10
IPX Node Address	11
IPX Circuit	12
Routing	12
IPX Routers	12
IPX Server	13
AS/400 IPX Internal Network	14
IPX Internal Network Number	15
NetWare on the Integrated PC Server	15
Configuring the Internetwork Packet Exchange (IPX) Support	19
Configuring IPX—Overview	21
Ethernet Network Example	23
Step 1—Creating an Internetwork Packet Exchange (IPX) Description	23
Step 2—Configuring Line Descriptions for IPX Support—Ethernet	30
Step 3—Adding an Internetwork Packet Exchange (IPX) Circuit	35
Step 4—Adding Route Information	45
Step 5—Adding Service Information	45
X.25 Network Example	45
Step 1—Creating an IPX Description—X.25	46
Step 2—Configuring a Line Description for IPX Support—X.25	46

Step 3—Adding an IPX Circuit for an X.25 SVC Line	52
Circuit Routes and Circuit Services—Overview	56
Step 4—Adding Circuit Route Information	57
Step 5—Adding Circuit Service Information	61
Sample CL Program	65
Additional IPX Configuration Options	65
Operating and Managing IPX Support	67
Starting and Ending IPX Support	67
Before You Start IPX Support	67
Starting IPX	69
Ending IPX	70
IPX Status Support	72
Work with IPX Status Menu	72
Working with IPX Circuit Status	72
Working with IPX/SPX Connection Status	81
Advanced IPX Configuration	89
Configuration for NetWare Support	89
IPX Description	89
IPX Circuit Definition	90
X.25 Network and Integrated PC Server Example	90
X.25 Network Configuration	91
Step 1—Creating an Internetwork Packet Exchange (IPX) Description	92
Performance Considerations for IPX Descriptions	93
Step 2—Configuring an X.25 Line Description for System D	95
Step 3—Adding an IPX Circuit for an X.25 SVC Line on System D	98
Step 4—Adding Circuit Route Information for System D	100
Considerations for Adding Route Information	104
Controlling NLSP Route Selection	107
IPX Support and AnyNet/400	109
IP over IPX	110
SNA over IPX	111
Configuring AnyNet/400 Support using the Configure IPX Menu	111
IP over IPX AnyNet Configuration—Overview	112
IP over IPX AnyNet Configuration-Example	112
Assumptions	113
Step 1—Configuring IPX Support	113
Step 2—Configuring the IP over IPX Interface	114
Step 3—Adding IP over IPX Routes Configuration	117
Step 4—Adding IP over IPX Addresses Configuration	117
Step 5—Allow AnyNet/400 Support for IP over IPX Support	120
Step 6—Activating the IP over IPX Support	121
Changing the IP Over IPX Configuration	121
Matching Parameters for IP over IPX Support	122
IP over IPX Common Configuration Errors	123
APPC over IPX Configuration—Overview	123
APPC over IPX Configuration-Example	124
Assumptions	124
Step 1—IPX Configuration	124
Step 2—Creating the APPC Controllers	124
Step 3—Adding Remote Locations to the APPN Remote Location Lists	127
Step 4—Adding Local Locations to the APPN Local Locations Lists	129

Step 5—Adding APPC over IPX Location Name Addressing Configuration	131
Step 6—Allow AnyNet/400 Support	134
Step 7—Activating APPC over IPX Support	134
APPC over IPX Common Configuration Errors	135
Matching Parameters	135
Appendix A. CL Program for the IPX Configuration Example	137
Appendix B. Database Files Used by IPX Support	139
Saving and Restoring Configuration Files	139
Displaying Configuration Files	140
IPX Database Files for OS/400	140
File QAZSPPADR (IP over IPX Addresses)	141
File QAZSPLOC (SNA over IPX Locations)	141
File QAZSPCCT (IPX Circuits)	142
File QAZSPRTE (IPX Routes)	143
File QAZSPSRV (IPX Circuit Services)	143
Appendix C. Security for IPX Commands and Objects	145
*IOSYSCFG Authority Required	145
Command Object Authority	145
*IOSYSCFG Authority Not Required	146
Command Object Authority	146
Object Authority Required	146
Command Object Authority	146
Appendix D. IPX Performance	149
Main Storage Pool Size	149
IPX Jobs	149
IPX Protocol Support Provided by IOP	149
Packet Rollup	150
Packet Train	150
Service Advertising Protocol (SAP) Off-load	150
Routing Information Protocol (RIP) Off-load	150
NetWare Link Services Protocol (NLSP) Off-load	151
Simple Network Management Protocol (SNMP) Support	151
Appendix E. IPX Problem Analysis	153
Working with the Job Log and Message Queues	153
Common Configuration Errors	154
Tracing IPX Protocol Layer Problems	154
Setting Up a Licensed Internal Code Trace	154
Starting Component Traces	156
SNA Over IPX Debugging Capabilities	157
Tracing SNA over IPX Problems	158
IP over IPX Debugging Capabilities	159
Additional Debugging IP over IPX Configurations Information	160
Tracing IP over IPX Problems	160
Collecting a Communications Trace	161
Planning to Set up a Trace	162
Accessing the Start Service Tool (SST) Function	163
Starting a Communications Trace	164
Stopping a Communications Trace	167
Formatting and Saving the Communications Trace	168

Verifying the Contents of the Communications Trace	168
Return Codes and Messages Issued by IPX Support	171
Alertable Messages	174
Appendix F. NetWare for SAA Product Offering	177
What is NetWare for SAA?	177
NetWare for SAA and Client Access/400	178
AS/400 Application Support	179
Notices	181
Trademarks	181
Bibliography	183
AS/400 Communications Books	183
Programming Books	183
System Books	184
Architecture Books	184
NetWare** Books	184
Other Printed Information	184
Index	187

Tables

1.	Socket Numbers	6
2.	Supported Input/Output Adapters	30
3.	Supported Input/Output Adapters for the 6506 Integrated PC Server	30
4.	Supported Input/Output Adapters—6616 Integrated PC Server	31
5.	Supported Input/Output Adapters—2850 Integrated PC Server	31
6.	Frame Type Values Allowed by Line Type	39
7.	Novell Terminology for OS/400 Frame Type Values	39
8.	Default Costs	108
9.	Physical Database Files and Record Lengths	140
10.	QAZSPPADR Member Format (IP over IPX Address Mapping Configuration Data)	141
11.	QAZSPPLC Member Format (SNA over IPX Location Name Mapping Configuration Data)	141
12.	QAZSPPCCT Member Format (IPX Circuit Configuration Data)	142
13.	QAZSPPRTE Member Format (IPX Circuit Routes Configuration Data)	143
14.	QAZSPPSRV Member Format (IPX Circuit Service Configuration Data)	143
15.	Common IP over IPX Configuration Errors	160
16.	Trace Status	166
17.	Return Codes and Associated Data Description	171
18.	Alertable Messages	174

About IPX Support (SC41-5400)

This book contains information on configuring and using the Internetwork Packet Exchange** (IPX**) support on AS/400 business computing systems. The book contains the following sections:

For beginners:

- Installing IPX support
- IPX concepts and terminology
- Configuring IPX
- Using the Work with IPX status menu to view and manage IPX routes, services, and connections

For experienced users:

- Advanced IPX configuration information
- IPX support and AnyNet/400 information
- Appendices for Security, Performance, and Problem Analysis

Who Should Read This Book

This book is intended for network administrators or managers as well as system and application programmers who need to:

- Understand IPX concepts and terminology
- Install and configure IPX support
- View and manage IPX routes, services, and connections

NetWare users of this book should become familiar with the following:

- Basic communications, which are described in the Discover/Education Introduction to Data Communications course
- AS/400 menus and commands, which are described in the *System Operation* book and the *System Operation for New Users* book.

Conventions and Terminology Used in This Book

This book includes several usability aids and conventions to help you find and identify the information you need. The following sections describe these usability aids and conventions.

Task Indicator

Many tasks provide background information to help you become familiar with the task you will perform. Following this background information, an arrow in the margin identifies where the actual steps begin. For example, the network server description section provides background information about user IDs. Following the background information, the steps begin as follows:



To create a network server description:

1. From the Configure Network Server menu, select option 1 (Create network server description).

The Create Network Server Desc (CRTNWSD) display appears.

Note Indicator

Notes provide important information that can affect the operation of the product or the completion of the task. A note is indicated by a note pad symbol next to the note as shown in the following example:



If you connect more than one cable to a single Integrated PC Server port, only the token-ring line will work.

Tip Indicator

A symbol indicates helpful information or tips that help you complete a task with fewer steps, as shown in the following example:



Use the name of your system for the IPX description name.

Prerequisite and Related Information

For information about Advanced 36 publications, see the *Advanced 36 Information Directory*, SC21-8292, in the AS/400 Softcopy Library.

For information about other AS/400 publications (except Advanced 36), see either of the following:

- The *Publications Reference*, SC41-5003, in the AS/400 Softcopy Library.
- The *AS/400 Information Directory*, SK2T-2226, a unique, multimedia interface to a searchable database that contains descriptions of titles available from IBM or from selected other publishers.

For a list of related publications, see the “Bibliography” on page 183.

Information Available on the World Wide Web

More AS/400 information is available on the World Wide Web. You can access this information from the AS/400 home page, which is at the following uniform resource locator (URL) address:

<http://www.as400.ibm.com>

Select the Information Desk, and you will be able to access a variety of AS/400 information topics from that page.

Internetwork Packet Exchange Networks and Protocols—Introduction

This chapter provides an overview of computer networks and internetworking by using the OS/400 Internetwork Packet Exchange (IPX) support that is provided on the AS/400.

You can use the following AS/400 programs over this IPX support:

- Client Access/400 for Windows 95/NT.
See *Client Access for Windows 95/NT - Setup*, SC41-3512 for more information.
- Enhanced NetWare Integration
See *Integrating AS/400 with Novell NetWare*, SC41-5124 for more information.

Networks

A computer network is a collection of computer nodes that are physically connected by a suitable communications medium. A computer node can be a microcomputer, a computer workstation, or a larger computer system. The arrangement and connection of network nodes are known as the network topology, as shown in Figure 1.

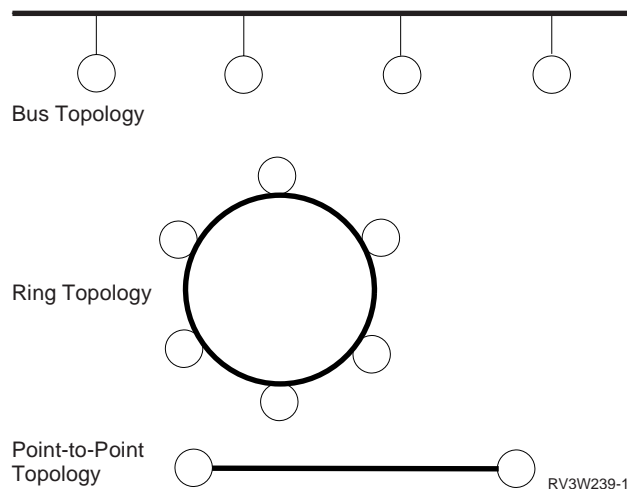

Figure 1. Network Topologies Examples

The purpose of a computer network is to provide communications between nodes for resource sharing and distributed data processing. Examples of communications applications include electronic mail, remote logon, file transfer, and remote printing.

A designated computer on the network, the **server**, makes specialized services available to other computers on the network (the clients) and handles requests from programs on those computers. The **client** can be any program that communicates with or uses the services of the server. Different computers provide different services for the benefit of the entire network.

A network where all nodes are treated the same, regardless of size, is called a peer-to-peer network.

Internetwork Communications

An internetwork, or **internet**, is a collection of packet-switched physical networks that are connected by gateways to form a single, large, virtual network. **Packets** are units of data that are sent across packet-switched networks. All nodes in the internet communicate as if they are on the same physical network, regardless of their specific hardware architecture or their software architecture. This cooperation among otherwise incompatible networks and systems is known as *interoperability*.

Serving

Client/serving generally refers to a computing model where two or more computers interact in such a way that one provides services to the other.

As the term implies, client/serving has two basic components: a *client* and a *server*. The client requests a service to be performed. This service might be to run an application, query a database, print a document, or even perform a backup or recovery procedure. The server is the resource that handles the client's request. Clients are typically thought of as personal computers and servers are typically thought of as a midrange or mainframe system; however, a server can be another personal computer on the network.

What is Internetwork Packet Exchange (IPX) Support?

The **IPX** (Internetwork Packet Exchange**) support** on AS/400 business computing systems refers to the implementation of most of the protocols that make up the NetWare** protocol suite. Protocols that are implemented as part of IPX support include Internetwork Packet Exchange (IPX), Sequenced Packet Exchange (SPX and SPX2), Routing Information Protocol (RIP), Service Advertising Protocol (SAP), and NetWare Link Services Protocol (NLSP). This support is also referred to as OS/400 IPX support in this book.

The IPX support provides peer-to-peer connectivity functions for both local and wide area networks. Because IPX is the base protocol of the NetWare protocol suite, the term IPX is the commonly used name for the whole suite.



The NetWare Core Protocol (NCP) is a service protocol that is used by NetWare to let users send requests for a service. The kinds of services range from file transfer to directory service lookups. NCP is available with the NetWare network operating system installed on the Integrated PC Server (formerly known as the file server I/O processor or FSIOP). NCP is not available as part of OS/400 IPX support.

History of Internetwork Packet Exchange (IPX)

NetWare is a network operating system and related support services environment that was introduced in the early 1980s by Novell**, Inc.. NetWare is composed of several different communication protocols. The NetWare architecture resembles and is based on the architecture of XNS** (Xerox Network Systems**). Xerox** developed and released XNS in 1981. Novell adapted IPX from the Internetwork Datagram Packet (IDP) protocol of XNS.

The services that are provided by NetWare include file and printer sharing, electronic mail transfer, database access, and other remote services. These services are provided in a client/server environment in which a workstation (client) requests and receives the services that are provided by various servers on the network.

Introduction to IPX Protocols

Network **protocols** are sets of rules that control the communication and transfer of data between two or more devices in a communications system.

IPX consists of a layered structure of protocols that range from low-level, hardware-dependent programs, to middle-level transport and network layers. These layers allow other applications to control the application layer, presentation layer, and session layer services. Each IPX layer provides services to the layer above it and uses the services that are provided by the layer below it.

Figure 2 on page 4 shows the relationship between the IPX protocols and functions within the IPX layered architecture and a model for the seven-layered architecture.



The topics that follow discuss only those protocols that are available on AS/400 business computing systems.

This layer provides a way for a process to cooperate with another process on the same or a different system.

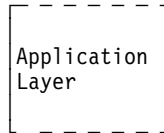

This layer provides a way for applications on different systems to correctly interpret the meaning of the data.

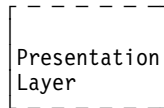

This layer provides a way to coordinate the interaction between users including functions for negotiating, establishing and releasing sessions.



This layer provides communications from one application program to another. Such communications is often called end-to-end data transfer.



This layer provides the interface to the actual network hardware. It may not provide reliable delivery. The interface can be packet-or stream-oriented. This layer provides adjacent node communication.

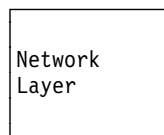

This layer provides the services for error control and synchronization of data as it is transmitted over the physical medium between adjacent nodes in the network.

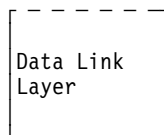

This layer describes the electromechanical characteristics for attachment to the physical medium, such as plugs and sockets, and the encoding of data into suitable electronic signals.

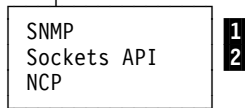
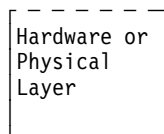

1
2

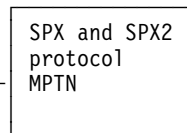

3
4

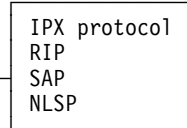

5
6
7
8

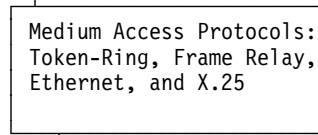

The NetWare Core Protocol (NCP) is available with the NetWare network operating system installed on the File Server Input/Output Processor (FSIOP).

Figure 2. IPX Protocol Relationship

Upper Protocol Layers

The application layer, presentation layer, and the session layer are not part of the OS/400 IPX support as currently implemented on AS/400. IPX support allows other functions to perform the application services. These functions can be any one of the following:

- Simple Network Management Protocol (SNMP)
- Sockets API
- NetWare Core Protocol (NCP)

Simple Network Management Protocol (SNMP)

1 **SNMP** is a protocol used by network hosts to exchange information that is used in the management of networks. The client/server model is based on SNMP network management. Each host that is to be managed runs a process that is called an agent. The agent is a server process that maintains the Management Information Base (MIB) database for the host network.

SNMP is a standard OS/400 system management application.

The OS/400 SNMP agent has added support for the IPX-defined MIBs.

Notes:

1. AS/400 supports the ability to get the SNMP data over AnyNet/400 or TCP/IP applications.
2. AS/400 does not support the SNMP over IPX RFC 1420.

For additional information on SNMP, see the *Simple Network Management Protocol (SNMP) Support* book.

Sockets Interface

2 The Sockets Interface is an API that allows customers the ability to write applications directly to different protocol stacks. Sockets allow unrelated processes to exchange data locally and over networks.

On the AS/400 system, the sockets interface can be used to write applications directly to the SPX and IPX protocols. It allows you to access the Service Advertising Protocol (SAP) functions and allows access to the NLSP and RIP routing information. Sockets operate over the IPX support by using an address family of NS (AF_NS). The Sockets interface can also be used over IPX by using AnyNet/400 and running AF_INET sockets.

For additional information on sockets, see the *Sockets Programming* book.

Socket

A **socket** is a method of communication between two processes. A socket is an identifier that the application uses to uniquely identify an end point of communications. The user associates a protocol address with the socket by associating a socket address with the socket.

IPX Socket Numbers

Socket numbers are used by IPX and SPX protocols to identify a unique origin or destination of communications within an application. Socket numbers or ports are integer values from 1 to 65535.

These socket numbers can be either static or dynamic.

Static socket numbers are also referred to as **well-known sockets**. Well-known socket numbers that are assigned by Novell begin at hexadecimal 8000 and go through hexadecimal FFFF. They are assigned to specific processes. For example, hexadecimal 9001 is the socket number that identifies NLSP. Socket numbers above hexadecimal 8000 should not be used by your application programs unless they are registered for that application with Novell. You can contact Novell to reserve well-known sockets for applications that you are writing.

Socket numbers between hexadecimal 4000 and hexadecimal 7FFF are dynamic sockets. These sockets are used by systems in a network to communicate with file servers and other network devices.

The following list of socket numbers is not exhaustive and lists only the socket numbers that are assigned to services that are widely implemented or of general interest.

Socket Number	Socket Process
Hexadecimal 0451	NetWare Core Protocol (NCP) Process
Hexadecimal 0452	Service Advertising Protocol (SAP) Process
Hexadecimal 0453	Routing Information Protocol (RIP) Process
Hexadecimal 0455	NetBIOS Process
Hexadecimal 0456	Diagnostics Process
Hexadecimal 0890	NetWare Enhanced Integration for OS/400
Hexadecimal 4000 through 7FFF	Dynamic sockets; used by workstations for interaction with file servers and other network communications
Hexadecimal 8000 through FFFF	Well-known sockets
Hexadecimal 8795	AnyNet over SPX
Hexadecimal 8796	AnyNet over IPX
Hexadecimal 9001	NetWare Link Services Protocol (NLSP)
Hexadecimal 9004	IW2 protocol
Hexadecimal 9086	IPX Ping

Transport Protocol Layer

The Sequenced Packet Exchange (SPX) protocol and the Multiprotocol Transport Networking Architecture (MPTN) provide transport services for IPX support.

Sequenced Packet Exchange (SPX)

3 The SPX protocol layer operates above the IPX protocol layer in the NetWare communications stack. It uses functions of the IPX protocol in order to interoperate with the SPX layers on other systems. Before an SPX packet is sent, a connection or pipe between the sender and receiver is established. This makes SPX a connection-oriented protocol. SPX performs the tasks of guaranteeing delivery, sequencing packets, detecting errors and suppressing packet duplication.

Sequenced Packet Exchange (SPX2)

The SPX2 protocol is a functional enhancement to the SPX protocol. It provides improved performance through the support of larger packet sizes, as well as windowing support.

SPX2 allows the SPX support on the AS/400 to send and receive packets as large as 8K bytes at a time. It also increases the window size so that SPX applications can send and receive up to 16 packets at a time before it requires an acknowledgment.

Using the SPX2 Protocol with Sockets Applications

For a program that uses the Sockets API, the SPX protocol is used automatically when the AF_NS family is specified. When connecting out, the AS/400 SPX2 support always asks the connection partner to use the SPX2 protocol. If the partner only supports SPX or does not want to use SPX2, only SPX connections are established.

SPX2 contains two performance-related enhancements as compared to SPX. They are the ability to negotiate end-to-end maximum packet sizes, and the ability to send multiple packets without requiring an explicit acknowledgment from the remote system. The number of packets that are allowed to be sent without acknowledgment is known as the window size for a particular connection.

There is connection-time overhead associated with the maximum packet size negotiating, because the two systems must exchange this information in a series of packets associated with SPX2 protocol. An application can choose to incur the overhead of this packet size negotiating by specifying a sockets option, or by default it can bypass this negotiation. By not negotiating maximum packet size, the largest packet that can be sent and received on a SPX2 connection is 576 bytes, which is also the maximum packet size for SPX connections.

The window size for a particular SPX2 connection is not negotiated; it is based upon the SPX2 receive window size parameter in the IPX description. There are no sockets options that are associated with the window size.

To enable the packet size negotiation, the SO_MTU sockets option needs to be set to ZERO before the connect call is issued. After the connection is established, the negotiated maximum packet size will be returned if the program retrieves the SO_MTU value through the getsockopt function call.

For an AS/400 server listening and waiting for a connect request, an SPX2 connection will be established if the client requests the use of the SPX2 protocol. The packet size negotiation will also be enabled if the client requests it (in this case, the server does not have to set the SO_MTU to zero).

If your applications are using SPX2, the sockets option SO_KEEPALIVE is treated by the SPX2 support as ON even if the program set it to OFF because the SPX2 protocol requires the watchdog function to be active for all SPX2 connections.

Multiprotocol Transport Networking Architecture (MPTN)

4 MPTN on AS/400 systems allows Common Programming Interface Communications (CPI-Communications), intersystem communications function (ICF), and sockets to flow over TCP/IP, SNA, or IPX. On AS/400 systems, MPTN is known as, and provided through, AnyNet/400 support. AnyNet/400 support is included with the OS/400 licensed program.

Examples of AnyNet/400 support for IPX are:

- APPC over IPX

The APPC over IPX support allows APPC applications that are written for CPI-Communications and ICF APIs to communicate between systems in an IPX network. Both systems running the APPC applications (such as display station pass-through) must have APPC over IPX support.

When using AnyNet/400 support, APPC over IPX allows CPI-Communications or ICF applications to run with no changes over an IPX network.

- AF_INET Sockets over IPX

The AF_INET Sockets over IPX support allows sockets applications to communicate between systems in an IPX network. Both systems running the sockets applications (such as file transfer protocol) must have AF_INET Sockets over IPX support.

For more information about AnyNet/400, see IPX Support and AnyNet/400.

Network Protocol Layer

The internetwork package exchange (IPX) protocol is the most important protocol in this layer because IPX is the base protocol of the NetWare protocol suite. All other NetWare protocols are carried inside an IPX packet.

Internetwork Packet Exchange (IPX) Protocol

5 The IPX protocol provides transportation rules for communications between systems on the different networks that make up an internetwork. The IPX protocol does things like addressing, routing, and switching information packets from one location to another on the IPX internetwork. The IPX protocol defines internetwork and intranode by addressing schemes, while relying on the network hardware for the definition of node addressing.

Routing Information Protocol (RIP)

6 RIP is a distance-vector routing protocol that is used by IPX routers on the network. RIP allows a router to exchange routing information and service information with a neighboring router.

Note: A new, more efficient protocol than RIP for exchanging routing information is NLSP. RIP routers periodically broadcast all known routing information even though that information has not changed. By contrast, the NLSP routers only broadcast routing information when there is a change in a link or router in the network.

Service Advertising Protocol (SAP)

7 SAP allows service-providing nodes, such as file servers and print servers, to advertise their services and addresses in order for clients to access these services. SAP allows clients to query for available services in their network. The clients can then direct their requests for service to a particular server. AS/400 provides access to the SAP by using the sockets API.

NetWare Link Services Protocol (NLSP)

8 NLSP is used by IPX routers to share their routing and services information with other devices on the network. NLSP provides better performance, scalability, reliability, and management of network traffic than the Routing Information Protocol (RIP) and the Service Advertising Protocol (SAP). NLSP provides link-state routing for IPX.

Note: RIP and SAP are *noisy* protocols in that they need more bandwidth on a network for network protocol processing than other networking protocols. Usually RIP and SAP on a single local area network (LAN) offer acceptable levels of protocol overhead. However, on LAN internetworks and on wide-area network (WAN) internetworks, RIP and SAP protocol overhead inefficiencies can cause problems. These inefficiencies actually need a large portion of the network bandwidth. Therefore, NLSP is usually preferred over RIP and SAP on interconnected LANs and on WANs.

Lower Layer Protocols

IPX relies on the network hardware or the media access protocols to perform the services of the data link layer and the physical layer.

Relationship among the IPX Functions

The following diagram shows the relationship among the IPX functions on AS/400 systems.

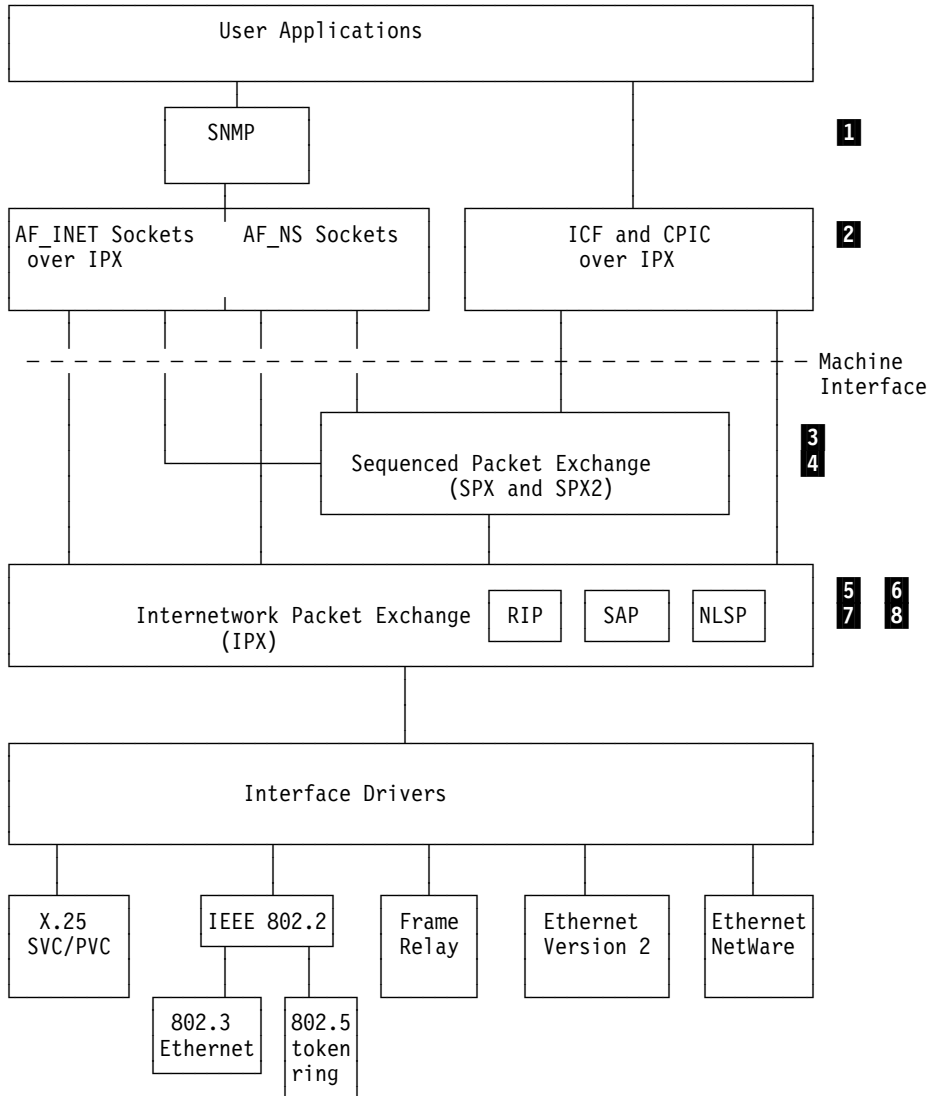

Figure 3. IPX Support on AS/400

IPX Network

A physical network segment is generally defined as an IPX network. In Figure 4 on page 11, three separate IPX networks are connected by IPX routers.

An IPX network can be used with local area networks (LANs) and wide area networks (WANs).

- For LANs, an IPX network is defined as running on a unique source service access point (SSAP) of a line. Multiple IPX networks with different SSAPs can run over a single LAN.
- For WANs, OS/400 IPX support uses data link connection identifiers (DLCIs) when running over Frame Relay. OS/400 IPX support uses logical channel identifiers when running over X.25 support.

Note: Multiple DLCs and logical channels can share a single WAN line at the same time.

IPX Node Address

The network connection of each IPX node on an internetwork is assigned an address.

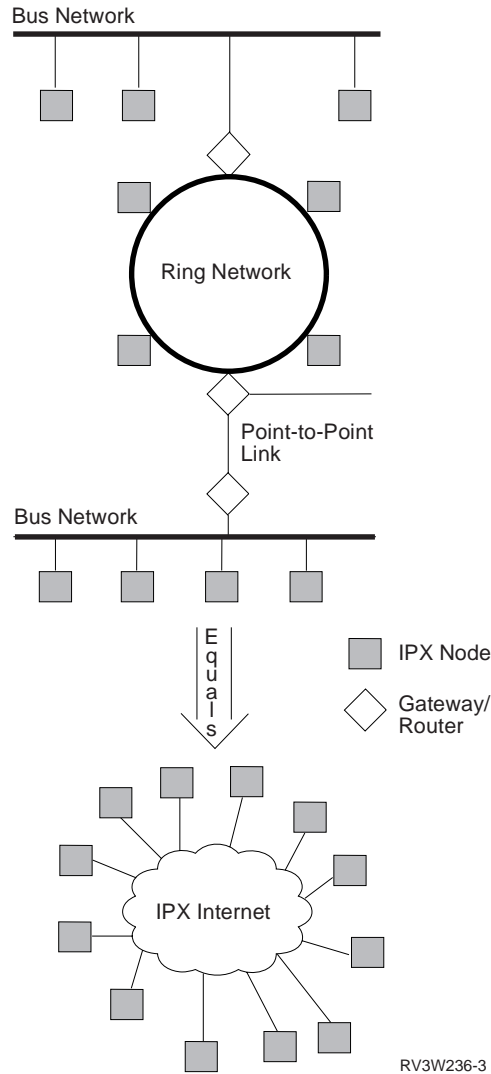

Figure 4. IPX Internetwork Example

Network connections are assigned an address that must be unique in an IPX network; this address is known as the node address. The node address is taken directly from the physical hardware address. The hardware address is often preset by the manufacturer. IPX addresses are in a standard form. A **node** in an IPX network corresponds to a physical port of the adapter card on a workstation.

IPX Circuit

An **IPX circuit** on AS/400 systems represents a path for IPX communications for a local area network (LAN) and a wide area network (WAN).

- For a LAN, an IPX circuit defines the path or point of attachment from the IPX protocol layer to the IPX network.
- For a WAN, an IPX circuit provides the path from the IPX protocol layer to a remote IPX node or system.

Each circuit is associated with a line description.

For information about working with IPX circuits, refer to “ Step 3–Adding an Inter-network Packet Exchange (IPX) Circuit” on page 35.

Routing

Routing is the process of mapping a path to send a packet to its destination IPX network address. Routing can be direct or indirect.

Direct routing is used when the source and destination nodes are on the same physical network. When direct routing is used, the source node sends the packet on the network together with the destination hardware address in the media access control layer. The destination node hardware detects its own address in the packet header and accepts the packet.

Indirect routing is used when the source and destination nodes are not on the same physical network. The source node uses its routing tables to determine which router will forward packets to the destination node. The packet is put on the network with the router hardware address in the network header, and the destination IPX node address in the IPX header. The router hardware then receives the packet from the network, and the IPX router software determines the packet destination from the IPX header.

IPX Routers

Routers are used to connect two or more similar or dissimilar networks and provide routing services that are based on logical end to end connections.

An **IPX router** routes IPX packets among the networks to which it is connected until the packet can be delivered to the final destination directly across one physical network. An **IPX packet** is the basic unit of data. IPX packets can be routed across up to 127 data links or **hops** between the source and destination of the packet. A hop implies that the packet was routed across an IPX router.



AS/400 can be a router in an IPX network. See Figure 5 on page 13.

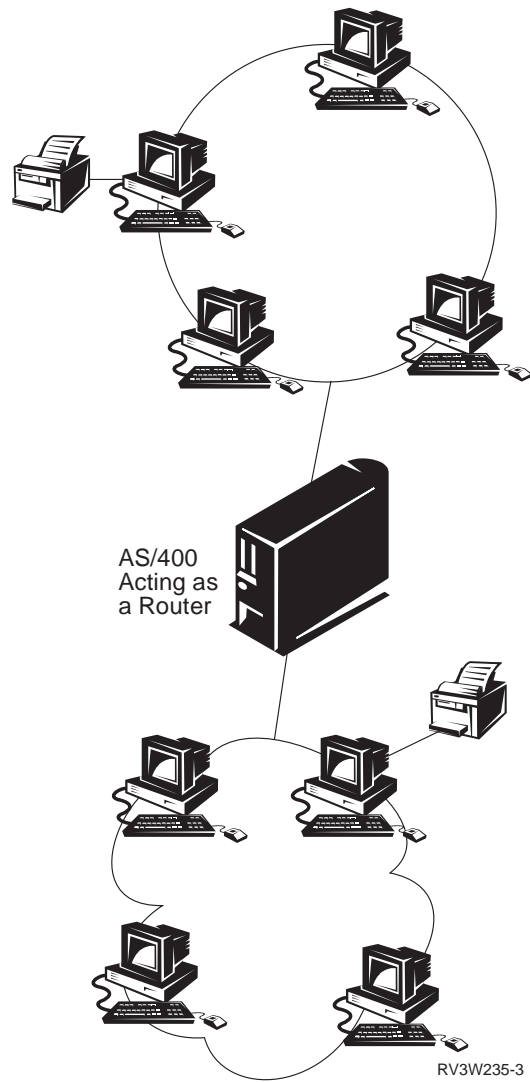

Figure 5. AS/400 Acting as a Router in an IPX Network

IPX Server

An **IPX server** provides a service to clients in an IPX internetwork. Typical services include print queues, file server, and print server. See Figure 6 on page 14.

The IPX support on AS/400 can act as an IPX server, an IPX router, or it can act as both a router and a server.

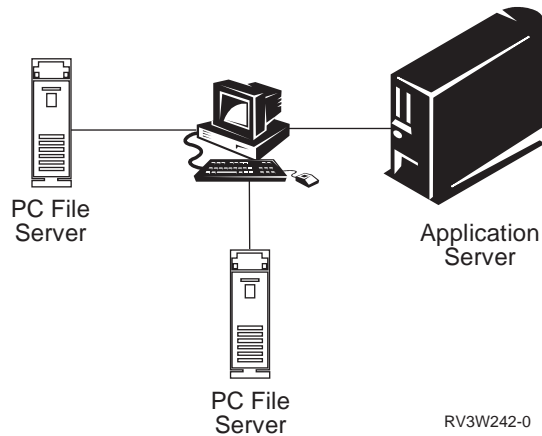

Figure 6. AS/400 Acting as a Server in an IPX Network

AS/400 IPX Internal Network

An internal IPX network operates in the AS/400 system that connects AS/400 and each of its IPX-enabled IOPs into a network.

Each of the IOPs can attach to an external network. The IOPs can, when wanted, attach to the same external network. Each path to an external network is defined by an IPX circuit that you configure. You can control whether the internal network defined between the AS/400 and the IOP is set up.

Each of the IOPs can attach to the same or to a different external IPX network. Each IOP acts as a router between the IPX external network it is attached to and the internal IPX network of the AS/400 system. See Figure 7. You cannot configure an internal IPX circuit for the internal network; that is automatically created by OS/400 IPX support.

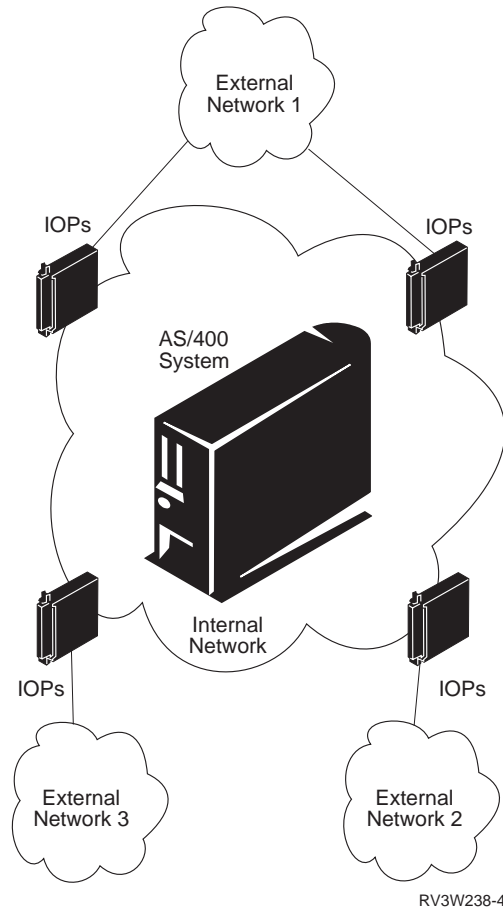

Figure 7. IPX Internal Network Example

Note: The IOPs that have NetWare installed have their own internal network and number; see “NetWare on the Integrated PC Server.”

IPX Internal Network Number

AS/400 appears as a single node on the IPX network. AS/400 supports an internal network between one or more IOPs and the main processor. Only the IOPs and the main processor can directly access this internal network. You control the *internal network number* by assigning it in the IPX description (see “ Step 1–Creating an Internetwork Packet Exchange (IPX) Description” on page 23). All applications on AS/400 that use IPX support are associated with the internal network number.

NetWare on the Integrated PC Server

A different relationship exists between the IPX support and the file serving IOP adapters when NetWare is installed on the Integrated PC Server. The Integrated PC Server is assigned an internal network number. The internal network number of the AS/400 and the internal network number of the Integrated PC Server communicate in a peer-to-peer relationship. The AS/400 and the Integrated PC Server with NetWare installed provide the routing to the networks they have established communications with. The Integrated PC Servers act as routers to their directly attached networks. In Figure 8 on page 16, the Integrated PC Server with NetWare installed acts as a router between the networks directly attached to it (IPX Network 2 and IPX Network 3). The AS/400 acts as a router between the Integrated PC

Server with NetWare that is installed and another communications adapter (IPX Network 1).

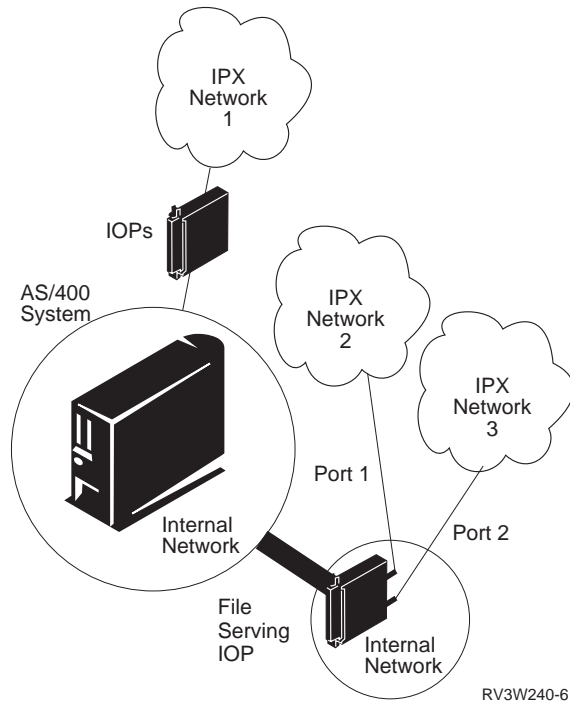

Figure 8. Integrated PC Server Internal Network

What is an Integrated PC Server?

The Integrated PC Server (also known as a file server I/O processor) is a dual purpose adapter, providing standard AS/400 communications over Systems Network Architecture (SNA), Transmission Control Protocol/Internet Protocol (TCP/IP), and Internetwork Packet Exchange (IPX) in addition to providing file serving.

You can also use an Integrated PC Server as a NetWare server, an OS/2 Warp server, or a Lotus Notes** server. For example, Figure 8 illustrates an IPCS being used as a file server in an internal network. The following integrated PC servers are available:

- The 6506 Integrated PC Server has an Intel** 486** DX2 66 Megahertz processor that is used for file serving.
Each 6506 Integrated PC Server can have a maximum of two LAN adapters. These adapters can be configured using software for either Ethernet or token ring and are sometimes referred to as ports.
- The 6616 Integrated PC Server has an Intel** Pentium** 166 Megahertz processor.
- The 2850 Integrated PC Server has an Intel** Pentium** 133 Megahertz processor. This Integrated PC Server can only be used on AS/400 Advanced Entry models.

The 6616 and 2850 Integrated PC Servers support up to two LAN adapters (or ports) in any of the following combinations:

- Two Ethernet ports
- Two token-ring ports
- One Ethernet port and one token-ring port
- One Ethernet port
- One token-ring port

Registering IPX Network Numbers

If you want to connect your IPX network to another IPX network or internetwork, you must ensure that all internal and external network addresses in the connected internetwork are unique. Novell provides the Novell Network Registry service to assign and track IPX network addresses and organization names. Such a registry allows participating organizations to share data between interconnected IPX networks without name and IPX address conflicts.

The Novell Network Registry assigns contiguous blocks of IPX addresses that are unique to your organization.

- To learn more about the Novell Network Registry
- To reserve a block of IPX addresses
- To request a copy of the *Novell Network Registry* book

Call 1-408-321-1506

FAX 1-408-956-0463

Send Internet e-mail to registry@novell.com



If your IPX network will never be connected to another IPX network, you can select any IPX network number for your AS/400 internal and external IPX network numbers.

Configuring the Internetwork Packet Exchange (IPX) Support

Configuring IPX—Overview	21
Ethernet Network Example	23
Step 1—Creating an Internetwork Packet Exchange (IPX) Description	23
IPX Description	24
IPX Internal Network Number	25
IPX Routing Protocol	25
IPX Router Name	26
IPX Maximum Datagram Size	26
Additional Parameters	27
Sample IPX Descriptions	28
Step 2—Configuring Line Descriptions for IPX Support—Ethernet	30
Line Description	32
Resource Name	32
Ethernet Standard	33
Source Service Access Point	33
Text 'description'	34
Sample Ethernet Line Descriptions	34
Step 3—Adding an Internetwork Packet Exchange (IPX) Circuit	35
Circuit Name	38
Line Description	38
IPX Network Number	38
Frame Type	38
Enable for NLSP	40
MAC Channel for NLSP	40
Router Priority for NLSP	40
Cost Override for NLSP	41
Additional Parameters	41
Displaying the Circuit Configurations	42
Sample IPX Circuits	43
Step 4—Adding Route Information	45
Step 5—Adding Service Information	45
X.25 Network Example	45
Step 1—Creating an IPX Description—X.25	46
Step 2—Configuring a Line Description for IPX Support—X.25	46
Line Description	47
Resource Name	47
Logical Channel Entries	48
Local Network Address	49
Connection Initiation	49
Default Packet Size	49
Maximum Packet Size	50
Default Window Size	50
Sample X.25 Line Description	50
Step 3—Adding an IPX Circuit for an X.25 SVC Line	52
Circuit Name	53
Line Description	53
X.25 PVC Logical Channel ID	53
X.25 SVC Network Address	53
X.25 SVC Call Type	53
X.25 Default Packet Size	54

X.25 Default Window Size	54
Automatic Start	54
RIP State	54
SAP State	55
Sample X.25 Circuit Display	55
Circuit Routes and Circuit Services—Overview	56
Step 4—Adding Circuit Route Information	57
Circuit Routes or Static Routes	57
Circuit Name	59
Remote IPX Network Number	59
Number of Hops	59
Number of Ticks	60
Sample Circuit Routes	60
Step 5—Adding Circuit Service Information	61
Circuit Services or Static Services	61
Circuit Name	63
Service Name	63
Service Type	64
Remote Network Number	64
Remote Node Address	64
Remote Socket Address	64
Number of Hops	64
Sample Circuit Services	65
Sample CL Program	65
Additional IPX Configuration Options	65

This chapter explains how to configure AS/400 business computing systems for IPX support. If this is the first time that you have configured the IPX support on AS/400 systems, please read the entire chapter before performing any of the configuration tasks.

If you are unfamiliar with OS/400 IPX support, you should also consider reading *Internetwork Packet Exchange Networks and Protocols—Introduction*.

This chapter will show you how to configure AS/400 systems in the sample network that is shown in Figure 9 on page 22.



Notes:

- If you want to configure IPX support in a Frame Relay network, you need to create a network interface description, also. For more information about working with a Frame Relay network, see the *LAN and Frame Relay Support* book.
- Your user profile must have the *IOSYSCFG special authority in order to configure the IPX support.
- The initial displays and menus that are shown when you configure IPX on your system may not contain any entries. The sample displays in this chapter may already contain data, which we entered in previous configuration steps.

Configuring IPX–Overview

To configure the IPX support, you need to do the following:

1. Create an IPX description.

See “ Step 1–Creating an Internetwork Packet Exchange (IPX) Description” on page 23.

2. Configure a line description.

See “ Step 2–Configuring Line Descriptions for IPX Support–Ethernet” on page 30.

3. Add an IPX circuit definition.

See “ Step 3–Adding an Internetwork Packet Exchange (IPX) Circuit” on page 35

The following steps are optional.

4. Add route information.

See “Step 4–Adding Circuit Route Information” on page 57.

5. Add service information.

See “Step 5–Adding Circuit Service Information” on page 61.

These steps can be done using the Configure IPX (CFGIPX) support, along with the commands and menus.



A network controller and network device description that are associated with the line description are also needed. If the controller and device descriptions for a line do not exist, IPX support creates them automatically when it starts a circuit. To learn more about activating a circuit, see *Operating and Managing IPX Support*.

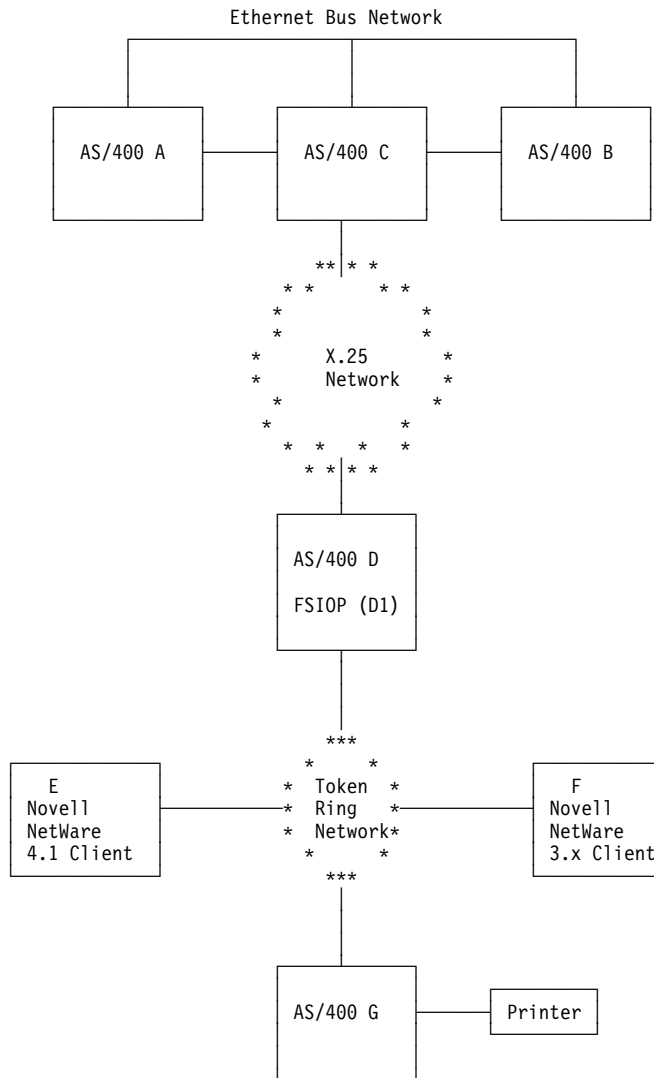

Figure 9. Sample IPX Network

To reach the Configure IPX menu:

1. Type GO CFGIPX or CFGIPX on any AS/400 command line.
2. Press the Enter key. The Configure IPX menu is shown.

See Figure 10 on page 23 for an example of this menu.

```

CFGIPX                                Configure IPX                                SYSTEM:  SYSNAMXX
Select one of the following:

Configure IPX
  1. Configure IPX circuits
  2. Work with IPX descriptions
  3. Work with IPX status

Configure AnyNet/400 over IPX
 10. Work with IP over IPX interfaces
 11. Work with IP over IPX routes
 12. Work with IP over IPX addresses

 20. Work with SNA over IPX locations

Selection or command
====>

F3=Exit  F4=Prompt  F9=Retrieve  F12=Cancel

```

Figure 10. Configure IPX Menu Example

The following steps describe how to configure the IPX support and show specific examples on how to configure parts of the sample network.

Ethernet Network Example

The Ethernet network is the first part of the sample network to configure.

Let's configure systems A, B, and C, which are part of the sample network. These three AS/400s are connected by an Ethernet bus.

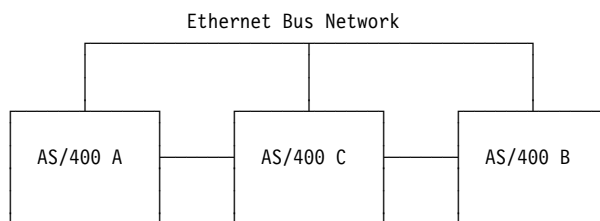

Step 1—Creating an Internetwork Packet Exchange (IPX) Description

Each AS/400 must have its own IPX description that defines global system default values for IPX. One IPX description is defined for the OS/400 IPX support on each AS/400.



You can define multiple IPX descriptions for IPX support on the system at any given time. However, the only time you would want to have multiple IPX descriptions is when you require different default values.



To create an IPX description to use the IPX support on AS/400:

1. Select option 2, *Work with IPX Descriptions* from the Configure IPX menu. See Figure 11 on page 24.

```

                                Work with IPX Descriptions
                                System:  SYSNAMXX

Type options, press Enter.
 1=Create  2=Change  3=Copy   4=Delete  5=Display  6=Print
 7=Rename  9=Retrieve source

Opt  IPX Desc  Text
1

```

Figure 11. *Work with IPX Descriptions Display Example*

2. Then select option 1. The Create IPX Description (CRTIPXD) command prompt display is shown.

Or enter the Create IPX Description (CRTIPXD) command and press F4.

You are prompted for the following information.

```

                                Create IPX Description (CRTIPXD)

Type choices, press enter.

IPX description . . . . .  _          NAME
IPX internal network number . .  00000001-FFFFFFE, *RANDOM
IPX routing protocol . . . . .  *NLSP   *NLSP, *RIP
IPX router name . . . . .      *NONE

IPX maximum datagram size . . .  576    576-65535
Text 'description' . . . . .      *BLANK

```

Figure 12. *Create IPX Description Command Prompt Example (1 of 2)*

You are required to specify just two of the parameters:

- IPX description name
- IPX internal network number

All other parameters have default values.

IPX Description

Enter the name of the IPX description being created. This name is used by the Start IPX (STRIPX) command.

SYSTEMA, SYSTEMB, and SYSTEMC are used for the names in the examples.



Use the name of your system for the IPX description name.

IPX Internal Network Number

Enter the number of the internal IPX network specifying the internal IPX network for which all services and applications that run on the IPX and SPX protocol stacks on AS/400.

This internal network number is reachable through all adjacent IPX networks, whose network numbers are configured in the IPX circuit definitions.

The internal network number is specified in the form, *nnnnnnnn*, where *nnnnnnnn* is a hexadecimal number ranging from 00000001 through FFFFFFFE.

Or you can specify *RANDOM to generate a number for your system. You must make sure that this is a unique number on the network. There is no default.

For the IPX internal network number in this example, use 00000001 for SYSTEMA, 00000002 for SYSTEMB, and 00000003 for SYSTEMC.



When duplicate network numbers are found, the data is prevented from reaching the correct destination. Use the Work with IPX Descriptions (WRKIPXD) command to display the internal network number that is associated with the IPX description that exists on this AS/400 system. The *RANDOM option generates an IPX internal network number when the IPX description is created, so this command shows you the internal network number that is generated by the AS/400 IPX support.

You can also use the Work with IPX Status (WRKIPXSTS) command, to display the active IPX description on this AS/400 system.

To check for other IPX network numbers in use, start the IPX support by using the Start IPX (STRIPX) command, start an IPX circuit, and then use WRKIPXSTS command, to display IPX route information.

For more information, see the “Work with IPX Status (WRKIPXSTS) command” in “IPX Status Support” on page 72.

IPX Routing Protocol

Enter the value to control whether IPX support uses this IPX description for RIP routing and SAP packet processing (RIP/SAP) only or for NLSP with RIP/SAP compatibility.

The *NLSP value gives you RIP/SAP compatibility. This means that the AS/400 NLSP router can interoperate on a network that uses RIP and SAP packets. *NLSP is the default.

Use the *RIP value if your network only supports RIP routing and SAP packet processing and does not contain any NLSP enabled routers.

IPX Router Name

Enter the name of the IPX router that is enabled by this IPX description on the local system. Using a symbolic name for the router is useful for network management purposes. The name can be 1 to 47 characters in length. All 7-bit ASCII characters are valid for router names.

*NONE is the default.



If you want your IPX router name to match the system name, you can manually type that system name in the router name field. Use the DSPNETA command to view the current system name. Use CHGNETA to change the system name.

You can also use the IPX description name as the router name (for example, if you are using a 2-port Integrated PC Server). The IPX description name must meet the criteria that are specified for a router name if it is to be used for the router name.

IPX Maximum Datagram Size

Enter the maximum size of IPX data that can be contained in a single IPX packet. This maximum also applies to the SPX protocol, because SPX data is sent in IPX packets.

This value is important because there is no end-to-end negotiation of maximum datagram size, and there may be intermediate hops in a route to the destination system that have a smaller maximum datagram size than the directly attached links to the AS/400 system.

You must determine the maximum packet size that is allowed between the AS/400 system and the destination system and set this value in the IPX description accordingly. Make this value as large as possible for performance reasons. If an IPX router between the AS/400 system and the destination system cannot support receiving packets that are the maximum datagram size, it discards the packet.

All routers must support 576 byte datagrams.

The IPX maximum datagram value is used by the initial open of a socket (when using the sockets API) to determine the size of the data to transmit. At socket open time, the actual circuit that the data will be transmitted on is not known. Also, if you are using sockets to communicate between two local processes out on a network, a circuit might not be needed.

Valid values range from 576 through 65,535 bytes; the default is 576.



Tips:

- This value is used by the initial open on a socket to determine the size of the data to send on the socket. There is not a fixed correlation between a socket and a circuit. A socket may be actively using one or more circuits. The sockets usage of a circuit changes as the other networks are addressed by the applications or when route changes occur.

- The Add IPX Circuit (ADDIPXCCT) command has a default maximum datagram parameter that needs to be considered when setting the IPX maximum datagram parameter for an IPX description. If the IPX maximum datagram value of the IPX description is larger than the default maximum datagram value of the IPX circuit on a circuit chosen for the IPX connection, then sending the packet over this circuit may fail.
- Also, the IPX maximum datagram size of the IPX description is used with the maximum datagram size parameter in the SSAP definition of the line description associated with the circuit to determine the actual maximum IPX packet size that is sent on a physical line.

Additional Parameters

When you press F10, the additional prompts are displayed. See Figure 13.

```

Create IPX Description (CRTIPXD)

Type choices, press Enter.

IPX description . . . . . SYSTEMA      Name
IPX internal network number . . 00000001 00000001-FFFFFFE, *RANDOM
IPX routing protocol . . . . . *NLSP    *NLSP, *RIP
IPX router name . . . . . *NONE

IPX maximum datagram size . . . 576      576-65535
IPX packet forwarding . . . . . *YES      *YES, *NO
IPX hop count . . . . . 64      8-127
SPX maximum sessions . . . . . 1000     100-9999
SPX watchdog abort timeout . . . 120000   30000-6000000
SPX watchdog verify timeout . . 30000    556-6000000
SPX are you there timeout . . . 60000    556-1200000
SPX default retry count . . . . 10      1-255
LAN hello . . . . . 20      1-600
WAN hello . . . . . 20      1-600
Designated router interval . . . 10      1-100

More...
F3=Exit  F4=Prompt  F5=Refresh  F12=Cancel  F13=How to use this display
F24=More keys

```

```

Create IPX Description (CRTIPXD)

Type choices, press Enter.

Holding time multiplier . . . . . 3      2-20
Log protocol errors . . . . . *NO     *NO, *YES
Propagate NetBIOS packets . . . *YES   *YES, *NO
SPX2 receive window size . . . . 8      1 - 16 packets
Text 'description' . . . . . *BLANK

Additional Parameters

Authority . . . . . *LIBCRTAUT  Name, *LIBCRTAUT, *CHANGE...

```

Figure 13. Create IPX Description Command Prompt Example (2 of 2)

Defaults are provided for the remainder of the parameters.

For more information on these parameters, see the “Create IPX Description (CRTIPXD) Command” in the *CL Reference* book.



Changes to an IPX description only take effect when:

- IPX support is started again (if the support is currently active).
- IPX support is started (if the support is not active).

See Operating and Managing IPX Support for more information.

Sample IPX Descriptions

Figure 14 shows the IPX description that is created for AS/400 System A.

```

                                Display IPX Description                                02/09/96 16:33:28  SYSNAMXX
IPX description . . . . . : SYSTEMA
IPX internal network number . . . . . : 00000001
IPX routing protocol . . . . . : *NLSP
IPX router name . . . . . : IPX_ROUTER_1

IPX maximum datagram size . . . . . : 576
IPX packet forwarding . . . . . : *YES
IPX hop count . . . . . : 64
SPX maximum sessions . . . . . : 1000
SPX watchdog abort timeout . . . . . : 120000
SPX watchdog verify timeout . . . . . : 30000
SPX are you there timeout . . . . . : 60000
SPX default retry count . . . . . : 10
LAN hello . . . . . : 20
WAN hello . . . . . : 20
Designated router interval . . . . . : 10
Holding time multiplier . . . . . : 3

                                                                MORE...

Press Enter to continue.

F3=Exit  F11=Display keywords  F12=Cancel

```

```

                                Display IPX Description                                02/09/96 16:33:28  SYSNAMXX
Log protocol errors . . . . . : *NO
Propagate NetBIOS packets . . . . . : *YES
SPX2 receive window size . . . . . : 8
Text 'description' . . . . . : IPXD for System A

```

Figure 14. Sample IPX Description for System A

Figure 15 on page 29 shows the IPX description created for AS/400 System B.

```

                                Display IPX Description
                                SYSNAMXX
                                02/09/96 16:33:28
IPX description . . . . . : SYSTEMB
IPX internal network number . . . : 00000002
IPX routing protocol . . . . . : *NLSP
IPX router name . . . . . : IPX_ROUTER_2

IPX maximum datagram size . . . . : 576
IPX packet forwarding . . . . . : *YES
IPX hop count . . . . . : 64
SPX maximum sessions . . . . . : 1000
SPX watchdog abort timeout . . . . : 120000
SPX watchdog verify timeout . . . . : 30000
SPX are you there timeout . . . . . : 60000
SPX default retry count . . . . . : 10
LAN hello . . . . . : 20
WAN hello . . . . . : 20
Designated router interval . . . . : 10
Holding time multiplier . . . . . : 3

                                MORE...

Press Enter to continue.

F3=Exit  F11=Display keywords  F12=Cancel

```

```

                                Display IPX Description
                                SYSNAMXX
                                02/09/96 16:33:28
Log protocol errors . . . . . : *NO
Propagate NetBIOS packets . . . . . : *YES
SPX2 receive window size . . . . . : 8
Text 'description' . . . . . : IPXD for System B

```

Figure 15. Sample IPX Description for System B

Figure 16 on page 30 shows the IPX description after it is created for System C.

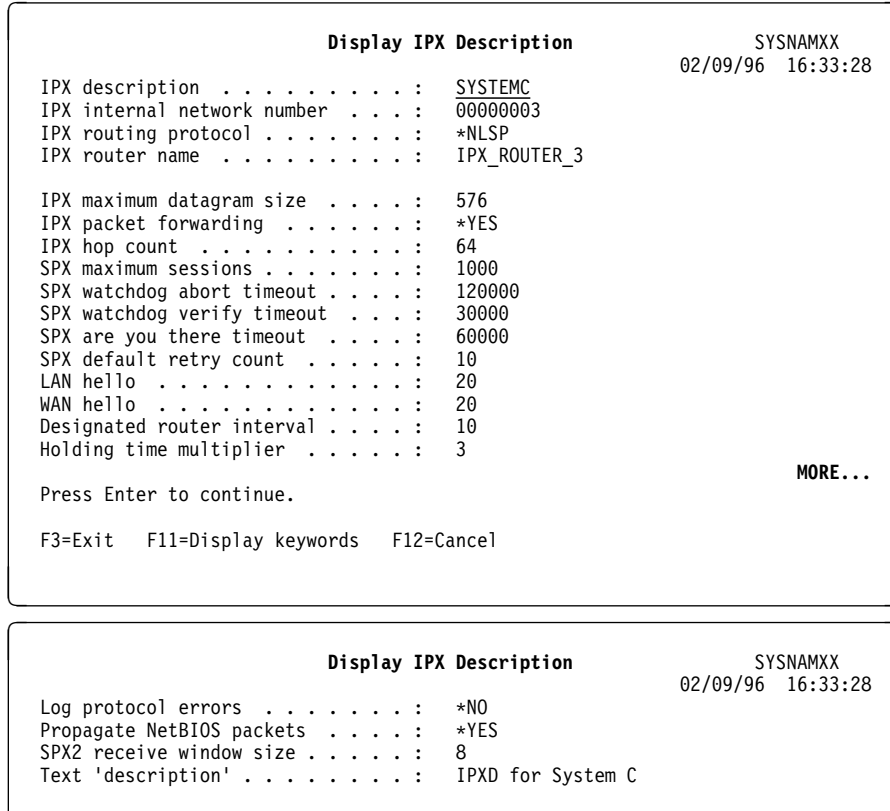

Figure 16. Sample IPX Description for System C

Step 2—Configuring Line Descriptions for IPX Support—Ethernet

Before you can add an IPX circuit, you must configure a line description for IPX processing. The line types are based on the communications input/output adapter on AS/400. See the following tables for a complete list of the supported IOAs for IPX support.

Table 2. Supported Input/Output Adapters

Protocol	Adapters
Ethernet	2617, 2723, 6181
Token Ring	2619, 2724, 6149
Frame Relay	2666, 2699
X.25	Any IOP that supports X.25 will support IPX
Integrated PC Server	Any Integrated PC Server will support IPX

Table 3. Supported Input/Output Adapters for the 6506 Integrated PC Server

Memory	One-Port Adapter	Two-Port Adapter
16MB	6516	6526
32MB	6517	6527
48MB	6518	6528
64MB	6519	6529

Table 4. Supported Input/Output Adapters—6616 Integrated PC Server

Options	Order Number
Ethernet/IEEE 802.3 adapter	6181
16/4 Mbps Token-Ring adapter	6149
32MB memory	2861
128MB memory	2862

Ordering Example: To order a base 6616 with 32MB of memory to be used with an Ethernet network, you would need to specify feature codes: 6616, 2861, and 6181. The 6616 does not come with any memory.

Table 5. Supported Input/Output Adapters—2850 Integrated PC Server

Options	Order Number
Ethernet/IEEE 802.3 adapter	2723
16/4 Mbps Token-Ring adapter	2724
32MB memory	3861
128MB memory	2860

Ordering Example: To order a base 2850 with 32MB of additional memory to be used with an Ethernet network, you would need to specify feature codes: 2850, 2860, and 2723. The 2850 comes with 32MB of memory.

You can use a line description that is already configured if it is one of these types.

For our network example, each system has one Ethernet line description.



To create a line description, do the following:

1. Type CRTLINETH on any command line.
2. Press F4 and the Create Line Description (Ethernet) (CRTLINETH) command prompt display is shown. See Figure 17 on page 32.

Certain values have special meaning for IPX support.

```

                                Create Line Desc (Ethernet) (CRTLINETH)

Type choices, press Enter.

Line description . . . . . > AETHLINE
Resource name . . . . . > CMN06
Online at IPL . . . . . *YES
Vary on wait . . . . . *NOWAIT
Local adapter address . . . . . *ADPT
Exchange identifier . . . . . *SYSGEN
Ethernet standard . . . . . *ALL
SSAP list:
  Source service access point . . . . . *SYSGEN
  SSAP maximum frame . . . . . _____
  SSAP type . . . . . _____
  + for more values - _____
Text 'description' . . . . . *BLANK

                                Bottom
F3=Exit   F4=Prompt   F5=Refresh   F10=Additional parameters   F12=Cancel
F13=How to use this display   F24=More keys

```

Figure 17. Create Line Description (Ethernet) Command Prompt Example

The important parameters in an Ethernet line description for IPX are as follows:

Line Description

1 Uniquely identifies the name of the line description that is to be used for IPX support on the system.

Use AETHLINE, BETHLINE, and CETHLINE for the line description names in this example.

Resource Name

2 Indicates the name of the communications port to which the hardware is that is attached.



Use the Work with Hardware Resources (WRKHDWRSC) command with *CMN that is specified as the Type value to help determine the resource name. The resource name consists of the IOA resource name and the port number on the IOA.

Figure 18 on page 33 shows the IOAs that could be available for IPX support on AS/400. See Table 2 on page 30 for the IOAs that IPX supports.

```

Work with Communication Resources
System: SYSNAMXX

Type options, press Enter.
2=Edit 4=Remove 5=Work with configuration descriptions

Opt Resource Type Status Text
CC01 0085 Operational Combined function IOP
LIN07 2617 Operational LAN Adaptor
CMN06 2617 Operational Ethernet Port
LIN08 605A Operational Virtual Controller

```

Figure 18. Work with Communication Resources Display Example

For System A in this example, the resource name that is associated with this line description is CMN06.

Ethernet Standard

3 Specifies the Ethernet standard frame type that is used on this line. Possible values are:

- *ALL: All Ethernet standards are used.



SNA data is only packaged in IEEE 802.3 frames.

- *ETHV2: Ethernet Version 2 frames are used for all data.
- *IEEE8023: IEEE 802.3 frames are used for all data.

We have specified the default value, *ALL in this example.



This value must be *ALL when the line is used for an Ethernet NetWare protocol network.

Source Service Access Point

4 Specifies the source service access point (SSAP) information, including an SSAP value, a maximum frame size, and an SSAP type. The line type determines which SSAP needs to be specified for IPX support.

The default value, *SYSGEN, automatically defines source service access points: 04, 12, AA, or C8.

There is no need to explicitly define SSAPs in the line description unless the line description is to be shared with other protocols. If the line description is to be shared with other protocols, define the SSAPs that are required by the other protocols.



Tips:

- If the X'E0' SSAP is to be used for an IPX circuit, it must not be explicitly defined in the line description.

- The X'AA' SSAP is unique because it can be shared by multiple communications protocols at the same time; therefore the X'AA' SSAP value can be explicitly defined on the line description without causing a conflict (for example, TCP/IP uses the X'AA' SSAP value).

Text 'description'

Specify text that briefly describes the line description. *BLANK indicates there is no text description.

Sample Ethernet Line Descriptions

Figure 19 shows the Ethernet line description for System A.

```

                                Display Line Description                                02/23/96 13:46:15  SYSNAMXX
Line description . . . . . : AETHLINE
Option . . . . . : *BASIC
Category of line . . . . . : *ELAN

Resource name . . . . . : CMN06
Online at IPL . . . . . : *YES
Vary on wait . . . . . : *NOWAIT
Local adapter address . . . . . : *ADAPT
Exchange identifier . . . . . : 056A0036
Ethernet standard . . . . . : *ALL
Maximum controllers . . . . . : 40
Error threshold level . . . . . : *OFF
Text . . . . . : 'Line description for System A'

```

Figure 19. Sample Ethernet Line Description for System A

Figure 20 displays the Ethernet line description for System B.

```

                                Display Line Description                                02/23/96 13:46:34  SYSNAMXX
Line description . . . . . : BETHLINE
Option . . . . . : *BASIC
Category of line . . . . . : *ELAN

Resource name . . . . . : CMN06
Online at IPL . . . . . : *YES
Vary on wait . . . . . : *NOWAIT
Local adapter address . . . . . : *ADAPT
Exchange identifier . . . . . : 056A0036
Ethernet standard . . . . . : *ALL
Maximum controllers . . . . . : 40
Error threshold level . . . . . : *OFF
Text . . . . . : 'Line description for System B'

```

Figure 20. Sample Ethernet Line Description for System B

Figure 21 on page 35 shows the Ethernet line description for AS/400 System C.

```

                                Display Line Description
                                02/23/96  SYSNAMXX 13:46:34
Line description . . . . . : CETHLINE
Option . . . . . : *BASIC
Category of line . . . . . : *ELAN

Resource name . . . . . : CMN06
Online at IPL . . . . . : *YES
Vary on wait . . . . . : *NOWAIT
Local adapter address . . . . . : *ADAPT
Exchange identifier . . . . . : 056A0036
Ethernet standard . . . . . : *ALL
Maximum controllers . . . . . : 40
Error threshold level . . . . . : *OFF
Text . . . . . : 'Line description for System C'

```

Figure 21. Ethernet Line Description for System C



System C has one line description for its Ethernet line, and another line description for its X.25 line. The X.25 line description is defined later, see “ Step 2—Configuring a Line Description for IPX Support—X.25” on page 46.

Step 3—Adding an Internetwork Packet Exchange (IPX) Circuit

In the network example, each system has one IPX circuit defined for its Ethernet line description.



To add an IPX circuit, do the following:

1. Select option 1, *Configure IPX Circuits* from the Configure IPX menu. See Figure 22.

```

                                Configure IPX Circuits
                                SYSTEM:  SYSNAMXX

Select one of the following:

    1. Work with IPX circuits
    2. Work with IPX circuit routes
    3. Work with IPX circuit services

Selection or command
===> 1

F3=Exit  F4=Prompt  F9=Retrieve  F12=Cancel

```

Figure 22. Configure IPX Circuits Menu Example

An IPX *circuit* is a logical representation of a path for IPX communication. No more than 255 circuits can be configured on one system.

- For a LAN, it defines the path or point of attachment from the IPX protocol layer to the IPX network.
- For a WAN, it defines the path from the IPX protocol layer to a remote IPX node or system.

Circuits are not physical objects. Each circuit is associated with a line description. The line description describes the physical connection from the AS/400 to the network. The circuit defines the logical path from the IPX layer to the line.



For LAN type line descriptions:

- In most cases, one circuit is defined for each LAN line description. However, up to 4 circuits could be defined if the LAN uses multiple frame types for IPX packets. The network administrator determines how the systems are set up when designing the network.
- The line type determines the number of SSAPs that can be used for IPX packets. Since you can define one circuit for each SSAP, this also determines the number of circuits that can be defined for a particular line description. Only 2 circuits can be defined for token-ring and Ethernet Version 2 (ETHV2) type line descriptions.

For WAN type line descriptions:

- One circuit is defined for each remote IPX router with which the local system is to communicate.
- For an X.25 line description, the number of circuits is limited by the number of configured logical channels.
- For Frame Relay line descriptions, only 1 circuit may be defined.

For more information, see Table 6 on page 39.

2. Select option 1, *Work with IPX Circuits* from the Configure IPX Circuits menu. The Work with IPX Circuits display is shown. See Figure 23.

Work with IPX Circuits				
Type options, press Enter.				System: SYSNAMXX
1=Add	2=Change	4=Remove	5=Display	7=Display associated services
8=Display associated routes	9=Start	10=End		
Opt	Circuit Name	Line Description	Line Type	Circuit Status
_____	_____	_____	_____	_____

Figure 23. Work with IPX Circuits Display Example

3. Type a 1 (Add) on this display to go to the Add IPX Circuits (ADDIPXCCT) command prompt display as shown in Figure 24 on page 37. You can also go directly to this prompt display by typing ADDIPXCCT on any command line and pressing F4.

```

Add IPX Circuit (ADDIPCCT)

Type choices, press Enter.

Circuit name . . . . . > CCT1A
Line description . . . . . > AETHLINE
IPX network number . . . . . 2FFFFFFF
Frame type . . . . . *SSAP
Enable for NLSP . . . . . *YES
MAC channel for NLSP . . . . . *BROADCAST
Router priority for NLSP . . . . . 44
Cost override for NLSP . . . . . *CALC

Name
00000001-FFFFFFFD
*SSAP, *SNAP, *ETHV2, *ETHNTW
*YES, *NO
*BROADCAST, *MULTICAST
0-127
1-63, *CALC

Bottom
F3=Exit F4=Prompt F5=Refresh F10=Additional parameters F12=Cancel
F13=How to use this display F24=More keys

```

Figure 24. Add IPX Circuit Command Prompt Example (1 of 2)

When you press F10, the additional prompts are displayed (Figure 25).

```

Add IPX Circuit (ADDIPCCT)

Type choices, press Enter.

Circuit name . . . . . > CCT1A
Line description . . . . . > AETHLINE
IPX network number . . . . . 2FFFFFFF
Frame type . . . . . *SSAP
Enable for NLSP . . . . . *YES
MAC channel for NLSP . . . . . *BROADCAST
Router priority for NLSP . . . . . 44
Cost override for NLSP . . . . . *CALC

Name
00000001-FFFFFFFD
*SSAP, *SNAP, *ETHV2, *ETHNTW
*YES, *NO
*BROADCAST, *MULTICAST
0-127
1-63, *CALC

Additional Parameters

Default maximum datagram size . *LIND 1 576-16388, *LIND
Throughput . . . . . *CALC 300-4294967295, *CALC
Delay time . . . . . *CALC 2 1-5000000, *CALC
Automatic start . . . . . *YES 3 *YES, *NO
RIP state . . . . . *AUTO *ON, *OFF, *AUTO

More...
F3=Exit F4=Prompt F5=Refresh F12=Cancel F13=How to use this display
F24=More keys

```

Figure 25. Add IPX Circuit Command Prompt Example (2 of 2)

The important prompts in an IPX circuit for an Ethernet line description are as follows:

Circuit Name

Specifies a name that uniquely identifies this IPX circuit. This circuit name must not have been previously configured.

The IPX circuit names in this example are: CCT1A for System A, CCT1B for System B, and CCT1C for System C.



Blanks are allowed.

Line Description

Specifies the name of the communications line description that is associated with the new circuit as defined previously in “ Step 2–Configuring Line Descriptions for IPX Support–Ethernet” on page 30.

To find the names of the currently defined line descriptions, use the Work with Line Descriptions (WRKLIND) command.



The line description must be created prior to adding the circuit.

The line description names in the sample network are AETHLINE, BETHLINE, and CETHLINE.

IPX Network Number

Specifies the external IPX network number of the IPX network that the local system belongs to. The network number is specified in the form 'nnnnnnnn', where *nnnnnnnn* is a hexadecimal number ranging from 00000001 through FFFFFFFD.

The network administrator determines the IPX network number to use. For more information, see “Registering IPX Network Numbers” on page 17.

For the sample network, the Ethernet portion of the network has an external IPX network number of 2FFFFFFF. This value must match for all IPX nodes in an IPX network. Only circuits within a local area network (LAN) need an external network number.



Tips:

- The IPX network number value and the Frame type value must both be specified if the circuit is being defined for a LAN-type line description.
- The IPX Frame type value is mutually exclusive with the SVC network address value and the PVC logical channel ID value.

Frame Type

Specifies the LAN frame type that is used by the IPX circuit being added. The frame type is controlled by the service access point (SSAP) of the line description. Only one network number can be specified for a specific SSAP on a line description, see “Source Service Access Point” on page 33.

The Frame Type value must match for all IPX circuits in an IPX network. In this example, we have chosen the default value, *SSAP, to indicate that the X'E0' SSAP will be used for this circuit.



Tips:

- The Frame Type value and the IPX network number value must both be specified if the circuit is being defined for a LAN-type line description.
- The Frame Type value is mutually exclusive with the SVC network address value and the PVC logical channel identifier when an X.25 description is specified for the line description value.

Table 6 shows the Frame Type values allowed for each of the line types.

Line Type	OS/400 Circuit Frame Type				Maximum Number of Circuits Allowed
	*SNAP (X'AA')	*SSAP (X'E0') See note 1.	*ETHV2	*ETHNTW See note 2.	
Token Ring	X	X			2
Ethernet 802.3	X	X			2
Ethernet V2			X		1
Ethernet *ALL	X	X	X	X	4

Notes:

1. The X'E0' SSAP must not exist in the token-ring or Ethernet line descriptions. If it does, the circuit will fail to start.
2. Be careful when you use the *ETHNTW value for Novell's Raw Ethernet frame type. Problems may arise with the sharing of addresses.

If you have a Novell network already configured, the following table, Table 7, should help you determine the Frame Type to use on AS/400.

OS/400 Circuit Frame Type	Novell Frame Type
Ethernet *SNAP	Ethernet_SNAP
Ethernet *SSAP	Ethernet_802.2
Ethernet *ETHV2	Ethernet_II
Ethernet Standard *ALL *ETHNTW	Ethernet_802.3
Token ring *SNAP	Token-ring_SNAP
Token ring *SSAP	Token-ring

Enable for NLSP

Enables NLSP processing for this circuit. If the circuit does not support NLSP processing, change the value to *NO.



If a value of *RIP is specified for the IPX routing protocol value on the IPX description that is active when a circuit is active, then the Enable for NLSP value will not be used.

MAC Channel for NLSP

Specifies whether broadcast or multicast capabilities are supported for NLSP on this circuit.

Broadcast allows all devices on the LAN to receive the transmitted packets. This is the default value, because some older systems do not support multicasting capabilities.

Multicast allows only those devices by listening for a special multicast packet address to accept the routing information packet. Using multicast allows for reduced load on systems that are not listening for the multicast address. Use of the multicast transmission method requires all NLSP routes on the LAN to be configured for multicast. Otherwise, the broadcast transmission method is used.

When multicast by addressing is specified for a circuit, the associated line description must have the correct multicast address enabled.

- For the Ethernet line description, the Group Address value must be 09001BFFFFFF.
- For the token-ring line description, the Functional Address value must be C00010000000.



This parameter is only valid for LANs.

Router Priority for NLSP

Specifies the priority that is assigned to this router for the NLSP designated router selection process. The designated router is the NLSP router responsible for the exchange of link state information on behalf of all other NLSP routers on the same LAN. You should set the priority value high for the most stable router with enough memory to process NLSP routing information for your LAN.

Valid values are 0 through 127; 44 is the default.



Tips:

- This value is the default starting point for the router priority. The router priority can be automatically changed by NLSP processing when this system is elected as the designated router. If this AS/400 system is elected as the designated router, NLSP processing automatically increases the router priority value by 20. If this system later resigns as the designated router, NLSP processing automatically

decreases the router priority value by 20. This returns the router priority value to its original value.

- The Enable for NLSP value must be *YES before this parameter takes effect.
- The Router Priority for NLSP value is only valid for LAN type line descriptions.

Cost Override for NLSP

Specifies the cost associated with the circuit. This value is used by NLSP to help determine the network paths over which to forward IPX packets. A lower value means less cost associated with that circuit and a better chance that the circuit will be selected. A value of *CALC means to determine the value based on the circuit line description's line type and line medium's throughput.



The Enable for NLSP value must be *YES before this parameter takes effect.

The cost override must be a value from 1 to 63; default is *CALC.

See “Controlling NLSP Route Selection” on page 107 for more information about throughput and default cost that is illustrated in the NLSP cost table.

Additional Parameters

Default values are provided for the additional prompts.

Default Maximum Datagram Size: **1** Specifies the maximum IPX packet size that can be sent over this circuit. This value includes the count of bytes up to and including the IPX header but not the LLC or MAC level header or trailer. This maximum also applies to the SPX protocol, because SPX data is sent in IPX packets. The maximum frame size of the line description is used only if *LIND is specified here. The default maximum datagram value is used with the maximum frame size value of the line description's SSAP value to determine the actual maximum packet size that is sent on a particular line. The minimum value allowed is 576.

This value is important because there is no end-to-end negotiation of maximum datagram size in IPX processing, and there may be intermediate hops in the path to a destination system that have a smaller maximum datagram size than the directly attached links to the AS/400 system.



The IPX description has an IPX maximum datagram value that needs to be considered when setting this value. If the IPX maximum datagram value of the IPX description is larger than the default maximum datagram value of the IPX circuit chosen for the IPX connection, then the sending of the packet will fail. You are requested to provide a smaller packet size that can fit on the circuit.



For *SNAP circuits defined using an Ethernet line, the value used by the system when the default maximum datagram size equals *LIND is based on the maximum frame size of the X'AA' SSAP.

For all other Ethernet type circuits, the system uses 1496.

Delay: **2** Specifies the time, in microseconds, to send a byte of information from one system to another. NLSP uses the delay and throughput values to calculate the number of ticks for a path to a destination network when communicating with a routing information protocol (RIP) router. The number of ticks is directly proportional to the delay. One tick equals 55000 microseconds or approximately 1/18 of a second. Valid values range from 1 through 5000000 microseconds. Delay is most commonly used for WAN networks.



When *CALC is specified for LAN-type line descriptions, the delay value is 200 microseconds. When *CALC is specified for WAN-type line descriptions, and the Enable for IW2 parameter is equal to *NO, Delay is set to a value of 15000 microseconds.

Automatic Start: **3** Specifies whether the IPX circuit is started automatically whenever IPX is started. The default is *YES. If you choose *NO, you must start the circuit yourself by using the Start IPX Circuit (STRIPXCCT) command or by selecting option 9 (Start) on the Work with IPX Circuits display as shown in Figure 23 on page 36.

Displaying the Circuit Configurations

To display the circuit for System A:

1. Select option 1, *Work with IPX Circuits* from the Configure IPX Circuits menu.
2. Press Enter.

The Work with IPX Circuits display would look like Figure 26.

Work with IPX Circuits				
Type options, press Enter.				SYSTEM: SYSNAMXX
1=Add	2=Change	4=Remove	5=Display	7=Display associated services
8=Display associated routes	9=Start	10=End		
Opt	Circuit Name	Line Description	Line Type	Circuit Status
—	CC1A	ETHLINEA	*ELAN	Inactive
5	NTW0101	NTW0101	*TRLAN	*FSIOP

Figure 26. Work with IPX Circuits Display Example



Any change to the IPX circuit definition, except for the Automatic Start parameter, takes effect immediately.

Sample IPX Circuits

To display our sample IPX circuits, do the following:

1. Select option 5 from the Work with IPX Circuits display (or enter the Display IPX Circuit (DSPIXCCT) command).
2. Press Enter, the Display IPX Circuit display is shown for the LAN-type (Ethernet) line description.

Figure 27 shows the IPX circuit for AS/400 System A.

```
Display IPX Circuit

Circuit name . . . . . : CCTIA
Circuit status . . . . . : Active
Line description . . . . . : AETHLINE
Line type . . . . . : *ELAN
IPX network number . . . . . : 2FFFFFFF
Frametype . . . . . : *SSAP
Node address . . . . . : 420000249396
Enable for NLSP . . . . . : YES
MAC channel for NLSP . . . . . : *BROADCAST
Router priority for NLSP . . . : 44
Cost override for NLSP . . . . : *CALC
Default maximum datagram size: *LIND
Throughput . . . . . : *CALC
Delay . . . . . : *CALC
Automatic start . . . . . : YES

Display IPX Circuit

RIP:
State . . . . . : *AUTO
Update interval . . . . . : 60
Age multiplier . . . . . : 4
SAP:
State . . . . . : *AUTO
Update interval . . . . . : 60
Age multiplier . . . . . : 4
```

Figure 27. Sample Display IPX Circuit for System A

Figure 28 on page 44 shows the IPX circuit for AS/400 System B.

```

                                Display IPX Circuit
Circuit name . . . . . : CCT1B
Circuit status . . . . . : Active
Line description . . . . . : BETHLINE
Line type . . . . . : *ELAN
IPX network number . . . . . : 2FFFFFFF
Frametype . . . . . : *SSAP
Node address . . . . . : 420000249396
Enable for NLSP . . . . . : YES
MAC channel for NLSP . . . . . : *BROADCAST
Router priority for NLSP . . . : 44
Cost override for NLSP . . . . : *CALC
Default maximum datagram size: *LIND
Throughput . . . . . : *CALC
Delay . . . . . : *CALC
Automatic start . . . . . : YES

                                MORE...

Press Enter to continue.

F3=Exit  F12=Cancel

```

```

                                Display IPX Circuit

RIP:
  State . . . . . : *AUTO
  Update interval . . . . . : 60
  Age multiplier . . . . . : 4
SAP:
  State . . . . . : *AUTO
  Update interval . . . . . : 60
  Age multiplier . . . . . : 4

```

Figure 28. Sample Display IPX Circuit for System B

Figure 29 on page 45 shows the IPX circuit for AS/400 System C.

```

                                Display IPX Circuit

Circuit name . . . . . : CCT1C
Circuit status . . . . . : Active
Line description . . . . . : CETHLINE
Line type . . . . . : *ELAN
IPX network number . . . . . : 2FFFFFFF
Frametype . . . . . : *SSAP
Node address . . . . . : 420000249398
Enable for NLSP . . . . . : YES
MAC channel for NLSP . . . . . : *BROADCAST
Router priority for NLSP . . . : 44
Cost override for NLSP . . . . : *CALC
Default maximum datagram size: *LIND
Throughput . . . . . : *CALC
Delay . . . . . : *CALC
Automatic start . . . . . : YES

                                                                MORE...

Press Enter to continue.

F3=Exit  F12=Cancel

```

```

                                Display IPX Circuit

RIP:
State . . . . . : *AUTO
Update interval . . . . . : 60
Age multiplier . . . . . : 4
SAP:
State . . . . . : *AUTO
Update interval . . . . . : 60
Age multiplier . . . . . : 4

```

Figure 29. Sample Display IPX Circuit for System C

Step 4—Adding Route Information

You do not need to create any IPX circuit routes for this sample network because the systems are connected using a LAN.

Step 5—Adding Service Information

You do not need to create any IPX circuit services for this sample network because the systems are connected using a LAN.

X.25 Network Example

This next section describes the configuration steps to complete defining System C in the sample IPX internetwork. The additional configuration steps that need to be completed on System C are:

1. Create an IPX description. See “ Step 1—Creating an Internetwork Packet Exchange (IPX) Description” on page 23.
2. Configure an X.25 line description. See “ Step 2—Configuring a Line Description for IPX Support—X.25” on page 46.
3. Add an IPX circuit for the X.25 line description. See “Step 3—Adding an IPX Circuit for an X.25 SVC Line” on page 52.

4. Adding circuit route information. See “Step 4–Adding Circuit Route Information” on page 57.
5. Adding circuit service information. See “Step 5–Adding Circuit Service Information” on page 61.

Besides being a node in the Ethernet network, System C has an X.25 link to the token-ring network.

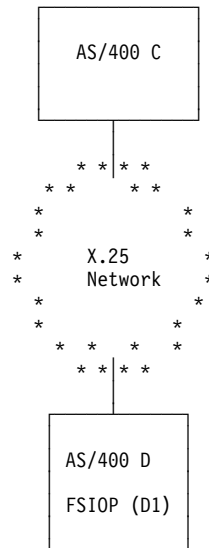

Figure 30. X.25 Network Example

Step 1–Creating an IPX Description–X.25

The IPX description for System C has already been created. See “ Step 1–Creating an Internetwork Packet Exchange (IPX) Description” on page 23.

Step 2–Configuring a Line Description for IPX Support–X.25



To create a X.25 line description, do the following:

1. Type CRTLINX25 on any command line.
2. Press Enter.
3. Press Enter again to see all of the parameters on the display.

You must enter certain values that have special meaning for IPX support. These parameters are discussed in the following sections.

Usually you need only one line description for each wide area network that AS/400 can connect to.

```

Create Line Desc (X.25) (CRTLINX25)

Type choices, press Enter.

Line description . . . . . > CX25LINE 1 Name
Resource name . . . . . CMN051 2 Name, *NWID
Logical channel entries: 3
  Logical channel identifier . . 002 001-FFF, *PROMPT
  Logical channel type . . . . *SVCBOTH *PVC, *SVCIN, *SVCBOTH...
  PVC controller . . . . . Name
    + for more values
Local network address . . . . 000000999 4
Connection initiation . . . . *LOCAL 5 *LOCAL, *REMOTE, *WAI T...
Online at IPL . . . . . *YES *YES, *NO
Physical interface . . . . . *X21BISV24 *X21BISV24, *X21BISV35...
Connection type . . . . . *NONSWTTP *NONSWTTP, *SWTPP
Vary on wait . . . . . *NOWAIT *NOWAIT, 15-180 (1 second)
Line speed . . . . . 9600 *CALC, 600, 1200, 2400...
Exchange identifier . . . . . *SYSGEN 05600000-056FFFFF, *SYSGEN
Extended network addressing . . *NO *YES, *NO

More...
F3=Exit F4=Prompt F5=Refresh F10=Additional parameters F12=Cancel
F13=How to use this display F24=More keys

```

```

Create Line Desc (X.25) (CRTLINX25)

Type choices, press Enter.

Maximum frame size . . . . . 1024 1024, 2048, 4096
Default packet size: 6
  Transmit value . . . . . 128 64, 128, 256, 512, 1024...
  Receive value . . . . . *TRANSMIT *TRANSMIT, 64, 128, 256...
Maximum packet size: 7
  Transmit value . . . . . *DFTPCKTSIZE *DFTPCKTSIZE, 64, 128, 256...
  Receive value . . . . . *TRANSMIT *DFTPCKTSIZE, *TRANSMIT, 64...
Modulus . . . . . 8 8, 128
Default window size: 8
  Transmit value . . . . . 2 1-15
  Receive value . . . . . *TRANSMIT 1-15, *TRANSMIT
Insert net address in packets . *YES *YES, *NO
Text 'description' . . . . . 'X25 Line for System C'

Bottom
F3=Exit F4=Prompt F5=Refresh F10=Additional parameters F12=Cancel
F13=How to use this display F24=More keys

```

Figure 31. Sample X.25 Line Description for AS/400 System C

Line Description

1 Uniquely identifies the line description on the system. We have named our line description CX25LINE.

Resource Name

2 Indicates the name of the communications port to which the hardware is that is attached.



Use the Work with Hardware Resources (WRKHDWRSC) command with *CMN that is specified as the Type value to help determine the resource name. The resource name consists of the input/output adapter (IOA) resource name and the port number on the IOA.

Figure 32 on page 48 shows the IOAs that could be available for IPX support on AS/400. See Table 2 on page 30 for the IOAs that IPX supports.

```

Work with Communication Resources
System:  SYSNAMXX

Type options, press Enter.
  2=Edit  4=Remove  5=Work with configuration descriptions

Opt Resource      Type Status      Text
  CC08          2666 Operational Comm Processor
  LIN15         2666 Operational Comm Adapter
  CMN051        2666 Operational Comm Port
  LIN20         605A Operational Virtual Controller

```

Figure 32. Work with Communications Resource Example

For AS/400 System C in this example, the resource name that is associated with this line description is CMN051.

Logical Channel Entries

3 Specifies a list of entries to be added, removed, or changed in the logical channel table.

A logical channel entry must be defined for each virtual circuit. A logical channel entry for an X.25 SVC consists of a logical channel identifier and a logical channel type.

There is a special value that is called *PROMPT which allows you to easily add, remove and change logical channel entries that is defined for an X.25 line. Once a PVC logical channel has a PVC controller attached to it, the logical channel entry cannot be changed while the PVC controller is attached.

Logical Channel Identifier

Specifies a three-character hexadecimal number ranging from 001 to FFF for the logical channel identifier. The first digit (from left to right) is the logical channel group number; the second and third digits make up the logical channel number.

You need to specify one logical channel identifier for each virtual circuit. Use 001 and 002 for the virtual circuits in the example.

Logical Channel Type

Specify the logical channel type as:

- *PVC (permanent virtual circuit)
- *SVCIN (switched virtual circuit for input only)
- *SVCOUT (switched virtual circuit for output only)
- *SVCBOTH (switched virtual circuit for both input and output)

In this example, set this value to *SVCBOTH, indicating that this logical channel is a switched virtual circuit for both incoming and outgoing calls.

PVC Controller (Optional)

Specifies the name of the permanent virtual circuit (PVC) controller that is assigned to the logical channel. This field is only valid when the channel type is *PVC.

Local Network Address

4 Specifies the local network address for this system. Up to 17 characters can be specified, if *YES is specified for the Extend Network Address parameter value. Otherwise, up to 15 characters can be specified.

Use 000000999 for the X.25 network address for the sample network. This number is assigned by the network administrator when the network is designed.

Connection Initiation

5 Specifies the method that is used to establish the X.25 data link connection.

- *LOCAL means the local system initiates the connection.
- *REMOTE means the remote system initiates the connection while the local system waits for the connection to be established.
- *WAIT means the local system waits for a disconnect (DISC) or disconnect mode (DM) from the data circuit-terminating equipment (DCE) before attempting to activate the link.
- *CALLER means the connection is initiated from either the local system or the remote system that is based on call direction.
- For the sample network, this is a DTE-to-DTE connection, so *LOCAL is used.

Default Packet Size

6 Specifies the packet size value used by the X.25 network for transmission and reception.

Transmit Value

Specify a packet size for transmission to all circuits that is attached to this line. The circuit definition can override this value with the packet size value on the Add IPX Circuit (ADDIPXCCT) or Change IPX Circuit (CHGIPXCCT) commands. The valid values for the packet size are 64, 128, 256, 512, 1024, 2048, and 4096.

The default packet size is 128. This value should match the packet size of the network you are communicating with.

Receive Value

Specifies a packet size for reception from all circuits that are attached to this line. The circuit definition can override this value with the packet size value on the ADDIPXCCT or CHGIPXCCT commands. The valid values for the packet size are 64, 128, 256, 512, 1024, 2048, and 4096. If the transmit value is specified, the default packet size for transmission is used as the default for reception.

Maximum Packet Size

7 Specify the maximum packet size value for transmission and reception on an X.25 network. The value that is specified must not be less than the default packet size specified.

Transmit Value

The maximum packet size for transmission is the same as that specified as the default packet size for transmission on the default packet size value when the *DFTPKTSIZE value is used.

The valid values for the packet size are 64, 128, 256, 512, 1024, 2048, and 4096.

Receive Value

The maximum packet size for reception is the same as that specified as the default package size for reception when the *DFTPKTSIZE value is used.

The value specified as the packet size for transmission is used as the default for reception when the *TRANSMIT value is used.

The default packet size value on the controller commands can override the default value.

Default Window Size

8 Specifies the packet window size for transmission and reception on circuits that are attached to this line. The window size value on the controller commands can override this value. Usually a default value is already specified, so you do not have to choose it.

Transmit Value

Specifies the appropriate default window size. Valid values range from 1 through 7 for networks that use modulus 8 packet numbering. Valid values range from 1 through 15 for networks that use modulus 128 packet numbering.

The default packet window size is 2; modulus 8 is supported on the X.25 line description for this example.

Receive Value

Specifies the appropriate default window size.

Valid values range from 1 through 7 for networks that use modulus 8 packet numbering and from 1 through 15 for networks that use modulus 128 packet numbering.

When the Transmit value is specified, the default window size for transmission is used as the value for reception.

Sample X.25 Line Description

When you are finished specifying the information on system C, the X.25 line description would look like Figure 33 on page 51.

```

                                Display Line Description
                                SYSNAMXX
                                02/09/96 11:51:23
Line description . . . . . : CX25LINE
Option . . . . . : *BASIC
Category of line . . . . . : *X.25

Resource name . . . . . : CMN051
Local network address . . . . . : 12345
Extended network addressing . . . . . : *NO
Connection initiation . . . . . : *LOCAL
Online at IPL . . . . . : *YES
Physical interface . . . . . : *X21BISV24
Connection type . . . . . : *NONSWTPP
X.25 DCE support . . . . . : *NO
Vary on wait . . . . . : *NOWAIT
Clocking . . . . . : *MODEM
Line speed . . . . . : 9600
Exchange identifier . . . . . : 05600033
Maximum frame size . . . . . : 1024

                                More...

Press Enter to continue.

F3=Exit  F11=Display keywords  F12=Cancel

```

```

                                Display Line Description
                                SYSNAMXX
                                02/09/96 11:51:23
Line description . . . . . : CX25LINE
Option . . . . . : *BASIC
Category of line . . . . . : *X.25

Default packet size:
  Transmit value . . . . . : 128
  Receive value . . . . . : *TRANSMIT
Maximum packet size:
  Transmit value . . . . . : *DFTPKTSIZE
  Receive value . . . . . : *TRANSMIT
Modulus . . . . . : 8
Default window size:
  Transmit value . . . . . : 2
  Receive value . . . . . : *TRANSMIT
Insert net address in packets . . . : *YES
Error threshold level . . . . . : *OFF
Modem type supported . . . . . : *NORMAL

                                More...

Press Enter to continue.

F3=Exit  F11=Display keywords  F12=Cancel

```

```

                                Display Line Description
                                SYSNAMXX
                                02/09/96 11:51:23
Line description . . . . . : SKRX25PVC
Option . . . . . : *BASIC
Category of line . . . . . : *X.25

Switched connection type . . . . . : *DIAL
Autoanswer type . . . . . : *DTR
Text . . . . . : 'X.25 line for System C'

```

Figure 33. Sample Display X.25 Line Description for AS/400 System C

For more information about working with an X.25 network, see the *X.25 Network Support* book.

Step 3—Adding an IPX Circuit for an X.25 SVC Line



To add an IPX circuit for the X.25 SVC line description, do the following:

1. Select option 1, *Configure IPX Circuits* from the Configure IPX menu.
2. Press Enter, the Add IPX Circuit (ADDIPXCCT) command prompt is shown. (See Figure 34.)
3. After you press F10, the additional prompts are displayed.

Add IPX Circuit (ADDIPXCCT)

Type choices, press Enter.

Circuit name	<u>CCT2C</u>		
Line description	<u>CX25LINE</u>	1	Name
IPX network number		2	00000001-FFFFFFD
Frame type	<u>*SSAP</u>		*SSAP, *SNAP, *ETHV2, *ETHNTW
X.25 PVC logical channel id	<u>1</u>	3	001-FFF
X.25 SVC network address	<u>000009994</u>	4	
X.25 SVC call type	<u>*DEMAND</u>	5	*DEMAND, *PERM
X.25 SVC reverse charge	<u>*NONE</u>		*NONE, *R EQUEST, *ACCEPT...
X.25 SVC idle circuit timeout	<u>60</u>		0-600
X.25 default packet size:		6	
Transmit packet size	<u>*LIND</u>		*LIND, 64, 128, 256, 512...
Receive packet size	<u>*LIND</u>		*LIND, *TRANSMIT, 64, 128...
X.25 default window size:		7	
Transmit window size	<u>*LIND</u>		1-15, *LIND
Receive window size	<u>*LIND</u>		1-15, *LIND, *TRANSMIT
Enable for NLSP	<u>*YES</u>		*YES, *NO

Add IPX Circuit (ADDIPXCCT)

Type choices, press Enter.

MAC channel for NLSP	<u>*MULTICAST</u>		*BROADCAST, *MULTICAST
Router priority for NLSP	<u>64</u>		0-127
Cost override for NLSP	<u>*CALC</u>		1-63, *CALC
Enable for IW2	<u>*YES</u>		*YES, *NO
IW2 timer request retries	<u>16</u>		1-256, *NOMAX
IW2 timer request interval	<u>20</u>		1-60
Additional Parameters			
Default maximum datagram size	<u>*LIND</u>		576-16388, *LIND
Throughput	<u>*CALC</u>		300-4294967295, *CALC
Delay time	<u>*CALC</u>		1-5000000, *CALC
Automatic start	<u>*YES</u>	8	*YES, *NO
RIP state	<u>*OFF</u>	9	*ON, *OFF, *AUTO
RIP update interval	<u>60</u>		30-300000
RIP age multiplier	<u>4</u>		1-10

Add IPX Circuit (ADDIPXCCT)

Type choices, press Enter.

SAP state	<u>*OFF</u>	10	*ON, *OFF, *AUTO
SAP update interval	<u>60</u>		30-300000
SAP age multiplier	<u>4</u>		1-10

Figure 34. Sample IPX Circuit for X.25 Line on System C

The important values in an IPX circuit for an X.25 SVC line are as follows:

Circuit Name

1 Use CCT2C for the IPX circuit name in this example.

Line Description

2 Identifies the line description that is associated with the circuit. CX25LINE is the name of the line description in this example.

X.25 PVC Logical Channel ID

3 Specifies the permanent virtual circuit (PVC) channel identifier that can be established on an X.25 circuit by the IPX support. Only 1 unique channel identifier may be specified. Valid ranges are 001 to FFF. The PVC value must have been previously specified on the X.25 line description value.



The X.25 PVC Logical Channel ID is only required if the SVC Network Address value is not specified and an X.25 line description is used.

X.25 SVC Network Address

4 Specifies the DTE that is associated with the remote X.25 system (that is, the DTE address of the remote system). The value can be a decimal number that is 1 through 17 digits in length.



The SVC Network Address is only valid for X.25 line descriptions. The PVC Logical Channel ID or the SVC Network Address must be specified if an X.25 line description is being used.

Use 0000009994 for the network address for System D in this example. This value must match the value in the line description on System D, and it must match the value specified at the remote system for its X.25 SVC local network address.

X.25 SVC Call Type

5 Specifies either an on-demand or a permanent X.25 SVC connection call.

- *DEMAND means that the SVC connection is established only when there is data to transfer to the remote destination. It is active for the duration of the data transfer plus the idle timeout value. The SVC connection is ended whenever the connection has not had any data for longer than the idle virtual circuit timeout value.
- *PERM means that the SVC connection is set up for data transfer when the circuit is activated. It is active for as long as the circuit is active. A permanent SVC connection is ended when the circuit is ended.
- *DEMAND is used for the sample network because the circuit is to be activated only when there is data to transfer to the remote systems.

X.25 Default Packet Size

6 Specifies the default packet size that is used by the X.25 network for transmission and reception. The values specified on this parameter should match the default values that are used by the X.25 network.

Transmit Packet Size

Specify a packet size for transmission. The valid values for the packet size are 64, 128, 256, 512, 1024, 2048, and 4096; *LIND is the default.

Receive Packet Size

Specify a packet size for reception. The valid values for the packet size are 64, 128, 256, 512, 1024, 2048, 4096, and *TRANSMIT; *LIND is the default.

X.25 Default Window Size

7 Specifies the packet window size for transmission to and reception from remote systems attached to an X.25 line.

Transmit Window Size

Specify the transmit window size. Valid values range from 1 through 7 for networks that use modulus 8 packet numbering. Valid values range from 1 through 15 for networks that use 128 packet numbering. The modulus value is specified on the X.25 line description; *LIND is the default.

Receive Window Size

Specify the appropriate default window size. Valid values range from 1 through 7 for networks that use modulus 8 packet numbering. Valid values range from 1 through 15 for networks that use 128 packet numbering. The modulus is specified on the X.25 line description; *LIND is the default.

Automatic Start

8 Specifies whether the IPX circuit is started automatically whenever IPX is started. The default is *YES. If you choose *NO, start the circuit yourself by using the Start IPX Circuit (STRIPXCCT) command or by selecting option 9 (Start) on the Work with IPX Circuits display.

RIP State

9 Specifies the routing information protocol (RIP) indicator mode of support on this circuit. Setting this parameter determines how RIP packets are processed on this circuit.



If you want to minimize RIP packets on your network but still need the support provided by RIP processing, you can set this parameter's value to *OFF and then define static routes associated with the system or systems with which you are networking. In order to fully minimize RIP traffic on your network, you would need to define static routes on all servers and routers in your network. You can define static routes by using the Add Circuit Route (ADDCCTRTE) command.

- *AUTO will initially disable the transmission of RIP broadcasts but will automatically enable RIP routing if non-NLSP devices are operating on the network. *AUTO allows the network to eliminate RIP processing once all routers and servers in the network are running NLSP.

- *ON enables RIP routing on this circuit and allows backward compatibility with RIP routers and servers that depend on RIP.
- *OFF disables RIP routing on this circuit and disables backward compatibility with RIP routers and servers that depend on RIP.

For our sample network, the RIP state value is *OFF to ensure that no RIP packets are sent over this circuit.

SAP State

10 Specifies the Service Advertising Protocol (SAP) indicator mode of support on this circuit. Setting this parameter will determine how SAP packets are processed on this circuit.



If you want to minimize SAP packets on your network but still need the support provided by SAP processing, you can set this parameter's value to *OFF and then define static services associated with the system or systems with which you are networking. In order to fully minimize SAP traffic on your network, you would need to define static services on all servers and routers in your network. You can define static services by using the Add Circuit Service (ADDCCTSRV) command.

- *AUTO initially disables the transmission of SAP broadcasts but will automatically enable SAP broadcasts if non-NLSP devices are operating on the network. *AUTO allows the network to eliminate SAP processing once all routers and servers in the network are running NLSP.
- *ON enables SAP broadcasts on this circuit and allows backward compatibility with SAP routers and servers that depend on SAP.
- *OFF disables SAP broadcasts on this circuit and disables backward compatibility with SAP routers and servers that depend on SAP.

For our sample network, the SAP state value is *OFF to ensure that no SAP packets are sent over this circuit.

The defaults are used for the other values in this IPX Circuit definition.

Sample X.25 Circuit Display

Figure 35 on page 56 shows the X.25 circuit we just added.

```

                                Display IPX Circuit

Circuit name . . . . . : CCT2C
Circuit status . . . . . : Inactive
Line description . . . . . : CX25LINE
Line type . . . . . : *X25
SVC network address . . . . . : 000009994
SVC call type . . . . . : *DEMAND
SVC reverse charge . . . . . : *NONE
Idle virtual circuit time out . . . . . : 60
Default packet size:
  Transmit . . . . . : *LIND
  Receive . . . . . : *LIND
Default window size:
  Transmit . . . . . : *LIND
  Receive . . . . . : *LIND
Enable for NLSP . . . . . : *YES
Cost override for NLSP . . . . . : *CALC
Default maximum datagram size . . . . . : *LIND

                                More...

Press Enter to continue.

F3=Exit  F12=Cancel

```

```

                                Display IPX Circuit

Throughput . . . . . : *CALC
Delay . . . . . : *CALC
Automatic start . . . . . : *YES
RIP:
  State . . . . . : *OFF
  Update interval . . . . . : 60
  Age multiplier . . . . . : 4
SAP:
  State . . . . . : *OFF
  Update interval . . . . . : 60
  Age multiplier . . . . . : 4

```

Figure 35. Display X.25 Circuit Example

Circuit Routes and Circuit Services—Overview

Adding circuit route and circuit service information is optional for any IPX network.



Novell calls these static routes and static services.

For the sample network, IPX circuit route entries are defined to the systems that are reachable by means of this X.25 circuit definition. In order for the token-ring network to be accessible from the Ethernet network, you must define circuit routes for systems in the token-ring network. Figure 36 shows these routes to System D, System E, System F, and System G.

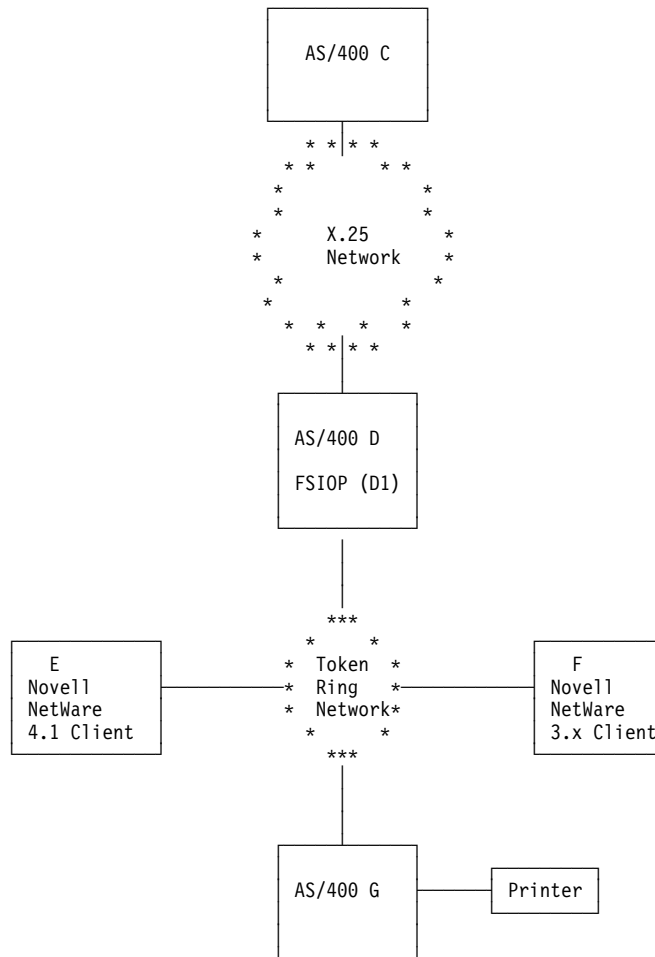

Figure 36. IPX Circuit Routes Example

Step 4—Adding Circuit Route Information

Circuit Routes or Static Routes

IPX support uses a routing protocol such as Routing Information Protocol (RIP) or NetWare Link Services Protocol (NLSP) to exchange network routing information.

If the routing protocols are not used, this section describes how to define the routing information for the local system.

If the local system is going to send data over an on-demand circuit, you must configure at least one static route. A *static route* defines the attributes that are associated with routing to that remote IPX node or network through a specific circuit. Each static route is associated with a circuit.

In most cases, multiple routes can be defined per circuit.



To add circuit routes, do the following:

1. Take option 1 from the Configure IPX menu, the Configure IPX Circuits menu is shown. See Figure 37 on page 58.

```

Configure IPX Circuits                                System:  SYSNAMXX
Select one of the following:
  1. Work with IPX circuits
  2. Work with IPX circuit routes
  3. Work with IPX circuit services

Selection or command
====> 2

F3=Exit  F4=Prompt  F9=Retrieve  F12=Cancel

```

Figure 37. Configure IPX Circuits Menu Example

2. Use option 2, *Work with Circuit Routes* on the Configure IPX Circuits menu. See Figure 38.
- The Work with Circuits display is shown.
3. Use option 1 to create the circuit route.

```

Work with Circuit Routes                                System:  SYSNAMXX
Type options, press Enter.
  1=Add  2=Change  4=Remove  5=Display

Opt  Circuit Name      Remote Network  Number of Hops  Number of Ticks  Next Hop Node Address
  1  CCT1D              00000001       2                12                *NONE

```

Figure 38. Work with Circuit Routes Display Example



Use the name of your system for the IPX description name.

- You do not need to, and in most cases will not use static route definitions for a LAN.
- A static route can be defined for a LAN circuit in order to minimize the amount of RIP packets on the LAN.
- If you do use static routes for a circuit (WAN or LAN), it is recommended that you set the RIP State value on the circuit definition to *OFF.
- The circuit must have been previously configured.

The Add Circuit Route prompt display is shown. See Figure 39 on page 59.

```

                                Add Circuit Route (ADDCCTRTE)

Type choices, press Enter.

Circuit name . . . . . _____
Remote IPX network number . . . . . _____ 00000001-FFFFFFE
Number of hops . . . . . _____ 1-127
Number of ticks . . . . . _____ 1-32767

```

Figure 39. Add Circuit Route Command Prompt Example

Because IPX routing information is not exchanged for on-demand WAN links, you must define static routes for all networks that you want to communicate through a WAN link.

Generally, you choose the internal IPX network number of these systems in the interconnected IPX networks. You must define the internal IPX networks for Systems D, E, F, and G in the sample IPX internetwork.

The important parameters in an IPX circuit route entry for an X.25 line description are as follows:

Circuit Name

Identifies the unique name of the circuit for which this static route is being defined. This is a required value. The static route is associated only with this circuit.

In this example, all of the circuit routes are associated with the previously defined IPX Circuit, CCT2C which is an X.25 SVC on demand type circuit.

Remote IPX Network Number

Identifies the remote network number or system this route connects to. The remote IPX network number is usually the internal IPX network number of the remote server or router. This is a required parameter value. The remote IPX network number is specified in the form, nnnnnnnn, where *nnnnnnnn* is a hexadecimal number ranging from 00000001 through FFFFFFFE.

In the sample network, you must be able to reach Systems D, E, F, and G through this circuit. Four circuit routes must be created, each specifying a different remote IPX network number.

Number of Hops

Specifies the number of hops to the remote network. The number of hops is equal to the number of routers that are crossed in order to reach the network or system identified by the Remote network number value. The number of hops must be less than or equal to the IPX hop count value that is associated with the local AS/400 active IPX description. If the number of hops for this route is greater than the IPX hop count value in the IPX description that is active at the time you are using IPX on the AS/400, then this route cannot be used by IPX.

The range of values that are allowed for this parameter is 1 to 127; the default is 1.

In the sample network, System D acts as a gateway system into the Token-Ring network, and is 1 hop away from System C. All of the other systems are 2 hops away from System C on this circuit.

Number of Ticks

Specifies the number of ticks that are needed to reach the destination network identified by the Remote network number. A tick is equal to 1/18th of a second. The maximum value that is allowed is 32767 ticks, which equals approximately 30 minutes. This value is usually used in comparison with tick values on other routes in the route table. It is used as a relative value that is compared to the other route entries.

In the sample network, System D is one hop away and therefore should be reachable in fewer ticks than systems E, F, and G. System D is 10 ticks away; System E, F, and G are 12 ticks away.

Sample Circuit Routes

Figure 40 shows the Add Circuit Route display for route 00000004.

```

                                Add Circuit Route (ADDCCTRTE)

Type choices, press Enter.

Circuit name . . . . . CCT2C
Remote IPX network number . . . 00000004 00000001-FFFFFFE
Number of hops . . . . . 1          1-127
Number of ticks . . . . . 10       1-32767
```

Figure 40. Add Circuit Route Example for IPX Network Number 00000004

Figure 41 shows the Add Circuit Route display for the route 00000005.

```

                                Add Circuit Route (ADDCCTRTE)

Type choices, press Enter.

Circuit name . . . . . CCT2C
Remote IPX network number . . . 00000005 00000001-F FFFFFFFE
Number of hops . . . . . 2          1-127
Number of ticks . . . . . 12       1-32767
```

Figure 41. Add Circuit Route Example for IPX Network Number 00000005

Figure 42 shows the Add Circuit Route display for the route 00000006.

```

                                Add Circuit Route (ADDCCTRTE)

Type choices, press Enter.

Circuit name . . . . . CCT2C
Remote IPX network number . . . 00000006 00000001-FFFFFFFE
Number of hops . . . . . 2          1-127
Number of ticks . . . . . 12       1-32767
Next hop node address. . . . . *NONE 020000000000-7FFFFFFF
Route source. . . . . *CFG
```

Figure 42. Add Circuit Route Example for Route 00000006

Figure 43 on page 61 shows the Add Circuit Route display for the route 00000007.

```

Add Circuit Route (ADDCCRTE)

Type choices, press Enter.

Circuit name . . . . . CCT2C 1
Remote IPX network number . . . . . 00000007 2 00000001-FFFFFFE
Number of hops . . . . . 2 3 1-127
Number of ticks . . . . . 12 4 1-32767
Nexthop node address . . . . . None 5 02000000000-7FFFFFFF
Route source . . . . . *CFG

```

Figure 43. Add Circuit Route Example for Route 00000007

The Work with Circuit Routes display shows the routes we have just added. See Figure 44 on page 61.

```

Work with Circuit Routes

Type options, press Enter.
1=Add 2=Change 4=Remove 5=Display

System: SYSNAMXX

Opt  Circuit Name      Remote Network  Number of Hops  Number of Ticks  Next Hop Node Address
-----
5  CCT2C                00000004       2                12               *NONE
-   CCT2C                00000005       2                12               *NONE
-   CCT2C                00000006       2                12               *NONE
-   CCT2C                00000007       2                12               *NONE

```

Figure 44. Work with Circuit Routes Display Example

Use option 5 to display one of the circuit routes you just created. See Figure 45.

```

Display Circuit Route (DPCCTRTE)

Circuit name . . . . . : CCT2C
Remote IPX network number . . . . . : 00000004
Number of hops . . . . . : 1
Number of ticks . . . . . : 10
Next hop node address . . . . . : *NONE
Route source . . . . . : *CFG

```

Figure 45. Display Circuit Route Command Prompt Example

Step 5—Adding Circuit Service Information

Circuit Services or Static Services

IPX Support uses the Service Advertising Protocol (SAP) or the NetWare Link Services Protocol (NLSP) to convey information about network services and the addresses of those network services. Through SAP, servers advertise their services and addresses. This is usually accomplished on a LAN by using SAP broadcast packets. Routers maintain the list of available services that are based on the SAP broadcast packets. When a client needs a service, it can find that service and where the service resides on the network from the routers.

If NLSP or SAP are not used, this section describes how to define the services information for the local system.

If the local system is going to access a service over an on-demand circuit, you must configure a static service for that circuit.

A *static service* is a specification of a service available on a remote IPX node or network through a particular circuit. A static service also defines the attributes that are associated with a service on a remote IPX node or network. Each static service is associated with a circuit. Multiple services can be defined for each circuit. See Figure 46.

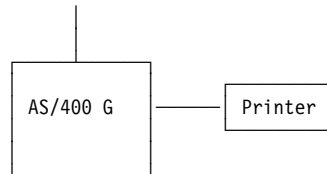

Figure 46. Adding a Static Service to the Network Example



To add a circuit service to the sample network, do the following:

1. Use Option 3, Work with Circuit Services, on the Configure IPX Circuits display.
2. Use option 1, to add a circuit service to our network. See Figure 47.

Work with Circuit Services				
Type options, press Enter.				System: SYSNAMXX
1=Add 2=Change 4=Remove 5=Display				
Opt	Circuit Name	Service Name	Service Type	Remote Network
<u>1</u>	_____	_____	_____	

Figure 47. Work with Circuit Services Display Example

The Add Circuit Service prompt display is shown in Figure 48 on page 63.



Tips:

- You do not need to, and in most cases will not, use static services for a LAN.
- A static service can be added for a LAN circuit, in order to minimize the amount of SAP packets on the LAN.
- If you do use static services for a circuit (WAN or LAN), it is recommended that you set the SAP state value on the circuit definition to *OFF.
- A circuit may have multiple services added to it, but each service must have a unique service name and service type combination.

```

Add Circuit Service (ADDCTSRV)

Type choices, press Enter.

Circuit name . . . . . CCT2C
Service name . . . . . > 'network printer'
Service type . . . . . *PRTSVR 0000-FFFF, *ADVPRTSVR...
Remote IPX network number . . . 6 00000001-FFFFFFE
Remote IPX node address . . . . 4000000000ED 00000000001-FFFFFFFEE
Remote socket address . . . . . 0001 0001-FFFF
Number of hops . . . . . 2 1-127

```

Figure 48. Add Circuit Service Command Prompt Example

Circuit Name

Identifies unique name of the circuit that this static service is reached from. This is a required value. The static service is associated only through this circuit.

For the sample network, CCT2C is an X.25 SVC on-demand type circuit. This is the name of the circuit we created under “Step 3–Adding an IPX Circuit for an X.25 SVC Line” on page 52.

Service Name

Identifies the name of the service available on the remote system. This is a required value.

The service name can be 1 to 48 characters; the last character must be a null character. Therefore, the actual size of the service name is 47 characters plus the null character. Any characters in the 7-bit ASCII code page 1009 are allowed for this value except for the following:

- slash (/)
- back slash (\)
- semicolon (;)
- colon (:)
- comma (,)
- asterisk (*)
- question mark (?)
- plus sign (+)
- greater than (>)
- less than (<)



If there is not a translation table available on your system to translate from the job CCSID or if the job CCSID is 65535, you cannot add, change, remove, or display a circuit service because the translation from the OS/400 EBCDIC to ASCII 850 has not occurred.

Service Type

Specifies the type of service available on the remote system. This is a required parameter. A set of special values are allowed, including *PRTQ and *FILESVR, that represent the well known server type values. You can also enter a 2-byte hexadecimal value.



The hexadecimal values of 0000 through 8000 and FFFF are reserved service type values.

For a list of these special values, see the “Add Circuit Service (ADDCCTSRV) command” in the *CL Reference* book.

Remote Network Number

Identifies the remote IPX network number where this service can be found. If this service is available on a server or router, the service IPX network number should be equal to the internal network number of that server or router. This is a required value.

The service IPX network number is specified in the form `nnnnnnnn`, where `nnnnnnnn` is a hexadecimal number ranging from 00000001 through FFFFFFFE.

Remote Node Address

Identifies the node address where the service resides. If this service is available on a NetWare 3.X or 4.X server or router, the service IPX node address should be 1. If the server or router does not have an internal network number, such as a NetWare 2 file server, specify the NIC (network interface card) or MAC address of the server adapter for the service IPX node address. This is a required parameter.

The service IPX node address is specified in the form, `nnnnnnnnnnnn`, where `nnnnnnnnnnnn` is a 6-byte hexadecimal number ranging from 000000000001 through FFFFFFFF.

Remote Socket Address

Identifies the socket on which this service listens for incoming requests. This is the socket address that is found on the remote system. For example, for file services, the standard socket address is hexadecimal 0451. The socket address is a 2-byte hexadecimal value that can range from hexadecimal 0001 to FFFF. This is a required parameter.

Number of Hops

Specifies the number of hops to the remote network. The number of hops is equal to the number of routers that are crossed in order to reach the network or system identified by the remote network number value. The number of hops must be less than or equal to the IPX hop count limit that is associated with the local AS/400 active IPX description. If the number of hops for this service is greater than the IPX hop count for the IPX description that is active at the time you are using IPX on the AS/400, then you will be unable to reach this service.

Possible values are 1 to 127; the default is 1.

Sample Circuit Services

After pressing Enter from the Add Circuit Service (ADDCCTSRV) display, the Work with Circuit Services display shows the services available on the circuit. See Figure 49.

```
Work with Circuit Services
SYSTEM:  SYSNAMXX
Type options, press Enter.
5=Display
```

Opt	Circuit Name	Service Name	Service Type	Remote IPX Network
5	CCT2C	Network Printer	*PRTSRV	00000006

Figure 49. Work with Circuit Services Display Example

Use option 5 to display a circuit service. See Figure 50.

```
Display Circuit Service (DSPCCTSRV)
Circuit name . . . . . : CCT2C
Service name . . . . . : Network Printer
Service type . . . . . : *PRTSVR
Remote IPX network number . . . . . : 6
Remote node address . . . . . : 4000000000ED
Remote socket address . . . . . : 0001
Number of hops . . . . . : 2
Service source . . . . . : *CFG
```

Figure 50. Display Circuit Services Command Prompt Example



Add Circuit Service (ADDCCTSRV) command can also be used to add the definition of a static service to a circuit in the IPX configuration.

Sample CL Program

For the complete CL program for the configuration example, see Appendix A, CL Program for the IPX Configuration Example.

Additional IPX Configuration Options

The Configure IPX Menu contains other options to work with the IPX support on the system.

- To start IPX support, go to “Starting and Ending IPX Support” on page 67.
- To learn more about working with IPX status, starting IPX support, and ending IPX support, go to Operating and Managing IPX Support.
- To learn more about routing, go to Advanced IPX Configuration.
- To configure AnyNet/400 over IPX, go to IPX Support and AnyNet/400.

Operating and Managing IPX Support

Starting and Ending IPX Support	67
Before You Start IPX Support	67
Configuration	67
IPX Jobs	68
Starting IPX	69
Ending IPX	70
IPX Status Support	72
Work with IPX Status Menu	72
Working with IPX Circuit Status	72
Displaying IPX Circuits	73
Working with Associated Routes and Services	74
Displaying IPX Route Information	78
Displaying IPX Service Information	79
Working with IPX/SPX Connection Status	81
Displaying IPX and SPX Connections	83
Ending IPX Connections	85
Displaying an Active IPX Description	86

This chapter discusses starting and ending IPX support and managing your system IPX processing by using the Work with IPX Status menu.

Simple Network Management Protocol (SNMP can manage IPX support on AS/400 systems). For information on SNMP, see the *Simple Network Management Protocol (SNMP) Support* book.

The IPX configuration commands, commands for activating IPX support, and the commands for deactivating IPX support require special authority. Refer to Appendix C, Security for IPX Commands and Objects for more information.

Starting and Ending IPX Support

IPX support runs in various jobs in the QSYSWRK subsystem. You can start and end IPX support by using menus or commands.

You must start IPX support by using the Start IPX (STRIPX) command before attempting to use the OS/400 IPX support.

Before You Start IPX Support

Consider the following before starting IPX support:

Configuration

If you want your AS/400 system to operate within an IPX network, you must have previously configured IPX as described in “Configuring the Internetwork Packet Exchange (IPX) Support” on page 19.

IP over IPX jobs can also be started automatically when IPX is activated. If you plan on using AnyNet/400 support for IP over IPX or APPC over IPX, then you need to do further configuration. This is described in IPX Support and AnyNet/400.

IPX Jobs

All IPX application jobs run in the QSYSWRK subsystem. You can monitor these jobs using the Work with Active Jobs (WRKACTJOB) command:

WRKACTJOB SBS(QSYSWRK)

```

Work with Active Jobs
                                SYSNAMXX
                                02/09/96 16:23:30
CPU %:      .0      Elapsed time: 00:00:00      Active jobs: 47

Type options, press Enter.
  2=Change  3=Hold  4=End  5=Work with  6=Release  7=Display message
  8=Work with spooled files  13=Disconnect ...

Opt  Subsystem/Job  User      Type  CPU %  Function      Status
---  -
---  QSYSWRK         QSYS      SBS   .0     DEQW          DEQW
---  QAPPCIPX        QSYS      BCH   .0     TIMW          TIMW
---  QDIRSHDCTL      QDOC     BCH   .0     * -DIRSHD     EVTW
---  QIPX            QSYS      BCH   .0     DEQW          DEQW
---  QMSF            QMSF     BCH   .0     DEQW          DEQW
---  QTCTPIP         QTCP     BCH   .0     DEQW          DEQW
---  QTFTP06532     QTCP     BCH   .0     DEQW          DEQW
---  QTFTP07069     QTCP     BCH   .0     DEQW          DEQW

Parameters or command
===>
F3=Exit    F5=Refresh  F10=Restart statistics  F11=Display elapsed data
F12=Cancel F23=More options  F24=More keys
More...

```

```

Work with Active Jobs
                                SYSNAMXX
                                02/09/96 16:23:30
CPU %:      .0      Elapsed time: 00:00:00      Active jobs: 47

Type options, press Enter.
  2=Change  3=Hold  4=End  5=Work with  6=Release  7=Display message
  8=Work with spooled files  13=Disconnect ...

Opt  Subsystem/Job  User      Type  CPU %  Function      Status
---  -
---  QTVDEVMGR       QSYS     BCH   .0     PGM-QTVDMGR  TIMW
---  QTVDEVMGR       QSYS     BCH   .0     PGM-QTVDMGR  TIMW
---  QTVIPXTELN     QSYS     BCH   .0     PGM-QTVTELN  TIMW
---  QTVIPXTELN     QSYS     BCH   .0     PGM-QTVTELN  TIMW

```

Figure 51. Work with Active Jobs Display Example

The jobs that are started by the Start IPX (STRIPX) command are the following:

Job Name Description

QIPX Main IPX job

QAPPCIPX APPC over IPX applications

QTVIPXTELN TELNET over IPX job

QTVDEVMGR TELNET Device Manager job



Notes:

- There may be other jobs running in the QSYSWRK subsystem that are not associated with the OS/400 IPX support.
- The IPX jobs in QSYSWRK run under the QSYS user profile.
- The job description that is used for the QIPX job is QSYS/QZSPJOB). The job description for QAPPCIPX job is QSYS/QZSPSNAIPX.
- To use APPC over IPX applications, you must set the network attribute Allow AnyNet (ALWANYNET) to *YES and activate IPX support using the STRIPX command.

Starting IPX

You must issue the Start IPX (STRIPX) command before any IPX processing can be performed on the AS/400.

The STRIPX command is used to:

- Initialize and activate IPX processing
- Start the QIPX job in the QSYSWRK subsystem
- Start the QTVIPXTELN jobs in the QSYWRK subsystem
- Start the QTVDEVMGR jobs in the QSYWRK subsystem
- Start the IPX circuits that have AUTOSTART set to *YES



Notes:

- If the network attribute Allow AnyNet (ALWANYNET) is set to *YES when you enter the STRIPX command or, if you change the attribute from *NO to *YES when IPX is already active, the following occurs:
 - The SNA over IPX support is activated, which includes starting the QAPPCIPX job in the QSYSWRK subsystem
 - The IP over IPX support is activated
 - The IP over IPX interfaces are started
- To use Client Access/400 over IPX after you start IPX, you may need to end and then restart the host servers by using the ENHOSTSVR and STRHOSTSVR commands.



To start IPX support, do the following:

1. Type STRIPX and press F4. Figure 52 on page 70 is shown.
2. Enter the name of the IPX description you want to start.
Use SYSTEMA for our sample network.

```

                                Start IPX (STRIPX)

Type choices, press enter.

IPX description . . . . .          SYSTEMA

```

Figure 52. Start IPX Command Prompt Example

For additional information, see the “Start IPX (STRIPX) command” in the *CL Reference* book.

Ending IPX

Use the End IPX (ENDIPX) command to end all IPX processing.

Attention

No confirmation display is shown when the ENDIPX command is entered. The ENDIPX command immediately ends all IPX processing on the AS/400 that are active.

The ENDIPX command causes the following to occur:

- No new open operations are allowed to IPX or SPX.
- All IPX and SPX connections are ended.
- All active IPX circuits are ended.
- The QIPX job in QSYSWRK is ended.
- The QTVIPXTELN jobs in QSYSWRK are ended.



QTVDEVMGR jobs remain active after IPX is ended. The device manager jobs are only ended when the QSYSWRK subsystem is ended.

If the ALWANYNET network attribute is set to *YES when the ENDIPX command is entered, the following occurs in addition to the above list of actions:

- The QAPPCIPX job in the QSYSWRK subsystem ends.
- All IP over IPX interfaces are ended.
- The IP over IPX support is deactivated.
- The SNA over IPX support is deactivated.



To end IPX, do the following:

1. Type ENDIPX and press F4. See Figure 53 on page 71.

```

Type command, press Enter.
===> ENDIPX

-----
-----

F3=Exit   F4=Prompt   F9=Retrieve   F10=Include detailed messages
F11=Display full   F12=Cancel   F13=Information Assistant   F24=More keys

```

The following message is displayed.

```

> ENDIPX
ENDIPX successfully completed.

Type command, press Enter.
===> _____

-----
-----

F3=Exit   F4=Prompt   F9=Retrieve   F10=Include detailed messages
F11=Display full   F12=Cancel   F13=Information Assistant   F24=More keys

```

Figure 53. End IPX Display Example



The ENDIPX command should be used carefully. Partially updated data may result if an application is processing data and has not completed an operation when this command is issued. Do the following:

1. Notify all users before issuing the command so that they can end their applications.
2. Issue the ENDIPX command at a time when you know that no IPX activity is occurring on the system.



To display the current IPX activity on the AS/400 system, choose option 3, *Work with IPX Status* from the Configure IPX menu, and then choose option 4. *Work with IPX Connection Status* from the Work with IPX Status menu. The Work with IPX/SPX Connection Status menu is described under “IPX Status Support” on page 72.

The ENDIPX command does not end the NetWare Support processing. For IPX considerations for NetWare Support, see Advanced IPX Configuration.

For additional information, see the “End IPX (ENDIPX) command” in the *CL Reference* book.

You can also use option 10 on the Work with IPX Circuit Status display to end IPX processing.

IPX Status Support

The IPX status support on AS/400 systems allows you to get information about the status of IPX circuits, routes, services, and connections on your local system. You can also display the active IPX description.

Work with IPX Status Menu

The Work with IPX Status menu allows you to work with the various network status functions.



To display the Work with IPX Status menu:

1. Enter GO CFGIPX or CFGIPX on any AS/400 command line.
2. Type 3 on the command line of the Configure IPX menu.
3. Press the Enter key. The following display (Figure 54) is shown.

```
                                Work with IPX Status
                                SYSTEM:  SYSNAMXX

Select one of the following:

    1. Work with IPX circuit status
    2. Display IPX route information
    3. Display IPX service information
    4. Work with IPX/SPX connection status
    5. Display active IPX description
```

Figure 54. Work with IPX Status Menu Example

The Work with IPX Status menu can also be displayed using the Work with IPX Status (WRKIPXSTS) command with or without the option parameter.

WRKIPXSTS or WRKIPXSTS OPTION(*Select)

The OPTION parameter gives you a fast method to go directly to one of the specific displays that can be selected from the IPX Status menu or to go directly to the IPX Status menu.

Working with IPX Circuit Status

The Work with IPX Circuits Status display, that is shown in Figure 55 on page 73, provides the most current summary of circuit activity. This display allows you to view IPX circuit information for selected circuits and to start or end IPX circuits.



To view the Work with IPX Circuits Status display:

1. Type 1 on the command line of the Work with IPX Status menu.
2. Press the Enter key.

See Figure 55 on page 73.

Work with IPX Circuits Status				
				SYSTEM: SYSNAMXX
Type options, press Enter.				
5=Display details 7=Display associated services				
8=Display associated routes 9=Start 10=End				
12=Work with configuration status				
Opt	Circuit Name	Line Description	Line Type	Circuit Status
—	CCTC2	TRNLINE	*TRLAN	Active
—	CCTC3	X25PVC	*X25	Inactive
—	CCTC4	X25SVC	*X25	Inactive

Figure 55. Work with IPX Circuits Status Display Example

The WRKIPXSTS command can also be used to go directly to this display by entering the following command:

```
WRKIPXSTS OPTION(*CCT)
```

Displaying IPX Circuits

To display more detailed information about the status for specific IPX circuits:

1. On the Work with IPX Circuit Status display, type 5 in the option field for each circuit that you want more information about.
2. Press the Enter key.

If you requested status for a token-ring circuit, the information is displayed as shown in Figure 56 on page 74. The information that is displayed for a LAN circuit is slightly different from that for a WAN circuit.

Referring back to our definition of LANs and WANs, “IPX Network” on page 10 may help you as you view the circuit descriptions.

```

                                Display IPX Circuit
Circuit name . . . . . : CCTC2
Circuit status . . . . . : Active
Line description . . . . . : TRNLINE
Line type . . . . . : *TRLAN
IPX network number . . . . . : 00000123
Frametype . . . . . : *SSAP
Node address . . . . . : 400001234567
Enable for NLSP . . . . . : *YES
MAC channel for NLSP . . . . . : *BROADCAST
Router priority for NLSP . . . : 44
Cost override for NLSP . . . . : *CALC
Enable for IW2 . . . . . : *YES
Default maximum datagram size: 576
Throughput . . . . . : 394967295
Delay . . . . . : 200
Automatic start . . . . . : *YES

```

```

                                Display IPX Circuit

RIP:
State . . . . . : *AUTO
Update interval . . . . . : 60
Age multiplier . . . . . : 4
SAP:
State . . . . . : *AUTO
Update interval . . . . . : 60
Age multiplier . . . . . : 4

Change date/time . . . . . : 08/06/95 10:16:34

```

Figure 56. Display IPX Circuit LAN Example

If you have requested circuit status information for more than one circuit, press the Enter key to view the remaining displays.

Working with Associated Routes and Services

The following tasks can also be completed from the Work with IPX Circuit Status menu.

Displaying Associated Services: To display information about the services associated with a specific circuit:

1. On the Work with IPX Circuit Status display, type 7 in the option field for each circuit for which you want to see the associated service information.
2. Press the Enter key.

See Figure 57 on page 75 for an example of the Associated Services display.

If you have requested associated service information for more than one circuit, press the Enter key to view the remaining displays.

```

                                Display Associated Services
                                SYSTEM:  SYSNAMXX
Circuit name . . . . . : CCTC2

Type options, press Enter.
5=Display details

Opt   Service      Service      Remote      Hops to      Service
  —   Name         Type         Network     Service      Source
  —   —           —           —           —           —
  —   Print Server *PRTSVR     00000006    2            *CFG

```

Figure 57. Display Associated Services Example

For more information about each field on the display, see the online help information.

Displaying Service Details: To display detailed information about the service:

1. On the Display Associated Services display, type 5 in the option field for each service that you want more information about.
2. Press the Enter key.

See Figure 58 for an example.

```

                                Display Circuit Service (DSPCCTSRV)
                                System:  SYSNAMXX
Service information:
Circuit name . . . . . : CCTC2
Service name . . . . . : Print Server

Service type . . . . . : *PRTSVR
Remote IPX network number . . . . . : 00000006
Remote node address . . . . . : 4000000000ED
Remote socket . . . . . : 0001
Number of hops . . . . . : 2
Service source . . . . . : *CFG

```

Figure 58. Display IPX Service Details Example

Displaying Associated Routes: To display information about the routes associated with a specific circuit:

1. On the Work with IPX Circuit Status display, type 8 in the option field for each circuit for which you want to see the associated routes information.
2. Press the Enter key, the associated route information display is shown. See Figure 59 on page 76.

If you have requested associated route information for more than one circuit, press the Enter key to view the remaining route information.

```

                                Display Associated Routes
                                SYSTEM:  SYSNAMXX
Circuit name . . . . . : CCTC2

Type options, press Enter.
5=Display details

Opt      Remote      Number      Number      Next Hop      Route
  _      Network     of Hops     of Ticks     Node Address   Source
-----  -
00000034  1           10         *NONE         *CFG

```

Figure 59. Display Associated Routes Example

Displaying Route Details: To display detailed information about the route:

1. On the Display Associated Routes display, type 5 in the option field for each route that you want more information about.
2. Press the Enter key.

Figure 60 is an example.

```

                                Display IPX Route Details
                                System:  SYSNAMXX

Route information:
Circuit name . . . . . : CCTC2
Remote IPX network number . . . . . : 00000034
Number of hops . . . . . : 1
Number of ticks . . . . . : 10
Next hop node address . . . . . : *None
Route source . . . . . : *CFG

```

Figure 60. Display IPX Route Details Example



The circuit information is shown only when this is a locally known circuit.

Starting IPX Circuits: IPX circuits can be started using either the:

Work with IPX Circuit Status menu

or the

Start IPX Circuit (STRIPCCT) command

Work with IPX Circuit Status				
				SYSTEM: SYSNAMXX
Type options, press Enter.				
5=Display details 7=Display associated services				
8=Display associated routes 9=Start 10=End				
12=Work with configuration status				
Opt	Circuit Name	Line Description	Line Type	Circuit Status
—	CCTC2	TRNLINE	*TRLAN	Active
—	CCTC3	X25PVC	*X25	Inactive
—	CCTC4	X25SVC	*X25	Inactive

Figure 61. Work with IPX Circuits Status Display Example

To start an IPX circuit from the Work with IPX Circuit Status menu, do the following:

1. Type 9 in the option field for each circuit that you want to start.
2. Press the Enter key.

To start an IPX circuit by using the STRIPXCCT command:

1. Type STRIPXCCT on the command line.
2. Press F4 (Prompt).
3. Type the circuit name of the IPX circuit you want to start.
4. Press the Enter key.

For more information, see the “Start IPX Circuit (STRIPXCCT) command” in the *CL Reference* book.

Ending IPX Circuits: The End IPX Circuit (ENDIPXCCT) command ends an existing IPX circuit immediately. As a result, all IPX connections by using this circuit also end immediately. However, the operation of any other IPX or IP over IPX interface that is using the same line description as the circuit being ended is not affected.

IPX circuits can be ended using either the:

- Work with IPX Circuits Status display
- or the
- End IPX Circuit (ENDIPXCCT) command

To end an IPX circuit from the Work with IPX Circuit Status display:

1. Type 10 in the option field for each circuit that you want to end.
2. Press the Enter key.

To end an IPX circuit by using the ENDIPXCCT command:

1. Type ENDIPXCCT on the command line.
2. Press F4 (Prompt).
3. Type the circuit name of the circuit you want to end.
4. Press the Enter key.

```

                                Confirm End of IPX Circuits
                                System:  SYSNAMXX
Press Enter to confirm your choices for 10=End.
Press F12 to return to change your choices.

Opt      Circuit      Line      Line      Circuit
10       CCTC2       TRLINE   *TRLAN   Active

```

Figure 62. Confirm End of IPX Circuit Display Example

For more information, see the “End IPX Circuit (ENDIPXCCT) Command” in the *CL Reference* book.

Working with Configuration Status: To check the status of the line description that is used by a circuit:

1. On the Work with IPX Circuit Status menu, type 12 in the option field for each circuit that you want to work with.
2. Press the Enter key.

Using the options that are shown in Figure 63 you can vary a line description on or off, display the Work with Job menu, and display the line description or mode status.

```

                                Work with Configuration Status
                                02/06/96 15:55:58  SYSNAMXX
Position to . . . . . _____ Starting characters

Type options, press Enter.
 1=Vary on   2=Vary off   5=Work with job   8=Work with description
 9=Display mode status ...

Opt  Description      Status      -----Job-----
      TRNLIN          ACTIVE
      TRNLIN          ACTIVE
      TRNLIPX         ACTIVE      QIPX      QSYS      017486

```

Figure 63. Work with Configuration Status Display Example

Displaying IPX Route Information

You can view information about IPX circuit routes.

To display circuit route information:

1. On the Work with IPX Status display, type 2 on the command line.
2. Press the Enter key.

The Display IPX Route Information display is shown, as in Figure 64 on page 79.

```

                                Display IPX Route Information
                                System:  SYSNAMXX

Type options, press Enter.
  5=Display details

  Opt      Remote      Number      Number      Next Hop      Route
  ---      Network     of Hops     of Ticks     Node Address  Source
  ---      ---         ---         ---         ---          ---
  ---      00000004    2           10          *NONE        *CFG

```

Figure 64. Display IPX Route Information Display Example

The routes that are shown on this display are only the best routes that are known to OS/400 IPX support to reach the remote network. There might be a route configured for a circuit on the AS/400 but the route is not the best route available to reach the remote network. That route will *not* be shown on the Display IPX Route Information display.

To view detailed information about a specific route, type 5 in the option field next to the route and press the Enter key, to see the display shown in Figure 65.

```

                                Display IPX Route Details
                                System:  SYSNAMXX

Route information:
Remote IPX network number . . . . . : 00000004
Number of hops . . . . . : 2
Number of ticks . . . . . : 10
Next hop node address . . . . . : *NONE
Route source . . . . . : *CFG
Change date/time . . . . . : 08/06/95 12:03:43

Local circuit information:
Circuit name . . . . . : CCTC2
Circuit status . . . . . : Active
Line description . . . . . : TRNLINE
Line type . . . . . : *TRLAN
IPX Network number . . . . . : 00000123
Node address . . . . . : 400001234567
Maximum packet size . . . . . : 576

```

Figure 65. Display IPX Route Details Example



The Work with IPX Status (WRKIPXSTS) command can also be used to access IPX route information.

WRKIPXSTS OPTION(*RTE)

Displaying IPX Service Information

You can view information about IPX services including: print serving, printer queues, and file serving. To display IPX service information:

1. Type 3 on the command line of the Work with IPX Status display
2. Press the Enter key.

The Display IPX Service Information list is shown. See Figure 66 on page 80.

The services that are shown on this display are only the nearest instance of that service reachable from OS/400 IPX support. Some services that have been configured for a circuit on this AS/400, but are not the best one to reach that service, will *not* display on the Display IPX Service Information display.

Display IPX Service Information					
Type options, press Enter. 5=Display details					System: SYSNAMXX
Opt	Service Name	Service Type	Remote Network	Hops to Service	Service Source
—	File server 2	0004	A0826103	5	*SAP
—	Job server 1	0005	17590106	13	*SAP
—	Print server 9	0007	70452655	8	*SAP
—	Data server B	440A	A0826103	5	*SAP

Figure 66. Display IPX Service Information Example

To display this information,

1. Type 5 in the option field of the Display Service Information display.
2. Press the Enter key.

Option 5 displays the details about a specific service. See Figure 67 for an example.

Display IPX Service Details	
Service information:	
Service name	File server 2
Service type	0004
Remote IPX network number	A0826103
Remote node address	4000A5296233
Remote socket	0783
Hops to service	5
Service source	*SAP
Change date/time	08/06/95 12:38:12
Local circuit information:	
Circuit name	CCTC2
Circuit status	Active
Line description	TRNLINE
Line type	*TRLAN

Display IPX Service Details	
Network number	
Node address	00000123
Maximum packet size	400001234567
	576

Figure 67. Display IPX Service Details Example

If the local circuit that is associated with the services is known, the circuit information is displayed.



The WRKIPXSTS command can also be used as a fast path method to go to the IPX Service Information display.

```
WRKIPXSTS OPTION(*SRV)
```

Working with IPX/SPX Connection Status

The Work with IPX/SPX Connection Status display allows you to display or end an IPX connection between a local system and a remote system.

When you display an SPX2 connection, the following state Values are possible:

Negotiating

This state occurs during connection establishment. This state involves negotiating with the remote system for support of SPX2, maximum packet size, and other SPX2 options.

Renegotiating

This state occurs during the reestablishment of an existing SPX2 connection following a route failure.

Release-wait-1

This state occurs during the orderly release of a connection. The local system has sent a request for an orderly release, and is waiting for an acknowledgement from the other system.

Release-wait-2

This state occurs during the orderly release of a connection. The local system has already sent a request for an orderly release. The remote system has responded with an acknowledgement, and the local system is waiting for an orderly release request from the remote system.

Close-wait

The remote system has sent a request for an orderly release, the local SPX support has informed the application program that the orderly release request has been received, and the remote system is waiting for a close from the local application program.

Last-ACK

This state occurs during the orderly release of a connection. Orderly release requests have been sent by both the remote and local system, and the local system is waiting for a final orderly release acknowledgment from the remote system.



These connection states are only possible if both sides of the connection support the SPX2 protocol.



To display the Work with IPX Connection Status display:

1. Type 4 on the command line of the Work with IPX Status menu.
2. Press the Enter key.

The Work with IPX/SPX Connection Status display is shown in Figure 70 on page 82.

```

Work with IPX/SPX Connection Status
System:  SYSNAMXX

Type options, press Enter.
  4=End  5=Display details

  Opt  Remote  Remote  Remote  Local
      Network Node Address Socket Socket Idle Time State
  ---  *      *      *      *      *      *
  ---  A0826103 4000A5296233 416A 41AF 017:45:17 Established
  
```

Press the F11 key to display more information about each connection.

Figure 68. Work with IPX/SPX Connection Status (1 of 3)

```

Work with IPX/SPX Connection Status
System:  SYSNAMXX

Type options, press Enter.
  4=End  5=Display details

  Opt  Remote  Remote  Remote  Local  Type  Bytes Out  Bytes In
      Network Node Address Socket Socket *IPX *SPX
  ---  *      *      *      *      *      *
  ---  A0826103 4000A5296233 416A 41AF *SPX 436470 5700
  
```

Press the F11 key to display the user of each connection.

Figure 69. Work with IPX/SPX Connection Status (2 of 3)

```

Work with IPX/SPX Connection Status
System:  SYSNAMXX

Type options, press Enter.
  4=End  5=Display details

  Opt  Remote  Remote  Remote  Local  User
      Network Node Address Socket Socket
  ---  *      *      *      *      *
  ---  A0826103 4000A5296233 416A 41AF QSYS
  ---  JDOE
  
```

Figure 70. Work with IPX/SPX Connection Status Display Connection State Example (3 of 3)

When an application requests a connection to a listening socket, a new connection is created. The remote network number and node address are shown for the new connection. The listening sockets always remain in the list of connections.



The WRKIPXSTS command can also be used reach the Work with IPX/SPX Connection Status display.

WRKIPXSTS OPTION(*CNN)

Displaying IPX and SPX Connections

You can request more detailed information for IPX connections shown on the Work with IPX/SPX Connection Status display. This information includes timing information and transmission statistics for the connection that is displayed.

To display more information about the listed connections:

1. Type 5 in the option field for each connection that you want more information about.
2. Press the Enter key.

A series of up to four displays for each connection is presented.

The contents of the displays vary depending on the type of connection: IPX or SPX. The displays in Figure 71 on page 84 are for an SPX connection.

```

Display SPX Connection Status
System:  SYSNAMXX

Connection information:
Remote IPX network number . . . . . : A0826103
Remote node address . . . . . : 4000A5296233
Remote socket . . . . . : 416A
Local IPX network number . . . . . : 00000123
Local node address . . . . . : 400001234567
Local socket . . . . . : 41AF
Local connection ID . . . . . : 6001
Remote connection ID . . . . . : 5003
SPX socket type . . . . . : *STREAM
Associated user profile . . . . . : BAARTMAN

Connection state information:
State . . . . . : Established
Connection open type . . . . . : Active
Idle time . . . . . : 002:52:25.821
Last activity date/time . . . . . : 03/11/97 19:08:42

```

```

Display SPX Connection Status
System:  SYSNAMXX

Bytes out . . . . . : 33721
Outgoing bytes buffered . . . . . : 0
Sequence number of next outgoing byte . . . : 33721
Send unacknowledged . . . . . : 33721

Packets out . . . . . : 691
Outgoing window number . . . . . : 706
Sequence number of next outgoing packet . . : 691
Send unacknowledged . . . . . : 691

Bytes in . . . . . : 41237
Incoming bytes buffered . . . . . : 0
Sequence number of next incoming byte . . . : 41237

```

```

Display SPX Connection Status
System:  SYSNAMXX

Packets in . . . . . : 1383
Incoming packets buffered . . . . . : 0
Incoming window number . . . . . : 1390
Sequence number of next incoming packet . . : 1383

Connection error information:
Number of retransmissions . . . . . : 0
Number of are you there packets sent . . . . : 346
Number of verify packets sent . . . . . : 0

Connection timing information:
Are you there timeout . . . . . : 60000
Verify timeout . . . . . : 30000
Abort timeout . . . . . : 60000
Retransmission timeout . . . . . : 4396

```

```

Display SPX Connection Status
System:  SYSNAMXX

Connection initialization information:
Maximum packet size . . . . . : 1991
SPX connection type . . . . . : *SPX2

Watchdog enabled . . . . . : Yes

```

Figure 71. Display SPX Connection Status Example

To look at an IPX connection, press Enter to return to the SPX/IPX connection status display.

1. Type a 5 next to the IPX connection you want to display.
2. Press the Enter key.

See Figure 72.

```

                                     Display IPX Connection Status
                                     System:  SYSNAMXX

Identification information:
Local IPX network number . . . . . : 00000123
Local node address . . . . . : 400001234567
Local socket . . . . . : 8795
Associated user profile . . . . . : QSYS

IPX information:
Bytes out . . . . . : 0
Packets out . . . . . : 0
Bytes in . . . . . : 0
Packets in . . . . . : 0
Idle time . . . . . : 001:26:47
Last activity date/time . . . . . : 08/06/96 13:04:32

```

Figure 72. Display IPX Connection Status Example

Ending IPX Connections

IPX connections and SPX connections can be ended from the Work with IPX/SPX Connection Status display.

To end a connection from the Work with IPX Connection Status display:

1. Type a 4 in the option field for the lines that contain the connections that you want to end.
2. Press the Enter key.

A Confirm End of IPX/SPX Connections display is shown in Figure 73.

```

                                     Confirm End of IPX/SPX Connections
                                     System:  SYSNAMXX

Press Enter to confirm your choices for 4=End.
Press F12 to return to change your choices.

  Opt  Remote  Remote  Remote  Local
      Network Node Address Socket Socket Idle Time State
  10  A0826103 4000A5296233 416A 41AF 017:45:17 Established

```

Figure 73. Confirm End of IPX Connections Display

To end the IPX connections you have chosen, press the Enter key from the Confirm End of IPX Connections display.

If you decide not to end an IPX connection or if you want to change your choices, press F12 (Cancel).



Tips:

- If errors occur during the process, the closing of the connection is suspended and the Work with IPX Connection Status List is displayed again with all unprocessed options in place.
- If the processing completes successfully, the connection is removed from the list.

Displaying an Active IPX Description

To display the IPX description that was activated using the Start IPX (STRIPX) command for OS/400 IPX support, do the following on Work with IPX Status menu:

1. Type option 5 on the command line.
2. Press Enter.

See Figure 74 for an example.

```

                                Display IPX Description
                                SYSNAMXX
                                02/08/96 08:07:04
IPX description . . . . . : SYSTEMA
IPX internal network number . . . : 00000001
IPX routing protocol . . . . . : *NLSP
IPX router name . . . . . : IPX_Router_Name

IPX maximum datagram size . . . . : 576
IPX packet forwarding . . . . . : *YES
IPX hop count . . . . . : 64
SPX maximum sessions . . . . . : 1000
SPX watchdog abort timeout . . . . : 120000
SPX watchdog verify timeout . . . . : 30000
SPX are you there timeout . . . . . : 60000
SPX default retry count . . . . . : 10
LAN hello . . . . . : 20
WAN hello . . . . . : 20
Designated router interval . . . . . : 10
Holding time multiplier . . . . . : 3

                                More...

Press Enter to continue.

F3=Exit  F11=Display keywords  F12=Cancel

```

```

                                Display IPX Description
                                SYSNAMXX
                                02/08/96 08:07:04
Log protocol errors . . . . . : *NO
Propagate NetBIOS packets . . . . . : *YES
SPX2 receive window size . . . . . : 8
Text 'description' . . . . . : IPXD for System A

```

Figure 74. Display Active IPX Description Example

The currently active IPX description for OS/400 IPX support is displayed. If you want to use a different IPX description for the OS/400 IPX support, you need to:

- End IPX processing by using the End IPX (ENDIPX) command.
- Start IPX using the Start IPX (STRIPX) command. The IPX description parameter in the STRIPX command must be set to the name of the IPX description you want to activate

Advanced IPX Configuration

This chapter discusses advanced IPX support, which includes configuring NetWare Support on the Integrated PC Server, additional routing considerations, and controlling NLSP route selection.

After you obtain NetWare 4.10 or higher from Novell, the NetWare Integration for OS/400 feature allows you to run Novell NetWare on the AS/400 and on the Integrated PC Server. Using the Integrated PC Server on the AS/400 has the following advantages:

- The AS/400 disk can be used for NetWare file serving.
- The AS/400 and NetWare servers can be consolidated into a single hardware platform for centralized administration.
- NetWare volumes that are created on the AS/400 disk can be saved and restored to the AS/400 removable media devices.
- Wide area network (WAN) that is routing is available with the NetWare Core Protocol (NCP).

You must install the NetWare Integration for OS/400 feature before working with the NetWare Support on the Integrated PC Server.

For the installation instructions and more information on the NetWare Integration for OS/400 feature, see the *Integrating AS/400 with Novell NetWare* book.

Configuration for NetWare Support

IPX is the communications protocol that is used to transport NetWare data over communications links between NetWare clients and servers.

The OS/400 IPX support and the NetWare Support share the same configuration objects. In order to use the IPX support and the NetWare Support, you need to define:

- An IPX description
- One or more IPX circuits

The Install NetWare Server(INSTNWSVR) command can create configuration objects for the Integrated PC Server. See the *Integrating AS/400 with Novell NetWare* book.

IPX Description

The IPX description contains the parameters that are required by the IPX support. The Network Server description needs the IPX description name for the file server IOP with the NetWare Support. See Configuring the Internetwork Packet Exchange (IPX) Support.

IPX Circuit Definition

To associate an external IPX network number with an AS/400 line description and IPX circuit is added. The NetWare Support as it is for the OS/400 IPX support requires an IPX circuit definition. See “Configuring the Internetwork Packet Exchange (IPX) Support” on page 19.

X.25 Network and Integrated PC Server Example

Figure 75 on page 91 shows the sample network that was configured in Configuring the Internetwork Packet Exchange (IPX) Support.

- The NetWare Support has been installed on a file server IOP on System D.
- An X.25 communications adapter is also installed on System D.
- System D is a node in the token-ring network and has an X.25 link to the Ethernet network.
- The Integrated PC Server is installed on a LAN.
- The Integrated PC Server is used for file serving.
- The Integrated PC Server should be near to the people who are using it.

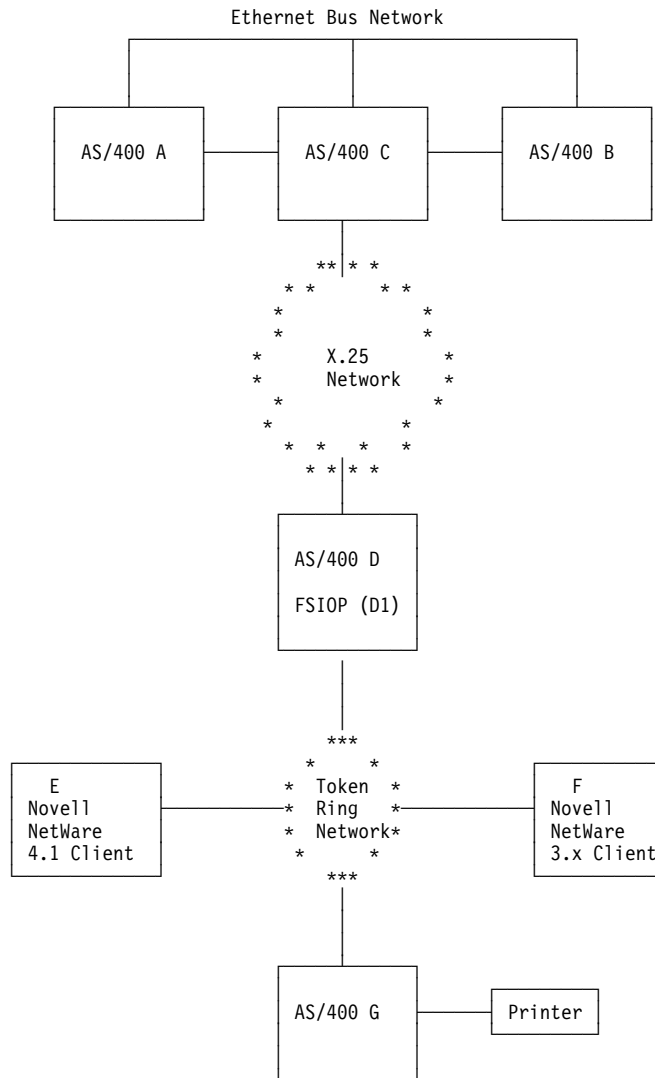

Figure 75. IPX Network with the NetWare Support Installed on the Integrated PC Server

X.25 Network Configuration

The section describes the configuration steps to define System D in our IPX inter-network. See Figure 76 on page 92. System D is an AS/400 doing LAN to WAN routing and the NetWare 4.10 is installed on the Integrated PC Server.

The configuration steps are:

1. Create an IPX description. See “ Step 1—Creating an Internetwork Packet Exchange (IPX) Description” on page 92.
2. Configure a line description. See “ Step 2—Configuring an X.25 Line Description for System D” on page 95.
3. Add an IPX circuit. See “ Step 3—Adding an IPX Circuit for an X.25 SVC Line on System D” on page 98.

4. Adding route information. See “Step 4–Adding Circuit Route Information for System D” on page 100.

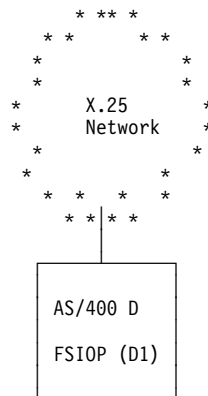

Figure 76. X.25 Network Example

You must create two IPX descriptions for System D in our sample network.

- One IPX description that defines global system default values for the AS/400 IPX support. See “ Step 1–Creating an Internetwork Packet Exchange (IPX) Description.”
- An IPX description is needed for one or both ports of the 1-port or 2-port Integrated PC Server.

The configuration steps that are needed for the AS/400 IPX support are following.

Step 1–Creating an Internetwork Packet Exchange (IPX) Description



To create an IPX description for the OS/400 IPX support on System D, do the following :

1. Enter the Create IPX Description (CRTIPXD) command.
2. Press F4.

You are prompted for the following information.

```

Create IPX Description (CRTIPXD)

Type choices, press Enter.

IPX description . . . . . SYSTEMD      1 Name
IPX internal network number . . 00000004  2 0000001-FFFFFFFE,*RANDOM
IPX routing protocol . . . . . *NLSP      *NLSP, *RIP
IPX router name . . . . . *NONE
IPX maximum datagram size . . . 576      576-65535
Text 'description' . . . . . 'IPX description for System D'

```

Figure 77. Create IPX Description (CRTIPXD) Command Prompt Example for System D

You must specify values for two parameters. These parameters are:

- The IPX description name
- The IPX internal network number

IPX Description

1 Enter the name of the IPX description object that is being created. This name is how the IPX description object is referred to when you want to start IPX processing by using the Start IPX (STRIPX) command.

Use SYSTEMD for the IPX description name in the sample network.

IPX Internal Network Number

2 Enter the number of the internal IPX network of this AS/400 system. The internal IPX network number specifies the AS/400 on which all services and applications that run on the IPX and SPX protocol stacks reside. For more information, see “IPX Internal Network Number” on page 15.

This internal IPX network number is reachable through all adjacent IPX networks, whose network numbers are configured in the IPX circuit definitions.

The internal network number is specified in the form, *nnnnnnnn*, where *nnnnnnnn* is a hexadecimal number ranging from 00000001 through FFFFFFFE.

A number is generated for your system if you specify *RANDOM. You must make sure that this is a unique number on the network. There is no default.

The internal IPX network number is defined as 00000004 for System D in this sample network.



The data might not reach the correct destination when duplicate network numbers are found. Use the Work with IPX Descriptions display to check for duplicate IPX numbers and change them as needed.

After typing in the first set of parameters, press Enter. The IPX description is created.

Default values are provided for the remainder of the parameters.

Performance Considerations for IPX Descriptions

Using the Change IPX Description (CHGIPXD) command, you can control the runtime performance of SPX by changing some key parameters. These parameters include the following:

- SPX maximum sessions:
 - It is recommended that this value should always be 1000 or less.
- SPX watchdog abort timeout (SPXABTTIMO):
 - It is recommended that this value be set to:
 - 120000, if you plan to run more than 30 SPX connections
 - 240000, if more than 100 SPX connections.

- 600000, if more than 200 SPX connections.
- 60000000, (the maximum value) if more than 500 SPX connections

It is possible to turn off the SPX watchdog abort timer for a specific SPX connection by setting the `SO_KEEPALIVE` option to `*OFF` by using the sockets API. This reduces the performance overhead that is caused by the periodic transmission of the SPX watchdog packets and improves the overall performance of IPX and SPX.



The SPX watchdog abort timeout parameter is not used for SPX2 connections; however, the SPX2 protocol does use the Abort timeout parameter.

- SPX watchdog verify timeout:

It is recommended that this value be set to:

- 30000, if you plan to run more than 30 SPX connections
- 60000, if more than 100 SPX connections.
- 150000, if more than 200 SPX connections.
- 6000000, (the maximum value) if more than 500 SPX connections.

It is possible to turn off the SPX watchdog verify timer for a specific SPX connection by setting the `SO_KEEPALIVE` option to `*OFF` using the sockets API. This reduces the performance overhead that is caused by the periodic transmission of the SPX watchdog packets and improves the overall performance of IPX and SPX.

- SPX are you there timeout (SPXAYTTIMO):

It is recommended that this value be set to:

- 60000, if you plan to run more than 30 SPX connections
- 120000, if more than 100 SPX connections.
- 300000, if more than 200 SPX connections.
- 12000000, (the maximum value) if more than 500 SPX connections

It is possible to turn off the SPX are you there timer for a specific SPX connection by setting the `SO_KEEPALIVE` option to `*OFF` using the sockets API. This reduces the performance overhead that is caused by the periodic transmission of the SPX watchdog packets and improves the overall performance of IPX and SPX.



The SPX are you there timeout parameter is not used for SPX2 connections; however, the SPX2 protocol does use the Are you there timeout parameter.

- SPX2 receive window size:

Specify a size greater than 1 to allow remote applications to send more data before having to wait for an acknowledgement from the local AS/400.

Step 2—Configuring an X.25 Line Description for System D

You need to create a line description for the X.25 line for the sample network. See Figure 76 on page 92.

You can use a line description that is already configured if it is one of valid line types for IPX support.



To create an X.25 line description for the OS/400 IPX support on System D, do the following:

1. Enter the Create Line Description (X.25) (CRTLINX25) command.
2. Press F4.

When creating a line description using the CRTLINX25 command, you must specify certain values that have special meaning for IPX support. These parameters are discussed in the following sections.

```
                Create Line Desc (X.25) (CRTLINX25)
Type choices, press Enter.
Line description . . . . . > DX25LINE      1      Name
Resource name   . . . . . LIN061         2      Name, *NWID
```

Figure 78. Create Line Description (X.25) (CRTLINX25) Command Prompt Display Example

3. Press the Enter key.

You are prompted for the following information.

```

Create Line Desc (X.25) (CRTLINX25)

Type choices, press Enter.

Line description . . . . . > DX25LINE 1 Name
Resource name . . . . . LIN061 2 Name, *NWID
Logical channel entries:
  Logical channel identifier . . 002          001-FFF, *PROMPT
  Logical channel type . . . . *SVCBOTH  *PVC, *SVCIN, *SVCBOTH...
  PVC controller . . . . .      Name
    + for more values
Local network address . . . . . 000000994 4
Connection initiation . . . . . *LOCAL 5 *LOCAL, *REMOTE, *WAIT...
Online at IPL . . . . . *YES      *YES, *NO
Physical interface . . . . . *X21BISV24 *X21BISV24, *X21BISV35...
Connection type . . . . . *NONSWTTP *NONSWTTP, *SWTPP
Vary on wait . . . . . *NOWAIT  *NOWAIT, 15-180 (1 second)
Line speed . . . . . 9600      *CALC, 600, 1200, 2400...
Exchange identifier . . . . . *SYSGEN  05600000-056FFFFF, *SYSGEN
Extended network addressing . . *NO      *YES, *NO
More...

F3=Exit  F4=Prompt  F5=Refresh  F10=Additional parameters  F12=Cancel
F13=How to use this display  F24=More keys

```

```

Create Line Desc (X.25) (CRTLINX25)

Type choices, press Enter.

Maximum frame size . . . . . 1024          1024, 2048, 4096
Default packet size:
  Transmit value . . . . . 128            64, 128, 256, 512, 1024...
  Receive value . . . . . *TRANSMIT      *TRANSMIT, 64, 128, 256...
Maximum packet size:
  Transmit value . . . . . *DFTPFSIZE    *DFTPFSIZE, 64, 128, 256...
  Receive value . . . . . *TRANSMIT      *DFTPFSIZE, *TRANSMIT, 64...
Modulus . . . . . 8                      8, 128
Default window size:
  Transmit value . . . . . 2              1-15
  Receive value . . . . . *TRANSMIT      1-15, *TRANSMIT
Insert net address in packets . *YES      *YES, *NO
Text 'description' . . . . . 'X25 Line for System D'

```

X.25 Line Description Command Prompt Example for System D

Figure 79. Create Line Description (X.25) (CRTLINX25)

Line Description

1 Uniquely identifies the line description on the system.

Use DX25LINE for the name of the line description in this example.

Resource Name

2 Indicates the name of the communications port to which the hardware is that is attached.



You can use the WRKHDWRSC *CMN command to help determine the correct resource name for the line description.

For System D, the resource name that is associated with this line description is LIN061 for this example.

The following values are X.25 specific.

Logical Channel Entries

3 Specifies a list of entries to be added, removed, or changed in the logical channel table.

A logical channel entry must be defined for each virtual circuit. A logical channel entry for an X.25 SVC consists of a logical channel identifier and a logical channel type.

There is a special value that is called *PROMPT which allows you to easily add, remove, and change logical channel entries that is defined for an X.25 line. Once a PVC logical channel has a PVC controller attached to it the logical channel entry cannot be changed.

Logical Channel Identifier

Specifies a three-character hexadecimal number that ranges from 001 to FFF for the logical channel identifier. The first digit (from left to right) is the logical channel group number; the second and third digits make up the logical channel number.

You must specify one logical channel identifier for each virtual circuit. We have defined 2 virtual circuits, with identifiers 001 and 002.

Logical Channel Type

Specify the logical channel type as:

- *PVC (permanent virtual circuit)
- *SVCIN (switched virtual circuit for input only),
- *SVCOUT (switched virtual circuit for output only)
- *SVCBOTH (switched virtual circuit for both input and output)

For this example, this value is set to *SVCBOTH, for both virtual circuits, indicating that this logical channel is a Switched Virtual Circuit for both incoming and outgoing calls.

PVC Controller (Optional)

Specifies the name of the permanent virtual circuit (PVC) controller that is assigned to the logical channel. This field is only valid when the channel type is *PVC.

Local Network Address

4 Specifies the local network address for this system. Up to 17 characters can be specified if *YES is specified for the Extend Network Address parameter. Otherwise up to 15 characters can be specified.

Use 000000994 for the X.25 network address for this example. This number is known by the network administrator.

Connection Initiation

5 Specify the method that is used to establish the X.25 data link connection.

For this sample network, we have specified *LOCAL, which means that a connection can be established to the local system.

Step 3—Adding an IPX Circuit for an X.25 SVC Line on System D



To create an IPX circuit for a switched virtual circuit over the X.25 line description on System D, do the following:

1. Enter the Add IPX Circuit (ADDIPXCCT) command.
2. Press F4.

You are prompted for the following information.

```

                                Add IPX Circuit (ADDIPXCCT)

Type choices, press Enter.

Circuit name . . . . . > CCT1D 1
Line description . . . . . > DX25LINE 2
X.25 PVC logical channel id . . . . . > 1
X.25 SVC network address . . . . . > 000000999 3
X.25 SVC call type . . . . . > *DEMAND
X.25 SVC reverse charge . . . . . > *NONE
X.25 SVC idle circuit timeout . . . . . > 60
X.25 default packet size:
  Transmit packet size . . . . . > *LIND
  Receive packet size . . . . . > *LIND
X.25 default window size:
  Transmit window size . . . . . > *LIND
  Receive window size . . . . . > *LIND
Enable for NLSP . . . . . > *YES
Cost override for NLSP . . . . . > *CALC
Enable for IW2 . . . . . > *YES 4

Name
001-FFF
*DEMAND, *PERM
*NONE, *REQUEST, *ACCEPT...
0-600
*LIND, 64, 128, 256, 512...
*LIND, *TRANSMIT, 64, 128...
1-15, *LIND
1-15, *LIND, *TRANSMIT
*YES, *NO
1-63, *CALC
*YES, *NO

More...

F3=Exit F4=Prompt F5=Refresh F12=Cancel F13=How to use this display
F24=More keys
```

Figure 80. Add X.25 IPX Circuit Command Prompt Example (1 of 2)

After F10 is pressed, additional prompts are displayed.

```

Add IPX Circuit (ADDIPXCCT)

Type choices, press Enter.

Additional Parameters

Default maximum datagram size . *LIND      576-16388, *LIND
Throughput . . . . . *CALC      300-4294967295, *CALC
Delay time . . . . . *CALC      1-5000000, *CALC
Automatic start . . . . . *YES      *YES, *NO
RIP state . . . . . *OFF      *ON, *OFF, *AUTO
RIP update interval . . . . . 60      30-300000
RIP age multiplier . . . . . 4      1-10
SAP state . . . . . *OFF      *ON, *OFF, *AUTO
SAP update interval . . . . . 60      30-300000
SAP age multiplier . . . . . 4      1-10

```

Figure 81. Add X.25 IPX Circuit Command Prompt Example (2 of 2)

The required parameters on an IPX circuit for an X.25 SVC line are as follows:

Circuit Name

1 Enter the name of the circuit.

Use CCT1D for the IPX circuit name in this sample network.

Line Description

2 Identifies the line description that is associated with the circuit.

DX25LINE is the name of the line description you created in the “ Step 2–Configuring a Line Description for IPX Support–X.25” on page 46 for this sample network.

X.25 PVC Logical Channel Identifier

Specifies the permanent virtual circuit (PVC) channel identifier that IPX support can establish on an X.25 circuit. Only 1 unique channel identifier may be specified. Valid ranges are 001 to FFF. The PVC value must have been previously specified on the X.25 line description value.



The X.25 PVC Logical Channel ID is only required if the SVC Network Address value is not specified and an X.25 line description is used.

Because the sample network is using an SVC logical channel, this parameter is not needed.

X.25 SVC Network Address

3 Enter the DTE that is associated with the remote X.25 system (the DTE address of the remote system). This value can be a decimal number that is 1 through 17 digits in length.



The SVC Network Address is only valid for X.25 line descriptions. If an X.25 line description is being used, the PVC Logical Channel ID or the SVC Network Address must be specified.

The network address for System D is 000000994 for this example.

Enable for IW2

4 Specifies whether the IW2 negotiations for a WAN are enabled for this circuit or not.

IW2 is the protocol used by Novell to exchange necessary router to router information prior to exchanging standard IPX routing information and traffic over WAN networks, such as X.25 and Frame Relay networks. Part of IW2 exchange includes the negotiation of the IPX network and node numbers to be assigned to the WAN circuit.

Some systems may not support IW2 negotiations. In order to interoperate with these systems, set this value to *NO. However, because IW2 exchange is not performed when this value is *NO, an IPX network number must be specified so it can be assigned to the circuit. The system derives an associated node number that consists of the specified network number that is followed by two bytes of binary zeros. For example, an IPX network number of X'10045D08' would result in the generation of X'10045D080000'.

For our example, we are using the default; *YES.

Default values are used for the other parameters in this IPX circuit definition. For more information about these parameters, see the “Add IPX Circuit (ADDIPXCCT) Command” in the *CL Reference* book.

Step 4—Adding Circuit Route Information for System D

IPX circuit route entries (or static route entries) need to be added for the systems that can be reached by this X.25 line description. Figure 82 on page 101 shows these routes.

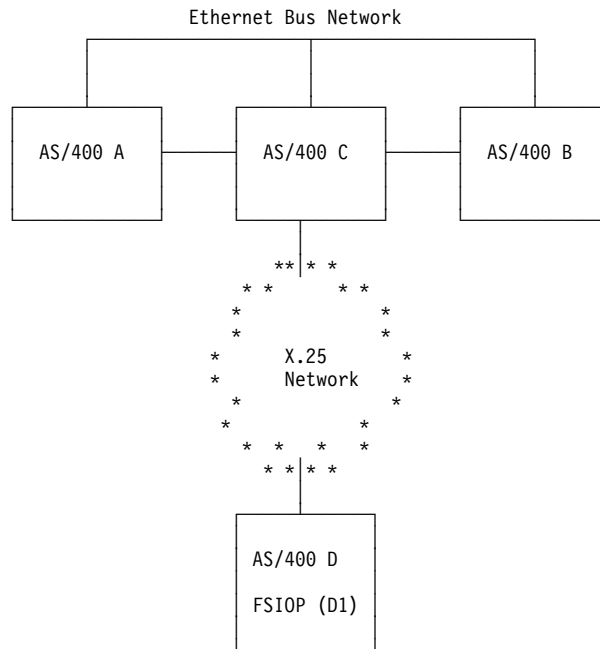

Figure 82. IPX Circuit Routes Example

If the local system is going to send data over an on-demand circuit, you must configure at least one static route.

Generally, you define the internal network number of these systems in the interconnected IPX networks. In the sample IPX internetwork, you must define the internal IPX networks for Systems A, B, and C.



To add circuit route entries, do the following:

1. Enter the Add Circuit Route (ADDCCTRTE) command.
2. Press F4.

The important parameters for an IPX route entry are as follows:

```

Add Circuit Route (ADDCCTRTE)

Type choices, press Enter.

Circuit name . . . . . CCT1D
Remote IPX network number . . . 00000001      00000001-FFFFFFE
Number of hops . . . . . 2                    1-127
Number of ticks . . . . . 12                   1-32767
  
```

Figure 83. Add Circuit Route Command Prompt Example

The required parameters in an IPX circuit route entry for an X.25 line description are as follows:

Circuit Name

Identifies the unique name of the circuit for which this static route is being defined. This is a required value. The static route is associated only with this circuit.

For Figure 82 on page 101, all of the circuit routes are associated with the previously defined IPX circuit, CC1D. The circuit is X.25 SVC on-demand type circuit in our example.

Remote IPX Network Number

Enter the remote IPX network number to identify the remote network number or system where this route connects to. The remote IPX network number is usually the internal IPX network number of the remote server or router. This is a required parameter value.

The remote IPX network number is specified in the form, *nnnnnnnn*, where *nnnnnnnn* is a hexadecimal number ranging from 00000001 through FFFFFFFE.

For Figure 82 on page 101, you must be able to reach System A, System B, and System C through this circuit. Three circuit routes, each specifying the internal network number of each of the IPX descriptions for each system, need to be added.

Number of Hops

Identifies the number of hops to the remote network. The number of hops is equal to the number of routers that are crossed in order to reach the network or system that is identified by the Remote network number value. The number of hops must be less than or equal to the IPX Hop Count value that is associated with the local AS/400 IPX description. If the number of hops for this route is greater than the IPX hop count value in the IPX description that is active at the time you are using IPX on the AS/400 this route cannot be used by IPX.

The range of values that are allowed is 1 to 127; the default is 1.

For Figure 82 on page 101, System D acts as a gateway system into the token-ring network, and is 1 hop away. All of the other systems are 2 hops away from System C on this circuit.

Number of Ticks

Specifies the number of ticks that are needed to reach the destination network that is identified by the remote IPX network number. A tick is equal to 1/18th of a second. The maximum value that is allowed is 32767 ticks, which equals approximately 30 minutes.

This value is usually used in comparison with tick values on other routes in the route table. It is used as a relative value that is compared to the other route entries.

The range of values that are allowed is 1 to 32767; the default value is 1.

After typing in the first set of parameter values, press the Enter key.

For Figure 82 on page 101, System C is one hop away and should be reached in less ticks than System A or System B. System C is 10 ticks away. System A and System B are 12 ticks away.

You must define circuit routes to the other two networks that are accessible through the X.25 circuit. Follow the same procedure as shown under “Step 4—Adding Circuit Route Information for System D” on page 100.

Figure 39 on page 59 shows the Add Circuit Route (ADDCCTRTE) command for route 00000002.

```

Add Circuit Route (ADDCCTRTE)

Type choices, press Enter.

Circuit name . . . . . CCT1D
Remote IPX network number . . . . . 00000002      00000001-FFFFFFE
Number of hops . . . . . 2                        1-127
Number of ticks . . . . . 12                       1-32767
  
```

Figure 84. Add Circuit Route Example for Route 00000002

Figure 85 shows the Add Circuit Route (ADDCCTRTE) command for route 00000003.

```

Add Circuit Route (ADDCCTRTE)

Type choices, press Enter.

Circuit name . . . . . CCT1D
Remote IPX network number . . . . . 00000003      00000001-FFFFFFE
Number of hops . . . . . 1                         1-127
Number of ticks . . . . . 10                       1-32767
  
```

Figure 85. Add Circuit Route Example for Route 00000003

The Work with Circuit Routes display shows the routes that you just added.

```

Work with Circuit Routes                                System:  SYSNAMXX

Type options, press Enter.
  1=Add  2=Change  4=Remove  5=Display

Opt      Circuit      Remote      Number      Number      Next Hop
Address  Name             Network    of Hops    of Ticks    Node
-----
5      CCT1D             00000001    2            12           *NONE
-       CCT1D             00000002    2            12           *NONE
-       CCT1D             00000003    1            10           *NONE
  
```

Figure 86. Work with Circuit Routes Example

Use option 5 to display one of the circuit routes you just created.

```

                Display Circuit Route (DSPCCTRTE)

Circuit name . . . . . : CCT1D
Remote IPX network number . . . . . : 00000001
Number of hops . . . . . : 2
Number of ticks . . . . . : 12
Next hop node address . . . . . : *NONE
Route source . . . . . : *CFG

```

Figure 87. Display Circuit Route 00000003 Example

Considerations for Adding Route Information

The AS/400 can be configured as a router in an IPX network. Two routing protocols, NLSP and RIP, are provided by the OS/400 IPX support. The ability to configure and use static routes is also supported. Four parameters that are used in the IPX configuration control how IPX routing works on the AS/400.

- The actual routing protocol in use by the AS/400 is dependent on the following parameter values:
 - The IPX routing protocol parameter on the Create IPX Description (CRTIPXD) and Change IPX Description (CHGIPXD) commands
 - The IPX packet forwarding parameter on the CRTIPXD command and CHGIPXD command
 - The Enable for NLSP parameter on the Add IPX Circuit (ADDIPXCCT) command and CHGIPXCCT (Change IPX Circuit) command
 - The RIP state parameter on the ADDIPXCCT commands and CHGIPXCCT commands

These parameters values must be considered together because they affect each other. As a group, these parameters determine the type of IPX routing to be performed by the AS/400 system.

- Another parameter that should also be considered when configuring the routing protocol to be used on AS/400, is the Service Advertising Protocol (SAP) state parameter on the ADDIPXCCT and CHGIPXCCT commands.

IPX Description Considerations for Routing

The parameters on the Create IPX Description (CRTIPXD) and the Change IPX Description (CHGIPXD) commands to be considered are: IPX routing protocol and IPX packet forwarding.

- The IPX routing protocol parameter determines the overall routing protocol that is used for the AS/400 IPX support. The IPX routing protocol parameter allows values of *NLSP and *RIP. The default is *NLSP.
- The IPX packet forwarding parameter determines if the AS/400 passes information about routes and services from one circuit to another.
- The IPX packet forwarding parameter allows values of *YES and *NO. The default is *YES.

If this value is *NO, then the IPX routing protocol parameter is ignored and the OS/400 IPX support will *not* act as a router for the attached networks. This parameter makes the AS/400 IPX support appear as a client or server if it is

*NO. When IPX packet forwarding is disabled, the internal network and locally defined services are still advertised using RIP and SAP. Other information that is learned about services and networks is not shared from one circuit to another.

IPX Circuit Considerations for Routing

The parameters on the Add IPX Circuit (ADDIPXCCT) and Change IPX Circuit (CHGIPXCCT) command are: Enable for NLSP and RIP state.

- The Enable for NLSP value determines whether a circuit is enabled for NLSP processing or not.
- The values for Enable for NLSP parameter are *YES and *NO. The default is *YES. The value of this parameter is used and is dependent on the IPX routing protocol value in the currently *active IPX* description. An IPX description is active if it has been specified on the STRIPX command.
- If the IPX routing protocol value is *NLSP and the Enable for NLSP value is *NO, then RIP is used as a routing protocol on this circuit (depending on the value of the RIP state parameter).
- If the IPX routing protocol value is *NLSP and the Enable for NLSP value is *YES, then NLSP is used as a routing protocol on this circuit. The RIP state parameter indicates if RIP will be concurrently supported on this circuit or not. If the IPX routing protocol value is *RIP, then the Enable for NLSP value is ignored.
- The RIP state parameter specifies the routing information protocol (RIP) mode of support on a circuit. The RIP state values are *AUTO, *ON and *OFF. The default is *AUTO. Setting this parameter determines how RIP advertises and how general RIP requests are processed on this circuit. A **general RIP request** is a request for all routes known to a system. A **specific RIP request** is a request for information about a specific route.



Whatever the RIP state parameter is set for a circuit (*ON, *AUTO or *OFF), a specific RIP request is always processed by AS/400 IPX support.

- *ON means to use normal RIP routing on this circuit. The AS/400 advertises routes by using RIP. The AS/400 IPX support can process general and specific RIP requests.
- *AUTO is defined as “Don’t generate RIP routing advertisements unless another RIP router is advertising.”

With the RIP state value set to *AUTO, the AS/400 advertises routes by using RIP, if another RIP router exists in the network that is also advertising. This mode allows an AS/400 by using NLSP for routing to be compatible with other RIP routers that may exist in the network.

- *OFF means that no RIP routing is supported on this circuit. The AS/400 does not advertise routes by using RIP. However, the AS/400 will respond to specific RIP requests.
- The RIP state value is dependent on the IPX routing protocol value in the currently ACTIVE IPX description and the value of the ENBNLSP parameter on

the same circuit. An IPX description is active if it has been specified on the STRIPX command.

Considerations for Combining Values for Routing

The different combinations of values for these parameters are discussed next.

When the following situations occur the parameters should be considered in combination are:

1. If the IPX routing protocol value is NLSP, the Enable for NLSP value is *NO, and the RIP state value is *ON, then the circuit acts as a normal RIP circuit.
2. If the IPX routing protocol value is *NLSP, the Enable for NLSP parameter is *NO, the RIP state value is *AUTO, then *AUTO is interpreted as *ON.

To prevent the following situation:

- Two systems are configured for RIP processing with the values are set as mentioned above. The systems could both be AS/400s or they could be one AS/400 and some other type of system.
- Both systems have IPX activated. For the AS/400s, you would use the STRIPX command and specify an IPX description.
- Since *AUTO is originally defined as “do not advertise unless specifically requested to do so” neither system exchanges routing information, neither system would find out about the other router in the network. No routes would be exchanged.

If you want to have a RIP network where no RIP traffic is present, then you should set the RIP state value to *OFF. You would have to configure static routes and services for this circuit in order to route data over this circuit. See the following discussion.

- If IPX routing protocol is *NLSP, Enable for NLSP is *NO, and RIP state is *OFF, then the circuit does not use any routing protocol. Static routes would have to be configured in order to use this circuit for IPX data.
- If IPX routing protocol is *NLSP and Enable for NLSP is *YES, then the RIP state of *AUTO, *ON and *OFF will operate as defined above. NLSP is used as a routing protocol on this circuit and RIP may also be used to be compatible with older RIP routers.
- If the IPX routing protocol value is *RIP, the Enable for NLSP value is ignored. When the RIP state value is *AUTO, the *AUTO value is interpreted as *ON to avoid the situation where no routing information would be exchanged.

Considerations for SAP State Parameter for Routing

When determining the type of routing that you want on a circuit, there are considerations for the SAP state parameter. The SAP state parameter allows the same values as the RIP state parameter: *ON, *AUTO, and *OFF. The default is *AUTO. The SAP state parameter operates in much the same manner as the RIP state parameter.

- *ON means to use normal SAP advertising on this circuit. The AS/400 advertises services using SAP. The AS/400 IPX support will respond to general and specific SAP requests.

- *AUTO is defined as “don’t generate SAP advertisements unless another SAP router is advertising.” When the SAP state value is *AUTO, the AS/400 advertises services by using SAP if another SAP router exists in the network that is also advertising. This allows for SAP compatibility on an NLSP circuit.
- *OFF means that no SAP advertising will not be generated or absorbed on this circuit. Specific SAP requests will be responded to.

The SAP state value is not dependent on the RIP state value. You can have RIP routing set to *OFF on a circuit while having SAP advertising set to *ON. You can also have RIP routing *ON and SAP advertising *OFF on a circuit.

Considerations for WAN Line Descriptions

For circuits that are defined to WAN line descriptions, there are some special considerations.

- If NLSP is not enabled and if the RIP state of a circuit is turned off, you must create at least one static route in order to use the circuit.
- For X.25 line descriptions, the service type (SVCTYPE) parameter on the ADDIPXCCT and CHGIPXCCT commands determines the type of SVC circuit. The values that are allowed are *DEMAND and *PERM. *DEMAND is the default
- If *DEMAND is configured, then at least one static route must be configured for this circuit before the AS/400 initiates a call, regardless of the routing protocol. You should also consider configuring static services if you want to be able to access the services of the remote systems by using this circuit.

Controlling NLSP Route Selection

This section explains how to override the cost that is associated with a circuit. Use this information if you need to manually control the selection of routes in an NLSP network.

Table 8. Default Costs. Throughput rates are estimated per second.

Throughput At Least	Throughput Less Than	Default Cost
0 kilobits	16 kilobits	61
16 kilobits	48 kilobits	55
48 kilobits	128 kilobits	45
128 kilobits	256 kilobits	40
256 kilobits	512 kilobits	35
512 kilobits	1 megabit	30
1 megabit	2 megabits	27
2 megabits	4 megabits	26
4 megabits	8 megabits	25
8 megabits	10 megabits	23
10 megabits	16 megabits	20
16 megabits	32 megabits	19
32 megabits	64 megabits	15
64 megabits	128 megabits	14
128 megabits	512 megabits	9
512 megabits	4 gigabits	6
4 gigabit	32 gigabits	3

The cost that is associated with a circuit is used by NLSP to determine that the network route over which to forward IPX packets. The end-to-end path with the lowest cost is selected as the preferred route. By default, the cost for a circuit is based on the throughput of the associated line type. For example, a circuit associated with a 10 megabit per second ethernet line would have a default cost of 20 whereas a circuit associated with a 16 megabit per second token-ring line would have a lower default cost of 19.

You can override the default cost that is associated with a circuit by setting the `CSTOVRNLSP` parameter when you create or change a circuit.

IPX Support and AnyNet/400

IP over IPX	110
SNA over IPX	111
Configuring AnyNet/400 Support using the Configure IPX Menu	111
IP over IPX AnyNet Configuration–Overview	112
IP over IPX AnyNet Configuration-Example	112
Assumptions	113
Step 1–Configuring IPX Support	113
Step 2–Configuring the IP over IPX Interface	114
Internet Address	115
Subnet Mask	116
Step 3–Adding IP over IPX Routes Configuration	117
Step 4–Adding IP over IPX Addresses Configuration	117
Remote Destination	118
Subnet Mask	119
Remote IPX Network Number	119
Remote IPX Node Address	119
CL Program for the IP over IPX Addresses Example	120
Step 5–Allow AnyNet/400 Support for IP over IPX Support	120
Step 6–Activating the IP over IPX Support	121
Changing the IP Over IPX Configuration	121
Matching Parameters for IP over IPX Support	122
IP over IPX Common Configuration Errors	123
APPC over IPX Configuration–Overview	123
APPC over IPX Configuration-Example	124
Assumptions	124
Step 1–IPX Configuration	124
Step 2–Creating the APPC Controllers	124
Controller Description	125
Link Type	125
Online	125
Remote Network Identifier	125
Remote Control Point	125
Sample APPC Controller Descriptions	126
Creating the APPC Device and Mode Descriptions	126
Step 3–Adding Remote Locations to the APPN Remote Location Lists	127
Step 4–Adding Local Locations to the APPN Local Locations Lists	129
Step 5–Adding APPC over IPX Location Name Addressing Configuration	131
Remote Location Name	132
Remote Network Identifier	132
Remote Network Number	132
Remote Node Address	133
Sample SNA over IPX Location Entries	133
CL Commands for the APPC over IPX Locations	133
Step 6–Allow AnyNet/400 Support	134
Step 7–Activating APPC over IPX Support	134
APPC over IPX Common Configuration Errors	135
Matching Parameters	135

This chapter discusses the OS/400 IPX support and the AnyNet/400 support.



AnyNet/400 configuration should be done by the experienced programmer.

Address mapping and location names are used to configure AS/400 systems for AnyNet/400 support for IP over IPX and SNA over IPX.

IP over IPX

The IP over IPX support allows socket applications that are written to the AF_INET address family to communicate over an IPX network without any changes in the application.

Configuring IP over IPX support consists of working with IP addresses and remote nodes. Configuring IP over IPX requires the following steps:

1. Configuring OS/400 IPX support, which includes creating an IPX description, and a line description for IPX support to use and adding an IPX circuit definition.
2. Designating the local IP address or address assigned to the local node. These IP addresses are normally referred to as interfaces in the IP network.
3. Designating the IP routes to the remote nodes. These routes are required whenever a remote node is not part of the same IP network. The node must be reached by means of a gateway. The IP route indicates the first gateway on the path to the remote node. This first gateway is known as the **next hop** and must be on the same IP network or subnetwork as the local node.
4. Mapping remote IPX network number and node address to IP address for each remote node that the local node wants to communicate with. You can either manually map or use the automatic mapping function for the IP address to remote IPX network number and node address. A special value of *CALC performs the automatic mapping.



When configuring an IP over IPX address entry and the remote destination system is an AS/400, the remote node address value must be equal to *CALC.

5. Setting the ALWANYNET (Allow AnyNet Support) network attribute to *YES.
6. Using the Start IPX (STRIPX) command to activate IP over IPX support.

For a sample IP over IPX configuration, refer to “IP over IPX AnyNet Configuration-Example” on page 112.

You can also define or change the IP over IPX configuration. Refer to “Changing the IP Over IPX Configuration” on page 121 for more information.

SNA over IPX

The SNA over IPX support allows CPI Communications and ICF applications to run without change over an IPX internetwork. SNA over IPX is more accurately referred to as APPC over IPX.



When referring to SNA over IPX support, it will be stated as APPC over IPX support in the remainder of this chapter.

APPC over IPX support consists of working with IPX location name entries. The configuration for SNA over IPX requires the following:

1. Configuring OS/400 IPX support, which includes creating an IPX description and a line description for IPX support to use and adding an IPX circuit definition.
2. Creating the APPC controller and devices.
3. Changing the remote location list to establish sessions with the remote system, depending on the remote control point name in the *ANYNW APPC controller, the remote location name, and the local location name.
4. Changing the APPN local location to define the local location name to be used by APPC over IPX support.
5. Mapping APPC LU names (remote location and remote network identifier) to remote IPX network and remote IPX node addresses by adding SNA over IPX locations entries. You can use the Add SNA over IPX Location (ADDSNILOC) command to identify the mappings.

When configuring an SNA over IPX location mapping entry and the remote destination is an AS/400 system, the remote node address value must be equal to *AS400.

6. Setting the ALWANYNET network attribute to *YES.
7. Using the STRIPX command to activate APPC over IPX support.



Steps 3 and 5 are only necessary if a session is to be initiated from a local system to the remote system.

For an APPC over IPX example network, refer to “APPC over IPX Configuration-Example” on page 124.

Configuring AnyNet/400 Support using the Configure IPX Menu

To configure the AnyNet/400 support, you use the Configure IPX menu. At the command line, enter:

```
GO CFGIPX
```

or

```
CFGIPX
```

The Configure IPX menu is displayed.

```
CFGIPX                                Configure IPX                                System: SYSTEMA
Select one of the following:

Configure IPX
  1. Configure IPX circuits
  2. Work with IPX descriptions
  3. Work with IPX status

Configure AnyNet/400 over IPX
  10. Work with IP over IPX interfaces
  11. Work with IP over IPX routes
  12. Work with IP over IPX addresses

  20. Work with SNA over IPX locations

Selection or command
====> _____
F3=Exit  F4=Prompt  F9=Retrieve  F12=Cancel
```

Figure 88. Configure IPX Menu Example

IP over IPX AnyNet Configuration–Overview

To configure IP over IPX support, do the following:

1. Create an IPX description. See “ Step 1–Creating an Internetwork Packet Exchange (IPX) Description” on page 23.
2. Create a line description for IPX support. See “ Step 2–Configuring Line Descriptions for IPX Support–Ethernet” on page 30.
3. Add an IPX circuit. See “ Step 3–Adding an Internetwork Packet Exchange (IPX) Circuit” on page 35.
4. Add an IP over IPX interface. See “Step 2–Configuring the IP over IPX Interface” on page 114.
5. Add IP over IPX routes. See “Step 3–Adding IP over IPX Routes Configuration” on page 117.
6. Add IP over IPX addresses. See “Step 4–Adding IP over IPX Addresses Configuration” on page 117.

IP over IPX AnyNet Configuration-Example

This section shows the displays and commands that can be used to perform IP over IPX configuration for Figure 89 on page 113.

The three systems are the same as in Figure 9 on page 22.

Assumptions

1. All three systems are AS/400s.
2. IPX support is already configured on each AS/400.
3. An IP address of 123.4.5.0 is assigned to this IPX network. Figure 89 shows an existing IPX network.
4. The subnet mask is 255.255.255.0. Performing a logical AND operation on the IP address of 123.4.5.0 and subnet mask 255.255.255.0 gives a subset of IP network addresses of 123.4.5.1 through 123.4.5.254. These are the addresses to be used by the IP over IPX support. This allows for 254 different IP addresses which means up to 254 different IPX nodes.
5. Figure 89 shows the IP addresses that are assigned to the IPX network.
 - a. The choice of IP addresses that are shown leaves gaps in the numbering of the IP addresses to allow room for future additions to the network. For example, new systems in this network would use IP addresses between 123.4.5.3 and 123.4.5.254.
 - b. Your choice of IP addresses should allow room for future additions that follow a pattern that makes sense for your network. By following, a pattern you can avoid confusion that is caused when two systems try to use the same IP addresses.

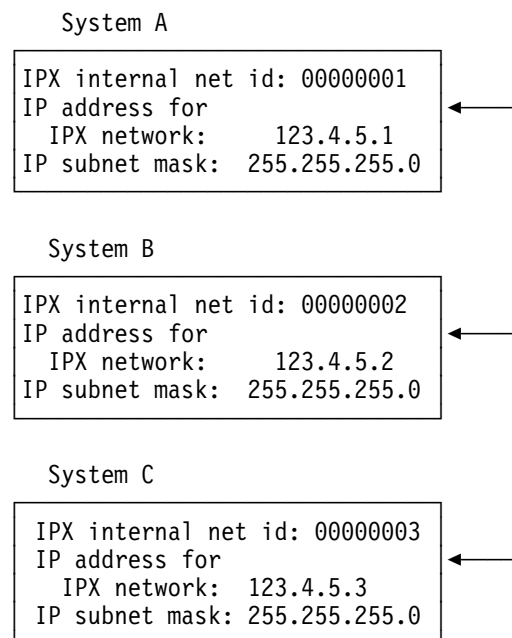

Figure 89. IP over IPX Network Example

Step 1—Configuring IPX Support

OS/400 IPX Support is already configured on these three systems in our network. For configuring OS/400 IPX support on the systems in our sample network, see Configuring the Internetwork Packet Exchange (IPX) Support.

Step 2—Configuring the IP over IPX Interface

The Add IP over IPX Interface (ADDIPIIFC) command is used to define an AF_INET socket (IP) over IPX interface. An interface is an IP address by which the local system is known to IP.

Interfaces that are defined by the ADDIPIIFC command are logical interfaces. They are not physical interfaces and they are not associated with any line description or network interface. There can be multiple AF_INET sockets over IPX logical interfaces that are defined on a host.



To define the IP over IPX interfaces, use the Work with IP over IPX Interfaces display.

1. Select option 10 from the Configure IPX menu.
2. Press the Enter key. The Work with IP over IPX Interfaces menu is shown.
3. Select option 1 to add an IP over IPX interface.
4. Press the Enter key.

```

                                Work with IP over IPX Interfaces
                                System:  SYSTEMA
Type options, press Enter.
  1=Add  2=Change  4=Remove  9=Start  10=End

Opt      Internet      Subnet      Interface
  1      Address       Mask       Status
  -      _____

```

Figure 90. Work with IP over IPX Interfaces Example

```

                                Add IP over IPX Interface (ADDIPIIFC)
Type choices, press Enter.
Internet address . . . . . _____
Subnet mask . . . . . _____

```

Figure 91. Add IP over IPX Interface Command Prompt Example

You need to add an IP over IPX interface for each of the internet addresses.

You are prompted for the following information:

Internet Address

Specifies the local IP address for an IPX interface (the internet address that the local system responds to on this interface). The specified internet address must not match any other local internet addresses that are defined on this node. The internet address is specified in the form nnn.nnn.nnn.nnn, where nnn is a decimal number ranging from 0 through 255.



An internet addresses that have all binary ones or zeros in the bits of the network identifier or the node identifier parts of the internet address is not valid.

For the sample network, the internet address for System A is 123.4.5.1, the internet address for System B is 123.4.5.2, and the internet address for System C is 123.4.5.3.

```
                Add IP over IPX Interface (ADDIPIIFC)

Type choices, press Enter.

Internet address . . . . . 123.4.5.1
Subnet mask . . . . . 255.255.255.0
```

Figure 92. Add IP over IPX Interface Command Prompt Example for System A

```
                Add IP over IPX Interface (ADDIPIIFC)

Type choices, press Enter.

Internet address . . . . . 123.4.5.2
Subnet mask . . . . . 255.255.255.0
```

Figure 93. Add IP over IPX Interface Command Prompt Example for System B

```
                Add IP over IPX Interface (ADDIPIIFC)

Type choices, press Enter.

Internet address . . . . . 123.4.5.3
Subnet mask . . . . . 255.255.255.0
```

Figure 94. Add IP over IPX Interface Command Prompt Example for System C

Subnet Mask

Specifies the mask of the network and node address fields of the internet address that defines a subnetwork. The subnet mask is in the form nnn.nnn.nnn.nnn, where nnn is a decimal number ranging in value from 0 through 255. The subnet mask must mask off all bits of the network class's network ID part of the internet address.

For more information on this value, see the "Add IP over IPX Address (ADDIPIFC) Command" in the *CL Reference* book.

The Work with IP over IPX Interfaces display shows the successfully added IP over IPX interfaces.

```

                                Work with IP over IPX Interfaces
                                System:  SYSTEMA
Type options, press Enter.
  1=Add  2=Change  4=Remove  9=Start  10=End

  Opt   Internet      Subnet      Interface
       Address      Mask        Status
  ---   -
  -     123.4.5.1    255.255.255.0  Active

                                Bottom
F3=Exit   F5=Refresh  F6=Print list  F10=Work with TCP/IP interfaces
F12=Cancel F17=Top      F18=Bottom
IP over IPX interface added successfully.

```

Figure 95. Work with IP over IPX Interfaces Display Example for System A

```

                                Work with IP over IPX Interfaces
                                System:  SYSTEMB
Type options, press Enter.
  1=Add  2=Change  4=Remove  9=Start  10=End

  Opt   Internet      Subnet      Interface
       Address      Mask        Status
  ---   -
  -     123.4.5.2    255.255.255.0  Active

                                Bottom
F3=Exit   F5=Refresh  F6=Print list  F10=Work with TCP/IP interfaces
F12=Cancel F17=Top      F18=Bottom
IP over IPX interface added successfully.

```

Figure 96. Work with IP over IPX Interfaces Display Example for System B

```

Work with IP over IPX Interfaces
System: SYSTEMC
Type options, press Enter.
  1=Add  2=Change  4=Remove  9=Start  10=End

  Opt      Internet Address      Subnet Mask      Interface Status
  --      -
  --      123.4.5.3              255.255.255.0   Active

F3=Exit    F5=Refresh  F6=Print list  F10=Work with TCP/IP interfaces
F12=Cancel F17=Top     F18=Bottom
IP over IPX interface added successfully.
Bottom

```

Figure 97. Work with IP over IPX Interfaces Display Example for System C

Step 3—Adding IP over IPX Routes Configuration

The Add IP over IPX Route (ADDIPIRTE) command designates the IP routes to remote nodes. These routes are required whenever a remote node is not part of the same IP network.

The IP over IPX route entries define the path to the remote nodes that can be accessed by way of the IPX transport. These route entries can designate a single node, or a group of nodes within a single network or subnetwork. If the route to the remote node traverse interconnected networks or subnetworks by using a gateway, the internet address of the next hop in the route must be supplied.



This network does not require routes, so you do not need to add IP over IPX route entries.

Step 4—Adding IP over IPX Addresses Configuration

The Add IP over IPX Address (ADDIPIADR) command can add an address mapping entry.

In order to enable IP over IPX processing, there must be a mapping of the remote IPX network number and node address to an IP address for each remote node that the local node communicates with. IP over IPX mapping entries define the remote IPX addresses that are associated with each remote node identified in the IP over IPX route entries and the local node interfaces identified in the IP over IPX interfaces. This can be a manual mapping process or an automatic mapping function of IP address to remote IPX network number and node addresses. Automatic mapping is done by specifying a special value of *CALC.

Before you can use IP over IPX support, you must define the IP over IPX addresses.



To define IP over IPX addresses, use the Work with IP over IPX Addresses display:

1. Select option 12 from the Configure IPX menu.
2. Press the Enter key. The Work with IP over IPX addresses display is shown.
3. Select option 1 to add an IP over IPX route
4. Press the Enter key. The Add IP over IPX Address command prompt display is shown. See Figure 98.

```

                                Work with IP over IPX Addresses
                                System:  SYSTEMA
Type options, press Enter.
  1=Add  2=Change  4=Remove

Opt      Remote      Subnet      Remote IPX      Remote IPX
  1      Destination  Mask        Network         Node Address
  1      _____  _____
(No address entries)

```

Figure 98. Work with IP over IPX Address Display Example

```

                                Add IP over IPX Address (ADDIPIADR)
Type choices, press Enter.
Remote destination . . . . . > _____
Subnet mask . . . . . > _____
Remote IPX network number . . . *CALC          00000001-FFFFFFFD, *CALC
Remote IPX node address . . . *CALC          000000000001-FFFFFFFFFE..

```

Figure 99. Add IP over IPX Address Command Prompt Example

You are prompted for the following information:

Remote Destination

Specifies an internet address of the network or host for the remote destination's IP over IPX address mapping entry. The IP address that you have assigned must be a unique IP address.

You must specify all four bytes that make up an internet address though some of the bytes may be equal to 0. For example, a route to all the nodes on the 9.5.11 subnetwork is identified by entering 9.5.11.0 for the remote destination. Used in combination with a subnet mask, the remote destination will identify a route to a network or system.

The remote destination for System A in our sample network is 123.4.5.1.

Subnet Mask

Specify the mask of the network and node address fields of the internet address that defines a subnetwork. The subnet mask is in the form nnn.nnn.nnn.nnn, where nnn is a decimal number ranging in value from 0 through 255. The subnet mask must mask off all bits of the network class's network ID part of the internet address.

*HOST is the default value. The internet address value of the route destination is used. The subnet mask value is calculated to be 255.255.255.255.

Remote IPX Network Number

Specifies the remote IPX network that is associated with this IP network or IP address. Specify an 8-character IPX network number. Valid values range from 00000001 through FFFFFFFD.

*CALC is the default value.

For more information on this value, see the “Add IP over IPX Address (ADDIPIADR) command” in the *CL Reference* book.

For our sample network, use 00000001 which is the internal IPX network number for System A.

Remote IPX Node Address

Specifies the remote node address (IPX node) that is associated with this IP network, subnetwork, or IP address.



When configuring an IP over IPX address mapping entry and the remote destination host is an AS/400, the remote node address value must be equal to *CALC. If the remote destination is actually a network with one or more AS/400s on that network, any valid remote node address value may be entered.

Specify a 12-character IPX node address. Valid values range from 000000000001 through FFFFFFFF0000.

*CALC is the default value.

For more information on this value, see the “Add IP over IPX Address (ADDIPIADR) command” in the *CL Reference* book.

The Work with IP over IPX Address display shows the successfully added address mapping entries for all three AS/400s. See Figure 100 on page 120.

Work with IP over IPX Addresses				
Type options, press Enter. 1=Add 2=Change 4=Remove				System: SYSTEMA
Opt	Remote Destination	Subnet Mask	Remote IPX Network	Remote IPX Node Address
-	123.4.5.1	*HOST	00000001	*CALC
-	123.4.5.2	*HOST	00000002	*CALC
-	123.4.5.3	*HOST	00000003	*CALC
IP over IPX address successfully added.				

Figure 100. Successfully Added IP Over IPX Address Example

CL Program for the IP over IPX Addresses Example

Figure 101 shows the CL commands to run on all the systems to map the IP address of that system to the IPX network ID and IPX node address in our sample network.

This program should be sent to all systems.

```
ADDIPIADR RMTDEST('123.4.5.1') SUBNETMASK(*HOST) +
RMTNETNBR(00000001) RMTNDEADR(*CALC)
ADDIPIADR RMTDEST('123.4.5.2') SUBNETMASK(*HOST) +
RMTNETNBR(00000002) RMTNDEADR(*CALC)
ADDIPIADR RMTDEST('123.4.5.3') SUBNETMASK(*HOST) +
RMTNETNBR(00000003) RMTNDEADR(*CALC)
```

Figure 101. CL Commands for the IP over IPX Configuration Example

Step 5—Allow AnyNet/400 Support for IP over IPX Support

To communicate using IP over IPX support, the systems must allow AnyNet/400 support and IPX support to be active. To allow AnyNet/400 support, the Allow AnyNet support (ALWANYNET) network attribute must be *YES.



Specifying ALWANYNET(*YES) enables and allows all AnyNet/400* support. In other words, this network attribute affects not only IP over IPX support but also TCP/IP over SNA support, APPC over TCP/IP support, and APPC over IPX support.

The following command, that is issued on all three systems, ensures that the systems allow the use of AnyNet/400 support, which includes IP over IPX support.

```
CHGNETA ALWANYNET(*YES)
```

The *CL Reference* has more information about the CHGNETA command.

Step 6—Activating the IP over IPX Support

To activate IPX support, you must use the IPX description you created and the IPX circuit you added.

You can then activate IPX support by entering the Start IPX (STRIPX) command, specifying an IPX description as follows:

```
STRIPX IPXD(SYSTEMA)
```



SYSTEMA was the name for the IPX description that was created under “Step 1—Creating an Internetwork Packet Exchange (IPX) Description” on page 23.

Changing the IP Over IPX Configuration

To change the IP over IPX configuration, use the Configure IP over IPX menu. At the command line, enter

```
CFGIPX
```

The Configure IP over IPX (CFGIPX) command allows a user to define or change the Internet Protocol (IP) over Internetwork Packet Exchange Protocol (IPX) configuration. It allows you to define or change the AS_INET sockets over IPX configuration.

The Configure IPI menu is displayed. This menu allows you to do the following tasks:

- Work with IP over IPX interfaces
- Work with IP over IPX routes
- Work with IP over IPX addresses

```
CFGIPX                                Configure IPI                                System:  SYSNAMXX
Select one of the following:
    1. Work with IP over IPX interfaces
    2. Work with IP over IPX routes
    3. Work with IP over IPX addresses
```

Figure 102. Configure IP over IPX Menu Example

1. Select option 1 to work with IP over IPX interfaces.

```

Work with IP over IPX Interfaces
System:  SYSNAMXX

Type options, press Enter.
  1=Add  2=Change  4=Remove  9=Start  10=End

Opt      Internet      Subnet      Interface
           Address      Mask        Status
-         123.4.5.1      255.255.255.0  Active
-         123.4.5.2      255.255.255.0  Active
-         123.4.5.3      255.255.255.0  Active

```

Figure 103. Work with IP over IPX Interfaces Menu Example

2. Select option 2 to work with IP over IPX routes.

```

Work with IP over IPX Routes
System:  SYSNAMXX

Type options, press Enter.
  1=Add  4=Remove

Opt      Route      Subnet      Next
           Destination  Mask        hop
-         125.6.7.8      255.255.255.0  123.4.5.2

```

Figure 104. Work with IP over IPX Routes Menu Example

3. Select option 3 to work with IP over IPX addresses.

```

Work with IP over IPX Addresses
System:  SYSNAMXX

Type options, press Enter.
  1=Add  2=Change  4=Remove

Opt      Remote      Subnet      Remote IPX      Remote IPX
           Destination  Mask        Network        Node Address
-         123.4.5.1      *HOST        00000001        *CALC
-         123.4.5.2      *HOST        00000001        *CALC
-         123.4.5.3      *HOST        00000001        *CALC

```

Figure 105. Work with IP over IPX Addresses Menu Example

Matching Parameters for IP over IPX Support

Figure 106 on page 123 shows the parameters that need to match for System A and System B in this IP over IPX configuration example.

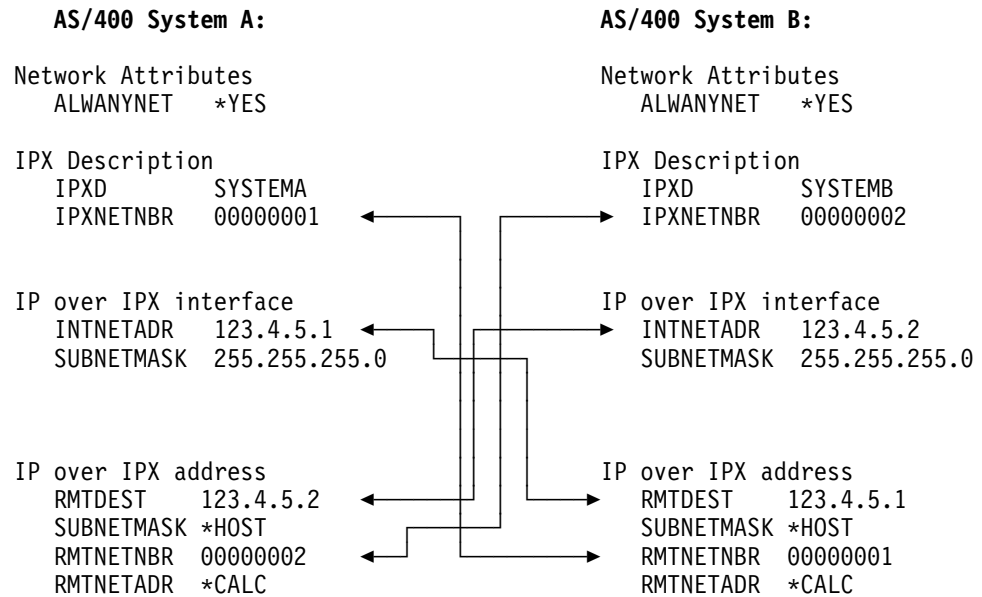

Figure 106. IP over IPX Configuration Matching Parameter Example

IP over IPX Common Configuration Errors

For some common configuration errors, refer to “IP over IPX Debugging Capabilities” on page 159.

APPC over IPX Configuration—Overview

To configure SNA over IPX support, you need to do the following:

1. Create an IPX description, see “ Step 1—Creating an Internetwork Packet Exchange (IPX) Description” on page 23.
2. Create a line description for IPX support, see “ Step 2—Configuring Line Descriptions for IPX Support—Ethernet” on page 30.
3. Add an IPX circuit, see “ Step 3—Adding an Internetwork Packet Exchange (IPX) Circuit” on page 35.
4. Create an APPC controller description with LINKTYPE(*ANYNW), see “Step 2—Creating the APPC Controllers” on page 124.
5. Add a remote location list entry, see “ Step 3—Adding Remote Locations to the APPN Remote Location Lists” on page 127.
6. Add a local Location list entry, see “ Step 4—Adding Local Locations to the APPN Local Locations Lists” on page 129.
7. Add APPC over SNA location mappings, see “ Step 5—Adding APPC over IPX Location Name Addressing Configuration” on page 131.

APPC over IPX Configuration-Example

In this example, three AS/400 systems are configured to communicate with each other using APPC over IPX support. See Figure 107. The three systems are the same as in Figure 9 on page 22.

Assumptions

1. The location names that are assigned to the three systems for APPC over IPX support are IPXA for System A, IPXB for System B, and IPXC for System C.
2. Default values are used for all parameters that are not explicitly defined.
3. For the complete syntax of the commands and parameters, refer to the *CL Reference* book.
4. Names (such as location names or resource names), network identifiers, and other values that are shown in the example are for illustration only.
5. The values you assign to your configuration depend on your network requirements.

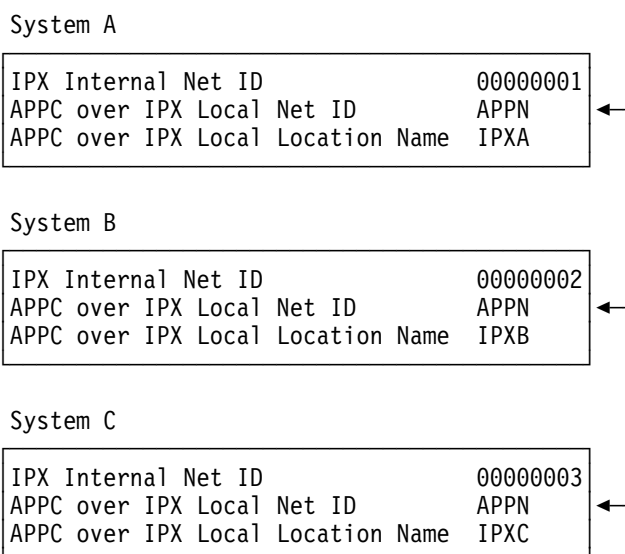

Figure 107. APPC over IPX Network Example

Step 1–IPX Configuration

IPX support is already configured for System A, System B, and System C; see Configuring the Internetwork Packet Exchange (IPX) Support.

Step 2–Creating the APPC Controllers

This part of the configuration example shows the APPC controller descriptions and APPN remote location lists.

The systems need to create APPC controllers for APPC over IPX communications. To create the controller description, use the Create Controller Description (APPC) (CRTCTLAPPC) command. A special Link type value is used for APPC over IPX because the APPC controller is not directly attached to a line description for APPC

over IPX support. The Link type value is *ANYNW. A controller description with Link type set to *ANYNW can support up to 254 attached APPC devices, and, hence, 254 remote location names.

```

                                Create Ctl Desc (APPC) (CRTCTLAPPC)

Type choices, press Enter.

Controller description . . . . .
Link type . . . . . *ANYNW
Online at IPL . . . . . -
Remote network identifier . . . . .
Remote control point . . . . .

Name
*ANYNW, *FAX, *FR.
*YES, *NO
Name, *NETATR, *NONE
Name, *ANY

```

Figure 108. Create Controller Description (APPC) (CRTCTLAPPC) Command Prompt Example

Specify the following parameters for the APPC controller description:

Controller Description

The name of this controller description.

Link Type

Specify *ANYNW for any network.

Online

Specifies whether or not this controller description is varied on when the system starts.

We have used *NO for our example network.

Remote Network Identifier

Specify the name of the remote network.



By using the *NETATR value, some network configuration changes only need to be made to the network attributes. Therefore, you should use the *NETATR value whenever possible. This example does not use the *NETATR value because the example is easier to understand without it.

Remote Control Point

Specify the name of the remote control point. This must be unique. We have specified IPX1 for System A in our sample network.

We have taken the defaults for the rest of the parameters.



APPC controllers with a Link type value of *ANYNW are not directly attached to a line. Instead, applications running over APPC controllers with a Link type value of *ANYNW are routed to IPX or TCP/IP configurations.

Sample APPC Controller Descriptions

Figure 109, Figure 110, and Figure 111 shows the example controller descriptions for system A, B, and C.

```

                                Create Ctl Desc (APPC) (CRTCTLAPPC)

Type choices, press Enter.

Controller description . . . . . IPXCTLA   Name
Link type . . . . . *ANYNW             *ANYNW, *FAX, *FR.
Online at IPL . . . . . *NO             *YES, *NO
Remote network identifier . . . APPN      Name, *NETATR, *NONE
Remote control point . . . . . IPX1      Name, *ANY

```

Figure 109. APPC Controller Display Example on AS/400 System A

```

                                Create Ctl Desc (APPC) (CRTCTLAPPC)

Type choices, press Enter.

Controller description . . . . . IPXCTLB   Name
Link type . . . . . *ANYNW             *ANYNW, *FAX, *FR.
Online at IPL . . . . . *NO             *YES, *NO
Remote network identifier . . . APPN      Name, *NETATR, *NONE
Remote control point . . . . . IPX2      Name, *ANY

```

Figure 110. APPC Controller Example on AS/400 System B

```

                                Create Ctl Desc (APPC) (CRTCTLAPPC)

Type choices, press Enter.

Controller description . . . . . IPXCTLC   Name
Link type . . . . . *ANYNW             *ANYNW, *FAX, *FR.
Online at IPL . . . . . *NO             *YES, *NO
Remote network identifier . . . APPN      Name, *NETATR, *NONE
Remote control point . . . . . IPX3      Name, *ANY

```

Figure 111. APPC Controller Display Example on AS/400 System C



These controllers can also be used as APPC controllers for TCP/IP networks.

Creating the APPC Device and Mode Descriptions

The system automatically creates APPC device descriptions as they are needed. In this example, the default mode description is used.

APPC over IPX support uses mode descriptions in the same way that APPC uses them.

- For information about creating mode descriptions, see the *Communications Configuration* book.
- For information about operating mode descriptions, see the *APPC Programming* book.

Step 3—Adding Remote Locations to the APPN Remote Location Lists

To communicate using APPC over IPX support, the systems require a configuration list entry for a remote location when both of the following are true:

- An application on the local system needs to establish a conversation with an application on the remote system.
- The remote location name is not equal to the remote control point name of any of the *ANYNW APPC controllers.

This entry causes the system to use APPC over IPX support (rather than APPN support) to communicate with this remote location.

For applications that establish sessions with remote systems, the remote systems are defined in the APPN remote location list. APPC over IPX communications needs the information in the APPN remote location list to determine which controller description to use when it activates the session (when the BIND command is issued). Use the Change Configuration List (CHGCFGL) command to define the remote locations.

You cannot have the same remote location name in both your SNA network and your SNA over IPX network because APPN requires that all remote location names be unique.

The remote control point name in the configuration list entry of the APPN remote location list must match the remote control point name of an APPC controller with a Link type value of *ANYNW.

See the *APPN Support* book for more information about the APPN remote location list.

Assuming the APPN remote location list has already been created on System A, the following command displays the APPN remote location list and allows you to change the list:

```
CHGCFGL *APPNRMT
```

Figure 112 on page 128 shows the APPN remote location list on AS/400 System A.

```

Change Configuration List
                                02/05/96 10:50:54 SYSTEMA
Configuration list . . . : QAPNRMT
Configuration list type : *APPNRMT
Text . . . . . : remote config list
Type changes, press Enter.

-----APPN Remote Locations-----
Remote   Remote   Local   Remote   Control   Location   Secure
Location Network  Location Point   Point   Net ID   Password   Loc
IPXB     APPN     IPXA     IPX1     APPN     _____ *YES
IPXC     APPN     IPXA     IPX1     APPN     _____ *NO
_____ *NETATR *NETATR _____ *NETATR _____ *NO
_____ *NETATR *NETATR _____ *NETATR _____ *NO
_____ *NETATR *NETATR _____ *NETATR _____ *NO
_____ *NETATR *NETATR _____ *NETATR _____ *NO
_____ *NETATR *NETATR _____ *NETATR _____ *NO
_____ *NETATR *NETATR _____ *NETATR _____ *NO
More...
F3=Exit  F11=Display session information  F12=Cancel  F17=Top  F18=Bottom

```

Figure 112. APPN Remote Location List Display Example on AS/400 System A

Assuming the APPN remote location list has already been created on System B, the following command displays the APPN remote location list and allows you to change the list:

CHGCFGL *APPNRMT

Figure 113 shows the APPN remote location list on AS/400 System B:

```

Change Configuration List
                                02/05/96 10:50:54 SYSTEMB
Configuration list . . . : QAPNRMT
Configuration list type : *APPNRMT
Text . . . . . : remote config list
Type changes, press Enter.

-----APPN Remote Locations-----
Remote   Remote   Local   Remote   Control   Location   Secure
Location Network  Location Point   Point   Net ID   Password   Loc
IPXA     APPN     IPXA     IPX2     APPN     _____ *YES
IPXC     APPN     IPXA     IPX2     APPN     _____ *NO
_____ *NETATR *NETATR _____ *NETATR _____ *NO
_____ *NETATR *NETATR _____ *NETATR _____ *NO
_____ *NETATR *NETATR _____ *NETATR _____ *NO
_____ *NETATR *NETATR _____ *NETATR _____ *NO
_____ *NETATR *NETATR _____ *NETATR _____ *NO
_____ *NETATR *NETATR _____ *NETATR _____ *NO
More...
F3=Exit  F11=Display session information  F12=Cancel  F17=Top  F18=Bottom

```

Figure 113. APPN Remote Location List Display Example AS/400 System B

Assuming the APPN remote location list has already been created on System C the following command displays the APPN remote location list and allows you to change the list:

CHGCFGL *APPNRMT

Figure 114 on page 129 shows the APPN remote location list on AS/400 System C:

```

Change Configuration List                                SYSTEMC
                                                    02/05/96 10:50:54
Configuration list . . . : QAPPNRMT
Configuration list type : *APPNRMT
Text . . . . . : remote config list
Type changes, press Enter.

-----APPN Remote Locations-----
Remote   Remote   Local   Remote   Control   Location   Secure
Location Network  Location Control Point  Password  Loc
IPXA     APPN     IPX3    IPX3     APPN      _____ *YES
IPXB     APPN     IPX3    IPX3     APPN      _____ *NO
_____ *NETATR *NETATR _____ *NETATR _____ *NO
_____ *NETATR *NETATR _____ *NETATR _____ *NO
_____ *NETATR *NETATR _____ *NETATR _____ *NO
_____ *NETATR *NETATR _____ *NETATR _____ *NO
_____ *NETATR *NETATR _____ *NETATR _____ *NO
_____ *NETATR *NETATR _____ *NETATR _____ *NO
More...
F3=Exit  F11=Display session information  F12=Cancel  F17=Top  F18=Bottom

```

Figure 114. APPN Remote Location List Display Example on AS/400 System C

Step 4—Adding Local Locations to the APPN Local Locations Lists

For APPC over IPX support, you have to have a unique local location name. The default local location name is defined in the network attributes. If the default local location name is going to be used for AS/400 SNA or SNA over TCP/IP, then you must define a unique local location name in the APPN local location list for use by APPC over IPX support.

See the *APPN Support* book for more information about the APPN local location list.

Assuming the APPN local location list has already been created on System A, the following command displays the APPN local location list and allows you to change the list:

```
CHGCFGL *APPNLCL
```

Figure 115 on page 130 shows the APPN local location list on AS/400 System A.

```

                                CHANGE CONFIGURATION LIST
                                09/05/95  SYSTEMA 20:59:07
CONFIGURATION LIST . . . : QAPPNLCL
CONFIGURATION LIST TYPE : *APPNLCL
TEXT . . . . . :

TYPE CHANGES, PRESS ENTER.

-----APPN LOCAL LOCATIONS-----
LOCAL
LOCATION TEXT
IPXA
-----APPN LOCAL LOCATIONS-----
LOCAL
LOCATION TEXT

```

Figure 115. APPN Local Location List Display Example on AS/400 System A

Assuming the APPN local location list has already been created on System B, the following command displays the APPN local location list and allows you to change the list:

CHGCFGL *APPNLCL

Figure 116 shows the APPN local location list on AS/400 System B.

```

                                CHANGE CONFIGURATION LIST
                                09/05/95  SYSTEMB 20:59:07
CONFIGURATION LIST . . . : QAPPNLCL
CONFIGURATION LIST TYPE : *APPNLCL
TEXT . . . . . :

TYPE CHANGES, PRESS ENTER.

-----APPN LOCAL LOCATIONS-----
LOCAL
LOCATION TEXT
IPXB
-----APPN LOCAL LOCATIONS-----
LOCAL
LOCATION TEXT

```

Figure 116. APPN Local Location List Display Example on AS/400 System B

Assuming the APPN local location list has already been created on System C, the following command displays the APPN local location list and allows you to change the list:

CHGCFGL *APPNLCL

Figure 117 on page 131 shows the APPN local location list on AS/400 System C.

```

                                CHANGE CONFIGURATION LIST
                                SYSTEMC
                                09/05/95 20:59:07
CONFIGURATION LIST . . . : QAPPNLCL
CONFIGURATION LIST TYPE : *APPNLCL
TEXT . . . . . :

TYPE CHANGES, PRESS ENTER.

-----APPN LOCAL LOCATIONS-----
LOCAL
LOCATION TEXT
IPXC _____
_____
_____

-----APPN LOCAL LOCATIONS-----
LOCAL
LOCATION TEXT
_____
_____
_____

```

Figure 117. APPN Local Location List Display Example on AS/400 System C

Step 5—Adding APPC over IPX Location Name Addressing Configuration

For APPC over IPX support, the Add SNA over IPX Location (ADDSNILOC) command is used to add a location name mapping entry.



This step is only necessary when the local system wants to initiate the conversation.

SNA over IPX location name mappings define the IPX addresses that are associated with each remote SNA location (logical unit (LU) name and network ID). They create a mapping from a remote SNA location (NETID.LUNAME) to an IPX address. Each entry defines a one-to-one mapping from a remote SNA location to an IPX address (network and node identifiers).



When configuring an SNA over IPX location mapping entry and the remote destination host is an AS/400 system, the remote node address value must be *AS400.

To use APPC over IPX support, the LU name that an application uses must be mapped to an IPX network and IPX node address. Use the Work with SNA over IPX Locations display.



To get to this display, do the following:

1. Select option 20 from the Configure IPX menu and press Enter. The Work with SNA over IPX Locations display is shown.
2. Select option 1 to add an SNA over IPX location mapping. See Figure 118 on page 132.

```

                                Work with SNA over IPX Locations
                                System: SYSTEMA
Type options, press Enter.
  1=Add  2=Change  4=Remove

  Opt      Remote SNA      Remote SNA      Remote IPX      Remote IPX
  1         Location Name   Network         Network         Node Address

  (No location entries)

```

Figure 118. Work with SNA over IPX Locations Display Example

3. Press the Enter key. The Add SNA over IPX Location (ADDSNILOC) command prompter display is shown. See Figure 119.

You are prompted for the following information.

```

                                Add SNA over IPX Location (ADDSNILOC)
Type choices, press Enter.

Remote location . . . . . _____ Name
Remote network identifier . . . _____ Name, *NETATR
Remote IPX network number . . . _____ 00000001-FFFFFFFD
Remote IPX node address . . . . . _____ 00000001-FFFFFFFFFE...

```

Figure 119. Add SNA over IPX Location Command Prompt Example

The required parameters for SNA over IPX locations are as follows:

Remote Location Name

Specifies the remote location name to be associated with a specific remote IPX network number and remote IPX node address.

Specify an 8-character SNA remote location name for the remote host.

Remote Network Identifier

Specifies the SNA remote network identifier to be associated with a specific remote IPX network number and remote IPX node address.

*NETATR specifies that the network identifier in the network attributes for this host is used, or you specify an 8-character SNA network identifier for the remote host.

Remote Network Number

Specifies the remote IPX network to be associated with this SNA remote location name and remote network identifier. This network number usually is the IPX internal network number of the remote system.

Specify an 8-character IPX network number. Valid values range from 00000001 through FFFFFFFD.

Remote Node Address

Specifies the remote IPX node address to be associated with this SNA remote location name and remote network identifier.



When configuring an SNA over IPX location mapping entry and the remote destination host is an AS/400, the remote IPX node address value must be equal to *AS400.

Specify a 12-character IPX node address. Valid values range from 000000000001 through FFFFFFFF0001.

Sample SNA over IPX Location Entries

Figure 120 shows the example SNA over IPX location mapping entry for System A.

```

Add SNA over IPX Location (ADDSNLOC)

Type choices, press Enter.

Remote location . . . . . IPXA           Name
Remote network identifier . . . APPN       Name, *NETATR
Remote IPX network number . . . 00000001  00000001-FFFFFFFD
Remote IPX node address . . . *AS400    00000001-FFFFFFFFFE...
  
```

Figure 120. Add SNA over IPX Locations Command Prompt Example

The Work with SNA over IPX Locations display shows the location mappings that were successfully added. See Figure 121.

```

Work with SNA over IPX Locations
System: SYSTEMA

Type options, press Enter.
 1=Add  2=Change  4=Remove

Opt      Remote SNA      Remote SNA      Remote IPX      Remote IPX
         Location Name   Network         Network         Node Address
         IPXA           APPN            00000001       *AS400
         IPXB           APPN            00000002       *AS400
         IPXC           APPN            00000003       *AS400
  
```

Figure 121. Successfully added SNA over IPX Locations Example

CL Commands for the APPC over IPX Locations

On all the systems, the following commands add the APPC over IPX location mappings of the System A, System B, and System C.

```

ADDSNILOC RMTLOCNAME(IPXA) RMTNETID(*APPN)      +
          RMTNETNBR(00000001) RMTNDEADR(*AS400)
ADDSNILOC RMTLOCNAME(IPXB) RMTNETID(*APPN)      +
          RMTNETNBR(00000002) RMTNDEADR(*AS400)
ADDSNILOC RMTLOCNAME(IPXC) RMTNETID(*APPN)      +
          RMTNETNBR(00000003) RMTNDEADR(*AS400)

```

The same configuration can be used on the other two systems.



The mapping for the local system (IPXA on System A) is ignored and will not cause any problems.

Step 6—Allow AnyNet/400 Support

To communicate using APPC over IPX support, the systems must allow AnyNet/400 support and IPX support must be active. To allow AnyNet/400 support, the allow AnyNet support (ALWANYNET) network attribute must be *YES.

Specify *YES for the allow AnyNet support (ALWANYNET) network attribute using the Change Network Attribute (CHGNETA) CL command. The system looks for LU names in the IPX location address mapping information only if ALWANYNET is *YES.



Specifying ALWANYNET(*YES) enables and allows all AnyNet/400* support. In other words, this network attribute affects not only APPC over IPX support but also TCP/IP over SNA support, APPC over TCP/IP support, and TCP/IP over IPX support.

The following command, issued on all three systems, ensures that the systems allow the use of AnyNet/400 support, which includes APPC over IPX support.

```
CHGNETA ALWANYNET(*YES)
```

The *CL Reference* has more information about the CHGNETA command.

Step 7—Activating APPC over IPX Support

To activate IPX support, you must have previously created an IPX description and IPX circuit.

You can then activate IPX support by entering the Start IPX (STRIPX) command specifying an IPX description as follows:

```
STRIPX IPXD(SYSTEMA)
```



This IPX description was configuration in “ Step 1—Creating an Internet-network Packet Exchange (IPX) Description” on page 23.

APPC over IPX Common Configuration Errors

For some common configuration errors, refer to “SNA Over IPX Debugging Capabilities” on page 157.

Matching Parameters

The following diagram shows the parameters that need to match when System A is connecting to System B in this APPC over IPX configuration example.

AS/400 System A:

Network Attributes
 ALWANYNET *YES
 LCLLOCNAME SYSTEMA
 LCLNETID APPN

IPX Description
 IPXD IPXA
 IPXNETNBR 00000001

APPC Controller Description
 CTLD IPXCTLA
 LINKTYPE *ANYNW
 RMTNETID APPN
 RMTCPNAME IPX1

APPN Remote Location List
 RMTLOCNAME IPXB
 RMTNETID APPN
 LCLOCNAME IPXA
 RMTCPNAME IPX1
 RMTNETID APPN

APPN Local Location List
 LCLLOCNAME IPXA
 LCLNETID APPN

SNA over IPX location
 RMTLOCNAME IPXB
 RMTNETID APPN
 RMTNETNBR 00000002
 RMTNDEADR *AS400

AS/400 System B:

Network Attributes
 ALWANYNET *YES
 LCLLOCNAME SYSTEMB
 LCLNETID APPN

IPX Description
 IPXD IPXB
 IPXNETNBR 00000002

APPC Controller Description
 CTLD IPXCTLB
 LINKTYPE *ANYNW
 RMTNETID APPN
 RMTCPNAME IPX2

APPN Remote Location List
 RMTLOCNAME IPXA
 RMTNETID APPN
 LCLOCNAME IPXB
 RMTCPNAME IPX2
 RMTNETID APPN

APPN Local Location List
 LCLLOCNAME IPXB
 LCLNETID APPN

SNA over IPX location
 RMTLOCNAME IPXA
 RMTNETID APPN
 RMTNETNBR 00000001
 RMTNDEADR *AS400

Figure 122. SNA over IPX Configuration Matching Parameter Example

Appendix A. CL Program for the IPX Configuration Example

The following CL commands can define the sample network in Configuring the Internetwork Packet Exchange (IPX) Support.

```
/* System A: AS/400 */
/* IPX Description */
CRTIPXD IPXD(SYSTEMA) IPXNETNBR(00000001) +
      TEXT('IPXD for System A')
/* Ethernet Line */
CRTLINETH LIND(AETHLINE) RSRNAME(CMN181) +
      ADPTADR(*ADPT) ETHSTD(*ALL) +
      SSAP(*SYSGEN) +
      TEXT('Ethernet Line for System A')
/* IPX Circuit */
ADDIPXCCT CCTNAME(CCT1A) LIND(AETHLINE) IPXNETNBR(2FFFFFFF) +
      FRAMETYPE(*SSAP)
/* System B: AS/400 */
/* IPX Description */
CRTIPXD IPXD(SYSTEMB) IPXNETNBR(00000002) +
      TEXT('IPXD for System B')
/* Ethernet Line Description */
CRTLINETH LIND(BETHLINE) RSRNAME(CMN181) +
      ADPTADR(*ADPT) ETHSTD(*ALL) +
      SSAP(*SYSGEN) +
      TEXT('Ethernet Line for System B')
/* IPX Circuit Definition */
ADDIPXCCT CCTNAME(CCT1B) LIND(BETHLINE) IPXNETNBR(2FFFFFFF) +
      FRAMETYPE(*SSAP)
/* System C: AS/400 */
/* IPX Description */
CRTIPXD IPXD(SYSTEMC) IPXNETNBR(00000003) +
      TEXT('IPXD for System C')
/* Ethernet Line Description */
CRTLINETH LIND(CETHLINE) RSRNAME(CMN181) +
      ADPTADR(*ADPT) ETHSTD(*ALL) +
      SSAP(*SYSGEN) +
      TEXT('Ethernet Line for System C')
/* X.25 Line Description */
CRTLINX25 LIND(CX25LINE) RSRNAME(CMN051) +
      LGLCHLE((002 *SVCBOTH)) NETADR(000000999) +
      CNNINIT(*LOCAL) ONLINE(*YES) INTERFACE(*X21BISV24) +
      CNN(*NONSWTPP) EXNNETADR(*NO) X25DCE(*NO) +
      TEXT('X25 Line for System C')

/* X.25 IPX Circuits */
ADDIPXCCT CCTNAME(CCT1C) LIND(CETHLINE) IPXNETNBR(2FFFFFFF) +
      FRAMETYPE(*SSAP)
ADDIPXCCT CCTNAME(CCT2C) LIND(CX25LINE) SVCNETADR('000009994') +
      RIPSTATE(*OFF) SAPSTATE(*OFF)
/* Circuit Route Entries */
ADDCCTRTE CCTNAME(CCT2C) RMTNETNBR(00000004) +
      NBRHOP(1) NBRTICK(10)
ADDCCTRTE CCTNAME(CCT2C) RMTNETNBR(00000005) +
      NBRHOP(2) NBRTICK(12)
ADDCCTRTE CCTNAME(CCT2C) RMTNETNBR(00000006) +
```

```

        NBRHOP(2) NBRICK(12)
ADDCCTRTE CCTNAME(CCT2C) RMTNETNBR(00000007)      +
        NBRHOP(2) NBRICK(12)

/* System D: AS/400                                */
/* IPX Description for System D                    */
CRTIPXD IPXD(SYSTEMD) IPXNETNBR(00000004)        +
        TEXT('IPXD for System D')
/* X.25 line for System D                          */
CRTLINX25 LIND(DX25LINE) RSRNAME(CMN061)          +
        LGLCHLE((002 *SVCBOTH)) NETADR(000009994) +
        CNNINIT(*LOCAL) ONLINE(*YES) INTERFACE(*X21BISV24) +
        CNN(*NONSWTPP) EXNNETADR(*NO) X25DCE(*NO)
/* X.25 IPX Circuit Definition                    */
ADDIPXCCT CCTNAME(CCT1D) LIND(DX25LINE)          +
        SVCNETADR('000000999') RIPSTATE(*OFF)    +
        SAPSTATE(*OFF)
/* Circuit Route Entries                          */
ADDCCTRTE CCTNAME(CCT1D) RMTNETNBR(00000001)    +
        NBRHOP(2) NBRICK(12)
ADDCCTRTE CCTNAME(CCT1D) RMTNETNBR(00000002)    +
        NBRHOP(2) NBRICK(12)
ADDCCTRTE CCTNAME(CCT1D) RMTNETNBR(00000003)    +
        NBRHOP(1) NBRICK(10)
/* System G: AS/400                                */
/* IPX Description                                  */
CRTIPXD IPXD(SYSTEMG) IPXNETNBR(00000007)      +
        TEXT('IPXD for System G')
/* Token-Ring Line Description                    */
CRTLINTRN LIND(GTRNLINE) RSRNAME(CMN121)        +
        TEXT('TRN Line for System G')
/* IPX Circuit Definition                          */
ADDIPXCCT CCTNAME(CCT1G) LIND(GTRNLINE) IPXNETNBR(2FFF0000) +
        FRAMETYPE(*SSAP)
/* IPX Circuit Service                             */
ADDCCTSRV CCTNAME(CCT2C) SRVNAME(Network Printer) +
        SRVTYPE(*PRTSVR) RMTNETNBR(6)           +
        RMTNDEADR(4000000000ED) RMTSCKADR(0001) +
        NBRHOP(2)

```

Note: The Install NetWare Server (INSNTWSRV) command is not part of the sample configuration, but should be added to complete the configuration for FSIOP on System D in our sample network. See "Advanced IPX Configuration" on page 89.

Appendix B. Database Files Used by IPX Support

Saving and Restoring Configuration Files	139
Displaying Configuration Files	140
IPX Database Files for OS/400	140
File QAZSPPADR (IP over IPX Addresses)	141
File QAZSPLOC (SNA over IPX Locations)	141
File QAZSPPCCT (IPX Circuits)	142
File QAZSPPRTE (IPX Routes)	143
File QAZSPPSRV (IPX Circuit Services)	143

The configuration data that is associated with IPX support is stored in a set of database files. These database files are found in the QUSRSYS library. As a user, you should never need to change or manipulate these files. The information that is given is only for your information and can be used to assist in problem analysis. Any time you make configuration changes using the Configure IPX menu options 1, 10, 11, 12, 20, or the CL commands associated with these options, the configuration database files are updated to reflect these changes. All the configuration changes that are made with the previous options, except for option 20, take effect immediately in the protocol stack if IPX support is active.

Each of the configuration functions stores its data in a separate keyed physical file in the QUSRSYS library. Keyed access for physical and logical files is used, where required, to access the data. For example, the circuits configuration data is stored in a file that is called QAZSPPCCT, member CIRCUITS.

Other database files and members are used for work areas or for storing information.

Saving and Restoring Configuration Files

You should save and restore all IPX configuration files as a group. Many logical files are defined; their names are:

QAZSPLADR QUSRSYS	System-supplied IP over IPX address file that is defined on QAZSPPADR physical file
QAZSPLCCT QUSRSYS	System-supplied IPX circuit logical file that is defined on QAZSPPCCT physical file
QAZSPLRTE QUSRSYS	System-supplied IPX route logical file that is defined on QAZSPPRTE physical file
QAZSPLSRV QUSRSYS	System-supplied IPX service logical file that is defined on QAZSPPSRV physical file

Saving just the physical files and then restoring them will cause problems. The logical files used by different functions to access the data stored in the physical files will point to a renamed physical file if just a physical file is restored. The restore database functions have created the renamed physical file to maintain the indexes to the logical files. Another reason to save and restore the configuration files as a group is that there are some dependencies between some of the files. Saving and restoring just a subset of the files could cause problems especially when activating IPX processing.

One way to save all IPX files is to enter the following command:

```
SAVOBJ OBJ(QAZSP*) LIB(QUSRSYS)
DEV(your-device) OBJTYPE(*FILE)
```

One way to restore all IPX files is to enter the following command:

```
RSTOBJ OBJ(QAZSP*) SAVLIB(QUSRSYS)
DEV(your-device) OBJTYPE(*FILE)
```



If you restore previous released versions of any of the IPX configuration files, you **must** reinstall the QUSRSYS and QGPL libraries for the operating system release level of your AS/400. This ensures that the install exit file conversion programs are run against the IPX configuration files.

If you plan to scratch install your AS/400 and save your current IPX configuration, do the following steps:

1. Save the IPX configuration files
2. Scratch install your AS/400
3. Delete all QAZSP* files in QUSRSYS
4. Restore the IPX configuration files
5. Reinstall QUSRSYS and QGPL libraries

Displaying Configuration Files

To display these files, use the Work with Members Using PDM (WRKMBRPDM) command and specify QUSRSYS/xxx for the FILE parameter:

```
WRKMBRPDM FILE(QUSRSYS/xxx)
```

where xxx is the name of an IPX file. You are shown the members that are contained in the file. Use option 5 (Display) to see the contents of the file member.

You can also use the Display Physical File Member (DSPPFM) command to show the contents of a member in a file.

IPX Database Files for OS/400

The physical database files and members that define the IPX protocol stack configuration are listed in Table 9 and the member formats are described in subsequent tables. In addition, logical files that correspond to the physical files are used to access configuration data (when required). The logical files are not listed.

Table 9 (Page 1 of 2). Physical Database Files and Record Lengths

Library/File.member	Description	Record length
QUSRSYS/QAZSPPADR.ADDRESSES, see "File QAZSPPADR (IP over IPX Addresses)" on page 141	IP over IPX address mapping configuration data	128
QUSRSYS/QAZSPLOC.LOCATIONS, see "File QAZSPLOC (SNA over IPX Locations)" on page 141	SNA over IPX locations configuration data	64

Table 9 (Page 2 of 2). Physical Database Files and Record Lengths

Library/File.member	Description	Record length
QUSRSYS/QAZSPPCCT.CIRCUITS, see "File QAZSPPCCT (IPX Circuits)" on page 142	IPX circuit configuration data	528
QUSRSYS/QAZSPPRTE.ROUTES, see "File QAZSPPRTE (IPX Routes)" on page 143	IPX circuit route configuration data	256
QUSRSYS/QAZSPPSRV.SERVICES, see "File QAZSPPSRV (IPX Circuit Services)" on page 143	IPX circuit service configuration data	256
QUSRSYS/QATOCIFC.INTERFACES, see the <i>TCP/IP Configuration and Reference</i> book.	IP over IPX interface configuration data	512
QUSRSYS/QATOCRTE.ROUTES, see the <i>TCP/IP Configuration and Reference</i> book.	IP over IPX route configuration data	256

File QAZSPPADR (IP over IPX Addresses)

Table 10. QAZSPPADR Member Format (IP over IPX Address Mapping Configuration Data)

Field	Starting Column	Length	Allowed Values
INTNETADR	1	15	Internet Address
BININTNET	16	4	Binary Internet Address
SUBNETMASK	20	15	Subnet Mask
BINSUBNET	35	4	Subnet Mask in Binary
IPXNETNBR	39	4	Remote IPX Network Number
IPXNODEADR	43	6	IPX Node Address
Reserved	49	80	Reserved for future use
Total Length		128	

File QAZSPLOC (SNA over IPX Locations)

Table 11. QAZSPLOC Member Format (SNA over IPX Location Name Mapping Configuration Data)

Field	Starting Column	Length	Allowed Values
RMTLOCNAME	1	8	Remote Location Name
RMTNETID	9	8	Remote SNA Network Identifier
IPXNETNBR	17	4	Remote IPX Network Number
IPXNODEADR	21	6	Remote IPX Node Address
Reserved	27	38	Reserved for future use
Total Length		64	

File QAZSPPCCT (IPX Circuits)

Table 12. QAZSPPCCT Member Format (IPX Circuit Configuration Data)

Field	Starting Column	Length	Allowed Values
CIRCUITNME	1	48	Circuit Name
CIRCUIT_ID	49	4	Circuit ID
LIND	53	10	Line Description
NETNBR	63	4	Network Number
NETNBR_C	67	8	Network Number in Character
FRAMETYPE	75	1	Frame Type
DFTMAXDTG	76	4	Default Maximum Datagram
THROUGHPUT	80	4	Throughput
DELAY	84	4	Delay
AUTOSTART	88	1	Automatic Start
PVC	89	3	PVC Channel ID
SVCNETADR	92	17	SVC Network Address
SVCTYPE	109	1	SVC Call Type
SVCRVSCRG	110	1	SVC Reverse Charge
IDLVCTIMO	111	2	IDLVCTIMO in Binary Format
RCVPKTSIZE	113	4	Receive Packet Size
TRNPKTSIZE	117	4	Transmit Packet Size
RCVWDWSIZE	121	4	Receive Window Size
TRNWDWSIZE	125	4	Transmit Window Size
NLSP	129	1	Enabled for NLSP
MACCHNLNLS	130	1	MAC Channel for NLSP
RTRPTYNLSP	131	2	Router Priority
CSTOVRNLSP	133	2	Cost Override NLSP
IW2	135	1	Enable for IW2
RIPSTATE	136	1	RIP State
RIPUPDITV	137	4	RIP Update Interval
RIPAGEMLT	141	4	RIP Age Multiplier
SAPSTATE	145	1	SAP State
SAPUPDITV	146	4	SAP Update Interval
SAPAGEMLT	150	4	SAP Age Multiplier
FSIOP	154	1	FSIOP Circuit
IW2TMRRTY	155	2	IW2 Timer Request Retry
IW2TMRITV	157	2	IW2 Timer Request Interval
Reserved	159	370	Reserved for future use
Total Length		528	

File QAZSPRTE (IPX Routes)

Table 13. QAZSPRTE Member Format (IPX Circuit Routes Configuration Data)

Field	Starting Column	Length	Allowed Values
CIRCUITNAME	1	48	Circuit Name
NETNBR	49	4	Remote Network Number
NETNBR_C	53	8	Network Number in Character
NBRHOPS	61	2	Number of Hops
NBRTICKS	63	2	Number of Ticks
NEXTHOP	65	6	Next Hop Node Address
NEXTHOP_C	71	12	Next Hop in Character
Reserved	83	174	Reserved for future use
Total Length		256	

File QAZSPPSRV (IPX Circuit Services)

Table 14. QAZSPPSRV Member Format (IPX Circuit Service Configuration Data)

Field	Starting Column	Length	Allowed Values
CIRCUITNME	1	48	Circuit Name
SERVICENME	49	48	Service Name
SRVNMEASC	97	48	Service Name in ASCII
SRVTYPE	145	2	Service Type
SRVTYPE_C	147	4	Service Type in Character
RTNETNBR	151	4	Remote Network Number
RMTNETNBR_C	155	8	Network Number in Character
RNODEADR	163	6	Remote Node Address
RNODEADR_C	169	12	Remote Node in Character
RMTSOCKADR	181	2	Remote Socket Address
RSOCKADR_C	183	4	Remote Socket Address in Character
NBRHOPS	187	2	Number of Hops
Reserved	189	68	Reserved for future use
Total Length		256	

Appendix C. Security for IPX Commands and Objects

This appendix discusses security as it relates to the IPX commands, automatic configuration, network devices, and programs. For more information about these commands, see the *CL Reference* book.

*IOSYSCFG Authority Required

*IOSYSCFG is the special authority that is required by these IPX commands to use or change any object.

- Add IPX Circuit (ADDIPXCCT)
- Add Circuit Route (ADDCCTRTE)
- Add Circuit Service (ADDCCTSRV)
- Add IP over IPX Address (ADDIPIADR)
- Add IP over IPX Interface (ADDIPIIFC)
- Add IP over IPX Route (ADDIPIRTE)
- Add SNA over IPX Location (ADDSNILOC)
- Change IPX Circuit (CHGIPXCCT)
- Change Circuit Route (CHGCCTRTE)
- Change Circuit Service (CHGCCTSRV)
- Change IP over IPX Address (CHGIPIADR)
- Change IP over IPX Interface (CHGIPIIFC)
- Change SNA over IPX Location (CHGSNILOC)
- Remove IPX Circuit (RMVIPXCCT)
- Remove Circuit Route (RMCCTRTE)
- Remove Circuit Service (RMCCTSRV)
- Remove IP over IPX Address (RMVIPIADR)
- Remove IP over IPX Interface (RMVIPIIFC)
- Remove IP over IPX Route (RMVIPIRTE)
- Remove SNA over IPX Locations (RMVSNILOC)

Command Object Authority

These commands are shipped with the following command object authorities:

QSYS *ALL
*PUBLIC *USE

*IOSYSCFG Authority Not Required

These IPX commands do not require any special authority.

- Change IPX Description (CHGIPXD)
- Change IPX Description (CHGIPXD)
- Configure IP over IPX (CFGIPX)
- Configure IPX (CFGIPX)
- Create IPX Description (CRTIPXD)
- Display IPX Circuit (DSPIXCCT)
- Display IPX Description (DSPIPXD)
- Display Circuit Route (DSPCCTRTE)
- Display Circuit Service (DSPCCTSRV)
- IPXPING (see Verify IPX Connection)
- Verify IPX Connection (VRYIPXCNN)
- Work with Circuit Route (WRKCCTRTE)
- Work with Circuit Service (WRKCCTSRV)
- Work with IPX Circuit (WRKIPXCCT)
- Work with IPX Description (WRKIPXD)
- Work with IPX Status (WRKIPXSTS)

Command Object Authority

These commands are shipped with the following command object authorities:

```
QSYS      *ALL
*PUBLIC   *USE
```

Object Authority Required

These IPX commands do not require any special authority.

- End IPX (ENDIPX)
- End IP over IPX Interface (ENDIPIIFC)
- End IPX Circuit (ENDIPXCCT)
- Start IPX (STRIPX)
- Start IPX Circuit (STRIPXCCT)
- Start IP over IPX Interface (STRIPIIFC)

Command Object Authority

These commands are shipped with the following command object authorities:

```
QSYS      *ALL
QSRV      *USE
QSRVBAS   *USE
QSYSOPR   *USE
QPGMR     *USE
*PUBLIC   *EXCLUDE
```

Authority can be changed using the Revoke Object Authority (RVKOBJAUT) command and the Grant Object Authority (GRTOBJAUT) command. To remove the authority of the QSYSOPR user profile from the End IPX Circuit (ENDIPXCCT) command, the following example command could be used:

```
RVKOBJAUT OBJ(ENDIPXCCT)
          OBJTYPE(*CMD) USER(QSYSOPR)
          AUT(*USE)
```

To give another user authority to the ENDIPXCCT command, the GRTOBJAUT command could be used as follows:

```
GRTOBJAUT OBJ(ENDIPXCCT)
          OBJTYPE(*CMD) USER(RUNEB)
          AUT(*USE)
```

These commands can be used in the same way to revoke or grant user authority to almost any object on the AS/400. To be able to view which users have authority to an object, use the Edit Object Authority (EDTOBJAUT) command. This command can be issued by a user with all rights to the object to revoke and grant user authority to the object from a single display.

Object Security for Network Configuration

IPX uses the information in the line description associated with an IPX circuit to determine which communications line to use. The line description can also be used to identify the attached network controller and the network device objects that the IPX protocol uses when the circuit is started. The line description is also used to identify the network server description object or network interface description object that the line description is attached to. To view or change the line description associated with an IPX circuit, select option 1 (Work with IPX circuits) from the Configure IPX menu (reached by typing GO CFGIPX or CFGIPX on the command line).

If the network controller and network device do not exist, IPX uses the automatic configuration support to create them when the first circuit that is associated with the line description is started. If the network controller or device is created by automatic configuration, *PUBLIC will be granted *CHANGE authority to the controller and device. Therefore, the objects are not secure.



IPX is an OS/400 system service and will function correctly no matter what authority you specify for the network configuration objects it uses. Use the Grant Object Authority (GRTOBJAUT) command to change the authority to access a communications line configuration object.

The QIPX job that runs in the QSYSWRK subsystem will lock the network device when any circuit that uses that network device is started. This prevents the line from being varied off while an IPX circuit is using it. To remove the lock that is held by the QIPX job, do one of the following:

- Use the End IPX Circuit (ENDIPXCCT) command to end the circuit that is using the line.
- Use the End IPX (ENDIPX) command to end all IPX processing. The ENDIPX command will end all IPX circuits and the QIPX job.

Appendix D. IPX Performance

Main Storage Pool Size	149
IPX Jobs	149
IPX Protocol Support Provided by IOP	149
Packet Rollup	150
Packet Train	150
Service Advertising Protocol (SAP) Off-load	150
Routing Information Protocol (RIP) Off-load	150
NetWare Link Services Protocol (NLSP) Off-load	151
Simple Network Management Protocol (SNMP) Support	151

The following performance items should be considered when using IPX support.

The IPX protocol stack always runs in the main storage pool on the AS/400 system. If the main storage pool is not given enough storage, IPX does not perform at its optimal level.

Main Storage Pool Size

Although it is possible to run in pools of less than 4000 KB of storage, it is suggested that the main storage pool be configured to use at least 4000 KB of storage. You can use the Work with System Storage (WRKSYSSTS) command to view and change pool sizes on AS/400 systems. Another alternative is to change the pool in which the IPX jobs run.

IPX Jobs

IPX jobs, like other jobs on your system, are created from job descriptions and associated classes. The job descriptions and classes should be adequate in most cases; however, they may be changed to fit your system needs.

The IPX job description has a number of items associated with it that define how the application runs on the AS/400. One of these pieces of information is the routing entry compare value. This value identifies which routing entry in a subsystem description is used when this job is submitted. By changing that routing entry, you can select in which storage pool to run the jobs for a particular application.

For information on compare values, see the *Work Management* book.

Other items that can be changed or selected on the QIPX and QAPPCIPX jobs include the job priority, the logging level for messages, and the initial library list.

IPX Protocol Support Provided by IOP

The input/output processor (IOP) performs protocol assistance functions for IPX, RIP, SAP, and NLSP. This protocol assistance off-loads work from the AS/400 processor to the IOP, which reduces the processing requirements and usage for the IPX support on AS/400.

The IOP assists the IPX/SPX processing by providing the following functions:

- Packet rollup
- Packet train
- RIP off-load
- SAP off-load
- SNMP support
- NLSP off-load

These functions are called *IOP-assist functions*. They are only available on the following IOPs:

IOP Type	Description
2617, 2723, 6181	Ethernet IEEE 802.3 adapter
2619, 2724, 6149	16/4 Mbps Token-Ring Network adapter/HP
2666, 2699	High-speed communication adapter, running frame relay only
6506, 6616, 2805	Integrated PC Server adapters

Note: When the X.25 protocol is used, you do not gain the advantage of the IOP-assistance function.

Packet Rollup

The OS/400 has the ability to bundle outbound IPX packets in certain circumstances when sending them to the IOP. This is known as **packet rollup**. Packet rollup reduces the number of times that IPX support must interact with the IOP when sending IPX packets.

Packet Train

The IOP can **bundle** inbound IPX packets in certain circumstances when sending them to the IPX support. This is known as **packet train**. Packet train reduces the number of times the IOP must interact with IPX support when receiving IPX packets.

Service Advertising Protocol (SAP) Off-load

The IOP assists the OS/400 program by performing the following functions for SAP:

- Informing OS/400 of service changes.
- Periodically broadcasting SAP information to other routers on the local network.
- Caching SAP information based on SAP responses and broadcast information.
- Aging of SAP information cache.

Routing Information Protocol (RIP) Off-load

The IOP assists the OS/400 program by performing the following functions for RIP:

- Construction of RIP packets.
- Initially broadcasting RIP information to other routers on the local network.
- Forwarding RIP information to the host.

- Periodically broadcasting RIP information to other routers on the local network.
- Caching RIP information based on RIP responses and broadcast information.
- Aging of RIP information cache.
- Supporting next hop routing.

NetWare Link Services Protocol (NLSP) Off-load

The IOP assists the OS/400 program by performing the local neighborhood discovery, or adjacency, part of the NetWare Link Services Protocol. The IOP performs the following functions:

- Caching adjacency information (other routers on the network) and forwarding changes to OS/400
- Periodically transmitting the NLSP Hello packet
- Electing the NLSP designated router

Simple Network Management Protocol (SNMP) Support

The IOP and OS/400 maintain all relevant SNMP information. The portion of the SNMP information for IPX support is accessed by the SNMP agent support on the AS/400. The IOP maintains management information base (MIB) information for the IPX functions: packet rollup, packet train, RIP off-load, SAP off-load, SNMP support, and NLSP off-load. When someone wants the MIB information, the OS/400 SNMP agent works with the OS/400 IPX support and the IOP to retrieve the information.

AS/400 supports the Novell MIB structure, which consists of three subtrees: IPX, RIP/SAP, and NLSP.

The IPX MIB defines the framework for the management of systems implementing the IPX protocol. The RIP/SAP MIB provides information about each instance of RIP and SAP running on one system. The NLSP MIB provides the management information for the NLSP protocol running in an IPX environment.

Novell allows Set functionality against most of the MIB objects, but the implementation in OS/400 does not allow Sets against any of the MIB objects.

The TCP/IP protocol must be used between the SNMP manager and SNMP agent to submit MIB requests for the IPX MIB. Requests using the IPX protocol are not supported.

For more information about the OS/400 SNMP Agent support, see the *Simple Network Management Protocol (SNMP) Support* book.

Appendix E. IPX Problem Analysis

Working with the Job Log and Message Queues	153
Common Configuration Errors	154
Tracing IPX Protocol Layer Problems	154
Setting Up a Licensed Internal Code Trace	154
Starting Component Traces	156
SNA Over IPX Debugging Capabilities	157
Tracing SNA over IPX Problems	158
IP over IPX Debugging Capabilities	159
Additional Debugging IP over IPX Configurations Information	160
Tracing IP over IPX Problems	160
Collecting a Communications Trace	161
Planning to Set up a Trace	162
Accessing the Start Service Tool (SST) Function	163
Starting a Communications Trace	164
Stopping a Communications Trace	167
Formatting and Saving the Communications Trace	168
Verifying the Contents of the Communications Trace	168
Return Codes and Messages Issued by IPX Support	171
Alertable Messages	174

This appendix is intended to be used for determining solutions to problems that are encountered while using IPX.

Working with the Job Log and Message Queues

IPX is shipped with job descriptions. The job descriptions and their associated jobs are as follows:

- QZSPJOB D for the QIPX (the QIPX job)
- QZSPSNAIPX for the QAPPCIPX (the SNA over IPX job)

The job descriptions are stored in the QSYS library. They are shipped with a message logging level of 4, a message logging severity of 0, and a message logging text value of *NOLIST. They are shipped with these values to prevent job logs from being created with only job-started and job-ended messages in them.

If you are having problems with the operation of IPX, one of the first things to do is to change the message logging level to *SECLVL on the job description for the application you are having problems with. Changing the message logging level generates a job log for that application as long as you end the current job and restart it using the updated job description.

```
CHGJOB D JOB D(QTCP/QZSPJOB D) LOG(4 0 *SECLVL)
CHGJOB D JOB D(QTCP/QZSPSNAIPX) LOG(4 0 *SECLVL)
```

Common Configuration Errors

Some common configuration errors are:

- Not starting host servers for Client Access/400 after you start IPX support. See “Starting IPX” on page 69 for more information.
- Not starting the circuits you want to use to reach a remote network. See “Starting IPX Circuits” on page 76 for more information.
- Not configuring the static services and routes associated with on demand SVC circuits. See “Step 4–Adding Circuit Route Information” on page 57 and “Step 5–Adding Circuit Service Information” on page 61 for more information.
- Not creating the correct line descriptions for IPX support. See “ Step 2–Configuring Line Descriptions for IPX Support–Ethernet” on page 30. More than one CPE0003 message is displayed when this error occurs.
- Attempting to use the same IPX description for both OS/400 IPX support and a *NETWARE FSIOP. Each FSIOP and the OS/400 IPX support must use a unique IPX description. See “ Step 1–Creating an Internetwork Packet Exchange (IPX) Description” on page 23 for more information.

Tracing IPX Protocol Layer Problems

If an IPX protocol layer problem occurs, you can perform a Licensed Internal Code (LIC) trace of the IPX component to capture the problem.

This LIC component can be traced using the system service tools (SST). This service function is accessed using the Start System Service Tools (STRSST) command. This function allows you to generate a LIC trace of the AS/400 IPX support.



Contact the security officer or system administrator to get service authority to use SST. This authority is necessary to use SST.

Setting Up a Licensed Internal Code Trace

1. To setup a LIC trace, enter:

```
STRSST
```

The System Service Tools (SST) menu is shown.

System Service Tools (SST)

Select one of the following:

1. Start a service tool
2. Work with active service tools
3. Work with disk units
4. Work with diskette data recovery

Selection

1
F3=Exit

F10=Command entry

F12=Cancel

2. Use option 1 (Start a service tool). The following display is shown:

Start a Service Tool

Warning: Incorrect use of this service tool can cause damage to data in this system. Contact your service representative for assistance.

Select one of the following:

1. Product activity log
2. Trace Licensed Internal Code
3. Work with communications trace
4. Display/Alter/Dump
5. Licensed Internal Code log
6. Main storage dump manager
7. Hardware service manager

Selection

2

F3=Exit

F12=Cancel

F16=SST menu

3. Use option 2 to trace licensed internal code:

Work with Licensed Internal Code Trace Tables

Type options, press Enter.

1=Create 2=Allocate 3=Status 4>Delete 5=Display
6=Dump 7=Start Traces 8=Stop Traces 9=Clear

Option	Table name	Creation Date	Status
-	System Default Trace Table	12/08/95	Inactive
-	IPX BRINGUP	01/10/96	Inactive
-	ANYNET TRACING	01/25/96	Inactive
-	DAN	01/29/96	Inactive
-	TCP	03/18/96	Inactive
-	SPX	04/04/96	Inactive
-	SOCKETS	04/05/96	Inactive
-	APPC OVER TCP	05/02/96	Inactive
<u>7</u>	IPX	06/10/96	Inactive
-	IPX2	06/17/96	Inactive

F3=Exit F12=Cancel

4. Use option 7 to start traces.

Starting Component Traces

1. Use option 1 to start component traces.

Start Traces

Type options, press Enter.
1=Start trace

Opt	Description
<u>1</u>	Component traces
-	MI instruction Supervisory Linkage (SVL) trace
-	Multi-programming Level (MPL) trace
-	Transaction trace

F3=Exit F12=Cancel

2. Choose Internetwork Packet Exchange (IPX) to start a LIC trace of IPX traffic.

```

Start Component Traces

Type options, press Enter.
 1=Start trace

Opt Description
- Display station passthru
- Environmental Recording, Editing and Printing (EREP)
- Error Log
- Event management
- Exception management
- Hardware Resources
- Heap manager
- Independent index
- Integrated File System (IFS)
1 Internetwork Packet Exchange (IPX)
- Inter-process Communications Facility (IPCF)
- Journal management
- Link test service function
- Load/Dump
- Machine Interface (MI) Transformer

F3=Exit F12=Cancel
More.

```

SNA Over IPX Debugging Capabilities

Debugging SNA over IPX problems is often a matter of doing standard debug of an APPC application. However, some additional problems can occur when first attempting to run the application over an IPX network.

- When an APPC application on the AS/400 attempts to open a connection to a remote location across a IPX network, three configuration steps are often overlooked:
 - If the APPN remote configuration list does not have an entry for the remote location that the APPC program is attempting to open to, the AS/400 attempts to find an APPN route to the remote location. This will fail with a CPF8933 message (or similar failure), stating that a route to the specified location was not found.

You need to tie this location to APPC over IPX by adding the remote location to the remote configuration list.
 - If the SNA over IPX database file does not contain the location name to IPX address mapping, the APPC over IPX job is not able to resolve the IPX routing to the remote location. A CPIE007 message is logged as a QSYSOPR message. Additionally, the QAPPCIPX job in the QSYSWRK subsystem logs a CPDE00A message.

You need to tie this location to a particular IPX address by adding the remote location to IPX address mapping in the SNA over IPX database file using the ADD SNA over IPX Location (ADDSNILOC) command.
 - If SNA over TCP support is active (the job QAPPCTCP in the QSYSWRK subsystem is active), then it is possible that TCP/IP routing is being used to connect with the remote location. Any mapping that is defined for SNA over TCP support in the host table or remote name server will take precedence over mappings that are defined for SNA over IPX support. Look in the QAPPCTCP job description for messages containing the remote location to

which you are attempting to connect to determine if an SNA over TCP mapping is being used.

- When APPC over IPX is running, the QAPPCIPX job is active in the QSYSWRK subsystem.

If this situation is not true, make sure IPX is started and that the ALWANYNET (Allow AnyNet) network attribute is set to *YES. To start IPX, issue the Start IPX (STRIPX) command.

Tracing SNA over IPX Problems

When an SNA over IPX problem occurs and you report the problem to IBM, you may need to perform a Licensed Internal Code (LIC) trace to capture the problem.

1. Set up a Licensed Internal Code trace. See “Setting Up a Licensed Internal Code Trace” on page 154.

```
                                Start Component Traces

Type options, press Enter.
 1=Start trace

Opt  Description
  -   Machine observation
  -   Machine Services Control Point (MSCP)
  -   Modula-2 runtime support
  -   Module management
  1  Multi-Protocol Transport Network (MPTN)
  -   OptiConnect
  -   Portability utilities
  -   Power management
  -   Presentation Services APPC
  -   Process management
  -   Process table
  -   Program binder
  -   Program management
  -   Queue management
  -   Queue space management

                                More.

F3=Exit  F12=Cancel
```

2. Use option 1 to start trace of APPC over IPX traffic.

```

Start Multi-Protocol Transport Network Traces

Type options, press Enter.
  1=Start trace

Opt  Description
  -    AF INET Multi-Protocol Transport Network
  -    AF INET Protocol Enveloper and Complementer
  1   APPC over a TCP/IP Multi-Protocol Transport Network

F3=Exit  F12=Cancel

```

3. Multiprotocol Transport Networking (MPTN) is an option of the Component Trace option of LIC Trace.

IP over IPX Debugging Capabilities

When you are debugging IP over IPX on the AS/400 system, check the following configuration steps:

1. Does the local IP address exist in the IP over IPX interface configuration list? To add an IP over IPX interface, use the Add IP over IPX Interface (ADDIPIIFC) command.
2. Does the IP route to the remote node in the IP over IPX route configuration list? These routes are required whenever a remote node is not part of the same IP network. To add an IP over IPX route, use the Add IP over IPX Route (ADDIPIRTE) command.
3. Does the IP over IPX address mapping entry exist in the IP over IPX address mapping configuration list? A mapping entry maps a remote IPX network number and node address to IP address for each remote node that the local node may communicate with.
4. Is the IP over IPX interface active? There are three reasons that the IP over IPX interface is not active.
 - a. The Start IPX (STRIPX) command has not been issued.
 - b. The Allow AnyNet (ALWANYNET) network attribute is not *YES.
 - c. There are already more than the maximum allowed IP over IPX interfaces active.

Additional Debugging IP over IPX Configurations Information

Two CL commands can be helpful in debugging IP over IPX configurations:

- The Verify IPX Connection (VFYIPXCNN, also known as IPXPING) command can help you determine if your IPX configuration is correct. As input to the IPXPING command, you need the remote IPX network number and node address. You can determine the remote network number and node address from the destination IP address by using option 12 (Work with IP over IPX addresses) from the Configure IPX menu (CFGIPX).
- The Verify TCP/IP Connection (VFYTCPCNN, also known as PING) command can help you determine if your AnyNet configuration is correct.

Note: When PING fails, it does not give a detailed reason for the failure. To get a detailed reason, you should run a sockets program that reports the value for *errno* when the failure occurs.

Table 15. Common IP over IPX Configuration Errors

Sockets Error (value of <i>errno</i>)	Possible Causes
EHOSTUNREACH	<ol style="list-style-type: none"> 1. Missing ADDIPIADR command on client system. 2. Missing ADDIPIIFC command on client system. 3. ADDIPIADR command on client system resulted in a IPX remote network number that is not found.
EADDRNOTAVAIL	<ol style="list-style-type: none"> 1. AnyNet not active on client system (ALWANYNET attribute set to *NO), but TCP is started. 2. IPX not started on client system.
EUNATTACH	<ol style="list-style-type: none"> 1. AnyNet not active on client system (ALWANYNET attribute set to *NO), and TCP is not started.
ECONNREFUSED	<ol style="list-style-type: none"> 1. AnyNet not active on client system (ALWANYNET attribute set to *NO). 2. <i>listen()</i> not active on server system.
ECONNABORTED	<ol style="list-style-type: none"> 1. Line error. 2. IPX ended on client or server system while in use.
ETIMEDOUT	<ol style="list-style-type: none"> 1. ADDIPIADR command on client system points to an IPX remote node address that does not exist or is on a system that is not responding in the IPX network. 2. Messages (especially inquiry messages) on message queue QSYSOPR are waiting for a reply.
EACCES	<ol style="list-style-type: none"> 1. User not authorized to port on client system.

Tracing IP over IPX Problems

When a IP over IPX problem occurs and you report the problem to IBM, you may need to perform a LIC trace to capture the problem.

1. See "Setting Up a Licensed Internal Code Trace" on page 154 for the instructions to perform a trace.

```

Start Component Traces

Type options, press Enter.
 1=Start trace

Opt  Description
-      Machine observation
-      Machine Services Control Point (MSCP)
-      Modula-2 runtime support
-      Module management
1     Multi-Protocol Transport Network (MPTN)
-      OptiConnect
-      Portability utilities
-      Power management
-      Presentation Services APPC
-      Process management
-      Process table
-      Program binder
-      Program management
-      Queue management
-      Queue space management

F3=Exit  F12=Cancel

More...

```

2. Type option 1, to start trace of APPC over IPX traffic.

```

Start Multi-Protocol Transport Network Traces

Type options, press Enter.
 1=Start trace

Opt  Description
1     AF_INET Multi-Protocol Transport Network
1     AF_INET Protocol Enveloper and Complementer
-      APPC over a TCP/IP Multi-Protocol Transport Network

F3=Exit  F12=Cancel

```

3. Choose AF_INET Multi-Protocol Transport Network and AF_INET Protocol Enveloper and Complementer to start a LIC trace of IP over IPX traffic.

Collecting a Communications Trace

A communications trace can be used to isolate errors. You can start communications traces from SST or by using the following CL commands:

- Check Communications Trace (CHKCMNTRC)
- Delete Communications Trace (DLTCMNTRC)
- End Communications Trace (ENDCMNTRC)

- Print Communications Trace (PRTCMNTRC)
- Start Communications Trace (STRCMNTRC)

You should be able to use the communications line while the communications trace is running. You should know the name of the line before starting the procedure. In order to determine the line that you need to trace for IPX problems, look at the interfaces you defined and what line description that circuit uses.

Planning to Set up a Trace

Before starting to work with a communications trace:

1. If you have not created the library IBMLIB or output queue IBMOUTQ, enter the following commands:

```
CRTLIB LIB(IBMLIB)
CRTOUTQ OUTQ(IBMOUTQ)
```

2. Enter the following commands to add the library IBMLIB to your library list and to change the output queue for your job to output queue IBMOUTQ:

```
ADDLIBLE IBMLIB +
CHGJOB * OUTQ(IBMOUTQ)
```

3. If the QIPXPRT printer file does not exist on your system, enter the following commands to create it:

```
CRTPRTF FILE(QGPL/QIPXPRT) DEV(*JOB) +
RPLUNPRT(*YES) SCHEDULE(*FILE) +
FILESEP(0) LVLCHK(*NO) +
TEXT('IPX printer file')
CHGOBJOWN OBJ(QGPL/QIPXPRT) OBJTYPE(*FILE) +
NEWOWN(QSYS)
```

4. Enter the following commands to send the spooled file QIPXPRT containing the communications trace to the output queue IBMOUTQ in library IBMLIB:

```
OVRPRTF FILE(QIPXPRT) OUTQ(IBMOUTQ)
OVRPRTF FILE(QPCSMPT) TOFILE(QGPL/QIPXPRT)
```

The printer file overrides are not in effect after your job ends.

5. Obtain the name of the line description associated with the IPX circuit with which you are having the problem or which is used by the application or network with which you are having a problem.

Use the Work with IPX Status (WRKIPXSTS) command with the *CCT option that is specified to determine the name of the line description that is associated with the circuit.

```
WRKIPXSTS *CCT
```

6. Ensure that the line is varied on and that the IPX circuit associated with the line has been started so that IPX data can be sent and received over the circuit and the line.

Use the WRKIPXSTS command with the *CCT option that is specified, to verify that the circuit is active.

```
WRKIPXSTS *CCT
```

Use the Work with IPX Status menu to print copies of the circuits, routes, and service information for problem analysis. The information helps determine where the errors can be found.

```
                                Work with IPX Status                                SYSTEM:  SYSNAMXX
Select one of the following:
    1. Work with IPX circuit status
    2. Display IPX route information
    3. Display IPX service information
    4. Work with IPX/SPX connection status
    5. Display active IPX description

Selection or command
====> 1
-----
F3=Exit  F4=Prompt  F9=Retrieve  F12=Cancel
```

Figure 123. Work with IPX Status Menu Example

Each of the displays accessible from the Work with IPX Status menu has an F6 (Print or Print list) that is associated with it. Use the F6 key to print out the information on the status of IPX support on AS/400.

Accessing the Start Service Tool (SST) Function

To access SST:

1. Enter STRSST on a command line. The following display appears:

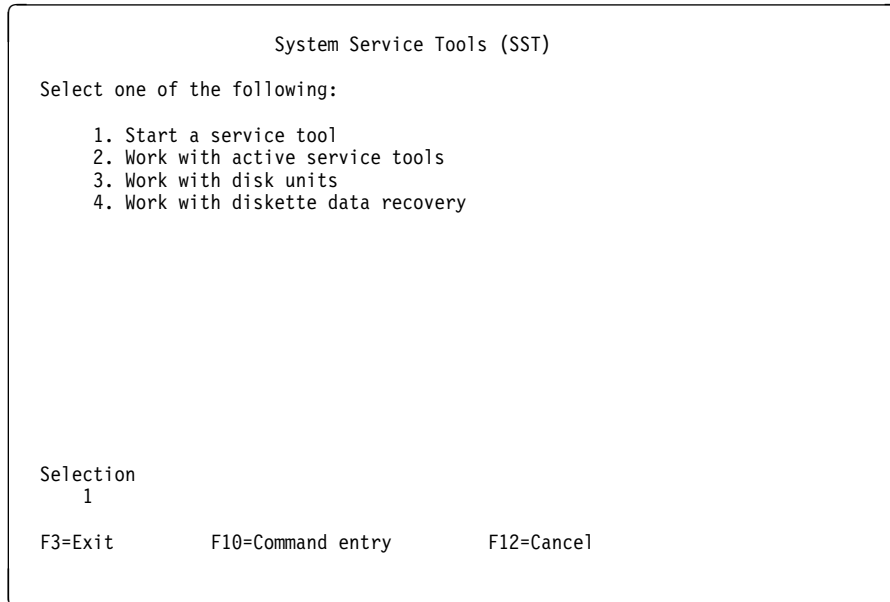

Figure 124. System Service Tools (SST) Display Example

2. Select option 1 (Start a service tool). The following display is shown:

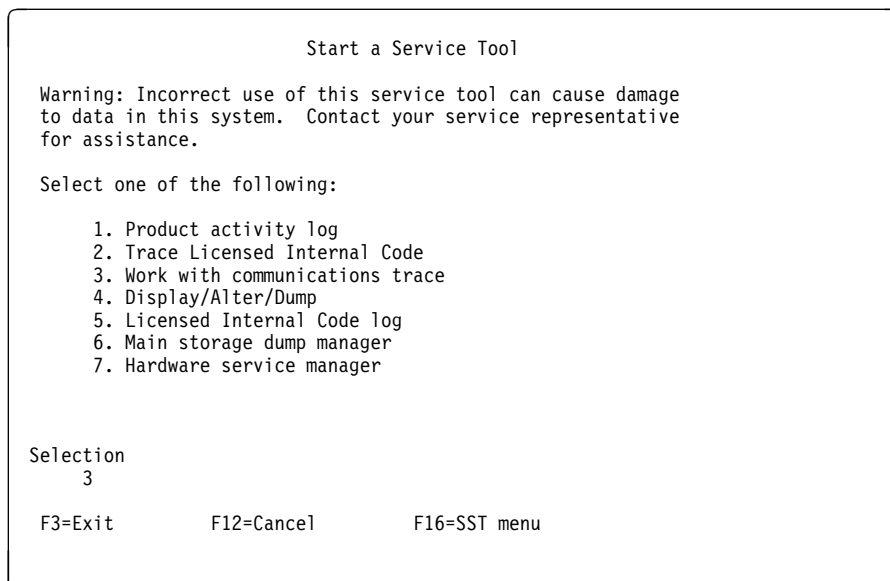

Figure 125. Start a Service Tool Menu Example

3. Select option 3 (Work with communications trace).

Starting a Communications Trace

To start a communications trace:

1. If you are instructed by the service provider to vary off the line, enter the following command; otherwise, continue with the next step.

```

VRYCFG CFGOBJ(line-name) CFGTYPE(*LIN)
STATUS(*OFF)

```

2. After you select option 3, the following display is shown:

```

Work with Communications Traces

Type options, press Enter.
 2=Stop trace      4=Delete trace   6=Format and print trace
 7=Display message 8=Restart trace

Configuration
Opt  Object      Type  Trace Description      Protocol  Trace Status

(No active traces)

```

3. Press F6 to start a trace. The following display appears:

```

Start Trace

Type choices, press Enter.

Configuration object . . . . . TRNLIN
Type . . . . . 1      1=Line, 2=Network interface
                          3=Network server

Trace description . . . . . IPX trace

Buffer size . . . . . 1      1=128K, 2=256K, 3=2048K
                          4=4096K, 5=6144K, 6=8192K

Stop on buffer full . . . . . N      Y=Yes, N=No

Data direction . . . . . 3      1=Sent, 2=Received, 3=Both

Number of bytes to trace:
  Beginning bytes . . . . . *CALC  Value, *CALC
  Ending bytes . . . . . *CALC  Value, *CALC

F3=Exit  F5=Refresh  F12=Cancel

```

- 4. Type in the name of the line that is associated with the IPX interface over which the problem occurs. These examples use TRNLIN as the line name.
- 5. Type a 6 in the *Buffer size* prompt. The display should look like this:

```

                                Start Trace
Type choices, press Enter.
Configuration object . . . . . TRNLINE
Type . . . . . 1          1=Line, 2=Network interface
                                3=Network server
Trace description . . . . . IPX trace
Buffer size . . . . . 6          1=128K, 2=256K, 3=2048K
                                4=4096K, 5=6144K, 6=8192K
Stop on buffer full . . . . . N          Y=Yes, N=No
Data direction . . . . . 3          1=Sent, 2=Received, 3=Both
Number of bytes to trace:
Beginning bytes . . . . . *CALC Value, *CALC
Ending bytes . . . . . *CALC Value, *CALC
F3=Exit  F5=Refresh  F12=Cancel

```

Figure 126. Start Trace Example

6. Press the Enter key. The following display appears:

```

                                Work with Communications Traces
Type options, press Enter.
2=Stop trace          4=Delete trace          6=Format and print trace
7=Display message    8=Restart trace
Configuration
Opt  Object          Type  Trace Description      Protocol  Trace Status
    TRNLINE         LINE  IPX TRACE              TRN      ACTIVE

```

Figure 127. Work with Communications Traces Display Example

7. Do one of the following:

Table 16. Trace Status

If the Trace Status Is	Go to Step
Waiting	1 on page 164
Error	1 on page 168
Other than waiting or error	11 on page 167

8. Press F3 (Exit) until you obtain the display that requests that you press Enter to continue ending SST.



The trace does not stop if you exit SST while the trace is running.

9. Press the Enter key to exit SST.

10. If you did step 1 on page 164 previously or the line is varied off, then enter the following command to vary on the line:

```
VRFCFG CFGOBJ(line-name) CFGTYPE(*LIN)
STATUS(*ON)
```

Ensure that the circuit that is associated with the line description is started. You can use the Start IPX Circuit (STRIPCCT) command to start a circuit.

11. Enter the commands and names of the programs that caused the problem. Trace the data on the line for a period of time that is specified by your service provider.
12. Go to "Stopping a Communications Trace" after the error occurs.

Stopping a Communications Trace

To stop the trace:

1. If you are at the Work with Communications Traces display, type a 2 in the Opt column next to the name of the line you want to stop tracing.



If the status is waiting, press F5 (Refresh) to refresh the status on the Work with Communications Traces display.

2. Press the Enter key. In this example, the trace status changed to stopping. The following display appears:

```
Work with Communications Traces

Type options, press Enter.
 2=Stop trace      4=Delete trace    6=Format and print trace
 7=Display message 8=Restart trace

Configuration
Opt  Object      Type  Trace Description  Protocol  Trace Status
   TRNLINE     LINE  IPX TRACE          TRN       STOPPING
```

3. Press F5 (Refresh) to refresh the display. In this example, the trace status changed to stopped. The following display appears:

```
Work with Communications Traces

Type options, press Enter.
 2=Stop trace      4=Delete trace    6=Format and print trace
 7=Display message 8=Restart trace

Configuration
Opt  Object      Type  Trace Description  Protocol  Trace Status
   TRNLINE     LINE  IPX TRACE          TRN       STOPPED
```

4. Continue with "Formatting and Saving the Communications Trace" on page 168 to format and save the trace.

Formatting and Saving the Communications Trace

1. Type a 6 in the Option column next to the name of the stopped line or line with a trace status of error that you want to format and print.
2. Press the Enter key.

If you want to format IPX data, specify Y in the Format IPX data only field.

The following display appears for a token-ring protocol:

```

                                Format Trace Data
Configuration object . . . . . : TRNLINE
Type . . . . . : LINE

Type choices, press Enter.

Controller . . . . . *ALL *ALL, name
Data representation . . . . . 3 1=ASCII, 2=EBCDIC, 3=*CALC

Format RR, RNR commands . . . . . N Y=Yes, N=No
Format Broadcast data . . . . . Y Y=Yes, N=No
Format MAC or SMT data only . . . . . N Y=Yes, N=No
Format UI data only . . . . . N Y=Yes, N=No
Format SNA data only . . . . . N Y=Yes, N=No
Format TCP/IP data only . . . . . N Y=Yes, N=No
Format IPX data only . . . . . Y Y=Yes, N=No

F3=Exit F5=Refresh F12=Cancel
```

Figure 128. Format Communications Trace Data Example



The format choices that are shown in this display are not available for every protocol.

3. Press F3 (Exit) until you exit the communications trace and the system service tools (SST).
4. Press the Enter key to exit SST.
5. Go to Verifying the Contents of the Communications Trace to display the trace.

Verifying the Contents of the Communications Trace

To verify the contents of the communications trace:

1. Enter the following command.
WRKOUTQ OUTQ(IBMLIB/IBMOUTQ)

A display like the following appears:

```

Work with Output Queue
Queue:  IBMOUTQ      Library:  IBMLIB      Status:  RLS
Type options, press Enter.
  1=Send  2=Change  3=Hold  4=Delete  5=Display  6=Release  7=Messages
  8=Attributes      9=Work with printing status
Opt  File      User      User Data  Sts  Pages  Copies  Form Type  Pty
   QPCSMPT  MCHANG

```

Figure 129. Work with Output Queue Display Example (1 of 2)

2. Press F11 (View 2) to view the date and time of the spooled file or files you want to work with. A display like the following appears:

```

Work with Output Queue
Queue:  IBMOUTQ      Library:  IBMLIB      Status:  RLS
Type options, press Enter.
  1=Send  2=Change  3=Hold  4=Delete  5=Display  6=Release  7=Messages
  8=Attributes      9=Work with printing status
Opt  File      File Nbr  Job      User      Number  Date      Time
   QIPXPRT      1  QPADEV0009  LINDA    006728  02/15/96  13:34:19

```

Figure 130. Work with Output Queue Display Example (2 of 2)

3. If 'More...' appears on the display and you need to continue searching for the spooled file, page forward or backward through the list of files; otherwise, continue with the next step.
4. Type a 5 (display) in the Opt column next to the spooled file named QIPXPRT that you want to display. QIPXPRT contains the communications trace.



The last file contains the communications trace if you just ran the trace.

5. Press the Enter key. A display like the following appears:

```

Display Spooled File
File . . . . . : QPCSMPT
Control . . . . . : _____
Find . . . . . : _____
*...+...1...+...2...+...3...+...4...+...5...+...6...+...7...+...
COMMUNICATIONS TRACE Title: IPX COMM TRACE 02/14/96
Trace Description . . . . . : IPX COMM TRACE
Configuration object . . . . . : IPXASSIST2
Type . . . . . : 1 1=Line, 2=Network Interface
3=Network server
Object protocol . . . . . : ETHERNET
Start date/Time . . . . . : 02/14/96 16:13:17
End date/Time . . . . . : 09/14/96 16:13:48
Bytes collected . . . . . : 1730
Buffer size . . . . . : 1 1=128K, 2=256K, 3=2048K
4=4096K, 5=6144K, 6=8192K
Data direction . . . . . : 3 1=Sent, 2=Received, 3=Both
Stop on buffer full . . . . . : N Y=Yes, N=No
Number of bytes to trace
Beginning bytes . . . . . : *CALC Value, *CALC
Ending bytes . . . . . : *CALC Value, *CALC
More...
F3=Exit F12=Cancel F19=Left F20=Right F24=More keys

```

Figure 131. Display Spooled File Display Example (1 of 3)

- Verify that this is a communications trace for the line that is traced and that the time the trace started and ended are correct.

The trace that is collected by the service tool is automatically deleted if you perform an IPL; however, the spooled file is still saved.

If you page down to the start of the actual IPX data in the communications trace, you will see displays similar to the following:

```

Display Spooled File
File . . . . . : QPCSMPT
Control . . . . . : _____
Find . . . . . : _____
*...+...1...+...2...+...3...+...4...+...5...+...6...+...7...+...
Controller name . . . . . : *ALL *ALL, name
Data representation . . . . . : 3 1=ASCII, 2=EBCDIC, 3=*CALC
Format SNA data only . . . . . : N Y=Yes, N=No
Format RR, RNR commands . . . . . : N Y=Yes, N=No
Format TCP/IP data only . . . . . : N Y=Yes, N=No
Format UI data only . . . . . : N Y=Yes, N=No
Select Ethernet data . . . . . : 3 1=802.3, 2=ETHV2, 3=Both
Format Broadcast data . . . . . : Y Y=Yes, N=No
COMMUNICATIONS TRACE Title: IPX COMM TRACE 02/14/96
Record Number . . . . . : Number of record in trace buffer (decimal)
S/R . . . . . : S=Sent R=Received M=Modem Change
Data Length . . . . . : Amount of data in record (decimal)
Record Status . . . . . : Status of record
Record Timer . . . . . : Time stamp (Seconds, 100 millisecond resolution,
decimal). Range is 0 to 6553.5 seconds
Data Type . . . . . : EBCDIC data, ASCII data or Blank=Unknown
More...
F3=Exit F12=Cancel F19=Left F20=Right F24=More keys

```

Figure 132. Display Spooled File Display Example (2 of 3)

```

                                Display Spooled File
File . . . . . : QPCSMPT                      Page/Line 3/1
Control . . . . . :                               Columns 1 - 78
Find . . . . . :
*...+...1...+...2...+...3...+...4...+...5...+...6...+...7...+...
COMMUNICATIONS TRACE      Title: IPX COMM TRACE      02/14/96
Record   Data   Record   Data   Controller   Destination   Source
Number  S/R   Length  Timer   Type        Name          MAC Address   MAC Address
-----  -
1   S       3   5702.9                08005A1AA0CF  08005AB7713
   Data . . . : 00000000000000007590340075909C000000000000
                0000000000000759034007590B8
2   S      45   5711.3                FFFFFFFF     08005AB7713
   Data . . . : 0000008137FFF002800010000000FFFFFFFF
                B7713104530001FFFFFFFF00FF00FF
3   R      69   5711.3                08005AB77131 10005A14E90
   Data . . . : 0000008137FFF00400001EE00000108005AB77131
                14E903045300025500000100010002EE0000020001
                022EF2FE0E00010002
4   S      39   5713.3                FFFFFFFF     08005AB7713
   Data . . . : 0000008137FFF002200040000000FFFFFFFF
                More...

F3=Exit  F12=Cancel  F19=Left  F20=Right  F24=More keys

```

Figure 133. Display Spooled File Display Example (3 of 3)

This information should help you debug the problems that you are having with IPX on this AS/400 or in the network that this AS/400 is part of.

Return Codes and Messages Issued by IPX Support

Certain circuit type messages that is issued by the IPX support contain the following information in the technical description. You may see the following message text:

The return code and associated data from IPX is 61530/40264040.

1 **2**

Table 17 identifies the (**1**) return codes and the (**2**) associated data descriptions.

Message recovery should be followed. In addition, use the information in Table 17 to help you determine the problem. The information that is listed in the Technical Description of the message is used for problem determination.

Table 17 (Page 1 of 3). Return Codes and Associated Data Description

Return Code	Associated Data Description
0	This is the internal representation for success by the IPX support. Its presence on a failure message provides no additional information.
10	The requested operation has already been done.
20	The requested operation is not supported with the circuit in its current state.
30	One or more communication object descriptions were deleted during the execution of an IPX circuit operation (for example, a device description).

Table 17 (Page 2 of 3). Return Codes and Associated Data Description

Return Code	Associated Data Description
40	The value specified in the IPX network number (IPXNETNBR) parameter of the circuit is different than the value currently in use by other systems on the network. The associated data contains the network number being used by other systems.
50	The line description resources required by the circuit are currently unavailable. The resource required by a circuit is determined by the Frame type (FRAMETYPE) circuit parameter for LAN line descriptions, the X.25 PVC logical channel ID (PVCLGLCHLI) parameter for X.25 line descriptions, or unavailable logical channels in the associated line.
60	The circuit was ended by the user or by IPX support. This usually is due to the exhaustion of error recovery during the InterWorking exchange (IW2) processing of circuit startup. This is not a circuit error.
70	IPX support received an IW2 packet on a circuit which is currently active. This indicates that the adjacent system restarted IPX communication on the circuit. Typically, the AS/400 system will attempt to reestablish communication with the adjacent system.
80	The adjacent system is using the same IPX internal network number as the local system (for example, IPXNETNBR parameter in the IPX description specified on the STRIPX command). The associated data contains the network number.
90	The routing capabilities offered by the adjacent system during the IW2 exchange are incompatible with those configured for this circuit. The parameters affecting routing capabilities are the IPX routing protocol (IPXRTGPCL) parameter and IPX packet forward (IPXPKTFWD) parameter in the IPX description specified on the STRIPX command, and the Enable for NLSP (ENBNLSP) and RIP state (RIPSTATE) parameters in the circuit. The default values for these parameters are the least restrictive, and should prevent this type of failure. However, a common example of failure would be to not offer RIP (RIPSTATE(*OFF)) when the adjacent system requires it.
100	IW2 exchange did not complete. Circuit not activated. The adjacent system did not behave as required during the IW2 protocol exchange.
110	IW2 exchange did not complete. Circuit not activated. A negative acknowledgement was received by the adjacent system during the IW2 exchange. This is typically received from an adjacent system that encountered a protocol error during the IW2 exchange.
120	IW2 exchange did not complete. Circuit not activated. An IW2 Timer Response packet was not received from the adjacent system. For WAN type circuits over X.25 PVC or frame relay, the adjacent system is not yet ready for communications.
130	IW2 exchange did not complete. Circuit not activated. After the IW2 exchange was started, a Throughput Response was not received from the adjacent system.
140	IW2 exchange did not complete. Circuit not activated. After the IW2 exchange was started, a Delay Response was not received from the adjacent system.
150	IW2 exchange did not complete. Circuit not activated. After the IW2 exchange was started, an Information Response was not received from the adjacent system.

Table 17 (Page 3 of 3). Return Codes and Associated Data Description

Return Code	Associated Data Description
160	IW2 exchange did not complete. Circuit not activated. After the IW2 exchange was started, negotiation was not completed within the required time.
200	The circuit was ended due to a communication media failure.
210	The circuit was ended due to the receipt or generation of an X.25 CLEAR or RESET packet. The first two digits of the associated data contain the corresponding cause code, followed immediately by a two digit diagnostic code. It is common to get this type of error on switched X.25 circuits due to an incorrect configuration of the X.25 SVC network address (SVCNETADR) parameter, or because the adjacent system is not ready to accept the call. Typically, the system will attempt to re-enable the circuit for future communication.
220	The circuit was terminated due to an idle timeout. The idle timeout value is set by the X.25 SVC idle circuit timeout (IDLVCTTIMO) parameter. Typically, the system will attempt to re-enable the circuit for future communication.
61450	An exception condition was encountered by the IPX support. The associated data is used for problem determination.
61460	The activation of the network device associated with the Line description (LIND) parameter failed. This may be due to an object being deleted or damaged prior to circuit start. The associated data is used for problem determination.
61470	A failure was encountered while attempting to communicate with the I/O processor associated with the Line description (LIND) parameter. The associated data is used for problem determination.
61480	A failure was encountered while attempting to communicate with the I/O processor associated with the Line description (LIND) parameter. The associated data is used for problem determination.
61490	The activation of IPX assistance function in the I/O processor associated with the circuit failed. This may be due to lack of storage in the I/O processor. The associated data is used for problem determination.
61500	A timeout was encountered while attempting to activate a circuit. An associated data value of 00000002 on an X.25 switched virtual circuit may indicate an outbound call timeout. The X.25 line description configuration should be verified with the network subscription. The associated data is used for problem determination.
61510	A failure occurred on the circuit. The associated data is used for problem determination.
61520	A STREAM I/O failure was encountered. The associated data is used for problem determination.
61530	A failure was encountered by a communication object associated with the circuit. This return code is commonly produced as a result of a communication media failure.
61540	A failure was encountered by the IPX assistance function in the communication I/O processor associated with the circuit. The associated data is used for problem determination.

Alertable Messages

Table 18 (Page 1 of 3). Alertable Messages

Message	Message Description
CPFE007	<p>Error occurred processing command.</p> <p>A system error occurred. This is not a normal condition. Check the job log for other error messages that may have been issued prior to this error message. Report the problem using the ANZPRB command.</p>
CPFE00B	<p>IPX circuit not started.</p> <p>The IPX circuit was not started because of one of the following reasons:</p> <ul style="list-style-type: none"> • The Start IPX Circuit (STRIPCCT) command processing program was unable to communicate with the QIPX job. • The automatic configuration of the controller and *IPX type network device failed. • A timeout occurred while attempting to get a lock on the *IPX type network device. • An error occurred while attempting to get a lock on the *IPX type network device. • IPX is not responding.
CPFE00C	<p>Library QUSRSYS not found.</p> <p>The QIPX job requires the library QUSRSYS. Restore the QUSRSYS library, and then try the request again.</p>
CPFE00F	<p>An error occurred on an IPX circuit.</p> <p>An error occurred while attempting to end an IPX circuit.</p>
CPFE011	<p>IPX circuit not found.</p> <p>Determine which IPX circuits exist using the WRKIPCCT command. Ensure the circuit name is correct and then try the request again.</p> <p>Note: Blanks are allowed in the circuit name.</p>
CPFE023	<p>SSAP hexadecimal value E0 cannot be configured on line description.</p> <p>Change the line description to remove SSAP hexadecimal E0, and try the request again.</p>
CPFE033	<p>IP over IPX not activated.</p> <p>Errors occurred while activating IP over IPX support that prevented it from being activated. Activating IP over IPX support was attempted.</p>
CPFE034	<p>IP over IPX activated; however errors occurred.</p> <p>Errors occurred when starting IP over IPX interfaces while activating IP over IPX support. The IP over IPX support was activated.</p>
CPFE035	<p>IP over IPX deactivated; however errors occurred.</p> <p>Diagnostic messages were sent to the QJUS job log detailing the errors that occurred.</p>
CPFE03B	<p>Command received by QIPX job is not valid.</p> <p>The command is not valid for the QIPX job. Try the request again. If the problem continues, use the ENDIPX command to end the QIPX job, followed by the STRIPCCT command. Then try the request again. If the problem continues, report the problem using the ANZPRB command.</p>

Table 18 (Page 2 of 3). Alertable Messages

Message	Message Description
CPFE03C	DFTMAXDTG value not valid. The Default Maximum Datagram size (DFTMAXDTG) parameter value for the IPX circuit is greater than the maximum frame size on the line description.
CPFE03D	DFTPKTSIZE value not valid. The transmit or receive parameter value of the default packet size is greater than the maximum packet size parameter value on the line description.
CPFE03E	DFTWDWSIZE value not valid. The transmit or receive parameter value of the default window size is greater than the default window size parameter value on the line description.
CPFE03F	SVCNETADR value not valid. The Switched Virtual Circuit Network Address (SVCNETADR) parameter value for the IPX circuit cannot be more than 15 digits if the extended network addressing (EXNNETADR) parameter value for the line description is *NO. Up to 17 digits can be specified if extended network addressing is *YES.
CPFE040	Cannot start the IPX circuit. The IPX circuit has the same network number as the active IPX description.
CPFE041	IPXNETNBR does not match attached IPX network number. The IPX Network Number (IPXNETNBR) parameter value for the IPX circuit does not match the attached IPX network number.
CPFE04C	SVC not valid for the IPX circuit. An IPX circuit was specified as an SVC circuit. The SVC specified on the line description does not allow outgoing calls. This type of SVC is not valid for IPX circuits.
CPFE04D	THROUGHPUT value *CALC not valid. A throughput (THROUGHPUT) parameter value of *CALC was specified and the line description has a resource name value of *NWID. A network interface description (NWID) was not found so the THROUGHPUT parameter value could not be calculated.
CPFE04F	QIPX job did not start. The QIPX job was unable to access system objects that are required for the QIPX job. The QIPX job did not start.
CPFE056	Remote system not responding on IPX circuit. The local system attempted to establish contact with the remote system using the IPX circuit. However, the local system received no response within the required time limit.
CPFE057	Unable to establish circuit with remote system. The local system attempted to negotiate communication capabilities with the remote system using the circuit. However, the communication capabilities between the two systems are not compatible, and the circuit was ended.

Table 18 (Page 3 of 3). Alertable Messages

Message	Message Description
CPFE058	Error occurred on IPX circuit. An error occurred on the IPX circuit established on the line description, when the X.25 virtual circuit was reset or cleared.
CPFE059	An error occurred on IPX circuit. An error occurred while attempting to start an IPX circuit.
CPFE060	IPX internal circuit not ended. An attempt was made to end the IPX internal circuit, but the QIPX job did not respond.
CPFE061	An error occurred while attempting to end IPX internal circuit. Issue the End IPX (ENDIPX) command and then the Start IPX (STRIPX) command. If the problem continues, use the Analyze Problem (ANZPRB) command to report the problem.
CPFE062	An error occurred while attempting to start IPX internal circuit. Issue the End IPX (ENDIPX) command and then the Start IPX (STRIPX) command. If the problem continues, use the Analyze Problem (ANZPRB) command to report the problem.
CPFE063	Line description and resource type do not support IPX. The following is a list of line types and resource types that can be used in support of IPX. <ul style="list-style-type: none">• Ethernet: 2617, 2723, 6181• Token Ring: 2619, 2724, 6149• Frame Relay: 2666• FSIOP: Any resource type that supports FSIOP will support IPX• X.25: Any resource type that supports X.25 will support IPX
CPFE064	IPX internal network number not unique. The IPX internal network number value in the IPX description is the same as the IPX internal network number being used by the remote system attached to the IPX circuit.
CPFE065	The IPX circuit was reset by the remote system. An indication was received from the remote system that resulted in the IPX circuit being reset.

Appendix F. NetWare for SAA Product Offering

What is NetWare for SAA?	177
NetWare for SAA and Client Access/400	178
AS/400 Application Support	179

This appendix introduces the NetWare for SAA product and relates it to the AS/400.

What is NetWare for SAA?

The NetWare for SAA product from Novell is a set of NetWare Loadable Modules (NLMs) that integrates NetWare networks with AS/400 and mainframe environments. It can support as many as 508 concurrent host sessions to multiple hosts over Ethernet, token-ring, SDLC, QLLC/X.25, and channel attachment data links.

NetWare for SAA is more than a gateway. A wide range of applications built on NetWare for SAA enable transparent integration of the AS/400 environment and NetWare networks. These LAN-to-host products provide such services as software distribution and host database access. They also include electronic mail gateways, print services applications, LAN-over-SNA protocol routers, financial applications, and others.

Novell offers two such products: **NetWare HostPrint** and **NetWare SNA Links**. The NetWare HostPrint NLM** runs on a NetWare for SAA server and enables you to send host print jobs directly to LAN printers. NetWare SNA Links is an NLM that works with NetWare for SAA to route IPX/SPX protocols over an existing SNA backbone network.

NetWare for SAA offers both host-based and network-based network management solutions. It supports IBM's NetView management by enabling NetView management system, by enabling NetView monitoring capabilities, and by providing a command interface that enables the host operator to control NetWare servers directly from the host. For network-based management, NetWare for SAA includes a comprehensive set of network management and administrative tools. NetWare for SAA Service Manager application provides extensive network management capabilities for monitoring, controlling, and maintaining multiple NetWare for SAA servers from NetWare Management System (NMS) console.

See Figure 134 on page 178 for an example of integrating NetWare for SAA with AS/400.

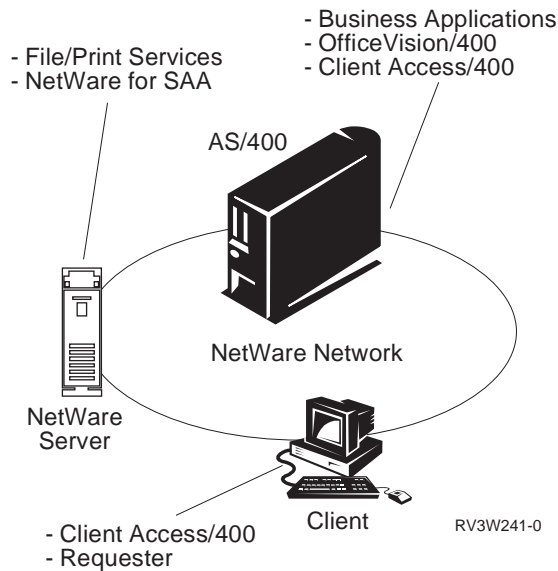

Figure 134. Integrating NetWare for SAA with the AS/400 Example

NetWare for SAA and Client Access/400

NetWare for SAA extends the Client Access/400 program by providing an interface for DOS and Windows workstations. It transmits Client Access/400 calls over IPX support to the NetWare for SAA server. NetWare for SAA then handles all SNA communications with the AS/400. The AS/400 interface included in NetWare for SAA includes the following:

- Single transport protocol. Because NetWare for SAA enables Client Access/400 to communicate over IPX/SPX, the NetWare shell can run alongside Client Access/400 functions.
- Reduced workstation memory. NetWare for SAA uses about 5KB of RAM at the workstation for its AS/400 interface. The AS/400 interface can use as much as 60 KB. Network Driver Interface Specification (NDIS) drivers used in Ethernet environments require even more memory.
- Support for a variety of topologies and adapters. NetWare for SAA supports token-ring, ARCNET, and Ethernet topologies over all adapters that are tested by Novell.
- Compatibility with existing routers. NetWare for SAA ensures compatibility with all routers, so Client Access/400 users can access AS/400 applications without needing additional source routing bridges.
- Switched connectivity for remote workstations. NetWare for SAA, in conjunction with NetWare Access Services v1.3, allows remote dial-in access to both NetWare resources and the AS/400 over the same asynchronous link.
- Remote connectivity for workgroups. NetWare for SAA allows a single SDLC or QLLC/X.25 connection to be shared among users on a NetWare network for connection to a remote AS/400 without needing communications adapters or the 5494 Remote Controller.

- Macintosh access to AS/400 applications. NetWare Access Services v1.3, provides a means for Macintosh users to run any Client Access/400 application (except shared folders).

For additional information on NetWare for SAA, see the online information provided with the product or call IBM at 1-800-IBM-3040.

AS/400 Application Support

NetWare for SAA is completely compatible with Client Access/400 applications and APIs. It also supports products for DOS with Extended Memory client and for Windows 3.1, including:

- Workstation function (for Windows 3.1)
- Elite/400** (for Windows 3.1)

Supported Client Access/400 functions include:

- Shared folders (DOS with Extended Memory client, for Windows 3.1, and Optimized for OS/2)
- Virtual print (DOS with Extended Memory client, for Windows 3.1, and Optimized for OS/2)
- File transfer (DOS with Extended Memory client, for Windows 3.1, and Optimized for OS/2)
- Organizer (DOS with Extended Memory client, for Windows 3.1, and Optimized for OS/2)
- PC5250 (DOS with Extended Memory client, for Windows 3.1, and Optimized for OS/2)
- Remote commands (DOS with Extended Memory client, for Windows 3.1, and Optimized for OS/2)
- RUMBA/400** (for Windows 3.1)

Original Equipment Manufacturer (OEM) products that allow network applications to access AS/400 databases include:

- SQL Router to AS/400**
- ShowCase**
- PROGRESS/400**

For additional information on OEM products, refer to the *NetWare for SAA Solutions Guide*.

Notices

References in this publication to IBM products, programs, or services do not imply that IBM intends to make these available in all countries in which IBM operates. Any reference to an IBM product, program, or service is not intended to state or imply that only that IBM product, program, or service may be used. Subject to IBM's valid intellectual property or other legally protectable rights, any functionally equivalent product, program, or service may be used instead of the IBM product, program, or service. The evaluation and verification of operation in conjunction with other products, except those expressly designated by IBM, are the responsibility of the user.

IBM may have patents or pending patent applications covering subject matter in this document. The furnishing of this document does not give you any license to these patents. You can send license inquiries, in writing, to:

IBM Director of Licensing
IBM Corporation
500 Columbus Avenue
Thornwood, NY 10594
U.S.A.

Licenseses of this program who wish to have information about it for the purpose of enabling: (i) the exchange of information between independently created programs and other programs (including this one) and (ii) the mutual use of the information which has been exchanged, should contact the software interoperability coordinator. Such information may be available, subject to appropriate terms and conditions, including in some cases, payment of a fee. Address your questions to:

IBM Corporation
Software Interoperability Coordinator
3605 Highway 52 N
Rochester, MN 55901-7829
U.S.A.

This publication could contain technical inaccuracies or typographical errors.

This publication may refer to products that are not currently available. IBM makes no commitment to make available any unannounced products referred to herein.

The final decision to announce any product is based on IBM's business and technical judgment.

This publication is for planning purposes only. The information herein is subject to change before the products described become available.

Trademarks

The following terms are trademarks of the IBM Corporation in the United States or other countries or both:

Advanced Peer-to-Peer Networking
AnyNet
AnyNet/400
Application System/400
APPN
AS/400
C/400
Client Access
Discover/Education
IBM
Information Assistant
Integrated Language Environment
NetView
Operating System/400
OS/2
OS/400
SAA
System 36
System 38
System Application Architecture
400

Microsoft, Windows, and the Windows 95 logo are trademarks or registered trademarks of Microsoft Corporation.

UNIX is a registered trademark in the United States and other countries licensed exclusively through X/Open Company Limited

Other company, product, and service names, which may be denoted by a double asterisk (**), may be trademarks or service marks of others.

Bibliography

The publications that are listed in this bibliography provide additional information about topics that are described or referred to in this book. The following publications are listed with their full title, short title, and order number. When these books are referred to in text, a shortened version of the title is used.

AS/400 Communications Books

- *APPN Support*, SC41-5407. Provides information about the concepts of AS/400 Advanced Peer-to-Peer Networking (APPN) and about planning APPN networks.
- *APPC Programming*, SC41-5443. Describes the advanced program-to-program communications (APPC) support for the AS/400 system and provides the information necessary for developing communications application programs.
- *Communications Configuration*, SC41-5401. Describes the objects, commands, and parameters that are used to configure OS/400 communications. It includes a general discussion of the objects and methods used to configure communications and detailed descriptions of all parameters that can be specified for the commands used to create the configuration objects.
- *Communications Management*, SC41-5406. Contains information on working with communications status, errors, performance, line speed, and storage requirements.
- *Integration Services for the Integrated PC Server*, SC41-5123. Describes how to configure, install, and use the Integration Services for the Integrated PC Server.
- *LAN and Frame Relay Support*, SC41-5404. Describes the AS/400 support for IBM token-ring, distributed data interface (DDI), Ethernet, and wireless local area networks and frame relay wide area networks. This manual also includes information about AS/400 functions that are used for problem determination and management of local area networks.
- *Integrating AS/400 with Novell NetWare*, SC41-5124. Describes how to install and set up the NetWare 4.0 product from Novell, Inc., as well as the Enhanced NetWare product.
- *DSNX Support*, SC41-5409. Provides information for configuring an AS/400 system to use the change management support (distributed systems node executive), problem management support (alerts), and the Simple Network Management Protocol (SNMP) agent.

- *Sockets Programming*, SC41-5422. Provides information about for the system programmer for using the sockets programming interface for the AS/400 system.
- *X.25 Network Support*, SC41-5405. Provides information on how to use the AS/400 X.25 support. Descriptions of various connection methods, diagnostic information, and configuration examples are included.

Programming Books

- *Application Display Programming*, SC41-5715. Contains information about managing files, and creating job queues and output queues.
- *CL Programming*, SC41-5721. Provides the application programmer or programmer with a wide-ranging discussion of AS/400 programming topics, such as a general discussion of objects and libraries, control language (CL) programming, messages and message handling, user-defined commands and menus, and application testing.
- *CL Reference*, SC41-5722. Provides the application programmer or system programmer with a description of the AS/400 control language (CL) and its commands. Command descriptions include a syntax diagram, parameters, default values and keywords.
- *System API Reference*, SC41-5801. Provides information for the experienced programmer on how to use the application programming interfaces (APIs) to such OS/400 functions as:
 - Dynamic Screen Manager
 - Files (database, spooled, hierarchical)
 - Message handling
 - National language support
 - Network management
 - Objects
 - Problem management
 - Registration facility
 - Security
 - Software products
 - Source debug
 - UNIX-type
 - User-defined communications
 - User interface

- Work management

System Books

- *Local Device Configuration*, SC41-5121. Provides the system operator or system administrator with information on how to do an initial hardware configuration and how to change that configuration. Also included is a description of the different keyboard language types.
- *International Application Development*, SC41-5603. Provides information that is required to understand and use the national language support function on the AS/400 system. This manual prepares the AS/400 user for planning and using the national language support (NLS) and the multilingual support of the AS/400 system.
- *Work Management*, SC41-5306. Provides programmers with information about how to effectively manage their system workload by changing work management objects to meet their needs. The publication provides guidelines for performance tuning; descriptions of system values; and information on collecting performance data, gathering system use data, using work entries, and scheduling batch jobs.

Architecture Books

The following book provides a technical overview of MPTN architecture.

- *Multiprotocol Transport Networking (MPTN) Architecture: Technical Overview*, GC31-7073.

NetWare** Books

The following books are available with the NetWare 4.10 Network Operating System from Novell.

- *Getting Started with NetWare 4.0*, PN 100-001561-001
- *NetWare for Macintosh Installation and Maintenance*, PN 100-001795-001
- *NetWare for Macintosh Print Services*, PN 100-001797-001
- *NetWare 4.0 Basics and Installation*, PN 100-001562-001
- *NetWare 4.0 Concepts*, PN 100-001417-001
- *NetWare 4.0 Installation and Upgrade*, PN 100-001414-001
- *NetWare 4.0 Installation and Operation*, PN 100-001305-001
- *NetWare 4.0 Master Index*, PN 100-001421-001

- *NetWare 4.0 Printer Services*, PN 100-001419-001
- *NetWare 4.0 Supervising the Network*, PN 100-001415-001
- *NetWare 4.0 System Messages I*, PN 100-001563-001
- *NetWare 4.0 System Messages II*, PN 100-001564-001
- *NetWare 4.0 TCP/IP Transport Supervisor's Guide*, PN 100-000945-002
- *NetWare 4.0 Utilities Reference*, PN 100-001416-001
- *NetWare 4.0 Workstation for DOS and Windows*, PN 100-001623-001
- *Using NetWare for Macintosh Client*, PN 100-001796-001

The following books are available with the Novell Multi-protocol Router 3.0 from Novell.

- *NetWare MultiProtocol Router (TM) 3.0 Installation and Basic Configuration Guide*, PN 100-002094-001
- *NetWare MultiProtocol Router (TM) 3.0 Advanced Configuration and Management Guide*, PN 100-002091-001
- *WAN Extensions 3.0 Installation and Configuration Guide* PN 100-002138-001
- *NetWare MultiProtocol Router (TM) 3.0 NLSP (TM) Migration Guide*, PN 100-002088-001

Other Novell documents:

- *The Novell Network Registry*, PN 461-000248-001
- *NetWare Link Services Protocol In-Depth* PN 481-000085-001
- *Novell NetWare Link Services Protocol (NLSP) Specification*, PN 100-001708-002
- *IPX Router Specification*, PN 107-000029-001
- *NetWare for SAA Solutions Guide*

Other Printed Information

The following non-IBM books provide detailed information about various communications standards.

- *American National Standards Institute/Institute of Electrical and Electronics Engineers 802.2, 1985 - Logical Link Control, International Organization for Standardization/Draft International Standard 8802/2*
- *American National Standards Institute/Institute of Electrical and Electronics Engineers 802.3, 1985 - Carrier Sense Multiple Access with Collision Detection, International Organization for Standardization/Draft International Standard 8802/3*

- *American National Standards Institute/Institute of Electrical and Electronics Engineers 802.3a, b, d, c, 1988 -Supplements to Carrier Sense Multiple Access with Collision Detection American National Standards Institute/Institute of Electrical and Electronics Engineers Standard 802.3, 1985.*
- *American National Standards Institute/Institute of Electrical and Electronics Engineers 802.5,1985 - Token Passing Ring, International Organization for Standardization/Draft International Standard 8802/5*
- *The International Telegraph and Telephone Consultative Committee, Red Book, Volume VIII - Facscicle VIII.3, Data Communications Networks Interfaces, Recommendations X.20 - X.32, VIIIth Plenary Assembly, Malaga-Torremolinos, October 8-19, 1984.*

Index

Special Characters

- *IOSYSCFG authority
 - configuration
 - commands 145
- *SYSGEN default value 33

Numerics

- 2850 Integrated PC Server 30
- 2850 Integrateed PC server 16
- 6506 Integrated PC server 16, 30
- 6616 Integrated PC server 16, 30

A

- accessing
 - SST 163
- activating
 - APPC over IPX Support 134
 - IP over IPX Support 121
- active IPX description
 - displaying 86
- add circuit route
 - command prompt example 59, 101
 - example 103
 - for IPX network number 00000004 60
 - for IPX network number 00000005 60
 - for IPX network number 00000006 60
- Add Circuit Route (ADDCCTRTE) command 57, 100
- add circuit service
 - command prompt example 63
- Add Circuit Service (ADDCCTSRV) command 61
- Add IP over IPX
 - address command prompt 118
 - Interface (ADDIPIFC) 114
 - interface command prompt example 114, 115
- add IPX circuit command prompt example 37
- Add SNA over IPX Location (ADDSNILOC) command 131
 - command prompt example 132, 133
- add X.25 IPX circuit command prompt example 98
- ADDCCTRTE (Add Circuit Route) command 100
- ADDCCTSRV (Add Circuit Service) command 61
- adding a circuit service to the network example 62
- adding an IPX circuit
 - for X.25 SVC line 52
 - hint 35
- adding an X.25 SVC line description 98
- adding APPC over IPX location name addressing configuration 131
- adding circuit route information for system D 100

- adding circuit service
 - hint 62
 - information 61
- adding IP over IPX route (ADDIPIRTE) command 117
- adding IP over IPX routes configuration
 - adding IP over IPX route (ADDIPIRTE) command 117
- adding route entries 100
 - adding route informations 104
 - considerations 104
 - IPX considerations for routing 104
- adding route information 45
- adding service information 45
- adding static routes
 - adding static route information 57
 - hint 58
- adding the remote locations to the APPN remote location lists 127
- adding X.25 circuit
 - for X.25 SVC line 98
- additional IPX configuration options 65
- address
 - node 11
 - physical hardware 11
- advanced configuration
 - IPX support 89
- AF_INET sockets over IPX 8
- alertable messages 174
- allow AnyNet support (ALWANYNET) network attribute 134
- allow AnyNet/400 support for IP over IPX Support 120
- ALWANYNET (allow AnyNet support network attribute) 134
- AnyNet/400 and IPX support
 - IP over IPX addresses configuration
 - adding 117
 - IP over IPX interface configuration 114
 - overview 112
- AnyNet/400 over IPX
 - IP over IPX routes configuration 117
- AnyNet/400 support 109
 - changing the IP over IPX configuration 121
 - configure IPX menu 111
- AnyNet/400 support for IP 120
- APPC configuration 124
 - adding the remote locations to the APPN remote location lists 127
 - creating the APPC Device and Mode Descriptions 126
- APPC controller description
 - hint 125

- APPC Controller display example 126
- APPC mode description 126
- APPC over IPX
 - activating 134
 - common configuration errors 135
 - configuration 123
 - allow AnyNet support network attribute 134
 - APPC controllers 124
 - APPC mode description 126
 - APPN remote location list 127
 - controller description parameter 125
 - link type parameter 125
 - local locations lists 129
 - location name addressing 131
 - online parameter 125
 - remote control point name parameter 125
 - remote location name parameter 132
 - remote network identifier parameter 125, 132
 - remote network number parameter 132
 - remote node address parameter 133
 - configuration example 124
 - IPX configuration 124
 - configuration overview 123
 - CPI-Communications applications 8
 - definition 8
 - intersystem communications function (ICF) applications 8
 - support
 - allow AnyNet support network attribute 134
- APPC over IPX support
 - matching configuration parameters 135
- APPN remote location list 127
 - display example 128, 129, 130
- architecture books 184
- associated routes and services
 - working with 74
- authority
 - for users
 - QPGMR authority 145
 - QSECOFR authority 145
 - QSRV authority 145
 - QSRVBAS authority 145
 - QSYSOPR authority 145
- automatic start
 - definition 54
 - parameter 42
 - circuit configuration 54
 - Sample IPX circuit 54

B

- books
 - architecture 184
 - communications 183
 - NetWare 184
 - programming 183

- books (*continued*)
 - system 184
- broadcast
 - definition 40
- bus topology 1

C

- CFGAPI (Configure API) command 121
- Change Line Description (Ethernet) (CHGLINETH)
 - command 51
- Change Line Description (Token-Ring) (CHGLINTRN)
 - command 51
- Change Line Description (X25) (CHGLINX25)
 - command 51, 98
- Change Network Attribute (CHGNNETA)
 - command 134
- channel entries 48
- Check Communications Trace (CHKCMNTRC)
 - command 161
- checking
 - communications trace 161
- CHKCMNTRC (Check Communications Trace)
 - command 161
- circuit
 - Internetwork Packet Exchange (IPX)
 - definition 12
 - IPX (Internetwork Packet Exchange)
 - definition 12
 - Start IPX Circuits (STRIPXCCT) command 76
- circuit name
 - parameter 38
 - circuit route 59, 102
 - circuit service 63
 - IPX circuit 53
- circuit name parameter 99
- circuit route
 - adding 57
 - definition 57, 61
 - example 57
 - overview 56
 - sample 60
- circuit service
 - adding 61
 - definition 61
 - overview 56
 - sample 65
- circuit service to the network example
 - adding 62
- circuits
 - End IPX Circuits (ENDIPXCCT) command 77
- CL commands
 - APPC over IPX
 - example 133
 - IP over IPX configuration
 - example 120

CL program for configuration example 137

client

- definition 1

collecting

- communications trace 161

combining values for routing

- considerations 106

command prompt

- create line description (Ethernet) 30
- Create Line Description (X25) 46

commands

- Add Circuit Route (ADDCCTRTE) 57, 100
- Add Circuit Service (ADDCCTSRV) 61
- add IP over IPX address (ADDIPIADR) 117
- Add IP over IPX Interface (ADDIPIIFC) 114
- Add SNA over IPX Location (ADDSNILOC) 131
- ADDCCTRTE (Add Circuit Route) 100
- ADDCCTSRV (Add Circuit Service) 61
- CFGAPI (Configure IPI) 121
- Change Line Description (Ethernet) (CHGLINETH) 51
- Change Line Description (Token-Ring) (CHGLINTRN) 51
- Change Line Description (X25) (CHGLINX25) 51, 98
- Change Network Attribute (CHGNNETA) 134
- Check Communications Trace (CHKCMNTRC) 161
- CHKCMNTRC (Check Communications Trace) 161

configuration

- special authorities 145

Configure IPI (CFGAPI) command 121

Create Controller Description (CRTCTLAPPC) 124

Create Line Description (Ethernet) (CRTLINETH)) 30

Create Line Description (Ethernet) (CRTLINETH) 51

Create Line Description (Token-Ring) (CRTLINTRN) 51

Create Line Description (X.25) (CRTLINX25) 95

Create Line Description (X25) (CHGLINX25) 51, 98

Create Line Description (X25) (CRTLINX25) 46

CRTCTLAPPC (Create Controller Description) 124

CRTLINETH 51

CRTLINTRN 51

CRTLINX25 46, 51, 98

Delete Communications Trace (DLTCMNTRC) 161

Display Line Description (DSPLIND) 51, 98

Display Physical File Member (DSPPFM) 140

DLTCMNTRC (Delete Communications Trace) 161

DLTLIND 51, 98

DSPLIND 51

DSPPFM (Display Physical File Member) 140

End Communications Trace (ENDCMNTRC) 161

ENDCMNTRC (End Communications Trace) 161

IPXPING (Verify IPX Connection) 160

Print Communications Trace (PRTCMNTRC) 161

commands (*continued*)

- PRTCMNTRC (Print Communications Trace) 161
- Start Communications Trace (STRCMNTRC) 161
- STRCMNTRC (Start Communications Trace) 161
- Verify IPX Connection (IPXPING) 160
- Verify IPX Connection (VFYIPXCNN) 160
- VFYIPXCNN (Verify IPX Connection) 160
- Work with IPX Status (WRKIPXSTS) 162
- Work with Members Using PDM (WRKMBRPDM) 140
- WRKIPXSTS (Work with IPX Status) 162
- WRKMBRPDM (Work with Members Using PDM) 140

common configuration

- APPC over IPX 135
- errors 123
- problem analysis 154

communications books 183

communications trace

- checking 161
- collecting 161
- deleting 161
- display 164
- ending 161
- example 165
- formatting 168
- printing 161
- saving 168
- starting 161, 164
- stopping 167
- verifying contents 168

component traces 156

configuration

- AnyNet/400
 - APPC over IPX 123
- APPC over IPX 123
- circuit 35
 - X.25 52, 98
- debugging
 - IPXPING (Verify IPX Connection) 160
 - Verify IPX Connection (VFYIPXCNN) command 160
- Ethernet network example 23
- Integrated PC Server example 90
- Internetwork Packet Exchange (IPX)
 - NetWare Support 89
- line 30
 - X.25 46
- line descriptions
 - Ethernet 30
 - X.25 95
- matching parameters
 - APPC over IPX support 135
 - IP over IPX support 122
- multi-protocol
 - APPC over IPX 123

- configuration (*continued*)
 - restoring configuration files 139
 - saving configuration files 139
 - X.25 network example 45, 90, 91
- configuration files
 - displaying 140
 - saving configuration files 139
- configuration options
 - additional 65
- configuration status
 - work with 78
- Configure IPI (CFG IPI) command 121
- configure IPX circuits menu example 35, 58
- configure IPX menu
 - AnyNet/400 support 111
- configure IPX menu example 21, 111
- configuring IPX
 - CL program example 137
- configuring IPX support 20
 - IPX over IPX 113
- configuring X.25 line description 95
- confirm end of IPX circuit display example 77
- confirm end of IPX connections display example 85
- confirm end of SPX connections display example 85
- connection
 - display IPX connections 83
 - display SPX connections 83
 - status, work with IPX connection 81
 - status, work with SPX connection 81
- connection initiation 98
- connection initiation parameter 49, 98
- considerations
 - configuration 67
 - security 145
- considerations for combining values for routing 106
- considerations for SAPSTATE parameter for routing 106
- considerations for WAN line descriptions 107
- controller description parameter 125
- cost override for NLSP
 - parameter 41
- CPI-Communications 8
- CPI-Communications application program
 - APPC over IPX support of 123
 - SNA over IPX support of 123
- Create Controller Description (CRTCTLAPPC)
 - command 124
- Create IPX Description (CRTIPXD) command
 - prompt example 93
- create IPX description command prompt example 23
- Create Line Description (Ethernet (CRTLINETH))
 - command 30
- Create Line Description (Ethernet) (CRTLINETH)
 - command 51
- Create Line Description (Token-Ring) (CRTLINTRN)
 - command 51
- Create Line Description (X.25) (CRTLINX25)
 - command 95
- Create Line Description (X25) (CRTLINX25)
 - command 46, 51, 98
- creating an Internetwork Packet Exchange (IPX)
 - description 23
- creating an IPX (Internetwork Packet Exchange)
 - description 23
- creating an IPX description 46
 - for X.25 network 92
- creating the APPC controller description 124
- creating the APPC Device and Mode Descriptions 126
- CRTLINETH (Create Line Description) (Ethernet)
 - command 30
- CRTLINX25 command 46

D

- database files 140
- database files used by IPX support 139
- datagram size 26, 41
- debugging capabilities 157, 159
- debugging IP over IPX configurations
 - IPXPING (Verify IPX Connection) 160
 - Verify IPX Connection (IPXPING) 160
 - Verify IPX Connection (VFYIPXCNN) 160
 - VFYIPXCNN (Verify IPX Connection) 160
- default maximum datagram size
 - hint 41
 - parameter 41
- default packet size
 - parameter 49
 - receive value 49
 - transmit value 49
- default window size parameter 50
- delay
 - parameter 42
- Delete Communications Trace (DLTCMNTRC)
 - command 161
- deleting
 - communications trace 161
- direct routing 12
- display
 - active IPX description example 86
 - associated routes example 75
 - associated services example 74
 - circuit route command prompt example 61
 - circuit route example 104
 - circuit services command prompt example 65
 - format trace data 168
 - IPX circuits LAN example 73
 - IPX connection status example 83
 - IPX route details example 76, 78
 - IPX route information display example 78
 - IPX service details example 74, 79
 - IPX service information example 79

- display (*continued*)
 - spoiled file display example 170
 - SPX connection status example 83
 - start a service tool for SST 154, 164
 - start trace 165
 - system service tools (SST) 163
 - work with communications traces 164
 - X.25 circuit example 56
- Display Line Description (DSPLIND) command 51
- Display Physical File Member (DSPPFM)
 - command 140
- displaying
 - an active IPX description 86
 - associated routes 75
 - associated services 74
 - circuit configurations 42
 - circuit status 73
 - communications trace 168
 - configuration files 140
 - IPX route information 78
 - IPX service information 79
 - physical file member 140
 - route details 76
 - service details 75
- distributed data processing 1
- DLTCMNTRC (Delete Communications Trace)
 - command 161
- DSPPFM (Display Physical File Member)
 - command 140

E

- Enable for IW2
 - parameter
 - IPX circuit 100
- Enable for NLSP
 - parameter
 - IPX circuit 40
- End Communications Trace (ENDCMNTRC)
 - command 161
- End IPX Circuits (ENDIPXCCT) command 77
- ENDCMNTRC (End Communications Trace)
 - command 161
- ending
 - communications trace 161
 - IPX (Internetwork Packet Exchange) support
 - End IPX (ENDIPX) command 70
- ending IPX
 - connections 85
- ending IPX connections
 - hint 85
- ending IPX support 67
 - hint 70
- ending SPX
 - connections 85
- ENDIPXCCT (End IPX Circuit) command 77
- errors
 - IP over IPX configuration 160
- Ethernet
 - supported adapters 30
- Ethernet line description
 - example
 - for system a 34
 - for system b 34
 - for system c 35
- Ethernet network configuration 23
- Ethernet standard parameter 33
- example 32, 72, 81, 118
 - add circuit route 103
 - add circuit route command prompt 59, 101
 - add circuit route for IPX network number 00000004 60
 - add circuit route for IPX network number 00000005 60
 - add circuit route for IPX network number 00000006 60
 - add circuit service command prompt 63
 - add IP over IPX interface command prompt 114, 115
 - add IPX circuit command prompt 37
 - add SNA over IPX location command prompt 132
 - add SNA over IPX locations command prompt 133
 - add X.25 IPX circuit command prompt 98
 - adding a circuit service to the network example 62
 - APPC controller display 126
 - APPC over IPX configuration 124
 - APPN remote location list display 128, 129, 130
 - CL commands for the APPC over IPX 133
 - CL commands for the IP over IPX configuration 120
 - CL program 137
 - configure IPX circuits menu 35, 58
 - configure IPX menu 21, 111
 - confirm end of IPX circuit display 77
 - confirm end of IPX connections display 85
 - confirm end of SPX connections display 85
 - Create IPX Description (CRTIPXD) command prompt 93
 - create IPX description command prompt 23
 - create line description (Ethernet) (CRTLINETH)
 - command prompt 30
 - display active IPX description 86
 - display associated routes 75
 - display associated services 74
 - display circuit route 104
 - display circuit route command prompt 61
 - display circuit services command prompt 65
 - display IPX circuit for system A 43
 - display IPX circuit for system B 44
 - display IPX circuit for system c 45
 - display IPX circuits LAN 73
 - display IPX connection status 83

example (*continued*)

- display IPX route details 76, 78
- display IPX route information 78
- display IPX service details 74, 79
- display IPX service information 79
- display spooled file display 170
- display SPX connection status 83
- display X.25 circuit 56
- Ethernet line description 34
- Ethernet line description for system A 34
- Ethernet line description for system B 34
- Ethernet line description for system c 35
- format trace data 168
- integrating NetWare for SAA with the AS/400 178
- IP over IPX configuration 120
- IPX Circuit for X.25 line on system C 53
- IPX circuit routes 57, 100
- IPX description for system A 28
- IPX description for system b 28
- IPX description for system c 28
- IPX internetwork 11
- IPX network
 - configuring 21
- IPX network to be added to the IP network 113
- IPX protocol relationship 3
- IPX support
 - Integrated PC Server 15
- network 21
- protocol relationship 3
- restoring IPX configuration 140
- saving IPX configuration 139
- single IP network and single IPX network 112
- start a service tool menu 164
- Start IPX command prompt 69
- start trace 165, 166
- successfully added IP over IPX address 120
- system service tools (SST) display 164
- work with active jobs display 68
- work with circuit routes 103
- work with circuit routes display 61
- work with circuit routes display example 58
- work with circuit services display 62, 65
- work with communications resource 48
- work with communications traces display 166
- work with configuration status display 78
- work with IP over IPX address display 118
- work with IP over IPX interface display 116
- Work with IP over IPX Interfaces 114
- work with IPX circuits display 36, 42
- work with IPX circuits status display 76
- work with IPX descriptions display 23
- work with IPX status menu 72, 163
- work with IPX/SPX connection status display con-
nection state 81
- work with IPX/SPX connection status display
user 81

example (*continued*)

- work with output queue display 169
- work with SNA over IPX locations display 132
- X.25 line description command prompt example for
system D 96
- X.25 line description for AS/400 system C 47, 51
- X.25 network 46

F

- format communications trace data example 168
- format IPX data 168
- formatting
 - communications trace 168
- frame relay
 - supported adapters 30
- frame type
 - hint 38
 - Novell 38
 - parameter
 - IPX circuit 38
- FSIOP 2
 - See also* Integrated PC Server

G

- general RIP request
 - definition 105
- getting started
 - working with communications trace 162

H

- hint
 - adding an IPX circuit 35
 - adding circuit service 62
 - adding static routes 58
 - APPC controller description 125
 - default maximum datagram size 41
 - ending IPX connections 85
 - ending IPX support 70
 - frame type 38
 - IPX description name 24
 - IPX internal network number 25, 93
 - IPX maximum datagram parameter 26
 - IPX network number 38
 - router priority for NLSP 40
 - source service access point parameter 33
- history of Internetwork Packet Exchange (IPX)
 - support 3
- hop
 - definition 12
- hops
 - parameter
 - circuit route 59
 - circuit service 64

- I
- ICF (intersystem communications function)
 - application program
 - APPC over IPX, support of 123
 - SNA over IPX support of 123
- ICF applications 8
- indirect routing 12
- input/output (I/O) adapters
 - communications
 - Integrated PC Server 30
- Integrated PC Server 2
 - definition 16
 - input/output (I/O) adapters 30
 - internal network 15
 - IPX support 15
 - NetWare 15
 - supported adapters 30
- integrating NetWare for SAA with the AS/400
 - example 178
- internal network
 - Internetwork Packet Exchange (IPX)
 - definition 14
- internal network number 25
- internet
 - definition 2
- internet address parameter 115
- Internetwork Packet Exchange (IPX)
 - circuit 12
 - history 3
 - internal network 14
 - introduction 1
 - job
 - QAPPCIPX 68
 - QIPX 68
 - jobs 68
 - network
 - definition 10
 - internal 14
 - network number
 - internal network 15
 - networks 1
 - problem analysis 153
 - protocol
 - definition 3, 8
 - protocols 1
 - QSYSWRK subsystem 68
 - routing 12
 - server
 - definition 13
 - software 3
 - support
 - definition 2
 - history 3
 - support, operating
 - configuration considerations 67
 - Internetwork Packet Exchange (IPX) circuit
 - adding 35
 - Internetwork Packet Exchange (IPX) functions
 - relationship among 9
 - Internetwork Packet Exchange (IPX) network
 - example 21
 - Internetwork Packet Exchange (IPX) network number
 - registering 17
 - Internetwork Packet Exchange (IPX) node address 11
 - Internetwork Packet Exchange (IPX) packet
 - definition 12
 - hop 12
 - Internetwork Packet Exchange (IPX) support
 - configuring 20
 - overview 21
 - ending
 - hint 70
 - operating 67
 - routing 107
 - starting
 - Start IPX (STRIPX) command 69
 - Internetwork Packet Exchange Protocol (IPX) support
 - job
 - description 149
 - interoperability
 - definition 2
 - IOAs
 - communications
 - Integrated PC Server 30
- IOP
 - IPX performance 149
- IOP-assist functions
 - definition 150
 - NetWare Link Services Protocol (NLSP) assist 151
 - packet rollup 150
 - packet train 150
 - routing information protocol (RIP) off-load 150
 - service advertising protocol (SAP) off-load 150
 - Simple Network Management Protocol (SNMP)
 - support 151
- IP or IPX configuration examples
 - single IP network and single IPX network 112
- IP over IPX
 - activating 121
 - addresses configuration
 - allow AnyNet/400 support 120
 - common configuration errors 123
 - configuring IPX support 113
 - definition 110
 - matching configuration parameters 122
 - matching parameters 122
 - problem analysis
 - debugging capabilities 159
- IP over IPX addresses
 - physical file 141

- IP over IPX addresses configuration
 - parameter
 - remote IPX network number 119
 - remote destination parameter 118
 - remote IPX node address parameter 119
 - subnet mask parameter 119
- IP over IPX configuration
 - Add IP over IPX Interface (ADDIPIIFC)
 - command 114
 - errors 160
 - overview 112
 - IP over IPX configuration example 120
 - IP over IPX interface configuration 114
 - internet address parameter 115
 - subnet mask parameter 116
 - work with IP over IPX interface display 116
 - IP over IPX menu
 - changing the configuraiton 121
- IPX (Internetwork Packet Exchange)
 - APPC over
 - configuration example 124
 - matching configuration parameters 135
 - circuit 12
 - ending
 - before you end 67
 - introduction 1
 - job
 - QAPPCIPX 68
 - QIPX 68
 - jobs 68
 - network
 - definition 10
 - networks 1
 - problem analysis 153
 - protocol
 - definition 3
 - protocols 1
 - QSYSWRK subsystem 68
 - router
 - definition 12
 - routing 12
 - server
 - definition 13
 - starting
 - before you start 67
 - support
 - definition 2
 - history 3
 - support, operating
 - configuration considerations 67
- IPX (Internetwork Packet Exchange) functions
 - relationship among 9
- IPX (Internetwork Packet Exchange) network number
 - registering 17
- IPX (Internetwork Packet Exchange) node address 11
- IPX (Internetwork Packet Exchange) packet
 - definition 12
 - hop 12
- IPX (Internetwork Packet Exchange) support
 - configuring 20
 - ending
 - End IPX (ENDIPX) command 70
 - hint 70
 - job
 - description 149
 - routing 107
 - starting 69
- IPX and AnyNet/400
 - changing the IP over IPX configuration 121
 - configure IPX menu 111
 - support 109
- IPX circuit
 - adding 35
 - additional parameters 41
 - considerations for routing 105
 - for X.25 SVC line description
 - adding 52
 - IPX circuit considerations for routing 105
 - IPX circuit definition
 - configuration
 - NetWare Support 90
 - IPX circuit routes example 57, 100
 - IPX circuit services
 - physical file 143
 - IPX circuits
 - ending 77
 - physical file 142
 - sample 43
 - IPX configuration
 - adding route information 45
 - adding service information 45
 - CL program example 137
 - X.25 network configuration 46
 - IPX connections
 - displaying 83
 - IPX database files for OS/400 140
 - table 140
 - IPX description
 - creating 23
 - NetWare Support
 - configuration 89
 - parameter 93
 - IPX description considerations for routing 104
 - IPX description name
 - hint 24
 - IPX description parameter 24
 - IPX descriptions
 - performance 93
 - IPX internal network number
 - hint 25, 93
 - parameter 93

- IPX internal network number parameter 25
- IPX internetwork example 11
- IPX maximum datagram parameter 26
 - hint 26
- IPX network example 21
- IPX network number
 - hint 38
 - parameter 38
 - circuit route 59
 - circuit service 63
 - tip 38
- IPX network to be added to the IP network
 - example 113
- IPX node address 119
- IPX performance
 - protocol support provided by IOP 149
- IPX protocol layer problems, tracing 154
- IPX protocol relationship 3
- IPX route information
 - displaying 78
- IPX router name parameter 26
- IPX routes
 - physical file 143
- IPX routing 25
- IPX routing protocol parameter 25
- IPX service information
 - displaying 79
- IPX status
 - circuit status
 - work with 72
- IPX status for
 - work with 72
- IPX Status menu
 - problem analysis 162
- IPX support
 - advanced configuration
 - NetWare Support on the Integrated PC Server 89
 - routing considerations 89
 - configuring
 - IPX network example 21
 - overview 21
 - database files 139
 - input/output (I/O) adapters 30
 - Integrated PC Server
 - example 15
 - operating 67
- IPX support and AnyNet/400
 - add IP over IPX address (ADDIPIADR)
 - command 117
- IPX support on AS/400 9
- IPX virtual network
 - defined 14
- IPXPING (Verify IPX Connection) 160

J

- job
 - IPX 149
- job log
 - working with 153
- jobs
 - IPX 68

L

- line description
 - parameter 38
 - IPX circuit 53
- line description name parameter 32
- line description parameter 47, 96, 99
- local network address parameter 97
- logical channel entries
 - logical channel identifier 97
 - logical channel type 97
 - PVC controller 97
- logical channel entries parameter 48, 97
- logical channel ID 53
- logical channel identifier 48, 97
- logical channel type 48, 97
- logical network address parameter 49

M

- MAC (media access control), definition 40
- MAC Channel for NLSP
 - parameter 40
- main storage pool size 149
- manuals
 - architecture 184
 - communications 183
 - NetWare 184
 - programming 183
 - system 184
- matching configuration parameters
 - APPC over IPX support 135
 - IP over IPX support 122
- matching parameters 122, 135
- maximum packet size parameter 50
- members using PDM
 - working with 140
- message queue
 - working with 153
- messages, alertable 174
- MPTN (Multiprotocol Transport Networking Architecture)
 - application protocol
 - definition 8
- multicast
 - definition 40
- Multiprotocol Transport Networking Architecture (MPTN)
 - application protocol
 - definition 8

N

- NetWare
 - Integrated PC Server 15
- NetWare books 184
- NetWare for SAA
 - AS/400 application support 179
 - Client Access/400 178
 - definition 177
 - integrating with the AS/400 example 178
- NetWare link services protocol (NLSP)
 - definition 9
- NetWare link services protocol (NLSP) off-load
 - definition 151
- NetWare Support
 - configuration
 - circuit definition 90
 - Internetwork Packet Exchange (IPX) 89
 - IPX description 89
- network
 - definition 1
 - peer-to-peer 1
 - protocols 3
 - software 3
 - topology examples 1
- network address 97
- network configuration
 - object security 147
- network example 21
 - Internetwork Packet Exchange (IPX) 21
- network number 38, 93
 - internal 15
 - Novell Network Registry 17
 - registering 17
- network protocol
 - NetWare link services protocol (NLSP) 9
- network protocol layer 8
 - Internetwork Packet Exchange (IPX) 8
 - IPX (Internetwork Packet Exchange) 8
 - RIP (routing information protocol) 8
 - routing information protocol (RIP) 8
 - service advertising protocol (SAP) 9
- network status for IPX
 - connections
 - display 85
 - end 85
- NLSP (NetWare link services protocol)
 - cost override 41
 - definition 9
 - enable for 40
 - MAC channel 40
 - router priority 40
 - tip 40
- NLSP off-load
 - definition 151

- NLSP route selection 107
- node
 - addressing 11
 - definition 1
- node address
 - parameter
 - circuit service 64
- Novell
 - frame type 38
- Novell Network Registry
 - duties 17
 - registering
 - network number 17
- number of hops
 - parameter
 - circuit route 59, 102
 - circuit service 64
- number of ticks
 - parameter
 - circuit route 60, 102

O

- object authority
 - configuration
 - commands 146
- object security
 - network configuration 147
- operating IPX support
 - managing IPX support 67
- option 161
 - See also work with...*

P

- packet
 - definition 2
- packet rollup
 - definition 150
- packet size 50, 54
 - receive size 54
 - receive value 50
 - transmit size 54
- packet train
 - definition 150
- parameter 119
 - automatic start 54
 - automatic start (AUTOSTART) 42
 - circuit name 38, 53, 59, 63, 99
 - circuit route 102
 - circuit service 63
 - connection initiation 49, 98
 - controller description 125
 - cost override for NLSP 41
 - default maximum datagram size 41
 - default packet size 49

- parameter (*continued*)
 - default window size 50
 - delay (DELAY) 42
 - Enable for IW2 100
 - Enable for NLSP (Enable for NLSP) 40
 - Ethernet standard 33
 - frame type 38
 - internet address parameter 115
 - IPX description 24, 93
 - IPX internal network number 25, 93
 - IPX maximum datagram 26
 - IPX network number 38, 59
 - IPX router name 26
 - IPX routing protocol 25
 - line 38
 - See *also* line description
 - line description 47, 53, 96, 99
 - line description name 32
 - link type 125
 - local network address 97
 - logical channel entries 48, 97
 - logical network address 49
 - MAC Channel for NLSP 40
 - maximum packet size 50
 - number of hops 64
 - circuit route 59, 102
 - number of ticks 60
 - circuit route 102
 - online 125
 - remote control point name 125
 - remote destination 118
 - remote IPX network number 59, 119
 - circuit service 63
 - remote location name 132
 - remote network identifier 125, 132
 - remote network number 132
 - circuit route 102
 - remote node address 64, 133
 - remote socket address 64
 - resource name 32, 47, 96
 - RIP state 54
 - router priority for NLSP 40
 - SAP state 55
 - source service access point 33
 - subnet mask 116, 119
 - SVC Call Type 53
 - text 34
 - X.25 default window size 54
 - X.25 PVC logical channel ID 53
 - X.25 PVC logical channel identifier 99
 - X.25 SVC network address 53, 99
- parameters
 - additional for IPX circuit 41
- peer-to-peer network 1
- performance
 - IPX descriptions 93
- performance (*continued*)
 - IPX jobs 149
 - main storage pool size 149
 - NLSP off-load 151
 - packet rollup 150
 - packet train 150
 - RIP off-load 150
 - SAP off-load 150
 - Simple Network Management Protocol (SNMP)
 - AS/400 SNMP agent 151
- physical database files
 - table 140
- physical database files for IPX support table 140
- physical file
 - QAZSPPADR 141
 - QAZSPPCCT 142
 - QAZSPPLC 141
 - QAZSPPRTE 143
 - QAZSPPSRV 143
- physical file member
 - displaying 140
 - IPX configuration 140
- planning
 - work with communications trace 162
 - Work with IPX Status (WRKIPXSTS)
 - command 162
 - WRKIPXSTS (Work with IPX Status)
 - command 162
- point-to-point topology 1
- pool size 149
- Print Communications Trace (PRTCMNTRC)
 - command 161
- printing
 - communications trace 161
- problem analysis
 - common errors 154
 - communications trace 161, 164
 - formatting 168
 - saving 168
 - stopping 167
 - verifying contents 168
- IP over IPX
 - debugging capabilities 159
 - tracing 160
- IPX
 - alertable messages 174
 - working with the job log 153
 - working with the message queue 153
 - IPX protocol layer problems 154
 - IPX Status menu 162
 - IPX support 153
 - return codes and messages 171
 - SNA over IPX debugging capabilities 157
- programming
 - books 183

- protocol
 - application
 - Multiprotocol Transport Networking Architecture (MPTN) 8
 - Simple Network Management Protocol (SNMP) 5
 - sockets 5
 - definition 3
 - network
 - definition 3
 - Internetwork Packet Exchange (IPX) 8
 - NetWare link services protocol 9
 - Service Advertising Protocol (SAP) 9
 - network layer
 - RIP (routing information protocol) 8
 - routing information protocol (RIP) 8
 - transport layer
 - Sequenced Packet Exchange (SPX) 7
- protocol layer problems
 - tracing 154
- protocol layer, protocol 8
- protocol layer, transport 7
- protocol layers
 - upper 5
- protocol relationship example 3
- protocol support provided by IOP
 - IPX performance 149
- PRTCMNTRC (Print Communications Trace)
 - command 161
- PVC controller 48, 97
- PVC logical channel identifier 99

Q

- QAPPCIPX job 68
- QAZSPPADR physical file 141
- QAZSPPCCT physical file 142
- QAZSPPLC physical file 141
- QAZSPPRTE physical file 143
- QAZSPPSRV physical file 143
- QIPX job 68
- QPGMR authority 145
- QSECOFR authority 145
- QSRV authority 145
- QSRVBAS authority 145
- QSYSOPR authority 145
- QSYSWRK subsystem 68

R

- receive packet size 54
- receive value 49, 50
- receive window size 54
- records lengths
 - table 140
- registering IPX network numbers 17
- relationship among the
 - IPX functions 9
- remote control point name parameter 125
- remote destination parameter 118
- remote IPX network number
 - parameter
 - circuit route 59
- remote IPX network number parameter 119
- remote IPX node address 119
- remote IPX node address parameter 119
- remote location name parameter 132
- remote network identifier parameter 125, 132
- remote network number
 - parameter
 - circuit route 102
- remote network number parameter 132
- remote node address
 - parameter
 - circuit service 64
- remote node address parameter 133
- remote socket address
 - parameter
 - circuit service 64
- resource name parameter 32, 47, 96
- resource sharing 1
- restoring
 - configuration files 139
- return codes and messages
 - problem analysis 171
- ring topology 1
- RIP (routing information protocol)
 - definition 8
- RIP off-load
 - definition 150
- RIP state
 - parameter
 - IPX circuit 54
- route
 - IPX route information, display 78
- route details
 - displaying 76
- route information
 - adding 45
- route selection 107
- router
 - Internetwork Packet Exchange (IPX)
 - definition 12
 - router name 26
 - router priority for NLSP
 - hint 40
 - parameter 40
- routing 107
 - definition 12
 - direct 12
 - indirect 12

- routing information protocol (RIP)
 - definition 8
- routing information protocol (RIP) off-load
 - definition 150

S

- sample 28
 - display IPX circuit for system A 43
 - display IPX circuit for system c 45
 - Ethernet line description 34
 - Ethernet line description for system A 34
 - Ethernet line description for system B 34
 - Ethernet line description for system c 35
 - X.25 line description for AS/400 system C 47, 51
- sample circuit services 65
- sample display IPX circuit for system B 44
- sample IPX Circuit for X.25 line on system C 53
- sample IPX circuits 43
- sample X.25 line description 50
- SAP (Service Advertising Protocol)
 - definition 9
- SAP off-load
 - definition 150
- SAP state
 - parameter
 - IPX circuit 55
- SAPSTATE parameter for routing
 - considerations 106
- saving
 - communications trace 168
 - configuration files 139
- saving IPX configuration example 139
- security
 - authority for users
 - QPGMR 145
 - QSECOFR 145
 - QSRV 145
 - QSRVBAS 145
 - QSYSOPR 145
 - considerations 145
 - network configuration 147
- Sequenced Packet Exchange (SPX)
 - protocol
 - definition 7
- Sequenced packet exchange (SPX2)
 - definition 7
 - Sockets applications 7
- server
 - definition 1, 13
- server job
 - IPX 68
 - QAPPCIPX 68
 - QIPX 68
- service
 - status, work with IPX 79

- Service Advertising Protocol (SAP)
 - definition 9
- Service Advertising Protocol (SAP) off-load
 - definition 150
- service information
 - adding 45
- service name
 - parameter
 - circuit service 63
- service type
 - parameter
 - circuit service 63
- serving
 - introduction 2
- setting up
 - licensed internal code trace 154
- Simple Network Management Protocol (SNMP)
 - application protocol
 - upper layer 5
- Simple Network Management Protocol (SNMP)
 - support 151
- single IP network and single IPX Network
 - example 112
- SNA over IPX
 - definition 111
 - problem analysis 157
 - tracing 158
- SNA over IPX configuration
 - overview 123
- SNA over IPX Locations
 - physical file 141
- SNMP (Network Management Protocol)
 - application protocol
 - upper layer 5
- SNMP support
 - IOP-assist functions
 - performance 151
- socket
 - definition 5
 - well-known
 - table 6
- socket address
 - parameter
 - circuit service 64
- socket numbers 6
- socket numbers table 6
- sockets interface
 - application protocol 5
- software, network 3
- source service access point parameter 33
 - hint 33
- specific RIP request
 - definition 105
- SPX (Sequenced Packet Exchange)
 - protocol
 - definition 7

- SPX connections
 - displaying 83
- SPX2
 - State Values 81
- SSAPs 33
- SST (system service tools)
 - accessing 163
- standard frame type 33
- start 54
 - communications trace display 165
- start a service tool menu example 164
- Start Communications Trace (STRCMNTRC)
 - command 161
- Start IPX Circuits (STRIPCCT) command 76
- Start IPX command prompt example 69
- Start Trace Example 166
- starting
 - communications trace 161, 164
 - work with communications trace 162
- starting IPX circuits 76
- starting IPX support 67
- static route
 - adding 57
 - definition 57, 61
- static service
 - definition 61
- status for IPX
 - circuit
 - work with configuration status 78
 - circuit status
 - display 73
 - circuits
 - display associated routes 75
 - display associated services 74
 - working with associated routes and services 74
 - connections 81
 - display 83
 - displaying route details 76
 - ending circuits 77
 - information
 - service 79
 - route information, display 78
 - starting circuits 76
- status for SPX
 - connections
 - display 83
 - general information 81
- status support 72
- stopping
 - communications trace 167
- storage pool size 149
- STRCMNTRC (Start Communications Trace)
 - command 161
- STRIPCCT (Start IPX Circuits) command 76
- subnet mask parameter 116, 119

- successfully added IP over IPX address example 120
- SVC call type 53
- SVC network address 53, 99
- system books 184
- system service tools (SST)
 - accessing 163
 - display 163
 - example 164

T

- table, socket numbers 6
- text parameter 34
- ticks
 - parameter
 - circuit route 60
- tip
 - IPX network number 38
 - router priority 40
- token ring
 - supported adapters 30
- topology
 - bus 1
 - network 1
 - point-to-point 1
 - ring 1
- trace
 - communications
 - formatting 168
 - saving 168
 - starting communications 164
 - stopping communications 167
 - verifying contents of communications 168
 - working with communications 161
- tracing IP over IPX problems 160
- tracing protocol layer problems 154
- tracing SNA over IPX Problems 158
- transmit packet size 54
- transmit value 49, 50
- transmit window size 54
- transport protocol layer 7
 - Sequenced Packet Exchange (SPX) 7

U

- upper layers
 - protocol 5
- upper protocol layers 5
- user authority
 - QPGMR 145
 - QSECOFR 145
 - QSRV 145
 - QSRVBAS 145
 - QSYSOPR 145

V

- Verify IPX Connection (IPXPING) 160
- Verify IPX Connection (VFYIPXCNN) command 160
- verifying
 - contents of communications trace 168
- VFYIPXCNN (Verify IPX Connection) command 160
- virtual network
 - definition 14

W

- well-known sockets
 - definition 6
- well-known sockets, definition 6
- window size 50, 54
 - receive 54
 - receive value 50
 - transmit 54
 - transmit value 50
- work with active jobs display example 68
- work with circuit routes display example 58, 61
- work with circuit routes example 103
- work with circuit services display example 62, 65
- work with communications resource display 32
- work with communications resource display example 32
- work with communications resource example 48
- work with communications traces display example 166
- work with configuration status display example 78
- work with IP over IPX address display example 118
- work with IP over IPX interface display example 116
- work with IP over IPX interfaces example 114
- work with IPX circuits display example 36, 42
- work with IPX circuits status display 72
- work with IPX circuits status display example 72, 76
- work with IPX connection status 81
- work with IPX descriptions display example 23
- Work with IPX Status (WRKIPXSTS) command 72, 162
- Work with IPX Status menu 72
- work with IPX Status menu example 72, 163
- work with IPX/SPX connection status display byte counts 81
- work with IPX/SPX connection status display byte counts example 81
- work with IPX/SPX connection status display connection state 81
- work with IPX/SPX connection status display user example 81
- Work with Members Using PDM (WRKMBRPDM) command 140
- work with output queue display example 169
- work with SNA over IPX locations display example 132

- work with SPX connection status 81
- working with
 - members using PDM 140
- WRKIPXSTS (Work with IPX Status) command 72, 162
- WRKMBRPDM (Work with Members Using PDM) command 140

X

- X.25
 - supported adapters 30
- X.25 circuit display
 - sample 55
- X.25 default packet size
 - parameter 54
 - IPX circuit 54
- X.25 default window size
 - parameter
 - IPX circuit 54
- X.25 line description
 - configuring 46
 - for AS/400 system c
 - example 51
 - sample 50
- X.25 line description command prompt 96
- X.25 network
 - adding an IPX circuit 98
 - configuring line description 95
 - example 45
 - IPX description 92
- X.25 network example 46
- X.25 PVC logical channel ID
 - parameter
 - IPX circuit 53
- X.25 PVC logical channel identifier
 - parameter
 - IPX circuit 99
- X.25 SVC call type
 - parameter
 - IPX circuit 53
- X.25 SVC network address
 - parameter
 - IPX circuit 53, 99

Communicating Your Comments to IBM

AS/400 Advanced Series
Internetwork Packet Exchange (IPX**)
Support
Version 4
Publication No. SC41-5400-00

If you especially like or dislike anything about this book, please use one of the methods listed below to send your comments to IBM. Whichever method you choose, make sure you send your name, address, and telephone number if you would like a reply.

Feel free to comment on specific errors or omissions, accuracy, organization, subject matter, or completeness of this book. However, the comments you send should pertain to only the information in this manual and the way in which the information is presented. To request additional publications, or to ask questions or make comments about the functions of IBM products or systems, you should talk to your IBM representative or to your IBM authorized remarketer.

When you send comments to IBM, you grant IBM a nonexclusive right to use or distribute your comments in any way it believes appropriate without incurring any obligation to you.

If you are mailing a readers' comment form (RCF) from a country other than the United States, you can give the RCF to the local IBM branch office or IBM representative for postage-paid mailing.

- If you prefer to send comments by mail, use the RCF at the back of this book.
- If you prefer to send comments by FAX, use this number:
 - United States and Canada: 1-800-937-3430
 - Other countries: 1-507-253-5192
- If you prefer to send comments electronically, use this network ID:
 - IBMMAIL(USIB56RZ)
 - IDCLERK@RCHVMW2.VNET.IBM.COM

Make sure to include the following in your note:

- Title and publication number of this book
- Page number or topic to which your comment applies.

Readers' Comments — We'd Like to Hear from You

**AS/400 Advanced Series
Internetwork Packet Exchange (IPX**)
Support
Version 4**

Publication No. SC41-5400-00

Overall, how satisfied are you with the information in this book?

	Very Satisfied	Satisfied	Neutral	Dissatisfied	Very Dissatisfied
Overall satisfaction	<input type="checkbox"/>	<input type="checkbox"/>	<input type="checkbox"/>	<input type="checkbox"/>	<input type="checkbox"/>

How satisfied are you that the information in this book is:

	Very Satisfied	Satisfied	Neutral	Dissatisfied	Very Dissatisfied
Accurate	<input type="checkbox"/>	<input type="checkbox"/>	<input type="checkbox"/>	<input type="checkbox"/>	<input type="checkbox"/>
Complete	<input type="checkbox"/>	<input type="checkbox"/>	<input type="checkbox"/>	<input type="checkbox"/>	<input type="checkbox"/>
Easy to find	<input type="checkbox"/>	<input type="checkbox"/>	<input type="checkbox"/>	<input type="checkbox"/>	<input type="checkbox"/>
Easy to understand	<input type="checkbox"/>	<input type="checkbox"/>	<input type="checkbox"/>	<input type="checkbox"/>	<input type="checkbox"/>
Well organized	<input type="checkbox"/>	<input type="checkbox"/>	<input type="checkbox"/>	<input type="checkbox"/>	<input type="checkbox"/>
Applicable to your tasks	<input type="checkbox"/>	<input type="checkbox"/>	<input type="checkbox"/>	<input type="checkbox"/>	<input type="checkbox"/>

Please tell us how we can improve this book:

Thank you for your responses. May we contact you? Yes No

When you send comments to IBM, you grant IBM a nonexclusive right to use or distribute your comments in any way it believes appropriate without incurring any obligation to you.

Name

Address

Company or Organization

Phone No.



Cut or Fold
Along Line

Fold and Tape

Please do not staple

Fold and Tape

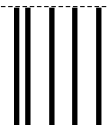

NO POSTAGE
NECESSARY
IF MAILED IN THE
UNITED STATES

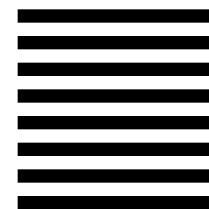

BUSINESS REPLY MAIL

FIRST-CLASS MAIL PERMIT NO. 40 ARMONK, NEW YORK

POSTAGE WILL BE PAID BY ADDRESSEE

IBM CORPORATION
ATTN DEPT 542 IDCLERK
3605 HWY 52 N
ROCHESTER MN 55901-7829



Fold and Tape

Please do not staple

Fold and Tape

Cut or Fold
Along Line



Printed in the United States of America
on recycled paper containing 10%
recovered post-consumer fiber.

SC41-5400-00



Spine information:



AS/400 Advanced Series

Internetwork Packet Exchange (IPX**)
Support

Version 4