

Power Systems

*Power supplies for the 8408-44E or
8408-E8E*

IBM

Power Systems

*Power supplies for the 8408-44E or
8408-E8E*

IBM

Note

Before using this information and the product it supports, read the information in “Safety notices” on page vii, “Notices” on page 87, the *IBM Systems Safety Notices* manual, G229-9054, and the *IBM Environmental Notices and User Guide*, Z125-5823.

This edition applies to IBM Power Systems servers that contain the POWER8 processor and to all associated models.

© Copyright IBM Corporation 2015, 2016.

US Government Users Restricted Rights – Use, duplication or disclosure restricted by GSA ADP Schedule Contract with IBM Corp.

Contents

Safety notices	vii
---------------------------------	------------

Power supplies for the 8408-44E or 8408-E8E	1
--	----------

Removing and replacing a power supply in the 8408-44E or 8408-E8E	1
Removing and replacing a power supply in the 8408-44E or 8408-E8E system with the power turned off	1
Preparing the system to remove and replace a power supply with the power turned off	1
Removing a power supply from the 8408-44E or 8408-E8E system with the power turned off	5
Replacing a power supply in the 8408-44E or 8408-E8E system with the power turned off	6
Preparing the system for operation after removing and replacing a power supply with the power turned off	8
Removing and replacing a power supply in the 8408-44E or 8408-E8E system with the power turned on	9
Preparing the system to remove and replace a power supply with the power turned on	9
Removing a power supply from the 8408-44E or 8408-E8E system with the power turned on	11
Replacing a power supply in the 8408-44E or 8408-E8E system with the power turned on	13
Preparing the system for operation after removing and replacing a power supply with the power turned on	15

Common procedures for removing and replacing power supplies	17
--	-----------

Before you begin	17
Identifying a part	20
Identifying the enclosure or server that contains the part	20
Enabling enclosure or server indicators with the ASMI	20
Control panel LEDs.	20
Activating an identify LED for an enclosure or server by using the HMC.	21
Finding the part location code and LED support status	22
Identifying a part by using the operating system or VIOS	23
Identifying a part in an AIX system or logical partition.	23
Finding the location code for a part in an AIX system or logical partition.	23
Activating the indicator light for a part by using AIX diagnostics	23
Identifying a part in an IBM i system or logical partition	24
Finding the location code and activating the indicator light for a part by using the IBM i operating system	24
Identifying a part in a Linux system or logical partition	25
Finding the location code of a part in a Linux system or logical partition.	25
Activating the indicator light for a part by using the Linux operating system	25
Identifying a part in a VIOS system or logical partition.	25
Finding the location code of a part in a VIOS system or logical partition	25
Activating the indicator light for a part by using the VIOS tools.	26
Identifying a part by using the ASMI.	26
Activating the identify LED by using the ASMI when you know the location code	26
Activating the identify LED by using the ASMI when you do not know the location code	27
Identifying a part by using the HMC.	27
Stopping a system or logical partition	28
Stopping a system that is not managed by an HMC	28
Stopping a system by using the control panel	28
Stopping a system by using the ASMI	29
Stopping a system by using the HMC	29
Stopping a system by using the HMC Classic or HMC Enhanced interface	29
Stopping a system by using the HMC Enhanced + Tech Preview (Pre-GA) or HMC Enhanced+ interface	30
Stopping an IBM PowerKVM system	30
Starting the system or logical partition	30
Starting a system that is not managed by an HMC	30
Starting a system by using the control panel	31
Starting a system by using the ASMI	32
Starting a system or logical partition by using the HMC	32
Starting a system or logical partition by using the HMC Classic or HMC Enhanced interface	32

Starting a system or logical partition by using the HMC Enhanced + Tech Preview (Pre-GA) or HMC Enhanced+ interface	33
Starting an IBM PowerKVM system	33
Installing or replacing a part with an HMC	34
Installing a part by using the HMC	34
Removing a part by using the HMC	34
Repairing a part by using the HMC	35
Power cords	36
Disconnecting the power cords from the system	36
Connecting the power cords to the system	39
Removing and replacing covers on an 8408-44E or 8408-E8E system	42
Removing the front cover from an 8408-44E or 8408-E8E system	42
Installing the front cover on an 8408-44E or 8408-E8E system	42
Removing the service access cover from an 8408-44E or 8408-E8E system	43
Installing the service access cover on an 8408-44E or 8408-E8E system	44
Removing and replacing the safety cover in an 8408-44E or 8408-E8E system	45
Removing the safety cover from an 8408-44E or 8408-E8E system	45
Replacing the safety cover in an 8408-44E or 8408-E8E system	46
Opening and closing the I/O latch in an 8408-44E or 8408-E8E system	47
Opening the I/O latch in an 8408-44E or 8408-E8E system	47
Closing the I/O latch in an 8408-44E or 8408-E8E system	48
Service and operating positions for an 8408-44E or 8408-E8E system	49
Placing an 8408-44E or 8408-E8E system into the service position	49
Placing an 8408-44E or 8408-E8E system into the operating position	50
Verifying the installed part	51
Verifying a part by using the operating system or VIOS	51
Verifying an installed feature or replaced part by using an AIX system or logical partition	51
Verifying an installed feature by using the AIX operating system	51
Verifying a replaced part by using the AIX operating system	52
Verifying the installed part by using an IBM i system or logical partition	54
Verifying an installed part by using a Linux system or logical partition	54
Verifying an installed part by using stand-alone diagnostics	55
Verifying an installed part or replaced part on a system or logical partition by using Virtual I/O Server tools	56
Verifying an installed part by using VIOS	56
Verify the replacement part by using VIOS	56
Verifying the installed part by using the HMC	58
Viewing serviceable events by using the HMC	59
Verifying a repair	60
Verifying the repair in AIX	61
Verifying a repair by using an IBM i system or logical partition	63
Verifying the repair in Linux	65
Verifying the repair on an IBM PowerKVM system	65
Verifying the repair from the management console	66
Activating and deactivating LEDs	67
Deactivating a system attention LED or partition LED by using the management console	68
Activating or deactivating an identify LED by using the management console	69
Deactivating a system attention LED or logical partition LED by using the Advanced System Management Interface	70
Activating or deactivating an identify LED by using the Advanced System Management Interface	70
Closing a service call	71
Closing a service call by using AIX or Linux	74
Closing a service call by using IBM PowerKVM	77
Closing a service call by using Integrated Virtualization Manager	77
Deactivating an identify LED	80
Deactivating a system attention LED by using the operating system or VIOS tools	80
Deactivating the indicator light for a part by using AIX diagnostics	80
Deactivating the indicator light by using the IBM i operating system	81
Deactivating the indicator light by using the Linux operating system	81
Deactivating the indicator light for a part by using the VIOS tools	82
Deactivating a system attention LED by using the ASMI	82
Deactivating the identify LED by using the ASMI when you know the location code	82

Deactivating the identify LED by using the ASMI when you do not know the location code	82
Deactivating a check log indicator (system information indicator) by using the ASMI.	83
Deactivating LEDs by using the HMC	83
Deactivating a system attention LED or partition LED by using the HMC	83
Deactivating an identify LED for a FRU by using the HMC	84
Deactivating an identify LED for an enclosure by using the HMC	84
Notices	87
Accessibility features for IBM Power Systems servers	88
Privacy policy considerations	89
Trademarks	90
Electronic emission notices	90
Class A Notices	90
Class B Notices	94
Terms and conditions	97

Safety notices

Safety notices may be printed throughout this guide:

- **DANGER** notices call attention to a situation that is potentially lethal or extremely hazardous to people.
- **CAUTION** notices call attention to a situation that is potentially hazardous to people because of some existing condition.
- **Attention** notices call attention to the possibility of damage to a program, device, system, or data.

World Trade safety information

Several countries require the safety information contained in product publications to be presented in their national languages. If this requirement applies to your country, safety information documentation is included in the publications package (such as in printed documentation, on DVD, or as part of the product) shipped with the product. The documentation contains the safety information in your national language with references to the U.S. English source. Before using a U.S. English publication to install, operate, or service this product, you must first become familiar with the related safety information documentation. You should also refer to the safety information documentation any time you do not clearly understand any safety information in the U.S. English publications.

Replacement or additional copies of safety information documentation can be obtained by calling the IBM Hotline at 1-800-300-8751.

German safety information

Das Produkt ist nicht für den Einsatz an Bildschirmarbeitsplätzen im Sinne § 2 der Bildschirmarbeitsverordnung geeignet.

Laser safety information

IBM® servers can use I/O cards or features that are fiber-optic based and that utilize lasers or LEDs.

Laser compliance

IBM servers may be installed inside or outside of an IT equipment rack.

DANGER: When working on or around the system, observe the following precautions:

Electrical voltage and current from power, telephone, and communication cables are hazardous. To avoid a shock hazard:

- If IBM supplied the power cord(s), connect power to this unit only with the IBM provided power cord. Do not use the IBM provided power cord for any other product.
- Do not open or service any power supply assembly.
- Do not connect or disconnect any cables or perform installation, maintenance, or reconfiguration of this product during an electrical storm.
- The product might be equipped with multiple power cords. To remove all hazardous voltages, disconnect all power cords.
 - For AC power, disconnect all power cords from their AC power source.
 - For racks with a DC power distribution panel (PDP), disconnect the customer's DC power source to the PDP.
- When connecting power to the product ensure all power cables are properly connected.

- For racks with AC power, connect all power cords to a properly wired and grounded electrical outlet. Ensure that the outlet supplies proper voltage and phase rotation according to the system rating plate.
- For racks with a DC power distribution panel (PDP), connect the customer's DC power source to the PDP. Ensure that the proper polarity is used when attaching the DC power and DC power return wiring.
- Connect any equipment that will be attached to this product to properly wired outlets.
- When possible, use one hand only to connect or disconnect signal cables.
- Never turn on any equipment when there is evidence of fire, water, or structural damage.
- Do not attempt to switch on power to the machine until all possible unsafe conditions are corrected.
- Assume that an electrical safety hazard is present. Perform all continuity, grounding, and power checks specified during the subsystem installation procedures to ensure that the machine meets safety requirements.
- Do not continue with the inspection if any unsafe conditions are present.
- Before you open the device covers, unless instructed otherwise in the installation and configuration procedures: Disconnect the attached AC power cords, turn off the applicable circuit breakers located in the rack power distribution panel (PDP), and disconnect any telecommunications systems, networks, and modems.

DANGER:

- Connect and disconnect cables as described in the following procedures when installing, moving, or opening covers on this product or attached devices.

To Disconnect:

1. Turn off everything (unless instructed otherwise).
2. For AC power, remove the power cords from the outlets.
3. For racks with a DC power distribution panel (PDP), turn off the circuit breakers located in the PDP and remove the power from the Customer's DC power source.
4. Remove the signal cables from the connectors.
5. Remove all cables from the devices.

To Connect:

1. Turn off everything (unless instructed otherwise).
2. Attach all cables to the devices.
3. Attach the signal cables to the connectors.
4. For AC power, attach the power cords to the outlets.
5. For racks with a DC power distribution panel (PDP), restore the power from the Customer's DC power source and turn on the circuit breakers located in the PDP.
6. Turn on the devices.

Sharp edges, corners and joints may be present in and around the system. Use care when handling equipment to avoid cuts, scrapes and pinching. (D005)

(R001 part 1 of 2):

DANGER: Observe the following precautions when working on or around your IT rack system:

- Heavy equipment—personal injury or equipment damage might result if mishandled.
- Always lower the leveling pads on the rack cabinet.
- Always install stabilizer brackets on the rack cabinet.
- To avoid hazardous conditions due to uneven mechanical loading, always install the heaviest devices in the bottom of the rack cabinet. Always install servers and optional devices starting from the bottom of the rack cabinet.
- Rack-mounted devices are not to be used as shelves or work spaces. Do not place objects on top of rack-mounted devices. In addition, do not lean on rack mounted devices and do not use them to stabilize your body position (for example, when working from a ladder).



- Each rack cabinet might have more than one power cord.
 - For AC powered racks, be sure to disconnect all power cords in the rack cabinet when directed to disconnect power during servicing.
 - For racks with a DC power distribution panel (PDP), turn off the circuit breaker that controls the power to the system unit(s), or disconnect the customer's DC power source, when directed to disconnect power during servicing.
- Connect all devices installed in a rack cabinet to power devices installed in the same rack cabinet. Do not plug a power cord from a device installed in one rack cabinet into a power device installed in a different rack cabinet.
- An electrical outlet that is not correctly wired could place hazardous voltage on the metal parts of the system or the devices that attach to the system. It is the responsibility of the customer to ensure that the outlet is correctly wired and grounded to prevent an electrical shock.

(R001 part 2 of 2):

CAUTION:

- Do not install a unit in a rack where the internal rack ambient temperatures will exceed the manufacturer's recommended ambient temperature for all your rack-mounted devices.
- Do not install a unit in a rack where the air flow is compromised. Ensure that air flow is not blocked or reduced on any side, front, or back of a unit used for air flow through the unit.
- Consideration should be given to the connection of the equipment to the supply circuit so that overloading of the circuits does not compromise the supply wiring or overcurrent protection. To provide the correct power connection to a rack, refer to the rating labels located on the equipment in the rack to determine the total power requirement of the supply circuit.
- *(For sliding drawers.)* Do not pull out or install any drawer or feature if the rack stabilizer brackets are not attached to the rack. Do not pull out more than one drawer at a time. The rack might become unstable if you pull out more than one drawer at a time.



- *(For fixed drawers.)* This drawer is a fixed drawer and must not be moved for servicing unless specified by the manufacturer. Attempting to move the drawer partially or completely out of the rack might cause the rack to become unstable or cause the drawer to fall out of the rack.

CAUTION:

Removing components from the upper positions in the rack cabinet improves rack stability during relocation. Follow these general guidelines whenever you relocate a populated rack cabinet within a room or building.

- Reduce the weight of the rack cabinet by removing equipment starting at the top of the rack cabinet. When possible, restore the rack cabinet to the configuration of the rack cabinet as you received it. If this configuration is not known, you must observe the following precautions:
 - Remove all devices in the 32U position (compliance ID RACK-001 or 22U (compliance ID RR001) and above.
 - Ensure that the heaviest devices are installed in the bottom of the rack cabinet.
 - Ensure that there are little-to-no empty U-levels between devices installed in the rack cabinet below the 32U (compliance ID RACK-001 or 22U (compliance ID RR001) level, unless the received configuration specifically allowed it.
- If the rack cabinet you are relocating is part of a suite of rack cabinets, detach the rack cabinet from the suite.
- If the rack cabinet you are relocating was supplied with removable outriggers they must be reinstalled before the cabinet is relocated.
- Inspect the route that you plan to take to eliminate potential hazards.
- Verify that the route that you choose can support the weight of the loaded rack cabinet. Refer to the documentation that comes with your rack cabinet for the weight of a loaded rack cabinet.
- Verify that all door openings are at least 760 x 230 mm (30 x 80 in.).
- Ensure that all devices, shelves, drawers, doors, and cables are secure.
- Ensure that the four leveling pads are raised to their highest position.
- Ensure that there is no stabilizer bracket installed on the rack cabinet during movement.
- Do not use a ramp inclined at more than 10 degrees.
- When the rack cabinet is in the new location, complete the following steps:
 - Lower the four leveling pads.
 - Install stabilizer brackets on the rack cabinet.
 - If you removed any devices from the rack cabinet, repopulate the rack cabinet from the lowest position to the highest position.
- If a long-distance relocation is required, restore the rack cabinet to the configuration of the rack cabinet as you received it. Pack the rack cabinet in the original packaging material, or equivalent. Also lower the leveling pads to raise the casters off of the pallet and bolt the rack cabinet to the pallet.

(R002)

(L001)



DANGER: Hazardous voltage, current, or energy levels are present inside any component that has this label attached. Do not open any cover or barrier that contains this label. (L001)

(L002)



DANGER: Rack-mounted devices are not to be used as shelves or work spaces. (L002)

(L003)

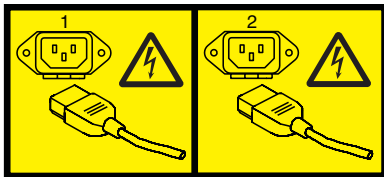

or

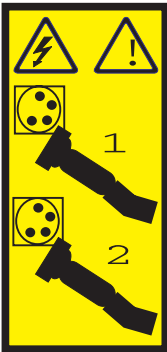

or



or

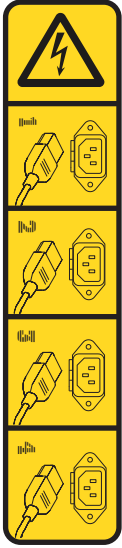

or

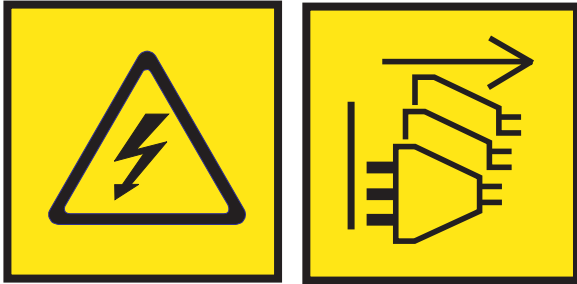

DANGER: Multiple power cords. The product might be equipped with multiple AC power cords or multiple DC power cables. To remove all hazardous voltages, disconnect all power cords and power cables. (L003)

(L007)



CAUTION: A hot surface nearby. (L007)

(L008)



CAUTION: Hazardous moving parts nearby. (L008)

All lasers are certified in the U.S. to conform to the requirements of DHHS 21 CFR Subchapter J for class 1 laser products. Outside the U.S., they are certified to be in compliance with IEC 60825 as a class 1 laser product. Consult the label on each part for laser certification numbers and approval information.

CAUTION:

This product might contain one or more of the following devices: CD-ROM drive, DVD-ROM drive, DVD-RAM drive, or laser module, which are Class 1 laser products. Note the following information:

- Do not remove the covers. Removing the covers of the laser product could result in exposure to hazardous laser radiation. There are no serviceable parts inside the device.
- Use of the controls or adjustments or performance of procedures other than those specified herein might result in hazardous radiation exposure.

(C026)

CAUTION:

Data processing environments can contain equipment transmitting on system links with laser modules that operate at greater than Class 1 power levels. For this reason, never look into the end of an optical fiber cable or open receptacle. Although shining light into one end and looking into the other end of a disconnected optical fiber to verify the continuity of optic fibers may not injure the eye, this procedure is potentially dangerous. Therefore, verifying the continuity of optical fibers by shining light into one end and looking at the other end is not recommended. To verify continuity of a fiber optic cable, use an optical light source and power meter. (C027)

CAUTION:

This product contains a Class 1M laser. Do not view directly with optical instruments. (C028)

CAUTION:

Some laser products contain an embedded Class 3A or Class 3B laser diode. Note the following information: laser radiation when open. Do not stare into the beam, do not view directly with optical instruments, and avoid direct exposure to the beam. (C030)

CAUTION:

The battery contains lithium. To avoid possible explosion, do not burn or charge the battery.

Do Not:

- ___ Throw or immerse into water
- ___ Heat to more than 100°C (212°F)
- ___ Repair or disassemble

Exchange only with the IBM-approved part. Recycle or discard the battery as instructed by local regulations. In the United States, IBM has a process for the collection of this battery. For information, call 1-800-426-4333. Have the IBM part number for the battery unit available when you call. (C003)

CAUTION:

Regarding IBM provided VENDOR LIFT TOOL:

- Operation of LIFT TOOL by authorized personnel only.
- LIFT TOOL intended for use to assist, lift, install, remove units (load) up into rack elevations. It is not to be used loaded transporting over major ramps nor as a replacement for such designated tools like pallet jacks, walkies, fork trucks and such related relocation practices. When this is not practicable, specially trained persons or services must be used (for instance, riggers or movers).
- Read and completely understand the contents of LIFT TOOL operator's manual before using. Failure to read, understand, obey safety rules, and follow instructions may result in property damage and/or personal injury. If there are questions, contact the vendor's service and support. Local paper manual must remain with machine in provided storage sleeve area. Latest revision manual available on vendor's web site.
- Test verify stabilizer brake function before each use. Do not over-force moving or rolling the LIFT TOOL with stabilizer brake engaged.
- Do not move LIFT TOOL while platform is raised, except for minor positioning.
- Do not exceed rated load capacity. See LOAD CAPACITY CHART regarding maximum loads at center versus edge of extended platform.
- Only raise load if properly centered on platform. Do not place more than 200 lb (91 kg) on edge of sliding platform shelf also considering the load's center of mass/gravity (CoG).
- Do not corner load the platform tilt riser accessory option. Secure platform riser tilt option to main shelf in all four (4x) locations with provided hardware only, prior to use. Load objects are designed to slide on/off smooth platforms without appreciable force, so take care not to push or lean. Keep riser tilt option flat at all times except for final minor adjustment when needed.
- Do not stand under overhanging load.
- Do not use on uneven surface, incline or decline (major ramps).
- Do not stack loads.
- Do not operate while under the influence of drugs or alcohol.
- Do not support ladder against LIFT TOOL.
- Tipping hazard. Do not push or lean against load with raised platform.
- Do not use as a personnel lifting platform or step. No riders.
- Do not stand on any part of lift. Not a step.
- Do not climb on mast.
- Do not operate a damaged or malfunctioning LIFT TOOL machine.
- Crush and pinch point hazard below platform. Only lower load in areas clear of personnel and obstructions. Keep hands and feet clear during operation.
- No Forks. Never lift or move bare LIFT TOOL MACHINE with pallet truck, jack or fork lift.
- Mast extends higher than platform. Be aware of ceiling height, cable trays, sprinklers, lights, and other overhead objects.
- Do not leave LIFT TOOL machine unattended with an elevated load.
- Watch and keep hands, fingers, and clothing clear when equipment is in motion.
- Turn Winch with hand power only. If winch handle cannot be cranked easily with one hand, it is probably over-loaded. Do not continue to turn winch past top or bottom of platform travel. Excessive unwinding will detach handle and damage cable. Always hold handle when lowering, unwinding. Always assure self that winch is holding load before releasing winch handle.
- A winch accident could cause serious injury. Not for moving humans. Make certain clicking sound is heard as the equipment is being raised. Be sure winch is locked in position before releasing handle. Read instruction page before operating this winch. Never allow winch to unwind freely. Freewheeling will cause uneven cable wrapping around winch drum, damage cable, and may cause serious injury. (C048)

Power and cabling information for NEBS (Network Equipment-Building System) GR-1089-CORE

The following comments apply to the IBM servers that have been designated as conforming to NEBS (Network Equipment-Building System) GR-1089-CORE:

The equipment is suitable for installation in the following:

- Network telecommunications facilities
- Locations where the NEC (National Electrical Code) applies

The intrabuilding ports of this equipment are suitable for connection to intrabuilding or unexposed wiring or cabling only. The intrabuilding ports of this equipment *must not* be metalically connected to the interfaces that connect to the OSP (outside plant) or its wiring. These interfaces are designed for use as intrabuilding interfaces only (Type 2 or Type 4 ports as described in GR-1089-CORE) and require isolation from the exposed OSP cabling. The addition of primary protectors is not sufficient protection to connect these interfaces metalically to OSP wiring.

Note: All Ethernet cables must be shielded and grounded at both ends.

The ac-powered system does not require the use of an external surge protection device (SPD).

The dc-powered system employs an isolated DC return (DC-I) design. The DC battery return terminal *shall not* be connected to the chassis or frame ground.

The dc-powered system is intended to be installed in a common bonding network (CBN) as described in GR-1089-CORE.

Power supplies for the 8408-44E or 8408-E8E

Find information about removing and replacing power supplies in the IBM Power® System E850 (8408-44E and 8408-E8E).

Removing and replacing a power supply in the 8408-44E or 8408-E8E

Learn how to remove and replace a power supply in the 8408-44E or 8408-E8E system.

Removing and replacing a power supply in the 8408-44E or 8408-E8E system with the power turned off

Find information about removing and replacing a power supply that failed in the system or as part of another service procedure, with the system power turned off.

If your system is managed by the Hardware Management Console (HMC), use the HMC to repair a part in the system. For instructions, see “Repairing a part by using the HMC” on page 35.

If your system is not managed by an HMC, complete the following steps to remove and replace a power supply:

1. “Preparing the system to remove and replace a power supply with the power turned off.”
2. “Removing a power supply from the 8408-44E or 8408-E8E system with the power turned off” on page 5.
3. “Replacing a power supply in the 8408-44E or 8408-E8E system with the power turned off” on page 6.
4. “Preparing the system for operation after removing and replacing a power supply with the power turned off” on page 8.

Note: Removing or replacing this feature is a customer task. You can complete this task yourself, or contact a service provider to complete the task for you. You might be charged a fee by the service provider for this service.

Preparing the system to remove and replace a power supply with the power turned off

To prepare the system to remove and replace a power supply, with the system power turned off, complete the steps in this procedure.

Procedure

1. Complete the prerequisite tasks. For instructions, see “Before you begin” on page 17.
2. If applicable, open the rack door at the rear of the system.
3. Attach the electrostatic discharge (ESD) wrist strap.

Attention:

- Attach an electrostatic discharge (ESD) wrist strap to the front ESD jack, to the rear ESD jack, or to an unpainted metal surface of your hardware to prevent the electrostatic discharge from damaging your hardware.
 - When you use an ESD wrist strap, follow all electrical safety procedures. An ESD wrist strap is used for static control. It does not increase or decrease your risk of receiving electric shock when using or working on electrical equipment.
 - If you do not have an ESD wrist strap, just prior to removing the product from ESD packaging and installing or replacing hardware, touch an unpainted metal surface of the system for a minimum of 5 seconds.
4. Locate the light-emitting diodes (LEDs) on the power supplies. Four power supplies are installed in the rear of the system. Figure 1 shows the location of the power supplies in an 8408-44E or 8408-E8E system and the position of the LEDs on the power supply.

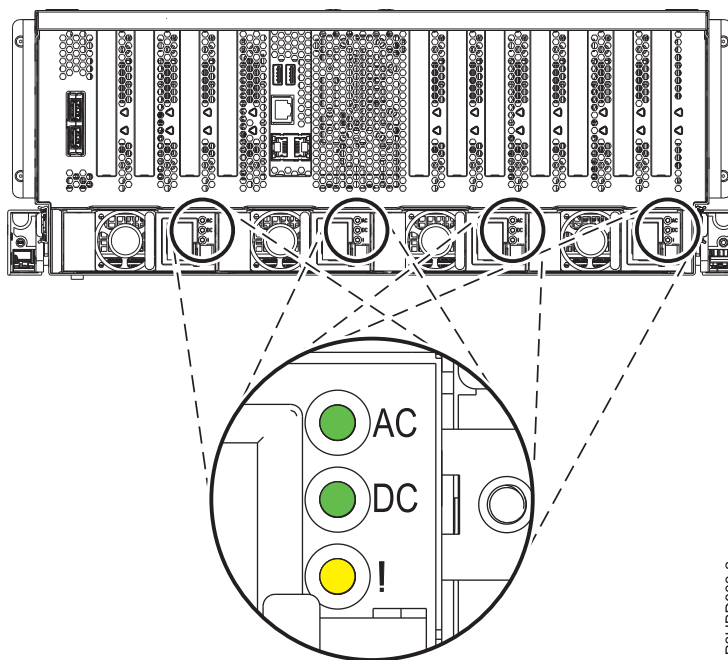

Figure 1. Location of the power supplies and LEDs in the 8408-44E or 8408-E8E system

The power supply has three LEDs that indicate the status of the power supply:

- An ac power-on LED (green)
- A dc power-on LED (green)
- An error and identify function LED (amber)

Table 1 provides the descriptions for the states of the power supply LEDs and helps to identify whether the power supplies are working or have a failure.

Table 1. Description of the power supply LED states

ac power LED (Green)	dc power LED (Green)	Error and identify LED (Amber)	Power supply status
On (Solid)	On (Solid)	Off	The power supply is operating correctly. See (B) in Figure 2 on page 3.
On (Solid)	Flashing	Off	The system is turned off, but the power supply is still connected to the power source. See (B) in Figure 2 on page 3.

Table 1. Description of the power supply LED states (continued)

ac power LED (Green)	dc power LED (Green)	Error and identify LED (Amber)	Power supply status
On (Solid)	Off	On	The power supply is not operating correctly. See (C) in Figure 2.
On (Solid)	On (Solid)	Flashing	The faulty or failed power supply was selected by using the identify function. See (D) in Figure 2.

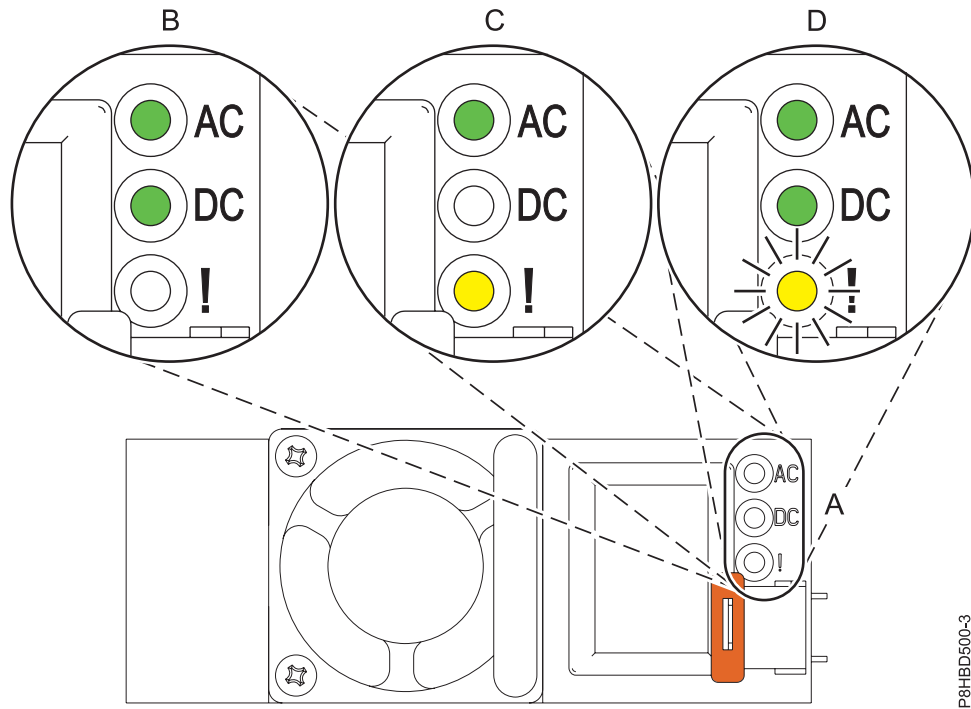
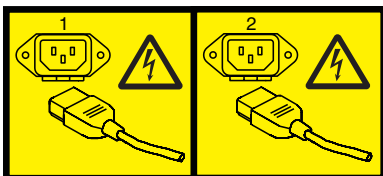

Figure 2. LEDs for a working and failed power supply

5. Identify the part and the system that you will be working on. For instructions, see “Identifying a part” on page 20.
6. Stop the system or logical partition. For instructions, see “Stopping a system or logical partition” on page 28.
7. Disconnect the power source from the system by unplugging the system. For instructions, see “Disconnecting the power cords from the system” on page 36.

Note: The system might be equipped with redundant power supply. Before you continue with this procedure, ensure that all power to your system is disconnected.

(L003)



or

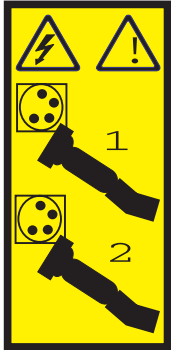

OR

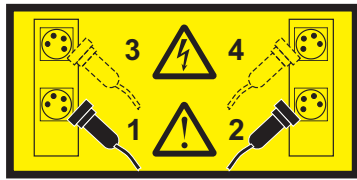

OR

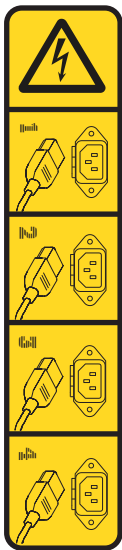

OR

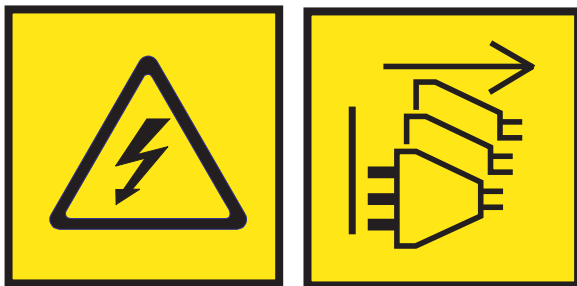

DANGER: Multiple power cords. The product might be equipped with multiple AC power cords or multiple DC power cables. To remove all hazardous voltages, disconnect all power cords and power cables. (L003)

Removing a power supply from the 8408-44E or 8408-E8E system with the power turned off

To remove a power supply from the 8408-44E or 8408-E8E system, complete the steps in this procedure.

Procedure

1. Ensure that you have the electrostatic discharge (ESD) wrist strap attached. If not, attach it now.
2. Label and disconnect the power cord from the power supply.

Attention: Do not remove the power cord from the cable-management arm.

- a. Label the power cord, and then unstrap the hook-and-loop fastener to release the power cord from the power supply handle. Refer to (D) in Figure 3 (8408-44E) or Figure 4 on page 6 (8408-E8E).
- b. Pull the end of the power cord (A) out of the power supply (C) in the direction that is shown in Figure 3 (8408-44E) or Figure 4 on page 6 (8408-E8E).
- c. Retain the hook-and-loop fastener for future use.

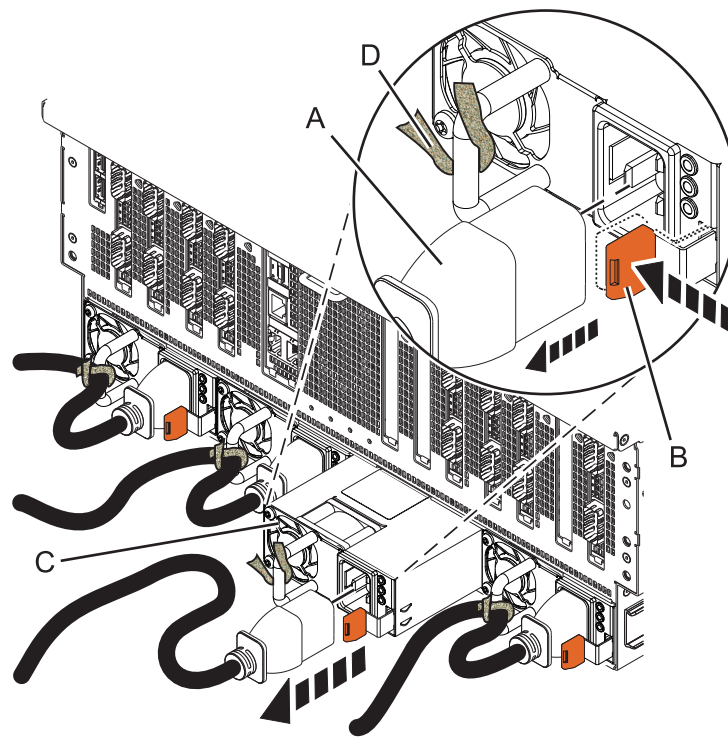

Figure 3. Removing a power supply from the 8408-44E system

P8HBD810-0

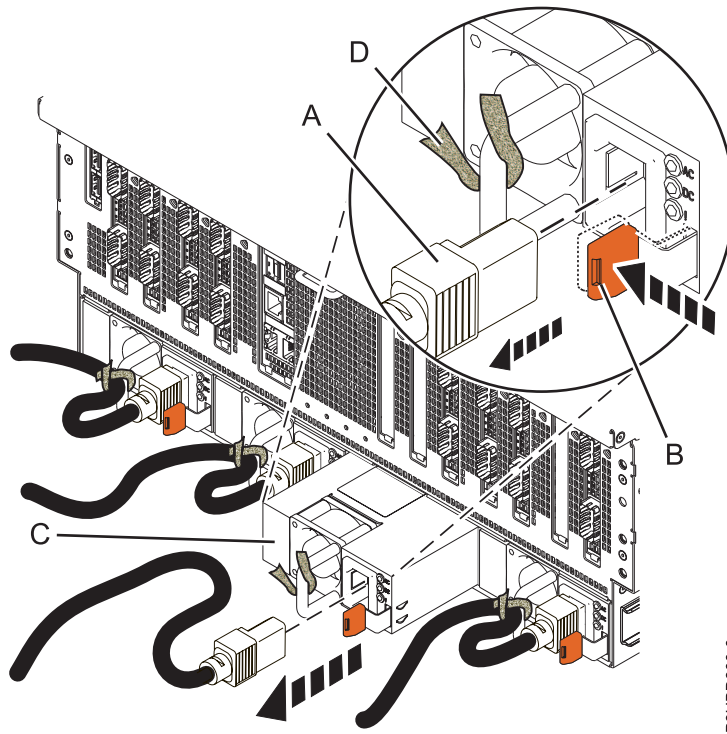

Figure 4. Removing a power supply from the 8408-E8E system

3. To unseat the power supply from its position in the system, push the terracotta locking-tab (B) in the direction shown in Figure 3 on page 5 (8408-44E) or Figure 4 (8408-E8E).
4. Pull the power supply (C) away from the system, as shown in Figure 3 on page 5 (8408-44E) or Figure 4 (8408-E8E).

Replacing a power supply in the 8408-44E or 8408-E8E system with the power turned off

To replace a power supply in the 8408-44E or 8408-E8E system, complete the steps in this procedure.

Procedure

1. Ensure that you have the electrostatic discharge (ESD) wrist strap attached. If not, attach it now.
2. Align the power supply (C) with the bay and slide the power supply into the system until the terracotta latch (B) locks in place, as shown in Figure 5 on page 7 (8408-44E) or Figure 6 on page 7 (8408-E8E).

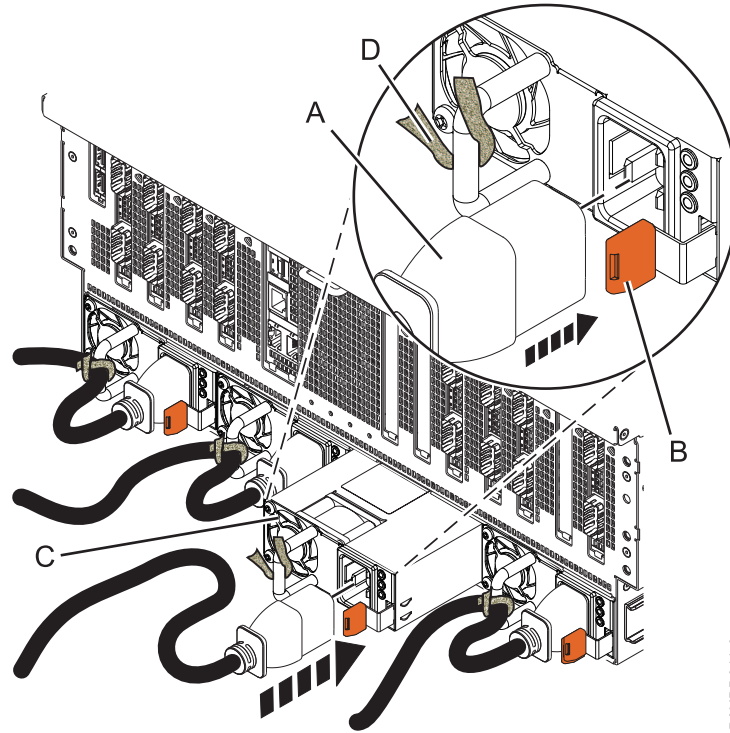

P8HBD811-0

Figure 5. Replacing a power supply in the 8408-44E system

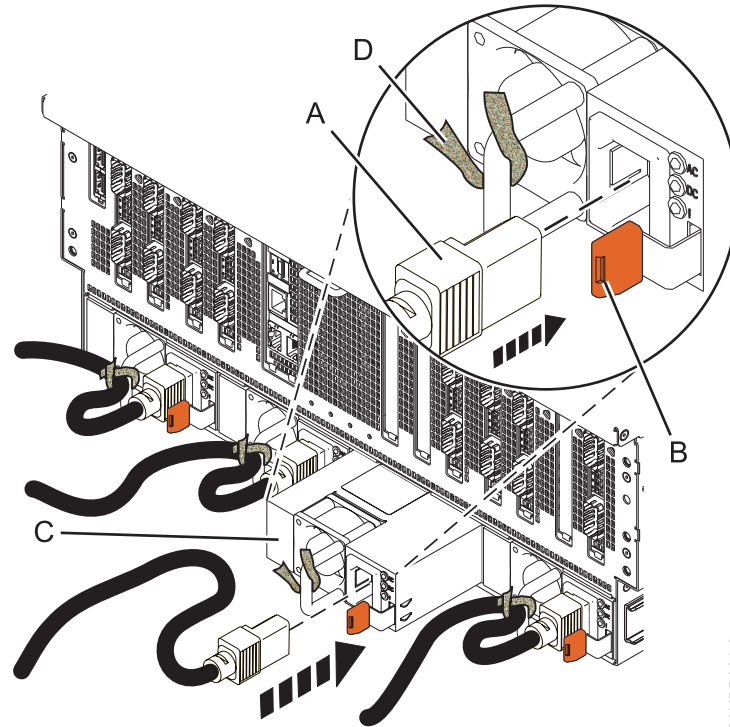

P8HBD801-0

Figure 6. Replacing a power supply in the 8408-E8E system

3. Connect the power cord (A) to the power supply (C), as shown in Figure 5 (8408-44E) or Figure 6 (8408-E8E).

4. Use the hook-and-loop fastener (D) and tie the power cord to the power supply handle, as shown in Figure 5 on page 7 (8408-44E) or Figure 6 on page 7 (8408-E8E).

Note: This system is equipped with other power supplies. Before you continue with this procedure, connect all power cords to the power supplies and strap them.

Preparing the system for operation after removing and replacing a power supply with the power turned off

To prepare the system for operation after removing and replacing a power supply, with the system power turned off, complete the steps in this procedure.

Procedure

1. Ensure that you have the electrostatic discharge (ESD) wrist strap attached. If not, attach it now.
2. Reconnect the power cords to the system. For instructions, see “Connecting the power cords to the system” on page 39.
3. If opened, close the rack door at the rear of the system.
4. Start the system or logical partition. For instructions, see “Starting the system or logical partition” on page 30.
5. Note the state of LEDs on the replaced power supply, see Figure 7. The LEDs for that power supply must be in the following state:
 - The ac power-on LED is **On** (solid).
 - The dc power-on LED is **On** (flashing).
 - The amber fault LED is **Off**.

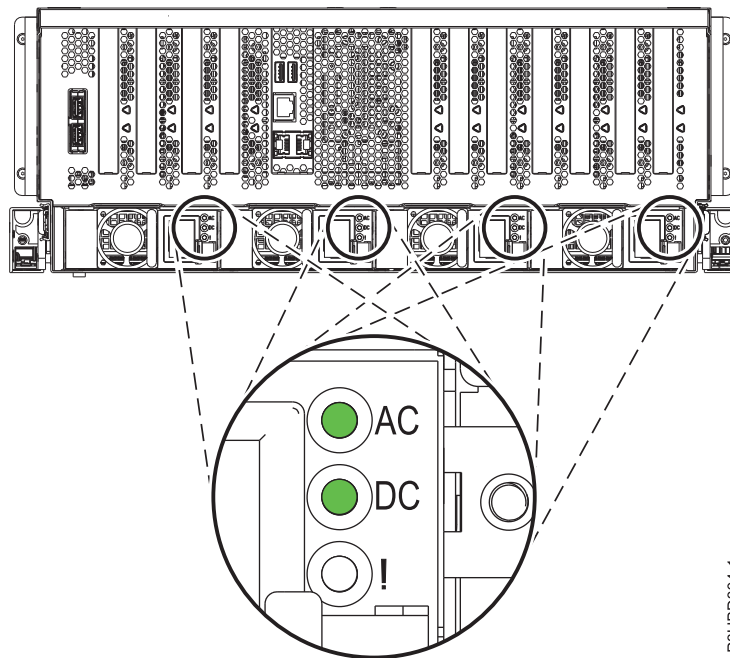

P8HBD004-1

Figure 7. LEDs for a working power supply

6. Verify the installed part.
 - If you replaced the part because of a service action, verify the installed part. For instructions, see Verifying a repair.
 - If you installed the part for any other reason, verify the installed part. For instructions, see “Verifying the installed part” on page 51.

Removing and replacing a power supply in the 8408-44E or 8408-E8E system with the power turned on

Find information about removing and replacing a power supply that failed in the system or as part of another service procedure, with the system power turned on.

If your system is managed by the Hardware Management Console (HMC), use the HMC to repair a part in the system. For instructions, see “Repairing a part by using the HMC” on page 35.

If your system is not managed by an HMC, complete the following steps to remove and replace a power supply:

1. “Preparing the system to remove and replace a power supply with the power turned on.”
2. “Removing a power supply from the 8408-44E or 8408-E8E system with the power turned on” on page 11.
3. “Replacing a power supply in the 8408-44E or 8408-E8E system with the power turned on” on page 13.
4. “Preparing the system for operation after removing and replacing a power supply with the power turned on” on page 15.

Note: Removing or replacing this feature is a customer task. You can complete this task yourself, or contact a service provider to complete the task for you. You might be charged a fee by the service provider for this service.

Preparing the system to remove and replace a power supply with the power turned on

To prepare the system to remove and replace a power supply, with the system power turned on, complete the steps in this procedure.

Procedure

1. Complete the prerequisite tasks. For instructions, see “Before you begin” on page 17.
2. If applicable, open the rack door at the rear of the system.
3. Attach the electrostatic discharge (ESD) wrist strap.

Attention:

- Attach an electrostatic discharge (ESD) wrist strap to the front ESD jack, to the rear ESD jack, or to an unpainted metal surface of your hardware to prevent the electrostatic discharge from damaging your hardware.
 - When you use an ESD wrist strap, follow all electrical safety procedures. An ESD wrist strap is used for static control. It does not increase or decrease your risk of receiving electric shock when using or working on electrical equipment.
 - If you do not have an ESD wrist strap, just prior to removing the product from ESD packaging and installing or replacing hardware, touch an unpainted metal surface of the system for a minimum of 5 seconds.
4. Locate the light-emitting diodes (LEDs) on the power supplies. The power supplies are installed in the rear of the system. Figure 8 on page 10 shows the location of the power supplies in an 8408-44E or 8408-E8E system and the position of the LEDs on the power supply.

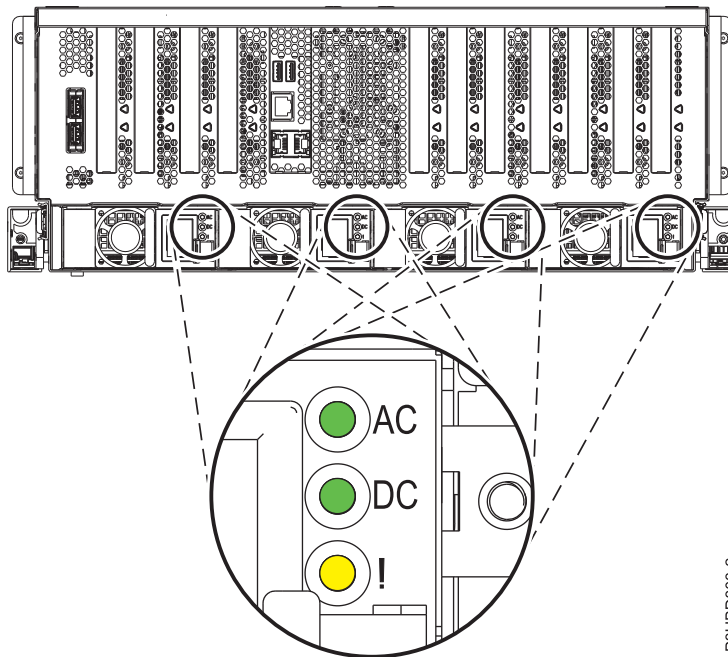

P8HED803-2

Figure 8. Location of the power supplies and LEDs in an 8408-44E or 8408-E8E system

The power supply has three LEDs that indicate the status of the power supply:

- An ac power-on LED (green)
- A dc power-on LED (green)
- An error and identify function LED (amber)

Table 2 provides the descriptions for the states of the power supply LEDs and helps to identify whether the power supplies are working or have a failure.

Table 2. Description of the power supply LED states

ac power LED (Green)	dc power LED (Green)	Error and identify LED (Amber)	Power supply status
On (Solid)	On (Solid)	Off	The power supply is operating correctly. See (B) in Figure 9 on page 11.
On (Solid)	Flashing	Off	The system is turned off, but the power supply is still connected to the power source. See (B) in Figure 9 on page 11.
On (Solid)	Off	On	The power supply is not operating correctly or has failed. See (C) in Figure 9 on page 11.
On (Solid)	On (Solid)	Flashing	The faulty or failed power supply has been selected by using the identify function. See (D) in Figure 9 on page 11.

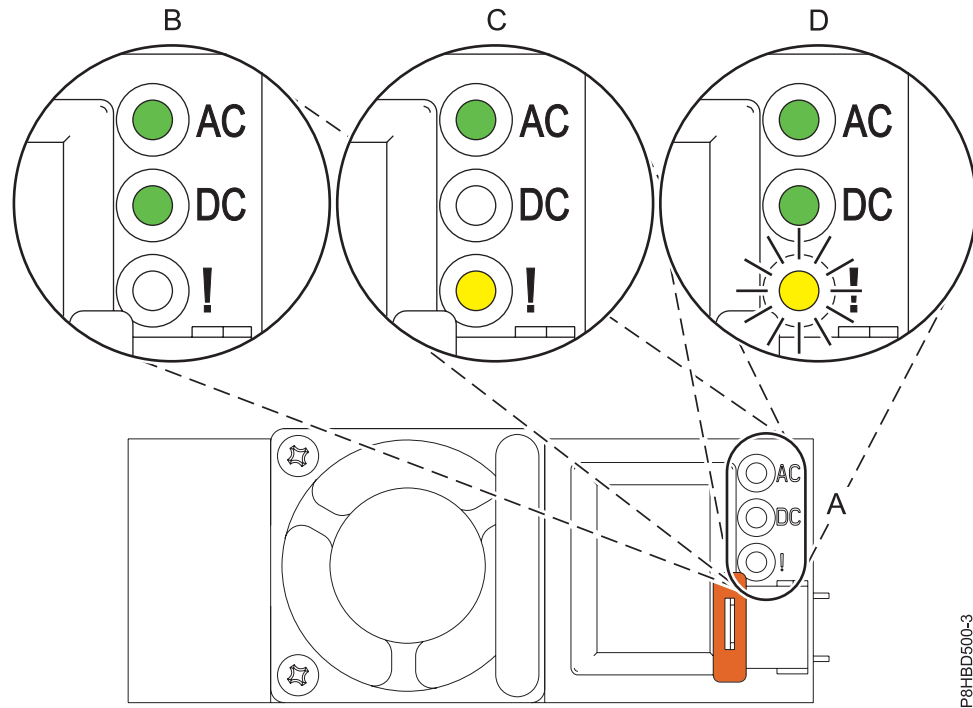

P8HBD500-3

Figure 9. LEDs for a working and failed power supply

5. Determine whether the repair can continue concurrently. To continue the repair concurrently, the following conditions must be true:
 - Power supplies must be installed in all four slots.
 - If two or less amber fault LEDs are **On**, the repair can be completed concurrently.

Attention:

- Removing and replacing the failed power supply is a time sensitive task when serviced with the system power turned on (concurrent).
 - You must replace the failed power supply within five minutes after removing the power supply from the system to avoid a system shutdown.
 - Ensure that you have read the complete procedure to remove and replace a system power supply and that you are prepared to remove and replace the power supply within this time.
6. Identify the part and the system that you will be working on. For instructions, see “Identifying a part” on page 20.
 7. Select an action.
 - To do a concurrent repair, continue the procedure with the system power turned on.
 - To do a nonconcurrent repair, see “Preparing the system to remove and replace a power supply with the power turned off” on page 1.

Note: If you do not replace the power supply within five minutes after removing the power supply from the system, the system turns off automatically.

Removing a power supply from the 8408-44E or 8408-E8E system with the power turned on

To remove a power supply from the 8408-44E or 8408-E8E system, complete the steps in this procedure.

Procedure

1. Ensure that you have the electrostatic discharge (ESD) wrist strap attached. If not, attach it now.
2. Label and disconnect the power cord from the power supply.
 - Attention:** Do not remove the power cord from the cable-management arm.
 - a. Label the power cord, and then unstrap the hook-and-loop fastener to release the power cord from the power supply handle. Refer to **(D)** in Figure 10 (8408-44E) or Figure 11 on page 13 (8408-E8E).
 - b. Pull the end of the power cord **(A)** out of the power supply **(C)** in the direction shown in Figure 10 (8408-44E) or Figure 11 on page 13 (8408-E8E).
 - c. Retain the hook-and-loop fastener for future use.

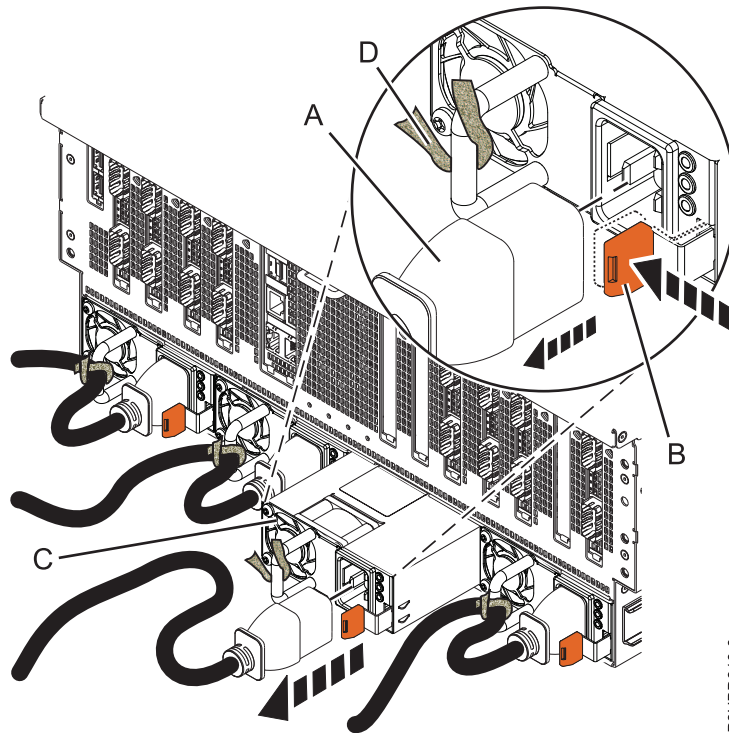

P8HBD810-0

Figure 10. Removing a power supply from the 8408-44E system

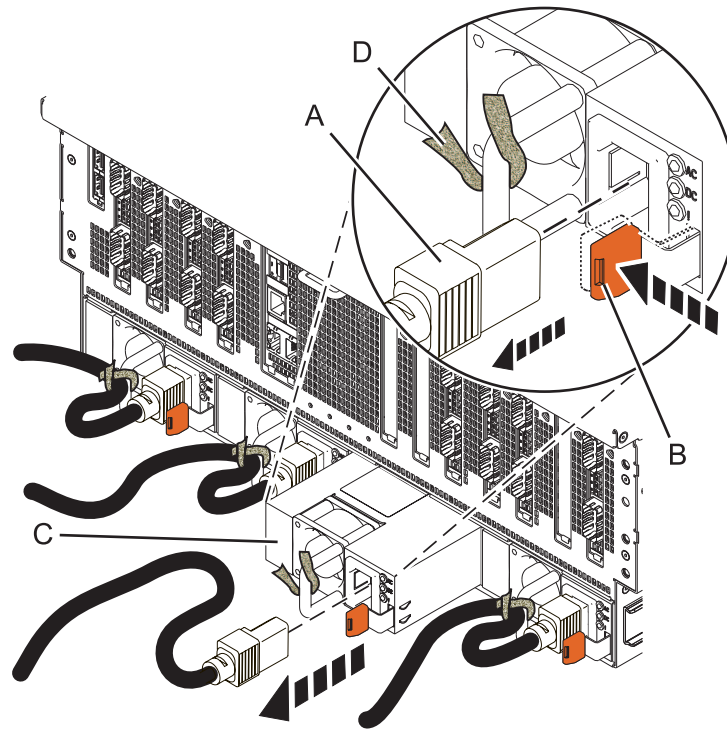

Figure 11. Removing a power supply from the 8408-E8E system

3. To unseat the power supply from its position in the system, push the terracotta locking-tab **(B)** in the direction shown in Figure 10 on page 12 (8408-44E) or Figure 11 (8408-E8E).
4. Pull the power supply **(C)** away from the system, as shown in Figure 10 on page 12 (8408-44E) or Figure 11 (8408-E8E).

Note: When you remove a power supply with the system power turned on, an error is logged. No action is required for this error.

Replacing a power supply in the 8408-44E or 8408-E8E system with the power turned on

To replace a power supply in the 8408-44E or 8408-E8E system, complete the steps in this procedure.

Procedure

1. Ensure that you have the electrostatic discharge (ESD) wrist strap attached. If not, attach it now.
2. Align the power supply **(C)** with the bay and slide the power supply into the system until the terracotta latch **(B)** locks in place, as shown in Figure 12 on page 14 (8408-44E) or Figure 13 on page 14 (8408-E8E).

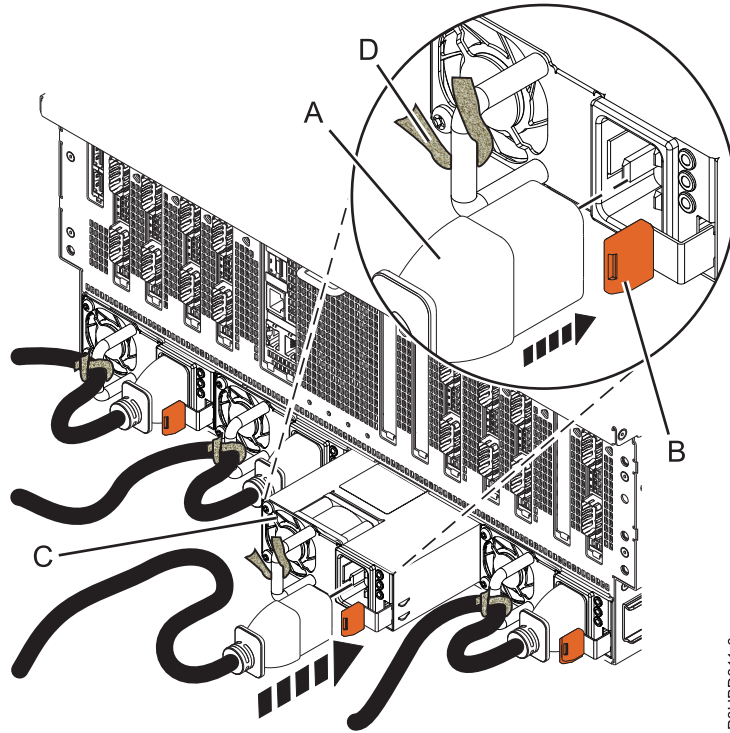

P8HBD811-0

Figure 12. Replacing a power supply in the 8408-44E system

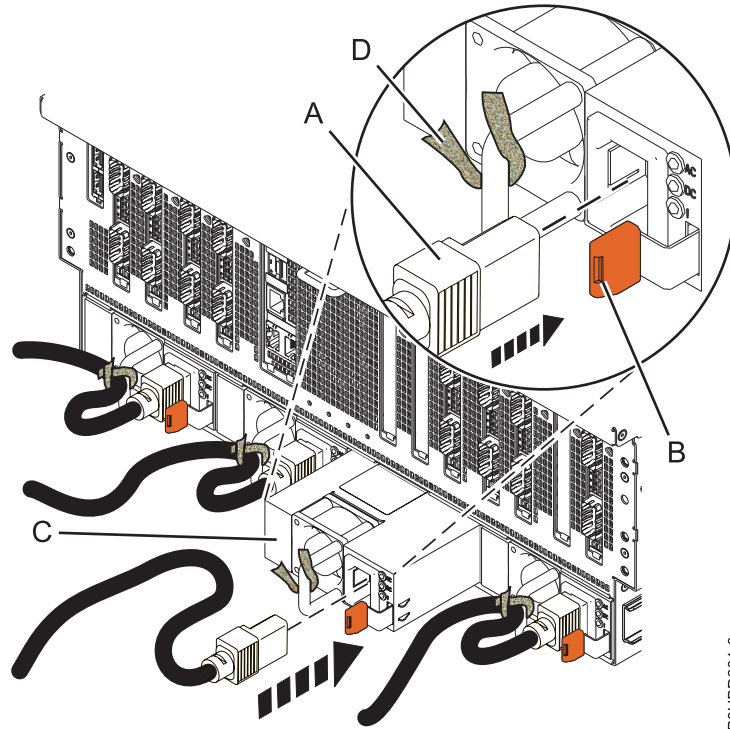

P8HBD801-0

Figure 13. Replacing a power supply in the 8408-E8E system

3. Connect the power cord (A) to the power supply (C), as shown in Figure 12 (8408-44E) or Figure 13 (8408-E8E).

4. Use the hook-and-loop fastener (D) and tie the power cord to the power supply handle, as shown in Figure 12 on page 14 (8408-44E) or Figure 13 on page 14 (8408-E8E).

Preparing the system for operation after removing and replacing a power supply with the power turned on

To prepare the system for operation after removing and replacing a power supply, with the system power turned on, complete the steps in this procedure.

Procedure

1. Ensure that you have the electrostatic discharge (ESD) wrist strap attached. If not, attach it now.
2. Turn off the identify LED. For instructions, see “Deactivating an identify LED” on page 80.
3. Note the state of LEDs on the replaced power supply, see Figure 14. The LEDs for that power supply must be in the following state:
 - The ac and dc power-on LEDs are **On** solid.
 - The amber fault LED is **Off**.

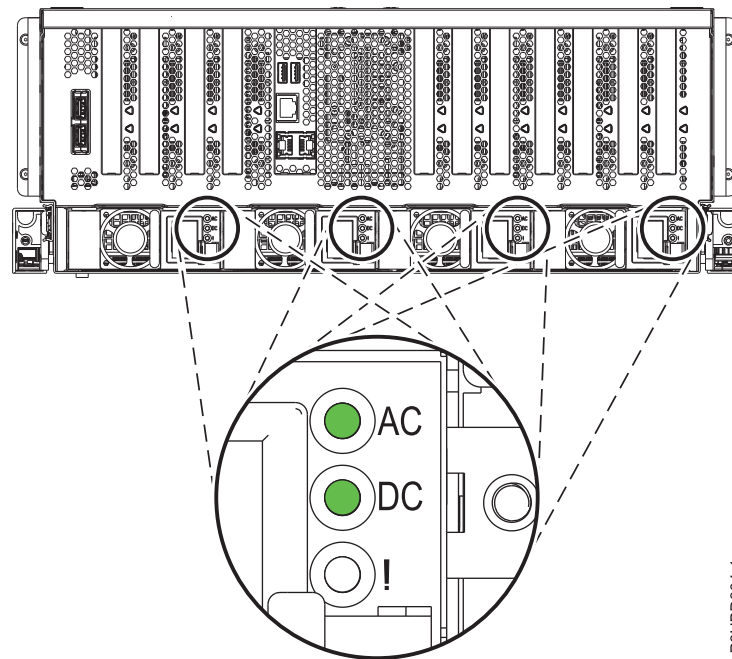

P8HBD804-1

Figure 14. LEDs for a working power supply

4. If opened, close the rack door at the rear of the system.
5. Verify the installed part.
 - If you replaced the part because of a service action, verify the installed part. For instructions, see Verifying a repair.
 - If you installed the part for any other reason, verify the installed part. For instructions, see “Verifying the installed part” on page 51.

Common procedures for removing and replacing power supplies

Find procedures that are common to removing and replacing the power supplies.

Before you begin

Observe these precautions when you are installing, removing, or replacing features and parts.

These precautions are intended to create a safe environment to service your system and do not provide steps for servicing your system. The installation, removal, and replacement procedures provide the step-by-step processes required to service your system.

DANGER: When working on or around the system, observe the following precautions:

Electrical voltage and current from power, telephone, and communication cables are hazardous. To avoid a shock hazard:

- If IBM supplied the power cord(s), connect power to this unit only with the IBM provided power cord. Do not use the IBM provided power cord for any other product.
- Do not open or service any power supply assembly.
- Do not connect or disconnect any cables or perform installation, maintenance, or reconfiguration of this product during an electrical storm.
- The product might be equipped with multiple power cords. To remove all hazardous voltages, disconnect all power cords.
 - For AC power, disconnect all power cords from their AC power source.
 - For racks with a DC power distribution panel (PDP), disconnect the customer's DC power source to the PDP.
- When connecting power to the product ensure all power cables are properly connected.
 - For racks with AC power, connect all power cords to a properly wired and grounded electrical outlet. Ensure that the outlet supplies proper voltage and phase rotation according to the system rating plate.
 - For racks with a DC power distribution panel (PDP), connect the customer's DC power source to the PDP. Ensure that the proper polarity is used when attaching the DC power and DC power return wiring.
- Connect any equipment that will be attached to this product to properly wired outlets.
- When possible, use one hand only to connect or disconnect signal cables.
- Never turn on any equipment when there is evidence of fire, water, or structural damage.
- Do not attempt to switch on power to the machine until all possible unsafe conditions are corrected.
- Assume that an electrical safety hazard is present. Perform all continuity, grounding, and power checks specified during the subsystem installation procedures to ensure that the machine meets safety requirements.
- Do not continue with the inspection if any unsafe conditions are present.
- Before you open the device covers, unless instructed otherwise in the installation and configuration procedures: Disconnect the attached AC power cords, turn off the applicable circuit breakers located in the rack power distribution panel (PDP), and disconnect any telecommunications systems, networks, and modems.

DANGER:

- Connect and disconnect cables as described in the following procedures when installing, moving, or opening covers on this product or attached devices.

To Disconnect:

1. Turn off everything (unless instructed otherwise).

2. For AC power, remove the power cords from the outlets.
3. For racks with a DC power distribution panel (PDP), turn off the circuit breakers located in the PDP and remove the power from the Customer's DC power source.
4. Remove the signal cables from the connectors.
5. Remove all cables from the devices.

To Connect:

1. Turn off everything (unless instructed otherwise).
2. Attach all cables to the devices.
3. Attach the signal cables to the connectors.
4. For AC power, attach the power cords to the outlets.
5. For racks with a DC power distribution panel (PDP), restore the power from the Customer's DC power source and turn on the circuit breakers located in the PDP.
6. Turn on the devices.

Sharp edges, corners and joints may be present in and around the system. Use care when handling equipment to avoid cuts, scrapes and pinching. (D005)

(R001 part 1 of 2):

DANGER: Observe the following precautions when working on or around your IT rack system:

- Heavy equipment—personal injury or equipment damage might result if mishandled.
- Always lower the leveling pads on the rack cabinet.
- Always install stabilizer brackets on the rack cabinet.
- To avoid hazardous conditions due to uneven mechanical loading, always install the heaviest devices in the bottom of the rack cabinet. Always install servers and optional devices starting from the bottom of the rack cabinet.
- Rack-mounted devices are not to be used as shelves or work spaces. Do not place objects on top of rack-mounted devices. In addition, do not lean on rack mounted devices and do not use them to stabilize your body position (for example, when working from a ladder).



- Each rack cabinet might have more than one power cord.
 - For AC powered racks, be sure to disconnect all power cords in the rack cabinet when directed to disconnect power during servicing.
 - For racks with a DC power distribution panel (PDP), turn off the circuit breaker that controls the power to the system unit(s), or disconnect the customer's DC power source, when directed to disconnect power during servicing.
- Connect all devices installed in a rack cabinet to power devices installed in the same rack cabinet. Do not plug a power cord from a device installed in one rack cabinet into a power device installed in a different rack cabinet.
- An electrical outlet that is not correctly wired could place hazardous voltage on the metal parts of the system or the devices that attach to the system. It is the responsibility of the customer to ensure that the outlet is correctly wired and grounded to prevent an electrical shock.

(R001 part 2 of 2):

CAUTION:

- Do not install a unit in a rack where the internal rack ambient temperatures will exceed the manufacturer's recommended ambient temperature for all your rack-mounted devices.
- Do not install a unit in a rack where the air flow is compromised. Ensure that air flow is not blocked or reduced on any side, front, or back of a unit used for air flow through the unit.

- Consideration should be given to the connection of the equipment to the supply circuit so that overloading of the circuits does not compromise the supply wiring or overcurrent protection. To provide the correct power connection to a rack, refer to the rating labels located on the equipment in the rack to determine the total power requirement of the supply circuit.
- (For sliding drawers.) Do not pull out or install any drawer or feature if the rack stabilizer brackets are not attached to the rack. Do not pull out more than one drawer at a time. The rack might become unstable if you pull out more than one drawer at a time.



- (For fixed drawers.) This drawer is a fixed drawer and must not be moved for servicing unless specified by the manufacturer. Attempting to move the drawer partially or completely out of the rack might cause the rack to become unstable or cause the drawer to fall out of the rack.

Before you begin a replacement or installation procedure, perform these tasks:

1. If you are installing a new feature, ensure that you have the software required to support the new feature. See IBM Prerequisite.
2. If you are performing an installation or replacement procedure that might put your data at risk, ensure, wherever possible, that you have a current backup of your system or logical partition (including operating systems, licensed programs, and data).
3. Review the installation or replacement procedure for the feature or part.
4. Note the significance of color on your system.

Blue or terra-cotta on a part of the hardware indicates a touch point where you can grip the hardware to remove it from or install it in the system, open or close a latch, and so on. Terra-cotta might also indicate that the part can be removed and replaced with the system or logical partition power on.

5. Ensure that you have access to a medium flat-blade screwdriver, a Phillips screwdriver, and a pair of scissors.
6. If parts are incorrect, missing, or visibly damaged, do the following:
 - If you are replacing a part, contact the provider of your parts or next level of support.
 - If you are installing a feature, contact one of the following service organizations:
 - The provider of your parts or next level of support.
 - In the United States, the IBM Rochester Manufacturing Automated Information Line (R-MAIL) at 1-800-300-8751.

In countries and regions outside of the United States, use the following website to locate your service and support telephone numbers:

<http://www.ibm.com/planetwide>

7. If you encounter difficulties during the installation, contact your service provider, your IBM reseller, or your next level of support.
8. If you are installing new hardware in a logical partition, you need to understand and plan for the implications of partitioning your system. For information, see Logical Partitioning.

Identifying a part

Learn how to identify the system or enclosure that contains a failing part, the location code and light-emitting diode (LED) status for a part, and how to activate and deactivate the identify part LED.

Note: If you are using PowerKVM, you must use the ASMI procedures to identify a part or enclosure.

Table 3. Tasks to identify a part

What you want to do	See the following information
Determine which server or enclosure contains the part	"Identifying the enclosure or server that contains the part"
Find the location of the part and determine whether the part has an identifying LED	"Finding the part location code and LED support status" on page 22
Turn on an identifying LED for a part	
If you are using PowerKVM:	"Identifying a part by using the ASMI" on page 26
If your system is in the runtime state:	"Identifying a part by using the operating system or VIOS" on page 23
If your system is in the standby power state:	"Identifying a part by using the ASMI" on page 26
If you have an HMC:	"Identifying a part by using the HMC" on page 27
Turn off an identify LED	"Deactivating an identify LED" on page 80
Turn off a check log indicator	"Deactivating a check log indicator (system information indicator) by using the ASMI" on page 83

Identifying the enclosure or server that contains the part

Learn how to determine which server or enclosure has the part you want to replace.

Enabling enclosure or server indicators with the ASMI

Find out how to enable enclosure or server indicators by using the Advanced System Management Interface (ASMI).

To perform this operation, you must have one of the following authority levels:

- Administrator
- Authorized service provider

To enable the enclosure or server indicator states, complete the following steps:

1. On the ASMI Welcome pane, specify your user ID and password, and click **Log In**.
2. In the navigation area, expand **System Configuration > Service Indicators > Enclosure Indicators**. A list of enclosures is displayed.
3. Select the enclosure and click **Continue**. A list of location codes is displayed. Alternatively, you can click **Indicators by Location Code** and type the location code in the **Location code** field.
4. In the **Identify indicator status** field, select **Identify**.
5. To save the changes made to the state of an indicator, click **Save settings**.

Control panel LEDs

Use this information as a guide to the control panel LEDs and buttons.

Use Figure 15 on page 21 with the control panel LED descriptions to understand the system status that is indicated by the control panel.

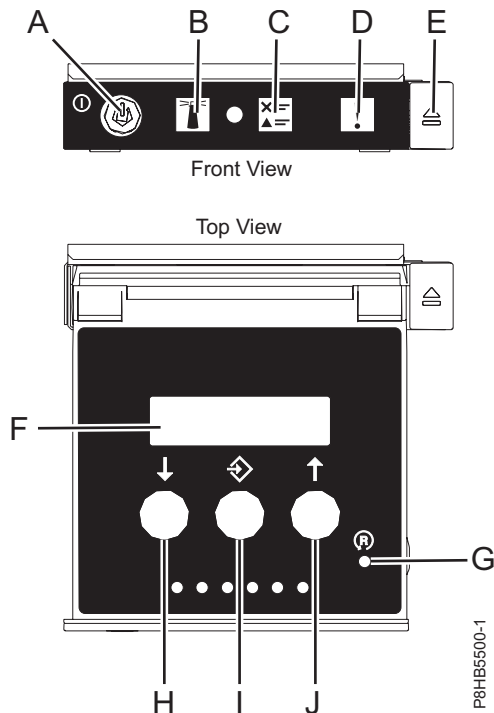

Figure 15. Control panel LEDs

Control panel LEDs and descriptions:

- **A:** Power-on button
 - A constant light indicates full system power to the unit.
 - A flashing light indicates standby power to the unit.
 - There is approximately a 30-second transition period from the time the power-on button is pressed to when the power LED goes from flashing to solid. During the transition period, the LED might flash faster.
- **B:** Enclosure identify light
 - A constant light indicates the identify state, which is used to identify a part.
 - No light indicates that the system is operating normally.
- **C:** Check log light
 - No light indicates that the system is operating normally.
 - Light on indicates that the system requires attention.
- **D:** Enclosure fault light
 - A constant light indicates a fault in the system unit.
 - No light indicates that the system is operating normally.
- **E:** Eject button
- **F:** Function/Data display
- **G:** Pinhole reset button
- **H:** Decrement button
- **I:** Enter button
- **J:** Increment button

Activating an identify LED for an enclosure or server by using the HMC

Learn how to activate an identify LED for an enclosure or server by using the Hardware Management Console (HMC).

The system provides several LEDs that help identify various components in the system, such as enclosures or field-replaceable units (FRUs). For this reason, they are called *identify LEDs*.

If you want to add a part to a specific enclosure or server, you need to know the machine type, model, and serial number (MTMS) of the enclosure or server. To determine whether you have the correct MTMS for the enclosure or server that needs the new part, you can activate the LED for an enclosure or server and verify that the MTMS corresponds to the enclosure or server that requires the new part.

1. Choose one of the following navigation options depending on the interface type of the HMC:
 - If you are using an HMC Classic or HMC Enhanced interface, complete the following steps:
 - a. In the navigation area, click **Systems Management > Servers**.
 - b. In the content pane, select the server.
 - c. Click **Tasks > Operations > LED Status > Identify LED**. The Identify LED, Select Enclosure window is displayed.
 - If you are using an HMC Enhanced + Tech Preview (Pre-GA) or HMC Enhanced+ interface, complete the following steps:



- a. In the navigation area, click the **Resources** icon  , and then click **All Systems**.
 - b. Click the server name for which you want to activate the identify LED.
 - c. Click **System Actions > Attention LED > Identify Attention LED**. The Identify Attention LED, Select Enclosure window is displayed.
2. To activate an identify LED for an enclosure or server, select an enclosure or server and then click **Activate LED**. The associated LED is turned on.

Finding the part location code and LED support status

You can use location codes for the server you are working with to find the part location code and whether there is Identify LED support.

To find the location code and to determine if there is identify LED support, complete the following steps:

1. Select the server you are working on to see the location codes:
 - 5148-21L, 5148-22L, 8247-21L, 8247-22L, 8284-21A, or 8284-22A locations (http://www.ibm.com/support/knowledgecenter/POWER8/p8ecs/p8ecs_83x_8rx_loccodes.htm)
 - 8247-42L, 8286-41A, or 8286-42A locations (http://www.ibm.com/support/knowledgecenter/POWER8/p8ecs/p8ecs_82x_84x_loccodes.htm)
 - 8408-44E or 8408-E8E locations(http://www.ibm.com/support/knowledgecenter/POWER8/p8ecs/p8ecs_85x_loccodes.htm)
 - 9080-MHE, 9080-MME, 9119-MHE, or 9119-MME locations(http://www.ibm.com/support/knowledgecenter/POWER8/p8ecs/p8ecs_87x_88x_loccodes.htm)
2. Record the location code.
3. Refer to the field replaceable unit (FRU) location table, Identify LED column to see if the word **Yes** (there is an identify LED) or **No** (there is not an identify LED) appears.
4. Select from the following options:
 - If the part has an identify LED, refer to the applicable procedure:
 - If you are using IBM PowerKVM, see “Identifying a part by using the ASMI” on page 26.
 - If your system is at runtime state, see “Identifying a part by using the operating system or VIOS” on page 23.
 - If your system is at standby power state, see “Identifying a part by using the ASMI” on page 26.
 - If the part does not have an identify LED, see Identifying the enclosure or server that contains the part.

Identifying a part by using the operating system or VIOS

Learn how to use AIX®, IBM i, Linux, or the Virtual I/O Server (VIOS) to identify a part.

For IBM Power Systems™ that contain the POWER8® processor, the identify LEDs can be used to identify or verify the location of a part that you intend to install, remove, or replace. The identify function (flashing the amber LED) corresponds to the location code you are going to work with.

When you are removing a part, first verify whether you are working on the correct part by using the identify function in the management console or other user interface. When you remove a part by using the Hardware Management Console (HMC), the identify function is activated and deactivated automatically at the correct times.

The identify function causes the amber LED to flash. When you turn off the identify function, the LED returns to the state it was previously. For parts that have a blue service button, the identify function sets LED information for the service button so that when the button is pressed, the correct LEDs on that part flash.

Note: Use the enclosure locate LED to identify the enclosure that is being serviced. Then, confirm and verify the location of the FRU (to be serviced) in the enclosure by checking the active identify indicator (flashing LED) for the selected FRU. For some FRUs, you might need to remove the service access cover to be able to see the identify indicators.

Identifying a part in an AIX system or logical partition

Use these instructions to learn how to locate a part, activate the indicator light for the part, and deactivate the indicator light for the part on a system or logical partition running the AIX operating system.

Finding the location code for a part in an AIX system or logical partition:

You might need to use AIX tools, before activating the indicator light, to locate a part.

To configure the AIX system to locate a part, complete the following steps:

1. Log in as root user or celogin-.
2. At the command line, type `diag` and press Enter.
3. From the Function Selection menu, select **Task Selection** and press Enter.
4. Select **Display Previous Diagnostic Results** and press Enter.
5. From the Display Previous Diagnostic Results display, select **Display Diagnostic Log Summary**. The Display Diagnostic Log display shows a chronological list of events.
6. Look in the **T** column for the most recent **S** entry. Select this row in the table and press Enter.
7. Select **Commit**. The details of this log entry are shown.
8. Record the location information and the SRN value that is shown near the end of the entry.
9. Exit to the command line.

Use the location information for the part to activate the indicator light that identifies the part. See “Activating the indicator light for a part by using AIX diagnostics.”

Activating the indicator light for a part by using AIX diagnostics:

Use these instructions to help physically identify the location of a part you are servicing.

To activate the indicator light for a part, complete the following steps:

1. Log in as root user.
2. At the command line, type `diag` and press Enter.

3. From the **Function Selection** menu, select **Task Selection** and press Enter.
4. From the **Task Selection** menu, select **Identify and Attention Indicators** and press Enter.
5. From the list of lights, select the location code for the part and press Enter.
6. Select **Commit**. This turns on the system attention and indicator light for the part.

Important: A flashing amber LED indicates the location of the part and a solid amber LED indicates that the part is failing.

7. Exit to the command line.

Identifying a part in an IBM i system or logical partition

You can activate or deactivate the indicator light to locate a part in an IBM i system or logical partition.

Finding the location code and activating the indicator light for a part by using the IBM i operating system:

You can search the service action log for an entry that matches the time, reference code, or resource of a problem, and then activate the indicator light for a part.

1. Sign on to an IBM i session, **with at least service level authority**.
2. On the command line of the session, type `strsst` and press Enter.

Note: If you cannot get to the System Service Tools (SST) display, use function 21 from the control panel. Alternatively, if the system is managed by a Hardware Management Console (HMC), use the Service Focal Point utilities to get to the Dedicated Service Tools (DST) display.

3. Type your service tools user ID and service tools password on the System Service Tools (SST) Sign On display and press Enter.

Remember: The service tools password is case sensitive.

4. Select **Start a service tool** from the System Service Tools (SST) display and press Enter.
5. Select **Hardware service manager** from the Start a Service Tool display and press Enter.
6. Select **Work with service action log** from the Hardware Service Manager display and press Enter.
7. On the Select Timeframe display, change the **From: Date and Time** field to a date and time prior to when the problem occurred.
8. Search for an entry that matches one or more conditions of the problem:
 - System reference code
 - Resource
 - Date and time
 - Failing item list
9. Select option 2 (Display failing item information) to display the service action log entry.
10. Select option 2 (Display details) to display location information for the failing part to be replaced. The information displayed in the date and time fields is the date and time for the first occurrence of the specific system reference code for the resource displayed during the time range selected.
11. If location information is available, select option 6 (Indicator on) to turn on the indicator light for the part.

Tip: If the part does not contain a physical indicator light, a higher-level indicator light is activated. For example, the indicator light for the backplane or unit that contains the part might be lit. In this case, use the location information to locate the actual part.

12. Look for the enclosure indicator light to locate the enclosure that contains the part.

Important: A flashing amber LED indicates the location of the part and a solid amber LED indicates that the part is failing.

Identifying a part in a Linux system or logical partition

If the service aids have been installed on a system or logical partition, you can activate or deactivate the indicator lights to locate a part or complete a service action.

Finding the location code of a part in a Linux system or logical partition:

Use this procedure to retrieve the location code of the part to perform service operations.

To find the location code of a part in a Linux system or logical partition, complete the following steps:

1. Log in as root user.
2. At the command line, type `grep diagela /var/log/platform` and press Enter.
3. Look for the most recent entry that contains a system reference code (SRC).
4. Record the location information.

Related information:

 Service and productivity tools for PowerLinux servers from IBM
IBM provides hardware diagnostic aids and productivity tools, and installation aids for Linux operating systems on IBM Power Systems servers.

Activating the indicator light for a part by using the Linux operating system:

If you know the location code of a part, activate the indicator light to help locate the part the while performing service operations.

To activate the indicator light, complete the following steps:

1. Log in as root user.
2. At the command line, type `/usr/sbin/usysident -s identify -l location_code` and press Enter.
3. Look for the system attention light to identify the enclosure that contains the part.

Important: A flashing amber LED indicates the location of the part and a solid amber LED indicates that the part is failing.

Related information:

 Service and productivity tools for Linux on Power servers
IBM provides hardware diagnostic aids and productivity tools, and installation aids for Linux operating systems on IBM Power Systems servers.

Identifying a part in a VIOS system or logical partition

Learn how to find the location code and identify a part by using the Virtual I/O Server (VIOS) tools.

Finding the location code of a part in a VIOS system or logical partition:

You can use Virtual I/O Server (VIOS) tools to find the location code of a part before you activate the indicator light.

To configure the Virtual I/O Server system for identifying a part, complete the following steps:

1. Log in as root user or `celogin-`.
2. At the command line, type `diagmenu` and press Enter.
3. From the **Function Selection** menu, select **Task Selection** and press Enter.
4. Select **Display Previous Diagnostic Results** and press Enter.
5. From the **Display Previous Diagnostic Results** display, select **Display Diagnostic Log Summary**. A **Display Diagnostic Log** display appears. This display contains a chronological list of events.
6. Look in the **T** column for the most recent **S** entry. Select this row in the table and press Enter.

7. Choose **Commit**. The details of this log entry are shown.
8. Record the location information and the SRN value shown near the end of the entry.
9. Exit to the command line.

Use the location information for the part to activate the indicator light that identifies the part. For instructions, see “Activating the indicator light for a part by using the VIOS tools.”

Activating the indicator light for a part by using the VIOS tools:

You can use Virtual I/O Server (VIOS) tools to activate the indicator light to physically locate a part.

To turn on the indicator light for identifying a part, complete the following steps:

1. Log in as root user.
2. At the command line, type `diagmenu` and press Enter.
3. From the **Function Selection** menu, select **Task Selection** and press Enter.
4. From the **Task Selection** menu, select **Identify and Attention Indicators** and press Enter.
5. From the list of lights, select the location code for the failing part and press Enter.
6. Select **Commit**. This turns on the system attention and indicator light for the part.

Important: A flashing amber LED indicates the location of the part and a solid amber LED indicates that the part is failing.

7. Exit to the command line.

Identifying a part by using the ASMI

Learn how to activate or deactivate amber identify indicator light-emitting diodes (LEDs) by using the Advanced System Management Interface (ASMI).

You can access the ASMI by using a web browser. For more information, see [Accessing the Advanced System Management Interface by using a web browser \(http://www.ibm.com/support/knowledgecenter/POWER8/p8ect/p8ect_browser.htm\)](http://www.ibm.com/support/knowledgecenter/POWER8/p8ect/p8ect_browser.htm).

For IBM Power Systems that contain the POWER8 processor, the identify LEDs can be used to identify or verify the location of a part that you intend to install, remove, or replace. The identify function (flashing the amber LED) corresponds to the location code you are going to work with.

You can set the identify LED to flash and to stop flashing by using the ASMI.

Note: You can use the ASMI to turn on and turn off the identify indicators except for the adapters, disk drives, solid-state drives, and media devices.

Activating the identify LED by using the ASMI when you know the location code

Learn how to activate the identify LED by using the Advanced System Management Interface (ASMI) when you know the location code.

You can specify the location code of any indicator to view or modify its current state. If you provide the wrong location code, the ASMI attempts to go to the next higher level of the location code.

The next level is the base-level location code for that field replaceable unit (FRU). For example, a user types the location code for the FRU located on the second memory module slot of the third enclosure in the system. If the location code for the second memory module slot is incorrect (the FRU does not exist at this location), an attempt to set the indicator for the third enclosure is initiated. This process continues until a FRU is located or no other level is available.

To complete this operation, your authority level must be one of the following levels:

- Administrator
- Authorized service provider

To change the current state of an indicator, complete the following steps:

1. On the ASMI Welcome pane, specify your user ID and password, and click **Log In**.
2. In the navigation area, expand **System Configuration > Service Indicators > Indicators by Location code**.
3. In the **Location code** field, type the location code of the FRU and click **Continue**.
4. From the **Identify indicator status** list, select **Identify**.
5. Click **Save settings**.

Activating the identify LED by using the ASMI when you do not know the location code

Learn how to activate the identify LED by using the Advanced System Management Interface (ASMI) when you do not know the location code.

You can turn on the identify indicators in each enclosure.

To complete this operation, your authority level must be one of the following levels:

- Administrator
- Authorized service provider

To enable the enclosure indicator states, complete the following steps:

1. On the ASMI Welcome pane, specify your user ID and password, and click **Log In**.
2. In the navigation area, expand **System Configuration > Service Indicators > Enclosure Indicators**. All servers and enclosures managed by the ASMI will display.
3. Select the server or enclosure with the part that needs to be replaced and click **Continue**. The location code identifiers are listed.
4. Select the location code identifier and select **Identify**.
5. To save the changes made to the state of one or more FRU indicators, click **Save settings**.

Identifying a part by using the HMC

You can use the following procedures to activate light-emitting diodes (LEDs) by using the Hardware Management Console (HMC).

You can use the identify LED for a FRU associated with a specified enclosure to help you identify a part. For example, if you want to hook up a cable to a specific I/O adapter, you can activate the LED for the adapter, which is a field replaceable unit (FRU). Then, you can physically check to see where you should hook up the cable. This action is especially useful when you have several adapters with open ports.

1. Choose one of the following navigation options depending on the interface type of the HMC:
 - If you are using an HMC Classic or HMC Enhanced interface, complete the following steps:
 - a. In the navigation area, click **Systems Management > Servers**.
 - b. Select the server that you are working on.
 - c. In the **Tasks** menu, click **Operations > LED status > Identify LED**. The **Identify LED, Select Enclosure** window is displayed.
 - If you are using an HMC Enhanced + Tech Preview (Pre-GA) or HMC Enhanced+ interface, complete the following steps.



- a. In the navigation area, click the **Resources** icon  , and then click **All Systems**.
 - b. Click the system name for which you want to activate the attention LED.
 - c. In the navigation area, click **System Actions > Attention LED > Identify Attention LED**. The Identify LED, Select Enclosure window is displayed.
2. To activate an identify LED for the enclosure, select an enclosure and then click **Activate LED**. The associated LED is turned on and is flashing.
 3. To activate an identify LED for one or more FRUs in the enclosure, complete the following steps:
 - a. Select an enclosure and then click **List FRUs**.
 - b. Select the FRUs for which you want to activate the identify LED and click **Activate LED**. The associated LED is turned on and is flashing.

Stopping a system or logical partition

Learn how to stop a system or logical partition as a part of a system upgrade or service action.

Attention: Using either the power-on button on the control panel or entering commands at the Hardware Management Console (HMC) to stop the system can cause unpredictable results in the data files. Also, the next time you start the system, it might take longer if all applications are not ended before stopping the system.

To stop the system or logical partition, select the appropriate procedure.

Stopping a system that is not managed by an HMC

You might need to stop the system to complete another task. If your system is not managed by the Hardware Management Console (HMC), use these instructions to stop the system by using the power button or the Advanced System Management Interface (ASMI).

Before you stop the system, follow these steps:

1. Ensure that all jobs are completed and end all applications.
2. If a Virtual I/O Server (VIOS) logical partition is running, ensure that all clients are shut down or that the clients have access to their devices by using an alternative method.

Stopping a system by using the control panel

You might need to stop the system to complete another task. If your system is not managed by the Hardware Management Console (HMC), use these instructions to stop the system by using the power button.

The following procedure describes how to stop a system that is not managed by the HMC.

1. Log in to the host partition as a user with the authority to run the **shutdown** or **pwrdownsys** (Power Down System) command.
2. At the command line, enter one of the following commands:
 - If your system is running the AIX operating system, type **shutdown**.
 - If your system is running the Linux operating system, type **shutdown -h now**.
 - If your system is running the IBM i operating system, type **PWRDWNSYS**. If your system is partitioned, use the **PWRDWNSYS** command to power down each of the secondary partitions. Then, use the **PWRDWNSYS** command to power down the primary partition.

The command stops the operating system. The system power turns off, the power-on light begins to slowly flash, and the system goes into a standby state.

3. Record the IPL type and the IPL mode from the control panel display to help you return the system to this state when the installation or replacement procedure is completed.
4. Set the power switches of any devices that are connected to the system to off.

Stopping a system by using the ASMI

You might need to stop the system to complete another task. If your system is not managed by the Hardware Management Console (HMC), use these instructions to stop the system by using the Advanced System Management Interface (ASMI).

To stop a system by using the ASMI, complete the following steps:

1. On the ASMI Welcome pane, specify your user ID and password, and click **Log In**.
2. In the navigation area, click **Power/Restart Control > Power On/Off System**. The power state of the system is displayed.
3. Specify the settings as required and click **Save setting and power off**.

Stopping a system by using the HMC

You can use the Hardware Management Console (HMC) to stop the system or logical partition.

By default, the managed system is set to power off automatically when you shut down the last running logical partition on the managed system. If you set the managed system properties on the HMC so that the managed system does not power off automatically, you must use this procedure to power off your managed system.

Attention: Ensure that you shut down the running logical partitions on the managed system before you power off the managed system. Powering off the managed system without shutting down the logical partitions first causes the logical partitions to shut down abnormally and can cause data loss. If you use a Virtual I/O Server (VIOS) logical partition, ensure that all clients are shut down or that the clients have access to their devices by using an alternative method.

To power off a managed system, you must be a member of one of the following roles:

- Super administrator
- Service representative
- Operator
- Product engineer

Note: If you are a product engineer, verify that the customer has shut down all active partitions and has powered off the managed system. Continue with the procedure only after the status of the server changes to **Power Off**.

Stopping a system by using the HMC Classic or HMC Enhanced interface

Learn how to stop a system by using the HMC Classic or HMC Enhanced interface.

To stop the system or logical partition by using the HMC Classic or HMC Enhanced interface, complete the following steps:

1. In the navigation area, click **Systems Management > Servers**.
2. In the content pane, select the managed system.
3. In the Tasks area, click **Operations > Power Off**.
4. Select the appropriate power-off mode and click **OK**.

Related information:

 Shutting down and restarting logical partitions

Stopping a system by using the HMC Enhanced + Tech Preview (Pre-GA) or HMC Enhanced+ interface

Learn how to stop a system by using the HMC Enhanced + Tech Preview (Pre-GA) or HMC Enhanced+ interface.

To stop the system or logical partition by using the HMC Enhanced + Tech Preview (Pre-GA) or HMC Enhanced+ interface, complete the following steps:

1. You must deactivate all the active logical partitions before powering off the system. To deactivate logical partitions for a specific system, complete the following steps:



- a. In the navigation area, click the **Resources** icon , and then click **All Systems**.
 - b. Click the system name for which you want to deactivate partitions.
 - c. Select the logical partitions that you want to deactivate.
 - d. In the content pane, click **Actions > Deactivate**.
 - e. Click **OK**.
2. To power off the system, complete the following steps:



- a. In the navigation area, click the **Resources** icon , and then click **All Systems**.
- b. Select the system that you want to power off.
- c. In the content pane, click **Actions > View All Actions > Power Off**.
- d. Click **OK**.

Stopping an IBM PowerKVM system

You can use the Intelligent Platform Management Interface (IPMI) to stop an IBM PowerKVM system.

To stop an IBM PowerKVM system, complete the following steps:

1. Log in to the host as a root user or with sudo authority.
2. To power off each of the guests, complete the following steps.
 - a. To obtain a list of all guests, type **virsh list**.
 - b. For each guest in the list, type **virsh shutdown domain name** or type **virsh shutdown domain ID**.

Note:

Type **virsh list** to verify whether all the guests are powered off. If any guest is not powered off, type **virsh destroy domain name** or type **virsh destroy domain ID** to power off the guest.

3. Run the **ipmitool -I lanplus -H FSP IP -P ipmipassword chassis power off** command from a remote system.

Starting the system or logical partition

Learn how to start a system or logical partition after performing a service action or system upgrade.

Starting a system that is not managed by an HMC

You can use the power button or the Advanced System Management Interface (ASMI) to start a system that is not managed by a Hardware Management Console (HMC).

Starting a system by using the control panel

You can use the power button on the control panel to start a system that is not managed by a Hardware Management Console (HMC).

To start a system by using the control panel, complete the following steps:

1. Open the front rack door, if necessary.
2. Before you press the power button on the control panel, ensure that power is connected to the system unit as follows:
 - All system power cables are connected to a power source.
 - The power LED, as shown in the following figure, is slowly flashing.
 - The top of the display, as shown in the following figure, shows 01 V=F.
3. Press the power button (A), as shown in the following figure, on the control panel.

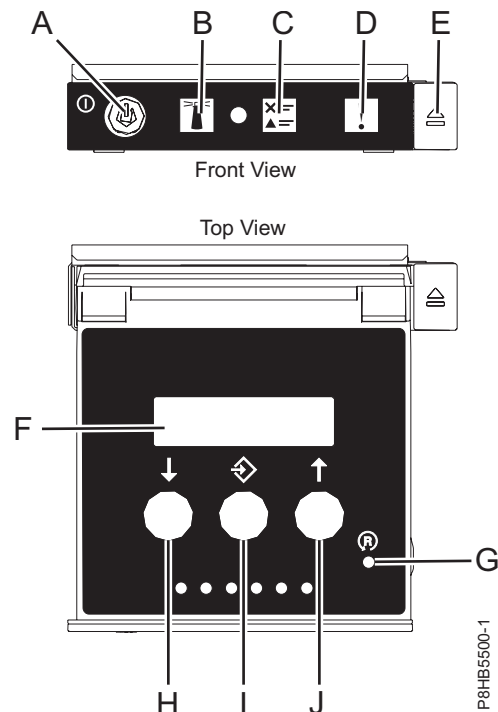

Figure 16. Control panel

- **A:** Power-on button
 - A constant light indicates full system power to the unit.
 - A flashing light indicates standby power to the unit.
 - There is approximately a 30-second transition period from the time the power-on button is pressed to when the power LED goes from flashing to solid. During the transition period, the LED might flash faster.
- **B:** Enclosure identify light
 - A constant light indicates the identify state, which is used to identify a part.
 - No light indicates that the system is operating normally.
- **C:** System information light
 - No light indicates that the system is operating normally.
 - Light on indicates that the system requires attention.
- **D:** Enclosure fault roll-up light

- A constant light indicates a fault in the enclosure.
 - No light indicates that the system is operating normally.
 - **E:** Eject button
 - **F:** Function/Data display
 - **G:** Pinhole reset button
 - **H:** Decrement button
 - **I:** Enter button
 - **J:** Increment button
4. Observe the following aspects after pressing the power button:
- The power-on light begins to flash faster.
 - The system cooling fans are activated after approximately 30 seconds and begin to accelerate to operating speed.
 - Progress indicators, also referred to as checkpoints, appear on the control panel display while the system is being started. The power-on light on the control panel stops flashing and remains on, indicating that the system power is on.

Tip: If pressing the power button does not start the system, then contact your next level of support or your service provider.

Starting a system by using the ASMI

You can use the Advanced System Management Interface (ASMI) to start a system that is not managed by a Hardware Management Console (HMC).

To start a system by using the ASMI, complete the following steps:

1. On the ASMI Welcome pane, specify your user ID and password, and click **Log In**.
2. In the navigation area, click **Power/Restart Control > Power On/Off System**. The power state of the system is displayed.
3. Specify the settings as required and click **Save setting and power on**.

Starting a system or logical partition by using the HMC

You can use the Hardware Management Console (HMC) to start the system or logical partition after the required cables are installed and the power cables are connected to a power source.

Starting a system or logical partition by using the HMC Classic or HMC Enhanced interface

Learn how to start a system or logical partition by using the HMC Classic or HMC Enhanced interface.

To start the system by using the HMC Classic or HMC Enhanced interface, complete the following steps:

1. Verify that the logical partition start policy is set to **User-Initiated** by completing the following steps:
 - a. In the navigation area, expand **Systems Management > Servers**.
 - b. In the content pane, select the managed system.
 - c. In the Tasks area, click **Properties**.
 - d. Click the **Power-On Parameters** tab. Ensure that the **Partition start policy** field is set to **User-Initiated**.
2. Power on the managed system by completing the following steps:
 - a. In the navigation area, expand **Systems Management > Servers**.
 - b. In the content pane, select the managed system.
 - c. Click **Operations > Power on**.
 - d. Select the power-on option and click **OK**.

Starting a system or logical partition by using the HMC Enhanced + Tech Preview (Pre-GA) or HMC Enhanced+ interface

Learn how to start a system or logical partition by using the HMC Enhanced + Tech Preview (Pre-GA) or HMC Enhanced+ interface.

To start a system or logical partition by using the HMC Enhanced + Tech Preview (Pre-GA) or HMC Enhanced+ interface, complete the following steps:

1. To power on the managed system, complete the following steps:



- a. In the navigation area, click the **Resources** icon  , and then click **All Systems**.
- b. Select the system that you want to power on.
- c. In the content pane, click **Actions > View All Actions > Power On**.
- d. Click **OK**.

2. To activate a logical partition, complete the following steps:



- a. In the navigation area, click the **Resources** icon  , and then click **All Partitions**.
- b. Click the logical partition name that you want to activate.
- c. In the navigation area, click **Partition Actions > Operations > Activate**.
- d. Click **OK**.

3. To activate a logical partition for a specific system, complete the following steps:



- a. In the navigation area, click the **Resources** icon  , and then click **All Systems**.
- b. Click the system name in which you want to activate the logical partition.
- c. Select logical partitions that you want to activate.
- d. In the content pane, click **Actions > Activate**.
- e. Click **OK**.

4. To verify that the logical partition start policy is set to **User-Initiated**, complete the following steps:



- a. In the navigation area, click the **Resources** icon  , and then click **All Systems**.
- b. Click the system name to view details.
- c. In the navigation area, click **Properties > Other Properties**.
- d. Click the **Power-On Parameters** tab. Ensure that the **Partition start policy** field is set to **User-Initiated**.

Starting an IBM PowerKVM system

You can use the Intelligent Platform Management Interface (IPMI) to start an IBM PowerKVM system.

To start an IBM PowerKVM system, run the `ipmitool -I lanplus -H FSP IP -P ipmipassword chassis power on` command from a remote system.

Installing or replacing a part with an HMC

You can use the Hardware Management Console (HMC) to perform many service actions, including the installation of a new field-replaceable unit (FRU) or parts.

Installing a part by using the HMC

You can use the Hardware Management Console (HMC) to perform many service actions, including the installation of a new feature or part.

To install a feature or part into a system or an expansion unit by using the HMC, complete the following steps:

1. Choose one of the following navigation options depending on the interface type of the Hardware Management Console (HMC):

- If you are using an HMC Classic or HMC Enhanced interface, complete the following steps:
 - a. In the navigation area, expand **Systems Management > Servers**.
 - b. Select the managed system for which you want to install a part.

Note: If your part is in a miscellaneous equipment specification (MES), continue with step 1c. If your part is contained in the install that is done by the system services representative (SSR) or in a ship group, go to step 1h.

- c. In the Tasks area, expand **Serviceability > Hardware > MES Tasks > Open MES**.
 - d. Click **Add MES Order Number**.
 - e. Enter the number, and click **OK**.
 - f. Click the newly created order number, and click **Next**. The details of the order number are displayed.
 - g. Click **Cancel** to close the window.
 - h. In the Tasks area, expand **Serviceability > Hardware > MES Tasks**.
- If you are using an HMC Enhanced + Tech Preview (Pre-GA) or HMC Enhanced+ interface, complete the following steps:



- a. In the navigation area, click the **Resources** icon , and then click **All Systems**.
 - b. Click the system name for which you want to install the part.
 - c. In the navigation area, click **Serviceability**.
2. In the Serviceability window, click **Add FRU** (field replaceable unit).
 3. In the Add/Install/Remove Hardware-Add FRU, Select FRU Type window, select the system or enclosure into which you are installing the feature.
 4. Select the type of feature you are installing, and click **Next**.
 5. Select the location code where you will install the feature, and click **Add**.
 6. After the part is listed in the **Pending Actions** section, click **Launch Procedure** and follow the instructions to install the feature.

Note: The HMC might open external instructions for installing the feature. If so, follow those instructions to install the feature.

Removing a part by using the HMC

Learn how to remove a part by using the Hardware Management Console (HMC).

To remove a part in a system or an expansion unit by using the HMC, complete the following steps:

1. Choose one of the following navigation options depending on the interface type of the HMC:
 - If you are using an HMC Classic or HMC Enhanced interface, complete the following steps:
 - a. In the navigation area, expand **Systems Management > Servers**.
 - b. Select the managed system from which you are removing a part.
 - c. In the Tasks area, expand **Serviceability > Hardware > MES Tasks > Remove FRU**.
 - If you are using an HMC Enhanced + Tech Preview (Pre-GA) or HMC Enhanced+ interface, complete the following steps:



- a. In the navigation area, click the **Resources** icon , and then click **All Systems**.
 - b. Click the system name for which you want to remove a part.
 - c. In the navigation area, click **Serviceability**.
 - d. In the Serviceability window, click **Remove FRU**.
2. In the Add/Install/Remove Hardware - Remove FRU, Select FRU Type window, select the system or enclosure from which you are removing the part.
 3. Select the type of part that you are removing, and click **Next**.
 4. Select the location of the part that you are removing, and click **Add**.
 5. After the part is listed in the **Pending Actions** section, click **Launch Procedure** and follow the instructions to remove the part.

Note: The HMC might display the IBM Knowledge Center instructions for removing the part. If so, follow those instructions to remove the part.

Repairing a part by using the HMC

You can use the Hardware Management Console (HMC) to complete many service actions, including repairing a field-replaceable unit (FRU) or part.

1. Choose one of the following navigation options depending on the interface type of the Hardware Management Console (HMC):
 - If you are using an HMC Classic or HMC Enhanced interface, complete the following steps:
 - a. In the navigation area, expand **Systems Management > Servers**.
 - b. Select the managed system for which you want to repair a part.
 - c. In the Tasks area, expand **Serviceability > Manage Serviceable Events**.
 - If you are using an HMC Enhanced + Tech Preview (Pre-GA) or HMC Enhanced+ interface, complete the following step:



- a. In the navigation area, click the **Resources** icon , and then click **All Systems**.
 - b. Click the system name for which you want to remove a part.
 - c. In the navigation area, click **Serviceability**.
 - d. In the Serviceability window, click **Serviceable Events Manager**.
- Note:** You can also access **Serviceable Events Manager** option from the **Actions** list after selecting the system.
2. In the Manage Serviceable Events window, specify the event criteria, error criteria, and FRU criteria. If you do not want the results to be filtered, select **ALL**.
 3. Click **OK**. The Manage Serviceable Events - Serviceable Event Overview window displays all of the events that match your criteria. The information that is displayed in the compact table view includes the following details:

- Problem number
- PMH number
- Reference code - click the Reference code to display a description of the problem reported and actions that can be taken to fix the problem.
- Status of the problem
- Last reported time of the problem
- Failing MTMS of the problem

Note: The full table view includes more detailed information, including reporting MTMS, first reported time, and serviceable event text.

4. Select a serviceable event and use the **Selected** drop-down menu to select **Repair**.
5. Follow the instructions to repair the part.

Note: The HMC might open IBM Knowledge Center instructions for repairing the part. If so, follow those instructions to repair the part.

Power cords

Use these procedures to disconnect and connect the power cords on IBM Power Systems servers that contain the POWER8 processor.

Disconnecting the power cords from the system

Use this procedure to disconnect the power cords from the system.

To disconnect the power cords from the system, complete the following steps:

1. Open the rear rack door on the system unit that you are servicing.
2. Identify the system unit that you are servicing in the rack.
3. Disconnect the power cords (**B**) from the system unit. See Figure 20 on page 38, Figure 21 on page 38, or Figure 22 on page 39 or depending on the type of your system.

Notes:

- This system might be equipped with two or more power supplies. If the removing and replacing procedures require the power to be off, then ensure that all the power sources to the system have been completely disconnected.
- The power cord is fastened to the system using the hook-and-loop fastener (**A**). If you are placing the system in a service position after disconnecting the power cords, then ensure that you unstrap the fastener.

Figure 17 on page 37 shows the supported alternate current (AC) and high voltage direct current (HVDC) connectors. Figure 18 on page 37 and Figure 19 on page 37 show the supported connectors and power distribution unit (PDU) for 8408-44E.

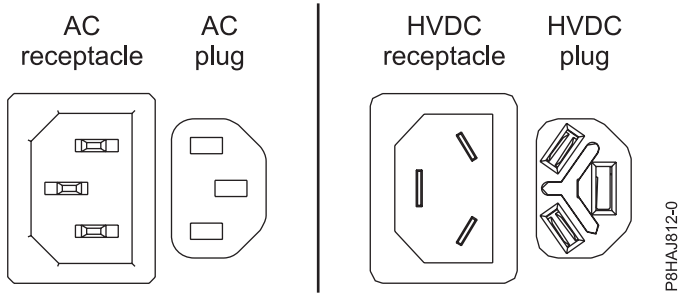

Figure 17. AC and HVDC connectors

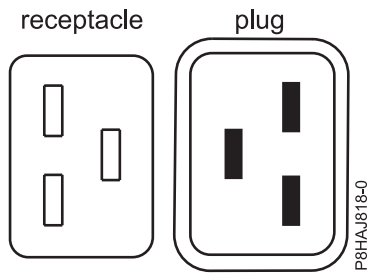

Figure 18. Connectors for the 8408-44E system

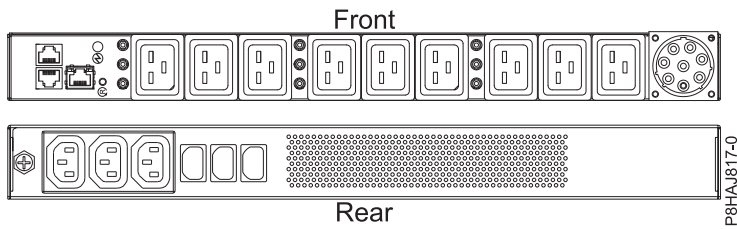

Figure 19. PDU for the 8408-44E system

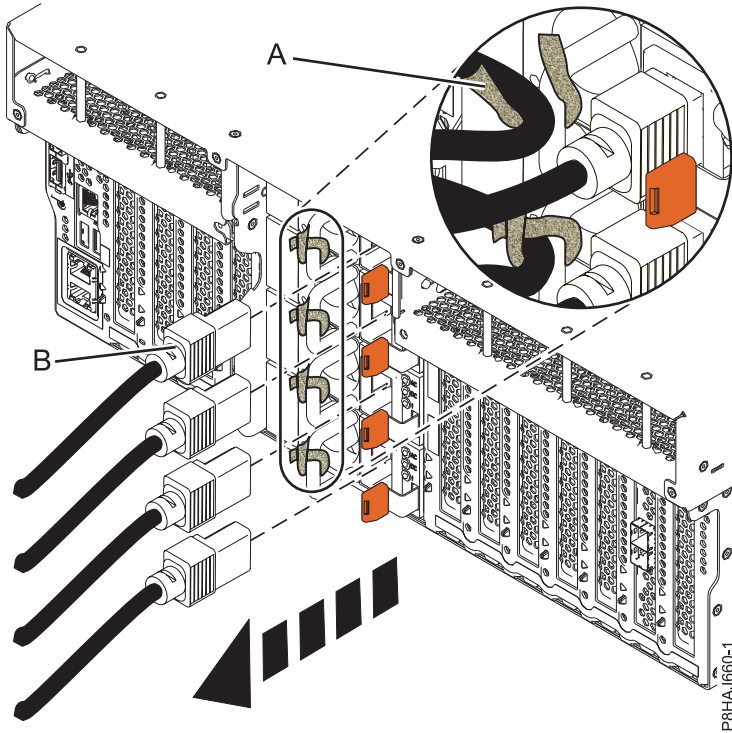

Figure 20. Removing the power cords from an 8247-42L, 8286-41A, or 8286-42A system

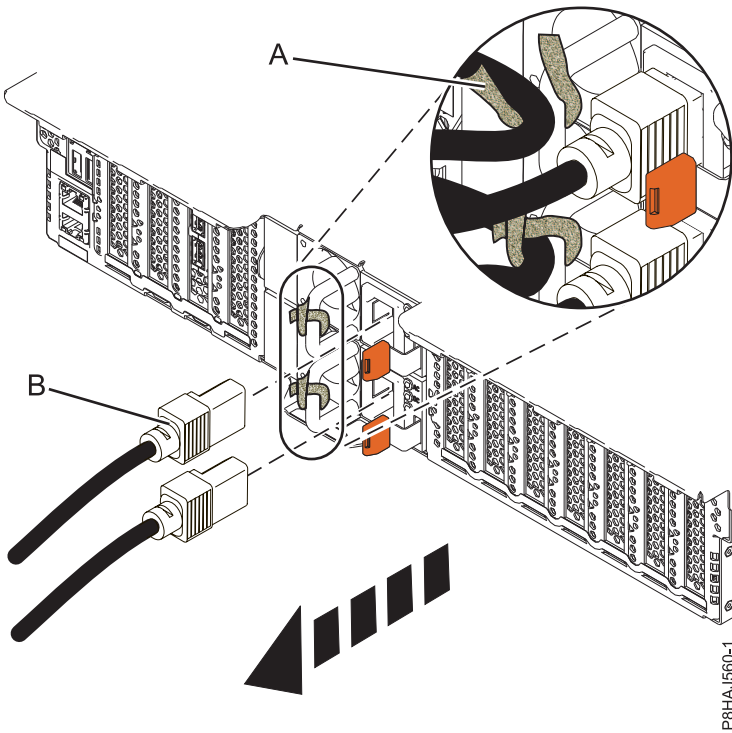

Figure 21. Removing the power cords from an 5148-21L, 5148-22L, 8247-21L, 8247-22L, 8284-21A, or 8284-22A system

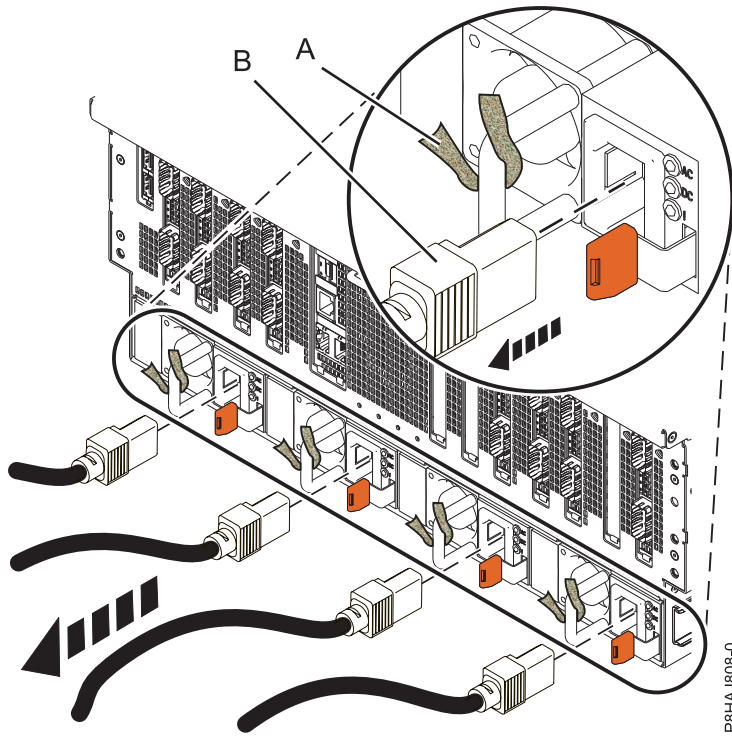

Figure 22. Removing the power cords from an 8408-44E or 8408-E8E system

Connecting the power cords to the system

Use this procedure to connect the power cords to the system.

To connect the power cords to the system, complete the following steps:

1. Open the rear rack door on the system unit that you are servicing.
2. Reconnect the power cords (A) to the system unit. See Figure 26 on page 40, Figure 27 on page 41, or Figure 28 on page 41 depending on the type of your system. Figure 23 shows the supported alternate current (AC) and high voltage direct current (HVDC) connectors. Figure 24 on page 40 and Figure 25 on page 40 show the supported connectors and power distribution unit (PDU) for 8408-44E.

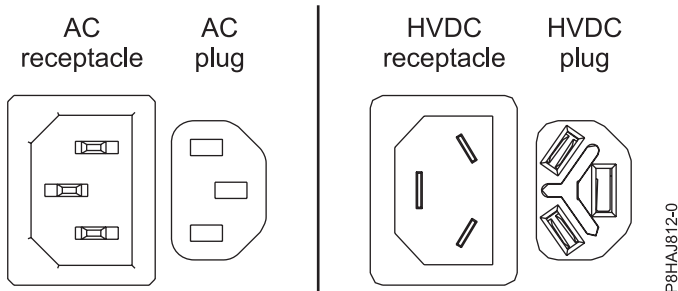

Figure 23. AC and HVDC connectors

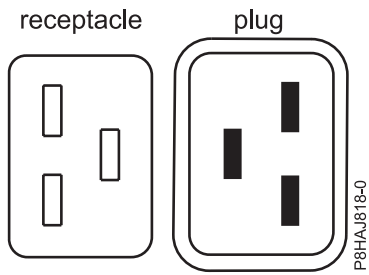

Figure 24. Connectors for the 8408-44E system

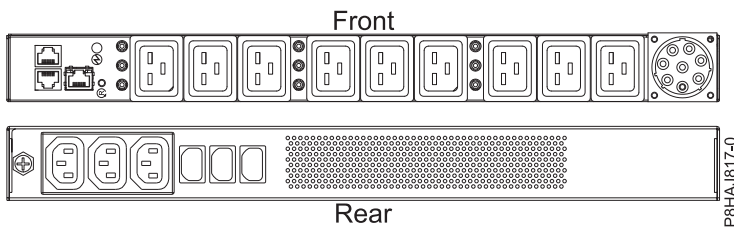

Figure 25. PDU for the 8408-44E system

3. Fasten the power cords to the system using the hook-and-loop fasteners **(B)**.

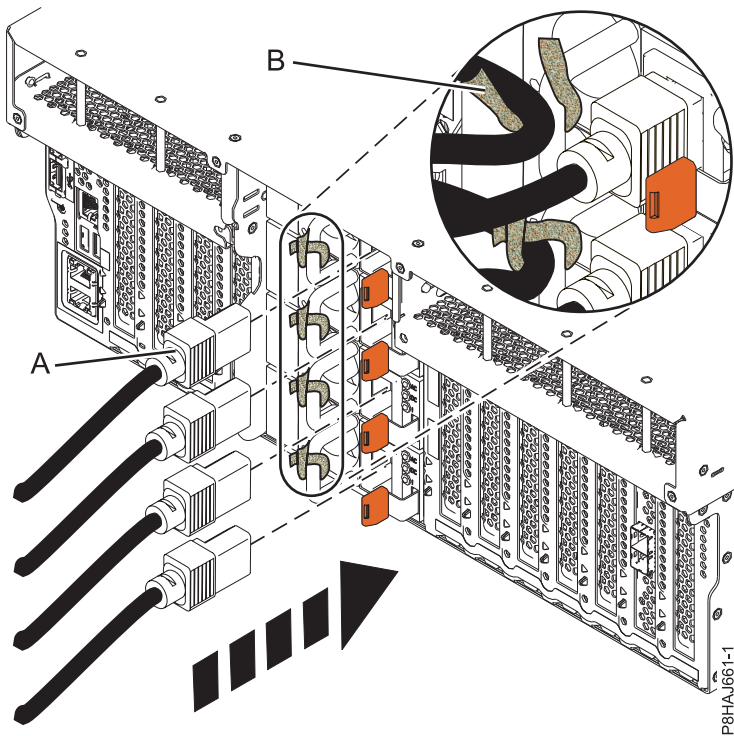

Figure 26. Connecting the power cords to an 8247-42L, 8286-41A, or 8286-42A system

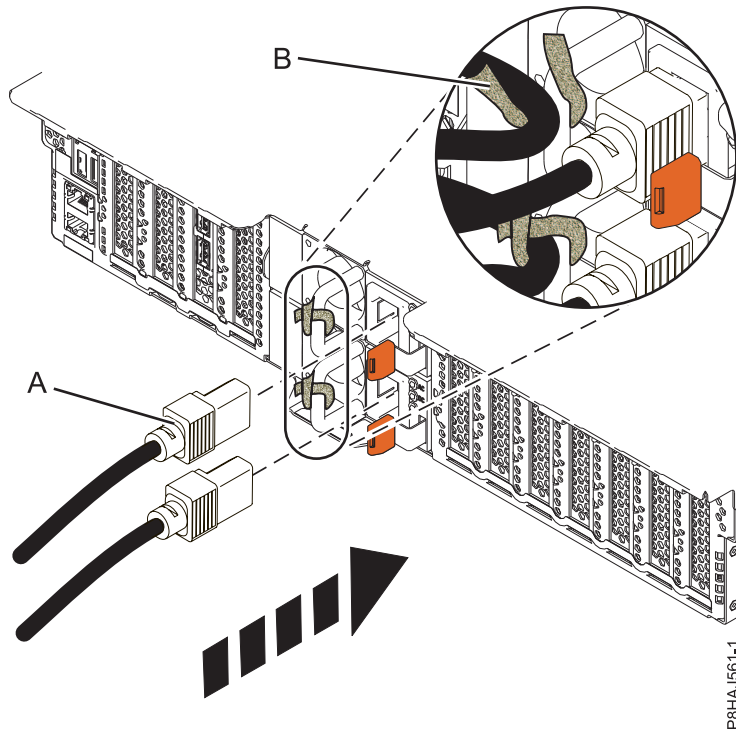

Figure 27. Connecting the power cords to a 5148-21L, 5148-22L, 8247-21L, 8247-22L, 8284-21A, or 8284-22A system

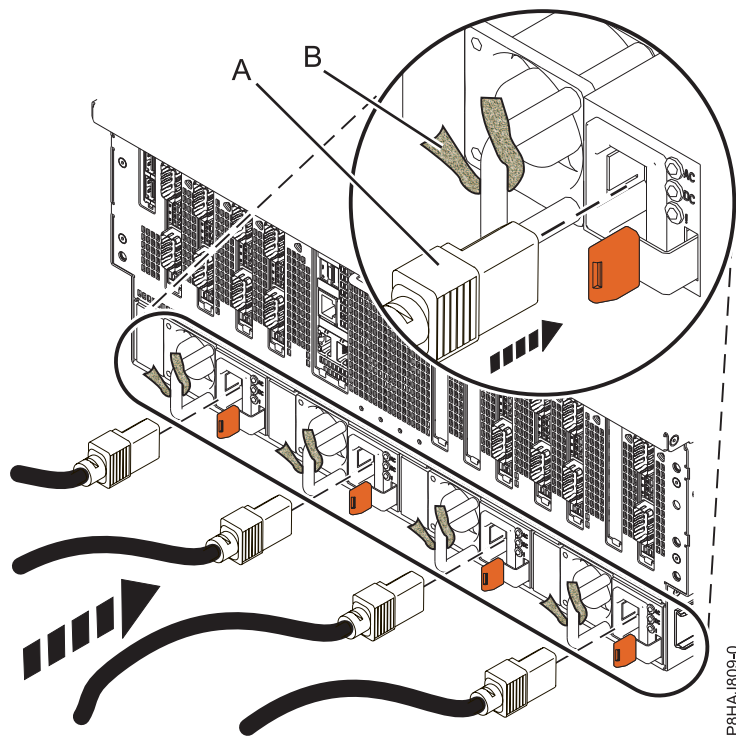

Figure 28. Connecting the power cords to an 8408-44E or 8408-E8E system

4. Close the rack door at the rear of the system.

Removing and replacing covers on an 8408-44E or 8408-E8E system

Use these instructions to remove and replace the covers in an 8408-44E or 8408-E8E system so that you can access the hardware parts or perform service.

Removing the front cover from an 8408-44E or 8408-E8E system

Use this procedure to remove the cover so that you can access the components or perform service.

To remove the front cover, complete the following steps:

1. If necessary, open the front rack door.
2. Ensure that you have the electrostatic discharge (ESD) wrist strap attached. If not, attach it now.
3. Place your fingers on the indentations and pull the latches (**B**) located on both sides of the cover.

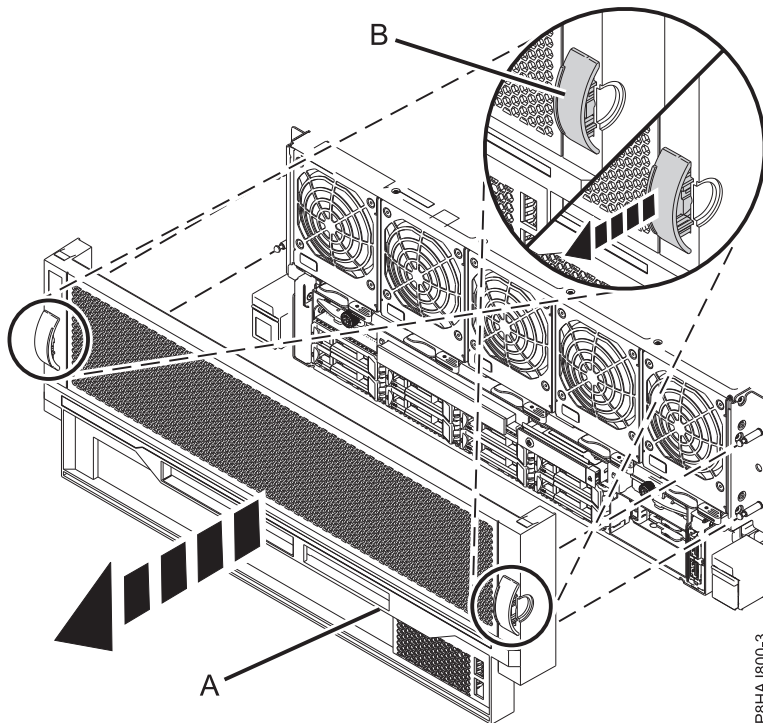

Figure 29. Removing the front cover

4. Pull the cover (**A**) away from the system.

Installing the front cover on an 8408-44E or 8408-E8E system

Use this procedure to install the cover after accessing the components or performing service.

To install the front cover, complete the following steps:

1. Ensure that you have the electrostatic discharge (ESD) wrist strap attached. If not, attach it now.
2. Position the cover (**A**) on the front of the system unit so that the four pins (**B**) on the system match the four holes at the rear of the cover.

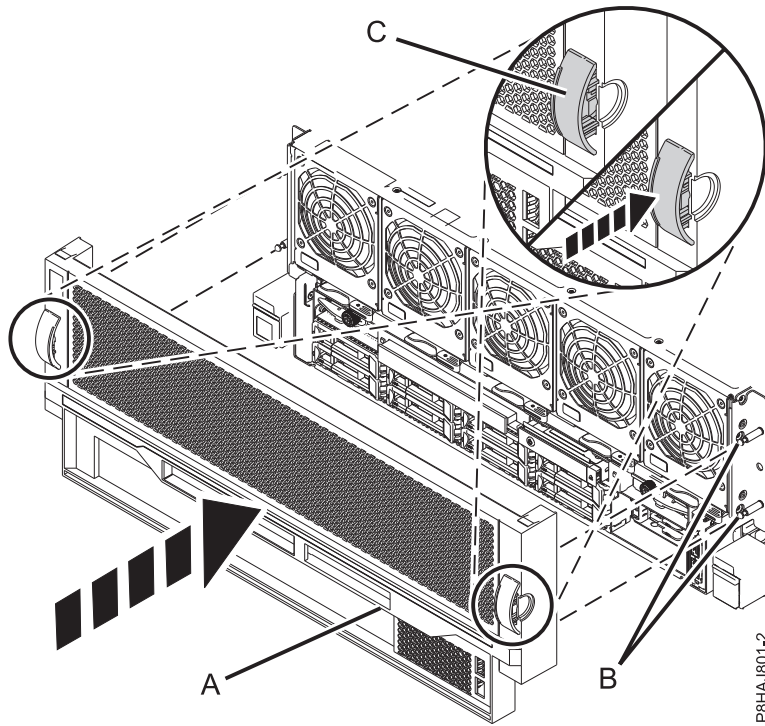

Figure 30. Installing the front cover

3. Press the tabs (C) to snap the cover into position.
4. Close the front door of the rack.

Removing the service access cover from an 8408-44E or 8408-E8E system

Use this procedure to remove the service access cover from an 8408-44E or 8408-E8E system.

To remove the service access cover, complete the following steps:

1. Ensure that you have the electrostatic discharge (ESD) wrist strap attached. If not, attach it now.
2. Push the release latches (A) in the direction shown.
3. Slide the cover (B) off the system unit. When the front of the service access cover has cleared the upper frame ledge, lift the cover up and off the system unit.

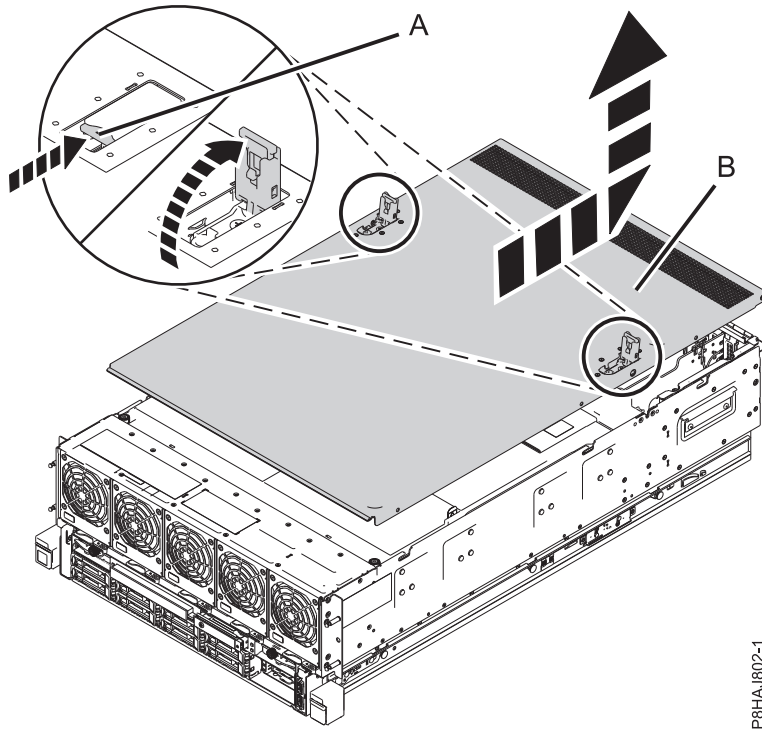

P8HAJ802-1

Figure 31. Removing the service access cover

Installing the service access cover on an 8408-44E or 8408-E8E system

Use this procedure to install the service access cover.

To install the service access cover, complete the following steps:

1. Ensure that you have the electrostatic discharge (ESD) wrist strap attached. If not, attach it now.
2. Slide the cover (**A**) onto the system unit.
3. Close the release latches (**B**) by pushing it in the direction shown.

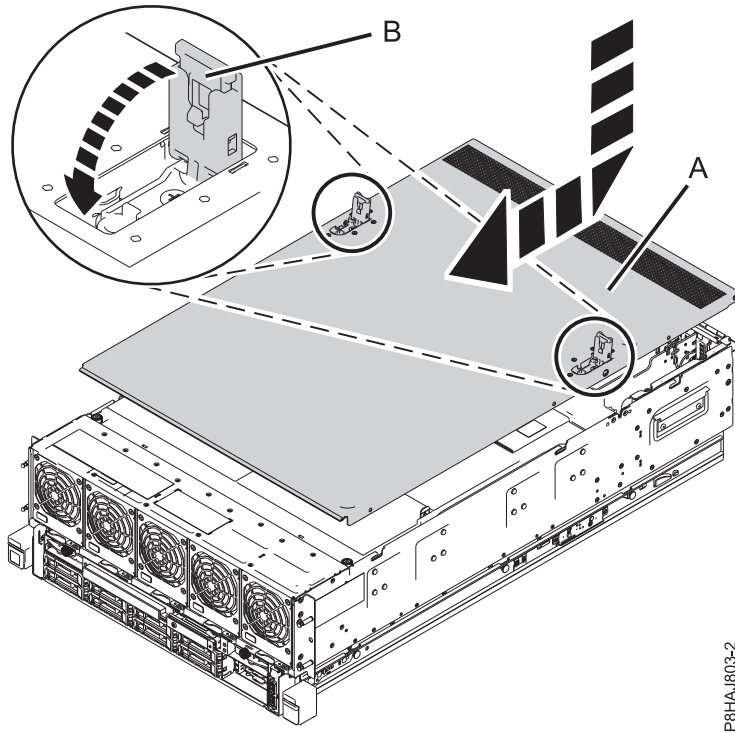

P8HAJ803-2

Figure 32. Installing the service access cover

Removing and replacing the safety cover in an 8408-44E or 8408-E8E system

Use these procedures to remove and replace the safety cover in an 8408-44E or 8408-E8E system.

Removing the safety cover from an 8408-44E or 8408-E8E system

Use this procedure to remove the safety cover from an 8408-44E or 8408-E8E system.

To remove the safety cover, complete the following steps:

1. Ensure that you have the electrostatic discharge (ESD) wrist strap attached. If not, attach it now.
2. Loosen the thumbscrew (A) located at the rear of the cover, by turning it in the direction shown in Figure 33 on page 46.
3. Slide the safety cover (B) toward the rear of the system. When the front of the cover has cleared the upper frame ledge, lift the cover up and off the system.

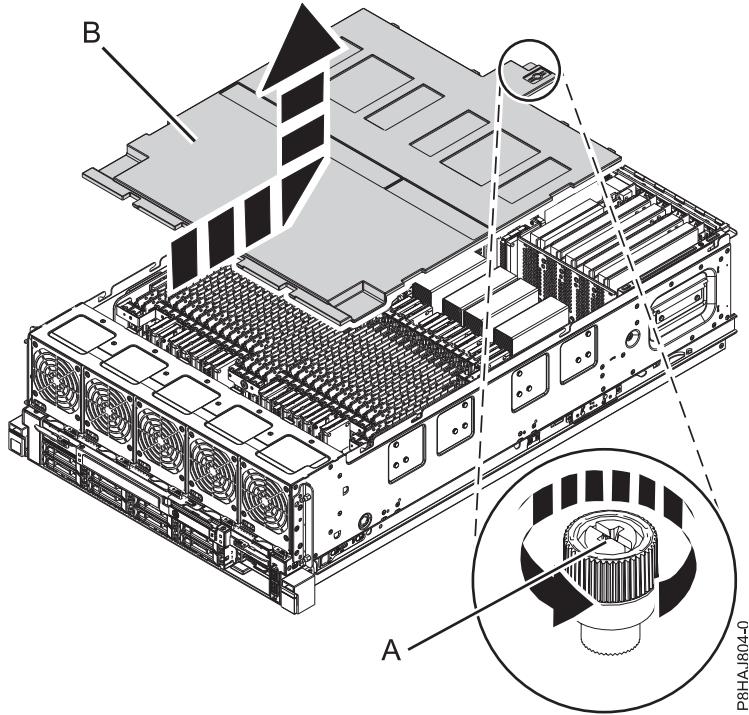

Figure 33. Removing the safety cover

Replacing the safety cover in an 8408-44E or 8408-E8E system

Use this procedure to replace the safety cover in an 8408-44E or 8408-E8E system.

To replace the safety cover, complete the following steps:

1. Ensure that you have the electrostatic discharge (ESD) wrist strap attached. If not, attach it now.
2. Push the safety cover (A) toward the chassis.
3. Tighten the thumbscrew (B) by turning it in the direction shown in Figure 34 on page 47 to fix the safety cover to the chassis.

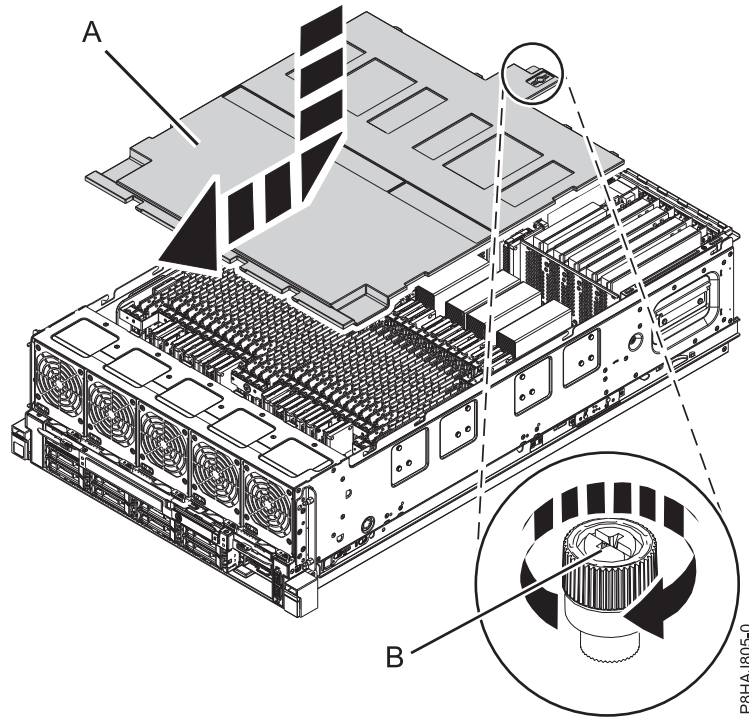

Figure 34. Replacing the safety cover

Opening and closing the I/O latch in an 8408-44E or 8408-E8E system

Use this procedure to open and close the I/O latch in an 8408-44E or 8408-E8E system.

The 8408-44E or 8408-E8E system is equipped with two I/O latches on either side of the system.

Opening the I/O latch in an 8408-44E or 8408-E8E system

Use this procedure to open the I/O latch in an 8408-44E or 8408-E8E system.

To open the I/O latch, complete the following steps:

1. Ensure that you have the electrostatic discharge (ESD) wrist strap attached. If not, attach it now.
2. Loosen the thumbscrew (A), by turning it in the direction shown in Figure 35 on page 48.
3. Move service access latch (B) to the open position, by pushing it in the direction shown in Figure 35 on page 48.

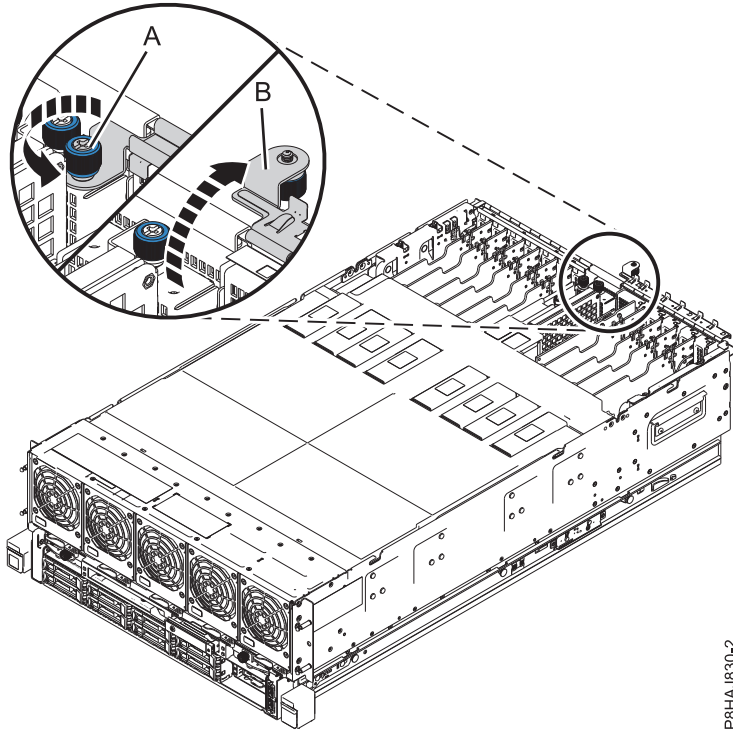

P8HAJ830-2

Figure 35. Opening the I/O latch

Closing the I/O latch in an 8408-44E or 8408-E8E system

Use this procedure to close the I/O latch in an 8408-44E or 8408-E8E system.

To close the I/O latch, complete the following steps:

1. Ensure that you have the electrostatic discharge (ESD) wrist strap attached. If not, attach it now.
2. Close the service access latch (**B**) by pushing it toward the chassis as shown in Figure 36 on page 49.
3. Tighten the thumbscrew (**A**) by turning it in the direction shown, to fix the latch to the chassis.

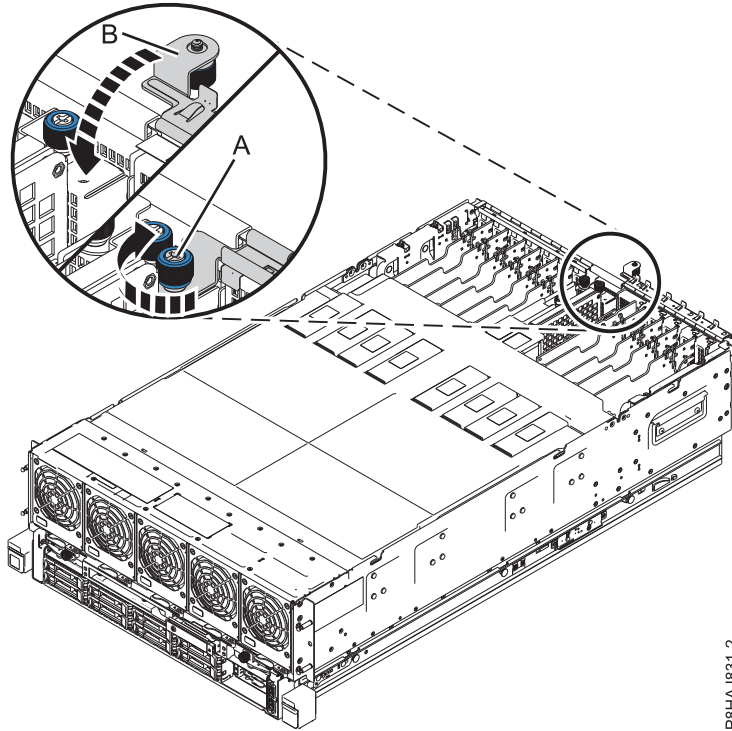

P8HAJ831-2

Figure 36. Closing the I/O latch

Service and operating positions for an 8408-44E or 8408-E8E system

Use these procedures to place an 8408-44E or 8408-E8E server into the service or operating position.

Placing an 8408-44E or 8408-E8E system into the service position

Use this procedure to place an 8408-44E or 8408-E8E system into the service position.

Notes:

- When placing the system into the service position, ensure that all stability plates are firmly in position to prevent the rack from toppling.
- Ensure that only one system unit is in the service position at a time.
- Ensure that the cables at the rear of the system unit do not catch or bind as you pull the system unit forward in the rack.
- When the rails are fully extended, the rail safety latches lock into place. This action prevents the system from being pulled out too far.

To place an 8408-44E or 8408-E8E system into the service position, complete the following steps:

1. Ensure that you have the electrostatic discharge (ESD) wrist strap attached. If not, attach it now.
2. If you have not already done so, remove the front cover from the system. For instructions, see “Removing the front cover from an 8408-44E or 8408-E8E system” on page 42.
3. Remove the shipping screws (A) by using a Phillips screwdriver, if they are not removed already.
4. Release the side latches (B) by pressing them downward and then outward as shown in the following figure.

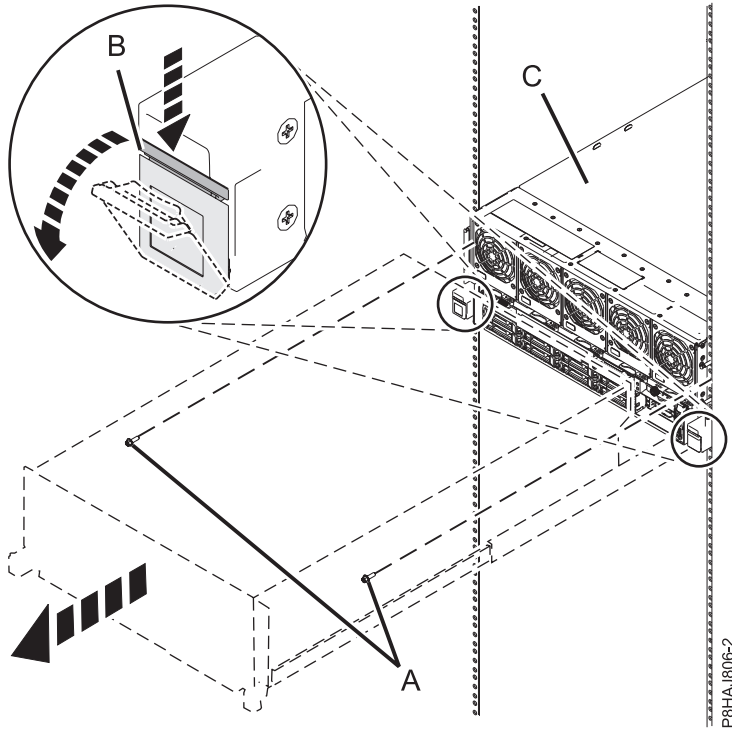

Figure 37. Placing the system in service position

5. Slide out the system unit (C) from the rack.

Placing an 8408-44E or 8408-E8E system into the operating position

Use this procedure to place an 8408-44E or 8408-E8E system into the operating position.

Note: When you place the system in the operating position, ensure that the cables at the rear of the system do not catch or bind as you push the system unit back into the rack.

To place an 8408-44E or 8408-E8E system in the operating position, complete the following steps:

1. Ensure that you have the electrostatic discharge (ESD) wrist strap attached. If not, attach it now.
2. Unlock the blue rail safety latches (A) by lifting them upward.
3. Push the system unit (B) back into the rack until both system unit release latches lock into position.

Note: Slide the system unit slowly into the rack to ensure that your fingers do not get caught in the side rails.

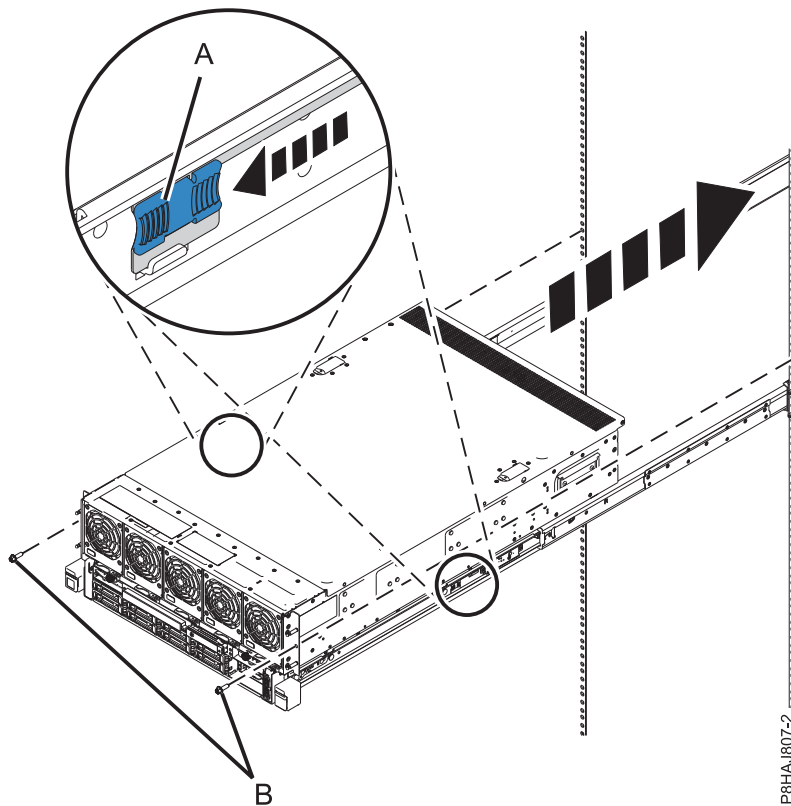

Figure 38. Placing the system into the operating position

4. Secure the server to the rack by using shipping screws.
5. If you have not already done so, replace the front cover. For instructions, see “Installing the front cover on an 8408-44E or 8408-E8E system” on page 42.

Verifying the installed part

You can verify a newly installed or replaced part on your system, logical partition, or expansion unit by using the operating system, stand-alone diagnostics, or the Hardware Management Console (HMC).

Verifying a part by using the operating system or VIOS

If you installed a new feature or replaced a part, you might want to use the tools in the operating system or Virtual I/O Server (VIOS) to verify that the feature or part is recognized by the system or logical partition.

Verifying an installed feature or replaced part by using an AIX system or logical partition

If you installed feature or replaced a part, you might want to use the tools in the AIX operating system to verify that the feature or part is recognized by the system or logical partition.

Verifying an installed feature by using the AIX operating system:

If you installed feature or replaced a part, you might want to use the tools in the AIX operating system to verify that the feature or part is recognized by the system or logical partition.

To verify the installed feature by using the AIX operating system, complete the following steps:

1. Log in as root user.

2. At the command line, type `diag` and press Enter.
3. Select **Advanced Diagnostics Routines** and press Enter.
4. From the **Diagnostic Mode Selection** menu, select **System Verification** and press Enter.
5. When the **Advanced Diagnostic Selection** menu appears, select one of the following options:
 - To test a single resource, select the resource that you installed from the list of resources and press Enter.
 - To test all the resources available to the operating system, select **All Resources** and press Enter.
6. Select **Commit**, and wait until the diagnostic programs run to completion, responding to any prompts that appear.
7. Did the diagnostics run to completion and display the message No trouble was found?
 - **No:** If a service request number (SRN) or other reference code is displayed, suspect a loose adapter or cable connection. Review the installation procedures to ensure that the new feature is installed correctly. If you cannot correct the problem, collect all SRNs or any other reference code information that you see. If the system is running in logical partitioning (LPAR) mode, note the logical partition in which you installed the feature. Contact your service provider for assistance.
 - **Yes:** The new device is installed correctly. Exit the diagnostic programs and return the system to normal operations.

Verifying a replaced part by using the AIX operating system:

If you replaced a part, you might want to use the tools in the AIX operating system to verify that the part is recognized by the system or logical partition.

To verify the operation of a replacement part, complete the following steps:

1. Did you use either the AIX operating system or the online diagnostics service aid concurrent (hot-swap) service to replace the part?
 - No:** Go to step 2.
 - Yes:** Go to step 5 on page 53.
2. Is the system powered off?
 - No:** Go to step 4.
 - Yes:** Continue with the next step.
3. Start the system and wait until the AIX operating system login prompt is displayed or until apparent system activity on the operator panel or display has stopped.

Did the AIX login prompt display?

 - **No:** If a service request number (SRN) or other reference code is displayed, suspect a loose adapter or cable connection. Review the procedures for the part that you replaced to ensure that the new part is installed correctly. If you cannot correct the problem, collect all SRNs or any other reference code information that you see. If the system does not start or you have no login prompt, see: Problems with loading and starting the operating system.

If the system is partitioned, note the logical partition in which you replaced the part. Contact your service provider for assistance.
 - **Yes:** Go to step 4.
4. At the command prompt, type `diag -a` and press Enter to check for missing resources. If you see a command prompt, go to step 5 on page 53.

If the **Diagnostic selection** menu is shown with **M** appearing next to any resource, follow these steps:

 - a. Select the resource and press Enter.
 - b. Select **Commit**.
 - c. Follow any instructions that are shown.

- d. If the *Do you want to review the previously displayed error?* message is shown, select **Yes** and press Enter.
 - e. If an SRN is shown, suspect a loose card or connection. If no obvious problem is shown, record the SRN and contact your service provider for assistance.
 - f. If no SRN is shown, go to step 5.
5. Test the part by doing the following steps:
 - a. At the command line, type `diag` and press Enter.
 - b. From the **Function Selection** menu, select **Advanced Diagnostics Routines** and press Enter.
 - c. From the **Diagnostic Mode Selection** menu, select **System Verification** and press Enter.
 - d. Select **All Resources**, or select the diagnostics for the individual part to test only the part you replaced and any devices that are attached to the part you replaced and press Enter.
Did the **Resource Repair Action** menu appear?
No: Go to step 6.
Yes: Go to step 7.
 6. Did the *Testing Complete, No trouble was found* message appear?
 - **No:** There is still a problem. Contact your service provider. **This ends the procedure.**
 - **Yes:** Select **Log Repair Action**, if not previously logged, from the **Task Selection** menu to update the AIX error log. If the repair action was reseating a cable or adapter, select the resource associated with that repair action. If the resource associated with your action is not displayed on the resource list, select `sysplanar0` and press Enter.

Tip: This action changes the indicator light for the part from the fault state to the normal state.
Go to step 9 on page 54.
 7. Select the resource for the replaced part from the **Resource Repair Action** menu. When a test is run on a resource in system verification mode, and that resource has an entry in the AIX error log, if the test on the resource was successful, the **Resource Repair Action** menu appears. Complete the following steps to update the AIX error log to indicate that a system-detectable part has been replaced.

Note: On systems with an indicator light for the failing part, this action changes the indicator light to the normal state.
 - a. Select the resource that has been replaced from the **Resource Repair Action** menu. If the repair action was reseating a cable or adapter, select the resource associated with that repair action. If the resource associated with your action does not appear on the resource list, select `sysplanar0` and press Enter.
 - b. Select **Commit** after you make your selections. Did another **Resource Repair Action** display appear?
No: If the **No Trouble Found** display appears, go to step 9 on page 54
Yes: Go to step 8.
 8. Select the parent or child of the resource for the replaced part from the **Resource Repair Action** menu if necessary. When a test is run on a resource in system verification mode, and that resource has an entry in the AIX error log, if the test on the resource was successful, the **Resource Repair Action** menu appears. Complete the following steps to update the AIX error log to indicate that a system-detectable part has been replaced.

Note: This action changes the indicator light for the part from the fault state to the normal state.
 - a. From the **Resource Repair Action** menu, select the parent or child of the resource that has been replaced. If the repair action was to reseat a cable or adapter, select the resource associated with that repair action. If the resource associated with your action does not appear on the resource list, select `sysplanar0` and press Enter.

- b. Select **Commit** after you make your selections.
 - c. If the **No Trouble Found** display appears, go to step 9.
9. If you changed the service processor or network settings, as instructed in previous procedures, restore the settings to the values they had prior to servicing the system.
 10. Did you do any hot-plug procedures before doing this procedure?
 - No:** Go to step 11.
 - Yes:** Go to step 12.
 11. Start the operating system, with the system or logical partition in normal mode. Were you able to start the operating system?
 - No:** Contact your service provider. **This ends the procedure.**
 - Yes:** Go to step 12.
 12. Are the indicator lights still on?
 - **No. This ends the procedure.**
 - **Yes.** Turn off the lights. See the following for instructions: Changing service indicators (<http://www.ibm.com/support/knowledgecenter/POWER8/p8hby/serviceindicators.htm>).

Verifying the installed part by using an IBM i system or logical partition

If you have installed a new feature or part, verify that the system recognizes the feature or part by using the IBM i system service tools.

To verify the installed part, complete the following steps:

1. Deactivate the failing item indicator light. For instructions, see “Deactivating the indicator light by using the IBM i operating system” on page 81.
2. Sign on **with at least service level authority**.
3. On the command line of the IBM i session, type `strsst` and press Enter.

Note: If you cannot get to the System Service Tools display, use function 21 from the control panel. Alternatively, if the system is managed by Hardware Management Console (HMC), use the Service Focal Point Utilities to get to the Dedicated Service Tools (DST) display.

4. Type your service tools user ID and service tools password on the System Service Tools (SST) Sign On display and press Enter.

Note: The service tools password is case-sensitive.

5. Select **Start a service tool** from the System Service Tools (SST) display and press Enter.
6. Select **Hardware service manager** from the Start a Service Tool display and press Enter.
7. Select **Logical hardware resources (buses, IOPs, controllers)** from the Hardware Service Manager display and press Enter. This option allows you to display and work with logical resources. Logical hardware resources are the functional resources of the system used by the operating system.

With the Logical Hardware Resources display, you can show logical hardware resource status or information, and associated packaging hardware resources. Use the online Help information to better understand specific functions, fields, or symbols.

Verifying an installed part by using a Linux system or logical partition

Learn how to verify that the system recognizes a new or replacement part.

To verify the newly installed or replaced part, continue with “Verifying an installed part by using stand-alone diagnostics” on page 55.

Verifying an installed part by using stand-alone diagnostics

If you have installed or replaced a part, verify that the system recognizes the new part. You can use stand-alone diagnostics to verify an installed part in an AIX or Linux system, expansion unit, or logical partition.

- If this server is directly attached to another server or attached to a network, ensure communications with the other servers have stopped.
- The stand-alone diagnostics require use of all of the logical partition resources. No other activity can be running on the logical partition.
- The stand-alone diagnostics require access to the system console.

You access these diagnostics from a CD-ROM or from the Network Installation Management (NIM) server. This procedure describes how to use the diagnostics from a CD-ROM. For information on running diagnostics from the NIM server, see *Running stand-alone diagnostics from a Network Installation Management server*.

To use stand-alone diagnostics, follow these steps:

1. Stop all jobs and applications and then stop the operating system on the system or logical partition.
2. Remove all tapes, diskettes, and CD-ROM.
3. Turn off the system unit power. The next step boots the server or logical partition from the stand-alone diagnostics CD-ROM. If the optical drive is not available as a boot device on the server or logical partition on which you are working, follow these steps:
 - a. Access the ASMI. For information on using the ASMI, see *Managing the Advanced System Management Interface*.
 - b. On the ASMI main menu, click **Power/Restart Control**.
 - c. Click **Power On/Off System**.
 - d. Select the **Service mode boot from default boot list** option in the AIX or Linux logical partition mode boot drop-down menu.
 - e. Click **Save settings and power on**. When the optical drive is powered on, insert the stand-alone diagnostic CD-ROM.
 - f. Go to step 5.
4. Turn on the system unit power and immediately insert the diagnostics CD-ROM into the optical drive.
5. After the **keyboard** POST indicator displays on the system console and before the last POST indicator (**speaker**) displays, press the numeric 5 key on the system console to indicate that a service mode boot must be initiated by using the default-service mode boot list.
6. Enter any requested password.
7. At the **Diagnostic Operating Instructions** display, press Enter.

Tip: If a service request number (SRN) or other reference code is displayed, suspect a loose adapter or cable connection.

Note: If you received an SRN or any other reference code when you attempted to start the system, contact your service provider for assistance.

8. If the terminal type is requested, select the **Initialize Terminal** option on the Function Selection menu to initialize the operating system.
9. From the Function Selection menu, select **Advanced Diagnostics Routines** and press Enter.
10. From the Diagnostic Mode Selection menu, select **System Verification** and press Enter.
11. When the Advanced Diagnostic Selection menu appears, select **All Resources**, or test only the part you replaced, and any devices that are attached to the part you replaced, by selecting the diagnostics for the individual part and press Enter.
12. Did the Testing Complete, No trouble was found message appear?

- **No:** There is still a problem. Contact your service provider.
 - **Yes:** Go to step 13.
13. If you changed the service processor or network settings, as instructed in previous procedures, restore the settings to the value they had prior to servicing the system.
 14. If the indicator lights are still on, follow these steps:
 - a. Select **Identify and Attention Indicators** from the Task Selection menu to turn off the system attention and indicator lights and press Enter.
 - b. Select **Set System Attention Indicator to NORMAL** and press Enter.
 - c. Select **Set All Identify Indicators to NORMAL** and press Enter.
 - d. Choose **Commit**.

Note: This changes the system attention and identify indicators from the *Fault* state to the *Normal* state.

- e. Exit to the command line.

Verifying an installed part or replaced part on a system or logical partition by using Virtual I/O Server tools

If you installed or replaced a part, you might want to use the tools in Virtual I/O Server (VIOS) to verify that the part is recognized by the system or logical partition.

Verifying an installed part by using VIOS:

You can verify the operation of an installed part by using the VIOS.

To verify an installed part, complete the following steps:

1. Log in as root user.
2. At the command line, type `diagmenu` and press Enter.
3. Select **Advanced Diagnostics Routines** and press Enter.
4. From the **Diagnostic Mode Selection** menu, select **System Verification** and press Enter.
5. When the **Advanced Diagnostic Selection** menu appears, do one of the following steps:
 - To test a single resource, select the resource that you just installed from the list of resources and press Enter.
 - To test all the resources available to the operating system, select **All Resources** and press Enter.
6. Select **Commit**, and wait until the diagnostic programs run to completion, responding to any prompts that appear.
7. Did the diagnostics run to completion and display the message No trouble was found?
 - **No:** If a service request number (SRN) or other reference code is displayed, suspect a loose adapter or cable connection. Review the installation procedures to ensure that the new part is installed correctly. If you cannot correct the problem, collect all SRNs or any other reference code information that you see. If the system is running in LPAR mode, note the logical partition in which you installed the part. Contact your service provider for assistance.
 - **Yes:** The new device is installed correctly. Exit the diagnostic programs and return the system to normal operations.

Verify the replacement part by using VIOS:

You can verify the operation of a replacement part by using the VIOS.

To verify the operation of a replacement part, complete the following steps:

1. Did you replace the part by using either VIOS or the online diagnostics service aid's concurrent (hot-swap) service operation?

- **No:** Go to step 2.
 - **Yes:** Go to step 5.
2. Is the system powered off?
 - **No:** Go to step 4.
 - **Yes:** Go to step 3.
 3. Start the system and wait until the VIOS operating system login prompt displays or until apparent system activity on the operator panel or display has stopped. Did the VIOS login prompt display?
 - **No:** If an SRN or other reference code is displayed, suspect a loose adapter or cable connection. Review the procedures for the part that you replaced to ensure that the new part is installed correctly. If you cannot correct the problem, collect all SRNs or any other reference code information that you see. If the system does not start or you have no login prompt, see Problems with loading and starting the operating system.

If the system is partitioned, note the logical partition in which you replaced the part. Contact your service provider for assistance.
 - **Yes:** Go to step 4.
 4. At the command prompt, type `diag -a` and press Enter to check for missing resources. If you see a command prompt, go to step 5.

If the **Diagnostic selection** menu is shown with **M** appearing next to any resource, follow these steps:
 - a. Select the resource and press Enter.
 - b. Select **Commit**.
 - c. Follow any instructions that are shown.
 - d. If a *Do you want to review the previously displayed error?* message is shown, select **Yes** and press Enter.
 - e. If an SRN is shown, suspect a loose card or connection. If no obvious problem is shown, record the SRN and contact your service provider for assistance.
 - f. If no SRN is shown, go to 5.
 5. Test the part by doing the following:
 - a. At the command line, type `diagmenu` and press Enter.
 - b. From the **Function Selection** menu, select **Advanced Diagnostics Routines** and press Enter.
 - c. From the **Diagnostic Mode Selection** menu, select **System Verification** and press Enter.
 - d. Select **All Resources**, or select the diagnostics for the individual part to test only the part you replaced, and any devices that are attached to the part you replaced and press Enter.

Did the **Resource Repair Action** menu appear?
 - **No:** Go to step 6.
 - **Yes:** Go to step 7.
 6. Did the *Testing Complete, No trouble was found* message appear?
 - **No:** There is still a problem. Contact your service provider. **This ends the procedure.**
 - **Yes:** Select **Log Repair Action**, if not previously logged, from the **Task Selection** menu to update the error log. If the repair action was reseating a cable or adapter, select the resource associated with that repair action. If the resource associated with your action is not displayed on the Resource List, select `sysplanar0` and press Enter.

Tip: This action changes the indicator light for the part from the fault state to the normal state. Go to step 9 on page 58.
 7. Select the resource for the replaced part from the **Resource Repair Action** menu. When a test is run on a resource in system verification mode, and that resource has an entry in the error log, if the test on the resource was successful, the **Resource Repair Action** menu appears. Complete the following

steps to update the error log to indicate that a system-detectable part has been replaced. On systems with an indicator light for the failing part, this changes the indicator light to the normal state.

- a. Select the resource that has been replaced from the **Resource Repair Action** menu. If the repair action was reseating a cable or adapter, select the resource associated with that repair action. If the resource associated with your action does not appear on the Resource List, select **sysplanar0**. Press Enter.
 - b. Select **Commit** after you make your selections. Did another **Resource Repair Action** display appear?
 - **No:** If the **No Trouble Found** display appears, go to step 9.
 - **Yes:** Go to step 8.
8. Select the parent or child of the resource for the replaced part from the **Resource Repair Action** menu if necessary. When a test is run on a resource in system verification mode, and that resource has an entry in the error log, if the test on the resource was successful, the **Resource Repair Action** menu appears. Complete the following steps to update the error log to indicate that a system-detectable part has been replaced. This changes the indicator light for the part from the fault state to the normal state.
- a. From the **Resource Repair Action** menu, select the parent or child of the resource that has been replaced. If the repair action was to reseat a cable or adapter, select the resource associated with that repair action. If the resource associated with your action does not appear on the Resource List, select **sysplanar0**. Press Enter.
 - b. Select **Commit** after you make your selections.
 - a. If the **No Trouble Found** display appears, go to step 9.
9. If you changed the service processor or network settings, as instructed in previous procedures, restore the settings to the values they had prior to servicing the system.
10. Did you do any hot-plug procedures before doing this procedure?
 - **No:** Go to step 11.
 - **Yes:** Go to step 12.
11. Start the operating system, with the system or logical partition in normal mode. Were you able to start the operating system?
 - **No:** Contact your service provider. **This ends the procedure.**
 - **Yes:** Go to step 12.
12. Are the indicator lights still on?
 - **No:** This ends the procedure.
 - **Yes.** Turn off the lights. For instructions, see Changing service indicators.

Verifying the installed part by using the HMC

If you have installed or replaced a part, use the Hardware Management Console (HMC) to update your HMC records after you have completed a service action on your server. If you have reference codes, symptoms, or location codes that you used during the service action, locate the records for use during this procedure.

To verify the installed part, complete the following steps:

1. At the HMC, examine the service action event log for any open service action events. See “Viewing serviceable events by using the HMC” on page 59 for details.
2. Are there any service action events that are open?
 - No:** If the system attention LED is still on, use the HMC to turn off the LED. See “Deactivating LEDs by using the HMC” on page 83. **This ends the procedure.**
 - Yes:** Continue with the next step.
3. Record the list of open service action events.

4. Examine the details of the open service action event. Is the error code associated with this service action event the same as you gathered earlier.
 - **No:** Select one of the following options:
 - Review the other serviceable events, find one that does match, and continue with the next step.
 - If the log does not match what you had gathered earlier, contact your service provider.
 - **Yes:** Continue with the next step.
5. Select and highlight the service action event from the Error Associated With This Serviceable Event window.
6. Click **Close Event**.
7. Add comments for the serviceable event. Include any unique additional information. Click **OK**.
8. Did you replace, add, or modify a field replaceable unit (FRU) of the open service action event?
 - **No:** Select the **No FRU Replaced for this Serviceable Event** option, and click **OK** to close the service action event.
 - **Yes:** Perform the following steps:
 - a. From the FRU list, select a FRU that you need to update.
 - b. Double-click the FRU and update the FRU information.
 - c. Click **OK** to close the service action event.
9. If you continue to have problems, contact your service provider.

Viewing serviceable events by using the HMC

Use this procedure to view a serviceable event, including details, comments, and service history by using the Hardware Management Console (HMC).

To view serviceable events and other information about the events, you must be a member of one of the following roles:

- Super administrator
- Service representative
- Operator
- Product engineer
- Viewer

To view serviceable events, follow these steps:

1. Choose one of the following navigation options depending on the interface type of the HMC:
 - If you are using the HMC Classic or HMC Enhanced interface, in the navigation area, click **Service Management > Manage Serviceable Events**.
 - If you are using an HMC Enhanced + Tech Preview (Pre-GA) or HMC Enhanced+ interface, in the



navigation area, click the **Serviceability** icon , and then click **Serviceable Events Manager**.

2. Select the criteria for the serviceable events that you want to view, and click **OK**. The Serviceable Event Overview window opens. The list shows all serviceable events that match your selection criteria. You can use the menu options to complete actions on the serviceable events.
3. Select a line in the Serviceable Event Overview window, and select **Selected > View Details**. The Serviceable Event Details window opens, showing detailed information about the serviceable event. The upper table shows information, such as problem number and reference code. The lower table shows the field replaceable units (FRUs) associated with this event.
4. Select the error for which you want to view comments and history, and follow these steps:
 - a. Click **Actions > View Comments**.

- b. When you are finished viewing the comments, click **Close**.
 - c. Click **Actions > View Service History**. The Service History window opens, showing service history that is associated with the selected error.
 - d. When you are finished viewing the service history, click **Close**.
5. When you are finished, click **Cancel** twice to close the Serviceable Event Details window and the Serviceable Event Overview window.

Verifying a repair

Use these procedures to verify hardware operation after making repairs to the system.

Choose from the following options:

- To verify the repair of a system that is currently powered off, go to step 1.
 - To verify the repair of a system that is currently powered on with no operating system loaded, go to step 3.
 - To verify the repair of a system that is currently powered on and that has an operating system loaded, go to step 5 on page 61.
1. Power on the server and all attached I/O enclosures.

Did all the enclosures power on?

Yes: Go to step 3.

No: Continue with the next step.

2. Choose from the following options:

- If the original problem was that an enclosure would not power on and you have another FRU to replace, locate and replace the next field-replaceable unit (FRU).
 - If the next FRU in the FRU list is an isolation procedure, perform the isolation procedure.
 - If the original problem was that an enclosure would not power on and you have an isolation procedure to complete, perform the isolation procedure.
 - If the original problem was that an enclosure would not power on and there are no more FRUs or isolation procedures in the FRU list, contact your next level of support.
 - If you have a new problem, perform problem analysis and repair the new problem.
-

3. Load the operating system.

Did the operating system load successfully?

Yes: Go to step 5.

No: Continue with the next step.

4. Choose from the following options:

- If the original problem was a failing disk drive that contained the operating system software, go to step 5.
 - If the original problem was that the operating system would not load and you have another FRU to replace, go to your FRU locations section to locate the next FRU.
 - If the next FRU in the FRU list is an isolation procedure, perform the isolation procedure.
 - If the original problem was that the operating system would not load and you have an isolation procedure to complete, perform the isolation procedure.
 - If the original problem was that the operating system would not load and there are no more FRUs or isolation procedures in the FRU list, contact your next level of support.
 - If you have a new problem, perform problem analysis and repair the new problem.
-

5. Choose from the following options:

- “Verifying the repair in AIX”
- “Verifying the repair in Linux” on page 65
- “Verifying a repair by using an IBM i system or logical partition” on page 63
- “Verifying the repair on an IBM PowerKVM system” on page 65
- “Verifying the repair from the management console” on page 66

Verifying the repair in AIX

You can use this procedure to verify that a repair is complete using the AIX operating system.

Use this maintenance analysis procedure (MAP) to check out the server after a repair is completed.

1. Did you replace a disk drive in the root volume group?

No Go to step 3.

Yes Continue with the next step.

2. Run stand-alone diagnostics either from a CD or from a Network Installation Management (NIM) server.

Did you encounter any problems?

No Reinstall the operating system and continue with step 5.

Yes If the original problem still exists, replace the field-replaceable unit (FRU) or perform the isolation procedure that is next in the FRU list. If you have reached the end of the FRU list, contact your next level of support.

If a new problem has occurred, go to Beginning problem analysis.

3. Did you replace a FRU with the power turned on and concurrently with system operations?

No Go to step 5.

Yes Continue with the next step.

4. Did you use an AIX diagnostics service aid hot-swap operation to change the FRU?

No Go to step 7 on page 62.

Yes Go to step 6 on page 62.

Note: The AIX diagnostic service aid was used if a resource was removed by using the **Hot Plug** task.

5. If any FRUs have been removed that should be reinstalled, reinstall them now:

a. If the system is not powered on, power it on now.

b. Wait until the AIX operating system login prompt is displayed or until system activity on the operator panel or display has stopped.

c. Did you encounter any problems?

No Continue at step 6.

Yes If the original problem still exists, replace the FRU or perform the isolation procedure that is next in the FRU list. If you have reached the end of the FRU list, contact your next level of support.

If a new problem occurs, go to Beginning problem analysis.

6. If the Resource Repair Action menu is already displayed, go to step 9; otherwise, perform the following steps:
 - a. Log into the operating system either with root authority (if needed, ask the customer to enter the password) or use the CE login.
 - b. Enter `diag -a` command and check for missing resources. Follow any instructions that are displayed. If an SRN displays, suspect a loose card or connection. If no instructions are displayed, no resources were detected as missing. Continue with the next step.
7. Perform the following steps:
 - a. Enter `diag` at the command prompt.
 - b. Press Enter.
 - c. Select the **Diagnostics Routines** option.
 - d. When the Diagnostic Mode Selection menu is displayed, select **System verification**.
 - e. When the Diagnostic Selection menu is displayed, select the **All Resources** option or test the FRUs you exchanged and any devices that are attached to the FRUs you exchanged by selecting the diagnostics for the individual FRU.

Did the Resource Repair Action menu (801015) display?

No Continue with the next step.

Yes Go to step 9.

8. Did the TESTING COMPLETE, no trouble was found menu (801010) display?

No If the original problem still exists, replace the FRU or perform the isolation procedure that is next in the FRU list. If you have reached the end of the FRU list, contact your next level of support.

If a new problem occurs go to Beginning problem analysis.

Yes Use the **Log Repair Action** option, if not previously logged, in the TASK SELECTION menu to update the AIX error log. If the repair action was reseating a cable or adapter, select the resource associated with that repair action.

If the resource associated with your action is not displayed on the resource list, select **sysplanar0**.

Note: If the check log indicator is on, this action will set it back to the normal state.

Go to step 11 on page 63.

9. When a test is run on a resource in system verification mode, that resource has an entry in the AIX error log. If the test on that resource was successful, the Resource Repair Action menu is displayed. After replacing a FRU, you must select the resource for that FRU from the Resource Repair Action menu. This updates the AIX error log to indicate that a system-detectable FRU has been replaced.

Note: If the check log indicator is on, this action will set it back to the normal state.

Perform the following steps:

- a. Select the resource that has been replaced from the Resource Repair Action menu. If the repair action was reseating a cable or adapter, select the resource associated with that repair action. If the resource associated with your action is not displayed on the resource list, select **sysplanar0**.

b. Press **Commit** after you make your selections.

Did another Resource Repair Action (801015) display?

No If the No Trouble Found menu displays, go to step 11.

Yes Continue with the next step.

10. The parent or child of the resource you just replaced might also require that you run the Resource Repair Action service aid on it.

When a test is run on a resource in system verification mode, that resource has an entry in the AIX error log. If the test on the resource was successful, the Resource Repair Action menu displays.

After replacing that FRU, you must select the resource for that FRU from the Resource Repair Action menu. This updates the AIX error log to indicate that a system-detectable FRU has been replaced.

Note: If the check log indicator is on, this action will set it back to the normal state.

Perform the following steps:

a. From the RESOURCE REPAIR ACTION menu, select the parent or child of the resource that has been replaced. If the repair action was reseating a cable or adapter, select the resource associated with that repair action. If the resource associated with your action is not displayed on the resource list, select **sysplanar0**.

b. Press **COMMIT** after you make your selections.

c. If the No Trouble Found menu is displayed, continue with the next step.

11. If you changed the service processor or network settings, as instructed in previous MAPs, restore the settings to the value they had prior to servicing the system. If you ran stand-alone diagnostics from CD-ROM, remove the stand-alone diagnostics CD-ROM from the system.

Did you perform service on a RAID subsystem that involved changing of the PCI RAID adapter cache card or changing the configuration?

Note: This information does not apply to the PCI-X RAID adapter or cache.

No Go to the close of call procedure.

Yes Continue with the next step.

12. Use the **Recover Options** selection to resolve the RAID configuration, by completing the following steps:

a. On the PCI SCSI Disk Array Manager display, select **Recovery options**.

b. If a previous configuration exists on the replacement adapter, this must be cleared. Select **Clear PCI SCSI Adapter Configuration** and press F3.

c. On the Recovery Options screen, select **Resolve PCI SCSI RAID Adapter Configuration**.

d. On the Resolve PCI SCSI RAID Adapter Configuration screen, select **Accept Configuration on Drives**.

e. On the PCI SCSI RAID Adapter selections menu, select the adapter that you changed.

f. On the next screen, press Enter.

g. When you see the Are You Sure selection menu, press Enter to continue.

h. If you see a Failed status message, verify that you selected the correct adapter, and then repeat this procedure. When the recovery is complete, exit the operating system.

i. Go to the Closing a service call procedure.

Verifying a repair by using an IBM i system or logical partition

Use this procedure to verify a repair by using the IBM i operating system.

1. Was the system powered off during the repair?

Yes: Continue with the next step.

No: Continue with step 3.

2. Perform the following tasks:
 - a. Verify that the power cable is plugged into the power outlet.
 - b. Verify that power is available at the customer's power outlet.
3. Was the partition powered off during the repair?

Yes: Continue with the next step.

No: Continue with step 6.
4. Select the IPL type and mode for the system or logical partition that the customer uses (see IPL type mode and speed options in the Service functions).
5. Start an IPL by powering on the system or partition (see Powering on and powering off). Did the system complete the IPL?

Yes: Continue with the next step.

No: This might be a new problem. Go to the Starting a repair action. **This ends the procedure.**
6. Did the system or partition remain running throughout the repair, and was the I/O processor, I/O adapter, or storage device replaced?

Yes: Continue with step 10.

No: Continue with the next step.
7. Use the service action log or serviceable event view (if the system is managed by an HMC) to look for any reference codes that are related to this IPL (see Searching the service action log). Are there any reference codes that are related to this IPL?

Yes: Continue with the next step.

No: If the problem was related to removable media or communications, perform the verification procedures in the Service functions to verify that the problem is corrected. Then return the system to the customer and have the customer verify the system date and time. **This ends the procedure.**
8. Is the new reference code the same as the original reference code?

Yes: Continue with the next step.

No: A new symptom might have occurred. Go to the Start of call procedure. **This ends the procedure.**
9. Are there any other failing items that remain to be replaced?

Yes: Replace the next failing item listed for this reference code. **This ends the procedure.**

No: Contact your next level of support for assistance. **This ends the procedure.**
10. Was concurrent maintenance performed on an optical storage unit?

Yes: The product activity log and service action log, in most cases, contain a reference code for the optical storage unit when concurrent maintenance is performed. You can ignore this reference code. Perform the following:

 - Perform the verification procedures in the Service functions topic to verify that the problem is corrected.
 - Return the system to the customer and have the customer verify the system date and time. **This ends the procedure.**

No: Continue with the next step.
11. Use the service action log to look for any new reference codes (see Using the Service Action Log). Are there any new reference codes?

Yes: Continue with the next step.

No: Go to step 14.
12. Is the new reference code the same as the original reference code?

Yes: Continue with the next step.

No: A new symptom might have occurred. Go to the Start of call procedure to determine the cause of the problem. **This ends the procedure.**

13. Are there any other failing items that need to be replaced?
Yes: Replace the next failing item listed for the reference code. **This ends the procedure.**
No: Contact your next level of support for assistance. **This ends the procedure.**
14. Are you working with a tape device?
Yes: Perform the verification procedures in the Service functions to verify that the problem is corrected. After the verification test is complete, the tape device description will be set to the failed state because a resource change was detected. Perform the following tasks:
- Vary the tape device description off and then on.
- Return the system to the customer and have the customer verify the system date and time. Then go to Verifying the repair from the HMC. **This ends the procedure.**
No: Continue with the next step.
15. Are you working with an IOP or an IOA?
Yes: Use the display hardware configuration service function to check for any missing or failed hardware:
- On the command line, enter the STRSST (Start System Service Tools command). If you cannot get to SST, select DST. Do not IPL the system or partition to get to DST.
- On the Start Service Tools Sign On display, enter the user ID with the service authority and password.
- Select **Start a service tool > Hardware service manager > Logical hardware resources > System bus resources.**
- Select the function key for **Include nonreporting resources.**
- If the IOP and IOA that you just replaced is a failed or nonreporting resource, the problem has not been fixed. Continue to the next failing item in the failing item list. **This ends the procedure.**
No: Perform the verification procedures in the Service functions topics to verify that the problem is corrected. Resources that usually vary on automatically during an IPL, or that were previously varied on manually, might need to be varied on again after the verification procedures are complete. Return the system to the customer and have the customer verify the system date and time. **This ends the procedure.**

Verifying the repair in Linux

You can use this procedure to verify that a repair is complete by using the Linux operating system.

1. Run stand-alone diagnostics from either a CD or from a Network Installation Management (NIM) server. See Running the stand-alone diagnostics from CD-ROM. **Did you encounter any problems?**
No Reboot the operating system and continue with the close of call procedure.
Yes If the original problem still exists, replace the field-replaceable unit (FRU) or perform the isolation procedure that is next in the FRU list. If you have reached the end of the FRU list, contact your next level of support.
If a new problem has occurs go to Beginning problem analysis and repair the new problem.

Verifying the repair on an IBM PowerKVM system

You can use the following procedure to verify whether a repair is complete on an IBM PowerKVM system.

1. Look for any new reference codes that might have occurred as a result of the service action that was performed. To locate the error information in a system running IBM PowerKVM, complete the following steps:
 - a. Log in as root user.
 - b. At the command line, type `opal-elog-parse -s` and press **Enter**.
 - c. Look for the most recent entry that contains a reference code.

Did a new reference code occur as a result of the service action that was performed?

- **Yes:** Continue with the next step.
- **No:** Continue with step 4.

2. The reference code description might provide information or an action that you can take to correct the failure.

Use the search function of IBM Knowledge Center to find the reference code details. The search function is located in the upper-left corner of IBM Knowledge Center. Read the reference code description and return here. Do not take any other action at this time.

For more information about reference codes, see Reference codes.

Was there a reference code description that enabled you to resolve the problem?

- **Yes: This ends the procedure.**
- **No:** Continue with the next step.

3. Service is required to resolve the error. Collect as much error data as possible and record it. You and your service provider will develop a corrective action to resolve the problem based on the following guidelines:

- If a field-replaceable unit (FRU) location code is provided, that location must be used to determine which FRU to replace.
- If an isolation procedure is listed for the reference code in the reference code lookup information, include it as a corrective action even if it is not listed in the serviceable event view or control panel.
- If any FRUs are marked for block replacement, replace all FRUs in the block replacement group at the same time.

Complete the following steps:

- a. Record the reference code if available.
- b. Record the error details.
- c. Run the `sosreport` command to collect debug data.
- d. Contact your service provider.

This ends the procedure.

4. Was a disk drive, solid-state drive, media device, or I/O adapter replaced when the system was powered off?
 - **Yes:** Perform Running diagnostics on an IBM PowerKVM system. **This ends the procedure.**
 - **No:** Continue with the "Closing a service call" on page 71 procedure. **This ends the procedure.**

Verifying the repair from the management console

Perform these procedures to close problem numbers, clear hardware messages, and prepare the server to return to the customer by using the management console.

Follow this checklist before performing the procedures:

- You return the server to the state that the customer normally uses, such as IPL type, IPL mode, and the way the system is configured or partitioned.
 - While you were performing the problem analysis on the original serviceable event, other serviceable-event numbers might have been opened. Close all serviceable events that were opened as a result of your service activity.
 - Server verification has been performed and there are no problems that require additional service actions.
 - If the repair was done by using the HMC online repair procedures, ensure that the original serviceable event is now closed.
1. Is a management console used to manage the server that you are servicing?
 - **Yes:** Continue with the next step.

- **No:** Return to the “Verifying a repair” on page 60. **This ends the procedure.**
2. Are you closing a service event that was a repair on the management console personal computer?
 - **Yes:** Continue with the next step.
 - **No:** Go to step 4.
 3. Power on the management console. Did the power-on process complete without errors?
 - **Yes:** Ensure that the management console can be used to perform server management tasks, and return the management console to normal operations. Go to “Closing a service call” on page 71. **This ends the procedure.**
 - **No:** Go to the *HMC isolation procedures*. **This ends the procedure.**
 4. Log into the management console as the service representative. If invalid user or invalid password is displayed, get the correct login information from the system administrator.
 - a. If logged into the System Manager, select **Exit from the Console**, located in the System Manager window.
 - b. Log in to the System Manager with the following:
 - User identification - service
 - Password - service mode
 5. View Serviceable Event Details.
 - a. In the navigation area, click **Service Applications**.
 - b. In the navigation area, click **Service Focal Point**.
 - c. In the Contents area, click **Manage Serviceable Events**.
 - d. Designate the set of Serviceable Events you want to view. When you are finished, click **OK**. The **Service Event Overview** window opens.

Note: Only the events that match all of the criteria you specify are shown.
 6. Close open or delayed events.
 - a. Select the problem to close in the Service Event Overview window.
 - b. Select the **Selected** menu, located on the menu bar.
 - c. Click **Close Event**.
 - d. Enter your comments in the **Serviceable Event Comments** window, and click **Close Event**.
 - e. Close all events associated with the problem on which you were working.
 7. Did the Service Event Overview window contain the event or events on which you were working?
 - **Yes:** Return the HMC to normal operations. Go to “Closing a service call” on page 71. **This ends the procedure.**
 - **No:** Go to Detecting problems. **This ends the procedure.**

Activating and deactivating LEDs

You can use these procedures to activate or deactivate light-emitting diodes (LEDs) by using the management console or the Advanced System Management Interface (ASMI).

The system attention LED is activated when an error that requires a service action is detected, but a fault LED is not activated. Such errors can include errors that generate a system reference code (SRC) or a service request number (SRN). On systems that support fault LEDs, a fault LED is activated for many problems that can be isolated to a specific hardware component. However, for some problems that require a service action, a fault LED might not be activated even if a problem can be isolated to a specific hardware component. For those problems, the system attention LED is activated instead.

For IBM Power Systems servers that contain the POWER8 processor, the LEDs can be used to identify or verify a part that you are servicing. The error and identify function (amber) LED indicates an error and corresponds to the location code in the system reference code (SRC). The LED is activated and deactivated automatically.

Additionally, the following procedures can also be used to activate and deactivate LEDs.

- “Deactivating a system attention LED or partition LED by using the management console”
- “Activating or deactivating an identify LED by using the management console” on page 69
- “Deactivating a system attention LED or logical partition LED by using the Advanced System Management Interface” on page 70
- “Activating or deactivating an identify LED by using the Advanced System Management Interface” on page 70

Deactivating a system attention LED or partition LED by using the management console

You can deactivate a system attention LED or a logical partition LED if you decide that a problem is not a high priority and you decide to repair the problem at a later time. You can do this task from the Hardware Management Console (HMC).

If you want to be alerted if another problem occurs, you must deactivate the system attention LED so that it can be activated again if another problem occurs.

To deactivate a system attention LED by using the HMC, choose one of the following navigation options depending on the interface type of the HMC:

- If you are using an HMC Classic or HMC Enhanced interface, complete the following steps:
 1. In the navigation area, click **Systems management > Servers**.
 2. To enable the tasks for that server, select the required server name.
 3. From the **Tasks** menu, click **Operations > LED Status**
 4. Click **Identify LED**. The Identify LED window opens. The selected system and its LED state are displayed in the upper part of the window. The logical partition and its LED state are displayed in the lower part of the window. From the Identify LED window, you can deactivate both the System attention LED and the logical partition LED.
 5. Click **Deactivate Attention LED**. A confirmation window is displayed that provides the following information:
 - A verification that the system attention LED was deactivated.
 - An indication that there still might be open problems within the system.
 - An indication that you cannot activate the system attention LED.
 6. Select one of the logical partitions in the lower table, and click **Deactivate partition LED**. A confirmation window is displayed that provides the following information:
 - A verification that the logical partition LED was deactivated.
 - An indication that there still might be open problems within the logical partition.
 - An indication that you cannot activate the logical partition LED.
- If you are using an HMC Enhanced+ interface, complete the following steps:



1. In the navigation area, click the **Resources** icon  , and then click **All Systems**.
2. To view the actions for that server, select the server name of the required server.
3. In the navigation area, click **System Actions > Attention LED**.

4. Click **Identify Attention LED**. The Identify LED window opens. The selected system and its LED state are displayed in the upper part of the window. The logical partition and its LED state are displayed in the lower part of the window. From the Identify LED window, you can deactivate both the System attention LED and the logical partition LED.
5. Click **Turn Attention LED Off**. A confirmation window is displayed that provides the following information:
 - A verification that the system attention LED was deactivated.
 - An indication that there still might be open problems within the system.
 - An indication that you cannot activate the system attention LED.
6. Select one of the logical partitions in the lower table, and click **Turn Attention LED Off**. A confirmation window is displayed that provides the following information:
 - A verification that the logical partition LED was deactivated.
 - An indication that there still might be open problems within the logical partition.
 - An indication that you cannot activate the logical partition LED.

Activating or deactivating an identify LED by using the management console

You can activate or deactivate an identify LED for components attached to the system from the Hardware Management Console (HMC).

The system provides several LEDs that help identify various components in the system, such as enclosures or field-replaceable units (FRUs). For this reason, they are called *identify LEDs*.

You can activate or deactivate the following types of identify LEDs:

- **Identify LED for an enclosure.** If you want to add an adapter to a specific drawer (enclosure), you need to know the machine type, model, and serial number (MTMS) of the drawer. To determine whether you have the correct MTMS for the drawer that needs the new adapter, you can activate the LED for a drawer and verify that the MTMS corresponds to the drawer that requires the new adapter.
- **Identify LED for a FRU associated with a specified enclosure.** If you want to hook up a cable to a specific I/O adapter, you can activate the LED for the adapter, which is a field replaceable unit (FRU), and then physically check to see where you should connect the cable. This is especially useful when you have several adapters with open ports.

To activate or deactivate an identify LED for an enclosure or FRU, choose one of the following navigation options depending on the interface type of the HMC:

- If you are using an HMC Classic or HMC Enhanced interface, complete the following steps:
 1. In the navigation area, click **Systems management > Servers**.
 2. To enable the tasks for that server, select the required server name.
 3. From the **Tasks** menu, click **Operations > LED Status > Identify LED**. The Identify LED, Select Enclosure window is displayed.
 4. To activate or deactivate an identify LED for an enclosure, select an enclosure from the table, and click either **Activate LED** or **Deactivate LED**. The associated LED is either turned on or off.
 5. To activate or deactivate an identify LED for a FRU, select an enclosure from the table, and then click **Selected > List FRUs**.
 6. Select one or more FRUs from the table, and click either **Activate LED** or **Deactivate LED**. The associated LED is either turned on or off.
- If you are using an HMC Enhanced+ interface, complete the following steps:



1. In the navigation area, click the **Resources** icon , and then click **All Systems**.

2. To view the actions for that server, select the required server.
3. In the navigation area, click **System Actions > Attention LED > Identify Attention LED**. The Identify Attention LED, Select Enclosure window is displayed.
4. To activate or deactivate an identify LED for an enclosure, select an enclosure from the table, and click either **Activate LED** or **Deactivate LED**. The associated LED is either turned on or off.
5. To activate or deactivate an identify LED for a FRU, select an enclosure from the table, and then click **Selected > List FRUs**.
6. Select one or more FRUs from the table, and click either **Activate LED** or **Deactivate LED**. The associated LED is either turned on or off.

Deactivating a system attention LED or logical partition LED by using the Advanced System Management Interface

You can deactivate a system attention LED or a logical partition LED by using the Advanced System Management Interface (ASMI).

The check log indicator provides a visual signal that the system as a whole requires attention or service. Each system has a single check log indicator. When an event occurs that either needs your intervention or that of service and support, the check log indicator lights continuously. The check log indicator is turned on when an entry is made in the service processor error log. The error entry is transmitted to the system error log and to the operating system error log.

To perform this operation, your authority level must be one of the following levels:

- Administrator
- Authorized service provider

To turn off the check log indicator, do the following steps:

1. In the ASMI Welcome pane, specify your user ID and password, and click **Log In**.
2. In the navigation area, expand **System Configuration > Service Indicators > System Attention Indicator**.
3. In the right pane, click **Turn off system attention indicator**. If the attempt is unsuccessful, an error message is displayed.

Activating or deactivating an identify LED by using the Advanced System Management Interface

You can activate or deactivate an identify LED by using the Advanced System Management Interface (ASMI).

You can specify the location code of any indicator to view or modify its current state. If you provide the wrong location code, the advanced system manager attempts to go to the next higher level of the location code.

The next level is the base-level location code for that field replaceable unit (FRU). For example, a user types the location code for the FRU located on the second I/O slot of the third enclosure in the system. If the location code for the second I/O slot is incorrect (the FRU does not exist at this location), an attempt to set the indicator for the third enclosure is initiated. This process continues until a FRU is located or no other level is available.

To perform this operation, your authority level must be one of the following levels:

- Administrator
- Authorized service provider

To change the current state of an indicator, do the following steps:

1. On the ASMI Welcome pane, specify your user ID and password, and click **Log In**.
2. In the navigation area, expand **System Configuration > Service Indicators > Indicators by Location code**.
3. In the right pane, enter the location code of the FRU and click **Continue**.
4. Select the preferred state from the list.
5. Click **Save settings**.

Closing a service call

Perform these procedures to close serviceable events, clear hardware messages, and prepare the server to return to the customer.

Follow this checklist before performing the procedure:

- Return the server to the state that the customer normally uses such as IPL type, IPL mode, and the way the system is configured or partitioned.
 - While you were performing the problem analysis on the original serviceable event, other serviceable events might have been opened. Close all serviceable events that were opened as a result of your service activity.
 - Ensure that server verification has been performed and no problems require additional service actions.
 - If the repair was done using the management console online repair procedures, ensure that the original serviceable event is now closed.
1. Record the system reference code (SRC), or symptom, and the location code of the field-replaceable unit (FRU) you replaced, for future reference. Is the server managed by a management console?
 - **Yes:** Continue with the next step.
 - **No:** Do one of the following steps:
 - If the server is managed by Integrated Virtualization Manager (IVM), go to “Closing a service call by using Integrated Virtualization Manager” on page 77.
 - If the server is not partitioned and is running the AIX or Linux operating system, go to “Closing a service call by using AIX or Linux” on page 74.
 - If the server is running IBM PowerKVM, go to “Closing a service call by using IBM PowerKVM” on page 77.
 2. Choose one of the following navigation options depending on the interface type of the Hardware Management Console (HMC):
 - If you are using an HMC Classic or HMC Enhanced interface, complete the following steps:
 - a. In the navigation area, click **Systems management**.
 - b. In the content pane, click **Manage Serviceable Events**.
 - c. Examine the service action event log for any open service action events.
 - If you are using an HMC Enhanced+ interface, complete the following steps:
 - a. In the navigation area, click the **Serviceability** icon , and then click **Serviceable Events Manager**.
 - b. Examine the service action event log for any open service action events.
 3. Are any service action events open?
 - **Yes:** Continue with the next step.
 - **No:** If the system attention LED is still on, turn off the LED as described in “Activating and deactivating LEDs” on page 67. Return the system to the customer. **This completes the repair.**
 4. Record the list of open service action events.

5. From the list of serviceable events recorded in step 4 on page 71, complete the following steps 6 - step 32 on page 73 for each open service action event.
6. Determine the error class of the serviceable event. Record for future use.
7. Examine the details of the open service action event.
Is the error code that is associated with this service action event the same as recorded in step 1 on page 71?
 - **Yes:** Go to step 11.
 - **No:** Continue with the next step.
8. Examine the FRU list of the service action event. Are any FRUs listed for the service action event?
 - **Yes:** Continue with the next step.
 - **No:** Go to step 11.
9. Is the FRU list identical that is, the same FRUs, same number of FRUs, and same order of FRUs) to the FRU list of the error code recorded in step 1 on page 71?
 - **Yes:** Go to step 11.
 - **No:** Continue with the next step.
10. The FRU list is different. Is the FRU you replaced and recorded in step 1 on page 71 in the list of FRUs for this service action event?
 - **Yes:** Continue with the next step.
 - **No:** Go to step 32 on page 73.

Note: Some service action events will remain open when you leave this MAP. Further service actions might be required to complete the repair.

11. Examine the details of this service action event, and record the partitions involved in this service action event for use in a later step.
12. Is the error code associated with this service action event of the form A11-xxx or A01-xxx?
 - **Yes:** Continue with the next step.
 - **No:** Go to step 17.
13. Have you begun a list of Axx partitions from prior service action events that you processed in this MAP?
 - **Yes:** Go to step 15.
 - **No:** Continue with the next step.
14. Begin a new list of Axx partitions by copying the list of partitions obtained in step 11. Go to step 16.
15. Add the partition list obtained in step 11 to the existing list of Axx partitions obtained from processing previous service action events in this maintenance analysis procedure (MAP).
16. Remove all entries in the list of all partitions you recorded in step 11. If you are referred to the list of partitions obtained in step 11 in future steps, the list is empty. Go to step 17.
17. Select and highlight the service action event from the Error Associated With This Serviceable Event window.
18. Click **Close Event**.
19. Add comments for the serviceable event. Include any unique additional information. Click **OK**. The following steps will add or update FRU information.
20. Did you replace, add, or modify a FRU of the open service action event?
 - **Yes:** Continue with the next step.
 - **No:** Go to step 22.
21. From the FRU list, select a FRU that you need to update. Double-click the FRU, and update the FRU information. Go to step 23.
22. Select the **No FRU Replaced for this Serviceable Event** option.
23. Click **OK** to close the service action event.

24. Is the list of all partitions you recorded in step 11 on page 72 empty?
 - **Yes:** Go to step 32.
 - **No:** Continue with the next step.
25. Does the list of all partitions you recorded in step 11 on page 72 contain more than one entry?
 - **Yes:** Continue with the next step.
 - **No:** Go to step 32.
26. Is the error class recorded in step 25 AIX?
 - **Yes:** Continue with the next step.
 - **No:** Go to step 32.
27. Perform all the following steps for each entry in the list of all partitions you recorded in step 11 on page 72, except for the partition you were using to debug the original problem.
28. From the list of all partitions, open the HMC virtual terminal window of a partition, and then type `diag` at the AIX command prompt.
29. When the diagnostic operating instructions are displayed, complete the following steps:
 - a. Press Enter.
 - b. Select the **Task Selection** option.
 - c. Select the **Log Repair** option.
 - d. Select the resource associated with the repair action:
 - If the repair action was reseating a cable or adapter, select the resource associated with that repair action.
 - If the resource associated with your repair action is not displayed on the Resource List, select **sysplanar0**.
 - e. Click **Commit** after you make your selection.

Note: If the terminal type is not defined, you are prompted to define it before you can proceed.
30. Exit from diagnostics in this partition and return to the AIX command prompt.
31. Have all the partitions in the list of all the partitions you recorded in step 11 on page 72 been processed?
 - **Yes:** Continue with the next step.
 - **No:** Go to step 24 to process the next partition in the list you recorded in step 11 on page 72.
32. Have all the serviceable events recorded in step 4 on page 71 been processed?
 - **Yes:** Continue with the next step.
 - **No:** Go to step 5 on page 72 and process the next service action event in the list of serviceable events recorded in step 4 on page 71.
33. While processing all service action events, were you directed to step 14 on page 72?
 - **Yes:** Continue with the next step.
 - **No:** If the system attention LED is still on, turn off the LED as described in “Activating and deactivating LEDs” on page 67. Return the system to the customer. **This completes the repair.**

Note: If, during the processing of the list of open service action events, some service action events remained open, further service actions might be required to complete the repair.
34. Perform all the following steps for each entry in the list of *Axx* partitions you began recording in step 14 on page 72, except for the partition you were using to debug the original problem.
35. From the list of *Axx* partitions, open the management console virtual terminal window of a partition , and then type `diag` at the AIX command prompt.
36. When the diagnostic operating instructions are displayed, complete the following steps:
 - a. Press Enter.
 - b. Select the **Task Selection** option.

Note: If the terminal type is not defined, you are prompted to define it before you can proceed.

- c. Select the resource associated with the repair action:
 - If the repair action was reseating a cable or adapter, select the resource associated with that repair action.
 - If the resource associated with your repair action is not displayed on the Resource List, select **sysplanar0**.
- d. Click **Commit** after you make your selection.

37. Exit from diagnostics in this partition and return to the AIX command prompt.

38. Have all the partitions in the list of Axx partitions you began recording in step 14 on page 72 been processed?

- **Yes:** Continue with the next step.
- **No:** Go to step 34 on page 73 to process the next partition in the list you recorded in step 14 on page 72.

39. If the system attention LED is still on, turn off the LED as described in “Activating and deactivating LEDs” on page 67. **This completes the repair.** Return the system to the customer.

Note: If, during the processing of the list of open service action events, some service action events remained open, further service actions might be required to complete the repair.

Closing a service call by using AIX or Linux

If the server is not connected to a management console and not using Integrated Virtualization Manager (IVM), perform these procedures to close serviceable events, clear hardware messages, and prepare the server to return to the customer.

Follow this checklist before performing the procedure:

- Return the server to the state that the customer normally uses, such as IPL type, IPL mode, and the way the system is configured or partitioned.
- While you were performing the problem analysis on the original serviceable event, other serviceable-event numbers might have been opened. Close all serviceable events that were opened as a result of your service activity.
- Ensure that server verification has been performed and that no problems require additional service actions.
- If the repair was done by using the IVM online repair procedures, ensure that the original serviceable event is now closed.

1. Did you use a hot-swap operation by using an AIX diagnostics service aid to change the FRU?

- **Yes:** Go to step 4 on page 75
- **No:** Continue with the next step.

2. Do you have any field-replaceable units (FRUs) (for example cards, adapters, cables, or devices) that were removed during problem analysis that you want to put back into the system?

Note: If the system backplane or battery has been replaced and you are loading diagnostics from a server over a network, it might be necessary for the customer to set the network boot information for this system before diagnostics can be loaded. Also, set the system time and date information after the repair is completed.

- **Yes:** Reinstall all of the FRUs that were removed during problem analysis. Go to step 3
- **No:** Continue with the next step.

3. Is the system or logical partition that you are performing a repair action on running the AIX operating system?

- **Yes:** Continue with the next step.
- **No:** Go to step 5 on page 75.

4. Does the system or logical partition you are performing a repair action on have the AIX operating system installed?

Note: If you have just replaced a hard disk in the root volume group, answer no to this question.

- **Yes:** Go to step 7.
- **No:** Continue with the next step.

5. Run stand-alone diagnostics in problem determination mode from either a CD-ROM or from a Network Installation Management (NIM) server.

Note: For instructions about running stand-alone diagnostics from a CD and not by using an HMC, go to Running the stand-alone diagnostics from CD on a server without an HMC attached.

For instructions about running stand-alone diagnostics from a NIM server, go to Running the stand-alone diagnostics from a Network Installation Management server.

Did you encounter any problems?

- **Yes:** Go to Problem analysis.
- **No:** Continue with the next step.

6. The system hardware is functioning correctly.

If the system attention LED is still on, turn off the LED as described in “Activating and deactivating LEDs” on page 67.

This completes the repair.

Note: If, during the processing of the list of open service action events, some service action events remained open, further service actions might be required to complete the repair.

Return the server to the state that the customer normally uses, such as IPL type, IPL mode, and the way the system is configured or partitioned. This might require you to reboot the operating system.

7. Complete the following steps:

- a. Restart the system.
- b. Wait until the AIX operating system login prompt is displayed or until system activity on the operator panel or display has stopped.

Did the AIX Login Prompt display?

- **Yes:** Continue with the next step.
- **No:** Go to Problem analysis.

8. If the Resource Repair Action menu is already displayed, go to 12 on page 76; otherwise, complete the following steps:

- a. Log into the operating system, either with root authority (if needed, ask the customer to enter the password) or use the CE login.
- b. Enter the `diag -a` command and check for missing resources. Follow any instructions that are displayed. If a system request number (SRN) is displayed, suspect a loose card or connection. If no instructions are displayed, no resources were detected as missing. Continue with step 9.

9. Complete the following steps:

- a. Enter `diag` at the command prompt and press **Enter**.
- b. Select the **Diagnostics Routines** option.
- c. When the Diagnostic Mode Selection menu is displayed, select **Problem determination**.
- d. When the Advanced Diagnostic Selection menu is displayed, select the **All Resources** option. Alternatively, test the FRUs you exchanged and any devices that are attached to the FRUs you exchanged by selecting the diagnostics for the individual FRU.

Did the Resource Repair Action menu (801015) display?

- **Yes:** Go to step 13 on page 76.

- **No:** Continue with the next step.
10. Did the TESTING COMPLETE, no trouble was found menu (801010) display?
- **Yes:** Continue with the next step.
 - **No:** There is still a problem. Go to Problem analysis.
11. Select the **Log Repair Action** option, if not previously logged, in the TASK SELECTION menu to update the AIX error log. If the repair action was reseating a cable or adapter, select the resource associated with that repair action.

If the resource associated with your action is not displayed on the resource list, select **sysplanar0**.

Note: If the check log indicator is on, this will set it back to the normal state. Go to step 14.

12. Run a test on a resource that has an entry in the AIX error log, in the system verification mode. If the test on the resource was successful, the Resource Repair Action menu is displayed.
- After replacing a FRU, select the resource for that FRU from the Resource Repair Action menu. This updates the AIX error log to indicate that a system-detectable FRU has been replaced.

Note: If the check log indicator is on, this action will set it back to the normal state.

To select the resource for the replaced FRU, complete the following steps:

- a. Select the resource associated with the repair action:
- If the repair action was reseating a cable or adapter, select the resource associated with that repair action.
 - If the resource associated with your repair action is not displayed on the Resource List, select **sysplanar0**.
- b. Click **Commit** after you make your selection.

Did another Resource Repair Action (801015) display?

- **Yes:** Continue with the next step.
 - **No:** If the No Trouble Found menu is displayed, go to step 14.
13. Run a test on a resource that has an entry in the AIX error log, in the system verification mode. If the test on the resource was successful, the Resource Repair Action menu is displayed.

Note: The parent or child of the resource you just replaced might also require that you run the Resource Repair Action service aid on it.

After replacing that FRU, select the resource for that FRU from the Resource Repair Action menu. This updates the AIX error log to indicate that a system-detectable FRU has been replaced.

Note: If the check log indicator is on, this action will set it back to the normal state.

To select the resource for the replaced FRU, complete the following steps:

- a. Select the resource associated with the repair action:
- If the repair action was reseating a cable or adapter, select the resource associated with that repair action.
 - If the resource associated with your repair action is not displayed on the Resource List, select **sysplanar0**.
- b. Click **Commit** after you make your selection.

Did the No Trouble Found menu display?

- **Yes:** Continue with the next step.
 - **No:** Go to Problem analysis.
14. If you changed the service processor or network settings, as instructed in previous MAPs, restore the settings to the value they had prior to servicing the system. If you ran stand-alone diagnostics from CD-ROM, remove the stand-alone diagnostics CD-ROM from the system.

Did you perform service on a RAID subsystem that involved changing the PCI RAID adapter cache card or changing the configuration?

Note: This does not refer to the PCI-X RAID adapter or cache.

- **Yes:** Continue with the next step.
 - **No:** Go to step 16.
15. Use the **Recover Options** selection to resolve the RAID configuration, by completing the following steps:
 - a. On the PCI SCSI Disk Array Manager dialog, select **Recovery options**.
 - b. Select **Clear PCI SCSI Adapter Configuration** and press F3 to clear any previous configuration data that exists on the replacement adapter.
 - c. On the Recovery Options dialog, select **Resolve PCI SCSI RAID Adapter Configuration**.
 - d. On the Resolve PCI SCSI RAID Adapter Configuration dialog, select **Accept Configuration on Drives**.
 - e. On the PCI SCSI RAID Adapter selections menu, select the adapter that you changed.
 - f. On the next dialog, press Enter.
 - g. When you see the Are You Sure selection menu, press Enter to continue. When the recovery action is complete, the status message of **OK** is shown.
 - h. If you receive a status message of **Failed**, verify that you selected the correct adapter, and then repeat this procedure. When recovery is complete, exit the operating system.
 - i. Go to step 16.
 16. The system hardware is functioning correctly. Return the server to the state that the customer normally uses, such as IPL type, IPL mode, and the way the system is configured or partitioned.

Closing a service call by using IBM PowerKVM

Perform the following steps to prepare the server to return to the customer.

Consider the following prerequisites before performing the procedure:

- Return the server to the state that the customer normally uses, such as IPL type, IPL mode, and the way the system is configured or partitioned.
 - Ensure that server verification has been performed and that no problems require additional service actions.
1. Do you have any field-replaceable units (FRUs) (for example, cards, adapters, cables, or devices) that were removed during problem analysis that you want to replace in the system?
 - **Yes:** Reinstall all of the FRUs that were removed during problem analysis. Continue with the next step.
 - **No:** Continue with the next step.
 2. Have you already performed “Verifying a repair” on page 60?
 - **Yes:** Continue with the next step.
 - **No:** Perform “Verifying a repair” on page 60. Then continue with the next step.
 3. The system hardware is functioning correctly.

If the check log LED is still on, turn off the LED as described in “Activating and deactivating LEDs” on page 67.

Closing a service call by using Integrated Virtualization Manager

Perform these procedures to close serviceable events, clear hardware messages, and prepare the server to return to the customer.

Follow this checklist before performing the procedure:

- Return the server to the state that the customer normally uses, such as IPL type, IPL mode, and the way the system is configured or partitioned.
- While you were performing the problem analysis on the original serviceable event, other serviceable-event numbers might have been opened. Close all serviceable events that were opened as a result of your service activity.
- Ensure that server verification has been performed and there are no problems that require additional service actions.
- If the repair was done by using the Integrated Virtualization Manager (IVM) online repair procedures, ensure that the original serviceable event is now closed.
 1. Record the system reference code (SRC), or symptom, and the location code of the field-replaceable unit (FRU) you replaced for future reference.
 2. On the IVM, open **Manage Serviceable Events** and look at existing serviceable events.
 3. Are there any service action events that are open?
 - **Yes:** Continue with the next step.
 - **No:** If the system attention LED is still on, turn off the LED as described in “Activating and deactivating LEDs” on page 67. Return the system to the customer. **This completes the repair.**
 4. Record the list of open service action events.
 5. From the list of serviceable events recorded in step 4, complete steps 6 - 30 on page 79 for each open service action event.
 6. Determine the error class of the serviceable event. Record it for future use.
 7. Examine the details of the open service action event.

Is the error code associated with this service action event the same as recorded in step 1?

 - **Yes:** Go to step 11.
 - **No:** Continue with the next step.
 8. Examine the FRU list of the service action event. Are any FRUs listed for the service action event?
 - **Yes:** Continue with the next step.
 - **No:** Go to step 11.
 9. Is the FRU list identical that is, the same FRUs, same number of FRUs, and same order of FRUs) to the FRU list of the error code recorded in step 1?
 - **Yes:** Go to step 11.
 - **No:** Continue with the next step.
 10. Is the FRU you replaced and recorded in step 1 in the list of FRUs for this service action event?
 - **Yes:** Continue with the next step.
 - **No:** Go to step 30 on page 79.

Note: Some service action events remain open when you leave this MAP. Further service actions might be required to complete the repair.
 11. Examine the details of this service action event, and record the partitions involved in this service action event for use in a later step.
 12. Is the error code associated with this service action event of the form A11-xxx or A01-xxx?
 - **Yes:** Continue with the next step.
 - **No:** Go to step 17 on page 79.
 13. Have you begun a list of Axx partitions from prior service action events that you processed in this maintenance analysis procedure (MAP)?
 - **Yes:** Go to step 15 on page 79.
 - **No:** Continue with the next step.
 14. Begin a new list of Axx partitions by copying the list of partitions obtained in step 11. Go to step 16 on page 79.

15. Add the partition list obtained in step 11 on page 78 to the existing list of Axx partitions obtained from processing previous service action events in this MAP.
16. Remove all entries in the list of all partitions you recorded in step 11 on page 78. If you are referred to the list of partitions obtained in step 11 on page 78 in future steps, the list is empty. Go to step 17.
17. Select and highlight the service action event from the Manage Serviceable Events window.
18. Click **Close Event**.
19. Add comments for the serviceable event. Include any unique additional information. Click **OK**.
20. Add or update the FRU information:

Did you replace, add, or modify a FRU of the open service action event?

 - **Yes:** Continue with the next step.
 - **No:** Go to step 22.
21. Click **OK** to close the service action event.
22. Is the list of all partitions you recorded in step 11 on page 78 empty?
 - **Yes:** Go to step 30.
 - **No:** Continue with the next step.
23. Does the list of all partitions you recorded in step 11 on page 78 contain more than one entry?
 - **Yes:** Continue with the next step.
 - **No:** Go to step 30.
24. Is the error class recorded in step 23?
 - **Yes:** Continue with the next step.
 - **No:** Go to step 30.
25. Perform all the following steps for each entry in the list of all partitions you recorded in step 11 on page 78, except for the partition you were using to debug the original problem.
26. From the list of all partitions, open the IVM virtual terminal window of a partition, and then type `diag` at the AIX command prompt.
27. When the diagnostic operating instructions are displayed, complete the following steps:
 - a. Press Enter.
 - b. Select the **Task Selection** option.
 - c. Select the **Log Repair** option.
 - d. Select the resource associated with the repair action:
 - If the repair action was reseating a cable or adapter, select the resource associated with that repair action.
 - If the resource associated with your repair action is not displayed on the Resource List, select `sysplanar0`.
 - e. Click **Commit** after you make your selection.

Note: If the terminal type is not defined, you are prompted to define it before you can proceed.
28. Exit from diagnostics in this partition and return to the AIX command prompt.
29. Have all the partitions in the list of all partitions you recorded in step 11 on page 78 been processed?
 - **Yes:** Continue with the next step.
 - **No:** Go to step 25 to process the next partition in the list you recorded in step 11 on page 78.
30. Have all the serviceable events recorded in step 4 on page 78 been processed?
 - **Yes:** Continue with the next step.
 - **No:** Go to step 5 on page 78 and process the next service action event in the list of serviceable events recorded in step 4 on page 78.
31. While processing all service action events, were you directed to step 14 on page 78?

- **Yes:** Continue with the next step.
- **No:** If the system attention LED is still on, turn off the LED as described in “Activating and deactivating LEDs” on page 67. Return the system to the customer. **This completes the repair.**

Note: If during the processing of the list of open service action events, some service action events remained open, further service actions might be required to complete the repair.

32. Complete all the following steps for each entry in the list of Axx partitions you began recording in step 14 on page 78, except for the partition you were using to debug the original problem.
33. From the list of Axx partitions, open the management console virtual terminal window of a partition , and then type `diag` at the AIX command prompt.
34. When the diagnostic operating instructions are displayed, complete the following steps:
 - a. Press Enter.
 - b. Select the **Task Selection** option.

Note: If the terminal type is not defined, you are prompted to define it before you can proceed.

- c. Select the **Log Repair** option.
 - d. Select the resource associated with the repair action:
 - If the repair action was reseating a cable or adapter, select the resource associated with that repair action.
 - If the resource associated with your repair action is not displayed on the Resource List, select `sysplanar0`.
 - e. Click **Commit** after you make your selection.
35. Exit from diagnostics in this partition and return to the AIX command prompt.
 36. Have all the partitions in the list of Axx partitions you began recording in step 14 on page 78 been processed?
 - **Yes:** Continue with the next step.
 - **No:** Go to step 32 to process the next partition in the list you recorded in step 14 on page 78.
 37. If the system attention LED is still on, turn off the LED as described in “Activating and deactivating LEDs” on page 67. **This completes the repair.** Return the system to the customer.

Note: If, during the processing of the list of open service action events, some service action events remained open, further service actions might be required to complete the repair.

Deactivating an identify LED

Learn how to deactivate an identifying LED for a part or enclosure.

Deactivating a system attention LED by using the operating system or VIOS tools

You can use the AIX, IBM i, or Linux operating system, or the Virtual I/O Server (VIOS) tools to deactivate a system attention LED.

Deactivating the indicator light for a part by using AIX diagnostics

Use this procedure to turn off any indicator light that you turned on as a part of a service action.

To deactivate the indicator light, complete the following steps:

1. Log in as root user.
2. At the command line, type `diag` and press Enter.
3. From the **Function Selection** menu, select **Task Selection** and press Enter.
4. From the **Task Selection** menu, select **Identify and Attention Indicators** and press Enter.

5. From the list of lights, select the location code for the part and press Enter. When a light is activated for a part, an I character precedes the location code.
6. Select **Commit**.
7. Exit to the command line.

Deactivating the indicator light by using the IBM i operating system

Use this procedure to turn off any indicator light that you turned on as a part of a service action.

To deactivate the indicator light, follow these steps:

1. Sign on to an IBM i session, **with at least service level authority**.
2. On the command line of the session, type `strsst` and press Enter.

Note: If you cannot get to the System Service Tools display, use function 21 from the control panel. Alternatively, if the system is managed by a Hardware Management Console (HMC), use the Service Focal Point utilities to get to the Dedicated Service Tools (DST) display.

3. Type your service tools user ID and service tools password on the System Service Tools (SST) Sign On display and press Enter.

Remember: The service tools password is case-sensitive.

4. Select **Start a service tool** from the System Service Tools (SST) display and press Enter.
5. Select **Hardware service manager** from the Start a Service Tool display and press Enter.
6. Select **Work with service action log** from the Hardware Service Manager display and press Enter.
7. On the Select Timeframe display, change the **From: Date and Time** field to a date and time prior to when the problem occurred.
8. Search for an entry that matches one or more conditions of the problem:
 - System reference code
 - Resource
 - Date and time
 - Failing item list
9. Select option 2 (Display failing item information) to display the service action log entry.
10. Select option 2 (Display details) to display location information for the failing part to be replaced. The information displayed in the date and time fields is the date and time for the first occurrence of the specific system reference code for the resource displayed during the time range selected.
11. Select option 7 (Indicator off) to turn off the indicator light.
12. Select the **Acknowledge all errors** function at the bottom of the Service Action Log display, if all problems have been resolved.
13. Close the log entry by selecting option 8 (Close new entry) on the Service Action Log Report display.

Deactivating the indicator light by using the Linux operating system

After you complete a removal and replacement procedure, you can deactivate the indicator light.

To deactivate the indicator light, complete the following steps:

1. Log in as root user.
2. At the command line, type `/usr/sbin/usysident -s normal -l location_code` and press Enter.

Related information:

 Service and productivity tools for Linux on Power servers

IBM provides hardware diagnostic aids and productivity tools, and installation aids for Linux operating systems on IBM Power Systems servers.

Deactivating the indicator light for a part by using the VIOS tools

Use this procedure to turn off any indicator light that you turned on as a part of a service action.

To deactivate the indicator light, complete the following steps:

1. Log in as root user.
2. At the command line, type `diagmenu` and press Enter.
3. From the **Function Selection** menu, select **Task Selection** and press Enter.
4. From the **Task Selection** menu, select **Identify and Attention Indicators** and press Enter.
5. From the list of lights, select the location code for the part and press Enter. When a light is activated for a part, an I character precedes the location code.
6. Select **Commit**.
7. Exit to the command line.

Deactivating a system attention LED by using the ASMI

You can use the Advanced System Management Interface (ASMI) to deactivate a system attention LED.

Deactivating the identify LED by using the ASMI when you know the location code

Learn how to deactivate the identify LED by using the Advanced System Management Interface (ASMI) when you know the location code.

You can specify the location code of any indicator to view or modify its current state. If you provide the wrong location code, the ASMI attempts to go to the next higher level of the location code.

The next level is the base-level location code for that field replaceable unit (FRU). For example, a user types the location code for the FRU located on the second memory module slot of the third enclosure in the system. If the location code for the second memory module slot is incorrect (the FRU does not exist at this location), an attempt to set the indicator for the third enclosure is initiated. This process continues until a FRU is located or no other level is available.

To complete this operation, your authority level must be one of the following levels:

- Administrator
- Authorized service provider

To change the current state of an indicator, complete the following steps:

1. On the ASMI Welcome pane, specify your user ID and password, and click **Log In**.
2. In the navigation area, expand **System Configuration > Service Indicators > Indicators by Location code**.
3. In the **Location code** field, type the location code of the FRU and click **Continue**.
4. From the **Identify indicator status** list, select **Off**.
5. Click **Save settings**.

Deactivating the identify LED by using the ASMI when you do not know the location code

Learn how to deactivate the identify LED by using the Advanced System Management Interface (ASMI) when you do not know the location code.

You can turn off the identify indicators in each enclosure.

To complete this operation, your authority level must be one of the following levels:

- Administrator
- Authorized service provider

To disable the enclosure indicator states, complete the following steps:

1. On the ASMI Welcome pane, specify your user ID and password, and click **Log In**.
2. In the navigation area, expand **System Configuration > Service Indicators > Enclosure Indicators**. All servers and enclosures managed by the ASMI will display.
3. Select the server or enclosure with the part that needs to be replaced and click **Continue**. The location code identifiers are listed.
4. Select the location code identifier and select **Off**.
5. To save the changes made to the state of one or more FRU indicators, click **Save settings**.

Deactivating a check log indicator (system information indicator) by using the ASMI

You can deactivate a check log indicator (system information indicator) or logical partition check log indicator by using the ASMI.

The check log indicator provides a visual signal that the system as a whole requires attention or service. Each system has a single check log indicator. When an event occurs that either needs your intervention or that of service and support, the check log indicator lights continuously. The check log indicator is turned on when an entry is made in the service processor error log. The error entry is transmitted to the system error log and to the operating system error log.

To complete this operation, your authority level must be one of the following levels:

- Administrator
- Authorized service provider

To turn off the check log indicator, do the following steps:

1. In the ASMI Welcome pane, specify your user ID and password, and click **Log In**.
2. In the navigation area, expand **System Configuration > Service Indicators > System Information Indicator**.
3. In the right pane, click **Turn off system information indicator**. If the attempt is unsuccessful, an error message is displayed.

Deactivating LEDs by using the HMC

Use this procedure to deactivate LEDs by using the Hardware Management Console (HMC).

Deactivating a system attention LED or partition LED by using the HMC

Use this procedure to deactivate a system attention LED or partition LED by using the Hardware Management Console (HMC).

To deactivate an LED by using the HMC, complete the following steps:

Choose one of the following navigation options depending on the interface type of the HMC:

- If you are using an HMC Classic or HMC Enhanced interface, complete the following steps:
 1. In the navigation area, click **Systems Management > Servers**.
 2. In the content pane, select the system.
 3. From the **Tasks** menu, click **Operations > LED Status**.
 4. Click **Identify LED**. The Identify LED window opens. The selected system and its LED state are displayed in the upper part of the window. The logical partition and its LED state are displayed in the lower part of the window. From the Identify LED window, you can deactivate both the system attention LED and the logical partition LED.
 5. Click **Deactivate Attention LED**. A confirmation window is displayed that provides the following information:

- A verification that the system attention LED was deactivated.
 - An indication that there still might be open problems within the system.
 - An indication that you cannot deactivate the system attention LED.
6. Select one of the logical partitions in the lower table, and click **Deactivate partition LED**. A confirmation window is displayed that provides the following information:
- A verification that the logical partition attention LED was deactivated.
 - An indication that there still might be open problems within the logical partition.
 - An indication that you cannot deactivate the logical partition attention LED.
- If you are using an HMC Enhanced + Tech Preview (Pre-GA) or HMC Enhanced+ interface, complete the following steps:



1. In the navigation area, click the **Resources** icon , and then click **All Systems**.
2. Click the server name for which you want to deactivate the attention LED.
3. In the navigation area, click **System Actions > Attention LED**.
4. Click **Turn Attention LED Off**. A confirmation window that provides the following information is displayed.
 - A verification that the system attention LED was deactivated.
 - An indication that there still might be open problems within the system.
5. Click **OK**.

Deactivating an identify LED for a FRU by using the HMC

Learn how to deactivate an identify LED by using the Hardware Management Console (HMC).

To deactivate an identify LED for a FRU by using the HMC, complete the following steps:

1. Choose one of the following navigation options depending on the interface type of the HMC:
 - If you are using an HMC Classic or HMC Enhanced interface, complete the following steps:
 - a. In the navigation area, click **Systems Management > Servers**.
 - b. In the content pane, select the system.
 - c. Click **Tasks > Operations > LED Status > Identify LED**. The Identify LED, Select Enclosure window is displayed.
 - If you are using an HMC Enhanced + Tech Preview (Pre-GA) or HMC Enhanced+ interface, complete the following steps.



- a. In the navigation area, click the **Resources** icon , and then click **All Systems**.
 - b. To view the actions for that server, click the name of the required server.
 - c. In the navigation area, click **System Actions > Attention LED > Identify Attention LED**. The Identify LED, Select Enclosure window is displayed.
2. To deactivate an identify LED for a FRU, select an enclosure from the table, and then click **Selected > List FRUs**.
 3. Select one or more FRUs from the table, and click **Deactivate LED**. The associated LED is turned off.

Deactivating an identify LED for an enclosure by using the HMC

Learn how to deactivate an identify LED by using the Hardware Management Console (HMC).

To deactivate an identify LED for an enclosure by using the HMC, complete the following steps:

1. Choose one of the following navigation options depending on the interface type of the HMC:

- If you are using an HMC Classic or HMC Enhanced interface, complete the following steps:
 - a. In the navigation area, click **Systems Management > Servers**.
 - b. In the content pane, select the system.
 - c. Click **Tasks > Operations > LED Status > Identify LED**.
- If you are using an HMC Enhanced + Tech Preview (Pre-GA) or HMC Enhanced+ interface, complete the following steps.



- a. In the navigation area, click the **Resources** icon  , and then click **All Systems**.
 - b. To view the actions for that server, click the name of the required server.
 - c. In the navigation area, click **System Actions > Attention LED > Identify Attention LED**.
2. To deactivate an identify LED for an enclosure, select an enclosure from the table, and click **Deactivate LED**. The associated LED is turned off.

Notices

This information was developed for products and services offered in the US.

IBM may not offer the products, services, or features discussed in this document in other countries. Consult your local IBM representative for information on the products and services currently available in your area. Any reference to an IBM product, program, or service is not intended to state or imply that only that IBM product, program, or service may be used. Any functionally equivalent product, program, or service that does not infringe any IBM intellectual property right may be used instead. However, it is the user's responsibility to evaluate and verify the operation of any non-IBM product, program, or service.

IBM may have patents or pending patent applications covering subject matter described in this document. The furnishing of this document does not grant you any license to these patents. You can send license inquiries, in writing, to:

*IBM Director of Licensing
IBM Corporation
North Castle Drive, MD-NC119
Armonk, NY 10504-1785
US*

INTERNATIONAL BUSINESS MACHINES CORPORATION PROVIDES THIS PUBLICATION "AS IS" WITHOUT WARRANTY OF ANY KIND, EITHER EXPRESS OR IMPLIED, INCLUDING, BUT NOT LIMITED TO, THE IMPLIED WARRANTIES OF NON-INFRINGEMENT, MERCHANTABILITY OR FITNESS FOR A PARTICULAR PURPOSE. Some jurisdictions do not allow disclaimer of express or implied warranties in certain transactions, therefore, this statement may not apply to you.

This information could include technical inaccuracies or typographical errors. Changes are periodically made to the information herein; these changes will be incorporated in new editions of the publication. IBM may make improvements and/or changes in the product(s) and/or the program(s) described in this publication at any time without notice.

Any references in this information to non-IBM websites are provided for convenience only and do not in any manner serve as an endorsement of those websites. The materials at those websites are not part of the materials for this IBM product and use of those websites is at your own risk.

IBM may use or distribute any of the information you provide in any way it believes appropriate without incurring any obligation to you.

The performance data and client examples cited are presented for illustrative purposes only. Actual performance results may vary depending on specific configurations and operating conditions.

Information concerning non-IBM products was obtained from the suppliers of those products, their published announcements or other publicly available sources. IBM has not tested those products and cannot confirm the accuracy of performance, compatibility or any other claims related to non-IBM products. Questions on the capabilities of non-IBM products should be addressed to the suppliers of those products.

Statements regarding IBM's future direction or intent are subject to change or withdrawal without notice, and represent goals and objectives only.

All IBM prices shown are IBM's suggested retail prices, are current and are subject to change without notice. Dealer prices may vary.

This information is for planning purposes only. The information herein is subject to change before the products described become available.

This information contains examples of data and reports used in daily business operations. To illustrate them as completely as possible, the examples include the names of individuals, companies, brands, and products. All of these names are fictitious and any similarity to actual people or business enterprises is entirely coincidental.

If you are viewing this information in softcopy, the photographs and color illustrations may not appear.

The drawings and specifications contained herein shall not be reproduced in whole or in part without the written permission of IBM.

IBM has prepared this information for use with the specific machines indicated. IBM makes no representations that it is suitable for any other purpose.

IBM's computer systems contain mechanisms designed to reduce the possibility of undetected data corruption or loss. This risk, however, cannot be eliminated. Users who experience unplanned outages, system failures, power fluctuations or outages, or component failures must verify the accuracy of operations performed and data saved or transmitted by the system at or near the time of the outage or failure. In addition, users must establish procedures to ensure that there is independent data verification before relying on such data in sensitive or critical operations. Users should periodically check IBM's support websites for updated information and fixes applicable to the system and related software.

Homologation statement

This product may not be certified in your country for connection by any means whatsoever to interfaces of public telecommunications networks. Further certification may be required by law prior to making any such connection. Contact an IBM representative or reseller for any questions.

Accessibility features for IBM Power Systems servers

Accessibility features assist users who have a disability, such as restricted mobility or limited vision, to use information technology content successfully.

Overview

The IBM Power Systems servers include the following major accessibility features:

- Keyboard-only operation
- Operations that use a screen reader

The IBM Power Systems servers use the latest W3C Standard, WAI-ARIA 1.0 (www.w3.org/TR/wai-aria/), to ensure compliance with US Section 508 (www.access-board.gov/guidelines-and-standards/communications-and-it/about-the-section-508-standards/section-508-standards) and Web Content Accessibility Guidelines (WCAG) 2.0 (www.w3.org/TR/WCAG20/). To take advantage of accessibility features, use the latest release of your screen reader and the latest web browser that is supported by the IBM Power Systems servers.

The IBM Power Systems servers online product documentation in IBM Knowledge Center is enabled for accessibility. The accessibility features of IBM Knowledge Center are described in the Accessibility section of the IBM Knowledge Center help (www.ibm.com/support/knowledgcenter/doc/kc_help.html#accessibility).

Keyboard navigation

This product uses standard navigation keys.

Interface information

The IBM Power Systems servers user interfaces do not have content that flashes 2 - 55 times per second.

The IBM Power Systems servers web user interface relies on cascading style sheets to render content properly and to provide a usable experience. The application provides an equivalent way for low-vision users to use system display settings, including high-contrast mode. You can control font size by using the device or web browser settings.

The IBM Power Systems servers web user interface includes WAI-ARIA navigational landmarks that you can use to quickly navigate to functional areas in the application.

Vendor software

The IBM Power Systems servers include certain vendor software that is not covered under the IBM license agreement. IBM makes no representation about the accessibility features of these products. Contact the vendor for accessibility information about its products.

Related accessibility information

In addition to standard IBM help desk and support websites, IBM has a TTY telephone service for use by deaf or hard of hearing customers to access sales and support services:

TTY service
800-IBM-3383 (800-426-3383)
(within North America)

For more information about the commitment that IBM has to accessibility, see IBM Accessibility (www.ibm.com/able).

Privacy policy considerations

IBM Software products, including software as a service solutions, (“Software Offerings”) may use cookies or other technologies to collect product usage information, to help improve the end user experience, to tailor interactions with the end user, or for other purposes. In many cases no personally identifiable information is collected by the Software Offerings. Some of our Software Offerings can help enable you to collect personally identifiable information. If this Software Offering uses cookies to collect personally identifiable information, specific information about this offering’s use of cookies is set forth below.

This Software Offering does not use cookies or other technologies to collect personally identifiable information.

If the configurations deployed for this Software Offering provide you as the customer the ability to collect personally identifiable information from end users via cookies and other technologies, you should seek your own legal advice about any laws applicable to such data collection, including any requirements for notice and consent.

For more information about the use of various technologies, including cookies, for these purposes, see IBM’s Privacy Policy at <http://www.ibm.com/privacy> and IBM’s Online Privacy Statement at <http://www.ibm.com/privacy/details> the section entitled “Cookies, Web Beacons and Other Technologies” and the “IBM Software Products and Software-as-a-Service Privacy Statement” at <http://www.ibm.com/software/info/product-privacy>.

Trademarks

IBM, the IBM logo, and ibm.com are trademarks or registered trademarks of International Business Machines Corp., registered in many jurisdictions worldwide. Other product and service names might be trademarks of IBM or other companies. A current list of IBM trademarks is available on the web at Copyright and trademark information at www.ibm.com/legal/copytrade.shtml.

Linux is a registered trademark of Linus Torvalds in the United States, other countries, or both.

Electronic emission notices

When attaching a monitor to the equipment, you must use the designated monitor cable and any interference suppression devices supplied with the monitor.

Class A Notices

The following Class A statements apply to the IBM servers that contain the POWER8 processor and its features unless designated as electromagnetic compatibility (EMC) Class B in the feature information.

Federal Communications Commission (FCC) Statement

Note: This equipment has been tested and found to comply with the limits for a Class A digital device, pursuant to Part 15 of the FCC Rules. These limits are designed to provide reasonable protection against harmful interference when the equipment is operated in a commercial environment. This equipment generates, uses, and can radiate radio frequency energy and, if not installed and used in accordance with the instruction manual, may cause harmful interference to radio communications. Operation of this equipment in a residential area is likely to cause harmful interference, in which case the user will be required to correct the interference at his own expense.

Properly shielded and grounded cables and connectors must be used in order to meet FCC emission limits. IBM is not responsible for any radio or television interference caused by using other than recommended cables and connectors or by unauthorized changes or modifications to this equipment. Unauthorized changes or modifications could void the user's authority to operate the equipment.

This device complies with Part 15 of the FCC rules. Operation is subject to the following two conditions: (1) this device may not cause harmful interference, and (2) this device must accept any interference received, including interference that may cause undesired operation.

Industry Canada Compliance Statement

CAN ICES-3 (A)/NMB-3(A)

European Community Compliance Statement

This product is in conformity with the protection requirements of EU Council Directive 2014/30/EU on the approximation of the laws of the Member States relating to electromagnetic compatibility. IBM cannot accept responsibility for any failure to satisfy the protection requirements resulting from a non-recommended modification of the product, including the fitting of non-IBM option cards.

European Community contact:

IBM Deutschland GmbH

Technical Regulations, Abteilung M456

IBM-Allee 1, 71139 Ehningen, Germany

Tel: +49 800 225 5426

email: halloibm@de.ibm.com

Warning: This is a Class A product. In a domestic environment, this product may cause radio interference, in which case the user may be required to take adequate measures.

VCCI Statement - Japan

この装置は、クラスA 情報技術装置です。この装置を家庭環境で使用すると電波妨害を引き起こすことがあります。この場合には使用者が適切な対策を講ずるよう要求されることがあります。 VCCI-A

The following is a summary of the VCCI Japanese statement in the box above:

This is a Class A product based on the standard of the VCCI Council. If this equipment is used in a domestic environment, radio interference may occur, in which case, the user may be required to take corrective actions.

Japan Electronics and Information Technology Industries Association Statement

This statement explains the Japan JIS C 61000-3-2 product wattage compliance.

(一社) 電子情報技術産業協会 高調波電流抑制対策実施
要領に基づく定格入力電力値： Knowledge Centerの各製品の
仕様ページ参照

This statement explains the Japan Electronics and Information Technology Industries Association (JEITA) statement for products less than or equal to 20 A per phase.

高調波電流規格 JIS C 61000-3-2 適合品

This statement explains the JEITA statement for products greater than 20 A, single phase.

高調波電流規格 JIS C 61000-3-2 準用品

本装置は、「高圧又は特別高圧で受電する需要家の高調波抑制対策ガイドライン」対象機器（高調波発生機器）です。

- 回路分類：6（単相、PFC回路付）
- 換算係数：0

This statement explains the JEITA statement for products greater than 20 A per phase, three-phase.

高調波電流規格 JIS C 61000-3-2 準用品

本装置は、「高圧又は特別高圧で受電する需要家の高調波抑制対策ガイドライン」対象機器（高調波発生機器）です。

- 回路分類 : 5 (3相、PFC回路付)
- 換算係数 : 0

Electromagnetic Interference (EMI) Statement - People's Republic of China

声 明

此为 A 级产品, 在生活环境中, 该产品可能会造成无线电干扰。在这种情况下, 可能需要用户对其干扰采取切实可行的措施。

Declaration: This is a Class A product. In a domestic environment this product may cause radio interference in which case the user may need to perform practical action.

Electromagnetic Interference (EMI) Statement - Taiwan

警告使用者：

這是甲類的資訊產品，在居住的環境中使用時，可能會造成射頻干擾，在這種情況下，使用者會被要求採取某些適當的對策。

The following is a summary of the EMI Taiwan statement above.

Warning: This is a Class A product. In a domestic environment this product may cause radio interference in which case the user will be required to take adequate measures.

IBM Taiwan Contact Information:

台灣IBM 產品服務聯絡方式：
台灣國際商業機器股份有限公司
台北市松仁路7號3樓
電話：0800-016-888

Electromagnetic Interference (EMI) Statement - Korea

이 기기는 업무용 환경에서 사용할 목적으로 적합성평가를 받은 기기로서 가정용 환경에서 사용하는 경우 전파간섭의 우려가 있습니다.

Germany Compliance Statement

Deutschsprachiger EU Hinweis: Hinweis für Geräte der Klasse A EU-Richtlinie zur Elektromagnetischen Verträglichkeit

Dieses Produkt entspricht den Schutzanforderungen der EU-Richtlinie 2014/30/EU zur Angleichung der Rechtsvorschriften über die elektromagnetische Verträglichkeit in den EU-Mitgliedsstaaten und hält die Grenzwerte der EN 55022 / EN 55032 Klasse A ein.

Um dieses sicherzustellen, sind die Geräte wie in den Handbüchern beschrieben zu installieren und zu betreiben. Des Weiteren dürfen auch nur von der IBM empfohlene Kabel angeschlossen werden. IBM übernimmt keine Verantwortung für die Einhaltung der Schutzanforderungen, wenn das Produkt ohne Zustimmung von IBM verändert bzw. wenn Erweiterungskomponenten von Fremdherstellern ohne Empfehlung von IBM gesteckt/eingebaut werden.

EN 55022 / EN 55032 Klasse A Geräte müssen mit folgendem Warnhinweis versehen werden:
"Warnung: Dieses ist eine Einrichtung der Klasse A. Diese Einrichtung kann im Wohnbereich Funk-Störungen verursachen; in diesem Fall kann vom Betreiber verlangt werden, angemessene Maßnahmen zu ergreifen und dafür aufzukommen."

Deutschland: Einhaltung des Gesetzes über die elektromagnetische Verträglichkeit von Geräten

Dieses Produkt entspricht dem "Gesetz über die elektromagnetische Verträglichkeit von Geräten (EMVG)". Dies ist die Umsetzung der EU-Richtlinie 2014/30/EU in der Bundesrepublik Deutschland.

Zulassungsbescheinigung laut dem Deutschen Gesetz über die elektromagnetische Verträglichkeit von Geräten (EMVG) (bzw. der EMC Richtlinie 2014/30/EU) für Geräte der Klasse A

Dieses Gerät ist berechtigt, in Übereinstimmung mit dem Deutschen EMVG das EG-Konformitätszeichen - CE - zu führen.

Verantwortlich für die Einhaltung der EMV Vorschriften ist der Hersteller:
International Business Machines Corp.
New Orchard Road
Armonk, New York 10504
Tel: 914-499-1900

Der verantwortliche Ansprechpartner des Herstellers in der EU ist:
IBM Deutschland GmbH
Technical Relations Europe, Abteilung M456
IBM-Allee 1, 71139 Ehningen, Germany
Tel: +49 (0) 800 225 5426
email: HalloIBM@de.ibm.com

Generelle Informationen:

Das Gerät erfüllt die Schutzanforderungen nach EN 55024 und EN 55022 / EN 55032 Klasse A.

Electromagnetic Interference (EMI) Statement - Russia

ВНИМАНИЕ! Настоящее изделие относится к классу А.
В жилых помещениях оно может создавать
радиопомехи, для снижения которых необходимы
дополнительные меры

Class B Notices

The following Class B statements apply to features designated as electromagnetic compatibility (EMC) Class B in the feature installation information.

Federal Communications Commission (FCC) Statement

This equipment has been tested and found to comply with the limits for a Class B digital device, pursuant to Part 15 of the FCC Rules. These limits are designed to provide reasonable protection against harmful interference in a residential installation.

This equipment generates, uses, and can radiate radio frequency energy and, if not installed and used in accordance with the instructions, may cause harmful interference to radio communications. However, there is no guarantee that interference will not occur in a particular installation.

If this equipment does cause harmful interference to radio or television reception, which can be determined by turning the equipment off and on, the user is encouraged to try to correct the interference by one or more of the following measures:

- Reorient or relocate the receiving antenna.
- Increase the separation between the equipment and receiver.
- Connect the equipment into an outlet on a circuit different from that to which the receiver is connected.
- Consult an IBM-authorized dealer or service representative for help.

Properly shielded and grounded cables and connectors must be used in order to meet FCC emission limits. Proper cables and connectors are available from IBM-authorized dealers. IBM is not responsible for any radio or television interference caused by unauthorized changes or modifications to this equipment. Unauthorized changes or modifications could void the user's authority to operate this equipment.

This device complies with Part 15 of the FCC rules. Operation is subject to the following two conditions: (1) this device may not cause harmful interference, and (2) this device must accept any interference received, including interference that may cause undesired operation.

Industry Canada Compliance Statement

CAN ICES-3 (B)/NMB-3(B)

European Community Compliance Statement

This product is in conformity with the protection requirements of EU Council Directive 2014/30/EU on the approximation of the laws of the Member States relating to electromagnetic compatibility. IBM cannot accept responsibility for any failure to satisfy the protection requirements resulting from a non-recommended modification of the product, including the fitting of non-IBM option cards.

European Community contact:
IBM Deutschland GmbH
Technical Regulations, Abteilung M456
IBM-Allee 1, 71139 Ehningen, Germany
Tel: +49 800 225 5426
email: halloibm@de.ibm.com

VCCI Statement - Japan

この装置は、クラスB情報技術装置です。この装置は、家庭環境で使用することを目的としていますが、この装置がラジオやテレビジョン受信機に近接して使用されると、受信障害を引き起こすことがあります。

取扱説明書に従って正しい取り扱いをして下さい。 VCCI-B

Japan Electronics and Information Technology Industries Association Statement

This statement explains the Japan JIS C 61000-3-2 product wattage compliance.

(一社) 電子情報技術産業協会 高調波電流抑制対策実施
要領に基づく定格入力電力値： Knowledge Centerの各製品の
仕様ページ参照

This statement explains the Japan Electronics and Information Technology Industries Association (JEITA) statement for products less than or equal to 20 A per phase.

高調波電流規格 JIS C 61000-3-2 適合品

This statement explains the JEITA statement for products greater than 20 A, single phase.

高調波電流規格 JIS C 61000-3-2 準用品

本装置は、「高圧又は特別高圧で受電する需要家の高調波抑制対策ガイドライン」対象機器（高調波発生機器）です。

- 回路分類：6（単相、PFC回路付）
- 換算係数：0

This statement explains the JEITA statement for products greater than 20 A per phase, three-phase.

高調波電流規格 JIS C 61000-3-2 準用品

本装置は、「高圧又は特別高圧で受電する需要家の高調波抑制対策ガイドライン」対象機器（高調波発生機器）です。

- 回路分類 : 5 (3相、PFC回路付)
- 換算係数 : 0

IBM Taiwan Contact Information

台灣IBM 產品服務聯絡方式：
台灣國際商業機器股份有限公司
台北市松仁路7號3樓
電話：0800-016-888

Germany Compliance Statement

Deutschsprachiger EU Hinweis: Hinweis für Geräte der Klasse B EU-Richtlinie zur Elektromagnetischen Verträglichkeit

Dieses Produkt entspricht den Schutzanforderungen der EU-Richtlinie 2014/30/EU zur Angleichung der Rechtsvorschriften über die elektromagnetische Verträglichkeit in den EU-Mitgliedsstaaten und hält die Grenzwerte der EN 55022/ EN 55032 Klasse B ein.

Um dieses sicherzustellen, sind die Geräte wie in den Handbüchern beschrieben zu installieren und zu betreiben. Des Weiteren dürfen auch nur von der IBM empfohlene Kabel angeschlossen werden. IBM übernimmt keine Verantwortung für die Einhaltung der Schutzanforderungen, wenn das Produkt ohne Zustimmung von IBM verändert bzw. wenn Erweiterungskomponenten von Fremdherstellern ohne Empfehlung von IBM gesteckt/eingebaut werden.

Deutschland: Einhaltung des Gesetzes über die elektromagnetische Verträglichkeit von Geräten

Dieses Produkt entspricht dem "Gesetz über die elektromagnetische Verträglichkeit von Geräten (EMVG)". Dies ist die Umsetzung der EU-Richtlinie 2014/30/EU in der Bundesrepublik Deutschland.

Zulassungsbescheinigung laut dem Deutschen Gesetz über die elektromagnetische Verträglichkeit von Geräten (EMVG) (bzw. der EMC Richtlinie 2014/30/EU) für Geräte der Klasse B

Dieses Gerät ist berechtigt, in Übereinstimmung mit dem Deutschen EMVG das EG-Konformitätszeichen - CE - zu führen.

Verantwortlich für die Einhaltung der EMV Vorschriften ist der Hersteller:
International Business Machines Corp.
New Orchard Road
Armonk, New York 10504

Tel: 914-499-1900

Der verantwortliche Ansprechpartner des Herstellers in der EU ist:

IBM Deutschland GmbH
Technical Relations Europe, Abteilung M456
IBM-Allee 1, 71139 Ehningen, Germany
Tel: +49 (0) 800 225 5426
email: HalloIBM@de.ibm.com

Generelle Informationen:

Das Gerät erfüllt die Schutzanforderungen nach EN 55024 und EN 55022/ EN 55032 Klasse B.

Terms and conditions

Permissions for the use of these publications are granted subject to the following terms and conditions.

Applicability: These terms and conditions are in addition to any terms of use for the IBM website.

Personal Use: You may reproduce these publications for your personal, noncommercial use provided that all proprietary notices are preserved. You may not distribute, display or make derivative works of these publications, or any portion thereof, without the express consent of IBM.

Commercial Use: You may reproduce, distribute and display these publications solely within your enterprise provided that all proprietary notices are preserved. You may not make derivative works of these publications, or reproduce, distribute or display these publications or any portion thereof outside your enterprise, without the express consent of IBM.

Rights: Except as expressly granted in this permission, no other permissions, licenses or rights are granted, either express or implied, to the publications or any information, data, software or other intellectual property contained therein.

IBM reserves the right to withdraw the permissions granted herein whenever, in its discretion, the use of the publications is detrimental to its interest or, as determined by IBM, the above instructions are not being properly followed.

You may not download, export or re-export this information except in full compliance with all applicable laws and regulations, including all United States export laws and regulations.

IBM MAKES NO GUARANTEE ABOUT THE CONTENT OF THESE PUBLICATIONS. THE PUBLICATIONS ARE PROVIDED "AS-IS" AND WITHOUT WARRANTY OF ANY KIND, EITHER EXPRESSED OR IMPLIED, INCLUDING BUT NOT LIMITED TO IMPLIED WARRANTIES OF MERCHANTABILITY, NON-INFRINGEMENT, AND FITNESS FOR A PARTICULAR PURPOSE.

