

Power Systems

*Disk drives or solid-state drives for the
5147-024, ESLL, and ESLS storage
enclosures*

IBM

Power Systems

*Disk drives or solid-state drives for the
5147-024, ESLL, and ESLS storage
enclosures*

IBM

Note

Before using this information and the product it supports, read the information in “Safety notices” on page vii, “Notices” on page 109, the *IBM Systems Safety Notices* manual, G229-9054, and the *IBM Environmental Notices and User Guide*, Z125-5823.

This edition applies to IBM Power Systems servers that contain the POWER8 processor and to all associated models.

© Copyright IBM Corporation 2016, 2017.

US Government Users Restricted Rights – Use, duplication or disclosure restricted by GSA ADP Schedule Contract with IBM Corp.

Contents

Safety notices	vii
---------------------------------	------------

Disk drives or solid-state drives for the 5147-024, ESLL, or ESLS storage enclosure . . .	1
--	----------

Installing a disk drive or SSD in the 5147-024, ESLL, or ESLS storage enclosure	1
Installing a disk drive or SSD in the 5147-024, ESLL, or ESLS storage enclosure with the system power turned off	1
Preparing an enclosure to install a disk drive or SSD with the system power turned off	1
Installing a disk drive or SSD in an enclosure with the system power turned off.	5
Preparing the enclosure for operation after installing a disk drive or SSD	6
Installing a disk drive or SSD in an ESLL or ESLS storage enclosure with the power turned on in AIX	6
Preparing an ESLL or ESLS storage enclosure to install a disk drive or SSD with the power turned on in AIX	6
Installing a disk drive or SSD in an ESLL or ESLS storage enclosure with the power turned on in AIX	9
Preparing an ESLL or ESLS storage enclosure for operation after installing a disk drive or SSD with the power turned on in AIX	9
Installing a disk drive or SSD in an ESLS storage enclosure with the power turned on in IBM i	10
Preparing an ESLS storage enclosure to install a disk drive or SSD with the power turned on in IBM i	10
Installing a disk drive or SSD in an ESLS storage enclosure with the power turned on in IBM i	13
Preparing an ESLS storage enclosure for operation after installing a drive with the power turned on in IBM i	14
Installing a disk drive or SSD in the 5147-024, ESLL, or ESLS storage enclosure with the power turned on in Linux	14
Preparing the 5147-024, ESLL, or ESLS storage enclosure to install a disk drive or SSD with the power turned on in Linux	15
Installing a disk drive or SSD in the 5147-024, ESLL, or ESLS storage enclosure with the power turned on in Linux	17
Preparing the 5147-024, ESLL, or ESLS storage enclosure for operation after installing a disk drive or SSD with the power turned on in Linux	18
Removing and replacing disk drives or solid-state drives in the 5147-024, ESLL, or ESLS storage enclosure	19
Removing and replacing a disk drive or SSD in the 5147-024, ESLL, or ESLS storage enclosure with the system power turned off	19
Preparing the 5147-024, ESLL, or ESLS storage enclosure to remove and replace a disk drive or SSD with the power turned off	20
Removing a disk drive or SSD from the 5147-024, ESLL, or ESLS storage enclosure with the power turned off	23
Replacing a disk drive or SSD in the 5147-024, ESLL, or ESLS storage enclosure with the power turned off	24
Preparing the 5147-024, ESLL, or ESLS storage enclosure for operation after removing and replacing a drive with the power turned off	25
Removing and replacing a disk drive or SSD in the ESLL or ESLS storage enclosure with the power turned on in AIX	26
Preparing an ESLL or ESLS storage enclosure to remove and replace a disk drive or SSD with the power turned on in AIX	26
Removing a disk drive or SSD from an ESLL or ESLS storage enclosure with the power turned on in AIX	29
Replacing a disk drive or SSD in an ESLL or ESLS storage enclosure with the power turned on in AIX.	30
Preparing an ESLL or ESLS storage enclosure for operation after replacing a drive with the power turned on in AIX	31
Removing and replacing a disk drive or SSD in an ESLS storage enclosure with the power turned on in IBM i	31
Preparing an ESLS storage enclosure to remove and replace a disk drive or solid-state drive with the power turned on in IBM i	31
Removing a disk drive or SSD from an ESLS storage enclosure with the power turned on in IBM i	35
Replacing a disk drive or SSD in an ESLS storage enclosure with the power turned on in IBM i	36
Preparing an ESLS storage enclosure for operation after removing and replacing a drive with the power turned on in IBM i	38
Removing and replacing a disk drive or SSD in an ESLS storage enclosure by using the hot-spare function with the power turned on in IBM i	38

Preparing an ESLS storage enclosure to remove and replace a disk drive or SSD by using the hot-spare function with the power turned on in IBM i	39
Removing a hot-spare disk drive or SSD from an ESLS storage enclosure with the power turned on in IBM i	42
Replacing a hot-spare disk drive or SSD in an ESLS storage enclosure with the power turned on in IBM i	43
Preparing an ESLS storage enclosure for operation after removing and replacing a hot-spare drive with the power turned on in IBM i	44
Removing and replacing a disk drive or SSD in the 5147-024, ESLL, or ESLS storage enclosure with the power turned on in Linux	46
Preparing the 5147-024, ESLL, or ESLS storage enclosure to remove and replace a disk drive or SSD with the power turned on in Linux	46
Removing a disk drive or solid-state drive from the 5147-024 or ESLS storage enclosure with the power turned on in Linux	51
Replacing a disk drive or SSD in the 5147-024 or ESLS storage enclosure with the power turned on in Linux	51
Preparing the 5147-024 or ESLS storage enclosure for operation after removing and replacing a drive with the power turned on in Linux	53

Common procedures for installing, removing, and replacing disk drives or solid-state drives 55

Disk drive or solid-state drive locations and service indicators	55
Disk drive locations and service indicators for the 5148-21L, 5148-22L, 8247-21L, 8247-22L, 8284-21A, or 8284-22A system.	55
Disk drive or solid-state drive locations and service indicators for the 8247-42L, 8286-41A, or 8286-42A system	56
Disk drive and SSD locations and service indicators for the 8408-44E or 8408-E8E system	59
Solid-state drive configuration rules	60
Mainstream solid-state drives	64
Using the AIX fuel gauge command	66
Using the IBM i fuel gauge tool	67
Using the Linux fuel gauge command	68
Preparing the system to remove a disk drive or solid-state drive	69
Preparing the system to remove a disk drive or solid-state drive in AIX	69
Preparing the system to remove a disk drive or solid-state drive from a system or logical partition controlled by IBM i	69
Preparing the system to remove a disk drive or solid-state drive in Linux	70
Configuring a disk drive or solid-state drive	70
Configuring a disk drive or solid-state drive for use in an AIX system or AIX logical partition	70
Configuring a disk drive or solid-state drive for use in an IBM i system or IBM i logical partition	70
Configuring a disk drive or solid-state drive on a load source adapter for hot-spare protection by using the IBM i operating system	72
Configuring a disk drive or solid-state drive for use in a Linux system or Linux logical partition	73
Determining the disk drive or solid-state drive protection status in the IBM i operating system	73
Rebuilding data on a replacement disk drive or solid-state drive	74
Rebuilding data on a replacement disk drive or solid-state drive in a system or logical partition running the AIX operating system	75
Rebuilding data on a replacement disk drive or solid-state drive in a system or logical partition running the IBM i operating system	75
Rebuilding data on a replacement disk drive or solid-state drive in a system or logical partition that is running the Linux operating system	76
Rebuilding data by using the iprconfig command	76
Before you begin	77
Identifying a part	80
Identifying the enclosure or server that contains the part	81
Enabling enclosure or server indicators with the ASMI	81
Control panel LEDs.	81
Activating an identify LED for an enclosure or server by using the HMC.	82
Finding the part location code and LED support status.	83
Identifying a part by using the operating system or VIOS	83
Identifying a part in an AIX system or logical partition.	84
Finding the location code for a part in an AIX system or logical partition.	84
Activating the indicator light for a part by using AIX diagnostics	84
Identifying a part in an IBM i system or logical partition	84

Finding the location code and activating the indicator light for a part by using the IBM i operating system	84
Identifying a part in a Linux system or logical partition	85
Finding the location code of a part in a Linux system or logical partition.	85
Activating the indicator light for a part by using the Linux operating system	86
Identifying a part in a VIOS system or logical partition.	86
Finding the location code of a part in a VIOS system or logical partition	86
Activating the indicator light for a part by using the VIOS tools.	86
Identifying a part by using the ASMI.	87
Activating the identify LED by using the ASMI when you know the location code	87
Activating the identify LED by using the ASMI when you do not know the location code	87
Identifying a part by using the HMC.	88
Stopping a system or logical partition	88
Stopping a system that is not managed by an HMC.	89
Stopping a system by using the control panel	89
Stopping a system by using the ASMI	89
Stopping a system by using the HMC	89
Stopping a system by using the HMC Classic or HMC Enhanced interface	90
Stopping a system by using the HMC Enhanced + Tech Preview (Pre-GA) or HMC Enhanced+ interface	90
Stopping an IBM PowerKVM system	91
Starting the system or logical partition	91
Starting a system that is not managed by an HMC	91
Starting a system by using the control panel	91
Starting a system by using the ASMI	93
Starting a system or logical partition by using the HMC	93
Starting a system or logical partition by using the HMC Classic or HMC Enhanced interface	93
Starting a system or logical partition by using the HMC Enhanced + Tech Preview (Pre-GA) or HMC Enhanced+ interface	93
Starting an IBM PowerKVM system	94
Installing or replacing a part with an HMC.	94
Installing a part by using the HMC	94
Removing a part by using the HMC	95
Repairing a part by using the HMC	96
Power cords	97
Disconnecting the power cords from the system	97
Connecting the power cords to the system.	100
Deactivating an identify LED	102
Deactivating a system attention LED by using the operating system or VIOS tools	102
Deactivating the indicator light for a part by using AIX diagnostics	102
Deactivating the indicator light by using the IBM i operating system.	103
Deactivating the indicator light by using the Linux operating system.	103
Deactivating the indicator light for a part by using the VIOS tools	103
Deactivating a system attention LED by using the ASMI	104
Deactivating the identify LED by using the ASMI when you know the location code	104
Deactivating the identify LED by using the ASMI when you do not know the location code	104
Deactivating a check log indicator (system information indicator) by using the ASMI	105
Deactivating LEDs by using the HMC	105
Deactivating a system attention LED or partition LED by using the HMC	105
Deactivating an identify LED for a FRU by using the HMC	106
Deactivating an identify LED for an enclosure by using the HMC	106
Notices	109
Accessibility features for IBM Power Systems servers	110
Privacy policy considerations	111
Trademarks	112
Electronic emission notices	112
Class A Notices.	112
Class B Notices.	116
Terms and conditions.	119

Safety notices

Safety notices may be printed throughout this guide:

- **DANGER** notices call attention to a situation that is potentially lethal or extremely hazardous to people.
- **CAUTION** notices call attention to a situation that is potentially hazardous to people because of some existing condition.
- **Attention** notices call attention to the possibility of damage to a program, device, system, or data.

World Trade safety information

Several countries require the safety information contained in product publications to be presented in their national languages. If this requirement applies to your country, safety information documentation is included in the publications package (such as in printed documentation, on DVD, or as part of the product) shipped with the product. The documentation contains the safety information in your national language with references to the U.S. English source. Before using a U.S. English publication to install, operate, or service this product, you must first become familiar with the related safety information documentation. You should also refer to the safety information documentation any time you do not clearly understand any safety information in the U.S. English publications.

Replacement or additional copies of safety information documentation can be obtained by calling the IBM Hotline at 1-800-300-8751.

German safety information

Das Produkt ist nicht für den Einsatz an Bildschirmarbeitsplätzen im Sinne § 2 der Bildschirmarbeitsverordnung geeignet.

Laser safety information

IBM® servers can use I/O cards or features that are fiber-optic based and that utilize lasers or LEDs.

Laser compliance

IBM servers may be installed inside or outside of an IT equipment rack.

DANGER: When working on or around the system, observe the following precautions:

Electrical voltage and current from power, telephone, and communication cables are hazardous. To avoid a shock hazard:

- If IBM supplied the power cord(s), connect power to this unit only with the IBM provided power cord. Do not use the IBM provided power cord for any other product.
- Do not open or service any power supply assembly.
- Do not connect or disconnect any cables or perform installation, maintenance, or reconfiguration of this product during an electrical storm.
- The product might be equipped with multiple power cords. To remove all hazardous voltages, disconnect all power cords.
 - For AC power, disconnect all power cords from their AC power source.
 - For racks with a DC power distribution panel (PDP), disconnect the customer's DC power source to the PDP.
- When connecting power to the product ensure all power cables are properly connected.

- For racks with AC power, connect all power cords to a properly wired and grounded electrical outlet. Ensure that the outlet supplies proper voltage and phase rotation according to the system rating plate.
- For racks with a DC power distribution panel (PDP), connect the customer's DC power source to the PDP. Ensure that the proper polarity is used when attaching the DC power and DC power return wiring.
- Connect any equipment that will be attached to this product to properly wired outlets.
- When possible, use one hand only to connect or disconnect signal cables.
- Never turn on any equipment when there is evidence of fire, water, or structural damage.
- Do not attempt to switch on power to the machine until all possible unsafe conditions are corrected.
- Assume that an electrical safety hazard is present. Perform all continuity, grounding, and power checks specified during the subsystem installation procedures to ensure that the machine meets safety requirements.
- Do not continue with the inspection if any unsafe conditions are present.
- Before you open the device covers, unless instructed otherwise in the installation and configuration procedures: Disconnect the attached AC power cords, turn off the applicable circuit breakers located in the rack power distribution panel (PDP), and disconnect any telecommunications systems, networks, and modems.

DANGER:

- Connect and disconnect cables as described in the following procedures when installing, moving, or opening covers on this product or attached devices.

To Disconnect:

1. Turn off everything (unless instructed otherwise).
2. For AC power, remove the power cords from the outlets.
3. For racks with a DC power distribution panel (PDP), turn off the circuit breakers located in the PDP and remove the power from the Customer's DC power source.
4. Remove the signal cables from the connectors.
5. Remove all cables from the devices.

To Connect:

1. Turn off everything (unless instructed otherwise).
2. Attach all cables to the devices.
3. Attach the signal cables to the connectors.
4. For AC power, attach the power cords to the outlets.
5. For racks with a DC power distribution panel (PDP), restore the power from the Customer's DC power source and turn on the circuit breakers located in the PDP.
6. Turn on the devices.

Sharp edges, corners and joints may be present in and around the system. Use care when handling equipment to avoid cuts, scrapes and pinching. (D005)

(R001 part 1 of 2):

DANGER: Observe the following precautions when working on or around your IT rack system:

- Heavy equipment—personal injury or equipment damage might result if mishandled.
- Always lower the leveling pads on the rack cabinet.
- Always install stabilizer brackets on the rack cabinet.
- To avoid hazardous conditions due to uneven mechanical loading, always install the heaviest devices in the bottom of the rack cabinet. Always install servers and optional devices starting from the bottom of the rack cabinet.
- Rack-mounted devices are not to be used as shelves or work spaces. Do not place objects on top of rack-mounted devices. In addition, do not lean on rack mounted devices and do not use them to stabilize your body position (for example, when working from a ladder).



- Each rack cabinet might have more than one power cord.
 - For AC powered racks, be sure to disconnect all power cords in the rack cabinet when directed to disconnect power during servicing.
 - For racks with a DC power distribution panel (PDP), turn off the circuit breaker that controls the power to the system unit(s), or disconnect the customer's DC power source, when directed to disconnect power during servicing.
- Connect all devices installed in a rack cabinet to power devices installed in the same rack cabinet. Do not plug a power cord from a device installed in one rack cabinet into a power device installed in a different rack cabinet.
- An electrical outlet that is not correctly wired could place hazardous voltage on the metal parts of the system or the devices that attach to the system. It is the responsibility of the customer to ensure that the outlet is correctly wired and grounded to prevent an electrical shock.

(R001 part 2 of 2):

CAUTION:

- Do not install a unit in a rack where the internal rack ambient temperatures will exceed the manufacturer's recommended ambient temperature for all your rack-mounted devices.
- Do not install a unit in a rack where the air flow is compromised. Ensure that air flow is not blocked or reduced on any side, front, or back of a unit used for air flow through the unit.
- Consideration should be given to the connection of the equipment to the supply circuit so that overloading of the circuits does not compromise the supply wiring or overcurrent protection. To provide the correct power connection to a rack, refer to the rating labels located on the equipment in the rack to determine the total power requirement of the supply circuit.
- *(For sliding drawers.)* Do not pull out or install any drawer or feature if the rack stabilizer brackets are not attached to the rack. Do not pull out more than one drawer at a time. The rack might become unstable if you pull out more than one drawer at a time.



- *(For fixed drawers.)* This drawer is a fixed drawer and must not be moved for servicing unless specified by the manufacturer. Attempting to move the drawer partially or completely out of the rack might cause the rack to become unstable or cause the drawer to fall out of the rack.

CAUTION:

Removing components from the upper positions in the rack cabinet improves rack stability during relocation. Follow these general guidelines whenever you relocate a populated rack cabinet within a room or building.

- Reduce the weight of the rack cabinet by removing equipment starting at the top of the rack cabinet. When possible, restore the rack cabinet to the configuration of the rack cabinet as you received it. If this configuration is not known, you must observe the following precautions:
 - Remove all devices in the 32U position (compliance ID RACK-001 or 22U (compliance ID RR001) and above.
 - Ensure that the heaviest devices are installed in the bottom of the rack cabinet.
 - Ensure that there are little-to-no empty U-levels between devices installed in the rack cabinet below the 32U (compliance ID RACK-001 or 22U (compliance ID RR001) level, unless the received configuration specifically allowed it.
- If the rack cabinet you are relocating is part of a suite of rack cabinets, detach the rack cabinet from the suite.
- If the rack cabinet you are relocating was supplied with removable outriggers they must be reinstalled before the cabinet is relocated.
- Inspect the route that you plan to take to eliminate potential hazards.
- Verify that the route that you choose can support the weight of the loaded rack cabinet. Refer to the documentation that comes with your rack cabinet for the weight of a loaded rack cabinet.
- Verify that all door openings are at least 760 x 230 mm (30 x 80 in.).
- Ensure that all devices, shelves, drawers, doors, and cables are secure.
- Ensure that the four leveling pads are raised to their highest position.
- Ensure that there is no stabilizer bracket installed on the rack cabinet during movement.
- Do not use a ramp inclined at more than 10 degrees.
- When the rack cabinet is in the new location, complete the following steps:
 - Lower the four leveling pads.
 - Install stabilizer brackets on the rack cabinet.
 - If you removed any devices from the rack cabinet, repopulate the rack cabinet from the lowest position to the highest position.
- If a long-distance relocation is required, restore the rack cabinet to the configuration of the rack cabinet as you received it. Pack the rack cabinet in the original packaging material, or equivalent. Also lower the leveling pads to raise the casters off of the pallet and bolt the rack cabinet to the pallet.

(R002)

(L001)



DANGER: Hazardous voltage, current, or energy levels are present inside any component that has this label attached. Do not open any cover or barrier that contains this label. (L001)

(L002)



DANGER: Rack-mounted devices are not to be used as shelves or work spaces. (L002)

(L003)



or



or



or



or

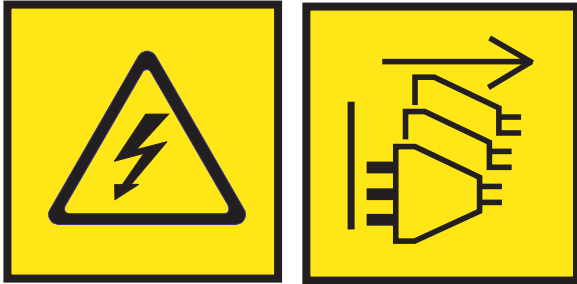

DANGER: Multiple power cords. The product might be equipped with multiple AC power cords or multiple DC power cables. To remove all hazardous voltages, disconnect all power cords and power cables. (L003)

(L007)



CAUTION: A hot surface nearby. (L007)

(L008)



CAUTION: Hazardous moving parts nearby. (L008)

All lasers are certified in the U.S. to conform to the requirements of DHHS 21 CFR Subchapter J for class 1 laser products. Outside the U.S., they are certified to be in compliance with IEC 60825 as a class 1 laser product. Consult the label on each part for laser certification numbers and approval information.

CAUTION:

This product might contain one or more of the following devices: CD-ROM drive, DVD-ROM drive, DVD-RAM drive, or laser module, which are Class 1 laser products. Note the following information:

- **Do not remove the covers. Removing the covers of the laser product could result in exposure to hazardous laser radiation. There are no serviceable parts inside the device.**
- **Use of the controls or adjustments or performance of procedures other than those specified herein might result in hazardous radiation exposure.**

(C026)

CAUTION:

Data processing environments can contain equipment transmitting on system links with laser modules that operate at greater than Class 1 power levels. For this reason, never look into the end of an optical fiber cable or open receptacle. Although shining light into one end and looking into the other end of a disconnected optical fiber to verify the continuity of optic fibers may not injure the eye, this procedure is potentially dangerous. Therefore, verifying the continuity of optical fibers by shining light into one end and looking at the other end is not recommended. To verify continuity of a fiber optic cable, use an optical light source and power meter. (C027)

CAUTION:

This product contains a Class 1M laser. Do not view directly with optical instruments. (C028)

CAUTION:

Some laser products contain an embedded Class 3A or Class 3B laser diode. Note the following information: laser radiation when open. Do not stare into the beam, do not view directly with optical instruments, and avoid direct exposure to the beam. (C030)

CAUTION:

The battery contains lithium. To avoid possible explosion, do not burn or charge the battery.

Do Not:

- **Throw or immerse into water**
- **Heat to more than 100°C (212°F)**
- **Repair or disassemble**

Exchange only with the IBM-approved part. Recycle or discard the battery as instructed by local regulations. In the United States, IBM has a process for the collection of this battery. For information, call 1-800-426-4333. Have the IBM part number for the battery unit available when you call. (C003)

CAUTION:

Regarding IBM provided VENDOR LIFT TOOL:

- Operation of LIFT TOOL by authorized personnel only.
- LIFT TOOL intended for use to assist, lift, install, remove units (load) up into rack elevations. It is not to be used loaded transporting over major ramps nor as a replacement for such designated tools like pallet jacks, walkies, fork trucks and such related relocation practices. When this is not practicable, specially trained persons or services must be used (for instance, riggers or movers).
- Read and completely understand the contents of LIFT TOOL operator's manual before using. Failure to read, understand, obey safety rules, and follow instructions may result in property damage and/or personal injury. If there are questions, contact the vendor's service and support. Local paper manual must remain with machine in provided storage sleeve area. Latest revision manual available on vendor's web site.
- Test verify stabilizer brake function before each use. Do not over-force moving or rolling the LIFT TOOL with stabilizer brake engaged.
- Do not move LIFT TOOL while platform is raised, except for minor positioning.
- Do not exceed rated load capacity. See LOAD CAPACITY CHART regarding maximum loads at center versus edge of extended platform.
- Only raise load if properly centered on platform. Do not place more than 200 lb (91 kg) on edge of sliding platform shelf also considering the load's center of mass/gravity (CoG).
- Do not corner load the platform tilt riser accessory option. Secure platform riser tilt option to main shelf in all four (4x) locations with provided hardware only, prior to use. Load objects are designed to slide on/off smooth platforms without appreciable force, so take care not to push or lean. Keep riser tilt option flat at all times except for final minor adjustment when needed.
- Do not stand under overhanging load.
- Do not use on uneven surface, incline or decline (major ramps).
- Do not stack loads.
- Do not operate while under the influence of drugs or alcohol.
- Do not support ladder against LIFT TOOL.
- Tipping hazard. Do not push or lean against load with raised platform.
- Do not use as a personnel lifting platform or step. No riders.
- Do not stand on any part of lift. Not a step.
- Do not climb on mast.
- Do not operate a damaged or malfunctioning LIFT TOOL machine.
- Crush and pinch point hazard below platform. Only lower load in areas clear of personnel and obstructions. Keep hands and feet clear during operation.
- No Forks. Never lift or move bare LIFT TOOL MACHINE with pallet truck, jack or fork lift.
- Mast extends higher than platform. Be aware of ceiling height, cable trays, sprinklers, lights, and other overhead objects.
- Do not leave LIFT TOOL machine unattended with an elevated load.
- Watch and keep hands, fingers, and clothing clear when equipment is in motion.
- Turn Winch with hand power only. If winch handle cannot be cranked easily with one hand, it is probably over-loaded. Do not continue to turn winch past top or bottom of platform travel. Excessive unwinding will detach handle and damage cable. Always hold handle when lowering, unwinding. Always assure self that winch is holding load before releasing winch handle.
- A winch accident could cause serious injury. Not for moving humans. Make certain clicking sound is heard as the equipment is being raised. Be sure winch is locked in position before releasing handle. Read instruction page before operating this winch. Never allow winch to unwind freely. Freewheeling will cause uneven cable wrapping around winch drum, damage cable, and may cause serious injury. (C048)

Power and cabling information for NEBS (Network Equipment-Building System) GR-1089-CORE

The following comments apply to the IBM servers that have been designated as conforming to NEBS (Network Equipment-Building System) GR-1089-CORE:

The equipment is suitable for installation in the following:

- Network telecommunications facilities
- Locations where the NEC (National Electrical Code) applies

The intrabuilding ports of this equipment are suitable for connection to intrabuilding or unexposed wiring or cabling only. The intrabuilding ports of this equipment *must not* be metalically connected to the interfaces that connect to the OSP (outside plant) or its wiring. These interfaces are designed for use as intrabuilding interfaces only (Type 2 or Type 4 ports as described in GR-1089-CORE) and require isolation from the exposed OSP cabling. The addition of primary protectors is not sufficient protection to connect these interfaces metalically to OSP wiring.

Note: All Ethernet cables must be shielded and grounded at both ends.

The ac-powered system does not require the use of an external surge protection device (SPD).

The dc-powered system employs an isolated DC return (DC-I) design. The DC battery return terminal *shall not* be connected to the chassis or frame ground.

The dc-powered system is intended to be installed in a common bonding network (CBN) as described in GR-1089-CORE.

Disk drives or solid-state drives for the 5147-024, ESSL, or ESLS storage enclosure

Learn how to install, remove, and replace disk drives or solid-state drives (SSDs) for the 5147-024, ESSL, or ESLS storage enclosure.

If you are installing, removing, or replacing mainstream SSDs, it is not supported to mix mainstream drives with enterprise drives in disk arrays. Also, you will need to monitor the amount of life that is remaining in the mainstream drives. For more information about these drives, see “Mainstream solid-state drives” on page 64.

Installing a disk drive or SSD in the 5147-024, ESSL, or ESLS storage enclosure

Find information about installing a serial-attached SCSI (SAS) disk drive or a solid-state drive (SSD) in the 5147-024, ESSL, or ESLS storage enclosure.

If you are installing, removing, or replacing mainstream SSDs, it is not supported to mix mainstream drives with enterprise drives in disk arrays. Also, you will need to monitor the amount of life that is remaining in the mainstream drives. For more information about these drives, see “Mainstream solid-state drives” on page 64.

Installing a disk drive or SSD in the 5147-024, ESSL, or ESLS storage enclosure with the system power turned off

Learn how to install a disk drive or solid-state drive (SSD) in an enclosure, with the system power turned off.

Before you install a feature, ensure that the software that is required to support the feature is installed on your system. For information about software prerequisites, see the IBM Prerequisite website (http://www-912.ibm.com/e_dir/eServerPrereq.nsf). If the required software is not installed, see the following websites to download it, and then install it before you continue:

- To download system firmware updates, software updates, and fix packs, see the Fix Central website (<http://www.ibm.com/support/fixcentral/>).
- To download Hardware Management Console (HMC) updates and fixes, see the Hardware Management Console Support and downloads website (www14.software.ibm.com/webapp/set2/sas/f/hmcl/home.html).

To install a disk drive or solid-state drive in an enclosure, complete the following steps:

1. “Preparing an enclosure to install a disk drive or SSD with the system power turned off”
2. “Installing a disk drive or SSD in an enclosure with the system power turned off” on page 5
3. “Preparing the enclosure for operation after installing a disk drive or SSD” on page 6

Note: Installing this feature is a customer task. You can complete this task yourself, or contact a service provider to complete the task for you. You might be charged a fee by the service provider for this service.

Preparing an enclosure to install a disk drive or SSD with the system power turned off

Learn about the steps you must complete before you install a disk drive or solid-state drive (SSD) in an enclosure.

If you are installing SSDs, review the configuration rules and then return here. For details, see “Solid-state drive configuration rules” on page 60.

To prepare the enclosure to install a disk drive or solid-state drive, complete the following steps:

1. Identify the part and the enclosure that you want to service. The disk drive and SSD slots are located in the front of the enclosure. Figure 1 shows the front of the ESSL storage enclosure, Figure 2 shows the front of the ESLS storage enclosure, Figure 3 shows the rear view of the storage enclosures, and Figure 4 on page 3 shows the locations of the service indicators for the enclosures.

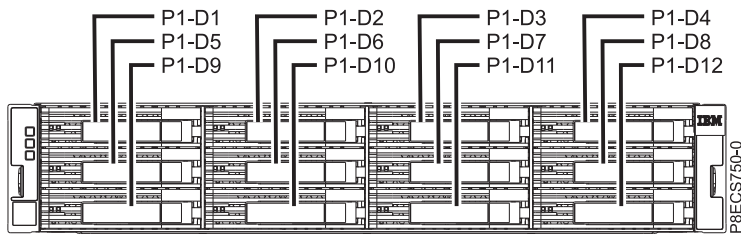

Figure 1. Front view of the ESSL storage enclosure showing the disk drive locations

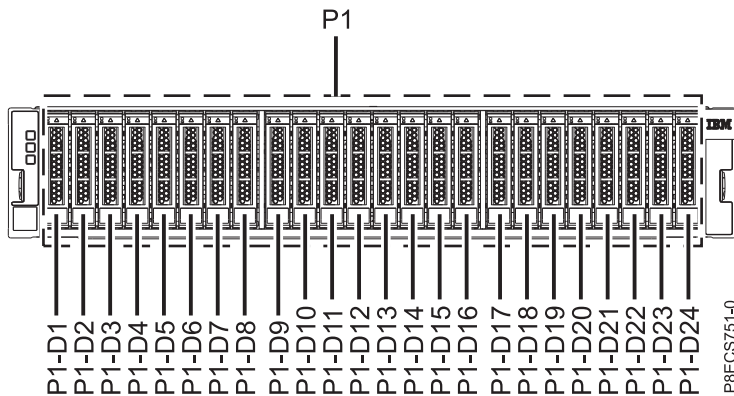

Figure 2. Front view of the 5147-024 or ESLS storage enclosure showing the drive locations

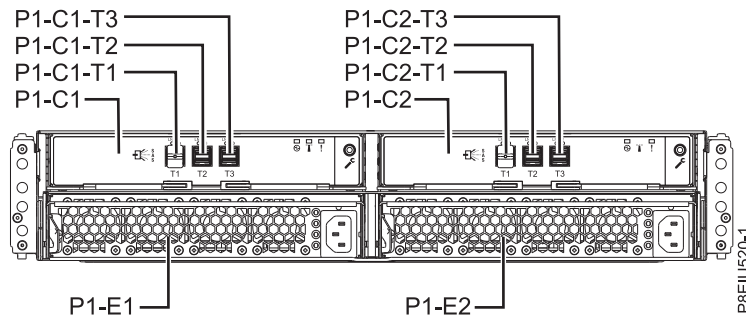

Figure 3. Rear view of the storage enclosures

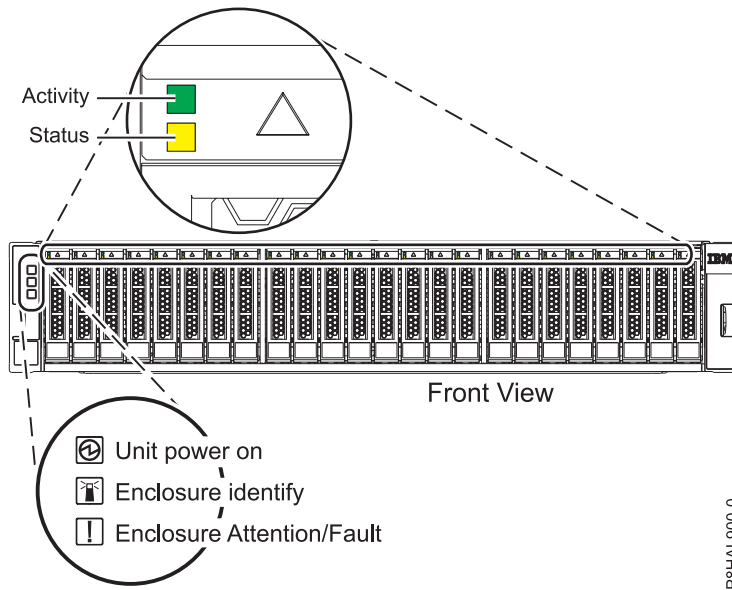

Figure 4. Front view of the storage enclosure showing the service indicators

Note: When you have drive slots available in a system, enclosure, or expansion unit, fill the slot positions in the system first. However, you can choose a different disk drive or solid-state drive placement that depends on your data protection strategy.

2. Record the position (an available empty slot) where the new SSD must be installed. For example, the next available disk drive or SSD slot might be P1-D3.
3. Stop the system or logical partition. For instructions, see “Stopping a system or logical partition” on page 88.
4. Open the rack rear door.
5. Disconnect the power source from the enclosure. Remove the power-cable retention brackets. Label and remove the power cables from the power supplies of the enclosure.

Note: The system might be equipped with redundant power supply. Before you continue with this procedure, ensure that all power to your system is disconnected.

(L003)

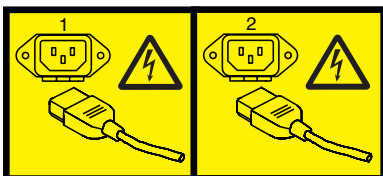

or

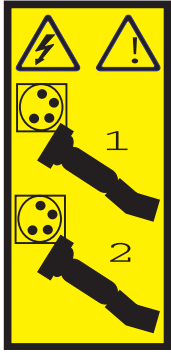

OR

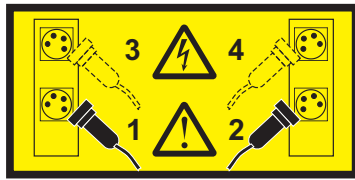

OR

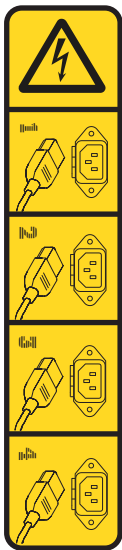

OR

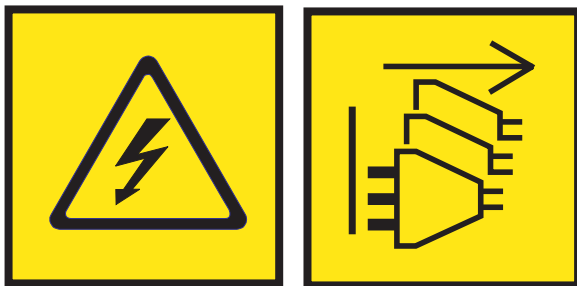

DANGER: Multiple power cords. The product might be equipped with multiple AC power cords or multiple DC power cables. To remove all hazardous voltages, disconnect all power cords and power cables. (L003)

6. Find the package that contains the new drive.

4 Disk drives or solid-state drives

Attention: Drives are fragile. Handle with care.

7. Attach the electrostatic discharge (ESD) wrist strap.

Attention:

- Attach an electrostatic discharge (ESD) wrist strap to the front ESD jack, to the rear ESD jack, or to an unpainted metal surface of your hardware to prevent the electrostatic discharge from damaging your hardware.
- When you use an ESD wrist strap, follow all electrical safety procedures. An ESD wrist strap is used for static control. It does not increase or decrease your risk of receiving electric shock when using or working on electrical equipment.
- If you do not have an ESD wrist strap, just prior to removing the product from ESD packaging and installing or replacing hardware, touch an unpainted metal surface of the system for a minimum of 5 seconds.

8. Remove the drive from the static-protective package and place it on an ESD mat.

Installing a disk drive or SSD in an enclosure with the system power turned off

Learn how to install a disk drive or solid-state drive (SSD) in an enclosure.

To install a disk drive or solid-state drive in an enclosure, complete the following steps:

1. Ensure that you have the electrostatic discharge (ESD) wrist strap attached. If not, attach it now.
2. With the handle in the unlocked position, as shown in Figure 5, support the bottom of the drive as you align it with the guide rails in the enclosure.

Note: Support the drive by holding the drive by its sides.

3. Slide the drive into the enclosure until the drive stops.

Important: Ensure that the drive is fully seated and is all the way into the system.

4. Lock the drive by rotating the bay handle (A) in the direction that is shown in Figure 5.

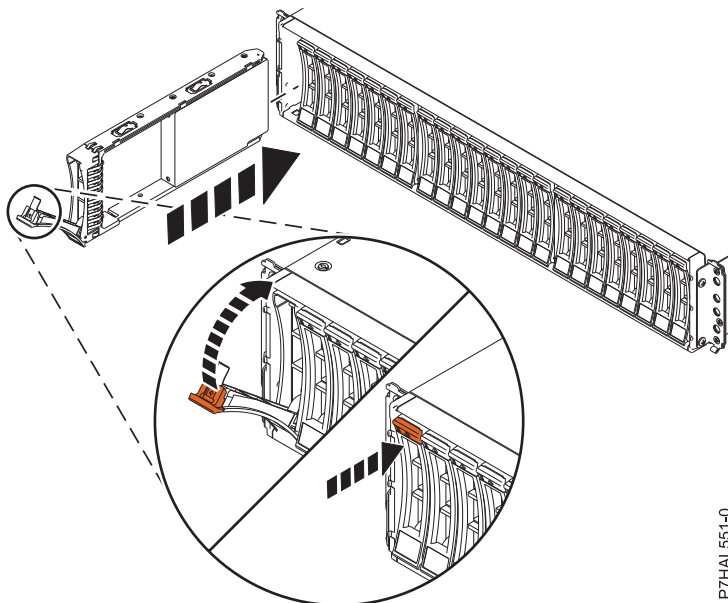

Figure 5. Installing or replacing the disk drive in an enclosure

5. If you are installing more than one drive, repeat the steps in this procedure until all drives are installed.

Preparing the enclosure for operation after installing a disk drive or SSD

Learn to prepare the enclosure for operation after you install a disk drive or solid-state drive (SSD).

To prepare the enclosure for operation, complete the following steps:

1. Reconnect the power cords to the system. For instructions, see “Connecting the power cords to the system” on page 100.
2. Start the system or logical partition. For instructions, see “Starting the system or logical partition” on page 91.
3. If you installed a drive in a disk drive slot and have not verified the drive yet, verify that the power LED is **ON** (green) for the installed drive on the front of the enclosure.
4. To configure the newly installed disk drive or solid-state drive, see the following procedures for the applicable operating system that controls the disk drive or solid-state drive:
 - “Configuring a disk drive or solid-state drive for use in an AIX system or AIX logical partition” on page 70.
 - “Configuring a disk drive or solid-state drive for use in an IBM i system or IBM i logical partition” on page 70.
 - “Configuring a disk drive or solid-state drive for use in an Linux system or Linux logical partition” on page 73.

Installing a disk drive or SSD in an ESLL or ESLS storage enclosure with the power turned on in AIX

Learn how to install a disk drive or solid-state drive (SSD) in an enclosure with the AIX® operating system or AIX logical partition that controls the drive location powered on.

Before you install a feature, ensure that the software that is required to support the feature is installed on your system. For information about software prerequisites, see the IBM Prerequisite website (http://www-912.ibm.com/e_dir/eServerPrereq.nsf). If the required software is not installed, see the following websites to download it, and then install it before you continue:

- To download system firmware updates, software updates, and fix packs, see the Fix Central website (<http://www.ibm.com/support/fixcentral/>).
- To download Hardware Management Console (HMC) updates and fixes, see the Hardware Management Console Support and downloads website (www14.software.ibm.com/webapp/set2/sas/f/hmcl/home.html).

To install a disk drive or solid-state drive in an enclosure, complete the following steps:

1. “Preparing an ESLL or ESLS storage enclosure to install a disk drive or SSD with the power turned on in AIX.”
2. “Installing a disk drive or SSD in an ESLL or ESLS storage enclosure with the power turned on in AIX” on page 9.
3. “Preparing an ESLL or ESLS storage enclosure for operation after installing a disk drive or SSD with the power turned on in AIX” on page 9.

Note: Installing this feature is a customer task. You can complete this task yourself, or contact a service provider to complete the task for you. You might be charged a fee by the service provider for this service.

Preparing an ESLL or ESLS storage enclosure to install a disk drive or SSD with the power turned on in AIX

Learn about the steps you must complete before you install a disk drive or solid-state drive (SSD) in an enclosure with the AIX operating system or AIX logical partition that controls the drive location powered on.

If you are installing SSDs, review the configuration rules and then return here. For details, see “Solid-state drive configuration rules” on page 60.

To prepare the system to install a disk drive or solid-state drive, complete the following steps:

1. Identify the part and the enclosure that you want to service. The disk drive and SSD slots are located in the front of the enclosure. Figure 6 shows the front of the ESSL storage enclosure, Figure 7 shows the front of the ESLS storage enclosure, Figure 8 shows the rear view of the storage enclosures, and Figure 9 on page 8 shows the locations of the service indicators for the enclosures.

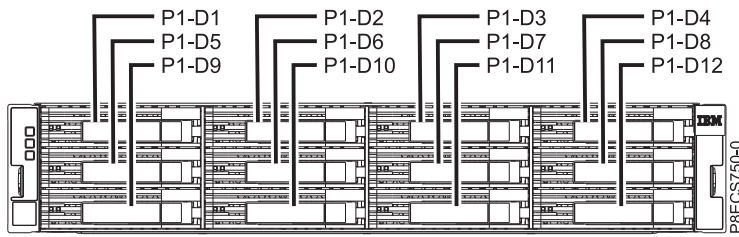

Figure 6. Front view of the ESSL storage enclosure showing the disk drive locations

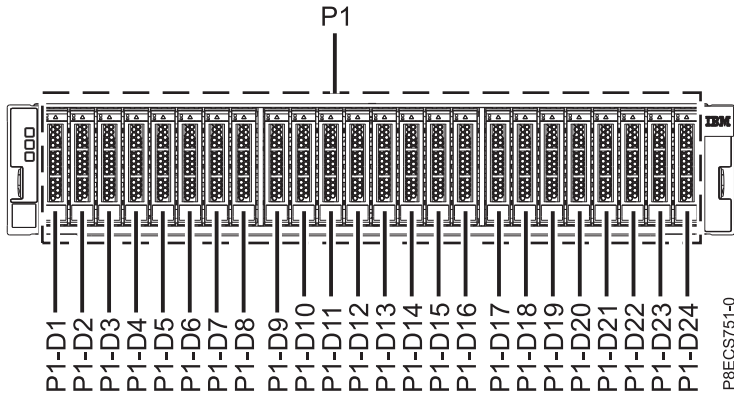

Figure 7. Front view of the ESLS storage enclosure showing the drive locations

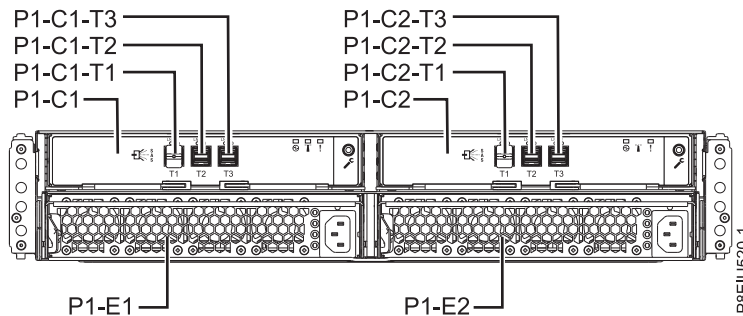

Figure 8. Rear view of the storage enclosures

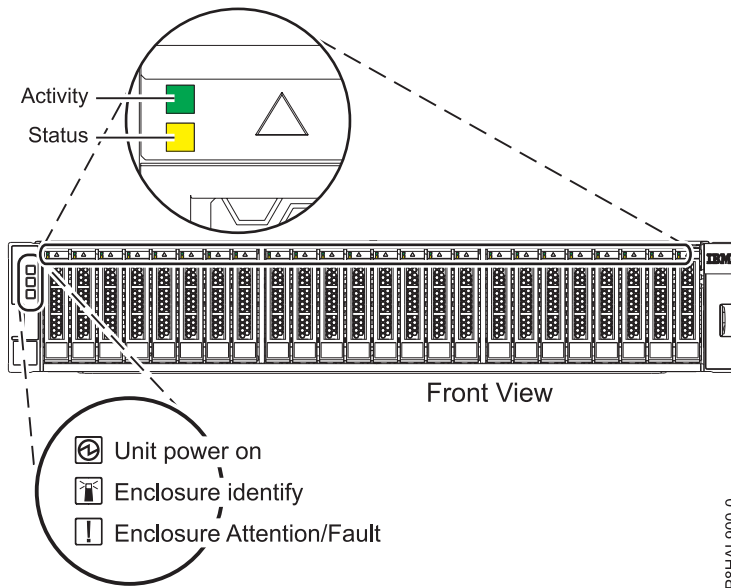

Figure 9. Front view of the storage enclosure showing the service indicators

Note: When you have drive slots available in a system, enclosure, or expansion unit, fill the slot positions in the system first. However, you can choose a different disk drive or solid-state drive placement that depends on your data protection strategy.

2. To identify the available slot by using the diagnostic command, complete the following steps:
 - a. Log in as root user.
 - b. At the command line, type `diag` and then press Enter.
 - c. On the Diagnostic Operating Instructions display, press Enter to continue.
 - d. On the Function Selection display, select **Task Selection**.
 - e. Select **RAID Array Manager**.
 - f. Select **IBM SAS Disk Array Manager**.
 - g. Select **Diagnostics and Recovery Options**.
 - h. Select **SCSI and SCSI RAID Hot Plug Manager**.
 - i. Select **Attach a Device to a SCSI Hot Swap Enclosure Device**. A list of empty slots in the SCSI hot swap enclosure device is shown.
3. Record the position (an available empty slot) where the new disk drive must be installed. For example, the next available disk drive or SSD slot might be P2-D3.
4. Find the package that contains the new drive.

Attention: Drives are fragile. Handle with care.
5. Attach the electrostatic discharge (ESD) wrist strap.

Attention:

 - Attach an electrostatic discharge (ESD) wrist strap to the front ESD jack, to the rear ESD jack, or to an unpainted metal surface of your hardware to prevent the electrostatic discharge from damaging your hardware.
 - When you use an ESD wrist strap, follow all electrical safety procedures. An ESD wrist strap is used for static control. It does not increase or decrease your risk of receiving electric shock when using or working on electrical equipment.
 - If you do not have an ESD wrist strap, just prior to removing the product from ESD packaging and installing or replacing hardware, touch an unpainted metal surface of the system for a minimum of 5 seconds.
6. Remove the drive from the static-protective package and place it on an ESD mat.
- 8 Disk drives or solid-state drives

Installing a disk drive or SSD in an ESLL or ESLS storage enclosure with the power turned on in AIX

Learn how to install a disk drive or solid-state drive (SSD) in an enclosure with the AIX operating system or AIX logical partition that controls the drive location powered on.

1. Ensure that you have the electrostatic discharge (ESD) wrist strap attached. If not, attach it now.
2. If the slot you want to use contains a drive filler, remove the filler from the slot.
 - a. Push the lock on the handle of the filler.
 - b. Hold the handle and pull out the filler from the slot.
3. With the handle in the unlocked position, as shown in Figure 10, support the bottom of the drive as you align it with the guide rails in the enclosure.

Note: Support the drive by holding the drive by its sides.

4. Slide the drive halfway into the enclosure.
5. On the console, select the drive that you want to install and then press Enter.
6. When the identify LED turns on solid, slide the drive into the enclosure until the drive stops.

Important: Ensure that the drive is fully seated and is all the way into the system.

7. Lock the drive by rotating the handle (A) in the direction that is shown in Figure 10.

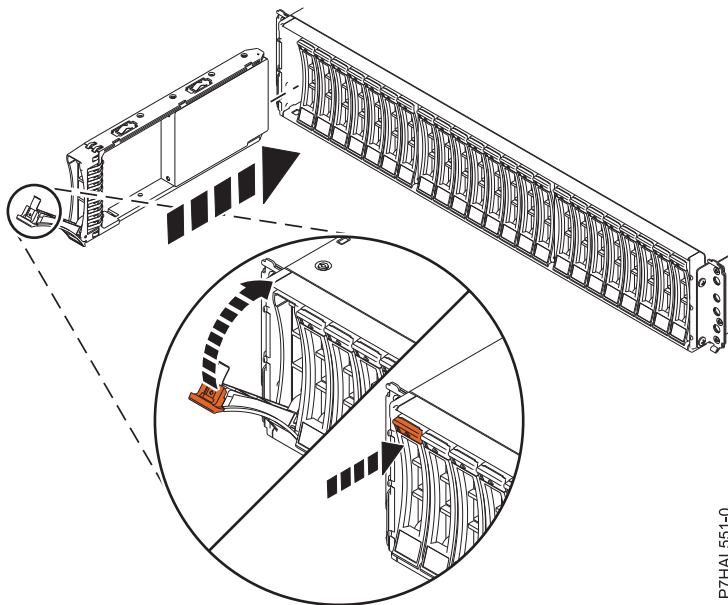

Figure 10. Installing or replacing the disk drive in the ESLL or ESLS storage enclosure

8. On the console, press Enter to indicate that you installed the drive.
9. If you are installing more than one drive, repeat the steps in this procedure until all drives are installed.

Preparing an ESLL or ESLS storage enclosure for operation after installing a disk drive or SSD with the power turned on in AIX

Learn to prepare the system for operation after you install a disk drive or solid-state drive (SSD) in an enclosure with the AIX operating system or AIX logical partition that controls the drive location powered on.

To prepare the system for operation, complete the following steps:

1. If you installed a drive in a disk drive slot and have not verified the drive yet, verify that the power LED is **ON** (green) for the installed drive on the front of the system.
2. To configure the newly installed disk drive or solid-state drive, see “Configuring a disk drive or solid-state drive for use in an AIX system or AIX logical partition” on page 70.

Installing a disk drive or SSD in an ESLS storage enclosure with the power turned on in IBM i

Learn how to install a disk drive or solid-state drive (SSD) in an enclosure with the IBM i operating system or IBM i logical partition that controls the drive location powered on.

Before you install a feature, ensure that the software that is required to support the feature is installed on your system. For information about software prerequisites, see the IBM Prerequisite website (http://www-912.ibm.com/e_dir/eServerPrereq.nsf). If the required software is not installed, see the following websites to download it, and then install it before you continue:

- To download system firmware updates, software updates, and fix packs, see the Fix Central website (<http://www.ibm.com/support/fixcentral/>).
- To download Hardware Management Console (HMC) updates and fixes, see the Hardware Management Console Support and downloads website (www14.software.ibm.com/webapp/set2/sas/f/hmcl/home.html).

To install a disk drive or solid-state drive in an enclosure, complete the following steps:

1. “Preparing an ESLS storage enclosure to install a disk drive or SSD with the power turned on in IBM i.”
2. “Installing a disk drive or SSD in an ESLS storage enclosure with the power turned on in IBM i” on page 13.
3. “Preparing an ESLS storage enclosure for operation after installing a drive with the power turned on in IBM i” on page 14.

Note: Installing this feature is a customer task. You can complete this task yourself, or contact a service provider to complete the task for you. You might be charged a fee by the service provider for this service.

Preparing an ESLS storage enclosure to install a disk drive or SSD with the power turned on in IBM i

Learn about the steps you must complete before you install a disk drive or solid-state drive (SSD) in an enclosure with the IBM i operating system or IBM i logical partition that controls the drive location powered on.

If you are installing SSDs, review the configuration rules and then return here. For details, see “Solid-state drive configuration rules” on page 60.

To prepare the enclosure to install a disk drive or solid-state drive, complete the following steps:

1. Identify the part and the enclosure that you want to service. The disk drive and SSD slots are located in the front of the enclosure. Figure 11 on page 11 shows the front of the ESLS storage enclosure, Figure 12 on page 11 shows the rear view of the storage enclosure, and Figure 13 on page 11 shows the locations of the service indicators for the enclosure.

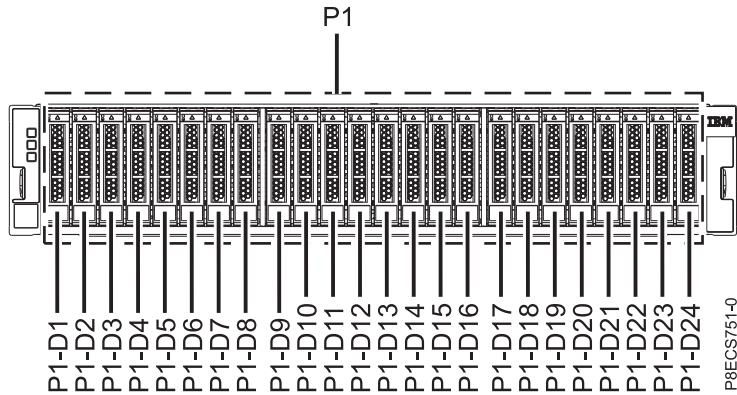

Figure 11. Front view of the ESLS storage enclosure showing the drive locations

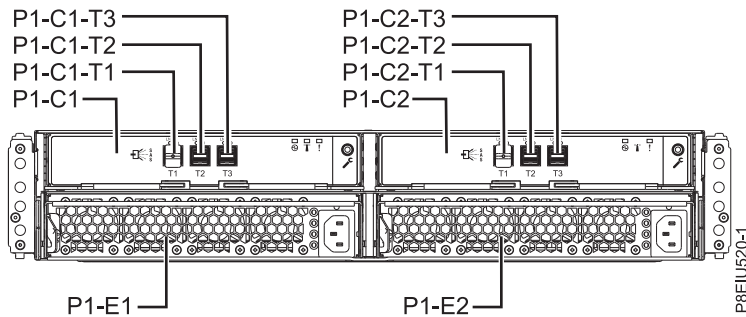

Figure 12. Rear view of the storage enclosure

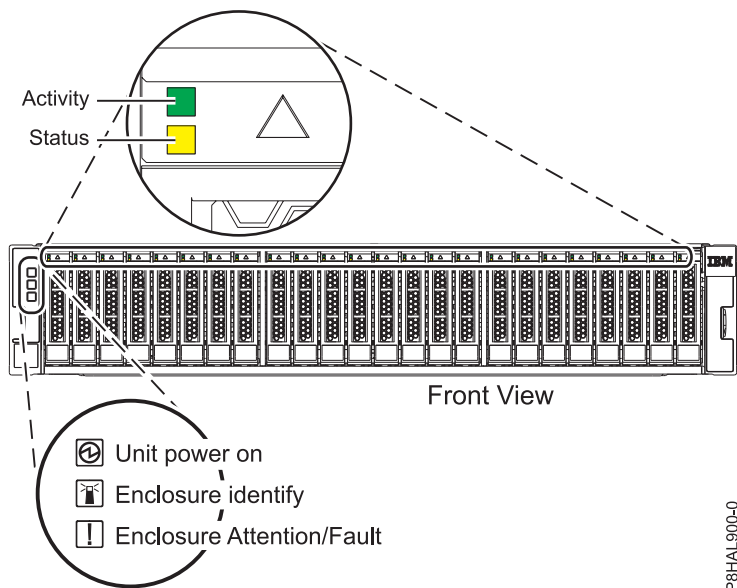

Figure 13. Front view of the storage enclosure showing the service indicators

Note: When you have drive slots available in a system, enclosure, or expansion unit, fill the slot positions in the system first. However, you can choose a different disk drive or solid-state drive placement that depends on your data protection strategy.

2. Record the physical location where the new disk drive or solid-state drive can be installed.

- a. The physical location has the following form: U787A.001.AAAXXXX-P2-D3 where P2-D3 is the position of the disk drive or solid-state drive in the system, drive enclosure, or an expansion unit. Find the U787A.001.AAAXXXX location information from the control panel display on the system, drive enclosure, or an expansion unit.
- b. In this example, U787A.001.AAAXXXX-P2-D3, U787A.001 comes from the feature code (FC) on the label, AAAXXXX comes from the last 7 digits of the sequence number (SN or SEQ) on the label, and P2-D3 is the slot where you are installing the disk drive or solid-state drive.
- c. If you cannot find the location information from the control panel, find the feature code (FC) and sequence number (SN or SEQ) on the label that is shown on the front of the system, drive enclosure, or an expansion unit, as shown in Figure 14. In the example, U5074.001.AAAXXXX-DB3-D32, you would install a disk drive or solid-state drive in the expansion unit with type 5074, model 001, sequence number AAAXXXX, and disk drive or solid-state drive position DB3-D32.



Figure 14. Example of a system or an expansion unit label

3. To identify the available slot by using the Hardware Service Manager (HSM), complete the following steps:
 - a. Sign on to service level authority.
 - b. Type `strsst` in the command line of the IBM i session and then press Enter.
 - c. Type your service tools user ID and service tools password in the Start Service Tools Sign On display, and then press Enter.

Note: The service tools password is case-sensitive.

- d. Select **Start a service tool** from the System Service Tools (SST) display, and then press Enter.
- e. Select **Hardware service manager** from the Start a Service Tool display, and then press Enter.
- f. If the slot you want to use contains a disk drive filler, remove the disk drive filler.
- g. Select **Device Concurrent Maintenance** from the Hardware Service Manager display, and then press Enter.

The Device Concurrent Maintenance is displayed, as shown in the following figure.

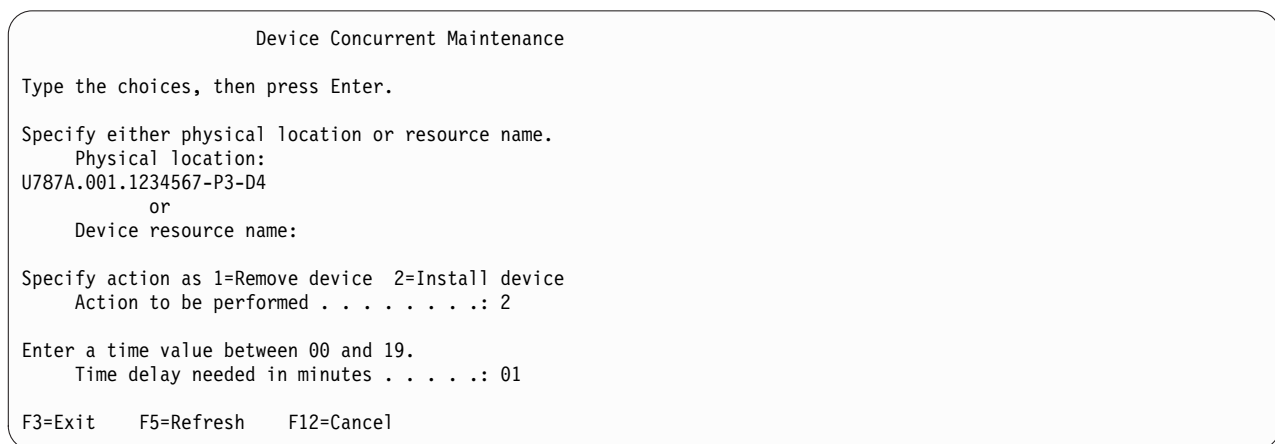

Figure 15. Example Device Concurrent Maintenance display

- h. In the **Specify either physical location or resource name** field, type the physical location that you previously recorded in this procedure.
- i. Select 2 (Install device) for the Action to be completed.
- j. Set the time delay in minutes. For example, for one minute enter: 01.

Note: You can set an appropriate time delay of 01 - 19 minutes to allow adequate time to access the disk drive or solid-state drive.

- k. Do not press Enter yet, first complete installing the disk drive or solid-state drive in the system, drive enclosure, or an expansion unit.
4. Find the package that contains the new drive.
Attention: Drives are fragile. Handle with care.
 5. Attach the electrostatic discharge (ESD) wrist strap.

Attention:

- Attach an electrostatic discharge (ESD) wrist strap to the front ESD jack, to the rear ESD jack, or to an unpainted metal surface of your hardware to prevent the electrostatic discharge from damaging your hardware.
 - When you use an ESD wrist strap, follow all electrical safety procedures. An ESD wrist strap is used for static control. It does not increase or decrease your risk of receiving electric shock when using or working on electrical equipment.
 - If you do not have an ESD wrist strap, just prior to removing the product from ESD packaging and installing or replacing hardware, touch an unpainted metal surface of the system for a minimum of 5 seconds.
6. Remove the drive from the static-protective package and place it on an ESD mat.

Installing a disk drive or SSD in an ESLS storage enclosure with the power turned on in IBM i

Learn how to install a disk drive or solid-state drive (SSD) in an enclosure with the IBM i operating system or IBM i logical partition that controls the drive location powered on.

1. Ensure that you have the electrostatic discharge (ESD) wrist strap attached. If not, attach it now.
2. If the slot you want to use contains a drive filler, remove the filler from the slot.
 - a. Push the lock on the handle of the filler.
 - b. Hold the handle and pull out the filler from the slot.
3. With the handle in the unlocked position, as shown in Figure 16 on page 14, support the bottom of the drive as you align it with the guide rails in the expansion unit.

Note: Support the drive by holding the drive by its sides.

4. Slide the drive halfway into the enclosure.
5. On the console, select the drive that you want to install.
6. Press Enter on the console.

Important: When you press Enter, after your selected time delay, the service indicator light comes on (solid) for 18 seconds. You then have 18 seconds to slide the drive all the way in and then lock it in place by pushing in the drive handle. You can set an appropriate time delay of 01 - 19 minutes to allow adequate time to access the disk drive or solid-state drive.

7. When the identify LED turns on solid, slide the drive into the enclosure until the drive stops.

Important: Ensure that the drive is fully seated and is all the way into the system.

8. Lock the drive by rotating the bay handle (A) in the direction that is shown in Figure 16 on page 14.

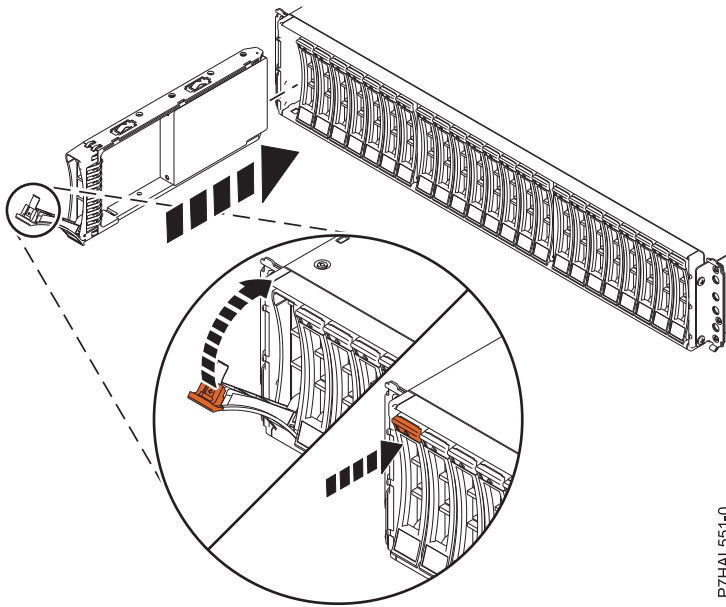

Figure 16. Installing or replacing the disk drive in the storage enclosure

9. On the console, press Enter to indicate that you installed the drive.
10. If you are installing more than one drive, repeat the steps in this procedure until all drives are installed.

Preparing an ESLS storage enclosure for operation after installing a drive with the power turned on in IBM i

Learn to prepare an enclosure for operation after you install a disk drive or solid-state drive (SSD) in the enclosure with the IBM i operating system or IBM i logical partition that controls the drive location powered on.

To prepare the enclosure for operation, complete the following steps:

1. Return to the console and wait until the Concurrent Maintenance Results display is shown, and then press Enter.
2. When the HSM display is shown, press F12 twice and then press Enter.
3. If you installed a drive in a disk drive slot and have not verified the drive yet, verify that the power LED is ON (green) for the installed drive on the front of the system.
4. To configure the newly installed disk drive or solid-state drive, see “Configuring a disk drive or solid-state drive for use in an IBM i system or IBM i logical partition” on page 70.

Installing a disk drive or SSD in the 5147-024, ESSL, or ESLS storage enclosure with the power turned on in Linux

Learn how to install a disk drive or solid-state drive (SSD) in an enclosure with the Linux operating system or Linux logical partition that controls the drive location powered on.

Before you install a feature, ensure that the software that is required to support the feature is installed on your system. For information about software prerequisites, see the IBM Prerequisite website (http://www-912.ibm.com/e_dir/eServerPrereq.nsf). If the required software is not installed, see the following websites to download it, and then install it before you continue:

- To download system firmware updates, software updates, and fix packs, see the Fix Central website (<http://www.ibm.com/support/fixcentral/>).

- To download Hardware Management Console (HMC) updates and fixes, see the Hardware Management Console Support and downloads website (www14.software.ibm.com/webapp/set2/sas/f/hmcl/home.html).

To install a disk drive or solid-state drive in an enclosure, complete the following steps:

1. “Preparing the 5147-024, ESLL, or ESLS storage enclosure to install a disk drive or SSD with the power turned on in Linux.”
2. “Installing a disk drive or SSD in the 5147-024, ESLL, or ESLS storage enclosure with the power turned on in Linux” on page 17.
3. “Preparing the 5147-024, ESLL, or ESLS storage enclosure for operation after installing a disk drive or SSD with the power turned on in Linux” on page 18.

Note: Installing this feature is a customer task. You can complete this task yourself, or contact a service provider to complete the task for you. You might be charged a fee by the service provider for this service.

Preparing the 5147-024, ESLL, or ESLS storage enclosure to install a disk drive or SSD with the power turned on in Linux

Learn about the steps you must complete before you install a disk drive or solid-state drive (SSD) in an enclosure with the Linux operating system or Linux logical partition that controls the drive location powered on.

If you are installing SSDs, review the configuration rules and then return here. For details, see “Solid-state drive configuration rules” on page 60.

To prepare the system to install a disk drive or solid-state drive, complete the following steps:

1. Identify the part and the enclosure that you want to service. The disk drive and SSD slots are located in the front of the enclosure. Figure 17 shows the front of the ESLL storage enclosure, Figure 18 on page 16 shows the front of the ESLS storage enclosure, Figure 19 on page 16 shows the rear view of the storage enclosures, and Figure 20 on page 16 shows the locations of the service indicators for the enclosures.

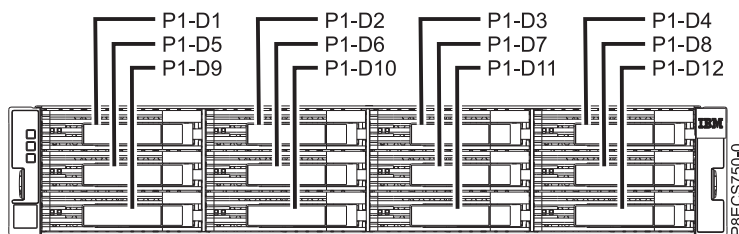

Figure 17. Front view of the ESLL storage enclosure showing the disk drive locations

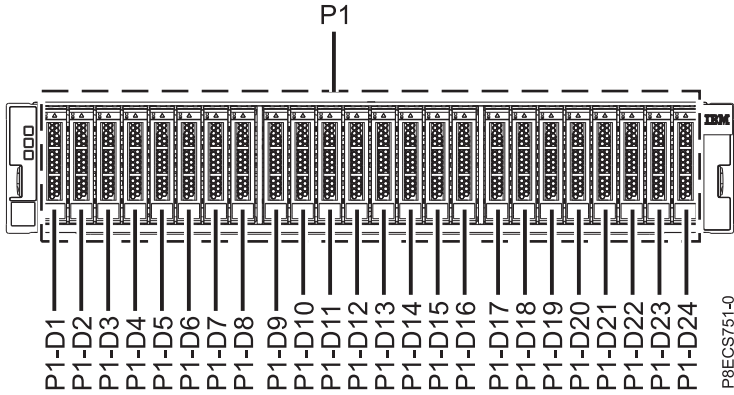

Figure 18. Front view of the 5147-024 or ESLS storage enclosure showing the drive locations

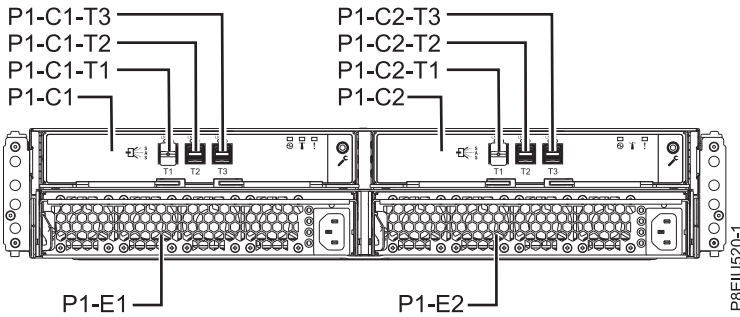

Figure 19. Rear view of the storage enclosure

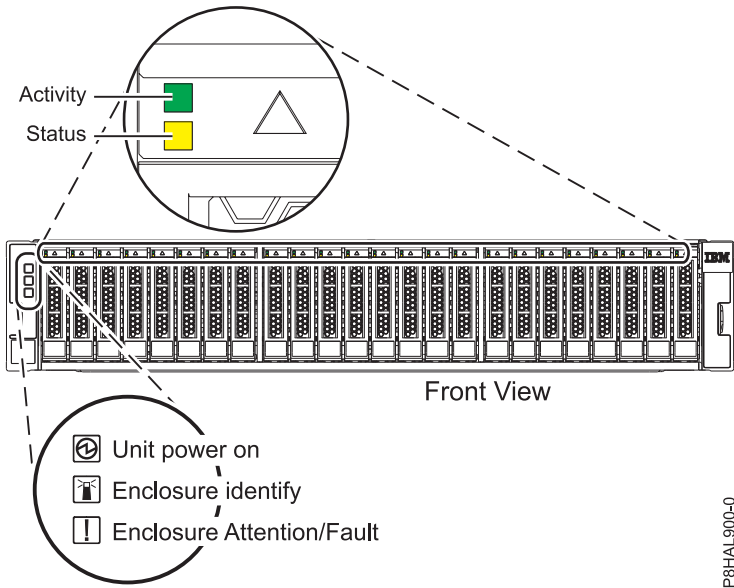

Figure 20. Front view of the storage enclosure showing the service indicators

Note: When you have drive slots available in a system, enclosure, or expansion unit, fill the slot positions in the system first. However, you can choose a different disk drive or solid-state drive placement that depends on your data protection strategy.

- To identify the available slot by using the `iprconfig` command, complete the following steps:

- a. Log in as root user.
- b. Type **iprconfig** on the command line of the Linux session, and then press Enter. The IBM Power RAID Configuration Utility display is shown.
- c. Select **Work with disk unit recovery** from the IBM Power RAID Configuration Utility display, and then press Enter.
- d. Select **Concurrent add device** from the Work with Disk Unit Recovery display, and then press Enter.

A Concurrent Device Add display, similar to Figure 21, is shown.

```

                                Concurrent Device Add

Choose a single location for add operations
  1=Select

OPT Name  PCI/SCSI Location      Description      Status
-----
          U5887.001.Z065075-P1-D1      Empty
          U5887.001.Z065075-P1-D6      Empty
          U5887.001.Z065075-P1-D7      Empty
          U5887.001.Z065075-P1-D8      Empty
          U5887.001.Z065075-P1-D9      Empty

e=Exit  q=Cancel  t=Toggle

```

Figure 21. Example Concurrent Device Add display

- e. Type **t** if you want to toggle through different location code representations.
 - f. Type **1** next to the location into which you want to install the disk drive or solid-state drive and press Enter. The **Verify Device Concurrent Add** display is shown and the service indicator flashes for the selected slot.
 - g. Do not press Enter again. Follow the rest of the procedure to complete installing the drive.
3. Record the position (an available empty slot) where the new disk drive must be installed. For example, the next available disk drive or SSD slot might be P2-D3.
 4. Find the package that contains the new drive.

Attention: Drives are fragile. Handle with care.
 5. Attach the electrostatic discharge (ESD) wrist strap.

Attention:

 - Attach an electrostatic discharge (ESD) wrist strap to the front ESD jack, to the rear ESD jack, or to an unpainted metal surface of your hardware to prevent the electrostatic discharge from damaging your hardware.
 - When you use an ESD wrist strap, follow all electrical safety procedures. An ESD wrist strap is used for static control. It does not increase or decrease your risk of receiving electric shock when using or working on electrical equipment.
 - If you do not have an ESD wrist strap, just prior to removing the product from ESD packaging and installing or replacing hardware, touch an unpainted metal surface of the system for a minimum of 5 seconds.
 6. Remove the drive from the static-protective package and place it on an ESD mat.

Installing a disk drive or SSD in the 5147-024, ESLL, or ESLS storage enclosure with the power turned on in Linux

Learn how to install a disk drive or solid-state drive (SSD) in an enclosure with the Linux operating system or Linux logical partition that controls the drive location powered on.

1. Ensure that you have the electrostatic discharge (ESD) wrist strap attached. If not, attach it now.
2. If the slot you want to use contains a drive filler, remove the filler from the slot.

- a. Push the lock on the handle of the filler.
- b. Hold the handle and pull out the filler from the slot.
3. With the handle in the unlocked position, as shown in Figure 22, support the bottom of the drive as you align it with the guide rails in the enclosure.

Note: Support the drive by holding the drive by its sides.

4. Slide the drive halfway into the enclosure.
5. Return to the console, and then press Enter. In the Verify Device Concurrent Add display, verify that the selected slot is the slot in which you want to install the drive.
6. When the identify LED flashes for the selected slot, slide the drive all the way into the slot until the drive stops.

Important: Ensure that the drive is fully seated and is all the way into the system.

7. Lock the drive by rotating the bay handle (A) in the direction that is shown in Figure 22.

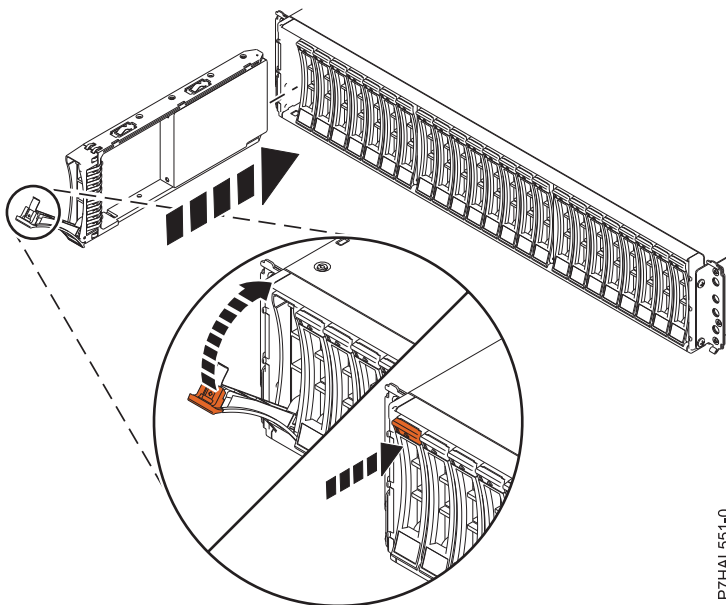

Figure 22. Installing or replacing the disk drive in an enclosure

8. On the console, press Enter to indicate that you installed the drive.
9. If you are installing more than one drive, repeat the steps in this procedure until all drives are installed.

Preparing the 5147-024, ESSL, or ESLS storage enclosure for operation after installing a disk drive or SSD with the power turned on in Linux

Learn to prepare an enclosure for operation after you install a disk drive or solid-state drive (SSD) in the enclosure with the Linux operating system or Linux logical partition that controls the drive location powered on.

To prepare the enclosure for operation, complete the following steps:

1. Press Enter on the Complete Device Concurrent Add display to indicate that the disk drive or solid-state drive is installed. The service indicator stops flashing and turns off for that drive slot.
2. To verify that the new disk drive or solid-state drive is operational, complete the following steps:
 - a. Log in as root user.

- b. Type `iprconfig` on the command line of the Linux session and press Enter. The IBM Power RAID Configuration Utility display is shown.
- c. Select **Display hardware status**. The Display Hardware Status display is shown, similar to the following figure.

```

Display Hardware Status

Type option, press Enter.
  l=Display hardware resource information details

OPT Name  PCI/SCSI Location      Description      Status
-----
          0000:01:00.0/0:
          0000:01:00.0/0:0:0:0  Advanced Function SSD  Active
          0000:01:00.0/0:0:1:0  Advanced Function SSD  Active
          0000:01:00.0/0:0:2:0  Advanced Function SSD  Active
          0000:01:00.0/0:0:3:0  Advanced Function SSD  Active
          0000:01:00.0/0:0:4:0  Advanced Function SSD  Active
          0000:01:00.0/0:0:5:0  Advanced Function SSD  Active
          0000:01:00.0/0:0:6:0  Advanced Function SSD  Active
          0000:01:00.0/0:0:8:0  Enclosure              Active
          0000:01:00.0/0:0:9:0  Enclosure              Active
          0001:01:00.0/1:
          0001:01:00.0/1:0:3:0  Advanced Function SSD  Remote
          0001:01:00.0/1:0:4:0  Advanced Function SSD  Remote
          0001:01:00.0/1:0:5:0  Advanced Function SSD  Remote
          More...

e=Exit  q=Cancel  r=Refresh  t=Toggle  f=PageDn  b=PageUp

```

Figure 23. Example Display Hardware Status

- d. Verify that the disk drive or solid-state drive that you installed is shown on this display.
3. If you installed a drive in a disk drive slot and have not verified the drive yet, verify that the power LED is **ON** (green) for the installed drive on the front of the system.
4. To configure the newly installed disk drive or solid-state drive, see “Configuring a disk drive or solid-state drive for use in an Linux system or Linux logical partition” on page 73.

Removing and replacing disk drives or solid-state drives in the 5147-024, ESLL, or ESLS storage enclosure

Learn how to remove and replace a disk drive or solid-state drive (SSD) in the 5147-024, ESLL, or ESLS storage enclosure.

If you are installing, removing, or replacing mainstream SSDs, it is not supported to mix mainstream drives with enterprise drives in disk arrays. Also, you will need to monitor the amount of life that is remaining in the mainstream drives. For more information about these drives, see “Mainstream solid-state drives” on page 64.

Removing and replacing a disk drive or SSD in the 5147-024, ESLL, or ESLS storage enclosure with the system power turned off

Learn how to remove and replace a disk drive or solid-state drive (SSD) in an enclosure with the system power turned off.

To remove and replace a disk drive or solid-state drive, complete the following steps:

1. “Preparing the 5147-024, ESLL, or ESLS storage enclosure to remove and replace a disk drive or SSD with the power turned off” on page 20.
2. “Removing a disk drive or SSD from the 5147-024, ESLL, or ESLS storage enclosure with the power turned off” on page 23.

3. "Replacing a disk drive or SSD in the 5147-024, ESSL, or ESLS storage enclosure with the power turned off" on page 24.
4. "Preparing the 5147-024, ESSL, or ESLS storage enclosure for operation after removing and replacing a drive with the power turned off" on page 25.

Note: Removing or replacing this feature is a customer task. You can complete this task yourself, or contact a service provider to complete the task for you. You might be charged a fee by the service provider for this service.

Preparing the 5147-024, ESSL, or ESLS storage enclosure to remove and replace a disk drive or SSD with the power turned off

Learn about the steps you must complete before you remove and replace a disk drive or solid-state drive (SSD) in an enclosure with the system power turned off.

To prepare an enclosure to remove and replace a disk drive or solid-state drive, complete the following steps:

1. Prepare to remove the disk drive or solid-state drive from the system, drive enclosure, or expansion unit by using one of the following procedures depending on the operating system that controls the drive location:
 - If the system or logical partition that controls the disk drive or solid-state drive location is running the AIX operating system, see "Preparing the system to remove a disk drive or solid-state drive in AIX" on page 69.
 - If the system or logical partition that controls the disk drive or solid-state drive location is running the IBM i operating system, see "Preparing the system to remove a disk drive or solid-state drive from a system or logical partition controlled by IBM i" on page 69.
 - If the system or logical partition that controls the disk drive or solid-state drive location is running the Linux operating system, see "Preparing the system to remove a disk drive or solid-state drive in Linux" on page 70.
2. Identify the part and the enclosure that you want to service. The disk drive and SSD slots are located in the front of the enclosure. Figure 24 shows the front of the ESSL storage enclosure, Figure 25 on page 21 shows the front of the ESLS storage enclosure, Figure 26 on page 21 shows the rear view of the storage enclosures, and Figure 27 on page 21 shows the locations of the service indicators for the storage enclosures.

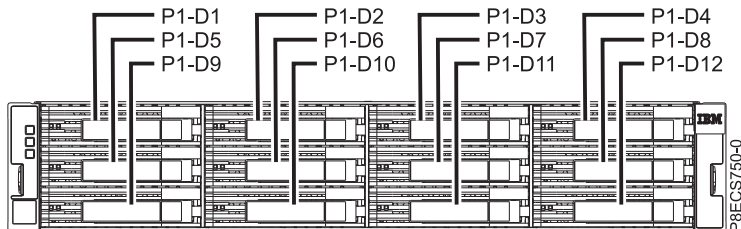

Figure 24. Front view of the ESSL storage enclosure showing the disk drive locations

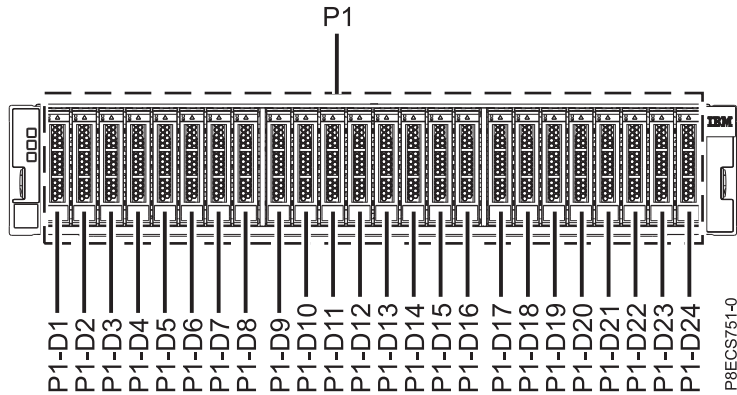

Figure 25. Front view of the 5147-024 or ESLS storage enclosure showing the drive locations

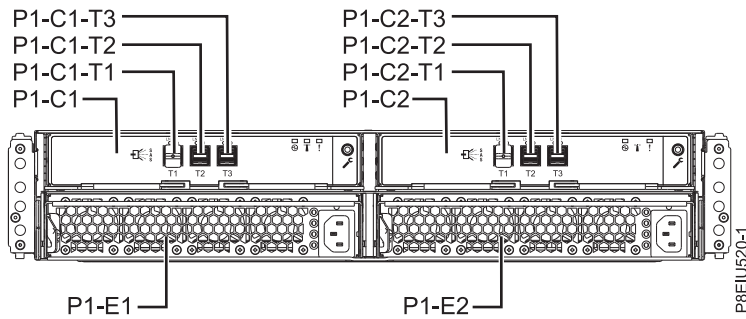

Figure 26. Rear view of the storage enclosures

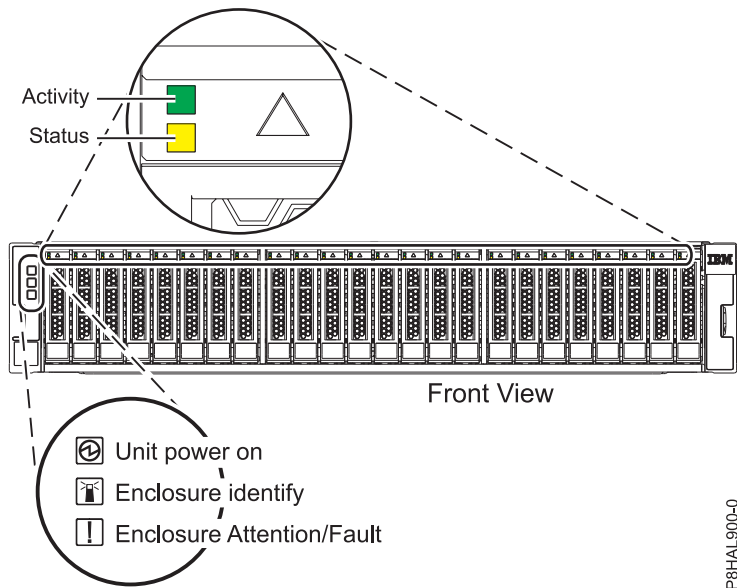

Figure 27. Front view of the storage enclosures showing the service indicators

Note: When you have drive slots available in a system, enclosure, or expansion unit, fill the slot positions in the system first. However, you can choose a different disk drive or solid-state drive placement that depends on your data protection strategy.

3. Identify the disk drive or solid-state drive to be removed and record the location information. For instructions, see “Identifying a part” on page 80.
4. Stop the system or logical partition. For instructions, see “Stopping a system or logical partition” on page 88.

5. Find the package that contains the new drive.

Attention: Drives are fragile. Handle with care.

6. Attach the electrostatic discharge (ESD) wrist strap.

Attention:

- Attach an electrostatic discharge (ESD) wrist strap to the front ESD jack, to the rear ESD jack, or to an unpainted metal surface of your hardware to prevent the electrostatic discharge from damaging your hardware.
- When you use an ESD wrist strap, follow all electrical safety procedures. An ESD wrist strap is used for static control. It does not increase or decrease your risk of receiving electric shock when using or working on electrical equipment.
- If you do not have an ESD wrist strap, just prior to removing the product from ESD packaging and installing or replacing hardware, touch an unpainted metal surface of the system for a minimum of 5 seconds.

7. Remove the drive from the static-protective package and place it on an ESD mat.
8. Open the rack rear door.
9. Disconnect the power source from the system by unplugging the system. For instructions, see “Disconnecting the power cords from the system” on page 97.

Note: The system might be equipped with redundant power supply. Before you continue with this procedure, ensure that all power to your system is disconnected.

(L003)

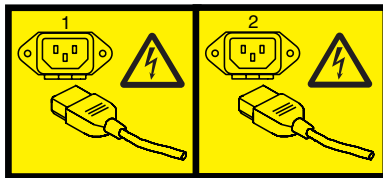

or

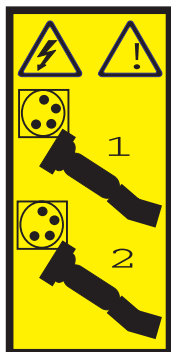

or



OR

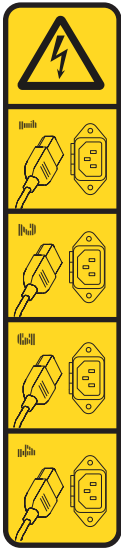

OR

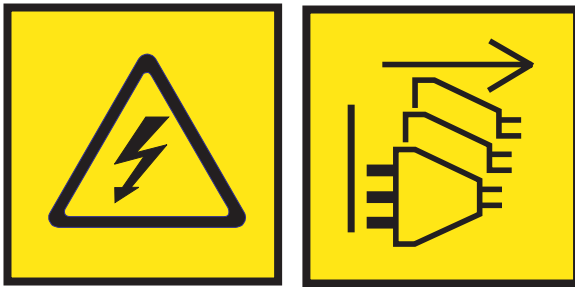

DANGER: Multiple power cords. The product might be equipped with multiple AC power cords or multiple DC power cables. To remove all hazardous voltages, disconnect all power cords and power cables. (L003)

Removing a disk drive or SSD from the 5147-024, ESLL, or ESLS storage enclosure with the power turned off

Find information about removing a disk drive or solid-state drive (SSD) from an enclosure with the system power turned off.

To remove a disk drive or an SSD from an enclosure, complete the following steps:

1. Ensure that you have the electrostatic discharge (ESD) wrist strap attached. If not, attach it now.
2. Slide the terracotta release latch up gently to unlock the drive handle.
3. Grasp the handle and pull the drive partially out of the slot.
4. Grasp the front of the drive and pull it out from the slot, ensuring that you support the bottom of the drive, as shown in Figure 28 on page 24.

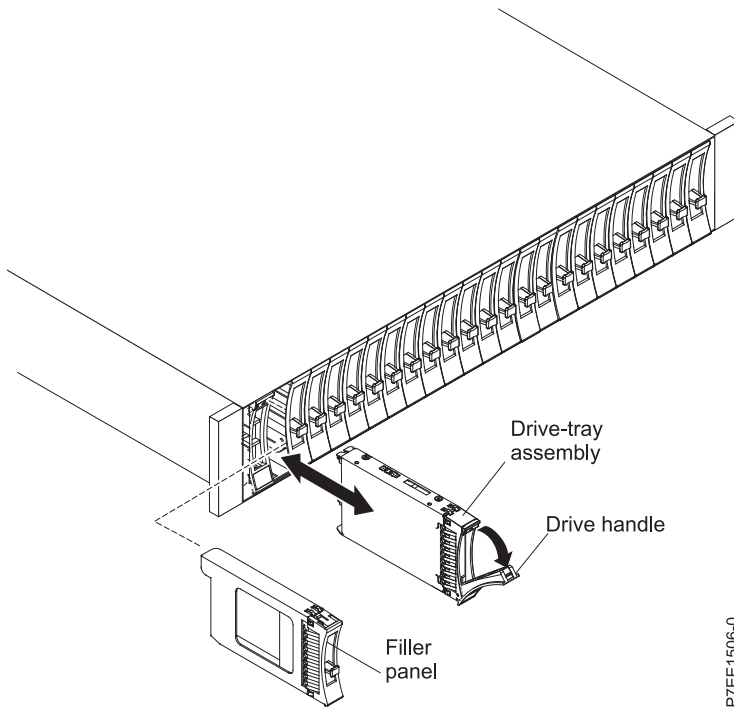

Figure 28. Removing a drive from the 5147-024, ESLL, or ESLS storage enclosure

5. If you are removing more than one drive, repeat the steps in this procedure until all drives are removed.

Replacing a disk drive or SSD in the 5147-024, ESLL, or ESLS storage enclosure with the power turned off

Find information about replacing a disk drive or solid-state drive (SSD) in an enclosure with the system power turned off.

To replace a disk drive or an SSD in an enclosure, complete the following steps:

1. Ensure that you have the electrostatic discharge (ESD) wrist strap attached. If not, attach it now.
2. With the handle in the unlocked position as shown, in Figure 29 on page 25, support the bottom of the drive as you align it with the guide rails in the enclosure.

Note: Support the drive by holding the drive by its sides.

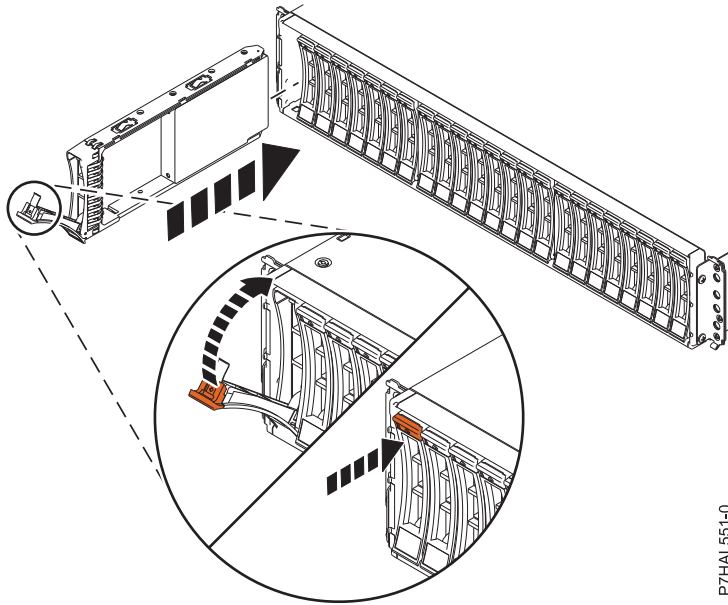

P7HAL551-0

Figure 29. Installing or replacing a disk drive in the 5147-024, ESLL, or ESLS storage enclosure

3. Slide the drive into the enclosure until the drive stops.

Important: Ensure that the drive is fully seated and is all the way into the system.

4. Lock the drive by rotating the bay handle (A) in the direction that is shown in Figure 29.
5. If you are installing more than one drive, repeat the steps in this procedure until all drives are installed.

Preparing the 5147-024, ESLL, or ESLS storage enclosure for operation after removing and replacing a drive with the power turned off

Learn to prepare the enclosure for operation after you replace a disk drive or solid-state drive (SSD) in an enclosure with the system power turned off.

To prepare the enclosure for operation, complete the following steps:

1. Reconnect the power source into the enclosure. Replace the power-cable retention brackets. Replace the power cables in the power supplies of the enclosure.
2. Close the rear rack door.
3. Start the system or logical partition. For instructions, see “Starting the system or logical partition” on page 91.
4. If you replaced a drive and have not verified the drive yet, verify that the power LED is **ON** (green) and the amber fault LED is **OFF** (not lit) for the replaced drive on the front of the system.
5. To configure the newly installed disk drive or solid-state drive, see the following procedures for the applicable operating system that controls the disk drive or solid-state drive:
 - “Configuring a disk drive or solid-state drive for use in an AIX system or AIX logical partition” on page 70.
 - “Configuring a disk drive or solid-state drive for use in an IBM i system or IBM i logical partition” on page 70.
 - “Configuring a disk drive or solid-state drive for use in an Linux system or Linux logical partition” on page 73.
6. To rebuild the data on the replacement disk drive or solid-state drive, or to recover from a failed or missing array, see the following procedures for the applicable operating system that controls the drive:

- “Rebuilding data on a replacement disk drive or solid-state drive in a system or logical partition running the AIX operating system” on page 75.
- “Rebuilding data on a replacement disk drive or solid-state drive in a system or logical partition running the IBM i operating system” on page 75.
- “Rebuilding data on a replacement disk drive or solid-state drive in a system or logical partition that is running the Linux operating system” on page 76.

Removing and replacing a disk drive or SSD in the ESLL or ESLS storage enclosure with the power turned on in AIX

Learn how to remove and replace a disk drive or solid-state drive (SSD) in an enclosure with the AIX operating system or AIX logical partition that controls the drive location powered on.

To remove and replace a disk drive or solid-state drive, complete the following steps:

1. “Preparing an ESLL or ESLS storage enclosure to remove and replace a disk drive or SSD with the power turned on in AIX.”
2. “Removing a disk drive or SSD from an ESLL or ESLS storage enclosure with the power turned on in AIX” on page 29.
3. “Replacing a disk drive or SSD in an ESLL or ESLS storage enclosure with the power turned on in AIX” on page 30.
4. “Preparing an ESLL or ESLS storage enclosure for operation after replacing a drive with the power turned on in AIX” on page 31.

Note: Removing or replacing this feature is a customer task. You can complete this task yourself, or contact a service provider to complete the task for you. You might be charged a fee by the service provider for this service.

Preparing an ESLL or ESLS storage enclosure to remove and replace a disk drive or SSD with the power turned on in AIX

Learn about the steps you must complete before you remove and replace a disk drive or solid-state drive (SSD) in an enclosure with the AIX operating system or AIX logical partition that controls the drive location powered on.

If the drive that you are removing is in the root volume group (rootvg) and it is not protected by either Redundant Array of Independent Disks (RAID) or mirroring, or to use the powered-off procedure, go to “Removing a disk drive or SSD from the 5147-024, ESLL, or ESLS storage enclosure with the power turned off” on page 23.

To prepare an enclosure to remove and replace a disk drive or solid-state drive, complete the following steps:

1. Before you remove a drive from an enclosure that is controlled by the AIX operating system, ensure that all data on that drive or the array that contains the drive is backed up and removed from the drive. If the drive that is being replaced is protected by RAID or mirroring, it is not necessary to remove data. Ensure that the disks are in the defined state if the disks are just a bunch of disks (JBOD).
2. If you are removing a solid-state device that is on a PCIe RAID and SSD SAS adapter, go to Replacing an SSD module on the PCIe RAID and SSD SAS adapter and complete that procedure.
3. Identify the part and the enclosure that you want to service. The disk drive and SSD slots are located in the front of the enclosure. Figure 30 on page 27 shows the front of the ESLL storage enclosure, Figure 31 on page 27 shows the front of the ESLS storage enclosure, Figure 32 on page 27 shows the rear view of the storage enclosures, and Figure 33 on page 28 shows the locations of the service indicators for the storage enclosures.

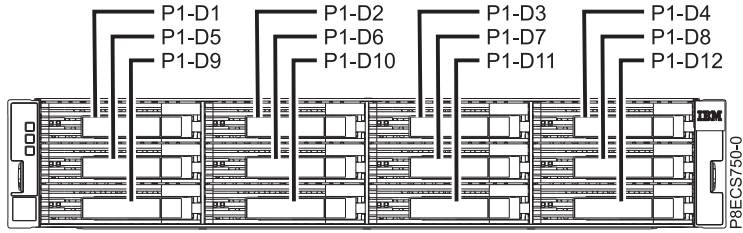

Figure 30. Front view of the ESLL storage enclosure showing the disk drive locations

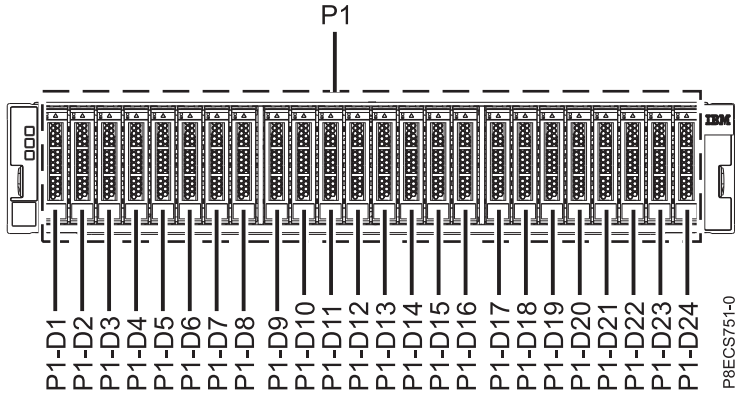

Figure 31. Front view of the ESLS storage enclosure showing the drive locations

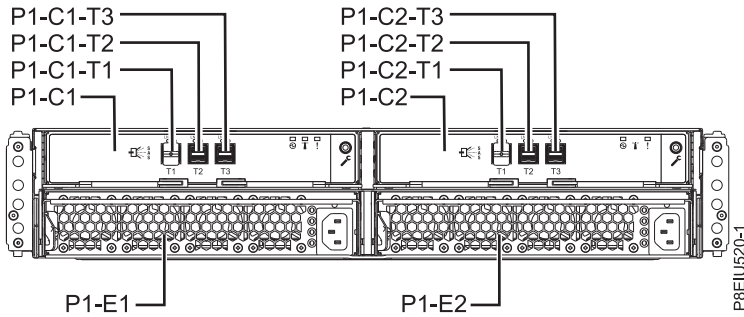

Figure 32. Rear view of the enclosure

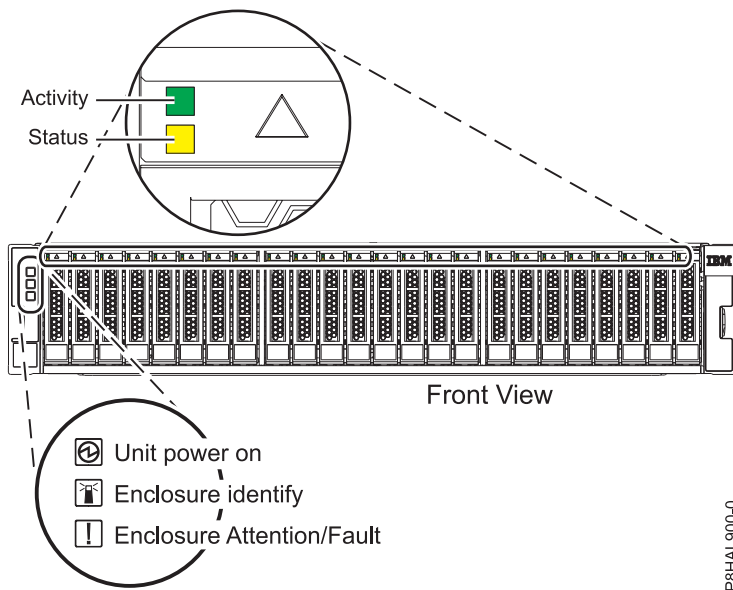

Figure 33. Front view of the enclosure showing the service indicators

Note: When you have drive slots available in a system, enclosure, or expansion unit, fill the slot positions in the system first. However, you can choose a different disk drive or solid-state drive placement that depends on your data protection strategy.

4. To identify the drive by using the diagnostic command before you remove a disk drive or solid-state drive, complete the following steps:
 - a. Log in as root user.
 - b. At the command line, type `diag` and then press Enter.
 - c. On the Diagnostic Operating Instructions display, press Enter to continue.
 - d. On the Function Selection display, select **Task Selection**.
 - e. Select **RAID Array Manager**.
 - f. Select **IBM SAS Disk Array Manager**.
 - g. Select **Diagnostics and Recovery Options**.
 - h. Select **SCSI and SCSI RAID Hot Plug Manager**.
 - i. To identify the location of the drive to be removed, select **Identify a Device Attached to an SCSI Hot Swap Enclosure Device**.
 - j. Choose the slot corresponding to the drive, and then press Enter. The identify LED for that slot flashes rapidly.
 - k. Verify that the identify LED for that slot is flashing rapidly, and record the location of the slot.
 - l. Press Enter to stop the LED from flashing and continue.
 - m. To prepare to remove the drive, press **F3** to return to the SCSI and SCSI RAID Hot Plug Manager display.
 - n. Select **Replace/Remove a Device Attached to an SCSI Hot Swap Enclosure Device**.
5. Find the package that contains the new drive.

Attention: Drives are fragile. Handle with care.
6. Open the rack rear door.
7. Attach the electrostatic discharge (ESD) wrist strap.

Attention:

- Attach an electrostatic discharge (ESD) wrist strap to the front ESD jack, to the rear ESD jack, or to an unpainted metal surface of your hardware to prevent the electrostatic discharge from damaging your hardware.
 - When you use an ESD wrist strap, follow all electrical safety procedures. An ESD wrist strap is used for static control. It does not increase or decrease your risk of receiving electric shock when using or working on electrical equipment.
 - If you do not have an ESD wrist strap, just prior to removing the product from ESD packaging and installing or replacing hardware, touch an unpainted metal surface of the system for a minimum of 5 seconds.
8. Remove the drive from the static-protective package and place it on an ESD mat.
 9. On the console, select the drive that you want to remove, and then press Enter.

Note: When you press Enter, the identify LED stops flashing and is ON (solid).

Removing a disk drive or SSD from an ESLL or ESLS storage enclosure with the power turned on in AIX

Find information about removing a disk drive or solid-state drive (SSD) from an enclosure with the AIX operating system or AIX logical partition that controls the drive location powered on.

To remove a disk drive or an SSD from a disk drive enclosure, complete the following steps:

1. Ensure that you have the electrostatic discharge (ESD) wrist strap attached. If not, attach it now.
2. When the identify LED turns on solid, slide the terracotta release latch up gently to unlock the drive handle.
3. Grasp the handle and pull the drive partially out of the slot.
4. Grasp the front of the drive and pull it out from the slot, ensuring that you support the bottom of the drive, as shown in Figure 34.

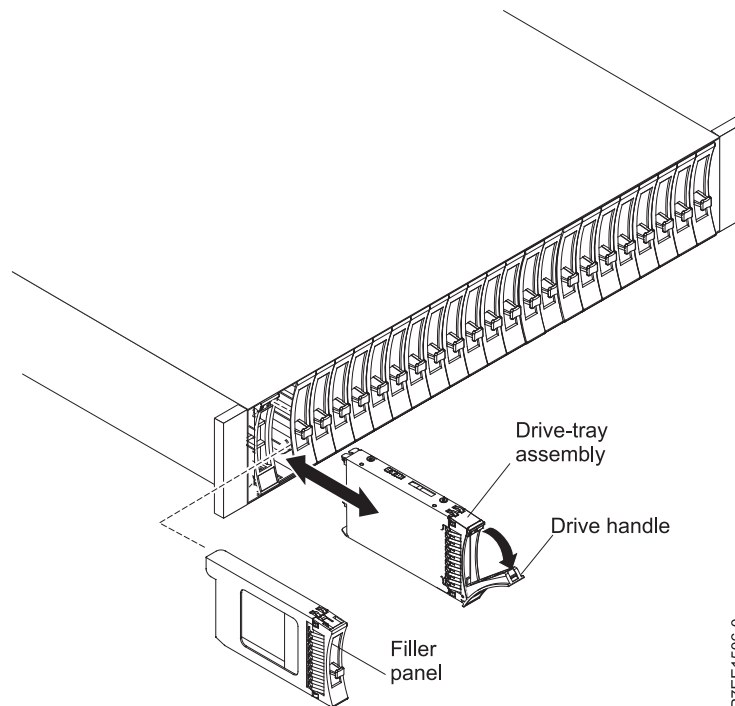

Figure 34. Removing a drive from an ESLL or ESLS storage enclosure

5. Support the bottom of the drive as you slide it out of the system. Hold the drive by its sides.

6. Press Enter on the console to indicate that you removed the drive. The identify LED turns off.
7. If you are removing more than one drive, repeat the steps in this procedure until all drives are removed.
8. If you are not installing a replacement drive, install a filler in the empty slot to ensure proper air flow for cooling.

Replacing a disk drive or SSD in an ESLL or ESLS storage enclosure with the power turned on in AIX

Find information about replacing a disk drive or solid-state drive (SSD) in an enclosure with the AIX operating system or AIX logical partition that controls the drive location powered on.

To replace a disk drive or an SSD in an enclosure, complete the following steps:

1. Ensure that you have the electrostatic discharge (ESD) wrist strap attached. If not, attach it now.
2. With the handle in the unlocked position, as shown in Figure 35, support the bottom of the drive as you align it with the guide rails in the enclosure.

Note: Support the drive by holding the drive by its sides.

3. Slide the drive halfway into the enclosure.
4. On the console, select the drive that you want to install and then press Enter.
5. When the identify LED turns on solid, slide the drive into the enclosure until the drive stops.

Important: Ensure that the drive is fully seated and is all the way into the system.

6. Lock the drive by rotating the handle (A) in the direction that is shown in Figure 35.

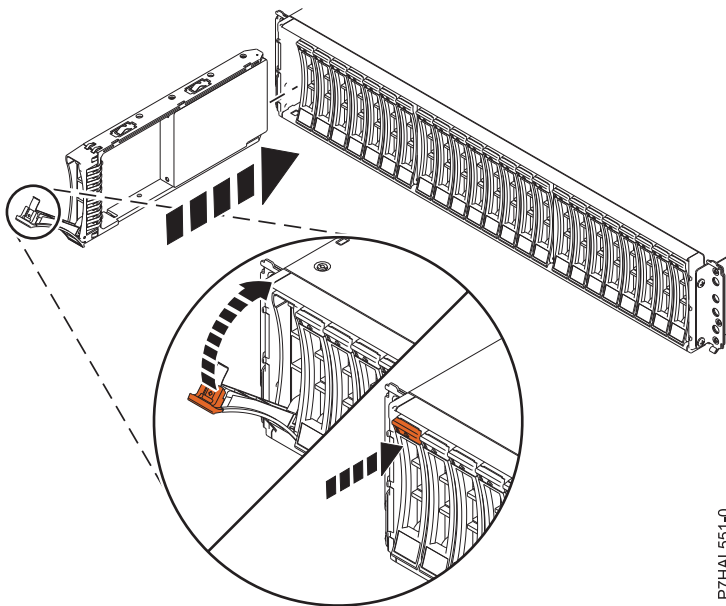

Figure 35. Installing or replacing the disk drive in an ESLL or ESLS storage enclosure

7. On the console, press Enter to indicate that you installed the drive.
8. If you are replacing more than one drive, repeat the steps in this procedure until all drives are replaced.

Preparing an ESLL or ESLS storage enclosure for operation after replacing a drive with the power turned on in AIX

Learn to prepare the enclosure for operation after you replace a disk drive or solid-state drive (SSD) in an enclosure with the AIX operating system or AIX logical partition that controls the drive location powered on.

To prepare the enclosure for operation, complete the following steps:

1. If you replaced a drive and have not verified the drive yet, verify that the power LED is **ON** (green) and the amber fault LED is **OFF** (not lit) for the replaced drive on the front of the system.
2. To configure the newly installed disk drive or solid-state drive, see “Configuring a disk drive or solid-state drive for use in an AIX system or AIX logical partition” on page 70.
3. To rebuild the data on the replacement disk drive or solid-state drive, see “Rebuilding data on a replacement disk drive or solid-state drive in a system or logical partition running the AIX operating system” on page 75.

Removing and replacing a disk drive or SSD in an ESLS storage enclosure with the power turned on in IBM i

Learn how to remove and replace a disk drive or solid-state drive (SSD) in an enclosure with the IBM i operating system or IBM i logical partition that controls the drive location powered on.

To remove and replace a disk drive or solid-state drive, complete the following steps:

1. “Preparing an ESLS storage enclosure to remove and replace a disk drive or solid-state drive with the power turned on in IBM i.”
2. “Removing a disk drive or SSD from an ESLS storage enclosure with the power turned on in IBM i” on page 35.
3. “Replacing a disk drive or SSD in an ESLS storage enclosure with the power turned on in IBM i” on page 36.
4. “Preparing an ESLS storage enclosure for operation after removing and replacing a drive with the power turned on in IBM i” on page 38.

Note: Removing or replacing this feature is a customer task. You can complete this task yourself, or contact a service provider to complete the task for you. You might be charged a fee by the service provider for this service.

Preparing an ESLS storage enclosure to remove and replace a disk drive or solid-state drive with the power turned on in IBM i

Learn about the steps you must complete before you remove and replace a disk drive or solid-state drive (SSD) in an enclosure with the IBM i operating system or IBM i logical partition that controls the drive location powered on.

If the drive that you are removing is a configured unit and it is not protected by either Redundant Array of Independent Disks (RAID) or mirroring, or to use the powered-off procedure, go to “Removing a disk drive or SSD from the 5147-024, ESLL, or ESLS storage enclosure with the power turned off” on page 23.

To prepare the system to remove and replace a disk drive or solid-state drive, complete the following steps:

1. Determine the protection status of the disk drive or solid-state drive that you are replacing. For instructions, see “Determining the disk drive or solid-state drive protection status in the IBM i operating system” on page 73.
2. Before you remove a disk drive or solid-state drive, ensure that you back up all the data from the drive or from the array that the drive is a part of. Then, move the data from the drive that you want to remove. For instructions, choose one of the following options:

- If you are moving and removing disk units, go to IBM i Knowledge Center (http://www-01.ibm.com/support/knowledgecenter/ssw_ibm_i/welcome) and then select **Systems management > Disk management > Disk pools > Managing disk pools > Moving or removing a disk unit from a disk pool**.
 - If you are recovering the system, go to IBM i Knowledge Center (http://www-01.ibm.com/support/knowledgecenter/ssw_ibm_i/welcome) and select the version of IBM i that you are using. Then, select **Systems management > Backup and recovery > Recovering your system**.
3. If you are removing a solid-state device that is on a PCIe RAID and SSD SAS adapter, go to Replacing an SSD module on the PCIe RAID and SSD SAS adapter and complete that procedure.
 4. Verify that the disk drive or solid-state drive you are replacing is suspended before you continue with this procedure. For mirrored disk drives in an IBM i system or an IBM i logical partition, complete the following steps to verify that the disk drive or solid-state drive you are removing is suspended:
 - a. Sign on with service level authority.
 - b. Type `strsst` on the command line of the IBM i session and then press Enter.
 - c. Type your service tools user ID and service tools password in the Start Service Tools Sign On display. Press Enter.

Note: The service tools password is case-sensitive.
 - d. Select **Work with disk units** from the System Service Tools (SST) display, and then press Enter.
 - e. Select **Display Disk Configuration** from the Work with Disk Units display, and then press Enter.
 - f. Select **Display Disk Configuration Status** from the Display Disk Configuration display, and then press Enter.
 - g. Does the disk drive or solid-state drive that is mirrored to the drive that you are replacing (same drive number) have a status of Active?
 - **No:** The replacement must be completed by a service provider.
 - **Yes:** Does the disk drive or solid-state drive that you are replacing have a status of Suspended?
 - **Yes:** Continue with the next step.
 - **No:** Follow these steps to suspend mirrored protection on the disk drive or solid-state drive that you are replacing:
 - 1) Press F3 from the Display Disk Configuration display to return to the Work with Disk Units display.
 - 2) Select **Work with Disk Unit Recovery** from the Work with Disk Units display, and then press Enter.
 - 3) Select **Suspend mirrored protection** from the Work with Disk Unit Recovery display, and then press Enter.
 - 4) Select the option to suspend the disk drive or solid-state drive that you are replacing from the Suspend Mirrored Protection display, and then press Enter.
 - h. Press F3 repeatedly to exit System Service Tools and return to the main menu.
 5. Identify the part and the enclosure that you want to service. The disk drive and SSD slots are located in the front of the enclosure. Figure 36 on page 33 shows the front of the ESLS storage enclosure, Figure 37 on page 33 shows the rear view of the storage enclosure, and Figure 38 on page 33 shows the locations of the service indicators for the enclosure.

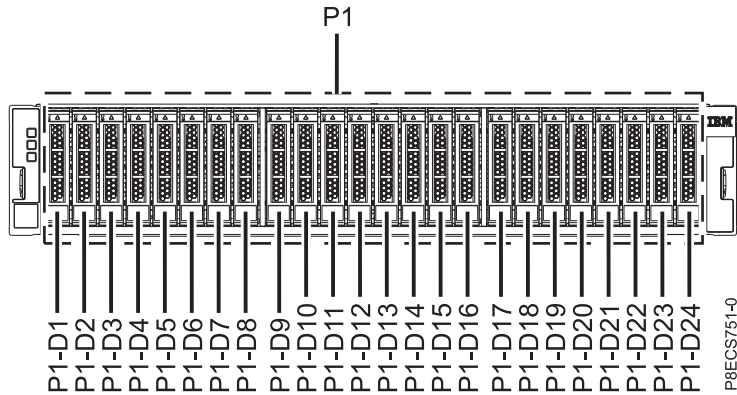

Figure 36. Front view of the ESLS storage enclosure showing the drive locations

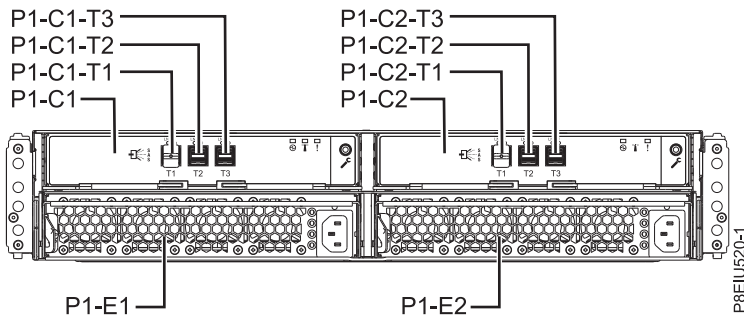

Figure 37. Rear view of the enclosure

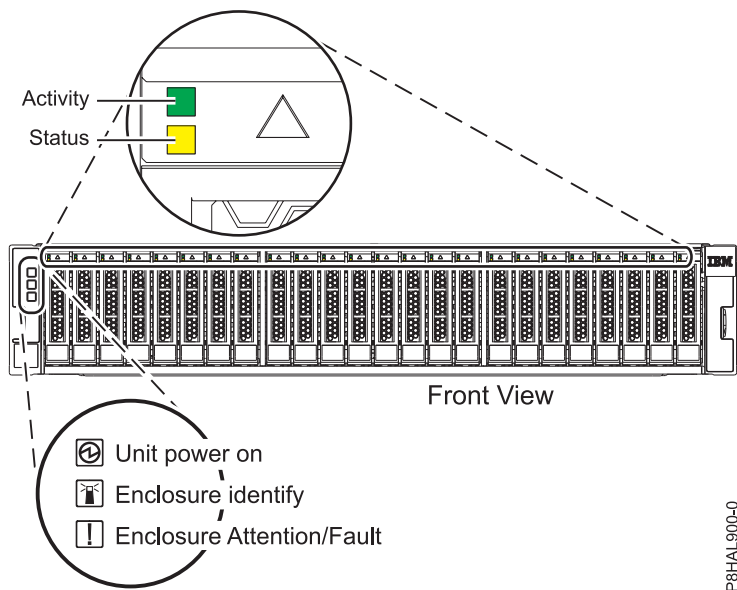

Figure 38. Front view of the ESLS storage enclosure showing the service indicators

Note: When you have drive slots available in a system, enclosure, or expansion unit, fill the slot positions in the system first. However, you can choose a different disk drive or solid-state drive placement that depends on your data protection strategy.

6. Locate the disk drive or solid-state drive to be replaced and record the location information. Then, use the location information to activate the identify light for that drive. For instructions, see “Finding the location code and activating the indicator light for a part by using the IBM i operating system” on page 84.
7. Determine whether the disk drive or solid-state drive to be removed is a non-configured drive by completing the following steps:
 - a. Type `strsst` on the command line of the IBM i session, and then press Enter.
 - b. Type your service tools user ID and service tools password, and then press Enter.
 - c. Select **Work with disk units**, and then press Enter.
 - d. Select **Display Disk Configuration**, and then press Enter.
 - e. Select **Display non-configured units**, and then press Enter.
8. Is the failed drive listed as a non-configured drive in the display?
 - **No:** Continue with step 11.
 - **Yes:** Continue with step 9.
9. Determine whether the disk drive or solid-state drive to be removed was replaced by a hot-spare drive when it failed by completing the following steps:
 - a. Go to the service action log. For instructions to access the service action log, see “Finding the location code and activating the indicator light for a part by using the IBM i operating system” on page 84.
 - b. Determine whether an `xxxx9031` error was logged close to the same time as the original disk failure. This error indicates that the data to the hot-spare drive was automatically rebuilt.
 - c. Determine whether an error was logged for the field-replaceable unit (FRU) by using concurrent maintenance. If yes, continue with the next step.
10. Did you find the service action log entry that is related to this problem?
 - **No:** Exit the service action log and go to step 12.
 - **Yes:** Continue with the next step.
11. Within the service action log, select the concurrent maintenance option. This option displays the drive location on the concurrent maintenance display. Go to step 14 on page 35.
12. From the Hardware Service Manager, navigate to **Select Device Concurrent Maintenance** option. Press Enter. The Device Concurrent Maintenance display is shown, as shown in the Figure 39.

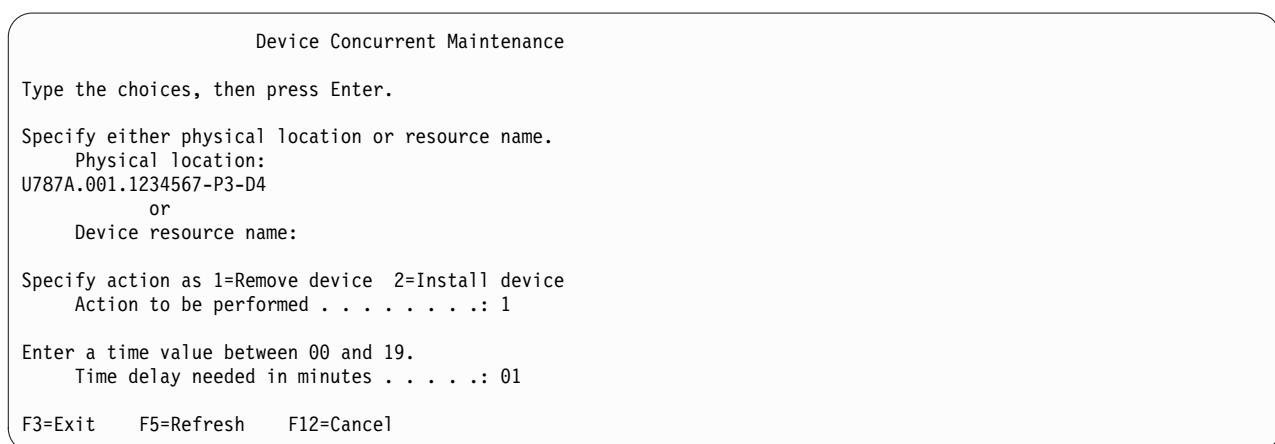

Figure 39. Example Device Concurrent Maintenance display

13. If the physical location does not show in the Device Concurrent Maintenance display, type the physical location where you are replacing the disk drive or solid-state drive as shown in the following example:

The physical location has the following form: U787A.001.AAAXXXX-P3-D4 where P3-D4 is the position of the disk drive or solid-state drive in the system unit or an expansion unit. You can get the U787A.001.AAAXXXX location information from the control panel display on the system unit or expansion unit.

If you cannot get the information from the control panel, find the feature code (FC) and sequence number (SN or SEQ) on the label that is on the front of the system unit or an expansion unit as shown in the following figure.



Figure 40. Example system or expansion unit label

In this example, U787A.001.AAAXXXX-P3-D4, U787A.001 comes from the feature code (FC) on the label, AAAXXXX comes from the last 7 digits of the sequence number (SN or SEQ) on the label, and P3-D4 is the slot where you are replacing the disk drive or solid-state drive.

In the example, U5074.001.AAAXXXX-DB3-D32, you would replace a disk drive or solid-state drive in the expansion unit with type 5074, model 001, sequence number AAAXXXX, and disk drive or solid-state drive position DB3-D32.

14. Select 1 (Remove device) for the action to be completed.
15. Set the time delay in minutes. For example, for one minute enter: 01

Note: You can set an appropriate time delay of 01 - 19 minutes to allow adequate time to access the disk drive or solid-state drive.

Important: Do not press Enter now.

16. Locate the service indicator that corresponds to the position of the drive that you are removing from a system, drive enclosure, or an expansion unit. For details about locations of the service indicators, see step 5 on page 32.
17. Find the package that contains the new drive.
Attention: Drives are fragile. Handle with care.
18. Attach the electrostatic discharge (ESD) wrist strap.
Attention:
 - Attach an electrostatic discharge (ESD) wrist strap to the front ESD jack, to the rear ESD jack, or to an unpainted metal surface of your hardware to prevent the electrostatic discharge from damaging your hardware.
 - When you use an ESD wrist strap, follow all electrical safety procedures. An ESD wrist strap is used for static control. It does not increase or decrease your risk of receiving electric shock when using or working on electrical equipment.
 - If you do not have an ESD wrist strap, just prior to removing the product from ESD packaging and installing or replacing hardware, touch an unpainted metal surface of the system for a minimum of 5 seconds.
19. Remove the drive from the static-protective package and place it on an ESD mat.

Removing a disk drive or SSD from an ESLS storage enclosure with the power turned on in IBM i

Find information about removing a disk drive or solid-state drive (SSD) from an enclosure with the IBM i operating system or IBM i logical partition that controls the drive location powered on.

To remove a disk drive or an SSD from an enclosure, complete the following steps:

1. On the console, select the drive that you want to remove, and then press Enter.

Important:

- When you press Enter, after your selected time delay, the service indicator light comes on (solid) for 18 seconds. You then have 18 seconds to unlock and remove the drive. You can set an appropriate time delay of 01 - 19 minutes to allow adequate time to access the disk drive or solid-state drive.
 - If the service indicator light was already turned on due to a failed device, you will not see a change in the service indicator light until after the first 18 seconds. You will need to wait until the service indicator light goes off and then turns back on (solid). You will have two cycles of the light turning on (solid) to unlock and remove the drive.
2. Ensure that you have the electrostatic discharge (ESD) wrist strap attached. If not, attach it now.
 3. When the identify LED turns on solid, slide the terracotta release latch up gently to unlock the drive handle.
 4. Grasp the handle and pull the drive partially out of the slot.
 5. Grasp the front of the drive and pull it out from the slot, ensuring that you support the bottom of the drive, as shown in Figure 41.

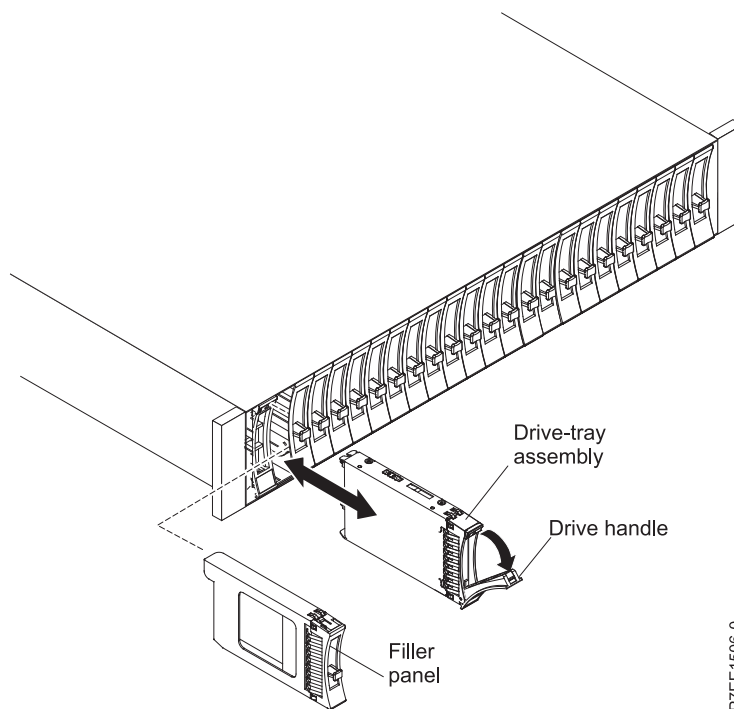

Figure 41. Removing a drive from an ESLS storage enclosure

6. Press Enter on the console to indicate that you removed the drive. The identify LED turns off.
7. If you are removing more than one drive, repeat the steps in this procedure until all drives are removed.
8. If you are not installing a replacement drive, install a filler in the empty slot to ensure proper air flow for cooling.

Replacing a disk drive or SSD in an ESLS storage enclosure with the power turned on in IBM i

Find information about replacing a disk drive or solid-state drive (SSD) in an enclosure with the IBM i operating system or IBM i logical partition that controls the drive location powered on.

To replace a disk drive or an SSD in an enclosure, complete the following steps:

1. Return to the console and complete the following steps. Wait until the Concurrent Maintenance Results display is shown.
 - a. Press F12.
 - b. The physical locations that you entered while you removed the disk drive or solid-state drive might still show on the display. If not, retype the physical location where you want to install the new disk drive or solid-state drive.
 - In the example, U787A.001.1234567-P3-D4, you would install a disk drive in the system unit with type 9406, Model 520, sequence number 1234567, and disk drive or solid-state drive position P3-D4.
 - In the example, U5074.001.1234567-DB3-D32, you would install a disk drive or solid-state drive in the expansion unit with type 5074, model 001, sequence number 1234567, and disk drive or solid-state drive position DB3-D32.
 - c. Select 2 (Install device) for the Action to be completed.
 - d. Set the time delay. For example, for one minute: 01.

Note: You can set an appropriate time delay of 01 - 19 minutes to allow adequate time to access the disk drive or solid-state drive.

Important: Do not press Enter yet.

2. Ensure that you have the electrostatic discharge (ESD) wrist strap attached. If not, attach it now.
3. With the handle in the unlocked position, as shown in Figure 42 on page 38, support the bottom of the drive as you align it with the guide rails in the expansion unit.

Note: Support the drive by holding the drive by its sides.

4. Slide the drive halfway into the enclosure.
5. On the console, select the drive that you want to install and then press Enter.
6. Press Enter on the console.

Important: When you press Enter, after your selected time delay, the service indicator light comes on (solid) for 18 seconds. You then have 18 seconds to slide the drive all the way in and then lock it in place by pushing in the drive handle. You can set an appropriate time delay of 01 - 19 minutes to allow adequate time to access the disk drive or solid-state drive.

7. When the identify LED turns on solid, slide the drive into the ESLS storage enclosure until the drive stops.

Important: Ensure that the drive is fully seated and is all the way into the system.

8. Lock the drive by rotating the bay handle (A) in the direction that is shown in Figure 42 on page 38.

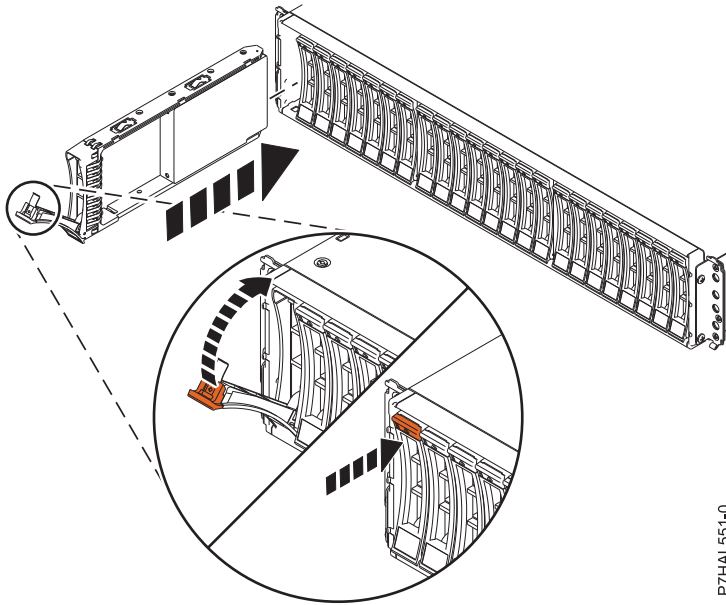

Figure 42. Replacing a disk drive in an enclosure

9. On the console, press Enter to indicate that you installed the drive.
10. If you are installing more than one drive, repeat the steps in this procedure until all drives are installed.

Preparing an ESLS storage enclosure for operation after removing and replacing a drive with the power turned on in IBM i

Learn to prepare the system for operation after you replace a disk drive or solid-state drive (SSD).

To prepare the system for operation, complete the following steps:

1. If you replaced a drive and have not verified the drive yet, verify that the power LED is **ON** (green) and the amber fault LED is **OFF** (not lit) for the replaced drive on the front of the system.
2. Return to the console and wait until the Concurrent Maintenance Results display is shown, and then press Enter.
3. If you return to the Service Action Log display, exit the service action log.
4. When the Hardware Service Manager (HSM) display is shown, press F3.
5. To configure the newly installed disk drive or solid-state drive, see “Configuring a disk drive or solid-state drive for use in an IBM i system or IBM i logical partition” on page 70.
6. To rebuild the data on the replacement disk drive or solid-state drive, see “Rebuilding data on a replacement disk drive or solid-state drive in a system or logical partition running the IBM i operating system” on page 75.

Removing and replacing a disk drive or SSD in an ESLS storage enclosure by using the hot-spare function with the power turned on in IBM i

Learn how to remove and replace a disk drive or solid-state drive (SSD) by using the hot-spare function with the IBM i system or an IBM i logical partition that controls the drive location powered on.

To remove and replace a disk drive or solid-state drive in a system, complete the following steps:

1. “Preparing an ESLS storage enclosure to remove and replace a disk drive or SSD by using the hot-spare function with the power turned on in IBM i” on page 39.

2. "Removing a hot-spare disk drive or SSD from an ESLS storage enclosure with the power turned on in IBM i" on page 42.
3. "Replacing a hot-spare disk drive or SSD in an ESLS storage enclosure with the power turned on in IBM i" on page 43.
4. "Preparing an ESLS storage enclosure for operation after removing and replacing a hot-spare drive with the power turned on in IBM i" on page 44.

Note: Removing or replacing this feature is a customer task. You can complete this task yourself, or contact a service provider to complete the task for you. You might be charged a fee by the service provider for this service.

Preparing an ESLS storage enclosure to remove and replace a disk drive or SSD by using the hot-spare function with the power turned on in IBM i

Learn about the steps you must complete before you remove and replace a disk drive or solid-state drive (SSD) by using the hot-spare function in an enclosure with the IBM i operating system or IBM i logical partition that controls the drive location powered on.

To prepare an enclosure to remove and replace a disk drive or solid-state drive, complete the following steps:

1. Determine the protection status of the disk drive or solid-state drive that you are replacing. For instructions, see "Determining the disk drive or solid-state drive protection status in the IBM i operating system" on page 73.
2. If you are removing a solid-state device that is on a PCIe RAID and SSD SAS adapter, go to Replacing an SSD module on the PCIe RAID and SSD SAS adapter and complete that procedure.
3. Identify the part and the enclosure that you want to service. The disk drive and SSD slots are located in the front of the enclosure. Figure 43 shows the front of the ESLS storage enclosure, Figure 44 on page 40 shows the rear view of the storage enclosure, and Figure 45 on page 40 shows the locations of the service indicators for the enclosure.

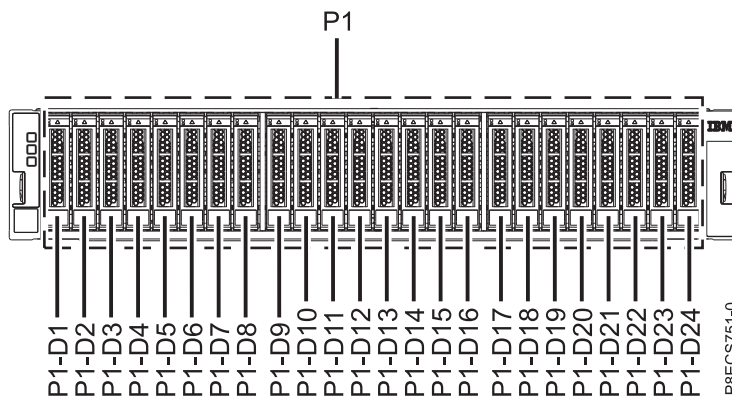

Figure 43. Front view of the ESLS storage enclosure showing the drive locations

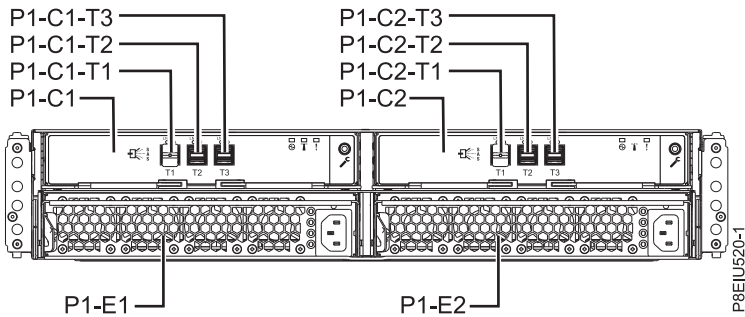

Figure 44. Rear view of the storage enclosure

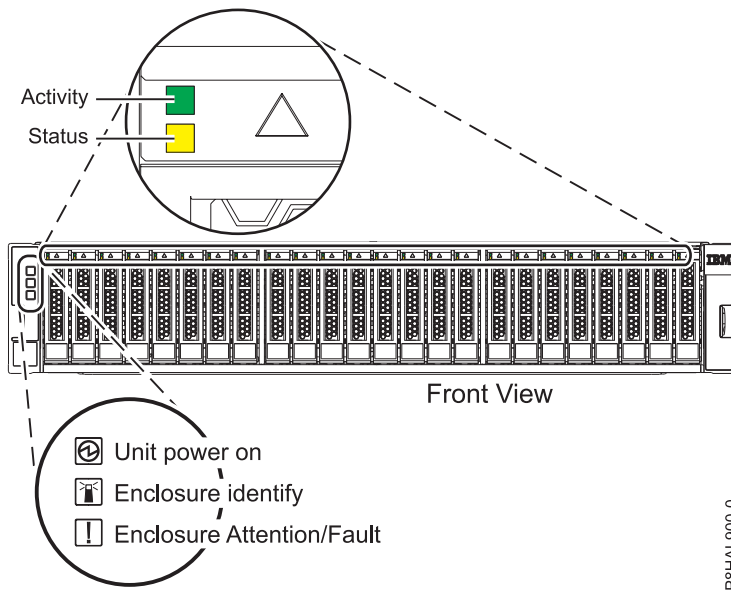

Figure 45. Front view of the storage enclosure showing the service indicators

Note: When you have drive slots available in a system, enclosure, or expansion unit, fill the slot positions in the system first. However, you can choose a different disk drive or solid-state drive placement that depends on your data protection strategy.

4. Locate the disk drive or solid-state drive to be replaced and record the location information. Then, use the location information to activate the identify light for that drive. For instructions, see “Finding the location code and activating the indicator light for a part by using the IBM i operating system” on page 84.
5. Determine whether the disk drive or solid-state drive to be removed is a non-configured drive by completing the following steps:
 - a. Type `strsst` on the command line of the IBM i session, and then press Enter.
 - b. Type your service tools user ID and service tools password, and then press Enter.
 - c. Select **Work with disk units**, and then press Enter.
 - d. Select **Display Disk Configuration**, and then press Enter.
 - e. Select **Display non-configured units**, and then press Enter.
6. Is the failed drive listed as a non-configured drive in the display?
 - **No:** Continue with “Removing and replacing a disk drive or SSD in an ESLS storage enclosure with the power turned on in IBM i” on page 31.

- **Yes:** Determine if the disk drive to be removed was replaced by a hot spare when it failed. An `xxxx9031` error logged close to the same time of the original disk failure indicates the automatic Rebuild of the data to a hot-spare device, then go on to the next step.
7. Is the disk drive to be removed controlled by the load source adapter?
 - **No:** Go to step 10.
 - **Yes:** Go to the next step.
 8. Is the disk drive to be removed located in a valid load source position?
 - **No:** Go to “Configuring a disk drive or solid-state drive on a load source adapter for hot-spare protection by using the IBM i operating system” on page 72.
 - **Yes:** Go to step 10.
 9. Choose the concurrent maintenance option. This option shows the disk drive location on the concurrent maintenance display. Go to step 12 on page 42.
 10. From the Hardware Service Manager, navigate to **Select Device Concurrent Maintenance** option. Press Enter. The Device Concurrent Maintenance display is shown, as shown in the Figure 46.

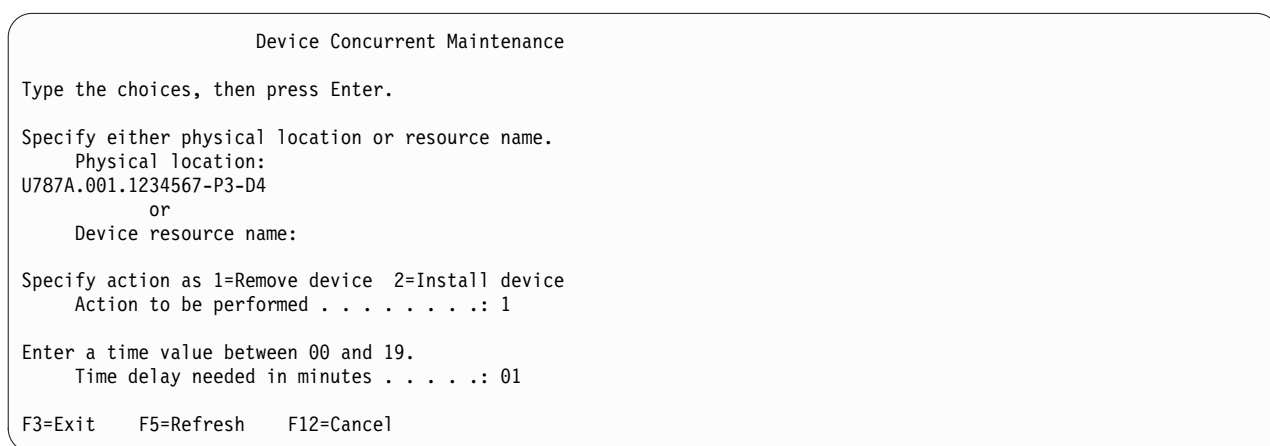

Figure 46. Example Device Concurrent Maintenance display

11. If the physical location does not show in the Device Concurrent Maintenance display, type the physical location where you are replacing the disk drive or solid-state drive as shown in the following example:

The physical location has the following form: `U787A.001.AAAXXXX-P3-D4` where P3-D4 is the position of the disk drive or solid-state drive in the system unit or an expansion unit. You can get the `U787A.001.AAAXXXX` location information from the control panel display on the system unit or expansion unit.

If you cannot get the information from the control panel, find the feature code (FC) and sequence number (SN or SEQ) on the label that is on the front of the system unit or an expansion unit as shown in the following figure.



Figure 47. Example system or expansion unit label

In this example, U787A.001.AAAXXX-P3-D4, U787A.001 comes from the feature code (FC) on the label, AAAXXX comes from the last 7 digits of the sequence number (SN or SEQ) on the label, and P3-D4 is the slot where you are replacing the disk drive or solid-state drive.

In the example, U5074.001.AAAXXX-DB3-D32, you would replace a disk drive or solid-state drive in the expansion unit with type 5074, model 001, sequence number AAAXXX, and disk drive or solid-state drive position DB3-D32.

12. Select 1 (Remove device) for the action to be completed.
13. Set the time delay in minutes. For example, for one minute enter: 01

Note: You can set an appropriate time delay of 01 - 19 minutes to allow adequate time to access the disk drive or solid-state drive.

Important: Do not press Enter now.

14. Find the package that contains the new drive.

Attention: Drives are fragile. Handle with care.

15. Attach the electrostatic discharge (ESD) wrist strap.

Attention:

- Attach an electrostatic discharge (ESD) wrist strap to the front ESD jack, to the rear ESD jack, or to an unpainted metal surface of your hardware to prevent the electrostatic discharge from damaging your hardware.
- When you use an ESD wrist strap, follow all electrical safety procedures. An ESD wrist strap is used for static control. It does not increase or decrease your risk of receiving electric shock when using or working on electrical equipment.
- If you do not have an ESD wrist strap, just prior to removing the product from ESD packaging and installing or replacing hardware, touch an unpainted metal surface of the system for a minimum of 5 seconds.

16. Remove the drive from the static-protective package and place it on an ESD mat.

Removing a hot-spare disk drive or SSD from an ESLS storage enclosure with the power turned on in IBM i

Find information about removing a hot-spare disk drive or solid-state drive (SSD) from an enclosure with the IBM i operating system or IBM i logical partition that controls the drive location powered on.

To remove a hot-spare disk drive or an SSD from an enclosure, complete the following steps:

1. On the console, select the drive that you want to remove, and then press Enter.

Important:

- When you press Enter, after your selected time delay, the service indicator light comes on (solid) for 18 seconds. You then have 18 seconds to unlock and remove the drive. You can set an appropriate time delay of 01 - 19 minutes to allow adequate time to access the disk drive or solid-state drive.
 - If the service indicator light was already turned on due to a failed device, you will not see a change in the service indicator light until after the first 18 seconds. You will need to wait until the service indicator light goes off and then turns back on (solid). You will have two cycles of the light turning on (solid) to unlock and remove the drive.
2. Ensure that you have the electrostatic discharge (ESD) wrist strap attached. If not, attach it now.
 3. When the identify LED turns on solid, slide the terracotta release latch up gently to unlock the drive handle.
 4. Grasp the handle and pull the drive partially out of the slot.
 5. Grasp the front of the drive and pull it out from the slot, ensuring that you support the bottom of the drive, as shown in Figure 48 on page 43.

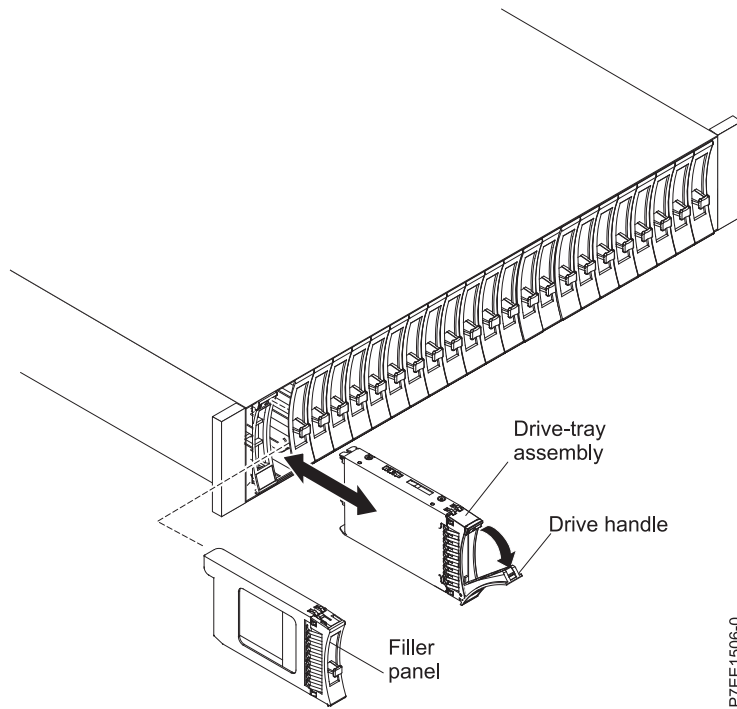

Figure 48. Removing a drive from an ESLS storage enclosure

6. Press Enter on the console to indicate that you removed the drive. The identify LED turns off.
7. If you are removing more than one drive, repeat the steps in this procedure until all drives are removed.
8. If you are not installing a replacement drive, install a filler in the empty slot to ensure proper air flow for cooling.

Replacing a hot-spare disk drive or SSD in an ESLS storage enclosure with the power turned on in IBM i

Find information about replacing a hot-spare disk drive or solid-state drive (SSD) in an enclosure with the IBM i operating system or IBM i logical partition that controls the drive location powered on.

To replace a hot-spare disk drive or an SSD in an enclosure, complete the following steps:

1. Ensure that you have the electrostatic discharge (ESD) wrist strap attached. If not, attach it now.
2. Return to the console and complete the following steps. Wait until the Concurrent Maintenance Results display is shown.
 - a. Press F12.
 - b. The physical locations that you entered while you removed the disk drive or solid-state drive might still show on the display. If not, retype the physical location where you want to install the new disk drive or solid-state drive.
 - In the example, U787A.001.1234567-P3-D4, you would install a disk drive in the system unit with type 9406, Model 520, sequence number 1234567, and disk drive or solid-state drive position P3-D4.
 - In the example, U5074.001.1234567-DB3-D32, you would install a disk drive or solid-state drive in the expansion unit with type 5074, model 001, sequence number 1234567, and disk drive or solid-state drive position DB3-D32.
 - c. Select 2 (Install device) for the Action to be completed.
 - d. Set the time delay. For example, for one minute: 01.

Note: You can set an appropriate time delay of 01 - 19 minutes to allow adequate time to access the disk drive or solid-state drive.

Important: Do not press Enter yet.

3. With the handle in the unlocked position, as shown in Figure 49, support the bottom of the drive as you align it with the guide rails in the expansion unit.

Note: Support the drive by holding the drive by its sides.

4. Slide the drive halfway into the ESLS storage enclosure.
5. On the console, select the drive that you want to install and then press Enter.
6. Press Enter on the console.

Important: When you press Enter, after your selected time delay, the service indicator light comes on (solid) for 18 seconds. You then have 18 seconds to slide the drive all the way in and then lock it in place by pushing in the drive handle. You can set an appropriate time delay of 01 - 19 minutes to allow adequate time to access the disk drive or solid-state drive.

7. When the identify LED turns on solid, slide the drive into the ESLS storage enclosure until the drive stops.

Important: Ensure that the drive is fully seated and is all the way into the system.

8. Lock the drive by rotating the bay handle (A) in the direction that is shown in Figure 49.

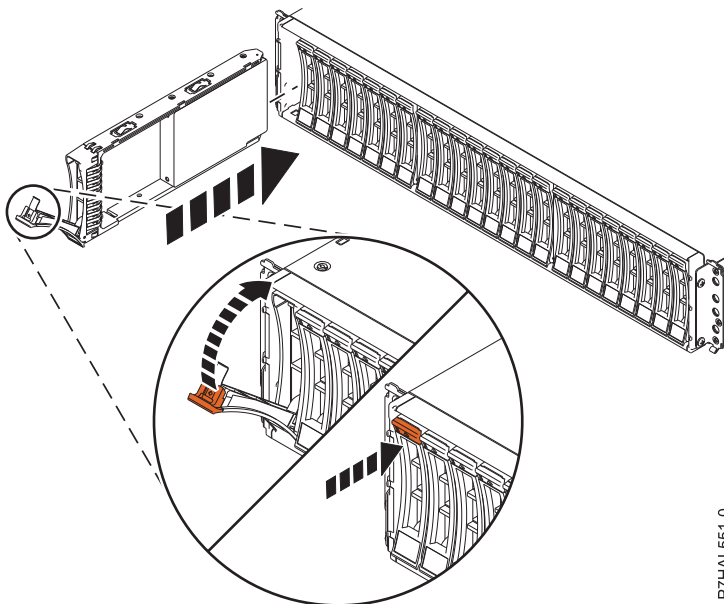

Figure 49. Installing or replacing a disk drive in an enclosure

9. On the console, press Enter to indicate that you installed the drive.
10. If you are installing more than one drive, repeat the steps in this procedure until all drives are installed.

Preparing an ESLS storage enclosure for operation after removing and replacing a hot-spare drive with the power turned on in IBM i

Learn to prepare the system for operation after you replace a hot-spare disk drive or solid-state drive (SSD) in a system with the IBM i operating system or IBM i logical partition that controls the drive location powered on.

To prepare the system for operation, complete the following steps:

1. Return to the console and wait until the Concurrent Maintenance Results display is shown, and press Enter if you used the concurrent maintenance process, otherwise continue with the next step.
2. If you return to the HSM, exit the HSM.
3. Select **Work with disk units** from the Start System Service Tools display and complete the following steps:
 - a. Select **Non-configured disk units** from the Work with Disk Units display, and press Enter.
 - b. Is the new disk unit displayed with a status of non-configured?

Note: It might take several minutes for the new drive to display.

- **No:** Contact your next level of support.
- **Yes:** Continue with the next step.

- c. Press **F3** to return to the **Work with Disk Units** display.
- d. Select **Work with disk unit recovery** from the Work with Disk Units display, and press Enter.
- e. Select **Disk unit problem recovery procedure**, and press Enter.
- f. Select **Initialize and format disk unit**, and press Enter.
- g. Select the new disk and press Enter.

Note: This task takes several minutes to complete.

- h. When the disk drive is initialized and formatted, press **F3** to return to the Work with Disk Units display.
- i. Select **Start hot spare**, and press Enter.
- j. Select the IOA with the new disk, then press Enter and press Enter again.
- k. Does the new hot spare disk drive have a smaller capacity than previous hot spare disk drive? Refer to the resource name identified in the xxxx9031 error that was logged close to the same time of the original disk failure.
 - **No:** The procedure is complete. Press **F3** to return to the System Service Tools display.
 - **Yes:** Go to the next step.
4. Select **Display Device Parity Status**, and press Enter. If the new disk drive is not active and hot spare protected, do not continue. Call your next level of support.
5. You must complete the following steps to ensure that your data is protected. To exchange the two disk drives so that the larger disk drive becomes the hot spare, and the smaller disk drive becomes a parity set member, complete the following steps:
 - a. Fail the previous hot spare disk drive by unlocking the disk drive handle by squeezing it and pulling it out toward you.
 - b. Pull the drive out about one inch and wait ten seconds.
 - c. Push the disk drive back into the slot and close the handle.
6. Return to step 1 and start the hot-spare procedure on the larger drive.
7. If you replaced a drive and have not verified the drive yet, verify that the power LED is **ON** (green) and the amber fault LED is **OFF** (not lit) for the replaced drive on the front of the system.
8. To configure the newly installed disk drive or solid-state drive, see “Configuring a disk drive or solid-state drive for use in an IBM i system or IBM i logical partition” on page 70.
9. To rebuild the data on the replacement disk drive or solid-state drive, see “Rebuilding data on a replacement disk drive or solid-state drive in a system or logical partition running the IBM i operating system” on page 75.

Removing and replacing a disk drive or SSD in the 5147-024, ESLL, or ESLS storage enclosure with the power turned on in Linux

Learn how to remove and replace a disk drive or solid-state drive (SSD) in an enclosure with the Linux operating system or a Linux logical partition that controls the drive location powered on.

To remove and replace a disk drive or solid-state drive in a system, complete the following steps:

1. “Preparing the 5147-024, ESLL, or ESLS storage enclosure to remove and replace a disk drive or SSD with the power turned on in Linux.”
2. “Removing a disk drive or solid-state drive from the 5147-024 or ESLS storage enclosure with the power turned on in Linux” on page 51.
3. “Replacing a disk drive or SSD in the 5147-024 or ESLS storage enclosure with the power turned on in Linux” on page 51.
4. “Preparing the 5147-024 or ESLS storage enclosure for operation after removing and replacing a drive with the power turned on in Linux” on page 53.

Note: Removing or replacing this feature is a customer task. You can complete this task yourself, or contact a service provider to complete the task for you. You might be charged a fee by the service provider for this service.

Preparing the 5147-024, ESLL, or ESLS storage enclosure to remove and replace a disk drive or SSD with the power turned on in Linux

Learn about the steps you must complete before you remove and replace a disk drive or solid-state drive (SSD) in an enclosure with the Linux operating system or Linux logical partition that controls the drive location powered on.

If the drive that you are removing is in the root volume group (rootvg) and it is not protected by either Redundant Array of Independent Disks (RAID) or mirroring, or to use the powered-off procedure, go to “Removing and replacing a disk drive or SSD in the 5147-024, ESLL, or ESLS storage enclosure with the system power turned off” on page 19.

To prepare the system to remove and replace a disk drive or solid-state drive, complete the following steps:

1. Identify the part and the enclosure that you want to service. The disk drive and SSD slots are located in the front of the enclosure. Figure 50 shows the front of the ESLL storage enclosure, Figure 51 on page 47 shows the front of the ESLS storage enclosure, Figure 52 on page 47 shows the rear view of the storage enclosures, and Figure 53 on page 47 shows the locations of the service indicators for the enclosures.

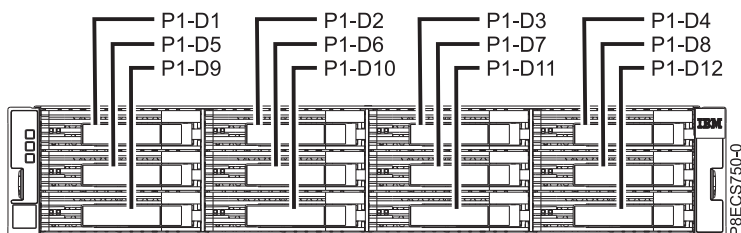

Figure 50. Front view of the ESLL storage enclosure showing the disk drive locations

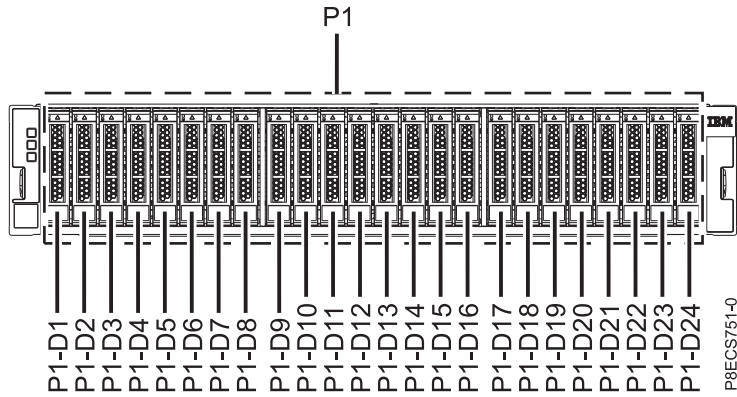

Figure 51. Front view of the 5147-024 or ESLS storage enclosure showing the drive locations

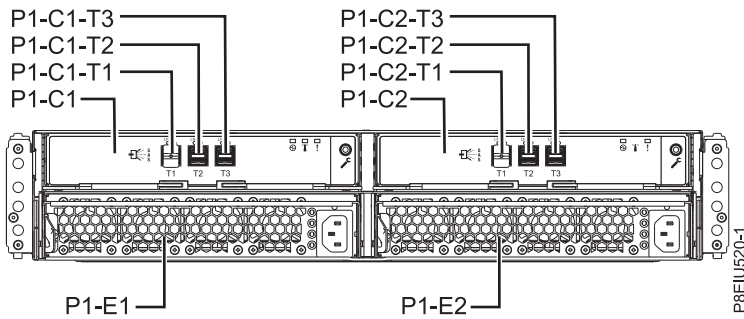

Figure 52. Rear view of the storage enclosures

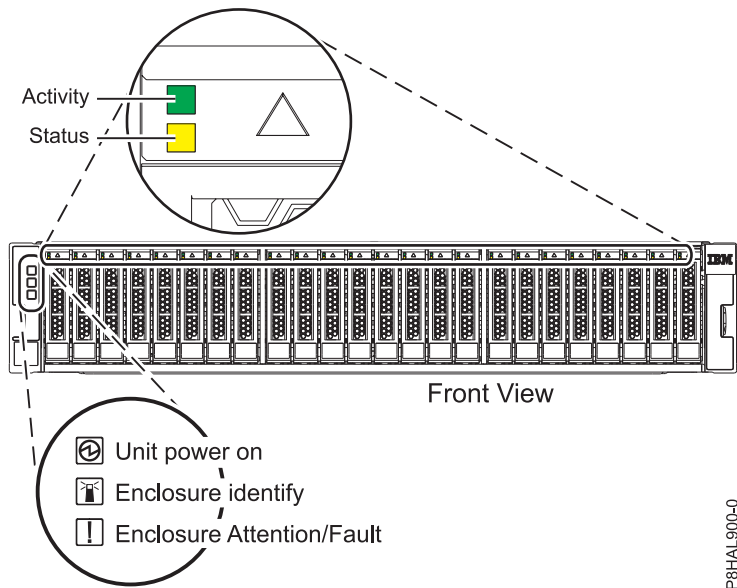

Figure 53. Front view of the storage enclosure showing the service indicators

Note: When you have drive slots available in a system, enclosure, or expansion unit, fill the slot positions in the system first. However, you can choose a different disk drive or solid-state drive placement that depends on your data protection strategy.

2. To identify the drive by using the **iprconfig** command before you remove a disk drive or solid-state drive, complete the following steps:
 - a. Log in as root user.
 - b. Type **iprconfig** on the command line of the Linux session and press Enter. The IBM Power RAID Configuration Utility display is shown.
 - c. Select **Analyze log**. Press Enter. The Kernel Messages Log display is shown.

```
Kernel Messages Log

Select one of the following:

1. View most recent ipr error messages
2. View ipr error messages
3. View all kernel error messages
4. View iprconfig error messages
5. Set root kernel message log directory
6. Set default editor
7. Restore defaults
8. View ipr boot time messages

Selection:
e=Exit
```

Figure 54. Kernel Messages Log

- d. Select **View most recent ipr error messages** from the Kernel Messages Log display. Press Enter.
- e. Find the entry in the log for the drive you want to replace.
- f. Record the location information for the drive.

Note: The location information is in either of these forms:

0:0:5:0 In this example, 0 is the SCSI host number, 0 is the SCSI bus, 5 is the SCSI target ID, and 0 is the logical unit number (LUN).

0/00-0E-02

In this example, 0 is the SCSI host number, 00 is the I/O adapter (IOA) SAS port, 0E is the expander port, and 02 is the device port.

- g. Type **iprconfig** on the command line and press Enter. The IBM Power RAID Configuration Utility display is shown.
- h. Select **Display hardware status** from the IBM Power RAID Configuration Utility display. Press Enter. The Display Hardware Status screen displays as shown in Figure 55 on page 49 and Figure 56 on page 49.

```

Display Hardware Status
Type option, press Enter.
1=Display hardware resource information details
OPT Name  PCI/SCSI Location      Description              Status
-----
0000:01:00.0/0:      PCI-E SAS RAID Adapter  Operational
0000:01:00.0/0:0:0:0  Advanced Function SSD   Active
0000:01:00.0/0:0:1:0  Advanced Function SSD   Active
0000:01:00.0/0:0:2:0  Advanced Function SSD   Active
0000:01:00.0/0:0:3:0  Advanced Function SSD   Active
0000:01:00.0/0:0:4:0  Advanced Function SSD   Active
0000:01:00.0/0:0:5:0  Advanced Function SSD   Failed
0000:01:00.0/0:0:6:0  Advanced Function SSD   Active
0000:01:00.0/0:0:8:0  Enclosure                Active
0000:01:00.0/0:0:9:0  Enclosure                Active
0001:01:00.0/1:      PCI-E SAS RAID Adapter  Operational
0001:01:00.0/1:0:3:0  Advanced Function SSD   Remote
0001:01:00.0/1:0:4:0  Advanced Function SSD   Remote
0001:01:00.0/1:0:5:0  Advanced Function SSD   Remote
More...
e=Exit  q=Cancel  r=Refresh  t=Toggle  f=PageDn  b=PageUp

```

Figure 55. Example Display Hardware Status

```

Display Hardware Status
Type option, press Enter.
1=Display hardware resource information details
OPT Name  Resource Path/Address      Vendor      Product ID      Status
-----
sg23     FE                          IBM         57CE001SIS10A  Operational
sg0      00-0E-01                    IBM         SG9XCA2E200GEIBM  Active
sg1      00-0E-0A                    IBM         SG9XCA2E200GEIBM  Active
sg2      00-0E-0B                    IBM         SG9XCA2E200GEIBM  Active
sg3      00-0E-03                    IBM         SG9XCA2E200GEIBM  Active
sg4      00-0E-09                    IBM         SG9XCA2E200GEIBM  Active
sg5      00-0E-02                    IBM         SG9XCA2E200GEIBM  Failed
sg6      00-0E-04                    IBM         SG9XCA2E200GEIBM  Active
sg7      00-0C-26                    IBM         5887             Active
sg8      00-0E-26                    IBM         5887             Active
sg47     FE                          IBM         57CE001SIS10A  Operational
sg26     00-0E-01                    IBM         SG9XCA2E200GEIBM  Remote
sg27     00-0E-0A                    IBM         SG9XCA2E200GEIBM  Remote
sg28     00-0E-0B                    IBM         SG9XCA2E200GEIBM  Remote
More...
e=Exit  q=Cancel  r=Refresh  t=Toggle  f=PageDn  b=PageUp

```

Figure 56. Example Display Hardware Status

- i. If the drive you want to replace is unprotected or in use, move the data from the drive before you continue with this procedure. If the drive is in a RAID 0 (non-redundant RAID array), after you move the data, delete the RAID 0 before proceeding. For SAS RAID controller information, see the SAS RAID controllers for Linux (http://www.ibm.com/support/knowledgecenter/POWER8/p8ebk/p8ebk_kickoff.htm).
- j. Look for the drive at the SCSI location you recorded. The drive might have a Failed status.
- k. Return to the IBM Power RAID Configuration Utility display.
- l. If you are removing a solid-state device that is on a PCIe RAID and SSD SAS adapter, go to Removing and replacing the SAS RAID adapter (<http://www.ibm.com/support/knowledgecenter/POWER8/p8ebj/p7ebjBDRemoveReplace.htm>), and complete that procedure.
- m. From the IBM Power RAID Configuration Utility display, select **Work with disk unit recovery**. Press Enter.
- n. From the Work with Disk Unit Recovery display, select **Concurrent remove device**, and press Enter. A Concurrent Device Remove display is shown, similar to the following examples shown in

Figure 57 and Figure 58.

Concurrent Device Remove			
Choose a single location for remove operations			
1=Select			
OPT Name	PCI/SCSI Location	Description	Status
	U5887.001.Z065075-P1-D1		Empty
sg0	U5887.001.Z065075-P1-D2	Advanced Function SSD	Active
sg5	U5887.001.Z065075-P1-D3	Advanced Function SSD	Failed
sg3	U5887.001.Z065075-P1-D4	Advanced Function SSD	Active
sg6	U5887.001.Z065075-P1-D5	Advanced Function SSD	Active
	U5887.001.Z065075-P1-D6		Empty
	U5887.001.Z065075-P1-D7		Empty
	U5887.001.Z065075-P1-D8		Empty
	U5887.001.Z065075-P1-D9		Empty
sg4	U5887.001.Z065075-P1-D10	Advanced Function SSD	Active
sg1	U5887.001.Z065075-P1-D11	Advanced Function SSD	Active
sg2	U5887.001.Z065075-P1-D12	Advanced Function SSD	Active

Figure 57. Example Concurrent Device Remove display

Concurrent Device Remove				
Choose a single location for remove operations				
1=Select				
OPT Name	SCSI Host/Resource Path	Vendor	Product ID	Status
	0/00-0E-00			Empty
sg0	0/00-0E-01	IBM	SG9XCA2E200GEIBM	Active
sg5	0/00-0E-02	IBM	SG9XCA2E200GEIBM	Failed
sg3	0/00-0E-03	IBM	SG9XCA2E200GEIBM	Active
sg6	0/00-0E-04	IBM	SG9XCA2E200GEIBM	Active
	0/00-0E-05			Empty
	0/00-0E-06			Empty
	0/00-0E-07			Empty
	0/00-0E-08			Empty
sg4	0/00-0E-09	IBM	SG9XCA2E200GEIBM	Active
sg1	0/00-0E-0A	IBM	SG9XCA2E200GEIBM	Active
sg2	0/00-0E-0B	IBM	SG9XCA2E200GEIBM	Active

e=Exit q=Cancel t=Toggle

Figure 58. Example Concurrent Device Remove display

- o. Press T to toggle between the Concurrent Device Remove panels.
 - p. Type 1 (Select) next to the location for this drive (0:0:5:0 or 0/00-0E-02). The Verify Device Concurrent Remove display is shown. The service indicator flashes for that drive slot.
3. Find the package that contains the new drive.

Attention: Drives are fragile. Handle with care.
 4. Attach the electrostatic discharge (ESD) wrist strap.

Attention:

 - Attach an electrostatic discharge (ESD) wrist strap to the front ESD jack, to the rear ESD jack, or to an unpainted metal surface of your hardware to prevent the electrostatic discharge from damaging your hardware.
 - When you use an ESD wrist strap, follow all electrical safety procedures. An ESD wrist strap is used for static control. It does not increase or decrease your risk of receiving electric shock when using or working on electrical equipment.
 - If you do not have an ESD wrist strap, just prior to removing the product from ESD packaging and installing or replacing hardware, touch an unpainted metal surface of the system for a minimum of 5 seconds.
 5. Remove the drive from the static-protective package and place it on an ESD mat.

Removing a disk drive or solid-state drive from the 5147-024 or ESLS storage enclosure with the power turned on in Linux

Find information about removing a disk drive or solid-state drive (SSD) from an enclosure with the Linux operating system or Linux logical partition that controls the drive location powered on.

To remove a disk drive or an SSD from an enclosure, complete the following steps:

1. Ensure that you have the electrostatic discharge (ESD) wrist strap attached. If not, attach it now.
2. When the identify LED turns on solid, slide the terracotta release latch up gently to unlock the drive handle.
3. Grasp the handle and pull the drive partially out of the slot.
4. Grasp the front of the drive and pull it out from the slot, ensuring that you support the bottom of the drive, as shown in Figure 59.

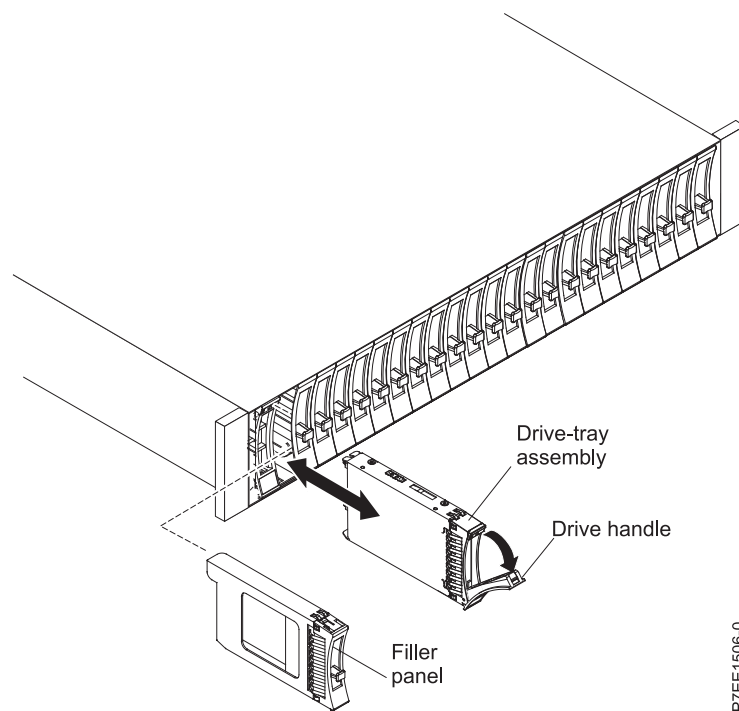

Figure 59. Removing a drive from the 5147-024 or ESLS storage enclosure

5. Support the bottom of the drive as you slide it out of the system. Hold the drive by its sides.
6. If you are removing more than one drive, repeat the steps in this procedure until all drives are removed.
7. If you are not installing a replacement drive, install a filler in the empty slot to ensure proper air flow for cooling.

Replacing a disk drive or SSD in the 5147-024 or ESLS storage enclosure with the power turned on in Linux

Find information about replacing a disk drive or solid-state drive (SSD) in an enclosure with the Linux operating system or Linux logical partition that controls the drive location powered on.

To replace a disk drive or an SSD in an enclosure, complete the following steps:

1. On the console, complete the following steps:
 - a. From the IBM Power RAID Configuration Utility display, select **Work with disk unit recovery**, and then press Enter.

- b. From the Work with Disk Unit Recovery display, select **Concurrent add device**. Press Enter. A Concurrent Device Add display similar to the following example is shown.

Concurrent Device Add			
Choose a single location for add operations			
1=Select			
OPT Name	Platform Location	Description	Status
	U5887.001.Z065075-P1-D1		Empty
	U5887.001.Z065075-P1-D6		Empty
	U5887.001.Z065075-P1-D7		Empty
	U5887.001.Z065075-P1-D8		Empty
	U5887.001.Z065075-P1-D9		Empty
e=Exit q=Cancel t=Toggle			

Figure 60. Example Concurrent Device Add display

- c. Type 1 (Select) next to the location from which you removed the disk drive or solid-state drive. The Verify Device Concurrent Add display is shown. The service indicator flashes for that drive slot.
2. Ensure that you have the electrostatic discharge (ESD) wrist strap attached. If not, attach it now.
 3. With the handle in the unlocked position, as shown in Figure 61, support the bottom of the drive as you align it with the guide rails in the expansion unit.

Note: Support the drive by holding the drive by its sides.

4. Slide the drive halfway into the enclosure.
5. On the console, press Enter on the Complete Device Concurrent Add display to indicate that the drive is installed. The service indicator stops flashing and turns off for that drive slot.
6. When the identify LED flashes, slide the drive into the enclosure until the drive stops.

Important: Ensure that the drive is fully seated and is all the way into the system.

7. Lock the drive by rotating the bay handle (A) in the direction that is shown in Figure 61.

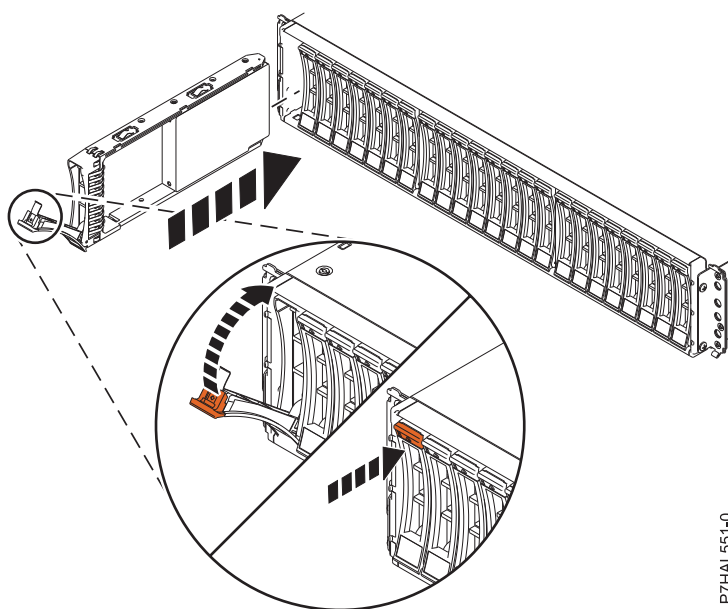

P7HAL551-0

Figure 61. Installing or replacing the disk drive in the 5147-024 or ESLS storage enclosure

8. On the console, press Enter on the Complete Device Concurrent Add display to indicate that the drive is installed. The service indicator stops flashing and turns off for that drive slot.
9. If you are replacing more than one drive, repeat the steps in this procedure until all drives are replaced.

Preparing the 5147-024 or ESLS storage enclosure for operation after removing and replacing a drive with the power turned on in Linux

Learn to prepare an enclosure for operation after you replace a disk drive or solid-state drive (SSD).

To prepare the enclosure for operation, complete the following steps:

1. To verify that the new disk drive or solid-state drive is operational, complete the following steps:
 - a. Log in as root user.
 - b. Type `iprconfig` on the command line of the Linux session and press Enter. The IBM Power RAID Configuration Utility display is shown.
 - c. Select **Display hardware status**. The Display Hardware Status display is shown, similar to the following figure.

```

Display Hardware Status

Type option, press Enter.
  1=Display hardware resource information details

OPT Name  PCI/SCSI Location      Description              Status
-----
          0000:01:00.0/0:      PCI-E SAS RAID Adapter  Operational
          0000:01:00.0/0:0:0:0  Advanced Function SSD   Active
          0000:01:00.0/0:0:0:1:0  Advanced Function SSD   Active
          0000:01:00.0/0:0:0:2:0  Advanced Function SSD   Active
          0000:01:00.0/0:0:0:3:0  Advanced Function SSD   Active
          0000:01:00.0/0:0:0:4:0  Advanced Function SSD   Active
          0000:01:00.0/0:0:0:5:0  Advanced Function SSD   Active
          0000:01:00.0/0:0:0:6:0  Advanced Function SSD   Active
          0000:01:00.0/0:0:0:8:0  Enclosure                Active
          0000:01:00.0/0:0:0:9:0  Enclosure                Active
          0001:01:00.0/1:        PCI-E SAS RAID Adapter  Operational
          0001:01:00.0/1:0:3:0    Advanced Function SSD   Remote
          0001:01:00.0/1:0:4:0    Advanced Function SSD   Remote
          0001:01:00.0/1:0:5:0    Advanced Function SSD   Remote
          More...

e=Exit  q=Cancel  r=Refresh  t=Toggle  f=PageDn  b=PageUp

```

Figure 62. Example Display Hardware Status

- d. Verify that the disk drive or solid-state drive that you installed is shown on this display.
2. If you replaced a drive and have not verified the drive yet, verify that the power LED is **ON** (green) and the amber fault LED is **OFF** (not lit) for the replaced drive on the front of the system.
3. To configure the newly installed disk drive or solid-state drive, see “Configuring a disk drive or solid-state drive for use in an Linux system or Linux logical partition” on page 73.
4. To rebuild data on the newly installed or replaced disk drive or solid-state drive, see “Rebuilding data on a replacement disk drive or solid-state drive in a system or logical partition that is running the Linux operating system” on page 76.

Common procedures for installing, removing, and replacing disk drives or solid-state drives

Find procedures that are common for installing, removing, and replacing disk drives or solid-state drives.

Disk drive or solid-state drive locations and service indicators

Find out where the disk drives or solid-state drives (SSDs) and service indicators are on the system or disk drive enclosure.

Learn about the disk drives or SSD locations and the location of the service indicators on the system or enclosure. If you are using logical partitions, go to Partitioning the server (http://www.ibm.com/support/knowledgecenter/POWER8/p8hat/p8hat_kickoff.htm) for more information.

Disk drive locations and service indicators for the 5148-21L, 5148-22L, 8247-21L, 8247-22L, 8284-21A, or 8284-22A system

Learn about the disk drive locations and understand where the service indicators are located for your system.

Figure 63 and Figure 64 on page 56 show the disk drive and solid-state drive locations and service indicators for the 5148-21L, 5148-22L, 8247-21L, 8247-22L, 8284-21A, or 8284-22A system. Service indicators are located above the latch handle on the disk drives.

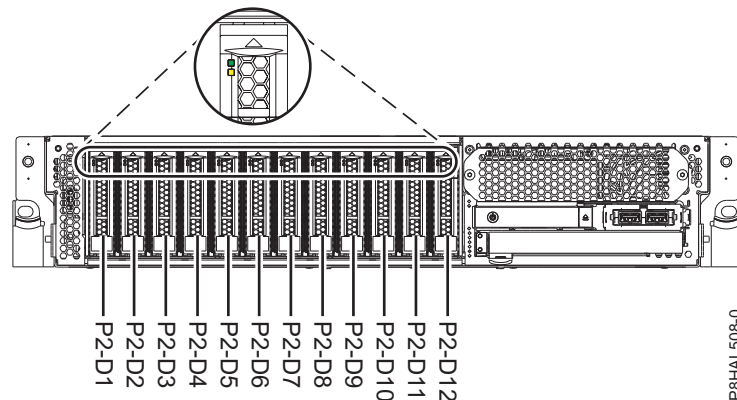

Figure 63. Disk drive and service indicator locations for a base function 5148-21L, 5148-22L, 8247-21L, 8247-22L, 8284-21A, or 8284-22A system

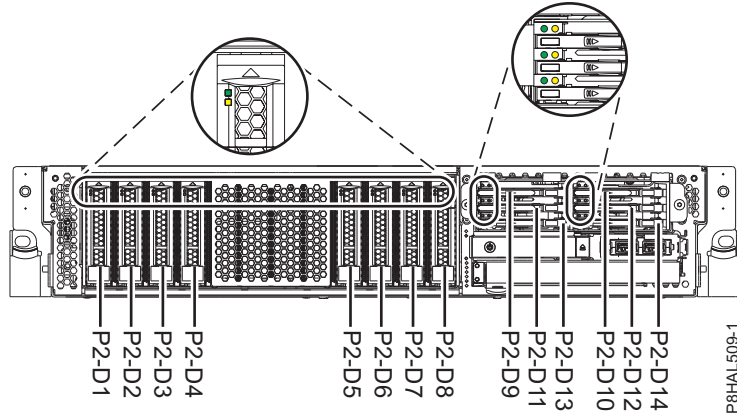

Figure 64. Disk drive, solid-state drive, and service indicator locations for an expanded function 5148-21L, 5148-22L, 8247-21L, 8247-22L, 8284-21A, or 8284-22A system

Disk drive or solid-state drive locations and service indicators for the 8247-42L, 8286-41A, or 8286-42A system

Learn about the disk drive or solid-state drive locations and understand where the service indicators are located for your system.

Figure 65 and Figure 66 on page 57 show the disk drive, solid-state drive, and the service indicator locations for a rack-mounted system.

Figure 67 on page 58 and Figure 68 on page 59 show the disk drive, solid-state drive locations and the service indicator locations for a stand-alone 8286-41A system.

Service indicators are located above the latch handle on the disk drives.

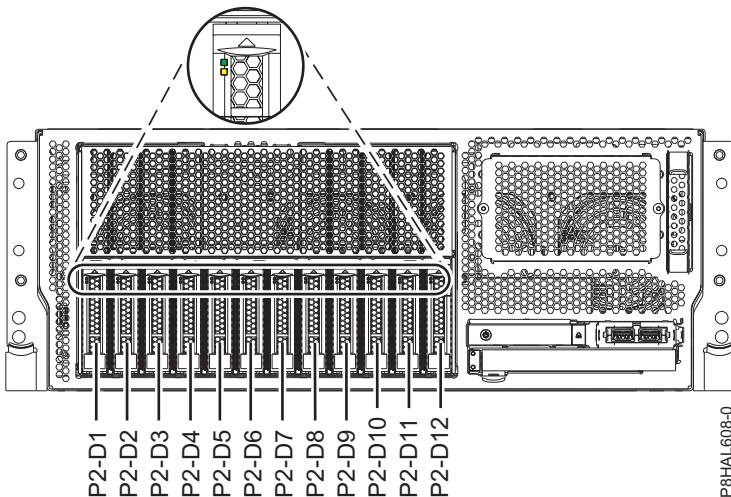

Figure 65. Disk drive or solid-state drive and service indicator locations in a rack-mounted, base function 8247-42L, 8286-41A, or 8286-42A system

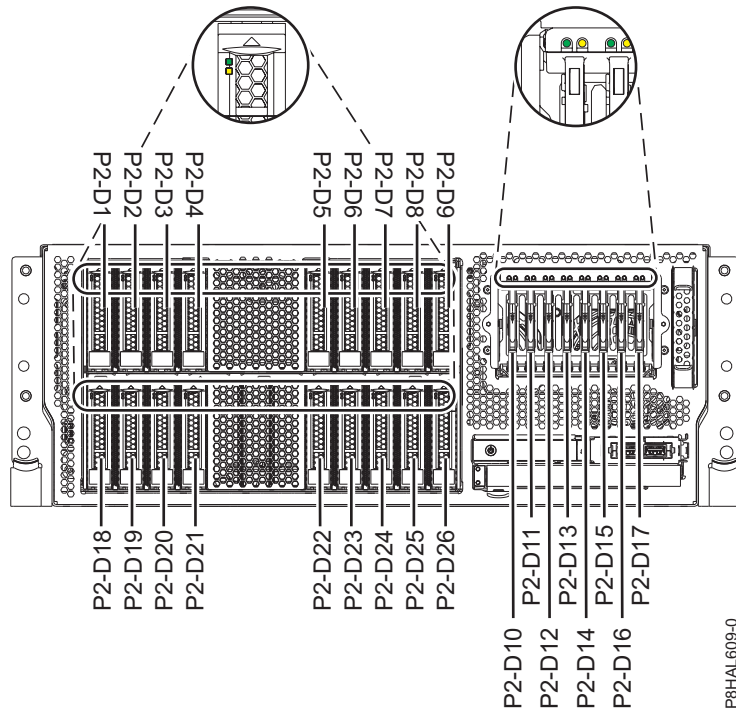

Figure 66. Disk drive, solid-state drive, and service indicator locations in a rack-mounted, expanded function 8286-41A or 8286-42A system

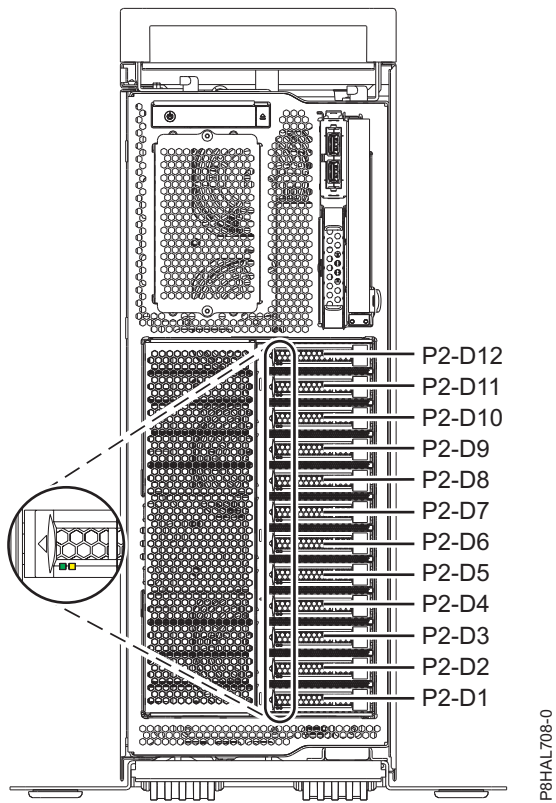

Figure 67. Disk drive or solid-state drive and service indicator locations in a stand-alone, base function 8286-41A system

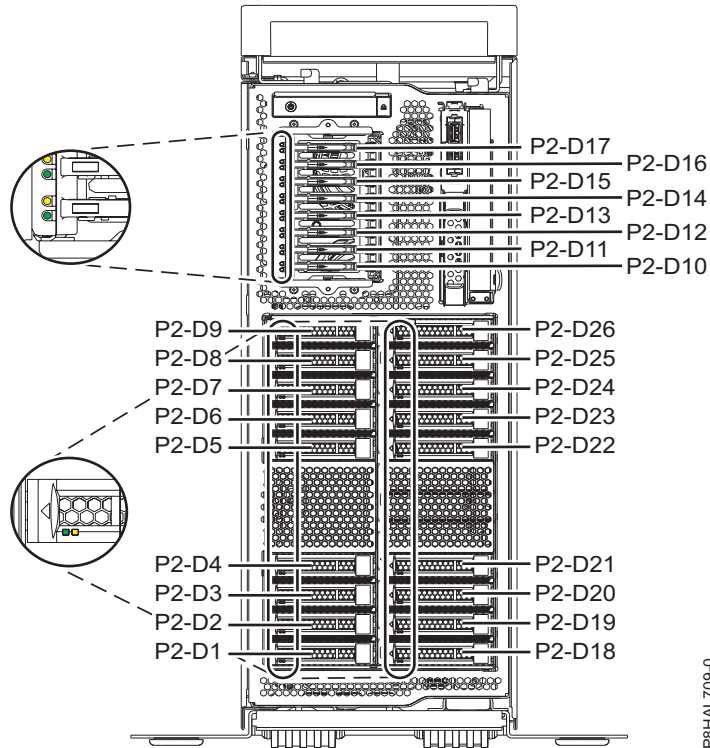

Figure 68. Disk drive, solid-state drive, and service indicator locations in a stand-alone, expanded function 8286-41A system

Disk drive and SSD locations and service indicators for the 8408-44E or 8408-E8E system

Learn about the disk drive and solid-state drive (SSD) locations and understand where the service indicators are located for your system.

Figure 69 on page 60 show the disk drive and solid-state drive locations and service indicators for the 8408-44E or 8408-E8E system. Service indicators are located above the latch handle on the drives.

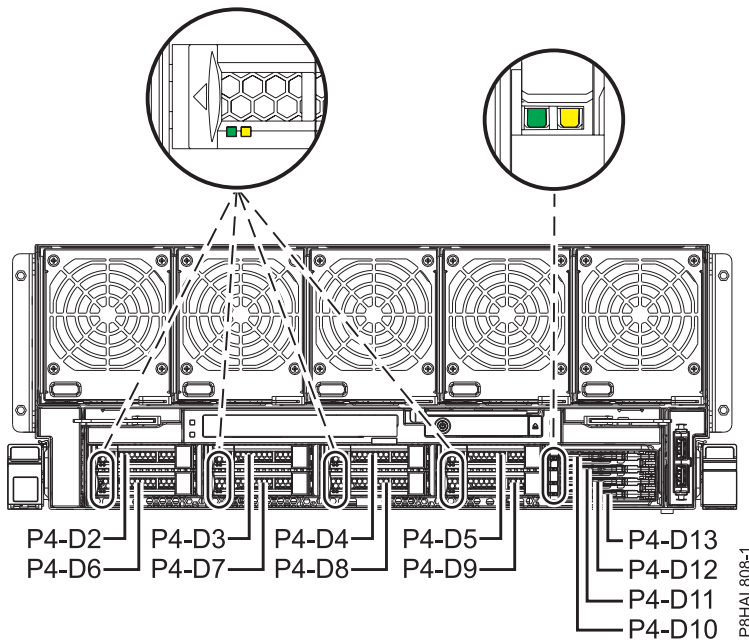

Figure 69. Disk drive and SSD and service indicator locations for an 8408-44E or 8408-E8E system

Solid-state drive configuration rules

Find information about configuration details of the solid-state drives (SSDs) before you install them in the system, enclosure, or an expansion unit.

Solid-state drives (SSDs), also known as flash drives, follow similar rules as regular hard disk drives (HDDs). For example, SSDs physically resemble, install in the same manner, and in most of the same slots as HDDs. However, some restrictions and configuration rules are specific to the SSD.

After you review the configuration rules, you can install the drive as you would any other disk drive.

Attention: Before you install an SSD in your system, ensure that both the SSD and the adapters have all the prerequisite updates. To check for the prerequisites, go to the IBM Prerequisite website (www-912.ibm.com/e_dir/eServerPrereq.nsf).

The following tables help you to determine the operating system, adapter, machine type model, and disk drive configuration rules that apply to your system or disk drive enclosure.

Restriction: Solid-state drives must be part of a RAID array or system mirroring in the system or logical partition that is controlled by IBM i.

Choose the system or enclosure you want to view the configuration rules for:

- Solid-state drive rules for the 5148-21L, 5148-22L, 8247-21L, 8247-22L, 8284-21A, or 8284-22A
- Solid-state drive rules for the 8247-42L, 8286-41A, or 8286-42A
- Solid-state drive rules for the 8408-44E or 8408-E8E
- Solid-state drive rules for the 5887 disk drive enclosure
- ESLS storage enclosure

Note: The ESLL storage enclosure does not use solid-state drives.

Solid-state drive rules for the 5148-21L, 5148-22L, 8247-21L, 8247-22L, 8284-21A, or 8284-22A

Table 1. Solid-state drive rules for the 5148-21L, 5148-22L, 8247-21L, 8247-22L, 8284-21A, or 8284-22A system.

System	Adapter	Mixing rules
8247-21L or 8247-22L	PCIe3 x8 SAS RAID internal adapter 6 Gb (FC EL3V; CCIN 57D7)	<ul style="list-style-type: none"> • FC EL3V can be used to split the disk backplane into two sets of 6 disks. • HDDs can be configured as just a bunch of disks (JBOD) or in RAID 0, 5, 6, and 10. • SSDs must be configured in RAID 0, 5, 6, or 10. • SSDs and HDDs can be mixed within each side of a split disk backplane, but cannot be mixed in the same RAID array.
8284-21A or 8284-22A	PCIe3 x8 SAS RAID internal adapter 6 Gb (FC EJ0V; CCIN 57D7)	<ul style="list-style-type: none"> • FC EJ0V can be used to split the disk backplane into two sets of 6 disks. • HDDs can be configured as JBOD or in RAID 0, 5, 6, and 10. • SSDs must be configured in RAID 0, 5, 6, or 10. • SSDs and HDDs can be mixed within each side of a split disk backplane, but cannot be mixed in the same RAID array.

Solid-state drive rules for the 8247-42L, 8286-41A, or 8286-42A

Table 2. Solid-state drive rules for the 8247-42L, 8286-41A, or 8286-42A system.

System, enclosure, or expansion unit	Adapter	Mixing rules
8247-42L, 8286-41A, or 8286-42A	PCIe3 x8 SAS RAID internal adapter 6 Gb (FC EJ0N; CCIN 57D7)	<ul style="list-style-type: none"> • FC EJ0N can be used to configure up to 12 disks on a single controller. • Disks can be configured as just a bunch of disks (JBOD) or in RAID 0, 5, 6, and 10, depending on the OS support. • SSDs must be configured in RAID 0, 5, 6, or 10. • SSDs and HDDs can be mixed in the disk drive backplane, but cannot be mixed in the same RAID array.

Table 2. Solid-state drive rules for the 8247-42L, 8286-41A, or 8286-42A system (continued).

System, enclosure, or expansion unit	Adapter	Mixing rules
8286-41A or 8286-42A	PCIe3 x8 SAS RAID internal adapter 6 Gb (FC EJ0S; Dual CCIN 57D7)	<ul style="list-style-type: none"> • FC EJ0S can be used to split the disk backplane into two sets of 6 disks that use two controllers. • HDDs can be configured as JBOD or in RAID 0, 5, 6, and 10 depending on the OS support. • SSDs must be configured in RAID 0, 5, 6, or 10. • SSDs and HDDs can be mixed within each side of a split disk backplane, but cannot be mixed in the same RAID array.
	PCIe3 x8 cache SAS RAID internal adapter 6 Gb expanded function (FC EJ0P; Dual CCIN 57D8)	<ul style="list-style-type: none"> • FC EJ0P can be used to configure up to 26 disks in the 8286-42A and up to 18 disks in the 8286-41A, with dual SAS paths that use expanded function controllers and disk drive backplane. • SSDs and HDDs can be configured in RAID 0, 5, 6, 10, 5T2, 6T2, and 10T2 depending on the OS support. (JBOD is not supported.) • SSDs and HDDs can be mixed within the expanded function disk drive backplane. • Feature code EJ0P also allows two external SAS ports and the attachment of an external 5887 disk drive enclosure.

Solid-state drive rules for the 8408-44E or 8408-E8E

Table 3. Solid-state drive rules for the 8408-44E or 8408-E8E system.

System	Controller	Mixing rules
8408-44E or 8408-E8E	PCIe3 x8 cache SAS RAID internal controller 6 Gb (FC EPVN; Dual CCIN 2CCA)	<ul style="list-style-type: none"> • Dual SAS RAID controllers • Dual write cache RAID • 8x SFF 2.5 in. plus 4x 1.8 in. SDD • SSDs and HDDs can be mixed in the SFF 2.5 in. bays, but cannot be mixed in the same RAID array. • SSDs and HDDs can be configured in RAID 0, 10, 5, 6, 5T2, 6T2, 10T2, depending on the OS support. (JBOD is not supported.)
	PCIe3 x8 SAS RAID internal controller 6 Gb (FC EPVP; Dual CCIN 2CD2)	<ul style="list-style-type: none"> • Dual SAS RAID controllers • No write cache RAID • 8x SFF 2.5 in. plus 4x 1.8 in. SDD • SSDs and HDDs can be mixed in the SFF 2.5 in. bays, but cannot be mixed in the same RAID array. • SSDs and HDDs can be configured in RAID 0, 10, 5, 6, 5T2, 6T2, 10T2, depending on the OS support. (JBOD is not supported.)
	PCIe3 x8 SAS RAID internal controller 6 Gb (FC EPVQ); Two single controllers (CCIN 2CCD)	<ul style="list-style-type: none"> • Two single SAS RAID controllers • Each controller owns 4x SFF 2.5 in. plus 2x 1.8 in. SDD • SSDs and HDDs can be mixed within each side of a split disk backplane in the SFF 2.5 in. bays, but cannot be mixed in the same RAID array. • HDDs can be configured as just a bunch of disks (JBOD) or in RAID 0, 10, 5, 6, 10T2, depending on the OS support. • SSDs must be configured in RAID 0, 5, 6, 10, or 10T2.

Solid-state drive rules for the 5887 disk drive enclosure

Table 4. Solid-state drive rules for the 5887 disk drive enclosure.

Disk drive enclosure	Mixing rules
5887 disk drive enclosure (EXP24S SFF Gen2-bay Drawer)	<ul style="list-style-type: none"> • A maximum of 24 drives are supported in this enclosure. • The EXP24S can be configured as one set of 24 bays (mode 1), two sets of 12 bays (mode 2), or four sets of 6 bays (mode 4). • The EXP24S serial-attached SCSI (SAS) ports are attached to SAS controllers, which can be a SAS Peripheral Component Interconnect-X (PCI-X) adapter, PCI Express (PCIe) adapter, PCI Express Gen2 (PCIE2), PCI Express Gen3 (PCIe3) adapter or a pair of adapters. • The EXP24S can also be attached to a pair of internal SAS controllers (FC EJ0U) in a system with an external SAS port. • The mixing of the SSDs and HDDs is as follows: <ul style="list-style-type: none"> – SSDs and HDDs cannot be mixed when configured in mode 1. – SSDs and HDDs can be mixed when configured in mode 2: one disk partition can be SSDs and the other disk partition can be HDDs, but you cannot mix within a disk partition. – SSDs and HDDs can be mixed when configured in mode 4 depending on the adapter support. Each disk partition can be either SSDs or HDDs, but cannot mix within a disk partition.

Solid-state drive rules for the ESLS storage enclosure

Table 5. Solid-state drive rules for the ESLS storage enclosure.

Storage enclosure	Mixing rules
ESLS storage enclosure (IBM EXP24SX SAS Storage Enclosure)	<ul style="list-style-type: none"> • A maximum of 24 drives are supported in this enclosure. • The EXP24SX can be configured as one set of 24 bays (mode 1), two sets of 12 bays (mode 2), or four sets of 6 bays (mode 4). • The EXP24SX serial-attached SCSI (SAS) ports are attached to SAS controllers, which can be a SAS Peripheral Component Interconnect-X (PCI-X) adapter, PCI Express (PCIe) adapter, PCI Express Gen2 (PCIE2), PCI Express Gen3 (PCIe3) adapter or a pair of adapters. • The EXP24S can also be attached to a pair of internal SAS controllers (FC EJ0U) in a system with an external SAS port. • The mixing of the SSDs and HDDs is as follows: <ul style="list-style-type: none"> – SSDs and HDDs cannot be mixed when configured in mode 1. – SSDs and HDDs can be mixed when configured in mode 2: one disk partition can be SSDs and the other disk partition can be HDDs, but you cannot mix within a disk partition. – SSDs and HDDs can be mixed when configured in mode 4 depending on the adapter support. Each disk partition can be either SSDs or HDDs, but cannot mix within a disk partition.

Mainstream solid-state drives

Learn about the differences between enterprise solid-state drives (SSDs) and mainstream SSDs (previously called read intensive SSDs).

Traditionally, enterprise SSDs are built on high-endurance multi-level cell (MLC) flash and can handle up to 10 drive writes per day. These SSDs are referred to as *enterprise SSDs* in this document (previously called eMLC). Now, because of software advances and industry demands, less write intensive SSDs can be used with applications where write operations are less frequent. IBM offers several 4K mainstream SSDs, including feature codes (FCs) ES8Y, ES8Z, ES96, ES97, ESE7, ESE8, ES83, ES84, ES92, ES93, ESE1, and ESE2.

Differences between mainstream and enterprise SSDs

Mainstream SSDs are less expensive to use, but also have lower endurance and random write performance.

Lower endurance for mainstream drives

The NAND flash used in mainstream drives tend to be of lower endurance than the NAND flash used in SSDs that are targeted for the more write intensive workloads. Therefore, the number of write operations to a mainstream drive is limited (typically, one drive write per day (DWPD) versus 10 DWPD on an enterprise drive).

A *drive write per day* writes the entire capacity of the drive in 24 hours. For example, a DWPD for a 387 GB drive writes 387 GB of data on the drive in 24 hours. You can write more data in a day, but the DWPD is the average usage rate by which the life span of the drive is calculated. Since many applications only require about 1 DWPD, these are the most commonly used drives in the industry and thus used for mainstream applications. Only applications that require high endurance or the highest random write performance need enterprise drives.

Lower over-provisioning for mainstream drives

SSDs have more NAND flash capacity than the rated user capacity of the drive. This extra capacity, called *over-provisioning*, is used by the SSD controller during the operation of the drive. When more over-provisioning is available, the controller extends the life of the flash more effectively. NAND flash can be written (programmed) and read in small units that are called *pages*, individually, but to rewrite that page, the page must first be erased and then programmed again.

Due to the architecture of NAND flash, erase operations are completed on the block level and not the page level. Each block contains hundreds to thousands of pages. Therefore, to erase a block, all of the valid data must first be transferred to another block and then you can erase the block. The SSD controller then searches for blocks with large proportions of pages that have data that can be erased. Then, the SSD controller moves and combines the pages of data that must be retained to previously erased blocks, which then frees these new blocks for erasing.

This process of moving data to free up blocks for erasing is called *garbage collection*. Increasing the over-provisioning of an SSD enables the controller to be more efficient in garbage collection and minimizes extra read and program operations.

All of these background operations result in more data that is written to the flash than what is written to the drive. The ratio of data that is written to flash and the data that is written to the drive is referred to as the *write amplification*. All else being equal, write amplification is greater for drives with lower over-provisioning.

Lower cost for mainstream drives

The cost per GB of a mainstream drive is typically less than the cost per GB of an enterprise drive. The cost is low because the amount of over-provisioning is less and almost all the flash memory in the drive is available for storing data.

Lower write operation performance for mainstream drives

Mainstream drives are similar to enterprise drives in terms of read performance. However, because of the lower over-provisioning of the mainstream drives, the random write performance is reduced because of the higher number of background operations that are needed for garbage collection and associated write amplification. Thus, lower over-provisioning decreases both performance and endurance. Read performance is not impacted.

No mixing of mainstream drives with enterprise drives in disk arrays

Endurance differences imply that when you form disk arrays, you must not mix mainstream drives with enterprise drives because the PCIe SAS adapter stripes data across drives, thus sending equal data to each drive. The IBM PCIe SAS adapters do not allow mixing of mainstream drives with enterprise drives when you create RAID arrays.

Monitoring end of life for mainstream drives

You must monitor end of life symptoms for mainstream drives because of their endurance limitations. Internally, when the drive nears the end of life, a predictive failure analysis (PFA) trip is generated and an operating system message is logged. When this trip is generated, the drive continues to run but it must be replaced as soon as possible. The PFA trip code for end of life is the same as the PFA trip code for thermal failures. Therefore, you can determine the root cause of a failure by using operating system support that is provided by a fuel gauge command.

Warranty and maintenance information for mainstream SSDs

A mainstream drive is not suitable for write intensive workloads. Assuming a typical heavily random workload, at about 3394 TB of write operations to a 1.9 TB mainstream drive, the drive is at its maximum

projected write capability. If the write operations exceed the drive's maximum write capacity, the write operation takes more time to complete. A predictive failure analysis (PFA) message indicates that you should replace the drive.

If you ignore the PFA message and if you continue to send the write operation requests to the drive, the drive is unable to accept write commands and only accepts read commands for some time. A failed write operation results in a more serious error message that indicates that the drive must be replaced.

The nature of the workload impacts the maximum write operation capacity. For example, if a high percentage of sequentially oriented write operations is used instead of random oriented write operations, the maximum write operation capacity increases. You must periodically check the percentage of the drive's remaining write life, and if necessary, adjust the workload or reassign the drive. Check the remaining life on each of the mainstream drives individually, even if all of the drives are in the same array.

If a mainstream drive reaches its maximum write operation capability during the warranty period, IBM replaces the drive at no cost. The warranty period of the drive is defined by the server type under which the drive feature code is ordered and it is either 3 years or 1 year for IBM Power Systems™ processor-based servers. After the warranty period, the replacement of the drive is not covered under IBM maintenance if the maximum number of write operations exceed the threshold value. You must order a new, chargeable SSD as a replacement. Other aspects of SSD maintenance are consistent with SSDs that are not mainstream drives.

Using the fuel gauge command

The fuel gauge command is an operating system command that you can use to determine the amount of life in a drive. When a PFA trip is reported by the drive, you can use the fuel gauge command to determine the remaining life on the mainstream drive. Then, you can decide whether the drive reached end of life or if the PFA trip occurred for another reason.

Note: The fuel gauge command does not apply to the IBM Elastic Storage Server Data Server 5147-024 storage enclosure SSD drives currently.

For instructions about using the fuel gauge command, select the option for the operating system you are using:

- Using the AIX fuel gauge command
- Using the IBM i fuel gauge tool
- Using the Linux fuel gauge command

Using the AIX fuel gauge command

Learn how to use the AIX operating system fuel gauge command to find the amount of remaining life in a mainstream solid-state drive (SSD).

To use the fuel gauge tool for the AIX operating system, complete the following steps:

1. If the system has logical partitions, complete this procedure from the logical partition that reported the problem.
2. From the AIX command line, type the following command and press Enter:
`/usr/lpp/diagnostics/bin/pdiskfg -d pdiskX`, where X is the pdisk number of the mainstream SSD.
3. Is the value in the **Life Remaining Gauge** field less than or equal to 2 percent?
 - **Yes:** Continue with the next step.
 - **No:** The mainstream SSD is not reporting a change in status for the number of write operations available.
4. Is the value in the **Life Remaining Gauge** field 0 percent?

- **Yes:** Continue with step 5.
 - **No:** Continue with step 6.
5. The mainstream SSD reached the limit for the number of write operations that are supported. Write operations to the SSD become slower over time, and at some point the SSD becomes a read-only drive. When the operating system writes to the read-only drive, the write operations are rejected, and the operating system considers the drive as if a failure occurred. For example, if the operating system writes to a drive that is in a RAID array and if the write operations are rejected, the array becomes exposed. To support normal write operations, the drive must be replaced.
Replacement of the mainstream SSD might not be covered by the system's level of service entitlement, depending on the terms and conditions of the system. For more information about mainstream SSDs, see “Mainstream solid-state drives” on page 64. **This ends the procedure.**
 6. The mainstream SSD is nearing the limit for the number of write operations that are supported. No service action is required at this time.

Note: After the mainstream SSD reaches the limit for the number of write operations that are supported, write operations to the SSD become slower over time, and at some point the SSD becomes a read-only drive. To support normal write operations, the drive must be replaced. Replacement of the mainstream SSD might not be covered by the system's level of service entitlement, depending on the terms and conditions of the system. For more information about mainstream SSDs, see “Mainstream solid-state drives” on page 64. **This ends the procedure.**

Using the IBM i fuel gauge tool

Learn how to use the IBM i operating system fuel gauge tool to find the amount of remaining life in a mainstream solid-state drive (SSD).

To use the fuel gauge tool for the IBM i operating system, complete the following steps:

1. If the system has logical partitions, complete this procedure from the logical partition that owns the SSD.
2. Sign on to an IBM i session with the QSECOFR user profile.
3. To create a report in a spoolfile, type the following command at the XPF command line and press Enter.
`CALL PGM(QSMGSSTD) PARM('SSDGAUGE' X'00000008' 'SSTD0100' X'00000000')`
4. Display the contents of the spool file. The spool file contains a report for mainstream SSDs. For each of the SSDs in the report, continue with the next step.
5. Is the value in the **Life Remaining Gauge** field less than or equal to 2 percent?
 - **Yes:** Continue with the next step.
 - **No:** The mainstream SSD is not reporting a change in status for the number of write operations available.
6. Is the value in the **Life Remaining Gauge** field 0 percent?
 - **Yes:** Continue with the next step.
 - **No:** Continue with step 8 on page 68.
7. The mainstream SSD reached the limit for the number of write operations that are supported. Write operations to the SSD become slower over time, and at some point the SSD becomes a read-only drive. When the operating system writes to the read-only drive, the write operations are rejected, and the operating system considers the drive as if a failure occurred. For example, if the operating system writes to a drive that is in a RAID array and if the write operations are rejected, the array becomes exposed. To support normal write operations, the drive must be replaced.
Replacement of the mainstream SSD might not be covered by the system's level of service entitlement, depending on the terms and conditions of the system. For more information about mainstream SSDs, see “Mainstream solid-state drives” on page 64. **This ends the procedure.**

8. The mainstream SSD is nearing the limit for the number of write operations that are supported. No service action is required at this time.

Note: After the mainstream SSD reaches the limit for the number of write operations that are supported, write operations to the SSD become slower over time, and at some point the SSD becomes a read-only drive. To support normal write operations, the drive must be replaced. Replacement of the mainstream SSD might not be covered by the system's level of service entitlement, depending on the terms and conditions of the system. For more information about mainstream SSDs, see "Mainstream solid-state drives" on page 64. **This ends the procedure.**

Using the Linux fuel gauge command

Learn how to use the Linux operating system fuel gauge command to find the amount of remaining life in a mainstream solid-state drive (SSD).

To use the fuel gauge tool for the Linux operating system, complete the following steps:

1. If the system has logical partitions, complete this procedure from the logical partition that reported the problem.
2. Choose from the following options:
 - To use the **iprconfig** command, continue with step 3.
 - To use the **ssd-report** command in the **iprutils** command-line interface, continue with step 9.
3. In the command line, enter the following command:
`$ iprconfig`
4. In the main menu, select the **Devices Statistics** option.
5. In the Device selection screen, select **Read Intensive SSD (Mainstream SSD)** by moving the cursor to the correct line and pressing **1**.
6. Press Enter to confirm. The statistics for the selected device is shown.
7. Review the information in the first block of information.
8. Continue with step 10.
9. To use the **ssd-report** command in the **iprutils** command-line interface, complete the following steps:
 - a. Type `$ iprconfig -c ssd-report <dev>`
Where `<dev>` is the device you want to use.
 - b. Review the information that is shown.
 - c. Continue with step 10.
10. Interpret the statistics:
 - **Total Bytes Written:** Number of GB already written to the device
 - **Number of Bytes reported by Warranty:** Number of GBs that can be written according to the specification
 - **Life Remaining Gauge:** An estimate of how much of the device's life has been consumed
 - **PFA Trip:** The device has detected an issue that could lead to a failure
 - **Power-on Days:** Number of days since the last power-on
11. Is the value in the **Life Remaining Gauge** field less than or equal to 2 percent?
 - **Yes:** Continue with the next step.
 - **No:** The mainstream SSD is not reporting a change in status for the number of write operations available.
12. Is the value in the **Life Remaining Gauge** field 0 percent?
 - **Yes:** Continue with step 13 on page 69.
 - **No:** Continue with step 14 on page 69.

13. The mainstream SSD reached the limit for the number of write operations that are supported. Write operations to the SSD become slower over time, and at some point the SSD becomes a read-only drive. When the operating system writes to the read-only drive, the write operations are rejected, and the operating system considers the drive as if a failure occurred. For example, if the operating system writes to a drive that is in a RAID array and if the write operations are rejected, the array becomes exposed. To support normal write operations, the drive must be replaced.

Replacement of the mainstream SSD might not be covered by the system's level of service entitlement, depending on the terms and conditions of the system. For more information about mainstream SSDs, see "Mainstream solid-state drives" on page 64. **This ends the procedure.**

14. The mainstream SSD is nearing the limit for the number of write operations that are supported. No service action is required at this time.

Note: After the mainstream SSD reaches the limit for the number of write operations that are supported, write operations to the SSD become slower over time, and at some point the SSD becomes a read-only drive. To support normal write operations, the drive must be replaced. Replacement of the mainstream SSD might not be covered by the system's level of service entitlement, depending on the terms and conditions of the system. For more information about mainstream SSDs, see "Mainstream solid-state drives" on page 64. **This ends the procedure.**

Preparing the system to remove a disk drive or solid-state drive

Find information about preparing the system to remove a drive by using your operating system.

Preparing the system to remove a disk drive or solid-state drive in AIX

Find information about the actions you must take to properly remove a disk drive or solid-state drive from a system, drive enclosure, or an expansion unit that is controlled by the AIX operating system.

Before you remove a drive from a system that is controlled by the AIX operating system, ensure that all data on that drive or the array that contains the drive is backed up and removed from the drive. If the drive that is being replaced is protected by RAID or mirroring, it is not necessary to remove data. Ensure that the disks are in the defined state if the disks are just a bunch of disks (JBOD).

If the drive is attached to a SAS RAID controller, see SAS RAID controllers for AIX.

More information is available at the IBM AIX IBM Knowledge Center website (http://www.ibm.com/support/knowledgecenter/ssw_aix).

Preparing the system to remove a disk drive or solid-state drive from a system or logical partition controlled by IBM i

Find information about the actions you must take to properly remove a disk drive or solid-state drive from a system, drive enclosure, or an expansion unit that is controlled by the IBM i operating system.

Before removing a drive from a system, drive enclosure, or an expansion unit that is controlled by the IBM i operating system, complete the following steps:

1. Determine the protection status of the drive that you are replacing. For instructions, see "Determining the disk drive or solid-state drive protection status in the IBM i operating system" on page 73.
2. **For mirrored disk drives** on an IBM i system or an IBM i logical partition, follow these steps to verify that the drive you are replacing has been suspended:
 - a. Sign on with service level authority.
 - b. Type `strsst` on the command line of the IBM i session, and then press Enter.
 - c. Type your service tools user ID and service tools password on the Start Service Tools (STRSST) Sign On display, and then press Enter.

Remember: The service tools password is case-sensitive.

- d. Select **Work with disk units** from the System Service Tools (SST) display, and then press Enter.
- e. Select **Display Disk Configuration** from the Work with Disk Units display, and then press Enter.
- f. Select **Display Disk Configuration Status** from the Display Disk Configuration display, and then press Enter.
- g. Does the drive that is mirrored to the drive that you are replacing (same drive number) have a status of Active?
 - **No:** The replacement must be done by a service provider.
 - **Yes:** Does the drive that you are replacing have a status of Suspended?
 - **Yes:** Continue with the next step.
 - **No:** Follow these steps to suspend mirrored protection on the drive that you are replacing:
 - 1) Press F3 from the Display Disk Configuration display to return to the Work with Disk Units display.
 - 2) Select **Work with Disk Unit Recovery** from the Work with Disk Units display, and then press Enter.
 - 3) Select **Suspend mirrored protection** from the Work with Disk Unit Recovery display, and then press Enter.
 - 4) Select the option to suspend the drive that you are replacing from the Suspend Mirrored Protection display, and then press Enter.
- h. Press F3 repeatedly to exit System Service Tools and return to the main menu.

Preparing the system to remove a disk drive or solid-state drive in Linux

Find information about the actions you must take to properly remove a disk drive or solid-state drive from a system, drive enclosure, or an expansion unit that is controlled by the Linux operating system.

Before removing a drive from a system, drive enclosure, or an expansion unit that is controlled by the Linux operating system, ensure that all data on that drive or the array that contains the drive is backed up and removed from the drive.

If the drive is attached to a SAS RAID controller, see SAS RAID controllers for Linux (http://www.ibm.com/support/knowledgecenter/POWER8/p8ebk/p8ebk_kickoff.htm).

Configuring a disk drive or solid-state drive

Find information about configuring a disk drive or solid-state drive by using your operating system.

Configuring a disk drive or solid-state drive for use in an AIX system or AIX logical partition

Configure the newly installed disk drive or solid-state drive (SSD) for your environment.

See the *AIX System Management Guide: Operating System and Devices*.

This guide is available at the IBM AIX Knowledge Center website (http://www-01.ibm.com/support/knowledgecenter/ssw_aix/welcome).

Configuring a disk drive or solid-state drive for use in an IBM i system or IBM i logical partition

Configure the newly installed disk drive or solid-state drive (SSD) for your environment.

If you want to start a new device parity set or change the protection on your disks, go to the IBM i Knowledge Center website (http://www-01.ibm.com/support/knowledgecenter/ssw_ibm_i/welcome) and select the version of the IBM i operating system you are using. Then, select **Systems management > Disk management > Disk protection > Device parity protection**.

Attention: Due to a potential large performance degradation, POWER8® systems do not allow the **Include disk** operation. Alternatively, you can stop parity on the existing set and then start parity with more disks in the set, or you can create a new parity set consisting of three or more drives.

To configure a newly installed disk drive or solid-state drive (SSD) for your environment, complete the following steps:

1. If necessary, start System Service Tools (SST) by typing **strsst** on the command line of the IBM i session, and then press Enter.
2. Type your service tools user ID and service tools password on the Start Service Tools (STRSST) Sign On display, and then press Enter.

Restriction: The service tools password is case-sensitive.

3. Select **Work with Disk Units** on the System Service Tools display, and then press Enter.
4. Select **Display disk configuration** on the Work with Disk Units display, and then press Enter.
5. Select **Display non-configured units** on the Display disk configuration display, and then press Enter.
6. The drives that you installed are listed. The serial numbers must match the serial numbers that you recorded (the last four digits).

Note: The new drives might take up to five minutes to appear in the list. If the drive is not listed, ensure that the drives were installed properly.

7. Press **F12** twice.
8. Select **Work with disk configuration** on the Work with Disk Units display, and then press Enter.
9. Choose from the following options:
 - To continue with device parity, go to step 10.
 - To configure mirroring or no protection, go to step 17 on page 72.
 - To configure for hot spare, go to step 23 on page 72.
10. Select **Work with device parity protection** on the Work with Disk Configuration display, and then press Enter.
11. The following conditions must be met before you can start device parity protection.
 - If there are enough drives available to create a new parity set, the drives are eligible for *Start Device Parity Protection* operation.
 - All drives in a parity set must be the same capacity with a minimum number of two, three, or four drives (depending on RAID level) and maximum of 32 drives in the resulting parity set.
 - Not all drives that are attached to an advanced function input/output adapter have been reported to the system. Repeat the operation.
 - The type or model of the drives cannot be used for the requested operation.When these conditions are met and Device Parity is started, press **F12** to return to the Work with Disk Configuration display.
12. Select **Display disk configuration** on the Work with disk configuration display, and then press Enter.
13. Select **Display disk configuration status** on the Display disk configuration display.
14. If you have more than one auxiliary storage pool (ASP), determine the ASP to which you want to add the drive.
15. Press **F12** twice to get to the Work with Disk Units display.

16. Select **Work with disk configuration** on the Work with Disk Units display, and then press Enter.
17. Select the option to add units to ASPs and balance data on the Work with disk configuration display. Press Enter.
18. Specify the number of the ASP to which you want to add the drive, and then press Enter. The system ASP is **ASP 1**.

Notes:

- a. If ASP is mirror protected, disk drives must be added in pairs of the same size.
- b. When one or more pairs of disk drives are added to a mirrored ASP, they automatically become mirror protected.
- c. To start mirrored protection on an ASP, go to the IBM i Knowledge Center website (http://www-01.ibm.com/support/knowledgecenter/ssw_ibm_i/welcome) and select the version of the IBM i operating system you are using. Then, select **Systems management > Backup and recovery > Recovering your system**.
19. The Confirm Add Units display shows the configuration that your system must have when the add operation completes.

Note: If you selected the wrong ASP, press **F12** to change your options. Press the Enter to continue. The add process takes several minutes to complete.

20. When the message Selected units have been added successfully is shown, press **F3** three times and press Enter to return to the Main menu display.
21. If you have a printer, print the configuration list. A service provider might refer to the configuration list in the future.
 - a. You must sign on **with at least service level authority**
 - b. Type **strsst** on the Main menu command line, and then press Enter.
 - c. Type your service tools user ID and service tools password on the Start Service Tools Sign On display, and then press Enter.

Remember: The service tools password is case-sensitive.

- d. Select **Start a service tool** on the System Service Tools display, and then press Enter.
- e. Select **Hardware service manager** on the Start a Service Tool display, and then press Enter.
- f. Press **F6** (print the configuration) from the Hardware Service Manager display.
- g. To return to the Main Menu display, press **F3** (Exit) twice, and then press Enter.
- h. Place the configuration list where you can refer to it in the future.
22. If you are a service provider and completed this task, return to the procedure that sent you here.
23. Complete the following steps for hot spare:
 - a. Select **Work with hot spare protection** from the **Work with disk configuration** menu.
 - b. Select **Start device parity protection - RAID 5 with hot spare** or **Start device parity protection - RAID 6 with hot spare** depending on the level of parity protection that is wanted.

Configuring a disk drive or solid-state drive on a load source adapter for hot-spare protection by using the IBM i operating system

Learn how to configure a disk drive or solid-state drive on a load source adapter for hot-spare protection by using the IBM i operating system.

To start hot-spare protection on your load source adapter, you must determine the status of the drive in the load source slot and configure or exchange that drive. This action might require you to turn off the power to the system.

To configure a disk drive or solid-state drive on a load source adapter for hot-spare protection, complete the following steps:

1. If necessary, start the System Service Tools (SST) by typing `strsst` on the command line of the IBM i session, and then press Enter.
2. Type your service tools user ID and service tools password on the Start Service Tools (STRSST) Sign On display, and then press Enter.

Note: The service tools password is case-sensitive.

3. Determine the protection status of all disks that are controlled by the load source adapter. Do all drives that are a member of a parity sets or mirror sets have a status of active?
 - **Yes:** Continue to the next step.
 - **No:** Replace the drive. Refer to the removing and replacing instructions for your system with the power turned on in IBM i.
4. Before completing the next step, consider the following information:

Restriction: There must be a drive of the same or larger capacity to act as a hot-spare function for the active load source drive.

5. Determine whether a non-configured drive of the same or larger capacity is in a load source capable slot but is not the active load source. Only parallel SCSI places a restriction on the location of the load source. Any SAS, Fibre Channel, or virtual drive does not have this restriction.
 - **No:** There is no non-configured drive in a load source capable slot. Continue with the next step
 - **Yes:** A non-configured drive is in a load source capable slot. Return to the procedure that sent you here, and continue with the next step of that procedure.
6. Choose the drive to be installed or exchanged with the drive in the load source slot by completing the following steps:
 - a. Select a drive in a parity set in a load source capable slot, but is not the active load source drive, and record the location of this drive.
 - b. Select a non-configured drive of the same or larger capacity from either a non-load source slot or a failed drive you are replacing with a non-configured drive.
7. Stop the system or logical partition. For instructions, see “Stopping a system or logical partition” on page 88.
8. Exchange the drives from the two locations you recorded in step 6 by removing both drives and placing them into the other drives slot.
9. Start the system or logical partition. For instructions, see “Starting the system or logical partition” on page 91.
10. Return to the procedure that sent you here.

Configuring a disk drive or solid-state drive for use in an Linux system or Linux logical partition

Configure the newly installed disk drive or solid-state drive (SSD) for your environment.

If the drive is attached to a PCI-X SCSI RAID controller, see the *PCI-X SCSI RAID Controller Reference Guide for Linux* in the IBM Knowledge Center - Linux information for IBM systems website (http://www-01.ibm.com/support/knowledgecenter/8247-22L/p8ebk/p8ebk_kickoff.htm).

Determining the disk drive or solid-state drive protection status in the IBM i operating system

Find information about determining the protection status of the drives in an IBM i system or IBM i logical partition.

To determine the protection status of the drives in an IBM i operating system, complete the following steps from the System Service Tools display:

Attention: If you do not know the protection status of the drives and you cannot get to the System Service Tools (SST) display, contact your next level of support.

1. Sign on **with at least service level authority**.
2. Type `strsst` on the command line of the IBM i session, and then press Enter.
3. Type your service tools user ID and service tools password on the Start Service Tools (STRSST) Sign On display, and then press Enter.

Note: The service tools password is case-sensitive.

4. Select **Work with disk units** from the System Service Tools (SST) display, and then press Enter.
5. Select **Display Disk Configuration** from the Work with Disk Units display, and then press Enter.
6. Select **Display Disk Configuration Status** from the Display Disk Configuration display, and then press Enter.

A list of each auxiliary storage pool (ASP) displays, showing the drives that are members of the ASP. The **Status** column shows one of the following protection statuses for the ASP:

- **Mirrored.** These ASPs are configured for mirrored protection. If the failing drive has mirrored protection, record the status of both drives in the mirrored pair. You need this information in the recovery procedure.
- **Unprotected.** An ASP with a status of Unprotected might contain drives that are device parity protected. Record the status of the failing drive as it is shown in the **Status** column of the Display Disk Configuration Status display.

A drive with one of the following statuses has device parity protection only if all other drives in the array are operational:

- DPY/Active
- DPY/Failed
- DPY/HDW Failure
- DPY/Degraded
- DPY/Power Loss
- DPY/Not Ready
- DPY/Unknown

A drive with any other status (such as DPY/Rebuild or DPY/Unprotected) does not have device parity protection.

Examples:

- Suppose one drive has a status of DPY/Failed while all other drives have a status of DPY/Unprotected. In this case, only the drive with the DPY/Failed status is protected. Servicing the failed drive does not result in data loss. Removing any of the unprotected drives might result in data loss.
- All drives have a status of DPY/Active or DPY/Degraded, therefore, all drives are protected. In this case, exchanging any drive does not result in data loss.

Tip: For more information about the meaning of a status for any drive, use the **Help** key on the display.

Rebuilding data on a replacement disk drive or solid-state drive

Find information about rebuilding data on a replacement disk drive or solid-state drive by using your operating system.

Rebuilding data on a replacement disk drive or solid-state drive in a system or logical partition running the AIX operating system

To rebuild data on the replacement disk drive or solid-state drive, refer to the information for the controller to which the drive is attached.

To rebuild data on the replacement disk drive or solid-state drive, see Replacing a disk in a SAS RAID adapter.

Rebuilding data on a replacement disk drive or solid-state drive in a system or logical partition running the IBM i operating system

Learn how to rebuild data on replacement disks.

To rebuild data on the replacement drive, complete the following steps:

1. If necessary, start System Service Tools (SST) by typing `strsst` on the command line of the IBM i session and pressing Enter.
2. Type your service tools user ID and service tools password on the Start Service Tools (STRSST) Sign On display. Press Enter.

Note: The service tools password is case sensitive.

3. Select **Work with disk units** from the Start System Service Tools (SST) display. Press Enter.
4. Select **Work with disk unit recovery** from the Work with Disk Units display. Press Enter.
5. If you determined that the drive you replaced had **device parity protection (RAID)**, follow these steps to restore device parity protection (RAID) on the drive:
 - a. Select **Rebuild disk unit data** on the Work with Disk unit recovery display. Press Enter.
 - b. Select 1 to rebuild the drive displayed (the drive displayed is the drive that you **removed**) on the Rebuild Disk Unit Data display. Press Enter.
 - c. Press Enter on the Confirm Rebuild Disk Unit Data display. The rebuild process might take several minutes to complete.
 - d. Press **F5** to refresh the display until the **Percent complete** shows 5%.
 - e. When the display shows at least 5% complete, you can either continue to monitor this display to completion, or press **F3** (Exit) to return to the Work with disk units display.
 - f. Press **F3** (Exit) to return to the System service tools display.
 - g. Press **F3** (Exit) to return to the Exit SST display and press Enter.
 - h. Return to the procedure that sent you here.
6. If the drive that you replaced had **mirrored protection**, follow these steps:
 - a. Select **Replace configured unit** on the Work with Disk unit recovery display. Press Enter.
 - b. Select the configured drive that you are exchanging (suspended drive) on the Select Configured Unit to Replace display. Press Enter.
 - c. Select the drive that you just installed on the Select Replacement Unit display. This drive has a non-configured status.

Note: In some cases, it might take several minutes for a new drive to display. Repeat these steps until the new drive is shown.
Press Enter.

- d. Press Enter on the Confirm Replace of Configured Unit display to confirm your choice for replacement.

The replacement process might take several minutes to complete. When the process is complete, the Work with Disk unit recovery display is shown.

- e. Press **F3** (Exit) to return to the Work with disk units display.

- f. Select **Display disk configuration** on the Work with disk units display.
- g. Select **Display disk configuration status** on the Display Disk Configuration display.
Mirrored status shows Resuming. When complete, the mirrored status shows Active. This process might take several minutes to complete. You can either monitor this display to completion, or press F3 (Exit) three times, and then press Enter to return to the IBM i main menu.

Rebuilding data on a replacement disk drive or solid-state drive in a system or logical partition that is running the Linux operating system

You can rebuild data on the replacement drive that was replaced because of a failed disk drive or solid-state drive or as a new installation.

If a hot-spare drive was available and protected the disk array throughout the drive failure, you can configure the newly installed drive as a hot spare. For SAS RAID controller information, see SAS RAID controllers for Linux (http://www.ibm.com/support/knowledgecenter/POWER8/p8ebk/p8ebk_kickoff.htm).

If a hot-spare rebuild was not initiated by the controller, you need to initiate a rebuild on the newly installed drive. To initiate the rebuild, follow these steps:

For an unprotected disk drive

If the drive you are replacing is in a RAID Level 0 disk array or in a failed RAID Level 5 or RAID Level 10 disk array, complete these tasks:

1. Re-create the disk array.
2. Re-create the file systems on the disk array.
3. Copy the data back to the restored disk array from your backup media.

Rebuilding data by using the `iprconfig` command

If a hot-spare rebuild was not initiated by the controller, you must initiate a rebuild on the newly installed drive. To initiate the rebuild, complete the following procedure by using the `iprconfig` command.

For a disk drive in a RAID Level 5 or RAID Level 10 disk array

1. Log in as root user.
2. Type `iprconfig` on the command line of the Linux session and press Enter. The IBM Power® RAID Configuration Utility display is shown.
3. Select **Work with disk unit recovery** from the IBM Power RAID Configuration Utility display. Press Enter. The Work with Disk Unit Recovery display is shown.
4. From the Work with Disk Unit Recovery display, select **Rebuild disk unit data**.
A Rebuild Disk Unit Data display similar to the following example is shown.

```

Rebuild Disk Unit Data

Select the disks to be rebuilt

Type choice, press Enter.
1=Rebuild

OPT Name  PCI/SCSI Location      Description      Status
-----
1         0000:58:01.0.0/0:4:0      RAID Array Member  Failed

e=Exit  q=Cancel  t=Toggle

```

Figure 70. Example Rebuild Disk Unit Data display

5. Type 1 (Rebuild) next to the disk drive you want to rebuild and press Enter.

Note: Completing a rebuild on a drive overwrites the data currently on the drive. A Confirm Rebuild Disk Unit Data display similar to the following example is shown.

```

Confirm Rebuild Disk Unit Data

Rebuilding the disk unit data might take several minutes for each disk
selected.

Press Enter to confirm having the data rebuilt.
q=Cancel to return and change your choice.

OPT Name  PCI/SCSI Location      Description      Status
-----
1         0000:58:01.0.0/0:4:0      RAID Array Member  Failed

q=Cancel  t=Toggle

```

Figure 71. Example Confirm Rebuild Disk Unit Data display

6. To confirm that you want to rebuild the data on the drive, press Enter.

The message that the rebuild started is shown at the bottom of the Work with Disk Unit Recovery display. The rebuild process might take several minutes to complete.

Before you begin

Observe these precautions when you are installing, removing, or replacing features and parts.

These precautions are intended to create a safe environment to service your system and do not provide steps for servicing your system. The installation, removal, and replacement procedures provide the step-by-step processes required to service your system.

DANGER: When working on or around the system, observe the following precautions:

Electrical voltage and current from power, telephone, and communication cables are hazardous. To avoid a shock hazard:

- If IBM supplied the power cord(s), connect power to this unit only with the IBM provided power cord. Do not use the IBM provided power cord for any other product.
- Do not open or service any power supply assembly.

- Do not connect or disconnect any cables or perform installation, maintenance, or reconfiguration of this product during an electrical storm.
- The product might be equipped with multiple power cords. To remove all hazardous voltages, disconnect all power cords.
 - For AC power, disconnect all power cords from their AC power source.
 - For racks with a DC power distribution panel (PDP), disconnect the customer's DC power source to the PDP.
- When connecting power to the product ensure all power cables are properly connected.
 - For racks with AC power, connect all power cords to a properly wired and grounded electrical outlet. Ensure that the outlet supplies proper voltage and phase rotation according to the system rating plate.
 - For racks with a DC power distribution panel (PDP), connect the customer's DC power source to the PDP. Ensure that the proper polarity is used when attaching the DC power and DC power return wiring.
- Connect any equipment that will be attached to this product to properly wired outlets.
- When possible, use one hand only to connect or disconnect signal cables.
- Never turn on any equipment when there is evidence of fire, water, or structural damage.
- Do not attempt to switch on power to the machine until all possible unsafe conditions are corrected.
- Assume that an electrical safety hazard is present. Perform all continuity, grounding, and power checks specified during the subsystem installation procedures to ensure that the machine meets safety requirements.
- Do not continue with the inspection if any unsafe conditions are present.
- Before you open the device covers, unless instructed otherwise in the installation and configuration procedures: Disconnect the attached AC power cords, turn off the applicable circuit breakers located in the rack power distribution panel (PDP), and disconnect any telecommunications systems, networks, and modems.

DANGER:

- Connect and disconnect cables as described in the following procedures when installing, moving, or opening covers on this product or attached devices.

To Disconnect:

1. Turn off everything (unless instructed otherwise).
2. For AC power, remove the power cords from the outlets.
3. For racks with a DC power distribution panel (PDP), turn off the circuit breakers located in the PDP and remove the power from the Customer's DC power source.
4. Remove the signal cables from the connectors.
5. Remove all cables from the devices.

To Connect:

1. Turn off everything (unless instructed otherwise).
2. Attach all cables to the devices.
3. Attach the signal cables to the connectors.
4. For AC power, attach the power cords to the outlets.
5. For racks with a DC power distribution panel (PDP), restore the power from the Customer's DC power source and turn on the circuit breakers located in the PDP.
6. Turn on the devices.

Sharp edges, corners and joints may be present in and around the system. Use care when handling equipment to avoid cuts, scrapes and pinching. (D005)

(R001 part 1 of 2):

DANGER: Observe the following precautions when working on or around your IT rack system:

- Heavy equipment—personal injury or equipment damage might result if mishandled.
- Always lower the leveling pads on the rack cabinet.
- Always install stabilizer brackets on the rack cabinet.

- To avoid hazardous conditions due to uneven mechanical loading, always install the heaviest devices in the bottom of the rack cabinet. Always install servers and optional devices starting from the bottom of the rack cabinet.
- Rack-mounted devices are not to be used as shelves or work spaces. Do not place objects on top of rack-mounted devices. In addition, do not lean on rack mounted devices and do not use them to stabilize your body position (for example, when working from a ladder).



- Each rack cabinet might have more than one power cord.
 - For AC powered racks, be sure to disconnect all power cords in the rack cabinet when directed to disconnect power during servicing.
 - For racks with a DC power distribution panel (PDP), turn off the circuit breaker that controls the power to the system unit(s), or disconnect the customer's DC power source, when directed to disconnect power during servicing.
- Connect all devices installed in a rack cabinet to power devices installed in the same rack cabinet. Do not plug a power cord from a device installed in one rack cabinet into a power device installed in a different rack cabinet.
- An electrical outlet that is not correctly wired could place hazardous voltage on the metal parts of the system or the devices that attach to the system. It is the responsibility of the customer to ensure that the outlet is correctly wired and grounded to prevent an electrical shock.

(R001 part 2 of 2):

CAUTION:

- Do not install a unit in a rack where the internal rack ambient temperatures will exceed the manufacturer's recommended ambient temperature for all your rack-mounted devices.
- Do not install a unit in a rack where the air flow is compromised. Ensure that air flow is not blocked or reduced on any side, front, or back of a unit used for air flow through the unit.
- Consideration should be given to the connection of the equipment to the supply circuit so that overloading of the circuits does not compromise the supply wiring or overcurrent protection. To provide the correct power connection to a rack, refer to the rating labels located on the equipment in the rack to determine the total power requirement of the supply circuit.
- *(For sliding drawers.)* Do not pull out or install any drawer or feature if the rack stabilizer brackets are not attached to the rack. Do not pull out more than one drawer at a time. The rack might become unstable if you pull out more than one drawer at a time.



- *(For fixed drawers.)* This drawer is a fixed drawer and must not be moved for servicing unless specified by the manufacturer. Attempting to move the drawer partially or completely out of the rack might cause the rack to become unstable or cause the drawer to fall out of the rack.

Before you begin a replacement or installation procedure, perform these tasks:

1. If you are installing a new feature, ensure that you have the software required to support the new feature. See IBM Prerequisite.
2. If you are performing an installation or replacement procedure that might put your data at risk, ensure, wherever possible, that you have a current backup of your system or logical partition (including operating systems, licensed programs, and data).
3. Review the installation or replacement procedure for the feature or part.
4. Note the significance of color on your system.
Blue or terra-cotta on a part of the hardware indicates a touch point where you can grip the hardware to remove it from or install it in the system, open or close a latch, and so on. Terra-cotta might also indicate that the part can be removed and replaced with the system or logical partition power on.
5. Ensure that you have access to a medium flat-blade screwdriver, a Phillips screwdriver, and a pair of scissors.
6. If parts are incorrect, missing, or visibly damaged, do the following:
 - If you are replacing a part, contact the provider of your parts or next level of support.
 - If you are installing a feature, contact one of the following service organizations:
 - The provider of your parts or next level of support.
 - In the United States, the IBM Rochester Manufacturing Automated Information Line (R-MAIL) at 1-800-300-8751.

In countries and regions outside of the United States, use the following website to locate your service and support telephone numbers:
<http://www.ibm.com/planetwide>
7. If you encounter difficulties during the installation, contact your service provider, your IBM reseller, or your next level of support.
8. If you are installing new hardware in a logical partition, you need to understand and plan for the implications of partitioning your system. For information, see Logical Partitioning.

Identifying a part

Learn how to identify the system or enclosure that contains a failing part, the location code and light-emitting diode (LED) status for a part, and how to activate and deactivate the identify part LED.

Note: If you are using PowerKVM, you must use the ASMI procedures to identify a part or enclosure.

Table 6. Tasks to identify a part

What you want to do	See the following information
Determine which server or enclosure contains the part	"Identifying the enclosure or server that contains the part" on page 81
Find the location of the part and determine whether the part has an identifying LED	"Finding the part location code and LED support status" on page 83
Turn on an identifying LED for a part	
If you are using PowerKVM:	"Identifying a part by using the ASMI" on page 87
If your system is in the runtime state:	"Identifying a part by using the operating system or VIOS" on page 83
If your system is in the standby power state:	"Identifying a part by using the ASMI" on page 87
If you have an HMC:	"Identifying a part by using the HMC" on page 88
Turn off an identify LED	"Deactivating an identify LED" on page 102
Turn off a check log indicator	"Deactivating a check log indicator (system information indicator) by using the ASMI" on page 105

Identifying the enclosure or server that contains the part

Learn how to determine which server or enclosure has the part you want to replace.

Enabling enclosure or server indicators with the ASMI

Find out how to enable enclosure or server indicators by using the Advanced System Management Interface (ASMI).

To perform this operation, you must have one of the following authority levels:

- Administrator
- Authorized service provider

To enable the enclosure or server indicator states, complete the following steps:

1. On the ASMI Welcome pane, specify your user ID and password, and click **Log In**.
2. In the navigation area, expand **System Configuration > Service Indicators > Enclosure Indicators**. A list of enclosures is displayed.
3. Select the enclosure and click **Continue**. A list of location codes is displayed. Alternatively, you can click **Indicators by Location Code** and type the location code in the **Location code** field.
4. In the **Identify indicator status** field, select **Identify**.
5. To save the changes made to the state of an indicator, click **Save settings**.

Control panel LEDs

Use this information as a guide to the control panel LEDs and buttons.

Use Figure 72 with the control panel LED descriptions to understand the system status that is indicated by the control panel.

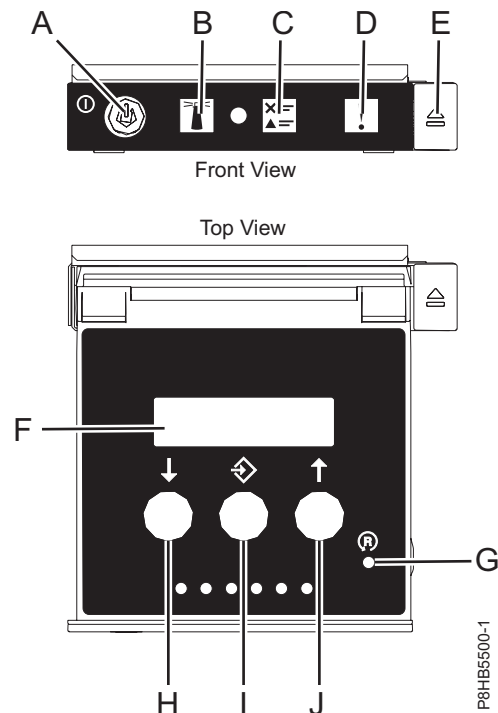

Figure 72. Control panel LEDs

Control panel LEDs and descriptions:

- **A:** Power-on button
 - A constant light indicates full system power to the unit.
 - A flashing light indicates standby power to the unit.
 - There is approximately a 30-second transition period from the time the power-on button is pressed to when the power LED goes from flashing to solid. During the transition period, the LED might flash faster.
- **B:** Enclosure identify light
 - A constant light indicates the identify state, which is used to identify a part.
 - No light indicates that the system is operating normally.
- **C:** Check log light
 - No light indicates that the system is operating normally.
 - Light on indicates that the system requires attention.
- **D:** Enclosure fault light
 - A constant light indicates a fault in the system unit.
 - No light indicates that the system is operating normally.
- **E:** Eject button
- **F:** Function/Data display
- **G:** Pinhole reset button
- **H:** Decrement button
- **I:** Enter button
- **J:** Increment button

Activating an identify LED for an enclosure or server by using the HMC

Learn how to activate an identify LED for an enclosure or server by using the Hardware Management Console (HMC).

The system provides several LEDs that help identify various components in the system, such as enclosures or field-replaceable units (FRUs). For this reason, they are called *identify LEDs*.

If you want to add a part to a specific enclosure or server, you need to know the machine type, model, and serial number (MTMS) of the enclosure or server. To determine whether you have the correct MTMS for the enclosure or server that needs the new part, you can activate the LED for an enclosure or server and verify that the MTMS corresponds to the enclosure or server that requires the new part.

1. Choose one of the following navigation options depending on the interface type of the HMC:
 - If you are using an HMC Classic or HMC Enhanced interface, complete the following steps:
 - a. In the navigation area, click **Systems Management > Servers**.
 - b. In the content pane, select the server.
 - c. Click **Tasks > Operations > LED Status > Identify LED**. The Identify LED, Select Enclosure window is displayed.
 - If you are using an HMC Enhanced + Tech Preview (Pre-GA) or HMC Enhanced+ interface, complete the following steps:



- a. In the navigation area, click the **Resources** icon , and then click **All Systems**.
- b. Click the server name for which you want to activate the identify LED.
- c. Click **System Actions > Attention LED > Identify Attention LED**. The Identify Attention LED, Select Enclosure window is displayed.

2. To activate an identify LED for an enclosure or server, select an enclosure or server and then click **Activate LED**. The associated LED is turned on.

Finding the part location code and LED support status

You can use location codes for the server you are working with to find the part location code and whether there is Identify LED support.

To find the location code and to determine if there is identify LED support, complete the following steps:

1. Select the server you are working on to see the location codes:
 - 5148-21L, 5148-22L, 8247-21L, 8247-22L, 8284-21A, or 8284-22A locations (http://www.ibm.com/support/knowledgecenter/POWER8/p8ecs/p8ecs_83x_8rx_loccodes.htm)
 - 8247-42L, 8286-41A, or 8286-42A locations (http://www.ibm.com/support/knowledgecenter/POWER8/p8ecs/p8ecs_82x_84x_loccodes.htm)
 - 8408-44E or 8408-E8E locations(http://www.ibm.com/support/knowledgecenter/POWER8/p8ecs/p8ecs_85x_loccodes.htm)
 - 9080-MHE, 9080-MME, 9119-MHE, or 9119-MME locations(http://www.ibm.com/support/knowledgecenter/POWER8/p8ecs/p8ecs_87x_88x_loccodes.htm)
2. Record the location code.
3. Refer to the field replaceable unit (FRU) location table, Identify LED column to see if the word **Yes** (there is an identify LED) or **No** (there is not an identify LED) appears.
4. Select from the following options:
 - If the part has an identify LED, refer to the applicable procedure:
 - If you are using IBM PowerKVM, see “Identifying a part by using the ASMI” on page 87.
 - If your system is at runtime state, see “Identifying a part by using the operating system or VIOS.”
 - If your system is at standby power state, see “Identifying a part by using the ASMI” on page 87.
 - If the part does not have an identify LED, see Identifying the enclosure or server that contains the part.

Identifying a part by using the operating system or VIOS

Learn how to use AIX, IBM i, Linux, or the Virtual I/O Server (VIOS) to identify a part.

For IBM Power Systems that contain the POWER8 processor, the identify LEDs can be used to identify or verify the location of a part that you intend to install, remove, or replace. The identify function (flashing the amber LED) corresponds to the location code you are going to work with.

When you are removing a part, first verify whether you are working on the correct part by using the identify function in the management console or other user interface. When you remove a part by using the Hardware Management Console (HMC), the identify function is activated and deactivated automatically at the correct times.

The identify function causes the amber LED to flash. When you turn off the identify function, the LED returns to the state it was previously. For parts that have a blue service button, the identify function sets LED information for the service button so that when the button is pressed, the correct LEDs on that part flash.

Note: Use the enclosure locate LED to identify the enclosure that is being serviced. Then, confirm and verify the location of the FRU (to be serviced) in the enclosure by checking the active identify indicator (flashing LED) for the selected FRU. For some FRUs, you might need to remove the service access cover to be able to see the identify indicators.

Identifying a part in an AIX system or logical partition

Use these instructions to learn how to locate a part, activate the indicator light for the part, and deactivate the indicator light for the part on a system or logical partition running the AIX operating system.

Finding the location code for a part in an AIX system or logical partition:

You might need to use AIX tools, before activating the indicator light, to locate a part.

To configure the AIX system to locate a part, complete the following steps:

1. Log in as root user or celogin-.
2. At the command line, type `diag` and press Enter.
3. From the Function Selection menu, select **Task Selection** and press Enter.
4. Select **Display Previous Diagnostic Results** and press Enter.
5. From the Display Previous Diagnostic Results display, select **Display Diagnostic Log Summary**. The Display Diagnostic Log display shows a chronological list of events.
6. Look in the **T** column for the most recent **S** entry. Select this row in the table and press Enter.
7. Select **Commit**. The details of this log entry are shown.
8. Record the location information and the SRN value that is shown near the end of the entry.
9. Exit to the command line.

Use the location information for the part to activate the indicator light that identifies the part. See “Activating the indicator light for a part by using AIX diagnostics.”

Activating the indicator light for a part by using AIX diagnostics:

Use these instructions to help physically identify the location of a part you are servicing.

To activate the indicator light for a part, complete the following steps:

1. Log in as root user.
2. At the command line, type `diag` and press Enter.
3. From the **Function Selection** menu, select **Task Selection** and press Enter.
4. From the **Task Selection** menu, select **Identify and Attention Indicators** and press Enter.
5. From the list of lights, select the location code for the part and press Enter.
6. Select **Commit**. This turns on the system attention and indicator light for the part.

Important: A flashing amber LED indicates the location of the part and a solid amber LED indicates that the part is failing.

7. Exit to the command line.

Identifying a part in an IBM i system or logical partition

You can activate or deactivate the indicator light to locate a part in an IBM i system or logical partition.

Finding the location code and activating the indicator light for a part by using the IBM i operating system:

You can search the service action log for an entry that matches the time, reference code, or resource of a problem, and then activate the indicator light for a part.

1. Sign on to an IBM i session, **with at least service level authority**.
2. On the command line of the session, type `strsst` and press Enter.

Note: If you cannot get to the System Service Tools (SST) display, use function 21 from the control panel. Alternatively, if the system is managed by a Hardware Management Console (HMC), use the Service Focal Point utilities to get to the Dedicated Service Tools (DST) display.

3. Type your service tools user ID and service tools password on the System Service Tools (SST) Sign On display and press Enter.

Remember: The service tools password is case sensitive.

4. Select **Start a service tool** from the System Service Tools (SST) display and press Enter.
5. Select **Hardware service manager** from the Start a Service Tool display and press Enter.
6. Select **Work with service action log** from the Hardware Service Manager display and press Enter.
7. On the Select Timeframe display, change the **From: Date and Time** field to a date and time prior to when the problem occurred.
8. Search for an entry that matches one or more conditions of the problem:
 - System reference code
 - Resource
 - Date and time
 - Failing item list
9. Select option 2 (Display failing item information) to display the service action log entry.
10. Select option 2 (Display details) to display location information for the failing part to be replaced. The information displayed in the date and time fields is the date and time for the first occurrence of the specific system reference code for the resource displayed during the time range selected.
11. If location information is available, select option 6 (Indicator on) to turn on the indicator light for the part.

Tip: If the part does not contain a physical indicator light, a higher-level indicator light is activated. For example, the indicator light for the backplane or unit that contains the part might be lit. In this case, use the location information to locate the actual part.

12. Look for the enclosure indicator light to locate the enclosure that contains the part.

Important: A flashing amber LED indicates the location of the part and a solid amber LED indicates that the part is failing.

Identifying a part in a Linux system or logical partition

If the service aids have been installed on a system or logical partition, you can activate or deactivate the indicator lights to locate a part or complete a service action.

Finding the location code of a part in a Linux system or logical partition:

Use this procedure to retrieve the location code of the part to perform service operations.

To find the location code of a part in a Linux system or logical partition, complete the following steps:

1. Log in as root user.
2. At the command line, type `grep diagela /var/log/platform` and press Enter.
3. Look for the most recent entry that contains a system reference code (SRC).
4. Record the location information.

Related information:

 Service and productivity tools for PowerLinux servers from IBM

IBM provides hardware diagnostic aids and productivity tools, and installation aids for Linux operating systems on IBM Power Systems servers.

Activating the indicator light for a part by using the Linux operating system:

If you know the location code of a part, activate the indicator light to help locate the part the while performing service operations.

To activate the indicator light, complete the following steps:

1. Log in as root user.
2. At the command line, type `/usr/sbin/usysident -s identify -l location_code` and press Enter.
3. Look for the system attention light to identify the enclosure that contains the part.

Important: A flashing amber LED indicates the location of the part and a solid amber LED indicates that the part is failing.

Related information:

 Service and productivity tools for Linux on Power servers

IBM provides hardware diagnostic aids and productivity tools, and installation aids for Linux operating systems on IBM Power Systems servers.

Identifying a part in a VIOS system or logical partition

Learn how to find the location code and identify a part by using the Virtual I/O Server (VIOS) tools.

Finding the location code of a part in a VIOS system or logical partition:

You can use Virtual I/O Server (VIOS) tools to find the location code of a part before you activate the indicator light.

To configure the Virtual I/O Server system for identifying a part, complete the following steps:

1. Log in as root user or `celogin-`.
2. At the command line, type `diagmenu` and press Enter.
3. From the **Function Selection** menu, select **Task Selection** and press Enter.
4. Select **Display Previous Diagnostic Results** and press Enter.
5. From the **Display Previous Diagnostic Results** display, select **Display Diagnostic Log Summary**. A **Display Diagnostic Log** display appears. This display contains a chronological list of events.
6. Look in the **T** column for the most recent **S** entry. Select this row in the table and press Enter.
7. Choose **Commit**. The details of this log entry are shown.
8. Record the location information and the SRN value shown near the end of the entry.
9. Exit to the command line.

Use the location information for the part to activate the indicator light that identifies the part. For instructions, see “Activating the indicator light for a part by using the VIOS tools.”

Activating the indicator light for a part by using the VIOS tools:

You can use Virtual I/O Server (VIOS) tools to activate the indicator light to physically locate a part.

To turn on the indicator light for identifying a part, complete the following steps:

1. Log in as root user.
2. At the command line, type `diagmenu` and press Enter.
3. From the **Function Selection** menu, select **Task Selection** and press Enter.
4. From the **Task Selection** menu, select **Identify and Attention Indicators** and press Enter.
5. From the list of lights, select the location code for the failing part and press Enter.
6. Select **Commit**. This turns on the system attention and indicator light for the part.

Important: A flashing amber LED indicates the location of the part and a solid amber LED indicates that the part is failing.

7. Exit to the command line.

Identifying a part by using the ASMI

Learn how to activate or deactivate amber identify indicator light-emitting diodes (LEDs) by using the Advanced System Management Interface (ASMI).

You can access the ASMI by using a web browser. For more information, see *Accessing the Advanced System Management Interface by using a web browser* (http://www.ibm.com/support/knowledgecenter/POWER8/p8ect/pxect_browser.htm).

For IBM Power Systems that contain the POWER8 processor, the identify LEDs can be used to identify or verify the location of a part that you intend to install, remove, or replace. The identify function (flashing the amber LED) corresponds to the location code you are going to work with.

You can set the identify LED to flash and to stop flashing by using the ASMI.

Note: You can use the ASMI to turn on and turn off the identify indicators except for the adapters, disk drives, solid-state drives, and media devices.

Activating the identify LED by using the ASMI when you know the location code

Learn how to activate the identify LED by using the Advanced System Management Interface (ASMI) when you know the location code.

You can specify the location code of any indicator to view or modify its current state. If you provide the wrong location code, the ASMI attempts to go to the next higher level of the location code.

The next level is the base-level location code for that field replaceable unit (FRU). For example, a user types the location code for the FRU located on the second memory module slot of the third enclosure in the system. If the location code for the second memory module slot is incorrect (the FRU does not exist at this location), an attempt to set the indicator for the third enclosure is initiated. This process continues until a FRU is located or no other level is available.

To complete this operation, your authority level must be one of the following levels:

- Administrator
- Authorized service provider

To change the current state of an indicator, complete the following steps:

1. On the ASMI Welcome pane, specify your user ID and password, and click **Log In**.
2. In the navigation area, expand **System Configuration > Service Indicators > Indicators by Location code**.
3. In the **Location code** field, type the location code of the FRU and click **Continue**.
4. From the **Identify indicator status** list, select **Identify**.
5. Click **Save settings**.

Activating the identify LED by using the ASMI when you do not know the location code

Learn how to activate the identify LED by using the Advanced System Management Interface (ASMI) when you do not know the location code.

You can turn on the identify indicators in each enclosure.

To complete this operation, your authority level must be one of the following levels:

- Administrator
- Authorized service provider

To enable the enclosure indicator states, complete the following steps:

1. On the ASMI Welcome pane, specify your user ID and password, and click **Log In**.
2. In the navigation area, expand **System Configuration > Service Indicators > Enclosure Indicators**. All servers and enclosures managed by the ASMI will display.
3. Select the server or enclosure with the part that needs to be replaced and click **Continue**. The location code identifiers are listed.
4. Select the location code identifier and select **Identify**.
5. To save the changes made to the state of one or more FRU indicators, click **Save settings**.

Identifying a part by using the HMC

You can use the following procedures to activate light-emitting diodes (LEDs) by using the Hardware Management Console (HMC).

You can use the identify LED for a FRU associated with a specified enclosure to help you identify a part. For example, if you want to hook up a cable to a specific I/O adapter, you can activate the LED for the adapter, which is a field replaceable unit (FRU). Then, you can physically check to see where you should hook up the cable. This action is especially useful when you have several adapters with open ports.

1. Choose one of the following navigation options depending on the interface type of the HMC:
 - If you are using an HMC Classic or HMC Enhanced interface, complete the following steps:
 - a. In the navigation area, click **Systems Management > Servers**.
 - b. Select the server that you are working on.
 - c. In the **Tasks** menu, click **Operations > LED status > Identify LED**. The Identify LED, Select Enclosure window is displayed.
 - If you are using an HMC Enhanced + Tech Preview (Pre-GA) or HMC Enhanced+ interface, complete the following steps.



- a. In the navigation area, click the **Resources** icon  , and then click **All Systems**.
 - b. Click the system name for which you want to activate the attention LED.
 - c. In the navigation area, click **System Actions > Attention LED > Identify Attention LED**. The Identify LED, Select Enclosure window is displayed.
2. To activate an identify LED for the enclosure, select an enclosure and then click **Activate LED**. The associated LED is turned on and is flashing.
 3. To activate an identify LED for one or more FRUs in the enclosure, complete the following steps:
 - a. Select an enclosure and then click **List FRUs**.
 - b. Select the FRUs for which you want to activate the identify LED and click **Activate LED**. The associated LED is turned on and is flashing.

Stopping a system or logical partition

Learn how to stop a system or logical partition as a part of a system upgrade or service action.

Attention: Using either the power-on button on the control panel or entering commands at the Hardware Management Console (HMC) to stop the system can cause unpredictable results in the data files. Also, the next time you start the system, it might take longer if all applications are not ended before stopping the system.

To stop the system or logical partition, select the appropriate procedure.

Stopping a system that is not managed by an HMC

You might need to stop the system to complete another task. If your system is not managed by the Hardware Management Console (HMC), use these instructions to stop the system by using the power button or the Advanced System Management Interface (ASMI).

Before you stop the system, follow these steps:

1. Ensure that all jobs are completed and end all applications.
2. If a Virtual I/O Server (VIOS) logical partition is running, ensure that all clients are shut down or that the clients have access to their devices by using an alternative method.

Stopping a system by using the control panel

You might need to stop the system to complete another task. If your system is not managed by the Hardware Management Console (HMC), use these instructions to stop the system by using the power button.

The following procedure describes how to stop a system that is not managed by the HMC.

1. Log in to the host partition as a user with the authority to run the **shutdown** or **pwrdownsys** (Power Down System) command.
2. At the command line, enter one of the following commands:
 - If your system is running the AIX operating system, type **shutdown**.
 - If your system is running the Linux operating system, type **shutdown -h now**.
 - If your system is running the IBM i operating system, type **PWRDOWNSYS**. If your system is partitioned, use the **PWRDOWNSYS** command to power down each of the secondary partitions. Then, use the **PWRDOWNSYS** command to power down the primary partition.

The command stops the operating system. The system power turns off, the power-on light begins to slowly flash, and the system goes into a standby state.
3. Record the IPL type and the IPL mode from the control panel display to help you return the system to this state when the installation or replacement procedure is completed.
4. Set the power switches of any devices that are connected to the system to off.

Stopping a system by using the ASMI

You might need to stop the system to complete another task. If your system is not managed by the Hardware Management Console (HMC), use these instructions to stop the system by using the Advanced System Management Interface (ASMI).

To stop a system by using the ASMI, complete the following steps:

1. On the ASMI Welcome pane, specify your user ID and password, and click **Log In**.
2. In the navigation area, click **Power/Restart Control > Power On/Off System**. The power state of the system is displayed.
3. Specify the settings as required and click **Save setting and power off**.

Stopping a system by using the HMC

You can use the Hardware Management Console (HMC) to stop the system or logical partition.

By default, the managed system is set to power off automatically when you shut down the last running logical partition on the managed system. If you set the managed system properties on the HMC so that the managed system does not power off automatically, you must use this procedure to power off your managed system.

Attention: Ensure that you shut down the running logical partitions on the managed system before you power off the managed system. Powering off the managed system without shutting down the logical partitions first causes the logical partitions to shut down abnormally and can cause data loss. If you use a Virtual I/O Server (VIOS) logical partition, ensure that all clients are shut down or that the clients have access to their devices by using an alternative method.

To power off a managed system, you must be a member of one of the following roles:

- Super administrator
- Service representative
- Operator
- Product engineer

Note: If you are a product engineer, verify that the customer has shut down all active partitions and has powered off the managed system. Continue with the procedure only after the status of the server changes to **Power Off**.

Stopping a system by using the HMC Classic or HMC Enhanced interface

Learn how to stop a system by using the HMC Classic or HMC Enhanced interface.

To stop the system or logical partition by using the HMC Classic or HMC Enhanced interface, complete the following steps:

1. In the navigation area, click **Systems Management > Servers**.
2. In the content pane, select the managed system.
3. In the Tasks area, click **Operations > Power Off**.
4. Select the appropriate power-off mode and click **OK**.

Related information:

 Shutting down and restarting logical partitions

Stopping a system by using the HMC Enhanced + Tech Preview (Pre-GA) or HMC Enhanced+ interface

Learn how to stop a system by using the HMC Enhanced + Tech Preview (Pre-GA) or HMC Enhanced+ interface.

To stop the system or logical partition by using the HMC Enhanced + Tech Preview (Pre-GA) or HMC Enhanced+ interface, complete the following steps:

1. You must deactivate all the active logical partitions before powering off the system. To deactivate logical partitions for a specific system, complete the following steps:

- a. In the navigation area, click the **Resources** icon  , and then click **All Systems**.
- b. Click the system name for which you want to deactivate partitions.
- c. Select the logical partitions that you want to deactivate.
- d. In the content pane, click **Actions > Deactivate**.
- e. Click **OK**.

2. To power off the system, complete the following steps:

- a. In the navigation area, click the **Resources** icon  , and then click **All Systems**.
- b. Select the system that you want to power off.

- c. In the content pane, click **Actions > View All Actions > Power Off**.
- d. Click **OK**.

Stopping an IBM PowerKVM system

You can use the Intelligent Platform Management Interface (IPMI) to stop an IBM PowerKVM system.

To stop an IBM PowerKVM system, complete the following steps:

1. Log in to the host as a root user or with sudo authority.
2. To power off each of the guests, complete the following steps.
 - a. To obtain a list of all guests, type **virsh list**.
 - b. For each guest in the list, type **virsh shutdown domain name** or type **virsh shutdown domain ID**.

Note:

Type **virsh list** to verify whether all the guests are powered off. If any guest is not powered off, type **virsh destroy domain name** or type **virsh destroy domain ID** to power off the guest.

3. Run the **ipmitool -I lanplus -H FSP IP -P ipmipassword chassis power off** command from a remote system.

Starting the system or logical partition

Learn how to start a system or logical partition after performing a service action or system upgrade.

Starting a system that is not managed by an HMC

You can use the power button or the Advanced System Management Interface (ASMI) to start a system that is not managed by a Hardware Management Console (HMC).

Starting a system by using the control panel

You can use the power button on the control panel to start a system that is not managed by a Hardware Management Console (HMC).

To start a system by using the control panel, complete the following steps:

1. Open the front rack door, if necessary.
2. Before you press the power button on the control panel, ensure that power is connected to the system unit as follows:
 - All system power cables are connected to a power source.
 - The power LED, as shown in the following figure, is slowly flashing.
 - The top of the display, as shown in the following figure, shows 01 V=F.
3. Press the power button (**A**), as shown in the following figure, on the control panel.

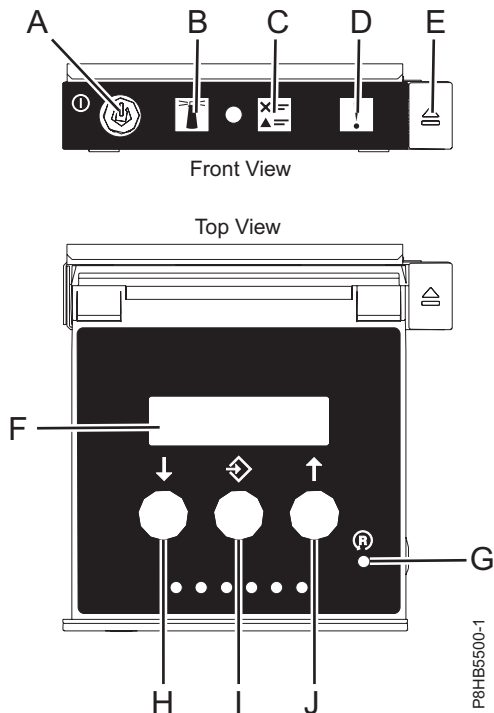

Figure 73. Control panel

- **A:** Power-on button
 - A constant light indicates full system power to the unit.
 - A flashing light indicates standby power to the unit.
 - There is approximately a 30-second transition period from the time the power-on button is pressed to when the power LED goes from flashing to solid. During the transition period, the LED might flash faster.
 - **B:** Enclosure identify light
 - A constant light indicates the identify state, which is used to identify a part.
 - No light indicates that the system is operating normally.
 - **C:** System information light
 - No light indicates that the system is operating normally.
 - Light on indicates that the system requires attention.
 - **D:** Enclosure fault roll-up light
 - A constant light indicates a fault in the enclosure.
 - No light indicates that the system is operating normally.
 - **E:** Eject button
 - **F:** Function/Data display
 - **G:** Pinhole reset button
 - **H:** Decrement button
 - **I:** Enter button
 - **J:** Increment button
4. Observe the following aspects after pressing the power button:
- The power-on light begins to flash faster.
 - The system cooling fans are activated after approximately 30 seconds and begin to accelerate to operating speed.

- Progress indicators, also referred to as checkpoints, appear on the control panel display while the system is being started. The power-on light on the control panel stops flashing and remains on, indicating that the system power is on.

Tip: If pressing the power button does not start the system, then contact your next level of support or your service provider.

Starting a system by using the ASMI

You can use the Advanced System Management Interface (ASMI) to start a system that is not managed by a Hardware Management Console (HMC).

To start a system by using the ASMI, complete the following steps:

1. On the ASMI Welcome pane, specify your user ID and password, and click **Log In**.
2. In the navigation area, click **Power/Restart Control > Power On/Off System**. The power state of the system is displayed.
3. Specify the settings as required and click **Save setting and power on**.

Starting a system or logical partition by using the HMC

You can use the Hardware Management Console (HMC) to start the system or logical partition after the required cables are installed and the power cables are connected to a power source.

Starting a system or logical partition by using the HMC Classic or HMC Enhanced interface

Learn how to start a system or logical partition by using the HMC Classic or HMC Enhanced interface.

To start the system by using the HMC Classic or HMC Enhanced interface, complete the following steps:

1. Verify that the logical partition start policy is set to **User-Initiated** by completing the following steps:
 - a. In the navigation area, expand **Systems Management > Servers**.
 - b. In the content pane, select the managed system.
 - c. In the Tasks area, click **Properties**.
 - d. Click the **Power-On Parameters** tab. Ensure that the **Partition start policy** field is set to **User-Initiated**.
2. Power on the managed system by completing the following steps:
 - a. In the navigation area, expand **Systems Management > Servers**.
 - b. In the content pane, select the managed system.
 - c. Click **Operations > Power on**.
 - d. Select the power-on option and click **OK**.

Starting a system or logical partition by using the HMC Enhanced + Tech Preview (Pre-GA) or HMC Enhanced+ interface

Learn how to start a system or logical partition by using the HMC Enhanced + Tech Preview (Pre-GA) or HMC Enhanced+ interface.

To start a system or logical partition by using the HMC Enhanced + Tech Preview (Pre-GA) or HMC Enhanced+ interface, complete the following steps:

1. To power on the managed system, complete the following steps:



- a. In the navigation area, click the **Resources** icon  , and then click **All Systems**.
- b. Select the system that you want to power on.
- c. In the content pane, click **Actions > View All Actions > Power On**.

- d. Click **OK**.
2. To activate a logical partition, complete the following steps:



- a. In the navigation area, click the **Resources** icon , and then click **All Partitions**.
 - b. Click the logical partition name that you want to activate.
 - c. In the navigation area, click **Partition Actions > Operations > Activate**.
 - d. Click **OK**.
3. To activate a logical partition for a specific system, complete the following steps:



- a. In the navigation area, click the **Resources** icon , and then click **All Systems**.
 - b. Click the system name in which you want to activate the logical partition.
 - c. Select logical partitions that you want to activate.
 - d. In the content pane, click **Actions > Activate**.
 - e. Click **OK**.
4. To verify that the logical partition start policy is set to **User-Initiated**, complete the following steps:



- a. In the navigation area, click the **Resources** icon , and then click **All Systems**.
- b. Click the system name to view details.
- c. In the navigation area, click **Properties > Other Properties**.
- d. Click the **Power-On Parameters** tab. Ensure that the **Partition start policy** field is set to **User-Initiated**.

Starting an IBM PowerKVM system

You can use the Intelligent Platform Management Interface (IPMI) to start an IBM PowerKVM system.

To start an IBM PowerKVM system, run the `ipmitool -I lanplus -H FSP IP -P ipmipassword chassis power on` command from a remote system.

Installing or replacing a part with an HMC

You can use the Hardware Management Console (HMC) to perform many service actions, including the installation of a new field-replaceable unit (FRU) or parts.

Installing a part by using the HMC

You can use the Hardware Management Console (HMC) to perform many service actions, including the installation of a new feature or part.

To install a feature or part into a system or an expansion unit by using the HMC, complete the following steps:

1. Choose one of the following navigation options depending on the interface type of the Hardware Management Console (HMC):
 - If you are using an HMC Classic or HMC Enhanced interface, complete the following steps:
 - a. In the navigation area, expand **Systems Management > Servers**.
 - b. Select the managed system for which you want to install a part.

Note: If your part is in a miscellaneous equipment specification (MES), continue with step 1c. If your part is contained in the install that is done by the system services representative (SSR) or in a ship group, go to step 1h.

- c. In the Tasks area, expand **Serviceability > Hardware > MES Tasks > Open MES**.
 - d. Click **Add MES Order Number**.
 - e. Enter the number, and click **OK**.
 - f. Click the newly created order number, and click **Next**. The details of the order number are displayed.
 - g. Click **Cancel** to close the window.
 - h. In the Tasks area, expand **Serviceability > Hardware > MES Tasks**.
- If you are using an HMC Enhanced + Tech Preview (Pre-GA) or HMC Enhanced+ interface, complete the following steps:



- a. In the navigation area, click the **Resources** icon  , and then click **All Systems**.
 - b. Click the system name for which you want to install the part.
 - c. In the navigation area, click **Serviceability**.
2. In the Serviceability window, click **Add FRU** (field replaceable unit).
 3. In the Add/Install/Remove Hardware-Add FRU, Select FRU Type window, select the system or enclosure into which you are installing the feature.
 4. Select the type of feature you are installing, and click **Next**.
 5. Select the location code where you will install the feature, and click **Add**.
 6. After the part is listed in the **Pending Actions** section, click **Launch Procedure** and follow the instructions to install the feature.

Note: The HMC might open external instructions for installing the feature. If so, follow those instructions to install the feature.

Removing a part by using the HMC

Learn how to remove a part by using the Hardware Management Console (HMC).

To remove a part in a system or an expansion unit by using the HMC, complete the following steps:

1. Choose one of the following navigation options depending on the interface type of the HMC:
 - If you are using an HMC Classic or HMC Enhanced interface, complete the following steps:
 - a. In the navigation area, expand **Systems Management > Servers**.
 - b. Select the managed system from which you are removing a part.
 - c. In the Tasks area, expand **Serviceability > Hardware > MES Tasks > Remove FRU**.
 - If you are using an HMC Enhanced + Tech Preview (Pre-GA) or HMC Enhanced+ interface, complete the following steps:



- a. In the navigation area, click the **Resources** icon  , and then click **All Systems**.
 - b. Click the system name for which you want to remove a part.
 - c. In the navigation area, click **Serviceability**.
 - d. In the Serviceability window, click **Remove FRU**.
2. In the Add/Install/Remove Hardware - Remove FRU, Select FRU Type window, select the system or enclosure from which you are removing the part.

3. Select the type of part that you are removing, and click **Next**.
4. Select the location of the part that you are removing, and click **Add**.
5. After the part is listed in the **Pending Actions** section, click **Launch Procedure** and follow the instructions to remove the part.

Note: The HMC might display the IBM Knowledge Center instructions for removing the part. If so, follow those instructions to remove the part.

Repairing a part by using the HMC

You can use the Hardware Management Console (HMC) to complete many service actions, including repairing a field-replaceable unit (FRU) or part.

1. Choose one of the following navigation options depending on the interface type of the Hardware Management Console (HMC):
 - If you are using an HMC Classic or HMC Enhanced interface, complete the following steps:
 - a. In the navigation area, expand **Systems Management > Servers**.
 - b. Select the managed system for which you want to repair a part.
 - c. In the Tasks area, expand **Serviceability > Manage Serviceable Events**.
 - If you are using an HMC Enhanced + Tech Preview (Pre-GA) or HMC Enhanced+ interface, complete the following step:



- a. In the navigation area, click the **Resources** icon  , and then click **All Systems**.
- b. Click the system name for which you want to remove a part.
- c. In the navigation area, click **Serviceability**.
- d. In the Serviceability window, click **Serviceable Events Manager**.

Note: You can also access **Serviceable Events Manager** option from the **Actions** list after selecting the system.

2. In the Manage Serviceable Events window, specify the event criteria, error criteria, and FRU criteria. If you do not want the results to be filtered, select **ALL**.
3. Click **OK**. The Manage Serviceable Events - Serviceable Event Overview window displays all of the events that match your criteria. The information that is displayed in the compact table view includes the following details:
 - Problem number
 - PMH number
 - Reference code - click the Reference code to display a description of the problem reported and actions that can be taken to fix the problem.
 - Status of the problem
 - Last reported time of the problem
 - Failing MTMS of the problem

Note: The full table view includes more detailed information, including reporting MTMS, first reported time, and serviceable event text.

4. Select a serviceable event and use the **Selected** drop-down menu to select **Repair**.
5. Follow the instructions to repair the part.

Note: The HMC might open IBM Knowledge Center instructions for repairing the part. If so, follow those instructions to repair the part.

Power cords

Use these procedures to disconnect and connect the power cords on IBM Power Systems servers that contain the POWER8 processor.

Disconnecting the power cords from the system

Use this procedure to disconnect the power cords from the system.

To disconnect the power cords from the system, complete the following steps:

1. Open the rear rack door on the system unit that you are servicing.
2. Identify the system unit that you are servicing in the rack.
3. Disconnect the power cords (**B**) from the system unit. See Figure 77 on page 98, Figure 78 on page 99, or Figure 79 on page 99 or depending on the type of your system.

Notes:

- This system might be equipped with two or more power supplies. If the removing and replacing procedures require the power to be off, then ensure that all the power sources to the system have been completely disconnected.
- The power cord is fastened to the system using the hook-and-loop fastener (**A**). If you are placing the system in a service position after disconnecting the power cords, then ensure that you unstrap the fastener.

Figure 74 shows the supported alternate current (AC) and high voltage direct current (HVDC) connectors. Figure 75 and Figure 76 on page 98 show the supported connectors and power distribution unit (PDU) for 8408-44E.

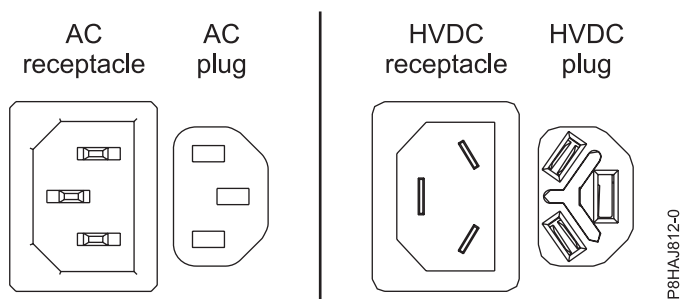

Figure 74. AC and HVDC connectors

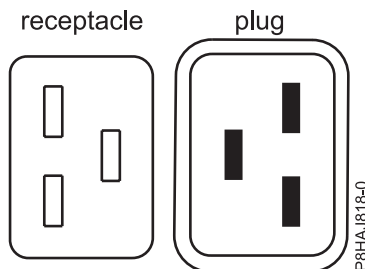

Figure 75. Connectors for the 8408-44E system

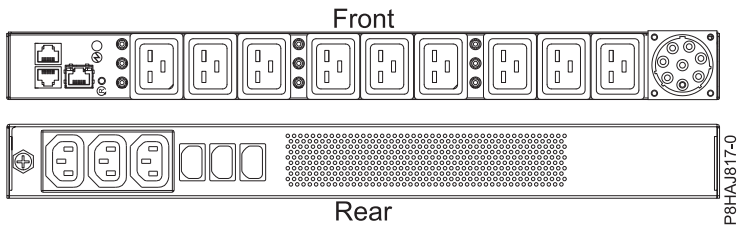

Figure 76. PDU for the 8408-44E system

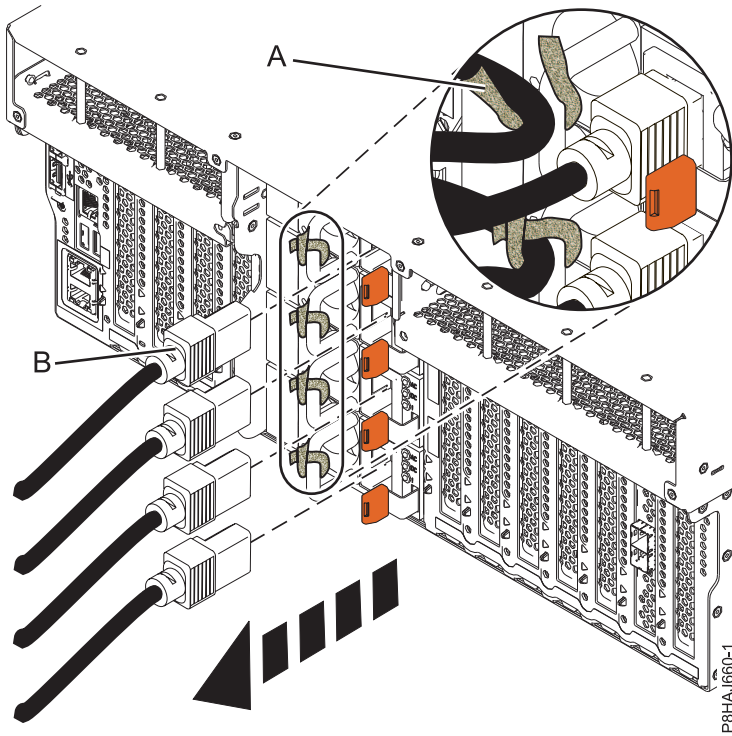

Figure 77. Removing the power cords from an 8247-42L, 8286-41A, or 8286-42A system

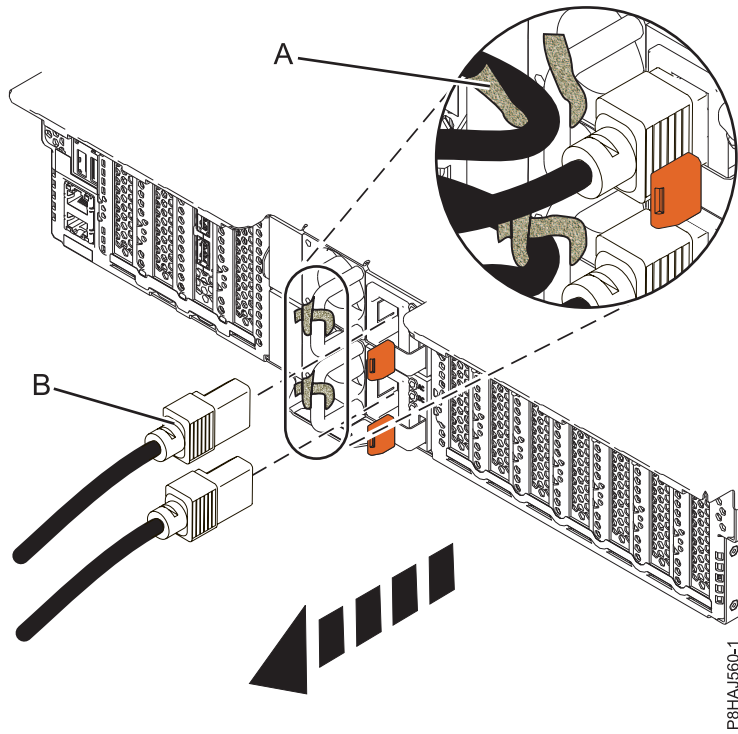

Figure 78. Removing the power cords from an 5148-21L, 5148-22L, 8247-21L, 8247-22L, 8284-21A, or 8284-22A system

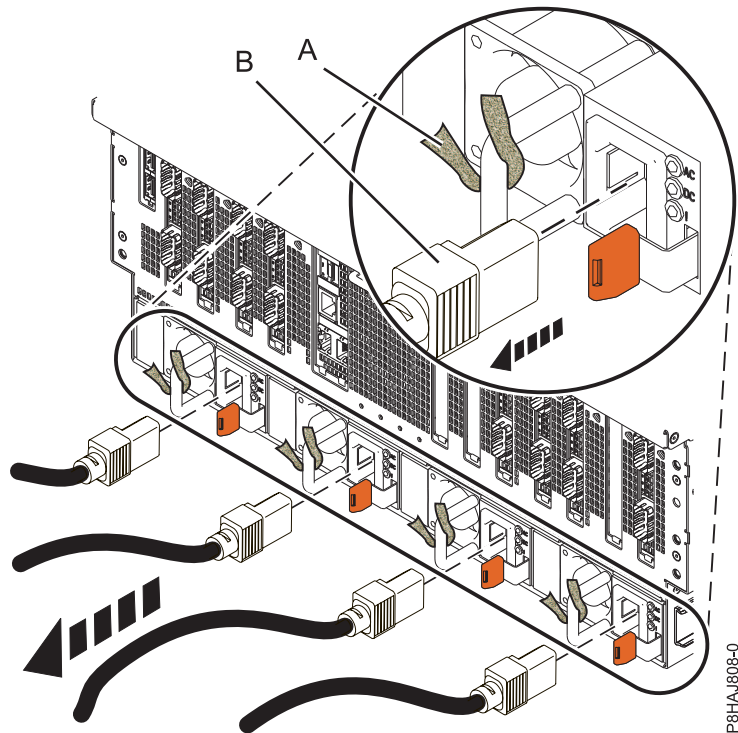

Figure 79. Removing the power cords from an 8408-44E or 8408-E8E system

Connecting the power cords to the system

Use this procedure to connect the power cords to the system.

To connect the power cords to the system, complete the following steps:

1. Open the rear rack door on the system unit that you are servicing.
2. Reconnect the power cords **(A)** to the system unit. See Figure 83 on page 101, Figure 84 on page 101, or Figure 85 on page 102 depending on the type of your system. Figure 80 shows the supported alternate current (AC) and high voltage direct current (HVDC) connectors. Figure 81 and Figure 82 show the supported connectors and power distribution unit (PDU) for 8408-44E.

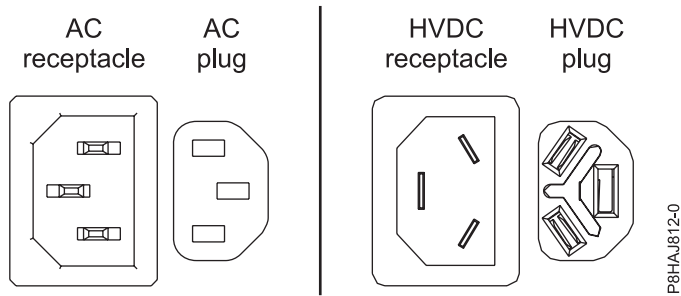

Figure 80. AC and HVDC connectors

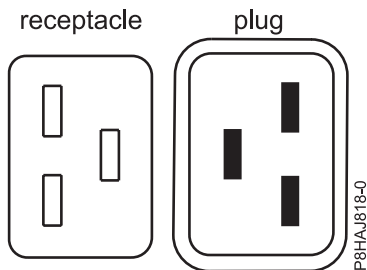

Figure 81. Connectors for the 8408-44E system

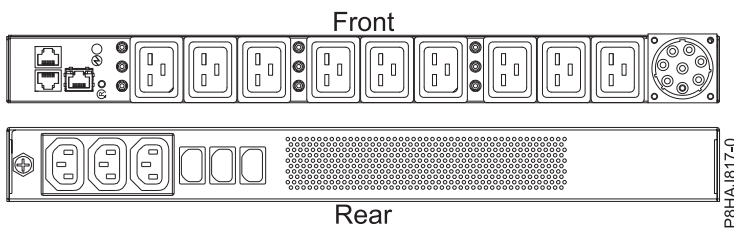

Figure 82. PDU for the 8408-44E system

3. Fasten the power cords to the system using the hook-and-loop fasteners **(B)**.

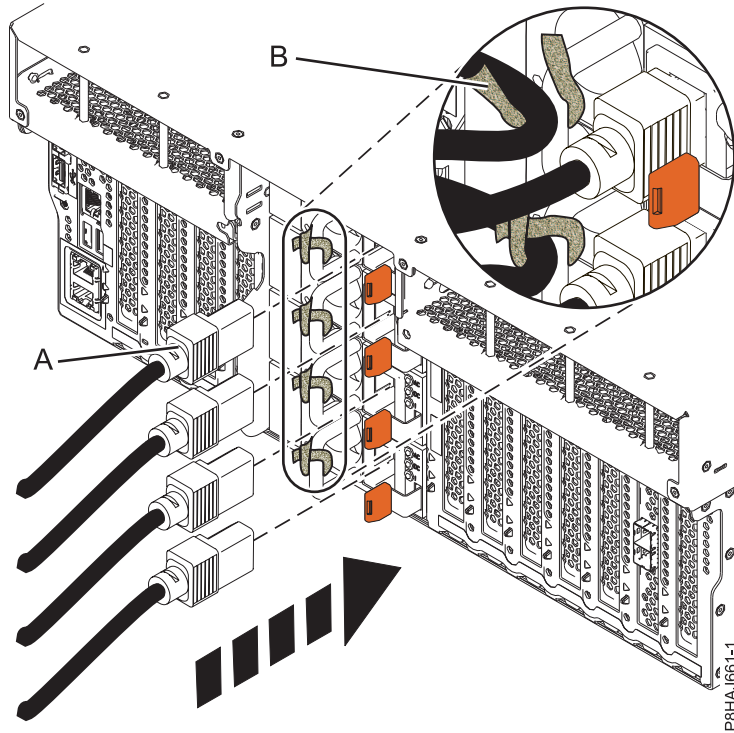

Figure 83. Connecting the power cords to an 8247-42L, 8286-41A, or 8286-42A system

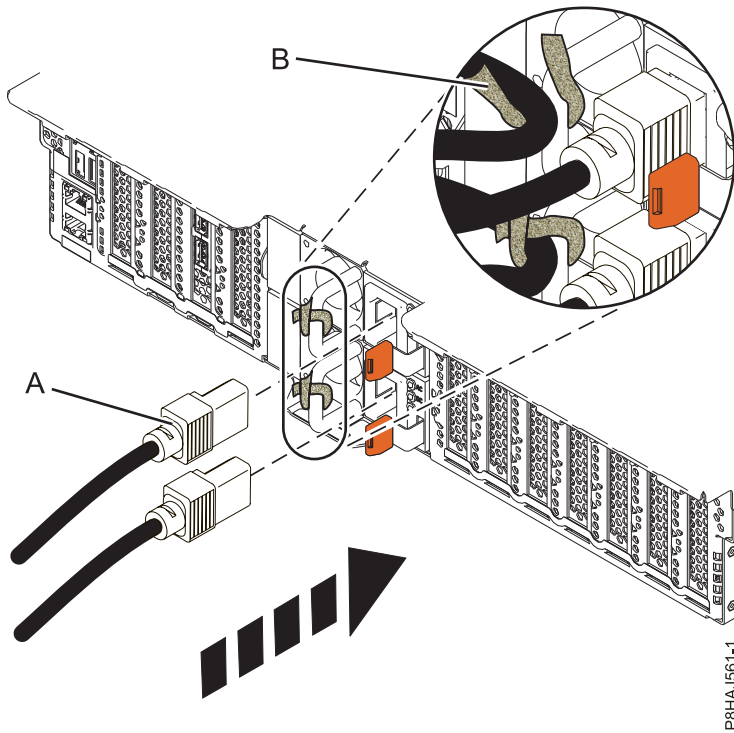

Figure 84. Connecting the power cords to a 5148-21L, 5148-22L, 8247-21L, 8247-22L, 8284-21A, or 8284-22A system

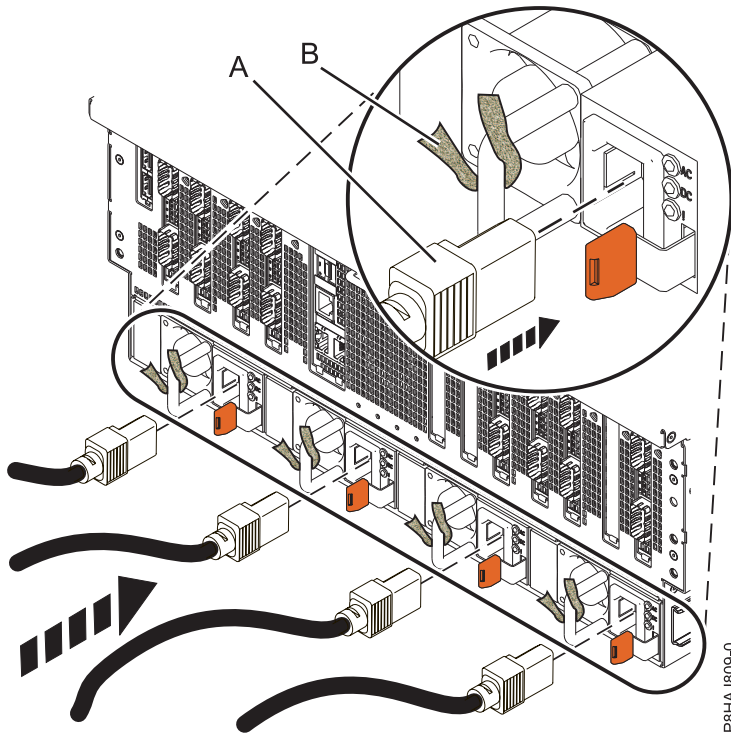

Figure 85. Connecting the power cords to an 8408-44E or 8408-E8E system

4. Close the rack door at the rear of the system.

Deactivating an identify LED

Learn how to deactivate an identifying LED for a part or enclosure.

Deactivating a system attention LED by using the operating system or VIOS tools

You can use the AIX, IBM i, or Linux operating system, or the Virtual I/O Server (VIOS) tools to deactivate a system attention LED.

Deactivating the indicator light for a part by using AIX diagnostics

Use this procedure to turn off any indicator light that you turned on as a part of a service action.

To deactivate the indicator light, complete the following steps:

1. Log in as root user.
2. At the command line, type `diag` and press Enter.
3. From the **Function Selection** menu, select **Task Selection** and press Enter.
4. From the **Task Selection** menu, select **Identify and Attention Indicators** and press Enter.
5. From the list of lights, select the location code for the part and press Enter. When a light is activated for a part, an I character precedes the location code.
6. Select **Commit**.
7. Exit to the command line.

Deactivating the indicator light by using the IBM i operating system

Use this procedure to turn off any indicator light that you turned on as a part of a service action.

To deactivate the indicator light, follow these steps:

1. Sign on to an IBM i session, **with at least service level authority**.
2. On the command line of the session, type `strsst` and press Enter.

Note: If you cannot get to the System Service Tools display, use function 21 from the control panel. Alternatively, if the system is managed by a Hardware Management Console (HMC), use the Service Focal Point utilities to get to the Dedicated Service Tools (DST) display.

3. Type your service tools user ID and service tools password on the System Service Tools (SST) Sign On display and press Enter.

Remember: The service tools password is case-sensitive.

4. Select **Start a service tool** from the System Service Tools (SST) display and press Enter.
5. Select **Hardware service manager** from the Start a Service Tool display and press Enter.
6. Select **Work with service action log** from the Hardware Service Manager display and press Enter.
7. On the Select Timeframe display, change the **From: Date and Time** field to a date and time prior to when the problem occurred.
8. Search for an entry that matches one or more conditions of the problem:
 - System reference code
 - Resource
 - Date and time
 - Failing item list
9. Select option 2 (Display failing item information) to display the service action log entry.
10. Select option 2 (Display details) to display location information for the failing part to be replaced. The information displayed in the date and time fields is the date and time for the first occurrence of the specific system reference code for the resource displayed during the time range selected.
11. Select option 7 (Indicator off) to turn off the indicator light.
12. Select the **Acknowledge all errors** function at the bottom of the Service Action Log display, if all problems have been resolved.
13. Close the log entry by selecting option 8 (Close new entry) on the Service Action Log Report display.

Deactivating the indicator light by using the Linux operating system

After you complete a removal and replacement procedure, you can deactivate the indicator light.

To deactivate the indicator light, complete the following steps:

1. Log in as root user.
2. At the command line, type `/usr/sbin/usysident -s normal -l location_code` and press Enter.

Related information:

 [Service and productivity tools for Linux on Power servers](#)

IBM provides hardware diagnostic aids and productivity tools, and installation aids for Linux operating systems on IBM Power Systems servers.

Deactivating the indicator light for a part by using the VIOS tools

Use this procedure to turn off any indicator light that you turned on as a part of a service action.

To deactivate the indicator light, complete the following steps:

1. Log in as root user.
2. At the command line, type `diagmenu` and press Enter.

3. From the **Function Selection** menu, select **Task Selection** and press Enter.
4. From the **Task Selection** menu, select **Identify and Attention Indicators** and press Enter.
5. From the list of lights, select the location code for the part and press Enter. When a light is activated for a part, an I character precedes the location code.
6. Select **Commit**.
7. Exit to the command line.

Deactivating a system attention LED by using the ASMI

You can use the Advanced System Management Interface (ASMI) to deactivate a system attention LED.

Deactivating the identify LED by using the ASMI when you know the location code

Learn how to deactivate the identify LED by using the Advanced System Management Interface (ASMI) when you know the location code.

You can specify the location code of any indicator to view or modify its current state. If you provide the wrong location code, the ASMI attempts to go to the next higher level of the location code.

The next level is the base-level location code for that field replaceable unit (FRU). For example, a user types the location code for the FRU located on the second memory module slot of the third enclosure in the system. If the location code for the second memory module slot is incorrect (the FRU does not exist at this location), an attempt to set the indicator for the third enclosure is initiated. This process continues until a FRU is located or no other level is available.

To complete this operation, your authority level must be one of the following levels:

- Administrator
- Authorized service provider

To change the current state of an indicator, complete the following steps:

1. On the ASMI Welcome pane, specify your user ID and password, and click **Log In**.
2. In the navigation area, expand **System Configuration > Service Indicators > Indicators by Location code**.
3. In the **Location code** field, type the location code of the FRU and click **Continue**.
4. From the **Identify indicator status** list, select **Off**.
5. Click **Save settings**.

Deactivating the identify LED by using the ASMI when you do not know the location code

Learn how to deactivate the identify LED by using the Advanced System Management Interface (ASMI) when you do not know the location code.

You can turn off the identify indicators in each enclosure.

To complete this operation, your authority level must be one of the following levels:

- Administrator
- Authorized service provider

To disable the enclosure indicator states, complete the following steps:

1. On the ASMI Welcome pane, specify your user ID and password, and click **Log In**.
2. In the navigation area, expand **System Configuration > Service Indicators > Enclosure Indicators**. All servers and enclosures managed by the ASMI will display.
3. Select the server or enclosure with the part that needs to be replaced and click **Continue**. The location code identifiers are listed.

4. Select the location code identifier and select **Off**.
5. To save the changes made to the state of one or more FRU indicators, click **Save settings**.

Deactivating a check log indicator (system information indicator) by using the ASMI

You can deactivate a check log indicator (system information indicator) or logical partition check log indicator by using the ASMI.

The check log indicator provides a visual signal that the system as a whole requires attention or service. Each system has a single check log indicator. When an event occurs that either needs your intervention or that of service and support, the check log indicator lights continuously. The check log indicator is turned on when an entry is made in the service processor error log. The error entry is transmitted to the system error log and to the operating system error log.

To complete this operation, your authority level must be one of the following levels:

- Administrator
- Authorized service provider

To turn off the check log indicator, do the following steps:

1. In the ASMI Welcome pane, specify your user ID and password, and click **Log In**.
2. In the navigation area, expand **System Configuration > Service Indicators > System Information Indicator**.
3. In the right pane, click **Turn off system information indicator**. If the attempt is unsuccessful, an error message is displayed.

Deactivating LEDs by using the HMC

Use this procedure to deactivate LEDs by using the Hardware Management Console (HMC).

Deactivating a system attention LED or partition LED by using the HMC

Use this procedure to deactivate a system attention LED or partition LED by using the Hardware Management Console (HMC).

To deactivate an LED by using the HMC, complete the following steps:

Choose one of the following navigation options depending on the interface type of the HMC:

- If you are using an HMC Classic or HMC Enhanced interface, complete the following steps:
 1. In the navigation area, click **Systems Management > Servers**.
 2. In the content pane, select the system.
 3. From the **Tasks** menu, click **Operations > LED Status**.
 4. Click **Identify LED**. The Identify LED window opens. The selected system and its LED state are displayed in the upper part of the window. The logical partition and its LED state are displayed in the lower part of the window. From the Identify LED window, you can deactivate both the system attention LED and the logical partition LED.
 5. Click **Deactivate Attention LED**. A confirmation window is displayed that provides the following information:
 - A verification that the system attention LED was deactivated.
 - An indication that there still might be open problems within the system.
 - An indication that you cannot deactivate the system attention LED.
 6. Select one of the logical partitions in the lower table, and click **Deactivate partition LED**. A confirmation window is displayed that provides the following information:
 - A verification that the logical partition attention LED was deactivated.

- An indication that there still might be open problems within the logical partition.
- An indication that you cannot deactivate the logical partition attention LED.
- If you are using an HMC Enhanced + Tech Preview (Pre-GA) or HMC Enhanced+ interface, complete the following steps:



1. In the navigation area, click the **Resources** icon  , and then click **All Systems**.
2. Click the server name for which you want to deactivate the attention LED.
3. In the navigation area, click **System Actions** > **Attention LED**.
4. Click **Turn Attention LED Off**. A confirmation window that provides the following information is displayed.
 - A verification that the system attention LED was deactivated.
 - An indication that there still might be open problems within the system.
5. Click **OK**.

Deactivating an identify LED for a FRU by using the HMC

Learn how to deactivate an identify LED by using the Hardware Management Console (HMC).

To deactivate an identify LED for a FRU by using the HMC, complete the following steps:

1. Choose one of the following navigation options depending on the interface type of the HMC:
 - If you are using an HMC Classic or HMC Enhanced interface, complete the following steps:
 - a. In the navigation area, click **Systems Management** > **Servers**.
 - b. In the content pane, select the system.
 - c. Click **Tasks** > **Operations** > **LED Status** > **Identify LED**. The Identify LED, Select Enclosure window is displayed.
 - If you are using an HMC Enhanced + Tech Preview (Pre-GA) or HMC Enhanced+ interface, complete the following steps.



- a. In the navigation area, click the **Resources** icon  , and then click **All Systems**.
- b. To view the actions for that server, click the name of the required server.
- c. In the navigation area, click **System Actions** > **Attention LED** > **Identify Attention LED**. The Identify LED, Select Enclosure window is displayed.
2. To deactivate an identify LED for a FRU, select an enclosure from the table, and then click **Selected** > **List FRUs**.
3. Select one or more FRUs from the table, and click **Deactivate LED**. The associated LED is turned off.

Deactivating an identify LED for an enclosure by using the HMC

Learn how to deactivate an identify LED by using the Hardware Management Console (HMC).

To deactivate an identify LED for an enclosure by using the HMC, complete the following steps:

1. Choose one of the following navigation options depending on the interface type of the HMC:
 - If you are using an HMC Classic or HMC Enhanced interface, complete the following steps:
 - a. In the navigation area, click **Systems Management** > **Servers**.
 - b. In the content pane, select the system.
 - c. Click **Tasks** > **Operations** > **LED Status** > **Identify LED**.
 - If you are using an HMC Enhanced + Tech Preview (Pre-GA) or HMC Enhanced+ interface, complete the following steps.



- a. In the navigation area, click the **Resources** icon  , and then click **All Systems**.
 - b. To view the actions for that server, click the name of the required server.
 - c. In the navigation area, click **System Actions > Attention LED > Identify Attention LED**.
2. To deactivate an identify LED for an enclosure, select an enclosure from the table, and click **Deactivate LED**. The associated LED is turned off.

Notices

This information was developed for products and services offered in the US.

IBM may not offer the products, services, or features discussed in this document in other countries. Consult your local IBM representative for information on the products and services currently available in your area. Any reference to an IBM product, program, or service is not intended to state or imply that only that IBM product, program, or service may be used. Any functionally equivalent product, program, or service that does not infringe any IBM intellectual property right may be used instead. However, it is the user's responsibility to evaluate and verify the operation of any non-IBM product, program, or service.

IBM may have patents or pending patent applications covering subject matter described in this document. The furnishing of this document does not grant you any license to these patents. You can send license inquiries, in writing, to:

*IBM Director of Licensing
IBM Corporation
North Castle Drive, MD-NC119
Armonk, NY 10504-1785
US*

INTERNATIONAL BUSINESS MACHINES CORPORATION PROVIDES THIS PUBLICATION "AS IS" WITHOUT WARRANTY OF ANY KIND, EITHER EXPRESS OR IMPLIED, INCLUDING, BUT NOT LIMITED TO, THE IMPLIED WARRANTIES OF NON-INFRINGEMENT, MERCHANTABILITY OR FITNESS FOR A PARTICULAR PURPOSE. Some jurisdictions do not allow disclaimer of express or implied warranties in certain transactions, therefore, this statement may not apply to you.

This information could include technical inaccuracies or typographical errors. Changes are periodically made to the information herein; these changes will be incorporated in new editions of the publication. IBM may make improvements and/or changes in the product(s) and/or the program(s) described in this publication at any time without notice.

Any references in this information to non-IBM websites are provided for convenience only and do not in any manner serve as an endorsement of those websites. The materials at those websites are not part of the materials for this IBM product and use of those websites is at your own risk.

IBM may use or distribute any of the information you provide in any way it believes appropriate without incurring any obligation to you.

The performance data and client examples cited are presented for illustrative purposes only. Actual performance results may vary depending on specific configurations and operating conditions.

Information concerning non-IBM products was obtained from the suppliers of those products, their published announcements or other publicly available sources. IBM has not tested those products and cannot confirm the accuracy of performance, compatibility or any other claims related to non-IBM products. Questions on the capabilities of non-IBM products should be addressed to the suppliers of those products.

Statements regarding IBM's future direction or intent are subject to change or withdrawal without notice, and represent goals and objectives only.

All IBM prices shown are IBM's suggested retail prices, are current and are subject to change without notice. Dealer prices may vary.

This information is for planning purposes only. The information herein is subject to change before the products described become available.

This information contains examples of data and reports used in daily business operations. To illustrate them as completely as possible, the examples include the names of individuals, companies, brands, and products. All of these names are fictitious and any similarity to actual people or business enterprises is entirely coincidental.

If you are viewing this information in softcopy, the photographs and color illustrations may not appear.

The drawings and specifications contained herein shall not be reproduced in whole or in part without the written permission of IBM.

IBM has prepared this information for use with the specific machines indicated. IBM makes no representations that it is suitable for any other purpose.

IBM's computer systems contain mechanisms designed to reduce the possibility of undetected data corruption or loss. This risk, however, cannot be eliminated. Users who experience unplanned outages, system failures, power fluctuations or outages, or component failures must verify the accuracy of operations performed and data saved or transmitted by the system at or near the time of the outage or failure. In addition, users must establish procedures to ensure that there is independent data verification before relying on such data in sensitive or critical operations. Users should periodically check IBM's support websites for updated information and fixes applicable to the system and related software.

Homologation statement

This product may not be certified in your country for connection by any means whatsoever to interfaces of public telecommunications networks. Further certification may be required by law prior to making any such connection. Contact an IBM representative or reseller for any questions.

Accessibility features for IBM Power Systems servers

Accessibility features assist users who have a disability, such as restricted mobility or limited vision, to use information technology content successfully.

Overview

The IBM Power Systems servers include the following major accessibility features:

- Keyboard-only operation
- Operations that use a screen reader

The IBM Power Systems servers use the latest W3C Standard, WAI-ARIA 1.0 (www.w3.org/TR/wai-aria/), to ensure compliance with US Section 508 (www.access-board.gov/guidelines-and-standards/communications-and-it/about-the-section-508-standards/section-508-standards) and Web Content Accessibility Guidelines (WCAG) 2.0 (www.w3.org/TR/WCAG20/). To take advantage of accessibility features, use the latest release of your screen reader and the latest web browser that is supported by the IBM Power Systems servers.

The IBM Power Systems servers online product documentation in IBM Knowledge Center is enabled for accessibility. The accessibility features of IBM Knowledge Center are described in the Accessibility section of the IBM Knowledge Center help (www.ibm.com/support/knowledgcenter/doc/kc_help.html#accessibility).

Keyboard navigation

This product uses standard navigation keys.

Interface information

The IBM Power Systems servers user interfaces do not have content that flashes 2 - 55 times per second.

The IBM Power Systems servers web user interface relies on cascading style sheets to render content properly and to provide a usable experience. The application provides an equivalent way for low-vision users to use system display settings, including high-contrast mode. You can control font size by using the device or web browser settings.

The IBM Power Systems servers web user interface includes WAI-ARIA navigational landmarks that you can use to quickly navigate to functional areas in the application.

Vendor software

The IBM Power Systems servers include certain vendor software that is not covered under the IBM license agreement. IBM makes no representation about the accessibility features of these products. Contact the vendor for accessibility information about its products.

Related accessibility information

In addition to standard IBM help desk and support websites, IBM has a TTY telephone service for use by deaf or hard of hearing customers to access sales and support services:

TTY service
800-IBM-3383 (800-426-3383)
(within North America)

For more information about the commitment that IBM has to accessibility, see IBM Accessibility (www.ibm.com/able).

Privacy policy considerations

IBM Software products, including software as a service solutions, (“Software Offerings”) may use cookies or other technologies to collect product usage information, to help improve the end user experience, to tailor interactions with the end user, or for other purposes. In many cases no personally identifiable information is collected by the Software Offerings. Some of our Software Offerings can help enable you to collect personally identifiable information. If this Software Offering uses cookies to collect personally identifiable information, specific information about this offering’s use of cookies is set forth below.

This Software Offering does not use cookies or other technologies to collect personally identifiable information.

If the configurations deployed for this Software Offering provide you as the customer the ability to collect personally identifiable information from end users via cookies and other technologies, you should seek your own legal advice about any laws applicable to such data collection, including any requirements for notice and consent.

For more information about the use of various technologies, including cookies, for these purposes, see IBM’s Privacy Policy at <http://www.ibm.com/privacy> and IBM’s Online Privacy Statement at <http://www.ibm.com/privacy/details> the section entitled “Cookies, Web Beacons and Other Technologies” and the “IBM Software Products and Software-as-a-Service Privacy Statement” at <http://www.ibm.com/software/info/product-privacy>.

Trademarks

IBM, the IBM logo, and ibm.com are trademarks or registered trademarks of International Business Machines Corp., registered in many jurisdictions worldwide. Other product and service names might be trademarks of IBM or other companies. A current list of IBM trademarks is available on the web at Copyright and trademark information at www.ibm.com/legal/copytrade.shtml.

Linux is a registered trademark of Linus Torvalds in the United States, other countries, or both.

Electronic emission notices

When attaching a monitor to the equipment, you must use the designated monitor cable and any interference suppression devices supplied with the monitor.

Class A Notices

The following Class A statements apply to the IBM servers that contain the POWER8 processor and its features unless designated as electromagnetic compatibility (EMC) Class B in the feature information.

Federal Communications Commission (FCC) Statement

Note: This equipment has been tested and found to comply with the limits for a Class A digital device, pursuant to Part 15 of the FCC Rules. These limits are designed to provide reasonable protection against harmful interference when the equipment is operated in a commercial environment. This equipment generates, uses, and can radiate radio frequency energy and, if not installed and used in accordance with the instruction manual, may cause harmful interference to radio communications. Operation of this equipment in a residential area is likely to cause harmful interference, in which case the user will be required to correct the interference at his own expense.

Properly shielded and grounded cables and connectors must be used in order to meet FCC emission limits. IBM is not responsible for any radio or television interference caused by using other than recommended cables and connectors or by unauthorized changes or modifications to this equipment. Unauthorized changes or modifications could void the user's authority to operate the equipment.

This device complies with Part 15 of the FCC rules. Operation is subject to the following two conditions: (1) this device may not cause harmful interference, and (2) this device must accept any interference received, including interference that may cause undesired operation.

Industry Canada Compliance Statement

CAN ICES-3 (A)/NMB-3(A)

European Community Compliance Statement

This product is in conformity with the protection requirements of EU Council Directive 2014/30/EU on the approximation of the laws of the Member States relating to electromagnetic compatibility. IBM cannot accept responsibility for any failure to satisfy the protection requirements resulting from a non-recommended modification of the product, including the fitting of non-IBM option cards.

European Community contact:
IBM Deutschland GmbH
Technical Regulations, Abteilung M456
IBM-Allee 1, 71139 Ehningen, Germany
Tel: +49 800 225 5426
email: halloibm@de.ibm.com

Warning: This is a Class A product. In a domestic environment, this product may cause radio interference, in which case the user may be required to take adequate measures.

VCCI Statement - Japan

この装置は、クラスA情報技術装置です。この装置を家庭環境で使用すると電波妨害を引き起こすことがあります。この場合には使用者が適切な対策を講ずるよう要求されることがあります。 VCCI-A

The following is a summary of the VCCI Japanese statement in the box above:

This is a Class A product based on the standard of the VCCI Council. If this equipment is used in a domestic environment, radio interference may occur, in which case, the user may be required to take corrective actions.

Japan Electronics and Information Technology Industries Association Statement

This statement explains the Japan JIS C 61000-3-2 product wattage compliance.

(一社) 電子情報技術産業協会 高調波電流抑制対策実施
要領に基づく定格入力電力値： Knowledge Centerの各製品の
仕様ページ参照

This statement explains the Japan Electronics and Information Technology Industries Association (JEITA) statement for products less than or equal to 20 A per phase.

高調波電流規格 JIS C 61000-3-2 適合品

This statement explains the JEITA statement for products greater than 20 A, single phase.

高調波電流規格 JIS C 61000-3-2 準用品

本装置は、「高圧又は特別高圧で受電する需要家の高調波抑制対策ガイドライン」対象機器（高調波発生機器）です。

- 回路分類：6（単相、PFC回路付）
- 換算係数：0

This statement explains the JEITA statement for products greater than 20 A per phase, three-phase.

高調波電流規格 JIS C 61000-3-2 準用品

本装置は、「高圧又は特別高圧で受電する需要家の高調波抑制対策ガイドライン」対象機器（高調波発生機器）です。

- 回路分類 : 5 (3相、PFC回路付)
- 換算係数 : 0

Electromagnetic Interference (EMI) Statement - People's Republic of China

声 明

此为 A 级产品, 在生活环境中, 该产品可能会造成无线电干扰。在这种情况下, 可能需要用户对其干扰采取切实可行的措施。

Declaration: This is a Class A product. In a domestic environment this product may cause radio interference in which case the user may need to perform practical action.

Electromagnetic Interference (EMI) Statement - Taiwan

警告使用者：

這是甲類的資訊產品，在居住的環境中使用時，可能會造成射頻干擾，在這種情況下，使用者會被要求採取某些適當的對策。

The following is a summary of the EMI Taiwan statement above.

Warning: This is a Class A product. In a domestic environment this product may cause radio interference in which case the user will be required to take adequate measures.

IBM Taiwan Contact Information:

台灣IBM 產品服務聯絡方式：
台灣國際商業機器股份有限公司
台北市松仁路7號3樓
電話：0800-016-888

Electromagnetic Interference (EMI) Statement - Korea

이 기기는 업무용 환경에서 사용할 목적으로 적합성평가를 받은 기기로서 가정용 환경에서 사용하는 경우 전파간섭의 우려가 있습니다.

Germany Compliance Statement

Deutschsprachiger EU Hinweis: Hinweis für Geräte der Klasse A EU-Richtlinie zur Elektromagnetischen Verträglichkeit

Dieses Produkt entspricht den Schutzanforderungen der EU-Richtlinie 2014/30/EU zur Angleichung der Rechtsvorschriften über die elektromagnetische Verträglichkeit in den EU-Mitgliedsstaaten und hält die Grenzwerte der EN 55022 / EN 55032 Klasse A ein.

Um dieses sicherzustellen, sind die Geräte wie in den Handbüchern beschrieben zu installieren und zu betreiben. Des Weiteren dürfen auch nur von der IBM empfohlene Kabel angeschlossen werden. IBM übernimmt keine Verantwortung für die Einhaltung der Schutzanforderungen, wenn das Produkt ohne Zustimmung von IBM verändert bzw. wenn Erweiterungskomponenten von Fremdherstellern ohne Empfehlung von IBM gesteckt/eingebaut werden.

EN 55022 / EN 55032 Klasse A Geräte müssen mit folgendem Warnhinweis versehen werden:
"Warnung: Dieses ist eine Einrichtung der Klasse A. Diese Einrichtung kann im Wohnbereich Funk-Störungen verursachen; in diesem Fall kann vom Betreiber verlangt werden, angemessene Maßnahmen zu ergreifen und dafür aufzukommen."

Deutschland: Einhaltung des Gesetzes über die elektromagnetische Verträglichkeit von Geräten

Dieses Produkt entspricht dem "Gesetz über die elektromagnetische Verträglichkeit von Geräten (EMVG)". Dies ist die Umsetzung der EU-Richtlinie 2014/30/EU in der Bundesrepublik Deutschland.

Zulassungsbescheinigung laut dem Deutschen Gesetz über die elektromagnetische Verträglichkeit von Geräten (EMVG) (bzw. der EMC Richtlinie 2014/30/EU) für Geräte der Klasse A

Dieses Gerät ist berechtigt, in Übereinstimmung mit dem Deutschen EMVG das EG-Konformitätszeichen - CE - zu führen.

Verantwortlich für die Einhaltung der EMV Vorschriften ist der Hersteller:
International Business Machines Corp.
New Orchard Road
Armonk, New York 10504
Tel: 914-499-1900

Der verantwortliche Ansprechpartner des Herstellers in der EU ist:
IBM Deutschland GmbH
Technical Relations Europe, Abteilung M456
IBM-Allee 1, 71139 Ehningen, Germany
Tel: +49 (0) 800 225 5426
email: HalloIBM@de.ibm.com

Generelle Informationen:

Das Gerät erfüllt die Schutzanforderungen nach EN 55024 und EN 55022 / EN 55032 Klasse A.

Electromagnetic Interference (EMI) Statement - Russia

ВНИМАНИЕ! Настоящее изделие относится к классу А.
В жилых помещениях оно может создавать
радиопомехи, для снижения которых необходимы
дополнительные меры

Class B Notices

The following Class B statements apply to features designated as electromagnetic compatibility (EMC) Class B in the feature installation information.

Federal Communications Commission (FCC) Statement

This equipment has been tested and found to comply with the limits for a Class B digital device, pursuant to Part 15 of the FCC Rules. These limits are designed to provide reasonable protection against harmful interference in a residential installation.

This equipment generates, uses, and can radiate radio frequency energy and, if not installed and used in accordance with the instructions, may cause harmful interference to radio communications. However, there is no guarantee that interference will not occur in a particular installation.

If this equipment does cause harmful interference to radio or television reception, which can be determined by turning the equipment off and on, the user is encouraged to try to correct the interference by one or more of the following measures:

- Reorient or relocate the receiving antenna.
- Increase the separation between the equipment and receiver.
- Connect the equipment into an outlet on a circuit different from that to which the receiver is connected.
- Consult an IBM-authorized dealer or service representative for help.

Properly shielded and grounded cables and connectors must be used in order to meet FCC emission limits. Proper cables and connectors are available from IBM-authorized dealers. IBM is not responsible for any radio or television interference caused by unauthorized changes or modifications to this equipment. Unauthorized changes or modifications could void the user's authority to operate this equipment.

This device complies with Part 15 of the FCC rules. Operation is subject to the following two conditions: (1) this device may not cause harmful interference, and (2) this device must accept any interference received, including interference that may cause undesired operation.

Industry Canada Compliance Statement

CAN ICES-3 (B)/NMB-3(B)

European Community Compliance Statement

This product is in conformity with the protection requirements of EU Council Directive 2014/30/EU on the approximation of the laws of the Member States relating to electromagnetic compatibility. IBM cannot accept responsibility for any failure to satisfy the protection requirements resulting from a non-recommended modification of the product, including the fitting of non-IBM option cards.

European Community contact:
IBM Deutschland GmbH
Technical Regulations, Abteilung M456
IBM-Allee 1, 71139 Ehningen, Germany
Tel: +49 800 225 5426
email: halloibm@de.ibm.com

VCCI Statement - Japan

この装置は、クラスB情報技術装置です。この装置は、家庭環境で使用することを目的としていますが、この装置がラジオやテレビジョン受信機に近接して使用されると、受信障害を引き起こすことがあります。

取扱説明書に従って正しい取り扱いをして下さい。 VCCI-B

Japan Electronics and Information Technology Industries Association Statement

This statement explains the Japan JIS C 61000-3-2 product wattage compliance.

(一社) 電子情報技術産業協会 高調波電流抑制対策実施
要領に基づく定格入力電力値 : Knowledge Centerの各製品の
仕様ページ参照

This statement explains the Japan Electronics and Information Technology Industries Association (JEITA) statement for products less than or equal to 20 A per phase.

高調波電流規格 JIS C 61000-3-2 適合品

This statement explains the JEITA statement for products greater than 20 A, single phase.

高調波電流規格 JIS C 61000-3-2 準用品

本装置は、「高圧又は特別高圧で受電する需要家の高調波抑制対策ガイドライン」対象機器（高調波発生機器）です。

- 回路分類 : 6 (単相、PFC回路付)
- 換算係数 : 0

This statement explains the JEITA statement for products greater than 20 A per phase, three-phase.

高調波電流規格 JIS C 61000-3-2 準用品

本装置は、「高圧又は特別高圧で受電する需要家の高調波抑制対策ガイドライン」対象機器（高調波発生機器）です。

- 回路分類 : 5 (3相、PFC回路付)
- 換算係数 : 0

IBM Taiwan Contact Information

台灣IBM 產品服務聯絡方式：
台灣國際商業機器股份有限公司
台北市松仁路7號3樓
電話：0800-016-888

Germany Compliance Statement

Deutschsprachiger EU Hinweis: Hinweis für Geräte der Klasse B EU-Richtlinie zur Elektromagnetischen Verträglichkeit

Dieses Produkt entspricht den Schutzanforderungen der EU-Richtlinie 2014/30/EU zur Angleichung der Rechtsvorschriften über die elektromagnetische Verträglichkeit in den EU-Mitgliedsstaaten und hält die Grenzwerte der EN 55022/ EN 55032 Klasse B ein.

Um dieses sicherzustellen, sind die Geräte wie in den Handbüchern beschrieben zu installieren und zu betreiben. Des Weiteren dürfen auch nur von der IBM empfohlene Kabel angeschlossen werden. IBM übernimmt keine Verantwortung für die Einhaltung der Schutzanforderungen, wenn das Produkt ohne Zustimmung von IBM verändert bzw. wenn Erweiterungskomponenten von Fremdherstellern ohne Empfehlung von IBM gesteckt/eingebaut werden.

Deutschland: Einhaltung des Gesetzes über die elektromagnetische Verträglichkeit von Geräten

Dieses Produkt entspricht dem "Gesetz über die elektromagnetische Verträglichkeit von Geräten (EMVG)". Dies ist die Umsetzung der EU-Richtlinie 2014/30/EU in der Bundesrepublik Deutschland.

Zulassungsbescheinigung laut dem Deutschen Gesetz über die elektromagnetische Verträglichkeit von Geräten (EMVG) (bzw. der EMC Richtlinie 2014/30/EU) für Geräte der Klasse B

Dieses Gerät ist berechtigt, in Übereinstimmung mit dem Deutschen EMVG das EG-Konformitätszeichen - CE - zu führen.

Verantwortlich für die Einhaltung der EMV Vorschriften ist der Hersteller:
International Business Machines Corp.
New Orchard Road
Armonk, New York 10504

Tel: 914-499-1900

Der verantwortliche Ansprechpartner des Herstellers in der EU ist:

IBM Deutschland GmbH
Technical Relations Europe, Abteilung M456
IBM-Allee 1, 71139 Ehningen, Germany
Tel: +49 (0) 800 225 5426
email: HalloIBM@de.ibm.com

Generelle Informationen:

Das Gerät erfüllt die Schutzanforderungen nach EN 55024 und EN 55022/ EN 55032 Klasse B.

Terms and conditions

Permissions for the use of these publications are granted subject to the following terms and conditions.

Applicability: These terms and conditions are in addition to any terms of use for the IBM website.

Personal Use: You may reproduce these publications for your personal, noncommercial use provided that all proprietary notices are preserved. You may not distribute, display or make derivative works of these publications, or any portion thereof, without the express consent of IBM.

Commercial Use: You may reproduce, distribute and display these publications solely within your enterprise provided that all proprietary notices are preserved. You may not make derivative works of these publications, or reproduce, distribute or display these publications or any portion thereof outside your enterprise, without the express consent of IBM.

Rights: Except as expressly granted in this permission, no other permissions, licenses or rights are granted, either express or implied, to the publications or any information, data, software or other intellectual property contained therein.

IBM reserves the right to withdraw the permissions granted herein whenever, in its discretion, the use of the publications is detrimental to its interest or, as determined by IBM, the above instructions are not being properly followed.

You may not download, export or re-export this information except in full compliance with all applicable laws and regulations, including all United States export laws and regulations.

IBM MAKES NO GUARANTEE ABOUT THE CONTENT OF THESE PUBLICATIONS. THE PUBLICATIONS ARE PROVIDED "AS-IS" AND WITHOUT WARRANTY OF ANY KIND, EITHER EXPRESSED OR IMPLIED, INCLUDING BUT NOT LIMITED TO IMPLIED WARRANTIES OF MERCHANTABILITY, NON-INFRINGEMENT, AND FITNESS FOR A PARTICULAR PURPOSE.

