

Power Systems

Site and hardware planning

IBM

Power Systems

Site and hardware planning

IBM

Note

Before using this information and the product it supports, read the information in “Safety notices” on page v, “Notices” on page 103, the *IBM Systems Safety Notices* manual, G229-9054, and the *IBM Environmental Notices and User Guide*, Z125-5823.

This edition applies to IBM Power Systems servers that contain the POWER8 processor and to all associated models.

© **Copyright IBM Corporation 2016.**

US Government Users Restricted Rights – Use, duplication or disclosure restricted by GSA ADP Schedule Contract with IBM Corp.

Contents

Safety notices	v
Site and hardware physical planning overview	1
Planning activities	3
Planning task checklist	3
General considerations	3
Site preparation and physical planning guidelines	4
Site and hardware planning	7
Hardware specification sheets	7
Server specifications	7
Model 5148-21L and 5148-22L server specifications	7
Rack specifications	10
Model 0550 and 9406-830 rack	10
Model 0551 rack	12
Model 0551, 0553, 0555, and 7014 rack configurations	13
Model 0551 and 9406-270 rack	20
Model 0554 and 7014-S11 rack	22
Model 0555 and 7014-S25 rack	24
Planning for the 7014-T00 and 7014-T42 racks	28
Model 7014-T00 rack	28
Model 7014-T42, 7014-B42, and 0553 rack	30
7014-T00, 7014-T42, and 0553 supported feature codes	33
7014-T00, 7014-T00, and 0553 racks multiple attachment	35
7014-T00, 7014-T42, and 0553 rack weight distribution and floor loading	35
Planning for the 7953-94X and 7965-94Y rack	37
Model 7953-94X and 7965-94Y rack	37
Cabling the 7953-94X and 7965-94Y rack	39
Side stabilizing outriggers	41
Multiple racks	42
Model 1164-95X rear door heat exchanger	43
Model 1164-95X rear door heat exchanger water cooling specifications and requirements	46
Planning for the 7965-S42 rack	50
Model 7965-S42 rack specifications	50
Cabling the 7965-S42 rack	54
Multiple racks	56
Model 1164-95X rear door heat exchanger	57
Model 1164-95X rear door heat exchanger water cooling specifications and requirements	60
Rack switch specifications	64
G8052R RackSwitch specification sheet	64
G8124ER RackSwitch specification sheet	64
G8264R RackSwitch specification sheet	65
G8316R RackSwitch specification sheet	66
Rack installation specifications for racks not purchased from IBM	66
Planning for power	73
Determining your power requirements	73
Server Information Form 3A	74
Workstation Information Form 3B	75
Plugs and receptacles	75
Supported power cords	75
Supported PDU power cords	85
Modification of IBM-provided power cords	88
Uninterruptible power supply	89
Power distribution unit and power cord options for 0551, 0553, 0555, 7014, 7953, and 7965 racks	91

Calculating the power load for 7188 or 9188 power distribution units	97
Planning for cables	99
Cable management	100
Power cord routing and retention	101
Notices	103
Accessibility features for IBM Power Systems servers	104
Privacy policy considerations	105
Trademarks	106
Electronic emission notices	106
Class A Notices.	106
Class B Notices	110
Terms and conditions.	113

Safety notices

Safety notices may be printed throughout this guide:

- **DANGER** notices call attention to a situation that is potentially lethal or extremely hazardous to people.
- **CAUTION** notices call attention to a situation that is potentially hazardous to people because of some existing condition.
- **Attention** notices call attention to the possibility of damage to a program, device, system, or data.

World Trade safety information

Several countries require the safety information contained in product publications to be presented in their national languages. If this requirement applies to your country, safety information documentation is included in the publications package (such as in printed documentation, on DVD, or as part of the product) shipped with the product. The documentation contains the safety information in your national language with references to the U.S. English source. Before using a U.S. English publication to install, operate, or service this product, you must first become familiar with the related safety information documentation. You should also refer to the safety information documentation any time you do not clearly understand any safety information in the U.S. English publications.

Replacement or additional copies of safety information documentation can be obtained by calling the IBM Hotline at 1-800-300-8751.

German safety information

Das Produkt ist nicht für den Einsatz an Bildschirmarbeitsplätzen im Sinne § 2 der Bildschirmarbeitsverordnung geeignet.

Laser safety information

IBM® servers can use I/O cards or features that are fiber-optic based and that utilize lasers or LEDs.

Laser compliance

IBM servers may be installed inside or outside of an IT equipment rack.

DANGER: When working on or around the system, observe the following precautions:

Electrical voltage and current from power, telephone, and communication cables are hazardous. To avoid a shock hazard:

- If IBM supplied the power cord(s), connect power to this unit only with the IBM provided power cord. Do not use the IBM provided power cord for any other product.
- Do not open or service any power supply assembly.
- Do not connect or disconnect any cables or perform installation, maintenance, or reconfiguration of this product during an electrical storm.
- The product might be equipped with multiple power cords. To remove all hazardous voltages, disconnect all power cords.
 - For AC power, disconnect all power cords from their AC power source.
 - For racks with a DC power distribution panel (PDP), disconnect the customer's DC power source to the PDP.
- When connecting power to the product ensure all power cables are properly connected.

- For racks with AC power, connect all power cords to a properly wired and grounded electrical outlet. Ensure that the outlet supplies proper voltage and phase rotation according to the system rating plate.
- For racks with a DC power distribution panel (PDP), connect the customer’s DC power source to the PDP. Ensure that the proper polarity is used when attaching the DC power and DC power return wiring.
- Connect any equipment that will be attached to this product to properly wired outlets.
- When possible, use one hand only to connect or disconnect signal cables.
- Never turn on any equipment when there is evidence of fire, water, or structural damage.
- Do not attempt to switch on power to the machine until all possible unsafe conditions are corrected.
- Assume that an electrical safety hazard is present. Perform all continuity, grounding, and power checks specified during the subsystem installation procedures to ensure that the machine meets safety requirements.
- Do not continue with the inspection if any unsafe conditions are present.
- Before you open the device covers, unless instructed otherwise in the installation and configuration procedures: Disconnect the attached AC power cords, turn off the applicable circuit breakers located in the rack power distribution panel (PDP), and disconnect any telecommunications systems, networks, and modems.

DANGER:

- Connect and disconnect cables as described in the following procedures when installing, moving, or opening covers on this product or attached devices.

To Disconnect:

1. Turn off everything (unless instructed otherwise).
2. For AC power, remove the power cords from the outlets.
3. For racks with a DC power distribution panel (PDP), turn off the circuit breakers located in the PDP and remove the power from the Customer's DC power source.
4. Remove the signal cables from the connectors.
5. Remove all cables from the devices.

To Connect:

1. Turn off everything (unless instructed otherwise).
2. Attach all cables to the devices.
3. Attach the signal cables to the connectors.
4. For AC power, attach the power cords to the outlets.
5. For racks with a DC power distribution panel (PDP), restore the power from the Customer's DC power source and turn on the circuit breakers located in the PDP.
6. Turn on the devices.

Sharp edges, corners and joints may be present in and around the system. Use care when handling equipment to avoid cuts, scrapes and pinching. (D005)

(R001 part 1 of 2):

DANGER: Observe the following precautions when working on or around your IT rack system:

- Heavy equipment–personal injury or equipment damage might result if mishandled.
- Always lower the leveling pads on the rack cabinet.
- Always install stabilizer brackets on the rack cabinet.
- To avoid hazardous conditions due to uneven mechanical loading, always install the heaviest devices in the bottom of the rack cabinet. Always install servers and optional devices starting from the bottom of the rack cabinet.
- Rack-mounted devices are not to be used as shelves or work spaces. Do not place objects on top of rack-mounted devices. In addition, do not lean on rack mounted devices and do not use them to stabilize your body position (for example, when working from a ladder).



- Each rack cabinet might have more than one power cord.
 - For AC powered racks, be sure to disconnect all power cords in the rack cabinet when directed to disconnect power during servicing.
 - For racks with a DC power distribution panel (PDP), turn off the circuit breaker that controls the power to the system unit(s), or disconnect the customer's DC power source, when directed to disconnect power during servicing.
- Connect all devices installed in a rack cabinet to power devices installed in the same rack cabinet. Do not plug a power cord from a device installed in one rack cabinet into a power device installed in a different rack cabinet.
- An electrical outlet that is not correctly wired could place hazardous voltage on the metal parts of the system or the devices that attach to the system. It is the responsibility of the customer to ensure that the outlet is correctly wired and grounded to prevent an electrical shock.

(R001 part 2 of 2):

CAUTION:

- Do not install a unit in a rack where the internal rack ambient temperatures will exceed the manufacturer's recommended ambient temperature for all your rack-mounted devices.
- Do not install a unit in a rack where the air flow is compromised. Ensure that air flow is not blocked or reduced on any side, front, or back of a unit used for air flow through the unit.
- Consideration should be given to the connection of the equipment to the supply circuit so that overloading of the circuits does not compromise the supply wiring or overcurrent protection. To provide the correct power connection to a rack, refer to the rating labels located on the equipment in the rack to determine the total power requirement of the supply circuit.
- *(For sliding drawers.)* Do not pull out or install any drawer or feature if the rack stabilizer brackets are not attached to the rack. Do not pull out more than one drawer at a time. The rack might become unstable if you pull out more than one drawer at a time.



- *(For fixed drawers.)* This drawer is a fixed drawer and must not be moved for servicing unless specified by the manufacturer. Attempting to move the drawer partially or completely out of the rack might cause the rack to become unstable or cause the drawer to fall out of the rack.

CAUTION:

Removing components from the upper positions in the rack cabinet improves rack stability during relocation. Follow these general guidelines whenever you relocate a populated rack cabinet within a room or building.

- Reduce the weight of the rack cabinet by removing equipment starting at the top of the rack cabinet. When possible, restore the rack cabinet to the configuration of the rack cabinet as you received it. If this configuration is not known, you must observe the following precautions:
 - Remove all devices in the 32U position (compliance ID RACK-001 or 22U (compliance ID RR001) and above.
 - Ensure that the heaviest devices are installed in the bottom of the rack cabinet.
 - Ensure that there are little-to-no empty U-levels between devices installed in the rack cabinet below the 32U (compliance ID RACK-001 or 22U (compliance ID RR001) level, unless the received configuration specifically allowed it.
- If the rack cabinet you are relocating is part of a suite of rack cabinets, detach the rack cabinet from the suite.
- If the rack cabinet you are relocating was supplied with removable outriggers they must be reinstalled before the cabinet is relocated.
- Inspect the route that you plan to take to eliminate potential hazards.
- Verify that the route that you choose can support the weight of the loaded rack cabinet. Refer to the documentation that comes with your rack cabinet for the weight of a loaded rack cabinet.
- Verify that all door openings are at least 760 x 230 mm (30 x 80 in.).
- Ensure that all devices, shelves, drawers, doors, and cables are secure.
- Ensure that the four leveling pads are raised to their highest position.
- Ensure that there is no stabilizer bracket installed on the rack cabinet during movement.
- Do not use a ramp inclined at more than 10 degrees.
- When the rack cabinet is in the new location, complete the following steps:
 - Lower the four leveling pads.
 - Install stabilizer brackets on the rack cabinet.
 - If you removed any devices from the rack cabinet, repopulate the rack cabinet from the lowest position to the highest position.
- If a long-distance relocation is required, restore the rack cabinet to the configuration of the rack cabinet as you received it. Pack the rack cabinet in the original packaging material, or equivalent. Also lower the leveling pads to raise the casters off of the pallet and bolt the rack cabinet to the pallet.

(R002)

(L001)



DANGER: Hazardous voltage, current, or energy levels are present inside any component that has this label attached. Do not open any cover or barrier that contains this label. (L001)

(L002)



DANGER: Rack-mounted devices are not to be used as shelves or work spaces. (L002)

(L003)



or



or



or



or



DANGER: Multiple power cords. The product might be equipped with multiple AC power cords or multiple DC power cables. To remove all hazardous voltages, disconnect all power cords and power cables. (L003)

(L007)



CAUTION: A hot surface nearby. (L007)

(L008)



CAUTION: Hazardous moving parts nearby. (L008)

All lasers are certified in the U.S. to conform to the requirements of DHHS 21 CFR Subchapter J for class 1 laser products. Outside the U.S., they are certified to be in compliance with IEC 60825 as a class 1 laser product. Consult the label on each part for laser certification numbers and approval information.

CAUTION:

This product might contain one or more of the following devices: CD-ROM drive, DVD-ROM drive, DVD-RAM drive, or laser module, which are Class 1 laser products. Note the following information:

- **Do not remove the covers. Removing the covers of the laser product could result in exposure to hazardous laser radiation. There are no serviceable parts inside the device.**
- **Use of the controls or adjustments or performance of procedures other than those specified herein might result in hazardous radiation exposure.**

(C026)

CAUTION:

Data processing environments can contain equipment transmitting on system links with laser modules that operate at greater than Class 1 power levels. For this reason, never look into the end of an optical fiber cable or open receptacle. Although shining light into one end and looking into the other end of a disconnected optical fiber to verify the continuity of optic fibers may not injure the eye, this procedure is potentially dangerous. Therefore, verifying the continuity of optical fibers by shining light into one end and looking at the other end is not recommended. To verify continuity of a fiber optic cable, use an optical light source and power meter. (C027)

CAUTION:

This product contains a Class 1M laser. Do not view directly with optical instruments. (C028)

CAUTION:

Some laser products contain an embedded Class 3A or Class 3B laser diode. Note the following information: laser radiation when open. Do not stare into the beam, do not view directly with optical instruments, and avoid direct exposure to the beam. (C030)

CAUTION:

The battery contains lithium. To avoid possible explosion, do not burn or charge the battery.

Do Not:

- **Throw or immerse into water**
- **Heat to more than 100°C (212°F)**
- **Repair or disassemble**

Exchange only with the IBM-approved part. Recycle or discard the battery as instructed by local regulations. In the United States, IBM has a process for the collection of this battery. For information, call 1-800-426-4333. Have the IBM part number for the battery unit available when you call. (C003)

CAUTION:

Regarding IBM provided VENDOR LIFT TOOL:

- Operation of LIFT TOOL by authorized personnel only.
- LIFT TOOL intended for use to assist, lift, install, remove units (load) up into rack elevations. It is not to be used loaded transporting over major ramps nor as a replacement for such designated tools like pallet jacks, walkies, fork trucks and such related relocation practices. When this is not practicable, specially trained persons or services must be used (for instance, riggers or movers).
- Read and completely understand the contents of LIFT TOOL operator's manual before using. Failure to read, understand, obey safety rules, and follow instructions may result in property damage and/or personal injury. If there are questions, contact the vendor's service and support. Local paper manual must remain with machine in provided storage sleeve area. Latest revision manual available on vendor's web site.
- Test verify stabilizer brake function before each use. Do not over-force moving or rolling the LIFT TOOL with stabilizer brake engaged.
- Do not move LIFT TOOL while platform is raised, except for minor positioning.
- Do not exceed rated load capacity. See LOAD CAPACITY CHART regarding maximum loads at center versus edge of extended platform.
- Only raise load if properly centered on platform. Do not place more than 200 lb (91 kg) on edge of sliding platform shelf also considering the load's center of mass/gravity (CoG).
- Do not corner load the platform tilt riser accessory option. Secure platform riser tilt option to main shelf in all four (4x) locations with provided hardware only, prior to use. Load objects are designed to slide on/off smooth platforms without appreciable force, so take care not to push or lean. Keep riser tilt option flat at all times except for final minor adjustment when needed.
- Do not stand under overhanging load.
- Do not use on uneven surface, incline or decline (major ramps).
- Do not stack loads.
- Do not operate while under the influence of drugs or alcohol.
- Do not support ladder against LIFT TOOL.
- Tipping hazard. Do not push or lean against load with raised platform.
- Do not use as a personnel lifting platform or step. No riders.
- Do not stand on any part of lift. Not a step.
- Do not climb on mast.
- Do not operate a damaged or malfunctioning LIFT TOOL machine.
- Crush and pinch point hazard below platform. Only lower load in areas clear of personnel and obstructions. Keep hands and feet clear during operation.
- No Forks. Never lift or move bare LIFT TOOL MACHINE with pallet truck, jack or fork lift.
- Mast extends higher than platform. Be aware of ceiling height, cable trays, sprinklers, lights, and other overhead objects.
- Do not leave LIFT TOOL machine unattended with an elevated load.
- Watch and keep hands, fingers, and clothing clear when equipment is in motion.
- Turn Winch with hand power only. If winch handle cannot be cranked easily with one hand, it is probably over-loaded. Do not continue to turn winch past top or bottom of platform travel. Excessive unwinding will detach handle and damage cable. Always hold handle when lowering, unwinding. Always assure self that winch is holding load before releasing winch handle.
- A winch accident could cause serious injury. Not for moving humans. Make certain clicking sound is heard as the equipment is being raised. Be sure winch is locked in position before releasing handle. Read instruction page before operating this winch. Never allow winch to unwind freely. Freewheeling will cause uneven cable wrapping around winch drum, damage cable, and may cause serious injury. (C048)

Power and cabling information for NEBS (Network Equipment-Building System) GR-1089-CORE

The following comments apply to the IBM servers that have been designated as conforming to NEBS (Network Equipment-Building System) GR-1089-CORE:

The equipment is suitable for installation in the following:

- Network telecommunications facilities
- Locations where the NEC (National Electrical Code) applies

The intrabuilding ports of this equipment are suitable for connection to intrabuilding or unexposed wiring or cabling only. The intrabuilding ports of this equipment *must not* be metalically connected to the interfaces that connect to the OSP (outside plant) or its wiring. These interfaces are designed for use as intrabuilding interfaces only (Type 2 or Type 4 ports as described in GR-1089-CORE) and require isolation from the exposed OSP cabling. The addition of primary protectors is not sufficient protection to connect these interfaces metalically to OSP wiring.

Note: All Ethernet cables must be shielded and grounded at both ends.

The ac-powered system does not require the use of an external surge protection device (SPD).

The dc-powered system employs an isolated DC return (DC-I) design. The DC battery return terminal *shall not* be connected to the chassis or frame ground.

The dc-powered system is intended to be installed in a common bonding network (CBN) as described in GR-1089-CORE.

Site and hardware physical planning overview

Successful installation requires effective planning of your physical and operational environment. You are the most valuable resource in site planning because you know where and how your system, and devices attached to it, will be used.

Site preparation for the complete system is the responsibility of the customer. The primary task of your site planner is to ensure that each system is installed so that it can operate and be serviced efficiently.

This topic collection provides the basic information you need to plan for your system installation. It provides an overview of each planning task, as well as valuable reference information useful throughout the performance of these tasks. Depending on the complexity of the system you ordered and your existing computing resource, you might not need to perform all the steps noted here.

First, with the help of your systems engineer, sales representative, or with the help of those coordinating your installation, list the hardware for which you need to plan. Use the summary of your order to help you when making your list. This list is now your "To Do" list. You can use the Planning task checklist to assist you.

While you are responsible for planning, vendors, contractors, and your sales representative are also available to help with any aspect of the planning. For some system units, a customer service representative will install your system unit and verify correct operation. Some system units are considered customer-installed. If you are not sure, check with your sales representative.

The physical planning section of this topic collection provides the physical characteristics of many system units, and associated products. For information on products not included in this topic collection, contact your sales representative or your authorized dealer.

Before proceeding with planning, ensure that the hardware and software you have chosen meets your needs. Your sales representative is available to answer questions.

While this information is for hardware planning, the system memory and disk storage needed are a function of the software to be used, therefore some things to consider are listed below. Information on software products is generally in or with the software Licensed Program Product itself.

In assessing the adequacy of hardware and software, consider the following:

- Available disk space and system memory for accommodating software, online documentation, and data (including future growth needs resulting from additional users, more data, and new applications)
- Compatibility of all devices
- Compatibility of software packages with each other and with the hardware configuration
- Adequate redundancy or backup capabilities in hardware and software
- Software portability to the new system, if necessary
- Prerequisites and corequisites of chosen software have been satisfied
- Data to be transferred to the new system

Planning activities

You can use this information to help you plan the physical installation for your server.

Proper planning for your system will facilitate a smooth installation and fast system start-up. Sales and installation planning representatives are also available to help you with installation planning.

As part of your planning activity, you will make decisions about where to locate your server and who will operate the system

Planning task checklist

Use this checklist to document your planning progress.

Working with your sales representative, establish completion dates for each of the tasks. You might want to review your planning schedule periodically with your sales representative.

Table 1. Planning task checklist

Planning step	Person responsible	Target date	Completion date
Plan your office or computer room layout (physical planning)			
Prepare for power cords and electrical needs			
Prepare for cables and cabling			
Create or modify communications networks			
Perform building alterations, as needed			
Prepare maintenance, recovery, and security plans			
Develop an education plan			
Order supplies			
Prepare for system delivery			

General considerations

Planning your system requires attention to the numerous details.

When determining the placement of your system, consider the following:

- Adequate space for the devices.
- Working environment of personnel who will be using the devices (their comfort, ability to access the devices, supplies, and reference materials).
- Adequate space for maintaining and servicing the devices.
- Physical security requirements necessary for the devices.
- Weight of the devices.
- Heat output of the devices.
- Operating temperature requirements of the devices.

- Humidity requirements of the devices.
- Air flow requirements of the devices.
- Air quality of the location where the devices will be used. For example, excess dust could damage your system.

Note: The system and devices are designed to operate in normal office environments. Dirty or other poor environments might damage the system or the devices. You are responsible for providing the proper operating environment.

- Altitude limitations of the devices.
- Noise emission levels of the devices.
- Any vibration of equipment near where the devices will be placed.
- Paths of power cords.

The following pages contain the information you need to evaluate these considerations.

Site preparation and physical planning guidelines

These guidelines help you prepare your site for the delivery and installation of your server.

Information contained in the Site preparation and physical planning might be helpful for preparing your data center for the arrival of a server.

The Site preparation and physical planning topic covers the following information:

Site selection, building and space considerations

- Site selection
- Access
- Static electricity and floor resistance
- Space requirements
- Floor construction and floor loading
- Raised floors
- Conductive contamination
- Computer room layout

Site environment, safety, and security

- Vibration and shock
- Lighting
- Acoustics
- Electromagnetic compatibility
- Computer room location
- Material and data storage protection
- Emergency planning for continuous operations

Electrical power and grounding

- General power information
- Power quality
- Voltage and frequency limits
- Power load
- Power source

- Dual power installations

Air conditioning

- Air conditioning determination
- General guidelines for data centers
- Temperature and humidity design criteria
- Temperature and humidity recording instruments
- Relocation and temporary storage
- Acclimation
- System air distribution

Planning for the installation of rear door heat exchangers

- Planning for the installation of rear door heat exchangers
- Heat exchanger specifications
- Water specifications for the secondary cooling loop
- Water delivery specifications for secondary loops
- Layout and mechanical installation
- Suggested sources for secondary loop components

Communications

- Planning for communications

Site and hardware planning

This topic collection provides specifications that site planners can use to assess the physical site and operational requirements necessary to prepare your site for a new server. This information includes specifications for servers and expansion units, plugs and receptacles, and cables as well as information about power-distribution units and uninterruptible power supplies.

Hardware specification sheets

Hardware specification sheets provide detailed information for your hardware, including dimensions, electrical, power, temperature, environment, and service clearances.

Server specifications

Server specifications provide detailed information for your server, including dimensions, electrical, power, temperature, environment, and service clearances.

Select the appropriate models to view the specifications for your server.

Model 5148-21L and 5148-22L server specifications

Server specifications provide detailed information for your server, including dimensions, electrical, power, temperature, environment, and service clearances.

Use the following specifications to plan for your server.

Table 2. Dimensions for 5148-21L and 5148-22L

Width	Depth	Height	EIA units	Weight
443 mm (17.5 in.)	755 mm (29.7 in.)	87 mm (3.5 in.)	2	28.6 kg (63 lb)

Table 3. Shipping dimensions for 5148-21L and 5148-22L (without pallet)

Width	Depth	Height	Weight
992 mm (39.1 in.)	592 mm (23.3 in.)	282 mm (11.1 in.)	37.7 kg (83.1 lb)

Table 4. Electrical characteristics for 5148-21L (IBM Elastic Storage Server Management Server) and 5148-22L (IBM Elastic Storage Server Data Server)

Electrical characteristics	Properties
AC rated voltage and frequency ¹	200 - 240 V ac at 47 - 63 Hz (5148-21L and 5148-22L)
Thermal output (maximum) ²	2270 Btu/hr (5148-21L)
	4266 Btu/hr (5148-22L)
Maximum power consumption ²	665 W (5148-21L)
	1250 W (5148-22L)
Maximum kVA ³	0.679 (5148-21L)
	1.276 (5148-22L)
Phase	Single

Table 4. Electrical characteristics for 5148-21L (IBM Elastic Storage Server Management Server) and 5148-22L (IBM Elastic Storage Server Data Server) (continued)

Electrical characteristics	Properties
Notes:	
<ol style="list-style-type: none"> 1. The power supplies automatically accept any voltage with the published, rated-voltage range. If dual power supplies are installed and operating, the power supplies draw approximately equal current from the utility (electrical supply) and provide approximately equal current to the load. 2. Power draw and heat load vary greatly by configuration. When you plan for an electrical system, it is important to use the maximum values. However, when you plan for heat load, you can use the IBM Systems Energy Estimator to obtain a heat output estimate based on a specific configuration. For more information, see The IBM Systems Energy Estimator website. 3. To calculate the amperage, multiply the kVA by 1000 and divide that number by the operating voltage. 	

Table 5. Environment requirements

Environment	Recommended operating	Allowable operating	Nonoperating
ASHRAE class		A3	
Airflow direction		Front-to-back	
Temperature ¹	18°C - 27°C (64°F - 80°F)	5°C - 40°C (41°F - 104°F)	5°C - 45°C (41°F - 113°F)
Humidity range	5.5°C (42°F) dew point (DP) to 60% relative humidity (RH) and 15°C (59°F) dew point	-12.0°C (10.4°F) DP and 8% - 80% RH	8% - 80% RH
Maximum dew point		24°C (75°F)	27°C (80°F)
Maximum operating altitude		3050 m (10000 ft)	
Shipping temperature ²			-40°C to 60°C (-40°F to 140°F)
Shipping relative humidity			5% - 100%
<ol style="list-style-type: none"> 1. Derate maximum allowable dry-bulb temperature 1°C per 175 m above 950 m. IBM recommends a temperature range of 18°C - 27°C (64°F - 80.6°F). 2. The maximum wet bulb temperature is 29°C (84°F). If one or more feature codes that are listed in Table 6 are installed, then the maximum wet bulb temperature is 28°C (82°F). 			

Table 6. Supported feature codes that affect environmental requirements¹

Feature codes (FCs)	Feature code names
1738 / EQ38	856 GB (IBM i) 10K RPM SAS HDD (Gen2-S)
1752 / EQ52	900 GB (AIX/Linux) 10K RPM SAS HDD (Gen2-S)
1917 / 1866	146 GB (AIX/Linux) 15K RPM SAS HDD (Gen2-S)
1925 / 1869	300 GB (AIX/Linux) 10K RPM SAS HDD (Gen2-S)
1947 / 1868	139 GB (IBM i) 15K RPM SAS HDD (Gen2-S)
1948 / 1927	283 GB (IBM i) 15K RPM SAS HDD (Gen2-S)
1953 / 1929	300 GB (AIX/Linux) 15K RPM SAS HDD (Gen2-S)
1956 / 1844	283 GB (IBM i) 10K RPM SAS HDD (Gen2-S)
1962 / 1817	571 GB (IBM i) 10K RPM SAS HDD (Gen2-S)
1964 / 1818	600 GB (AIX/Linux) 10K RPM SAS HDD (Gen2-S)
ESD2 / EQD2	1.14 TB (IBM i) 10K RPM SAS HDD (Gen2-S)

Table 6. Supported feature codes that affect environmental requirements¹ (continued)

Feature codes (FCs)	Feature code names
ESD3 / EQD3	1.2 TB (AIX/Linux) 10K RPM SAS HDD (Gen2-S)
ESDU	139 GB (IBM i) 15K RPM SAS HDD (Gen3)
ESDT	146 GB (AIX/Linux) 15K RPM SAS HDD (Gen3)
ESDA	283 GB (IBM i) 15K RPM SAS HDD (Gen3)
ESDB	300 GB (AIX/Linux) 15K RPM SAS HDD (Gen3)
ESDS	283 GB (IBM i) 10K RPM SAS HDD (Gen3)
ESDR	300 GB (AIX/Linux) 10K RPM SAS HDD (Gen3)
ESD4	571 GB (IBM i) 10K RPM SAS HDD (Gen3)
ESD5	600 GB (AIX/Linux) 10K RPM SAS HDD (Gen3)
ESD8	1.14 TB (IBM i) 10K RPM SAS HDD (Gen3)
ESD9	1.2 TB (AIX/Linux) 10K RPM SAS HDD (Gen3)
ESEY	283 GB (IBM i) 15K RPM 4KN SAS HDD (Gen2-S)
ESEZ	300 GB (AIX/Linux) 15K RPM 4KN SAS HDD (Gen2-S)
ESFA	283 GB (IBM i) 15K RPM 4KN SAS HDD (Gen3)
ESFB	300 GB (AIX/Linux) 15K RPM 4KN SAS HDD (Gen3)
ESFE	571 GB (IBM i) 15K RPM 4KN SAS HDD (Gen3)
ESFF	600 GB (AIX/Linux) 15K RPM 4KN SAS HDD (Gen3)
ESFN	571 GB (IBM i) 15K RPM 4KN SAS HDD (Gen2-S)
ESFP	600 GB (AIX/Linux) 15K RPM 4KN SAS HDD (Gen2-S)
ESDE	571 GB (IBM i) 15K RPM SAS HDD (Gen3)
ESDF	600 GB (AIX/Linux) 15K RPM SAS HDD (Gen3)
ESDN	571 GB (IBM i) 15K RPM SAS HDD (Gen2-S)
ESDP	600 GB (AIX/Linux) 15K RPM SAS HDD (Gen2-S)
Note:	
1. Any feature code that is listed in this table and is installed in your system decreases the maximum wet bulb temperature that is allowed during shipping from 29°C (84°F) to 28°C (82°F).	

Table 7. Service clearances

Clearances	Front	Rear	Left or right	Top
Operating	762 mm (30 in.)	762 mm (30 in.)		
Nonoperating	762 mm (30 in.)	762 mm (30 in.)	762 mm (30 in.)	762 mm (30 in.)

Electromagnetic compatibility compliance: CISPR 22; CISPR 24; FCC, CFR 47, Part 15 (US); VCCI (Japan); Directive 2004/108/EC (EEA); ICES-003, Issue 4 (Canada); ACMA radio communications standard (Australia, New Zealand); CNS 13438 (Taiwan); Radio Waves Act, MIC Rule No. 210 (Korea); Commodity Inspection Law (China); TCVN 7189 (Vietnam); MoCI (Saudi Arabia); SI 961 (Israel); GOST R 51318.22, 51318.24 (Russia)

Safety compliance: IEC/EN 60950-1; UL/CSA 60950-1

Special Hardware Management Console considerations

When the server is managed by a Hardware Management Console (HMC), the console must be provided within the same room and within 8 m (26 ft) of the server. For additional considerations, see Installing and configuring the HMC.

Note: As an alternative to the local HMC requirement, you can provide a supported device, such as a PC, with connectivity and authority to operate through a remotely attached HMC. This local device must be in the same room and within 8 m (26 ft) of your server. This local device must provide functional capabilities that are equivalent to the HMC that it replaces. This local device is needed by the service representative to service the system.

Rack specifications

Rack specifications provide detailed information for your rack, including dimensions, electrical, power, temperature, environment, and service clearances.

For non-IBM rack specifications, see Rack installation procedures for racks not purchased at IBM.

Select your rack model to view its specifications.

Model 0550 and 9406-830 rack

Rack specifications provide detailed information for your rack, including dimensions, electrical, power, temperature, environment, and service clearances.



Figure 1. 0550 rack

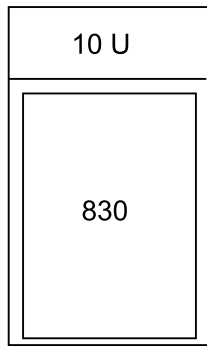

RBAGP815-0

Figure 2. 0550 rack configuration

Table 8. Dimensions

Maximum configuration weight	Width	Depth	Height	EIA units
644 kg (1417 lb)	650 mm (25.5 in.)	1020 mm (40.0 in.)	1800 mm (71.0 in.)	36
The 1.8 meter rack has 10 EIA units of space remaining. This space will be filled with a 5 EIA filler panel, a 3 EIA filler panel, and two of the 1 EIA filler panels. Because the rack does not have power distribution, the model 9406-830 rack requires a power cord of sufficient length to reach the receptacle. The power cord for model 9406-830 rack must be used to determine the appropriate receptacle.				

Table 9. Electrical

Electrical characteristics	Properties
kVA (maximum)	1.684
Rated voltage and frequency	200 - 240 V ac at 50 - 60 plus or minus 0.5 Hz
Thermal output (maximum)	5461 Btu/hr
Power requirements (maximum)	1600 W
Power factor	0.95
Inrush current	80 A
Leakage current (maximum)	3.5 mA
Phase	1

Table 10. Service clearance

Front	Back	Sides	Top
762 mm (30 in.)	762 mm (30 in.)	762 mm (30 in.)	762 mm (30 in.)
Side and top clearances are optional when operating.			

Table 11. Feature code

Feature Code	Top rack specify	Bottom rack specify	PDU support	Power cords
0550 ¹	None	None	0 to 4 ²	Model 9406-830 ³ , PDU
¹ Ten EIA units of space not managed by the configurator.				
² Feature codes 5160, 5161, and 5162.				
³ Model 9406-830 does not plug into a power distribution unit.				

Model 0551 rack

The 0551 rack specifications provide detailed information for your rack.

The 0551 provides an empty 1.8 m rack (36 EIA units of total space).

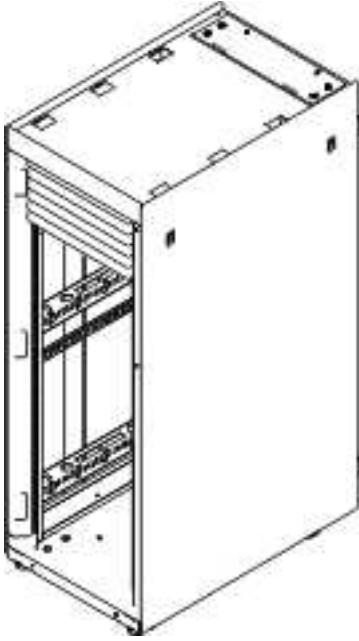

Figure 3. 0551 rack

Table 12. Dimensions

Maximum configuration weight	Width	Depth	Height
The weight of the empty rack is 244 kg (535 lb).	650 mm (25.5 in.)	1020 mm (40.0 in.)	1800 mm (71.0 in.)

Table 13. Temperature requirements

Operating	Nonoperating
10°C - 38°C (50°F - 100.4°F)	1°C - 60°C (33.8°F - 140°F)

Table 14. Environment requirements

Environment	Operating	Nonoperating
Noncondensing humidity	8% - 80%	8% - 80%
Wet bulb temperature	22.8°C (73°F)	22.8°C (73°F)
Maximum altitude	3048 m (10000 ft)	3048 m (10000 ft)
Noise emissions	Rack noise levels are a function of the number and type of drawers installed. See your server or hardware specifications for specific requirements	Rack noise levels are a function of the number and type of drawers installed. See your server or hardware specifications for specific requirements

Table 15. Service clearances

Front	Back	Sides	Top
762 mm (30 in.)	762 mm (30 in.)	762 mm (30 in.)	762 mm (30 in.)
Side and top clearances are optional during operation			

Notes:

1. The 1.8 meter rack has 10 EIA units of space remaining. This space will be filled with a 5 EIA filler panel, a 3 EIA filler panel, and two of the 1 EIA filler panels. Because the rack does not have power distribution, the model 830 requires a power cord of sufficient length to reach the receptacle. The power cord for model 830 must be used to determine the appropriate receptacle.
2. Acoustic doors are available for the IBM racks. Feature code 6248 is available for the 0551 and 7014-T00 racks. Feature code 6249 is available for the 0553 and 7014-T42 racks. The overall sound reduction is approximately 6 dB. The doors add 381 mm (15 in.) to the depth of the racks.
3. For a description of noise emission values, see Acoustics.

Caster and leveler locations

Figure 4 provides the caster and leveler locations for the 7014-T00, 7014-T42, 0551, 0553 and 0555 racks.

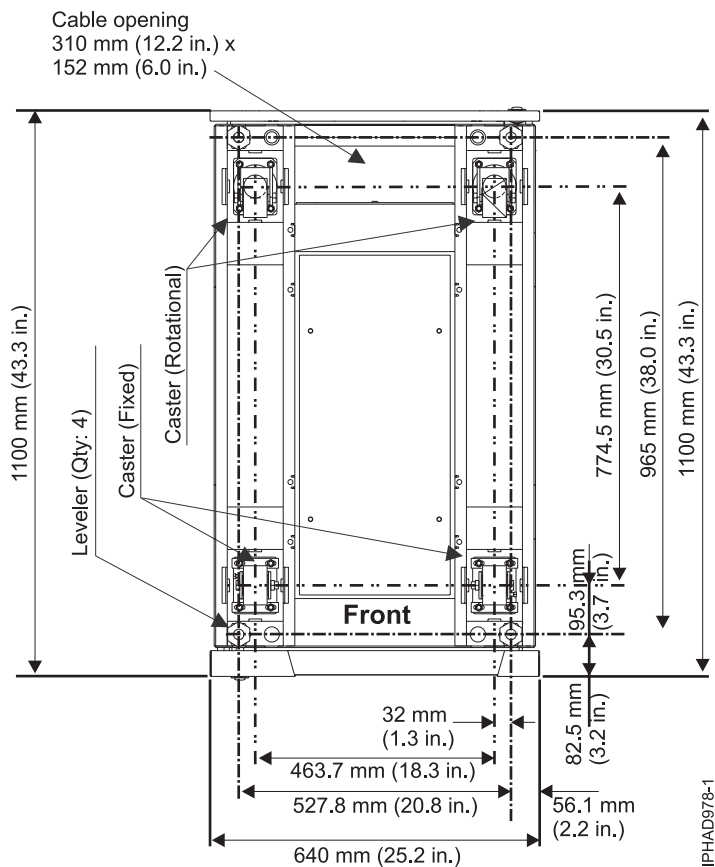
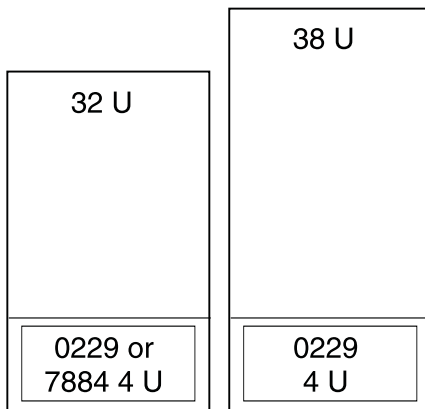

Figure 4. Caster and leveler locations

Model 0551, 0553, 0555, and 7014 rack configurations

The 0551 or 7014-T00 provide a 1.8 meter rack (36 EIA units of total space). The 7014-T42 or 0553 provides a 2.0 meter rack (42 EIA units of total space).

Feature code 7884 and 0229



IPHAD607-1

Figure 5. Feature code 7884

Table 16. Feature code 7884

IBM rack	Rack, specify code	PDU support	Power cords
0551 ¹	7884, 0229	0 to 4 ²	7884, PDU ³
0553 ¹			
7014 ⁴			
0555			

¹0551 is an empty 1.8 meter rack with 36 EIA units of total space. 0553 is a 2.0 meter rack with 42 EIA units of total space.

²0551, 0553, and 0555 feature codes 5160, 5161, 5163, and 7188. 7014 feature codes 7176, 7177, 7178, and 7188.

³If units plug into a power distribution unit (PDU), power jumper cord feature code 6458, 6459, 6095, or 9911 is required. If redundant power supply (feature code 5158) is ordered, a second power jumper cord feature code is required.

⁴7014-T00 is a 1.8 meter rack with 36 EIA units of total space. 7014-T42 is a 2.0 meter rack with 42 EIA units of total space. The rack includes one PDU, feature code 9188, 9176, 9177, or 9178.

Feature code 0230 and 7886



IPHAD613-0

Figure 6. 550 in a rack

Table 17. 550 in a rack

IBM rack	Rack, specify code	PDU support	Power cords
7014 ¹	0230 and 7886	0 to 4 ²	PDU ³
<p>¹7014-T00 is a 1.8 meter rack with 36 EIA units of total space. 7014-T42 is a 2.0 meter rack with 42 EIA units of total space. The rack includes one PDU, feature code 9188, 9176, 9177, or 9178.</p> <p>²0551, 0553, and 0555 feature codes 5160, 5161, 5163, and 7188. 7014 feature codes 7176, 7177, 7178, and 7188.</p> <p>³If unit plugs into a PDU, two feature code 6458, 6459, 6095, or 9911 power jumper cords are required.</p>			

Feature codes 0231, 0232, 0241, and 0242

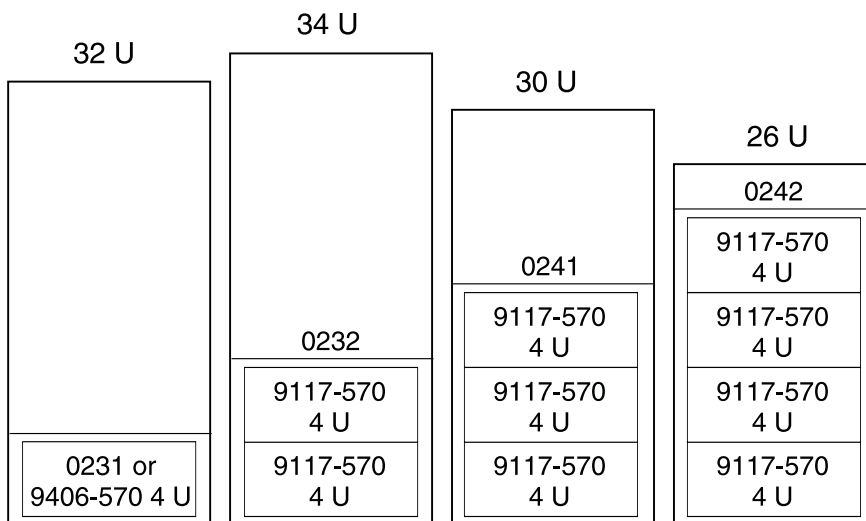

IPHAD608-1

Figure 7. 570 in rack

Table 18. 570 in rack

IBM rack	Rack, specify code	PDU support	Power cords
0551 ¹ 0553 ¹ 7014 ³ 0555	0231, 0232, 0241, 0242	0 to 4 ²	PDU ⁴
<p>¹0551 is an empty 1.8 meter rack with 36 EIA units of total space. 0553 is a 2.0 meter rack with 42 EIA units of total space.</p> <p>²0551, 0553, and 0555 feature codes 5160, 5161, 5163, and 7188. 7014 feature codes 7176, 7177, 7178, and 7188.</p> <p>³7014-T00 is a 1.8 meter rack with 36 EIA units of total space. 7014-T42 is a 2.0 meter rack with 42 EIA units of total space. The rack includes one PDU, feature code 9188, 9176, 9177, or 9178.</p> <p>⁴If unit plugs into a PDU, two feature code 6458, 6459, 6095, or 9911 power jumper cords are required.</p>			

Feature code 0123 - 5074 lower expansion unit in rack; feature code 0574 - 5074 equivalent

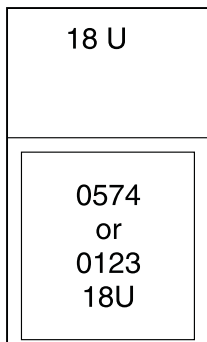

IPHAD600-0

Figure 8. Feature code 0123

Table 19. Feature code 0123

IBM rack	Bottom rack, specify code	Rack, specify code	PDU support	Power cords
0551 ¹ 0553 ¹ 0555	0123	0574	0 to 4 ²	0123, 0574, PDU ³
<p>¹0551 is an empty 1.8 meter rack with 36 EIA units of total space. 0553 is a 2.0 meter rack with 42 EIA units of total space.</p> <p>²0551, 0553, and 0555 feature codes 5160, 5161, 5163, and 7188. 7014 feature codes 7176, 7177, 7178, and 7188.</p> <p>³Feature code 0123 or 0574 do not plug into a PDU.</p>				

Feature code 0694 - 5094 equivalent

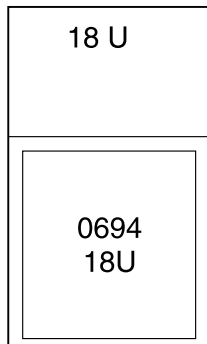

IPHAD601-0

Figure 9. Feature code 0694 - 5094 equivalent

Table 20. Feature code 0694 - 5094 equivalent

IBM rack	Rack, specify code	PDU support	Power cords
0551 ¹	0694	0 to 4 ²	0694, PDU ³
0553 ¹			
0555			
¹ 0551 is an empty 1.8 meter rack with 36 EIA units of total space. 0553 is a 2.0 meter rack with 42 EIA units of total space. ² 0551, 0553, and 0555 feature codes 5160, 5161, 5163, and 7188. 7014 feature codes 7176, 7177, 7178, and 7188. ³ Feature code 0125 does not plug into a PDU.			

Feature code 0133 - Manufacturing installation in rack (models 9406-800 and 9406-810); feature code 0137 - IBM service representation installation in rack (models 9406-800 and 9406-810)

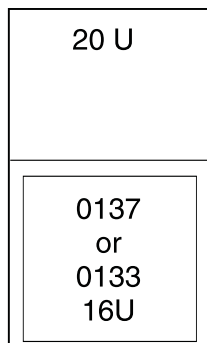

IPHAD602-0

Figure 10. Feature code 0133

Table 21. Feature code 0133

IBM rack	Rack, specify code	PDU support	Power cords
0551 ¹ 0553 ¹ 0555	0133 ³ , 0137 ³	0 to 4 ²	0133, 0137, PDU ⁴
<p>¹ 0551 is an empty 1.8 meter rack with 36 EIA units of total space. 0553 is a 2.0 meter rack with 42 EIA units of total space.</p> <p>² 0551, 0553, and 0555 feature codes 5160, 5161, 5163, and 7188. 7014 feature codes 7176, 7177, 7178, and 7188.</p> <p>³ This feature provides a rack shelf (2 U) with rail assembly, cable-management-arm assembly, adapter plate, and a pair of lift covers.</p> <p>⁴ If unit plugs into a PDU, two feature code 6458, 6459, 6095, or 9911 power jumper cords are required.</p>			

Feature code 0134 - IBM service representation installation in rack; feature code 0138 - IBM service representation installation in rack

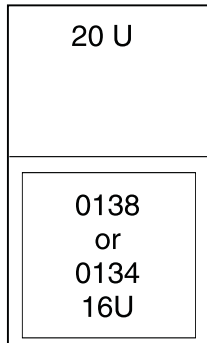

IPHAD603-0

Figure 11. Feature code 0134

Table 22. Feature code 0134

IBM rack	Rack, specify code	PDU support	Power cords
0551 ¹ 0553 ¹ 0555	0134 ³ , 0138 ³	0 to 4 ²	0134, 0138, PDU ⁴
<p>¹ 0551 is an empty 1.8 meter rack with 36 EIA units of total space. 0553 is a 2.0 meter rack with 42 EIA units of total space.</p> <p>² 0551, 0553, and 0555 feature codes 5160, 5161, 5163, and 7188. 7014 feature codes 7176, 7177, 7178, and 7188.</p> <p>³ This feature provides a rack shelf (2 U), cable-management-arm assembly, adapter plate, and a pair of lift covers.</p> <p>⁴ If unit plugs into a PDU, two feature code 6458, 6459, 6095, or 9911 power jumper cords are required.</p>			

Feature code 0578 - PCI-X expansion unit in rack

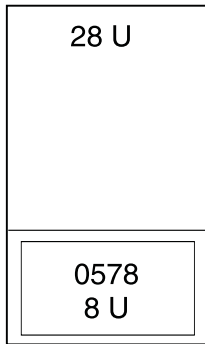

IPHAD604-0

Figure 12. Feature code 0578 - PCI-X expansion unit in rack

Table 23. Feature code 0578 - PCI-X expansion unit in rack

IBM rack	Rack, specify code	PDU support	Power cords
0551 ¹	0578	0 to 4 ²	PDU ³
0553 ¹			
0555			

¹0551 is an empty 1.8 meter rack with 36 EIA units of total space. 0553 is a 2.0 meter rack with 42 EIA units of total space.

²0551, 0553, and 0555 feature codes 5160, 5161, 5163, and 7188. 7014 feature codes 7176, 7177, 7178, and 7188.

³0578 includes two rack power cords that plug into a PDU.

Feature code 0588 - PCI-X expansion unit in rack

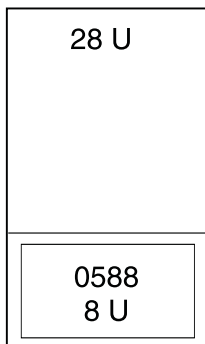

IPHAD605-0

Figure 13. Feature code 0588 - PCI-X expansion unit in rack

Table 24. Feature code 0588 - PCI-X expansion unit in rack

IBM rack	Rack, specify code	PDU support	Power cords
0551 ¹	0588	0 to 4 ²	PDU ³
0553 ¹			
0555			

Table 24. Feature code 0588 - PCI-X expansion unit in rack (continued)

IBM rack	Rack, specify code	PDU support	Power cords
¹ 0551 is an empty 1.8 meter rack with 36 EIA units of total space. 0553 is a 2.0 meter rack with 42 EIA units of total space. ² 0551, 0553, and 0555 feature codes 5160, 5161, 5163, and 7188. 7014 feature codes 7176, 7177, 7178, and 7188. ³ 0588 comes with two rack power cords that plug into a PDU.			

Feature code 0595 - PCI-X expansion unit in rack

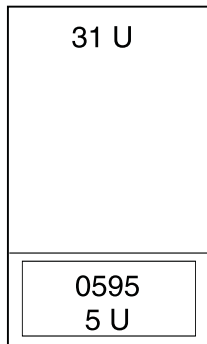

IPHAD606-0

Table 25. Feature code 0595 - PCI-X expansion unit in rack

IBM rack	Rack, specify code	PDU support	Power cords
0551 ¹	0595	0 to 4 ²	0595, PDU ³
0553 ¹			
0555			
¹ 0551 is an empty 1.8 meter rack with 36 EIA units of total space. 0553 is a 2.0 meter rack with 42 EIA units of total space. ² 0551, 0553, and 0555 feature codes 5160, 5161, 5163, and 7188. 7014 feature codes 7176, 7177, 7178, and 7188. ³ If unit plugs into a PDU, feature code 1422 is required. If redundant power supply (feature code 5138) is ordered, a second feature code 1422 is required.			

Note: Supported only on MES orders and includes a rack shelf with rail assembly, adapter plate, and cable-management-arm assembly.

Model 0551 and 9406-270 rack

Server specifications provide detailed information for your server, including dimensions, electrical, power, temperature, environment, and service clearances.

Pictured is model 0551 and 9406-270 rack. The 0551 consists of two models 9406-270 with 7104 system unit expansions installed in a 1.8 m rack. Specify code 0121 represents the first model 9406-270 in the rack (on the bottom). Specify code 0122 represents the second model 9406-270 in the rack (on the top).



Figure 14. Model 0551 and 9406-270 rack

Table 26. Dimensions

Maximum configuration weight ¹	Height	Width	Depth
403 kg (885 lb)	1800 mm (71.0 in.)	650 mm (25.5 in.)	1020 mm (40.0 in.)
¹ Side and top clearances are optional when operating.			

Table 27. Electrical

Electrical characteristics	Properties
kVA (maximum)	0.789
Rated voltage and frequency	100 - 127 or 200 - 240 V ac at 50 - 60 plus or minus 0.5 Hz
Thermal output (maximum)	2560 Btu/hr
Power requirements (maximum)	750 W
Power factor	0.95
Inrush current	41 A
Leakage current (maximum)	3.5 mA
Phase	1

Table 28. Temperature requirements

Operating	Nonoperating
10 - 38°C (50 - 100.4°F)	1 - 60°C (33.8 - 140°F)

Table 29. Environment requirements

Environment	Operating	Nonoperating
Wet bulb temperature	23°C (73.4°F)	27°C (80.6°F)

Table 29. Environment requirements (continued)

Environment	Operating	Nonoperating
Maximum altitude	3048 m (10 000 ft)	3048 m (10 000 ft)

Table 30. Noise emissions

Properties	Operating	Idle
L_{WAd} (Category 2E, General business)	6.6 bels	6.3 bels
$\langle L_{pA} \rangle_m$	48 dB	46 dB
For a description of noise emission values, see Acoustics.		

Table 31. Service clearances

Front	Back	Sides	Top
762 mm (30 in.)	762 mm (30 in.)	762 mm (30 in.)	762 mm (30 in.)
Side and top clearances are optional when operating.			

Notes:

1. The 1.8 meter rack has six EIA units of space remaining. This space will be filled with a three-EIA filler panel and three of the one-EIA filler panels.
2. Only the 4.3 m (14 ft) power cord features are offered for racked 9406-270 systems. There are a total of four power cords that are routed through cable management arms. Also, there is a cable management device that might be used to restrict the length of the power cord exiting the bottom of the rack. See model 9406-270 Cable Poster Addendum included with the 0551 model 9406-270 rack.
3. The rack does not have power distribution. Each model 9406-270 and 7104 requires a power cord of sufficient length to reach the receptacle. The power cord feature codes for model 9406-270s must be used to determine the appropriate receptacles.

Model 0554 and 7014-S11 rack

Hardware specifications provide detailed information for your rack, including dimensions, electrical, power, temperature, environment, and service clearances.

Table 32. Dimensions

Dimension	Properties
Height	611 mm (24 in.)
Capacity	11 usable EIA units
Height with PDP - DC only	Not applicable
Width without side panels	Not applicable
Width with side panels	518 mm (20.4 in.)
Depth without doors	820 mm (32.3 in.)
Depth with front door	873 mm (34.4 in.)
Depth with sculptured style front door	Not applicable
Weight Base rack (empty)	36 kg (80 lb)
Weight Full rack ¹	218 kg (481 lb)

Table 33. Electrical

Electrical characteristics	Properties
DC rack voltage (nominal)	Not applicable

Table 33. Electrical (continued)

Electrical characteristics	Properties
Power source loading maximum in kVa	Not applicable
Voltage range (V dc)	Not applicable
AC rack	See your server or hardware specifications for specific requirements
Power source loading maximum in kVa (per PDU)	See your server or hardware specifications for specific requirements
Voltage range (V ac)	See your server or hardware specifications for specific requirements
Frequency (Hz)	50 or 60
The 7188 power distribution unit used with this rack is mounted horizontally and requires one EIA unit of space.	

Table 34. Service clearances

Front	Back	Sides
915 mm (36 in.)	254 mm (10 in.)	71 mm (2.8 in.)
Recommended minimum vertical service clearance from floor is 2439 mm (8 ft).		

See your server or hardware specifications for specific temperature requirements and humidity requirements.

Rack noise levels are a function of the number and type of drawers installed. See your server or hardware specifications for specific requirements.

Rack airflow requirements are a function of the number and type of drawers installed. Refer to the individual drawer specifications.

Note: Configuration dependent, base rack weight plus the weight of the drawers mounted in the rack. The rack can support up to a maximum weight of 15.9 kg (35 lb) per EIA unit.

Model 0554 and 7014-S11 rack operational clearances

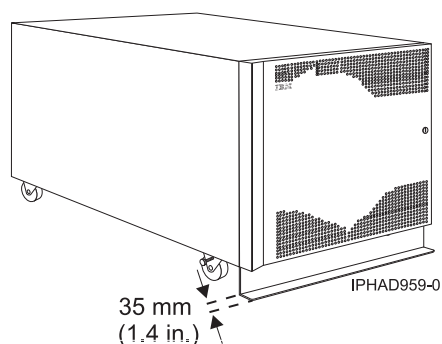

Figure 15. Model 0554 and 7014-S11 with stabilizer bar

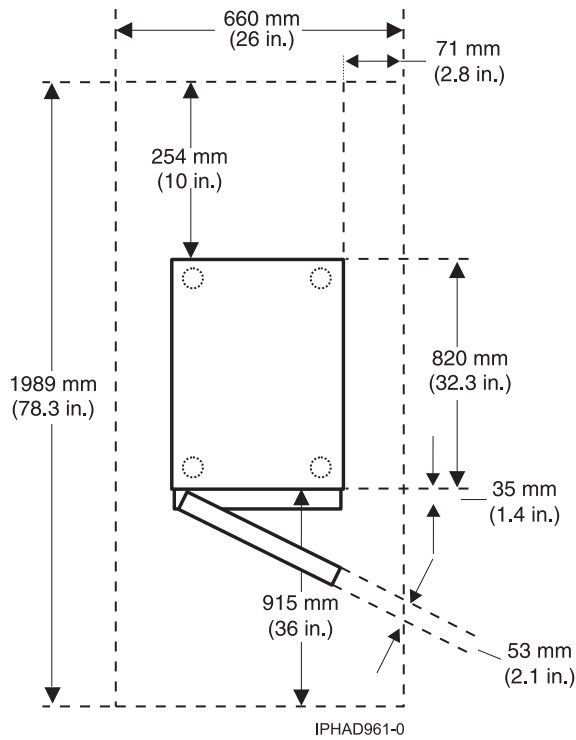

Figure 16. Model 0554 and 7014-S11 plan view

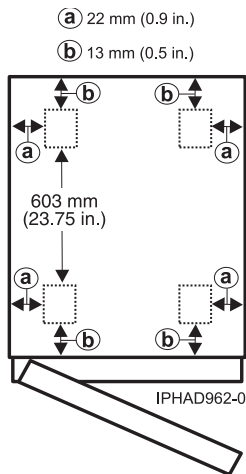

Figure 17. Model 0554 and 7014-S11 caster locations

Model 0555 and 7014-S25 rack

Hardware specifications provide detailed information for your rack, including dimensions, electrical, power, temperature, environment, and service clearances.

Table 35. Dimensions

Dimensions	Properties
Height	1240 mm (49 in.)
Capacity	25 usable EIA units
Height with PDP - DC only	Not applicable

Table 35. Dimensions (continued)

Dimensions	Properties
Width without side panels	590 mm (23.2 in.)
Width with side panels	610 mm (24 in.)
Depth with back door only	996 mm (39.2 in.)
Depth with back door and front door	1000 mm (39.4 in.)
Depth with sculptured style front door	Not applicable
Base rack (empty)	98 kg (217 lb)
Full rack ¹	665 kg (1467 lb)

Table 36. Electrical

Electrical characteristics	Properties
DC rack voltage (nominal)	Not applicable
Power source loading maximum in kVa	Not applicable
Voltage range (V dc)	Not applicable
AC rack	See your server or hardware specifications for specific requirements
Power source loading maximum in kVa (per PDU)	See your server or hardware specifications for specific requirements
Voltage range (V ac)	See your server or hardware specifications for specific requirements
Frequency (Hz)	50 or 60
The 7188 power distribution unit used with this rack is mounted horizontally and requires one EIA unit of space.	

Table 37. Service clearance

Front	Back	Sides
915 mm (36 in.)	760 mm (30 in.)	915 mm (36 in.)

See your server or hardware specifications for specific temperature and humidity requirements.

Rack noise levels are a function of the number and type of drawers installed. See your server or hardware specifications for specific requirements.

Rack airflow requirements are a function of the number and type of drawers installed. Refer to the individual drawer specifications.

Notes:

1. Configuration dependent, base rack weight plus the weight of the drawers mounted in the rack. The rack can support up to a maximum weight of 22.7 kg (50 lb) per EIA unit.
2. Recommended minimum vertical service clearance from floor is 2439 mm (8 ft).

Model 0555 and 7014-S25 rack operational clearances

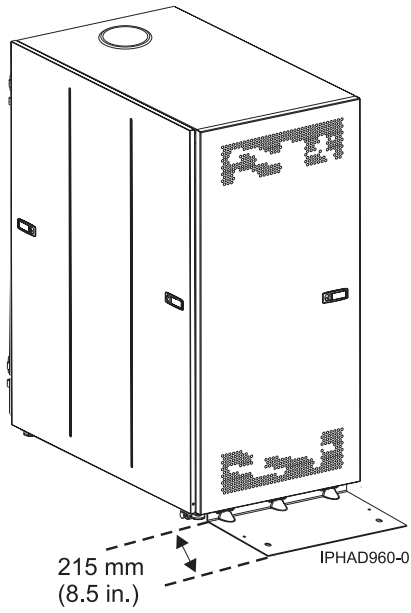

Figure 18. Model 0555 and 7014-S25 with stabilizer foot

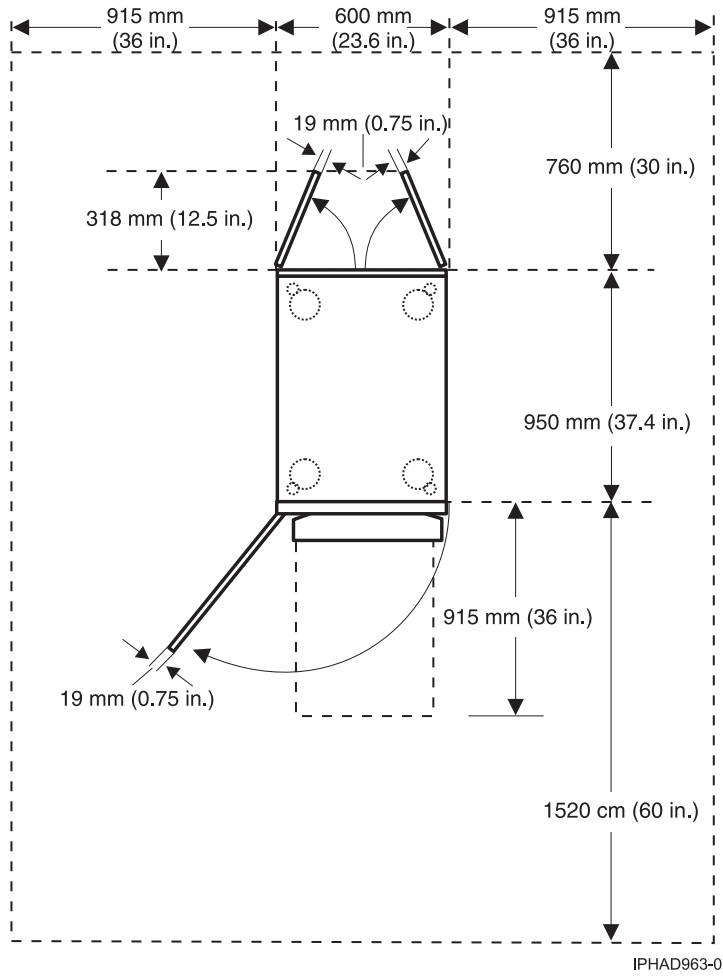

Figure 19. Model 0555 and 7014-S25 plan view

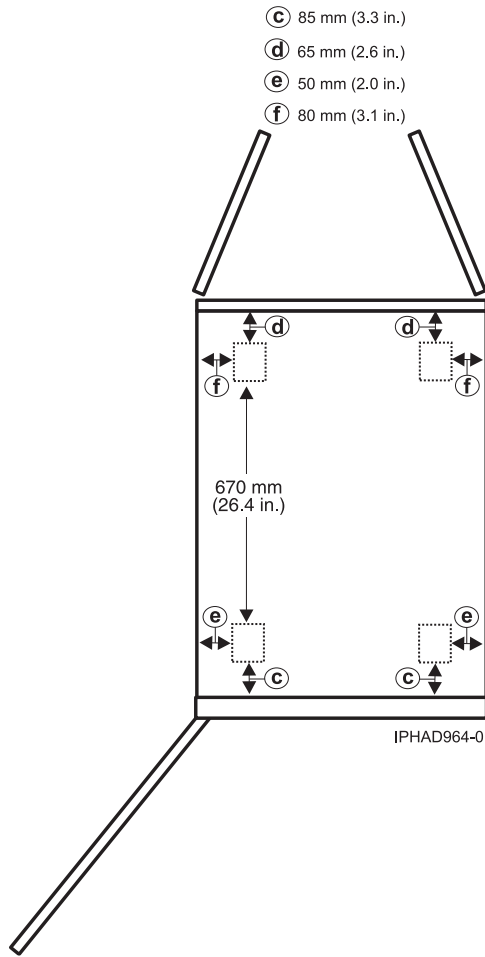

Figure 20. Model 0555 and 7014-S25 caster locations

Planning for the 7014-T00 and 7014-T42 racks

Rack specifications provide detailed information for your rack, including dimensions, electrical, power, temperature, environment, and service clearances.

Some products can have rack installation limitations. Refer to the specific server or product specifications for any restrictions.

The following provide specifications for the 7014-T00, and 7014-T42 or 0553 racks.

Model 7014-T00 rack:

Hardware specifications provide detailed information for your rack, including dimensions, electrical, power, temperature, environment, and service clearances.

Table 38. Dimensions for rack

Rack configuration	Width	Depth	Height	Weight (empty)	Weight (maximum configuration)	EIA unit capacity
Rack Only with side covers	644 mm (25.4 in.)	1016 mm (40.0 in.)	1804 mm (71.0 in.)	244 kg (535 lb)	816 kg (1795 lb) ¹	36 EIA units

Table 38. Dimensions for rack (continued)

Rack configuration	Width	Depth	Height	Weight (empty)	Weight (maximum configuration)	EIA unit capacity
Rack with standard rear door only	644 mm (25.4 in.)	1042 mm (41.0 in.)	1804 mm (71.0 in.)	254 kg (559 lb)	N/A	N/A
Rack with standard front and rear doors	644 mm (25.4 in.)	1100 mm (43.3 in.)	1804 mm (71.0 in.)	268 kg (590 lb)	N/A	N/A
Rack with FC 6101 OEM front door and standard rear door	644 mm (25.4 in.)	1100 mm (43.3 in.)	1804 mm (71.0 in.)	268 kg (590 lb)	N/A	N/A
Rack with FC 6068 high perforation front door and standard rear door	644 mm (25.4 in.)	1100 mm (43.3 in.)	1804 mm (71.0 in.)	268 kg (590 lb)	N/A	N/A
Rack with FC 6248 acoustic front and rear doors	644 mm (25.4 in.)	1413 mm (55.6 in.)	1804 mm (71.0 in.)	268 kg (589 lb)	N/A	N/A

¹ For more information about rack weight distribution and floor loading, see 7014-T00, 7014-T42, and 0553 rack weight distribution and floor loading.

Table 39. Dimensions for doors

Door model	Width	Height	Depth	Weight
Standard front door	639 mm (25.2 in.)	1740 mm (68.5 in.)	56 mm (2.3 in.)	14 kg (31 lb)
Standard rear door	639 mm (25.2 in.)	1740 mm (76.6 in.)	26 mm (1.0 in.)	11 kg (24 lb) With acoustic foam: 14 kg (31 lb)
Standard side covers	10 mm (0.4 in.) each	1740 mm (68.5 in.) each	1042 mm (41.0 in.) each	18 lbs 8.25 kg (18 lb) each
FC 6101 front door (OEM)	639 mm (25.2 in.)	1740 mm (68.5 in.)	56 mm (2.3 in.)	14 kg (31 lb)
FC 6068 front door, high perforation	639 mm (25.2 in.)	1740 mm (68.5 in.)	56 mm (2.3 in.)	14 kg (31 lb)
FC 6248 acoustic doors, front and rear	639 mm (25.2 in.) each	1740 mm (76.6 in.) each	198 mm (7.8 in.) each	12.3 kg (27 lb) each

See your individual server or hardware specifications for temperature and humidity requirements.

Rack noise levels are dependent on the number and type of drawers installed. See your server or hardware specifications for specific requirements.

Note: All rack installations require careful site and facilities planning designed to both address the cumulative drawer heat output and provide the airflow volume rates necessary to comply with drawer temperature requirements. All rack installations require careful site and facilities planning designed to

address both the cumulative drawer heat output and provide the airflow volume rates necessary to comply with drawer temperature requirements. Rack airflow requirements are dependent on the number and type of drawers installed.

Note: Acoustic doors are available for IBM racks. Feature code 6248 is available for the 0551 and 7014-T00 racks. Feature code 6249 is available for the 0553 and 7014-T42 racks. The overall sound reduction is approximately 6 dB. The doors add approximately 381 mm (15 in.) to the depth of the racks.

Related reference:

“7014-T00, 7014-T42, and 0553 rack weight distribution and floor loading” on page 35

Racks can be heavy when populated with several drawers. Use the Weight distribution distances for racks when loaded and Floor loading for racks when loaded tables to ensure proper floor loading and weight distribution.

Model 7014-T42, 7014-B42, and 0553 rack:

Hardware specifications provide detailed information for your rack, including dimensions, electrical, power, temperature, environment, and service clearances.

Table 40. Dimensions for rack

Rack configuration	Width	Depth	Height ¹	Weight (empty)	Weight (maximum configuration)	EIA unit capacity
Rack only with side covers	644 mm (25.4 in.)	1016 mm (40.0 in.)	2015 mm (79.3 in.)	261 kg (575 lb)	1597 kg (3521 lb) ² = (1336 kg + 261 kg)	42 EIA units
Rack with standard rear door only	644 mm (25.4 in.)	1042 mm (41.0 in.)	2015 mm (79.3 in.)	273 kg (602 lb)	N/A	N/A
Rack with standard front and rear doors	644 mm (25.4 in.)	1098 mm (43.3 in.)	2015 mm (79.3 in.)	289 kg (636 lb)	N/A	N/A
Rack with FC 6084 OEM front door and standard rear door	644 mm (25.4 in.)	1098 mm (43.3 in.)	2015 mm (79.3 in.)	289 kg (636 lb)	N/A	N/A
Rack with FC 6069 high perforation front door and standard rear door	644 mm (25.4 in.)	1098 mm (43.3 in.)	2015 mm (79.3 in.)	289 kg (636 lb)	N/A	N/A
Rack with FC ERG7 770/780 high perforation front door and standard rear door	644 mm (25.4 in.)	1176 mm (46.3 in.)	2015 mm (79.3 in.)	290 kg (639 lb)	N/A	N/A
Rack with FC 6249 acoustic front and rear doors	644 mm (25.4 in.)	1413 mm (55.6 in.)	2015 mm (79.3 in.)	289 kg (635 lb)	N/A	N/A

Table 40. Dimensions for rack (continued)

Rack configuration	Width	Depth	Height ¹	Weight (empty)	Weight (maximum configuration)	EIA unit capacity
Rack with FC 6250 high end appearance front door and standard rear door	644 mm (25.4 in.)	1131 mm (44.5 in.)	2015 mm (79.3 in.)		N/A	N/A
Rack with FC ERGB acoustic front door and standard rear door	644 mm (25.4 in.)	1240 mm (48.8 in.)	2015 mm (79.3 in.)	285 kg (627 lb)	N/A	N/A
Rack with FC 6858 heat exchanger rear door and standard front door	644 mm (25.4 in.)	1222 mm (48.1 in.)	2015 mm (79.3 in.)	Empty: 306 kg (675 lb) Full: 312 kg (688 lb)	N/A	N/A
Rack with FC ERG0 rack extension and standard front and rear doors	644 mm (25.4 in.)	1303 mm (51.3 in.)	2015 mm (79.3 in.)	315 kg (694 lb)	N/A	N/A
Notes:						
<p>1. The top 6U of the rack can be temporarily detached at the client site to make it easier to move the rack through doors or elevators. The top 6U is then reattached to the rack frame to provide the full 42U rack capacity. The rack is approximately 28 cm (11 in.) shorter when the top is removed. For more information about removing the top cover, see Removing the rack top cover. The weight of the top cover is approximately 29 kg (63 lbs).</p> <p>2. For more information about rack weight distribution and floor loading, see 7014-T00, 7014-T42, and 0553 rack weight distribution and floor loading.</p>						

Table 41. Dimensions for doors

Door model	Width	Height	Depth	Weight
Standard front door	639 mm (25.2 in.)	1946 mm (76.6 in.)	56 mm (2.3 in.)	16 kg (34 lb)
Standard rear door	639 mm (25.2 in.)	1946 mm (76.6 in.)	26 mm (1.0 in.)	13 kg (27 lb) With acoustic foam: 16 kg (34 lb)
Standard side covers (each)	10 mm (.4 in.)	1740 mm (68.5 in.)	1042 mm (41.0 in.)	18 lbs 8.25 kg(18 lb)
FC 6084 front door (OEM)	639 mm (25.2 in.)	1946 mm (76.6 in.)	56 mm (2.3 in.)	16 kg (34 lb)
FC 6069 front door, high perforation	639 mm (25.2 in.)	1946 mm (76.6 in.)	56 mm (2.3 in.)	16 kg (34 lb)
FC ERG7 front door 770/780 high perforation	639 mm (25.2 in.)	1946 mm (76.6 in.)	134 mm (5.3 in.)	17 kg (37 lb)
FC 6249 acoustic doors, front and rear	639 mm (25.2 in.) each	1946 mm (76.6 in.) each	198 mm (7.8 in.) each	13.6 kg (30 lb) each

Table 41. Dimensions for doors (continued)

Door model	Width	Height	Depth	Weight
FC 6250 high end appearance front door	639 mm (25.2 in.) each	1946 mm (76.6 in.) each	90 mm (3.5 in.)	
FC ERGB acoustic door, front only	639 mm (25.2 in.)	1946 mm (76.6 in.)	198 mm (7.8 in.)	13.6 kg (30 lb)
FC 6238 high end appearance side covers	10 mm (.4 in.)	1740 mm (68.5 in.)	1042 mm (41.0 in.)	8.5 kg (18 lb)
FC 6858 heat exchanger rear door	639 mm (25.2 in.)	1946 mm (76.6 in.)	147 mm (5.8 in.)	Empty: 29.9 kg (66 lb) Full: 35.6 kg (78.5 lb)
FC ERG0 8-inch rack extension	647 mm (25.4 in.)	1957 mm (77.1 in.)	203 mm (8.0 in.)	27 kg (58.0 lb)
FC ERG8 ballast weight specify code ¹	N/A	N/A	N/A	52.1 kg (115 lb)
¹ When model 9080-MHE, 9080-MME, 9119-MHE, and 9119-MME servers are ordered with FC ER16 to reserve rack space for future system nodes, FC ERG8 is automatically added to the order.				

Table 42. Electrical¹

Electrical characteristics	Properties
Power source loading maximum in kVA	For more information about rack power distribution units and power cord options, see Power distribution unit and power cord options for 7014, 0551, 0553, and 0555 racks.
¹ The total rack power can be derived from the sum of the power that is used by the drawers in the rack.	

See your individual server or hardware specifications for temperature and humidity requirements.

Rack noise levels depend on the number and type of drawers installed. See your server or hardware specifications for specific requirements.

Note: All rack installations require careful site and facilities planning that is designed to both address the cumulative drawer heat output and provide the airflow volume rates necessary to comply with drawer temperature requirements. All rack installations require careful site and facilities planning that is designed to address both the cumulative drawer heat output and provide the airflow volume rates necessary to comply with drawer temperature requirements. Rack airflow requirements depend on the number and type of drawers installed.

Note: Acoustic doors are available for IBM racks. Feature code 6248 is available for the 0551 and 7014-T00 racks. Feature code 6249 is available for the 0553 and 7014-T42 racks. The overall sound reduction is approximately 6 dB. The doors add approximately 381 mm (15 in.) to the depth of the racks.

Service clearances

Table 43. Service clearances for 7014-T00, 7014-T42, and 0553 racks

Front	Rear	Sides
915 mm (36 in.)	915 mm (36 in.)	915 mm (36 in.)
Note: Recommended minimum vertical service clearance from the floor is 2439 mm (8 ft).		

Figure 21 provides the caster and leveler locations for 7014-T00, 7014-T42, 0551, 0553, and 0555 racks.

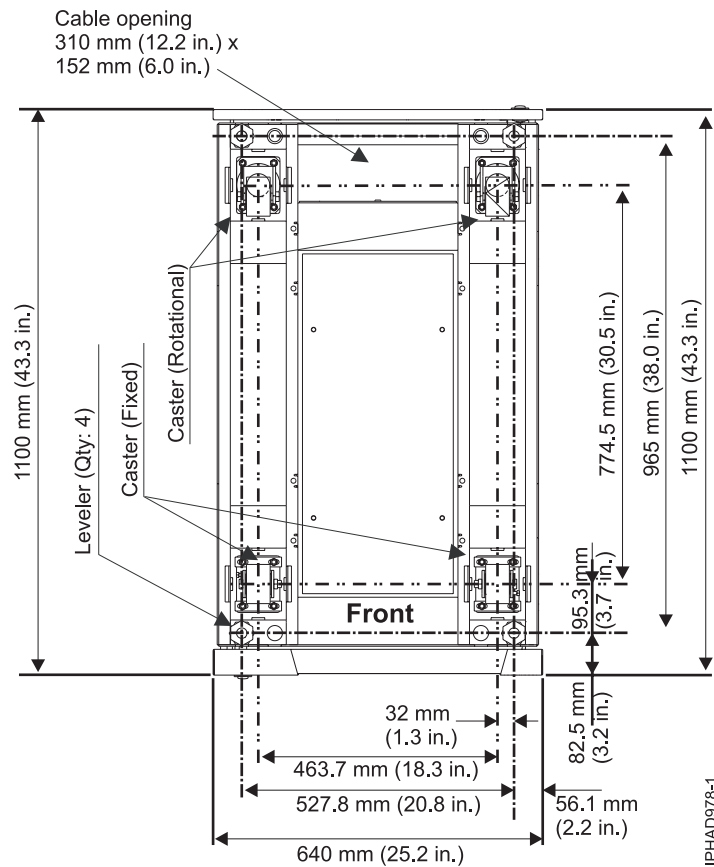

Figure 21. Caster and leveler locations

Note: Rack units are large and heavy and are not easily moved. As maintenance activities require access at both the front and the back, extra room is needed. The footprint illustration does not show the radius of the swinging doors on the I/O rack. A service clearance of 915 mm (36 in.) needs to be maintained on front, rear, and sides of the I/O rack.

Related reference:

“7014-T00, 7014-T42, and 0553 rack weight distribution and floor loading” on page 35

Racks can be heavy when populated with several drawers. Use the Weight distribution distances for racks when loaded and Floor loading for racks when loaded tables to ensure proper floor loading and weight distribution.

7014-T00, 7014-T42, and 0553 supported feature codes:

Learn about the supported feature codes that are available for 7014-T00, 7014-T42 and 0553 racks.

Feature code (FC) ERG0

FC ERG0 is an optional rear rack extender that can be used for 7014-T42 racks. This extender is installed on the rear of the 7014-T42 rack and provides 20.3 cm (8 in.) of extra space to hold cables on the side of the rack and to keep the center area clear for cooling and service access.

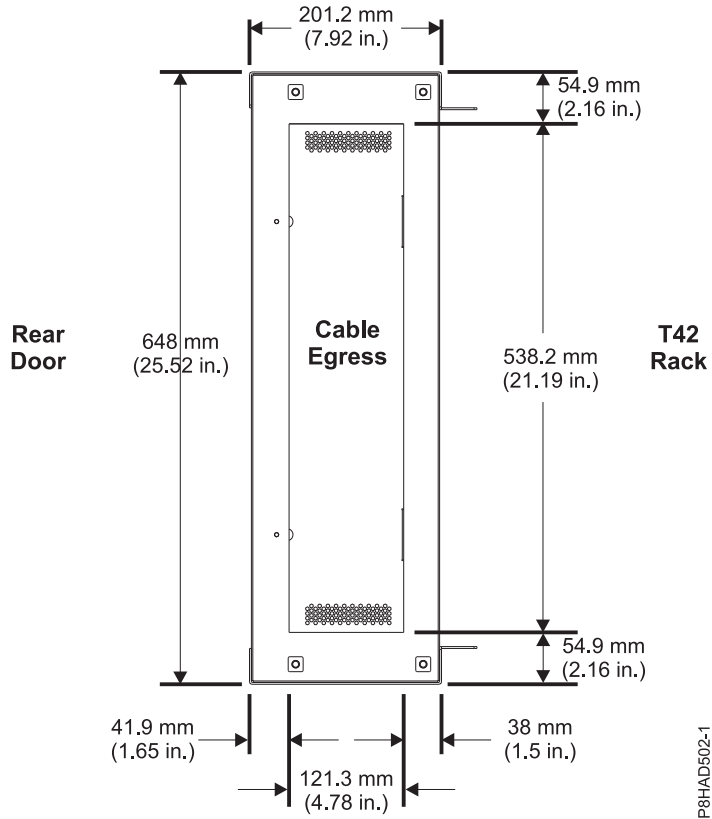

Figure 22. FC ERG0 rear rack extender (top-down view)

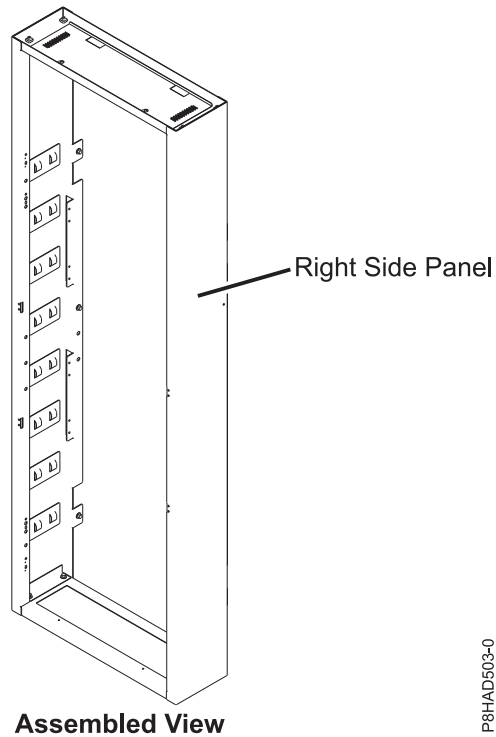

Figure 23. FC ERG0 assembled view

FC 6080

FC 6080 is an optional rack feature that provides extra hardware that reinforces the rack and anchors it to the floor. The feature provides enhanced rigidity and stability of the rack. This feature includes a large steel brace or truss that bolts into the rear of the rack. It is hinged on the left side (when looking at the rear of the rack) and can swing out of the way for easy access to the rack drawers when necessary. This feature also includes hardware for bolting the rack to a concrete floor or a similar surface and bolt-in steel filler panels for any unoccupied spaces in the rack.

Notes:

1. If FC 6080 is installed, a tool is required to remove the bolt to secure the side cover to the rack.
2. FC 6080 is not supported on 9080-MHE, 9080-MME, 9119-MHE, and 9119-MME systems due to the lack of cable space near the braces. Instead, you can use FC ERGC for these systems.
3. FC ERG0 (rear rack extender) cannot be used with FC 6080.

7014-T00, 7014-T42, and 0553 racks multiple attachment:

7014-T00, 7014-T42 or 0553 racks can be bolted together in a multiple rack arrangement. This figure shows that arrangement.

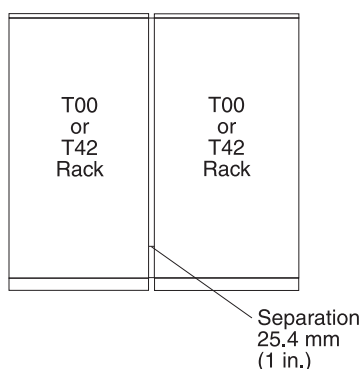

A kit is available including the bolts, spacers, and decorative trim pieces to cover the 25.4 mm (1 in.) space. For service clearances, see the service clearances as shown in the table for the model 7014-T00 rack.

Related reference:

“Model 7014-T00 rack” on page 28

Hardware specifications provide detailed information for your rack, including dimensions, electrical, power, temperature, environment, and service clearances.

7014-T00, 7014-T42, and 0553 rack weight distribution and floor loading:

Racks can be heavy when populated with several drawers. Use the Weight distribution distances for racks when loaded and Floor loading for racks when loaded tables to ensure proper floor loading and weight distribution.

The 7014-T00, 7014-T42, and 0553 racks can be extremely heavy when several drawers are present. The following table shows the necessary weight distribution distances for the 7014-T00, 7014-T42, and 0553 racks when loaded.

Table 44. Weight distribution distances for racks when loaded

Rack	System weight ¹	Width ²	Depth ²	Weight distribution distance ³	
				Front and back	Left and right
7014-T00 ⁴	816 kg (1795 lb)	623 mm (24.5 in)	1021 mm (40.2 in)	515.6 mm (20.3 in), 477.5 mm (18.8 in)	467.4 mm (18.4 in)
7014-T00 ⁵	816 kg (1795 lb)	623 mm (24.5 in)	1021 mm (40.2 in)	515.6 mm (20.3 in), 477.5 mm (18.8 in)	0
7014-T00 ⁶	816 kg (1795 lb)	623 mm (24.5 in)	1021 mm (40.2 in)	515.6 mm (20.3 in), 477.5 mm (18.8 in)	559 mm (22 in)
7014-T42 and 0553 ⁴	930 kg (2045 lb)	623 mm (24.5 in)	1021 mm (40.2 in)	515.6 mm (20.3 in), 477.5 mm (18.8 in)	467.4 mm (18.4 in)
7014-T42 and 0553 ⁵	930 kg (2045 lb)	623 mm (24.5 in)	1021 mm (40.2 in)	515.6 mm (20.3 in), 477.5 mm (18.8 in)	0
7014-T42 and 0553 ⁶	930 kg (2045 lb)	623 mm (24.5 in)	1021 mm (40.2 in)	515.6 mm (20.3 in), 477.5 mm (18.8 in)	686 mm (27 in)

Notes:

1. Maximum weight of fully populated rack, units are lb with kg in parentheses.
2. Dimensions without covers, units are mm with inches in parentheses.
3. The weight distribution distance in all four directions is the area around the rack perimeter (minus covers) necessary to distribute the weight beyond the perimeter of the rack. Weight distribution areas cannot overlap with adjacent computer equipment weight distribution areas. Units are inches with mm in parentheses.
4. Weight distribution distance is 1/2 the service clearance values shown in the figure plus cover thickness.
5. No left and right weight distribution distance.
6. Left and right weight distribution distance required for a 70 lb/ft² raised floor loading objective.

The following table shows the necessary floor loading for the 7014-T00, 7014-T42 and 0553 racks when loaded.

Table 45. Floor loading for racks when loaded

Rack	Floor loading			
	Raised kg/m ¹	Non-raised kg/m ¹	Raised lb/ft ¹	Non-raised lb/ft ¹
7014-T00 ²	366.7	322.7	75	66
7014-T00 ³	734.5	690.6	150.4	141.4
7014-T00 ⁴	341	297	70	61
7014-T42 and 0553 ²	403	359	82.5	73.5
7014-T42 and 0553 ³	825	781	169	160
7014-T42 and 0553 ⁴	341.4	297.5	70	61

Notes:

1. Dimensions without covers, units are mm with inches in parentheses.
2. Weight distribution distance is 1/2 the service clearance values shown in the figure plus cover thickness.
3. No left and right weight distribution distance.
4. Left and right weight distribution distance required for a 70 lb/ft² raised floor loading objective.

Related reference:

“Model 7014-T42, 7014-B42, and 0553 rack” on page 30

Hardware specifications provide detailed information for your rack, including dimensions, electrical, power, temperature, environment, and service clearances.

“Model 7014-T00 rack” on page 28

Hardware specifications provide detailed information for your rack, including dimensions, electrical, power, temperature, environment, and service clearances.

Planning for the 7953-94X and 7965-94Y rack

Rack specifications provide detailed information for your rack, including dimensions, electrical, power, temperature, environment, and service clearances.

The following provide specifications for the 7953-94X and 7965-94Y rack.

Model 7953-94X and 7965-94Y rack:

Hardware specifications provide detailed information for your rack, including dimensions, electrical, power, temperature, environment, and service clearances.

Table 46. Dimensions for rack

	Width	Depth	Height	Weight (Empty)	Weight (Maximum configuration)	EIA unit capacity
Rack only	600 mm (23.6 in.)	1039 mm (40.9 in.)	2002 mm (78.8 in.)	130 kg (287 lb)	1140 kg (2512 lb)	42 EIA units
Rack with standard doors	600 mm (23.6 in.)	1095 mm (43.1 in.)	2002 mm (78.8 in.)	138 kg (304 lb)	N/A	N/A
Rack with triplex doors	600 mm (23.6 in.)	1206.2 - 1228.8 mm (47.5 - 48.4 in.)	2002 mm (78.8 in.)	147 kg (324 lb)	N/A	N/A
Rack with rear door heat exchanger indicator	600 mm (23.6 in.)	1196 mm (47.1 in.)	2002 mm (78.8 in.)	169 kg (373 lb)	N/A	N/A

Note: When the rack is delivered or is moved, outriggers are needed for stability. For more information about outriggers, see “Side stabilizing outriggers” on page 41.

Table 47. Dimensions for doors

Door model	Width	Height	Depth	Weight
Standard front door (FC EC01) and standard back door (FC EC02)	597 mm (23.5 in.)	1925 mm (75.8 in.)	22.5 mm (0.9 in.)	7.7 kg (17 lb)
Triplex door (FC EU21) ³	597.1 mm (23.5 in.)	1923.6 mm (75.7 in.)	105.7 mm (4.2 in.) ¹ 128.3 mm (5.2 in.) ²	16.8 kg (37 lb)

¹ Measured from the front flat surface of the door.

² Measured from the IBM logo on the front of the door.

³ Multiple racks that are placed side-by-side must have a 6 mm (0.24 in.) minimum clearance between racks to allow the triplex front door to hinge properly. Feature code EC04 (Rack suite attachment kit) can be used to maintain the 6 mm (0.24 in.) minimum clearance between racks.

Table 48. Dimensions for side covers¹

Depth	Height	Weight
885 mm (34.9 in.)	1870 mm (73.6 in.)	17.7 kg (39 lb)
¹ Side covers do not increase the overall width of the rack.		

Table 49. Temperature requirements

Operating	Nonoperating
10°C - 38°C (50°F - 100.4°F) ¹	-40°C to 60°C (-40°F to 140°F)
¹ The maximum 38°C (100.4°F) temperature must be derated 1°C (1.8 °F) per 137 m (450 ft) above 1295 m (4250 ft).	

Table 50. Environmental requirements

Environment	Operating	Nonoperating	Maximum altitude
Noncondensing humidity	20% - 80% (allowable)	8% - 80% (including condensing)	2134 m (7000 ft) above sea level
	40% - 55% (recommended)		
Wet bulb temperature	21°C (69.8°F)	27°C (80.6°F)	

Table 51. Service clearances

Front	Back	Side ¹
915 mm (36 in.)	915 mm (36 in.)	610 mm (24 in.)
¹ Side service clearance is only required when outriggers are on the rack. Side service clearance is not required during normal operation of the rack when outriggers are not installed.		

Rear door heat exchanger

Specifications for Power orderable feature code (FC): EC05 - Rear door heat exchanger indicator (Model 1164-95X).

Table 52. Dimensions for rear door heat exchanger

Width	Depth	Height	Weight (empty)	Weight (filled)
600 mm (23.6 in.)	129 mm (5.0 in.)	1950 mm (76.8 in.)	39 kg (85 lb)	48 kg (105 lb)
For more information, see "Model 1164-95X rear door heat exchanger" on page 43.				

Electrical

For electrical requirements, see Power distribution unit and power cord options.

Features

The 7953-94X and 7965-94Y rack has the following features available for use:

- Recirculation prevention plate that is installed at the bottom, front of the rack.
- Stabilizer bracket that is installed at the front of the rack.

Caster locations

The following diagram provides the caster locations for the 7953-94X and 7965-94Y rack.

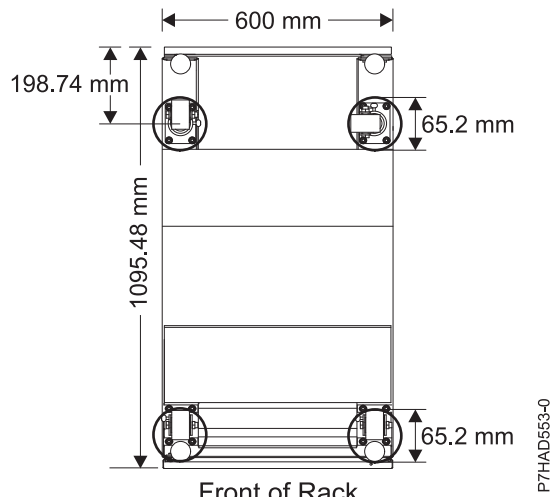

Figure 24. Caster locations

Cabling the 7953-94X and 7965-94Y rack:

Learn about the different cable routing options available for the 7953-94X and 7965-94Y rack.

Cabling within the rack

Side cable channels are available in the rack to route cables. There are two cable channels on each side of the rack as shown in Figure 25 on page 40.

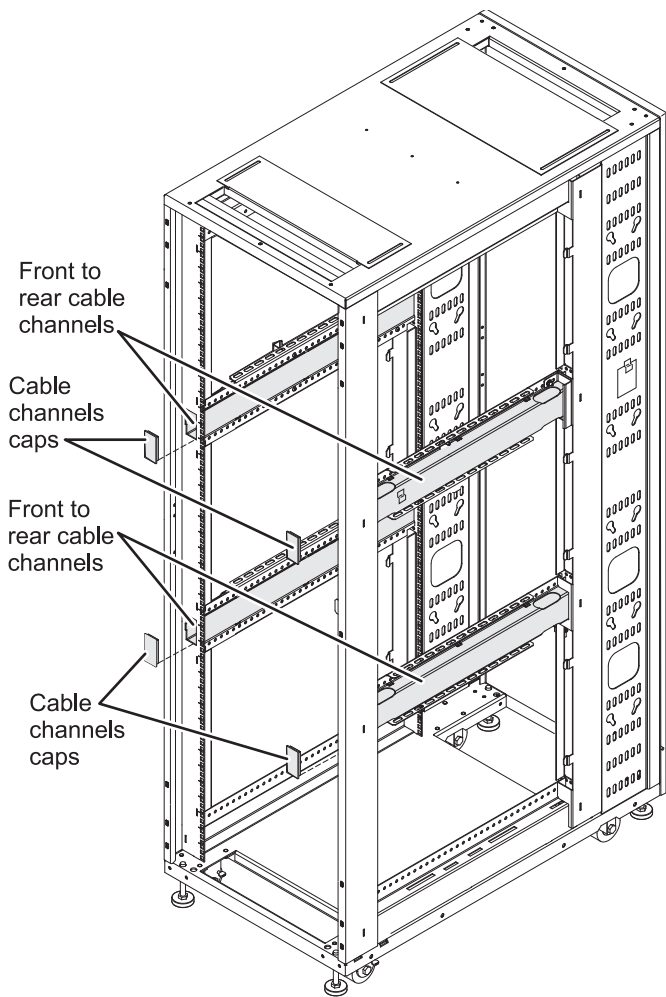

Figure 25. Cabling within the rack

Cabling under the floor

A cable access bar located on the bottom rear of the rack helps to route the cables, leaving the rack in place. This bar can be removed for installation and then reattached after the rack is installed and cabled.

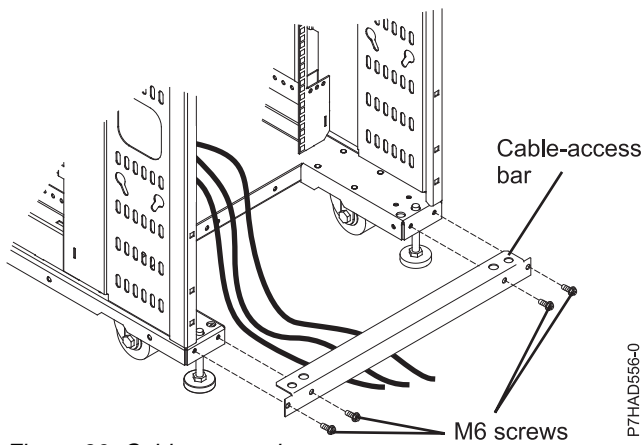

Figure 26. Cable access bar

Cabling overhead

Front and rear rectangular cable access openings located on the top of the rack cabinet allow cables to be routed up and out of the rack. Cable access covers are adjustable by loosening the side screws and sliding the covers forward or backward.

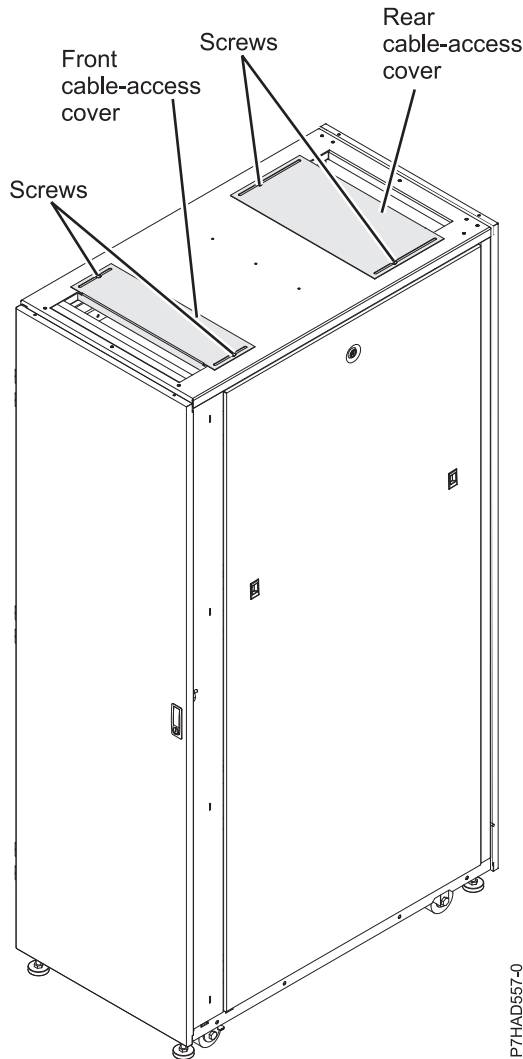

Figure 27. Cable access covers

Side stabilizing outriggers:

Learn about the side stabilizing outriggers available for the 7953-94X and 7965-94Y rack.

The outriggers are stabilizers with wheels installed on the sides of the rack cabinet. The outriggers can be removed only after the rack is in the final location and will not be moved more than 2 m (6 ft) away in any direction.

To remove the outriggers, use a 6 mm hex wrench to remove the four bolts that attach each outrigger to the rack cabinet.

Keep each of the outriggers and bolts in a safe place for future use when moving the rack. Reinstall the outriggers to move the rack cabinet to another location that is greater than 2 m (6 ft) away from its current location.

Table 53. Dimensions for rack with outriggers

Width	Depth	Height	Weight	EIA unit capacity
780 mm (30.7 in.)	1095 mm (43.1 in.)	2002 mm (78.8 in.)	261 kg (575 lb)	42 EIA units

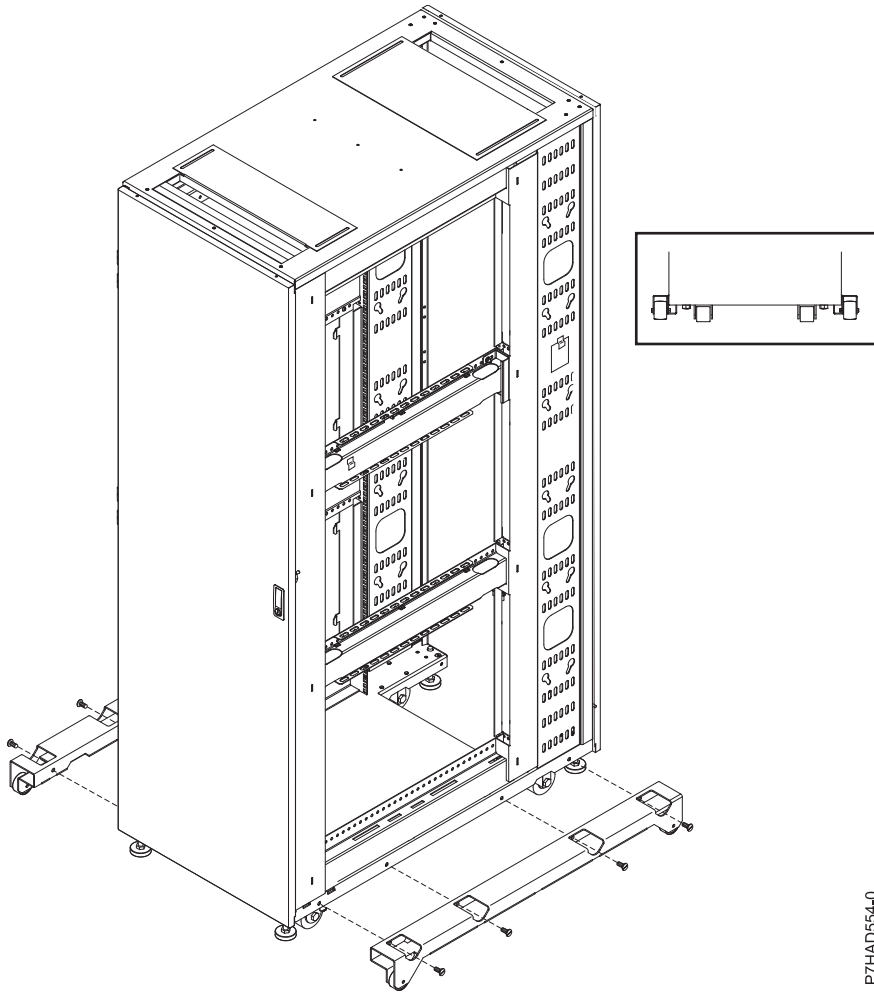

Figure 28. Outrigger locations

P7HAD554-0

Multiple racks:

Learn how to attach multiple 7953-94X and 7965-94Y racks together.

Multiple 7953-94X and 7965-94Y racks can be attached together via attachment brackets connecting the units at the front of the rack. See Figure 29 on page 43.

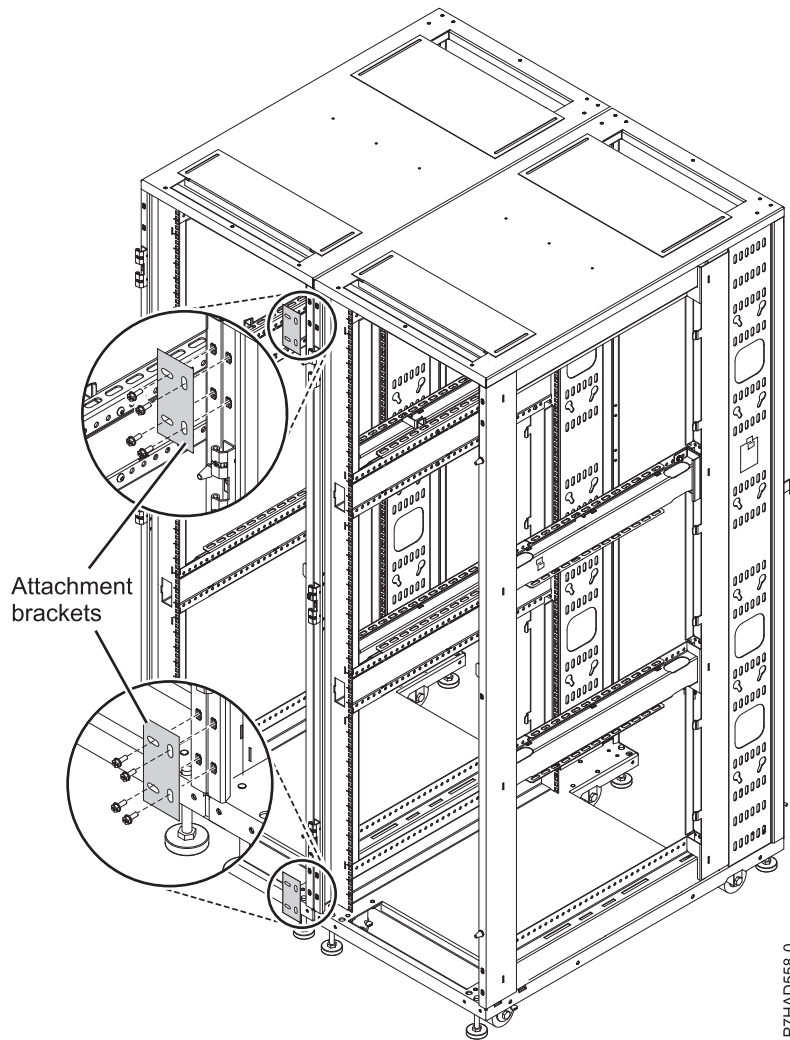

Figure 29. Attachment brackets

Model 1164-95X rear door heat exchanger:

Learn about the specifications of the 1164-95X rear door heat exchanger (feature code EC05).

Model 1164-95X rear door heat exchanger specifications

Table 54. Dimensions for the 1164-95X rear door heat exchanger

Width ¹	Depth	Height	Weight (empty)	Weight (filled)
600 mm (23.6 in.)	129 mm (5.0 in.)	1950 mm (76.8 in.)	39 kg (85.0 lb)	48 kg (105.0 lb)
1. The width is the inside width of the machine when installed in the U space of the rack. The width of the front bezel is 482 mm (19.0 in.).				

Water specifications

- Pressure
 - Normal operation: <137.93 kPa (20 psi)
 - Maximum: 689.66 kPa (100 psi)
- Volume
 - Approximately 9 liters (2.4 gallons)
- Temperature

- Water temperature must be above the dew point in the data center
- 18°C ± 1°C (64.4°F ± 1.8°F) for ASHRAE Class 1 Environment
- 22°C ± 1°C (71.6°F ± 1.8°F) for ASHRAE Class 2 Environment
- Required water flow rate (as measured from the supply entrance to the heat exchanger)
 - Minimum: 22.7 liters (6 gallons) per minute
 - Maximum: 56.8 liters (15 gallons) per minute

Heat exchanger performance

A heat removal of 100% indicates that an amount of heat that is equivalent to that generated by the devices has been removed by the heat exchanger and the average air temperature leaving the heat exchanger is identical to that entering the rack (27°C (80.6°F) in this example). Heat removal in excess of 100% indicates that the heat exchanger not only removed all of the heat that was generated by the devices, but further cooled the air so that the average air temperature that is leaving the rack is actually lower than air temperature that is entering the rack.

To help maintain optimum performance of the rear door heat exchanger and provide proper cooling for all rack components, you must take the following precautions:

- Install filler panels over all unoccupied bays.
- Route signal cables at the rear of the rack so that they enter or exit the cabinet through the top and bottom air baffles.
- Bundle signal cables together in a rectangle so that the upper and lower air-baffle sliders are closed as far as possible. Do not bundle signal cables together in a circular formation.

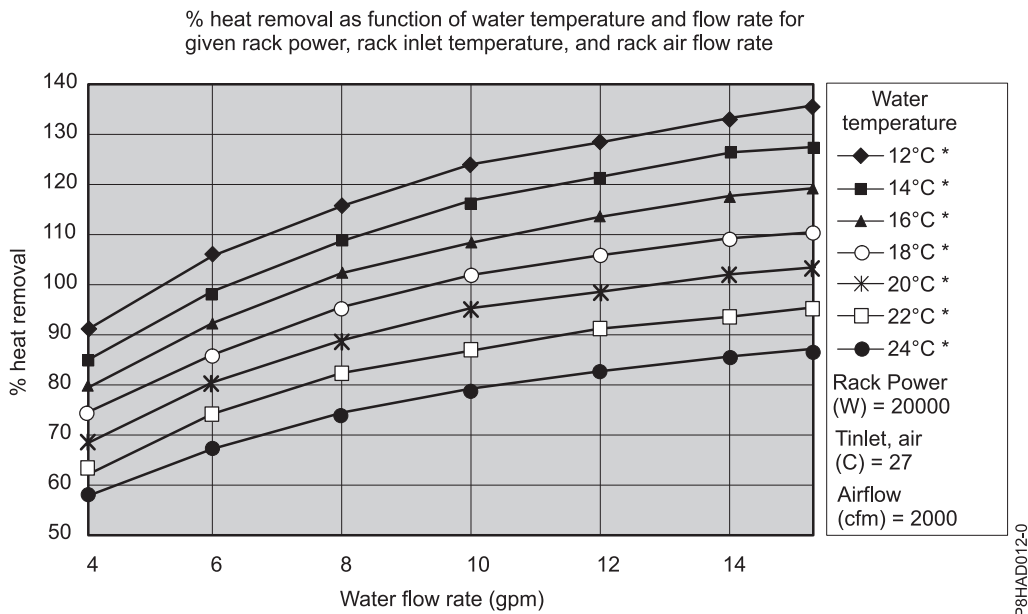

Figure 30. Typical performance of the heat exchanger, 20 kW heat load

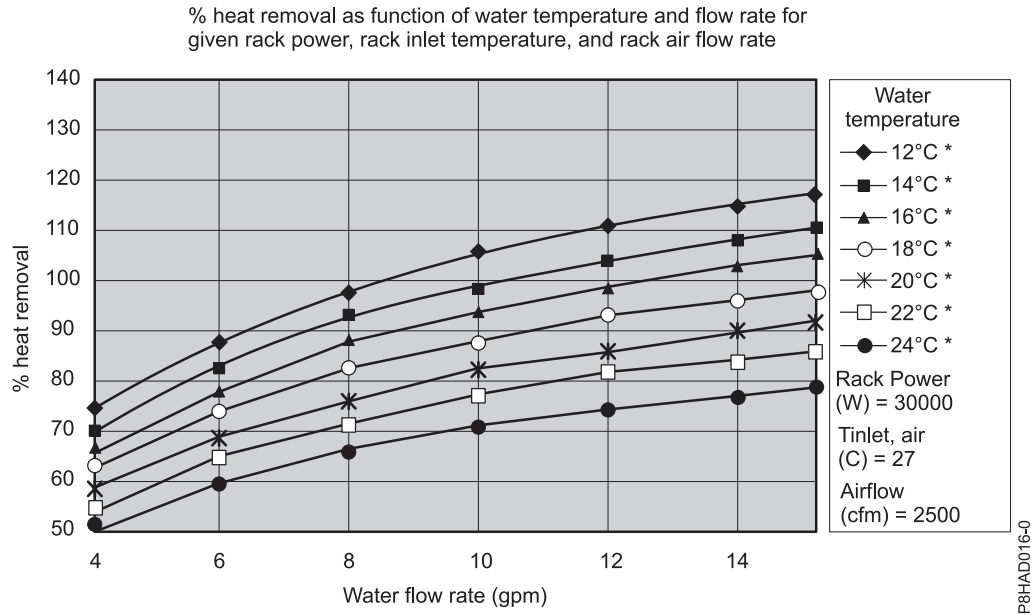

Figure 31. Typical performance of the heat exchanger, 30 kW heat load

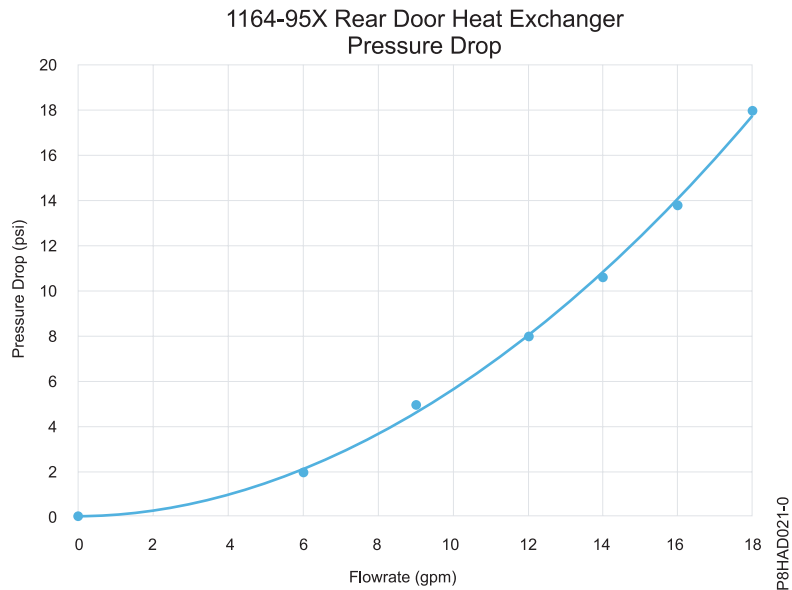

Figure 32. Pressure drop (standard units)

Water specifications for the secondary cooling loop

Important: The water that is being supplied to the heat exchanger must meet the requirements that are described in this section. Otherwise, system failures might occur over time as a result of any of the following problems:

- Leaks due to corrosion and pitting of the metal components of the heat exchanger or of the water-supply system.
- Buildup of scale deposits inside the heat exchanger, which can cause the following problems:
 - A reduction in the ability of the heat exchanger to cool the air that is exhausted from the rack

- Failure of mechanical hardware, such as a hose quick-connect coupling
- Organic contamination, such as bacteria, fungi, or algae. This contamination can cause the same problems as described for scale deposits.

Contact a water quality and water distribution services expert for designing and implementing the infrastructure and water chemistry of the secondary loop.

Control and conditioning of the secondary cooling loop

The water that is used to fill, refill, and supply the heat exchanger must be particle-free deionized water or particle-free distilled water with appropriate controls for avoiding the following problems:

- Metal corrosion
- Bacterial fouling
- Scaling

The water cannot originate from the primary chilled-water system for the building but must be supplied as part of a secondary closed-loop system.

Important: Do not use glycol solutions because they can adversely affect the cooling performance of the heat exchanger.

Materials to use in secondary loops

You can use any of the following materials in supply lines, connectors, manifolds, pumps and any other hardware that makes up the closed-loop water-supply system at your location:

- Copper v brass with less than 30% zinc content
- Brass with less than 30% zinc content
- Stainless steel 303 or 316
- Peroxide cured ethylene propylene diene monomer (EPDM) rubber, non-metal-oxide material

Materials to avoid in secondary loops

Do not use any of the following materials in any part of your water-supply system:

- Oxidizing biocides, such as chlorine, bromine, and chlorine dioxide
- Aluminum
- Brass with greater than 30% zinc
- Irons (nonstainless steel)

Model 1164-95X rear door heat exchanger water cooling specifications and requirements:

Learn about the specifications and requirements for the water cooling of the 1164-95X rear door heat exchanger (feature code EC05).

Water specifications for the secondary cooling loop

Important: The water that is being supplied to the heat exchanger must meet the requirements that are described at: “Model 1164-95X rear door heat exchanger” on page 43. Otherwise, system failures might occur over time as a result of any of the following problems:

- Leaks due to corrosion and pitting of the metal components of the heat exchanger or of the water-supply system.
- Buildup of scale deposits inside the heat exchanger, which can cause the following problems:
 - A reduction in the ability of the heat exchanger to cool the air that is exhausted from the rack

- Failure of mechanical hardware, such as a hose quick-connect coupling
- Organic contamination, such as bacteria, fungi, or algae. This contamination can cause the same problems as described for scale deposits.

Contact a water quality and water distribution services expert for designing and implementing the infrastructure and water chemistry of the secondary loop.

Control and conditioning of the secondary cooling loop

The water that is used to fill, refill, and supply the heat exchanger must be particle-free deionized water or particle-free distilled water with appropriate controls for avoiding the following problems:

- Metal corrosion
- Bacterial fouling
- Scaling

The water cannot originate from the primary chilled-water system for the building but must be supplied as part of a secondary closed-loop system.

Important: Do not use glycol solutions because they can adversely affect the cooling performance of the heat exchanger.

Materials to use in secondary loops

You can use any of the following materials in supply lines, connectors, manifolds, pumps, and any other hardware that makes up the closed-loop water-supply system at your location:

- Copper v brass with less than 30% zinc content
- Brass with less than 30% zinc content
- Stainless steel 303 or 316
- Peroxide cured ethylene propylene diene monomer (EPDM) rubber, non-metal-oxide material

Materials to avoid in secondary loops

Do not use any of the following materials in any part of your water-supply system:

- Oxidizing biocides, such as chlorine, bromine, and chlorine dioxide
- Aluminum
- Brass with greater than 30% zinc
- Irons (nonstainless steel)

Water-supply requirements for secondary loops

Learn about the specific characteristics of the system that supplies the chilled conditioned water to the heat exchanger.

Temperature:

The heat exchanger and its supply hose and return hoses are not insulated. Avoid any condition that might cause condensation. The temperature of the water inside the supply hose, return hose, and heat exchanger must be kept above the dew point of the location where the heat exchanger is being used.

Attention: Typical primary chilled water is too cold for use in this application because building chilled water can be as cold as 4°C - 6°C (39°F - 43°F).

Important:

The system that supplies the cooling water must be able to measure the room dew point and automatically adjust the water temperature accordingly. Otherwise, the water temperature must be above the maximum dew point for that data center installation. For example, the following minimum water temperature must be maintained:

- 18°C plus or minus 1°C (64.4°F plus or minus 1.8°F). This specification is applicable within an ASHRAE Class 1 Environmental Specification that requires a maximum dew point of 17°C (62.6°F).
- 22°C plus or minus 1°C (71.6°F plus or minus 1.8°F). This specification is applicable within an ASHRAE Class 2 Environmental Specification that requires a maximum dew point of 21°C (69.8°F).

See the ASHRAE document *Thermal Guidelines for Data Processing Environments*.

Pressure:

The water pressure in the secondary loop must be less than 690 kPa (100 psi). Normal operating pressure at the heat exchanger must be 414 kPa (60 psi) or less.

Flow rate:

The flow rate of the water in the system must be in the range of 23 - 57 liters (6 - 15 gallons) per minute.

Pressure drop versus flow rate for heat exchangers (including quick-connect couplings) is defined as approximately 103 kPa (15 psi) at 57 liters (15 gallons) per minute.

Water volume limits:

The heat exchanger holds approximately 9 liters (2.4 gallons). Fifteen meters (50 ft) of 19 mm (0.75 in.) supply and return hoses hold approximately 9.4 liters (2.5 gallons). To minimize exposure to flooding in the case of leaks, the entire product cooling system (heat exchanger, supply hose, and return hose), excluding any reservoir tank, must have a maximum 18.4 liters (4.8 gallons) of water. This is a cautionary statement, not a functional requirement. Also, consider using leak detection methods on the secondary loop that supplies water to the heat exchanger.

Air exposure:

The secondary cooling loop is a closed loop, with no continuous exposure to room air. After you fill the loop, remove all air from the loop. An air bleed valve is provided at the top of a heat exchanger manifold for purging all air from the system.

Water delivery specifications for secondary loops

Learn about the various hardware components that make up the delivery system secondary loop that provides the chilled, conditioned water to the heat exchanger. The delivery system includes pipes, hoses, and the required connection hardware to connect the hoses to the heat exchanger. Hose management can be used in raised-floor and non-raised-floor environments.

The heat exchanger can remove 100% or more of the heat load from an individual rack when it is running under optimum conditions.

The primary cooling loop is considered to be the building chilled-water supply or a modular chiller unit. The primary loop must not be used as a direct source of coolant for the heat exchanger.

Procurement and installation of the components that are needed to create the secondary cooling loop system are required for this design and are your responsibility. The main purpose is to provide examples of typical methods of secondary loop setup and operating characteristics that are needed to provide an adequate and safe supply of water to the heat exchanger.

Attention:

The overpressure safety device must meet the following requirements:

- Comply with *ISO 4126-1*.
- Be installed so that it is easily accessed for inspection, maintenance, and repair.
- Be connected as close as possible to the device that it is intended to protect.
- Be adjustable only with the use of a tool.
- Have a discharge opening that is directed so that discharged water or fluid does not create a hazard or be directed toward any person.
- Be of adequate discharge capacity to ensure that the maximum working pressure is not exceeded.
- Be installed without a shutoff valve between the overpressure safety device and the protected device.

Read the following guidelines before you design the installation:

- A method for monitoring and setting the total flow rate that is delivered to all of the heat exchangers is required. This can be a discrete flowmeter that is built into the flow loop or a flowmeter within the secondary loop of the coolant distribution unit (CDU).
- After you set the total flow rate for all of the heat exchangers by using a flowmeter, it is important to design the plumbing so that it provides the flow rate that you want for each heat exchanger and provides a way to verify the flow rate. Other methods, such as inline or external flowmeters, can provide a more accurate method for setting the flow rate through the individual shutoff valves.
- Design the flow loop to minimize the total pressure drop within the flow loop. The Optional Low Impedance Quick Connect feature cannot use the Parker quick-connect couplings that are used on the heat exchanger because of the excessive pressure drop that is associated with flowing through four quick-connect pairs in series. These must be very low, near 0, flow impedance quick connects. Alternatively, these quick connects can be eliminated and replaced with a hose barb connection.

Manifolds and piping:

Manifolds that accept large-diameter feed pipes from a pump unit are the preferred method for splitting the flow of water to smaller-diameter pipes or hoses that are routed to individual heat exchangers. Manifolds must be constructed of materials that are compatible with the pump unit and related piping. The manifolds must provide enough connection points to allow a matching number of supply and return lines to be attached, and the manifolds must match the capacity rating of the pumps and the loop heat exchanger (between the secondary cooling loop and the building chilled-water source). Anchor or restrain all manifolds to provide the required support to avoid movement when quick-connect couplings are connected to the manifolds.

Example of manifold supply pipe sizes:

- Use a 50.8 mm (2 in.) or larger supply pipe to provide the correct flow to three 19 mm (0.75 in.) supply hoses, with a 100 kW coolant distribution unit (CDU).
- Use a 63.5 mm (2.50 in.) or larger supply pipe to provide the correct flow to four 19 mm (0.75 in.) supply hoses, with a 120 kW CDU.
- Use an 88.9 mm (3.50 in.) or larger supply pipe to provide the correct flow to nine 19 mm (0.75 in.) supply hoses, with a 300 kW CDU.

To stop the flow of water in individual legs of multiple circuit loops, install shutoff valves for each supply and return line. This provides a way to service or replace an individual heat exchanger without affecting the operation of other heat exchangers in the loop.

To ensure that water specifications are being met and that the optimum heat removal is taking place, use temperature and flow metering (monitoring) in secondary loops.

Anchor or restrain all manifolds and pipes to provide the required support and to avoid movement when quick-connect couplings are being attached to the manifolds.

Flexible hoses and connections to manifolds and heat exchangers:

Pipe and hose configurations can vary. You can determine the best configuration for your installation by analyzing the needs of your facilities, or a site preparation representative can provide this analysis.

Flexible hoses are needed to supply and return water between your hard plumbing (manifolds and coolant distribution units) and the heat exchanger (allowing needed movement for opening and closing the rack rear door).

Hoses are available that provide water with acceptable pressure-drop characteristics and that help prevent depletion of some corrosion inhibitors. These hoses must be made of peroxide-cured ethylene propylene diene monomer (EPDM) rubber, non-metal oxide material and must have Parker Fluid Connectors quick-connect couplings at one end, which are attached to the heat exchanger, and must either have a low impedance quick connect coupling or nothing to attach to a barb at the other end. The Parker couplings are compatible with the heat exchanger couplings. Hose lengths 3 - 15 meters (10 - 50 ft), in increments of 3 meters (10 ft), are available. Hoses that are longer than 15 meters (50 ft) might create unacceptable pressure loss in the secondary circuit and reduce the water flow, reducing the heat removal capabilities of the heat exchanger.

Use solid piping or tubing that has a minimum inner diameter of 19 mm (0.75 in.) and the fewest possible joints between a manifold and a heat exchanger in each secondary loop.

Use quick-connect couplings to attach the hoses to the heat exchangers. Hose couplings that connect to the heat exchanger must have the following characteristics:

- The couplings must be constructed of passivated 300-L series stainless steel or brass with less than 30% zinc content. The coupling size is 19 mm (0.75 in.).
- The supply hose must have a Parker (male) quick-coupling nipple, part number SH6-63-W, or equivalent. The return hose must have a Parker (female) quick-connect coupling, part number SH6-62-W, or equivalent.
- If a low impedance quick-connect coupling is used at the opposite (manifold) end of the hose, use positive locking mechanisms to prevent loss of water when the hoses are disconnected. The connections must minimize water spill and air inclusion into the system when they are disconnected.

Planning for the 7965-S42 rack

Rack specifications provide detailed information for your rack, including dimensions, electrical, power, temperature, environment, and service clearances.

Model 7965-S42 rack specifications:

Hardware specifications provide detailed information for your rack, including dimensions, electrical, power, temperature, environment, and service clearances.

Table 55. Dimensions for rack

	Width	Depth	Height	Weight (Empty)	EIA unit capacity
Rack only	600 mm (23.6 in.)	1070 mm (42.1 in.)	2020 mm (79.5 in.)	166 kg (365 lb)	42 EIA units
Rack with two standard doors	600 mm (23.6 in.)	1132 mm (44.6 in.)	2020 mm (79.5 in.)	177 kg (391 lb)	42 EIA units
Rack with rear door heat exchanger (dry) and standard doors	600 mm (23.6 in.)	1231 mm (48.5 in.)	2020 mm (79.5 in.)	210 kg (463 lb)	42 EIA units

Table 55. Dimensions for rack (continued)

	Width	Depth	Height	Weight (Empty)	EIA unit capacity
Rack with high-end appearance front door and rear door	600 mm (23.6 in.)	1201 mm (47.3 in.)	2020 mm (79.5 in.)	181 kg (398 lb)	42 EIA units

Table 56. Dimensions for doors

Door model	Width	Height	Depth	Weight
Standard front door and standard back door	590 mm (23.2 in.)	1942 mm (76.5 in.)	31 mm (1.2 in.)	5.9 kg (13 lb)
Rear door heat exchanger door	600 mm (23.6 in.)	1950 mm (76.8 in.)	129 mm (5.0 in.)	39 kg (85 lb) - empty
				48 kg (105 lb) - filled
High-end appearance front door	590 mm (23.2 in.)	1942 mm (76.5 in.)	100 mm (3.9 in.)	9.1 kg (20 lb)

Table 57. Dimensions for side covers

Width ¹	Depth	Height	Weight
12 mm (0.25 in.)	1070 mm (42.1 in.)	1942 mm (76.5 in.)	20 kg (44 lb)

¹ Side covers increase the overall width of the rack by 12 mm (0.25 in.) per side, but are only used on the ends of the rows.

Table 58. Environment requirements¹

Environment	Recommended operating	Allowable operating	Nonoperating
ASHRAE class		A3	
Airflow direction		Front-to-back	
Temperature ²	18°C - 27°C (64°F - 80°F)	5°C - 40°C (41°F - 104°F)	1°C - 60°C (34°F - 140°F)
Humidity range	5.5°C (42°F) dew point (DP) to 60% relative humidity (RH) and 15°C (59°F) dew point	-12.0°C (10.4°F) DP and 8% - 80% RH	8% - 80% RH
Maximum dew point		24°C (75°F)	27°C (80°F)
Maximum operating altitude		3050 m (10000 ft)	
Shipping temperature			-40°C to 60°C (-40°F to 140°F)
Shipping relative humidity			5% - 100%

- The final ASHRAE class is determined by the hardware that is installed in the rack. Individual specifications for each piece of hardware must be reviewed.
- Derate maximum allowable dry-bulb temperature 1°C per 175 m above 950 m. IBM recommends a temperature range of 18°C - 27°C (64°F - 80.6°F).

Table 59. Service clearances

Front¹	Back
915 mm (36 in.)	915 mm (36 in.)
¹ Storage racks require larger service clearances in the front of the rack.	

Rear door heat exchanger

Specifications for Power orderable feature code (FC) EC05 (Rear door heat exchanger indicator (Model 1164-95X)).

Table 60. Dimensions for rear door heat exchanger

Width	Depth	Height	Weight (empty)	Weight (filled)
600 mm (23.6 in.)	129 mm (5.0 in.)	1950 mm (76.8 in.)	39 kg (85 lb)	48 kg (105 lb)
For more information, see "Model 1164-95X rear door heat exchanger" on page 43.				

Electrical

For electrical requirements, see Power distribution unit and power cord options.

Floor cutout

Racks with water hoses and power cords that exit from the bottom of the rack require a floor tile cutout of at least 30.48 cm (12 in.) long by 22.86 cm (9 in.) wide. Due to the hose bend radii, the hole must be positioned towards the side of the rack without the manifold (the left side of the rack when looking at the rear of the rack). The left edge of the hole must be at least 11.43 cm (4.5 in.) from the side and 3.81 cm (1.5 in.) from the back edge of the rack (not including doors). Hole placement on the tile depends on the location of the rack, tile size, and tile load limitations.

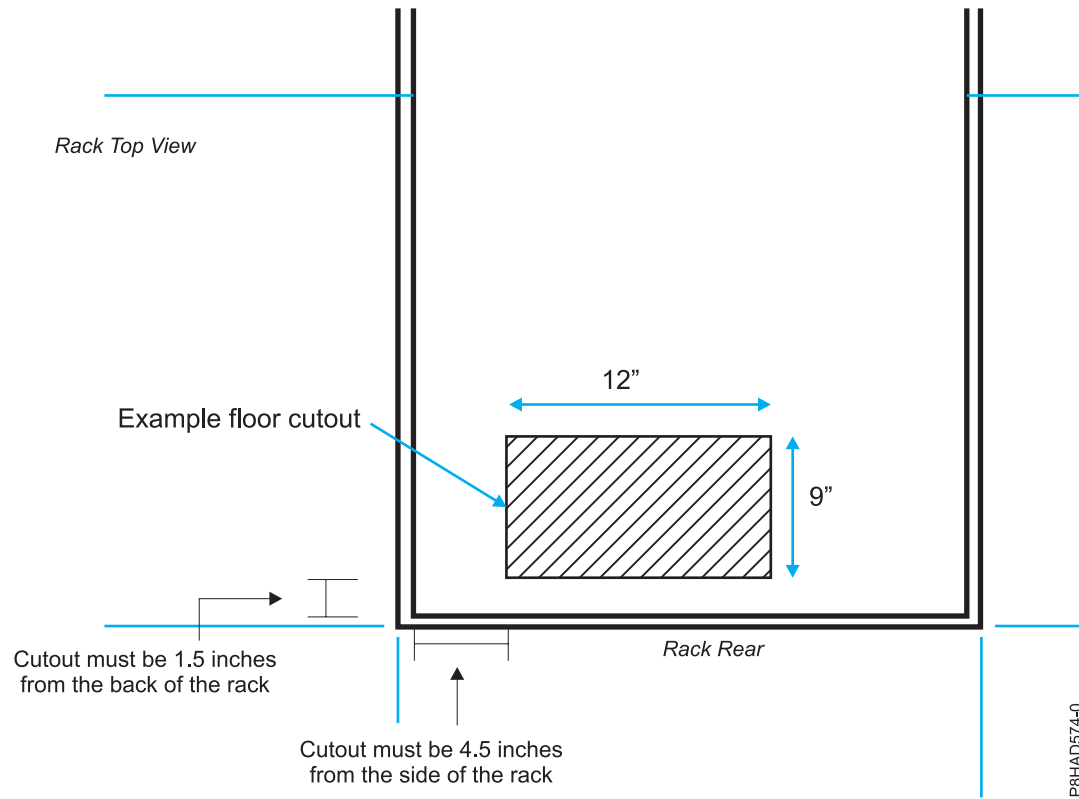
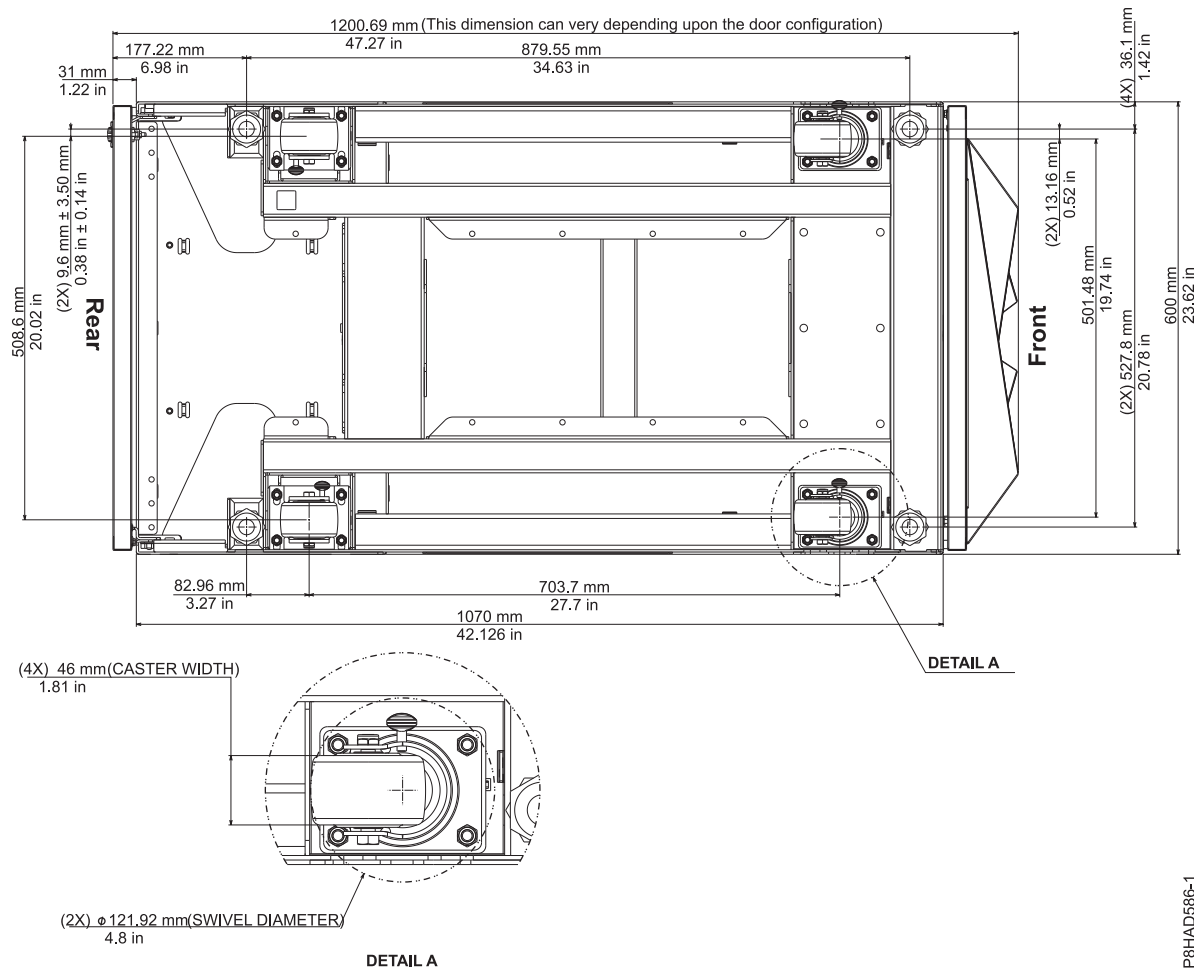

Figure 33. Floor cutout

Caster and leveler locations

The following diagram provides the caster and leveler locations for the 7965-S42 rack.



P8HAD586-1

Figure 34. Caster and leveler locations

Cabling the 7965-S42 rack:

Learn about the different cable routing options available for the 7965-S42 rack.

Cabling within the rack

Side cable channels are available in the rack to route cables. Three cable channels are on each side of the rack.

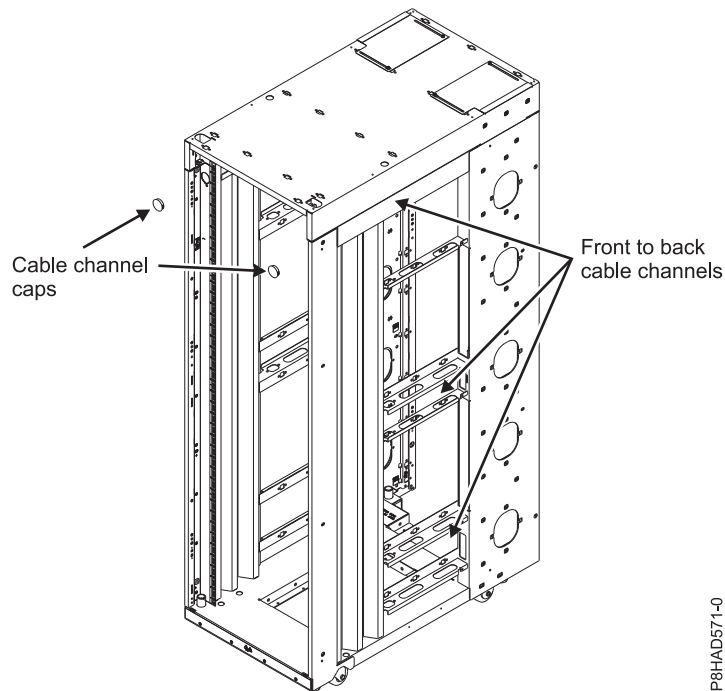

Figure 35. Cabling within the rack

Cabling under the floor

Cables can be routed straight down through the side channels of the rack or routed towards the center of the opening.

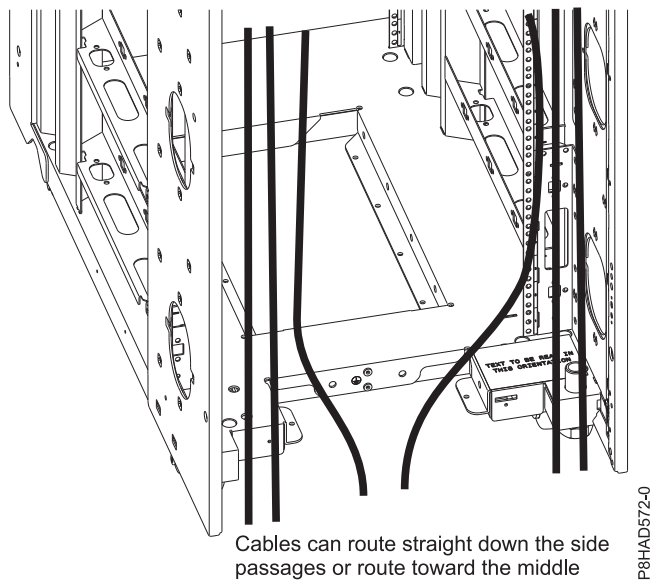
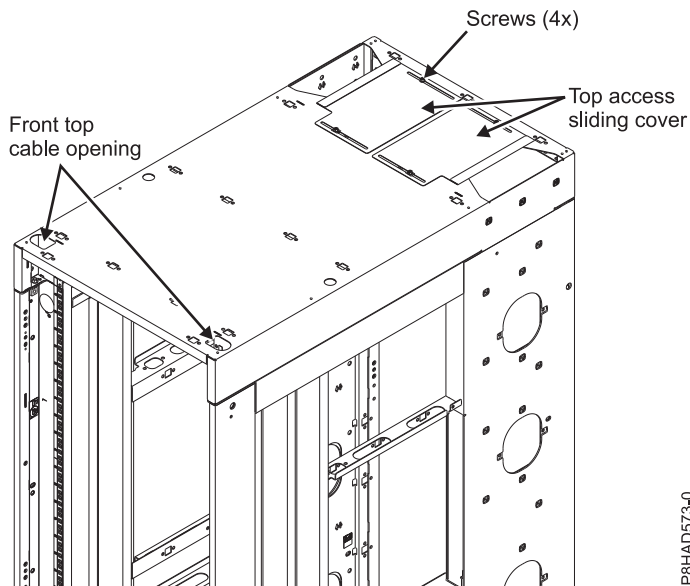

Figure 36. Cabling under the floor

Cabling overhead

Front and rear cable access openings that are on the top of the rack cabinet allow cables to be routed up and out of the rack. Cable access covers on the rear are adjustable by loosening the side screws and sliding the covers forward or backward. Because of the smaller size of the cable openings in front, cables

that pass through this area must be minimized.



P8HAD573-0

Figure 37. Cabling overhead

Multiple racks:

Learn how to attach multiple 7965-S42 racks together.

Multiple 7965-S42 racks can be attached together. For racks that are on a 600 mm (23.6 in.) pitch, two spacer brackets must be added to set the proper spacing.

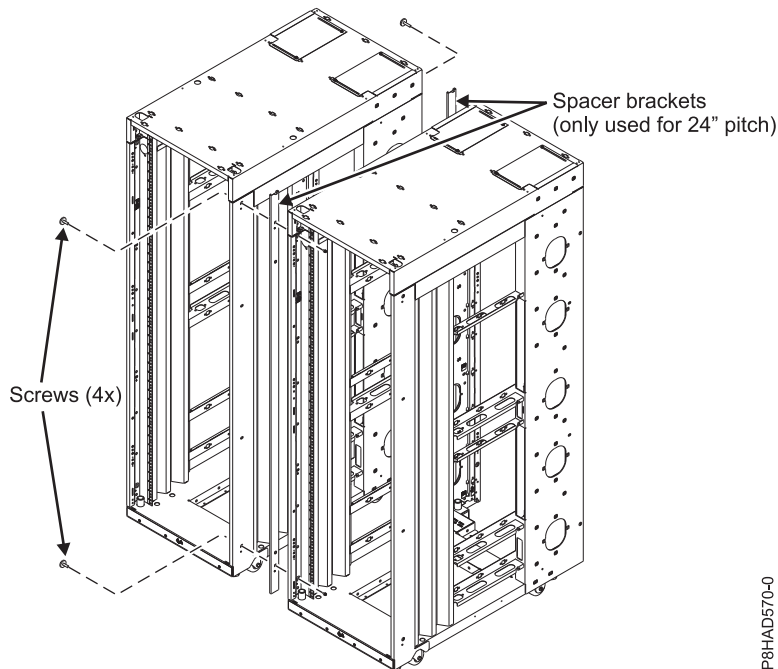

P8HAD570-0

Figure 38. Attaching multiple racks

Model 1164-95X rear door heat exchanger:

Learn about the specifications of the 1164-95X rear door heat exchanger (feature code EC05).

Model 1164-95X rear door heat exchanger specifications

Table 61. Dimensions for the 1164-95X rear door heat exchanger

Width ¹	Depth	Height	Weight (empty)	Weight (filled)
600 mm (23.6 in.)	129 mm (5.0 in.)	1950 mm (76.8 in.)	39 kg (85.0 lb)	48 kg (105.0 lb)
1. The width is the inside width of the machine when installed in the U space of the rack. The width of the front bezel is 482 mm (19.0 in.).				

Water specifications

- Pressure
 - Normal operation: <137.93 kPa (20 psi)
 - Maximum: 689.66 kPa (100 psi)
- Volume
 - Approximately 9 liters (2.4 gallons)
- Temperature
 - Water temperature must be above the dew point in the data center
 - 18°C ± 1°C (64.4°F ± 1.8°F) for ASHRAE Class 1 Environment
 - 22°C ± 1°C (71.6°F ± 1.8°F) for ASHRAE Class 2 Environment
- Required water flow rate (as measured from the supply entrance to the heat exchanger)
 - Minimum: 22.7 liters (6 gallons) per minute
 - Maximum: 56.8 liters (15 gallons) per minute

Heat exchanger performance

A heat removal of 100% indicates that an amount of heat that is equivalent to that generated by the devices has been removed by the heat exchanger and the average air temperature leaving the heat exchanger is identical to that entering the rack (27°C (80.6°F) in this example). Heat removal in excess of 100% indicates that the heat exchanger not only removed all of the heat that was generated by the devices, but further cooled the air so that the average air temperature that is leaving the rack is actually lower than air temperature that is entering the rack.

To help maintain optimum performance of the rear door heat exchanger and provide proper cooling for all rack components, you must take the following precautions:

- Install filler panels over all unoccupied bays.
- Route signal cables at the rear of the rack so that they enter or exit the cabinet through the top and bottom air baffles.
- Bundle signal cables together in a rectangle so that the upper and lower air-baffle sliders are closed as far as possible. Do not bundle signal cables together in a circular formation.

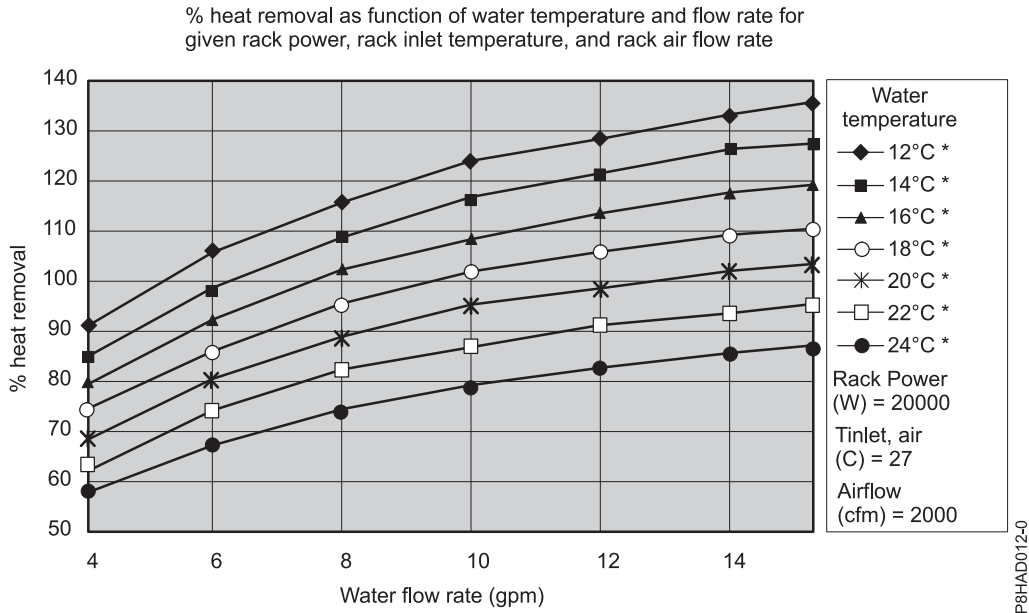

Figure 39. Typical performance of the heat exchanger, 20 kW heat load

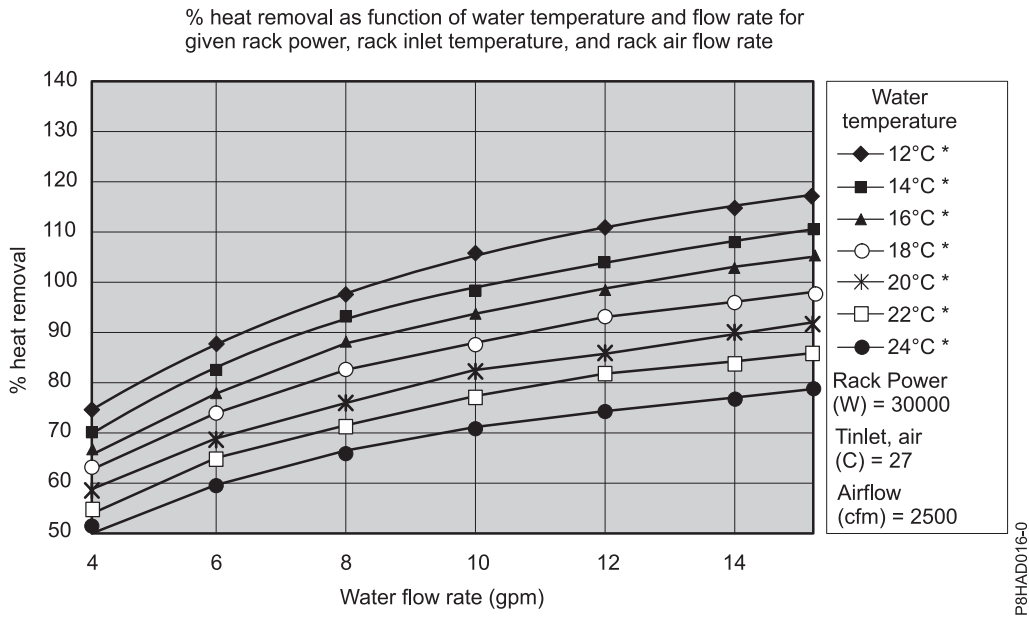

Figure 40. Typical performance of the heat exchanger, 30 kW heat load

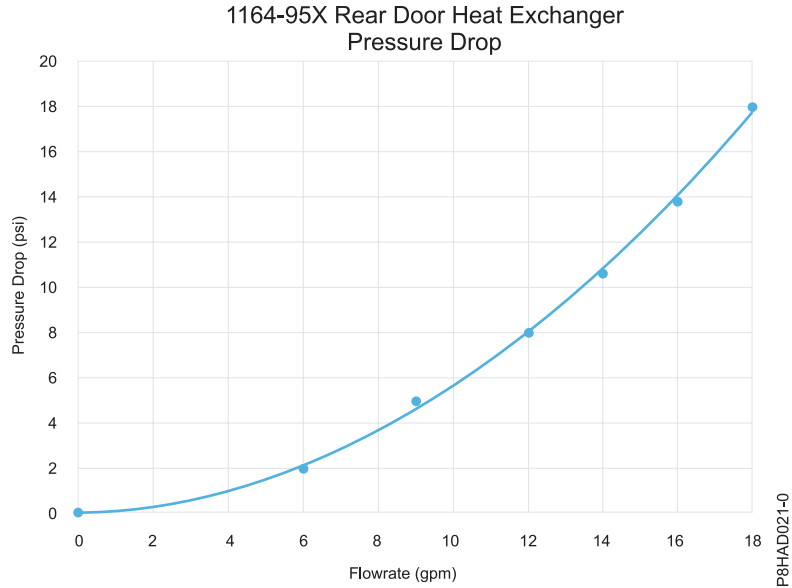

Figure 41. Pressure drop (standard units)

Water specifications for the secondary cooling loop

Important: The water that is being supplied to the heat exchanger must meet the requirements that are described in this section. Otherwise, system failures might occur over time as a result of any of the following problems:

- Leaks due to corrosion and pitting of the metal components of the heat exchanger or of the water-supply system.
- Buildup of scale deposits inside the heat exchanger, which can cause the following problems:
 - A reduction in the ability of the heat exchanger to cool the air that is exhausted from the rack
 - Failure of mechanical hardware, such as a hose quick-connect coupling
- Organic contamination, such as bacteria, fungi, or algae. This contamination can cause the same problems as described for scale deposits.

Contact a water quality and water distribution services expert for designing and implementing the infrastructure and water chemistry of the secondary loop.

Control and conditioning of the secondary cooling loop

The water that is used to fill, refill, and supply the heat exchanger must be particle-free deionized water or particle-free distilled water with appropriate controls for avoiding the following problems:

- Metal corrosion
- Bacterial fouling
- Scaling

The water cannot originate from the primary chilled-water system for the building but must be supplied as part of a secondary closed-loop system.

Important: Do not use glycol solutions because they can adversely affect the cooling performance of the heat exchanger.

Materials to use in secondary loops

You can use any of the following materials in supply lines, connectors, manifolds, pumps and any other hardware that makes up the closed-loop water-supply system at your location:

- Copper v brass with less than 30% zinc content
- Brass with less than 30% zinc content
- Stainless steel 303 or 316
- Peroxide cured ethylene propylene diene monomer (EPDM) rubber, non-metal-oxide material

Materials to avoid in secondary loops

Do not use any of the following materials in any part of your water-supply system:

- Oxidizing biocides, such as chlorine, bromine, and chlorine dioxide
- Aluminum
- Brass with greater than 30% zinc
- Irons (nonstainless steel)

Model 1164-95X rear door heat exchanger water cooling specifications and requirements:

Learn about the specifications and requirements for the water cooling of the 1164-95X rear door heat exchanger (feature code EC05).

Water specifications for the secondary cooling loop

Important: The water that is being supplied to the heat exchanger must meet the requirements that are described at: “Model 1164-95X rear door heat exchanger” on page 43. Otherwise, system failures might occur over time as a result of any of the following problems:

- Leaks due to corrosion and pitting of the metal components of the heat exchanger or of the water-supply system.
- Buildup of scale deposits inside the heat exchanger, which can cause the following problems:
 - A reduction in the ability of the heat exchanger to cool the air that is exhausted from the rack
 - Failure of mechanical hardware, such as a hose quick-connect coupling
- Organic contamination, such as bacteria, fungi, or algae. This contamination can cause the same problems as described for scale deposits.

Contact a water quality and water distribution services expert for designing and implementing the infrastructure and water chemistry of the secondary loop.

Control and conditioning of the secondary cooling loop

The water that is used to fill, refill, and supply the heat exchanger must be particle-free deionized water or particle-free distilled water with appropriate controls for avoiding the following problems:

- Metal corrosion
- Bacterial fouling
- Scaling

The water cannot originate from the primary chilled-water system for the building but must be supplied as part of a secondary closed-loop system.

Important: Do not use glycol solutions because they can adversely affect the cooling performance of the heat exchanger.

Materials to use in secondary loops

You can use any of the following materials in supply lines, connectors, manifolds, pumps, and any other hardware that makes up the closed-loop water-supply system at your location:

- Copper v brass with less than 30% zinc content
- Brass with less than 30% zinc content
- Stainless steel 303 or 316
- Peroxide cured ethylene propylene diene monomer (EPDM) rubber, non-metal-oxide material

Materials to avoid in secondary loops

Do not use any of the following materials in any part of your water-supply system:

- Oxidizing biocides, such as chlorine, bromine, and chlorine dioxide
- Aluminum
- Brass with greater than 30% zinc
- Irons (nonstainless steel)

Water-supply requirements for secondary loops

Learn about the specific characteristics of the system that supplies the chilled conditioned water to the heat exchanger.

Temperature:

The heat exchanger and its supply hose and return hoses are not insulated. Avoid any condition that might cause condensation. The temperature of the water inside the supply hose, return hose, and heat exchanger must be kept above the dew point of the location where the heat exchanger is being used.

Attention: Typical primary chilled water is too cold for use in this application because building chilled water can be as cold as 4°C - 6°C (39°F - 43°F).

Important:

The system that supplies the cooling water must be able to measure the room dew point and automatically adjust the water temperature accordingly. Otherwise, the water temperature must be above the maximum dew point for that data center installation. For example, the following minimum water temperature must be maintained:

- 18°C plus or minus 1°C (64.4°F plus or minus 1.8°F). This specification is applicable within an ASHRAE Class 1 Environmental Specification that requires a maximum dew point of 17°C (62.6°F).
- 22°C plus or minus 1°C (71.6°F plus or minus 1.8°F). This specification is applicable within an ASHRAE Class 2 Environmental Specification that requires a maximum dew point of 21°C (69.8°F).

See the *ASHRAE document Thermal Guidelines for Data Processing Environments*.

Pressure:

The water pressure in the secondary loop must be less than 690 kPa (100 psi). Normal operating pressure at the heat exchanger must be 414 kPa (60 psi) or less.

Flow rate:

The flow rate of the water in the system must be in the range of 23 - 57 liters (6 - 15 gallons) per minute.

Pressure drop versus flow rate for heat exchangers (including quick-connect couplings) is defined as approximately 103 kPa (15 psi) at 57 liters (15 gallons) per minute.

Water volume limits:

The heat exchanger holds approximately 9 liters (2.4 gallons). Fifteen meters (50 ft) of 19 mm (0.75 in.) supply and return hoses hold approximately 9.4 liters (2.5 gallons). To minimize exposure to flooding in the case of leaks, the entire product cooling system (heat exchanger, supply hose, and return hose), excluding any reservoir tank, must have a maximum 18.4 liters (4.8 gallons) of water. This is a cautionary statement, not a functional requirement. Also, consider using leak detection methods on the secondary loop that supplies water to the heat exchanger.

Air exposure:

The secondary cooling loop is a closed loop, with no continuous exposure to room air. After you fill the loop, remove all air from the loop. An air bleed valve is provided at the top of a heat exchanger manifold for purging all air from the system.

Water delivery specifications for secondary loops

Learn about the various hardware components that make up the delivery system secondary loop that provides the chilled, conditioned water to the heat exchanger. The delivery system includes pipes, hoses, and the required connection hardware to connect the hoses to the heat exchanger. Hose management can be used in raised-floor and non-raised-floor environments.

The heat exchanger can remove 100% or more of the heat load from an individual rack when it is running under optimum conditions.

The primary cooling loop is considered to be the building chilled-water supply or a modular chiller unit. The primary loop must not be used as a direct source of coolant for the heat exchanger.

Procurement and installation of the components that are needed to create the secondary cooling loop system are required for this design and are your responsibility. The main purpose is to provide examples of typical methods of secondary loop setup and operating characteristics that are needed to provide an adequate and safe supply of water to the heat exchanger.

Attention:

The overpressure safety device must meet the following requirements:

- Comply with *ISO 4126-1*.
- Be installed so that it is easily accessed for inspection, maintenance, and repair.
- Be connected as close as possible to the device that it is intended to protect.
- Be adjustable only with the use of a tool.
- Have a discharge opening that is directed so that discharged water or fluid does not create a hazard or be directed toward any person.
- Be of adequate discharge capacity to ensure that the maximum working pressure is not exceeded.
- Be installed without a shutoff valve between the overpressure safety device and the protected device.

Read the following guidelines before you design the installation:

- A method for monitoring and setting the total flow rate that is delivered to all of the heat exchangers is required. This can be a discrete flowmeter that is built into the flow loop or a flowmeter within the secondary loop of the coolant distribution unit (CDU).
- After you set the total flow rate for all of the heat exchangers by using a flowmeter, it is important to design the plumbing so that it provides the flow rate that you want for each heat exchanger and provides a way to verify the flow rate. Other methods, such as inline or external flowmeters, can provide a more accurate method for setting the flow rate through the individual shutoff valves.

- Design the flow loop to minimize the total pressure drop within the flow loop. The Optional Low Impedance Quick Connect feature cannot use the Parker quick-connect couplings that are used on the heat exchanger because of the excessive pressure drop that is associated with flowing through four quick-connect pairs in series. These must be very low, near 0, flow impedance quick connects. Alternatively, these quick connects can be eliminated and replaced with a hose barb connection.

Manifolds and piping:

Manifolds that accept large-diameter feed pipes from a pump unit are the preferred method for splitting the flow of water to smaller-diameter pipes or hoses that are routed to individual heat exchangers. Manifolds must be constructed of materials that are compatible with the pump unit and related piping. The manifolds must provide enough connection points to allow a matching number of supply and return lines to be attached, and the manifolds must match the capacity rating of the pumps and the loop heat exchanger (between the secondary cooling loop and the building chilled-water source). Anchor or restrain all manifolds to provide the required support to avoid movement when quick-connect couplings are connected to the manifolds.

Example of manifold supply pipe sizes:

- Use a 50.8 mm (2 in.) or larger supply pipe to provide the correct flow to three 19 mm (0.75 in.) supply hoses, with a 100 kW coolant distribution unit (CDU).
- Use a 63.5 mm (2.50 in.) or larger supply pipe to provide the correct flow to four 19 mm (0.75 in.) supply hoses, with a 120 kW CDU.
- Use an 88.9 mm (3.50 in.) or larger supply pipe to provide the correct flow to nine 19 mm (0.75 in.) supply hoses, with a 300 kW CDU.

To stop the flow of water in individual legs of multiple circuit loops, install shutoff valves for each supply and return line. This provides a way to service or replace an individual heat exchanger without affecting the operation of other heat exchangers in the loop.

To ensure that water specifications are being met and that the optimum heat removal is taking place, use temperature and flow metering (monitoring) in secondary loops.

Anchor or restrain all manifolds and pipes to provide the required support and to avoid movement when quick-connect couplings are being attached to the manifolds.

Flexible hoses and connections to manifolds and heat exchangers:

Pipe and hose configurations can vary. You can determine the best configuration for your installation by analyzing the needs of your facilities, or a site preparation representative can provide this analysis.

Flexible hoses are needed to supply and return water between your hard plumbing (manifolds and coolant distribution units) and the heat exchanger (allowing needed movement for opening and closing the rack rear door).

Hoses are available that provide water with acceptable pressure-drop characteristics and that help prevent depletion of some corrosion inhibitors. These hoses must be made of peroxide-cured ethylene propylene diene monomer (EPDM) rubber, non-metal oxide material and must have Parker Fluid Connectors quick-connect couplings at one end, which are attached to the heat exchanger, and must either have a low impedance quick connect coupling or nothing to attach to a barb at the other end. The Parker couplings are compatible with the heat exchanger couplings. Hose lengths 3 - 15 meters (10 - 50 ft), in increments of 3 meters (10 ft), are available. Hoses that are longer than 15 meters (50 ft) might create unacceptable pressure loss in the secondary circuit and reduce the water flow, reducing the heat removal capabilities of the heat exchanger.

Use solid piping or tubing that has a minimum inner diameter of 19 mm (0.75 in.) and the fewest possible joints between a manifold and a heat exchanger in each secondary loop.

Use quick-connect couplings to attach the hoses to the heat exchangers. Hose couplings that connect to the heat exchanger must have the following characteristics:

- The couplings must be constructed of passivated 300-L series stainless steel or brass with less than 30% zinc content. The coupling size is 19 mm (0.75 in.).
- The supply hose must have a Parker (male) quick-coupling nipple, part number SH6-63-W, or equivalent. The return hose must have a Parker (female) quick-connect coupling, part number SH6-62-W, or equivalent.
- If a low impedance quick-connect coupling is used at the opposite (manifold) end of the hose, use positive locking mechanisms to prevent loss of water when the hoses are disconnected. The connections must minimize water spill and air inclusion into the system when they are disconnected.

Rack switch specifications

Rack switch specifications provide detailed information for your IBM BNT RackSwitch, including dimensions, electrical, power, temperature, environment, and service clearances.

Select the appropriate models to view the specifications for your rack switch.

G8052R RackSwitch specification sheet

Hardware specifications provide detailed information for your IBM BNT RackSwitch, including dimensions, electrical, power, temperature, environment, and service clearances.

Table 62. Dimensions

Height	Width	Depth	Weight (maximum)
44 mm (1.73 in.)	439 mm (17.3 in.)	445 mm (17.5 in.)	8.3 kg (18.3 lb)

Table 63. Electrical

Electrical characteristics	Properties
Power requirements	200 W
Voltage	90 - 264 V ac
Frequency	47 - 63 Hz
Maximum thermal output	682.4 Btu/hr
Phase	1
kVA	0.204

Table 64. Environmental and acoustical requirements

Environment/Acoustical	Operating	Storage
Airflow direction	Rear-to-front	
Temperature, ambient operating	0°C - 40°C (32°F - 104°F)	
Temperature, (fan failure) operating	0°C - 35°C (32°F - 95°F)	
Temperature, storage		-40°C to +85°C (-40°F to 185°F)
Relative humidity range (non-condensing)	10% - 90% RH	10% - 90% RH
Maximum altitude	3050 m (10000 ft)	12190 m (40000 ft)
Heat dissipation	444 Btu/hr	
Acoustic noise	Less than 65 dB	

G8124ER RackSwitch specification sheet

Hardware specifications provide detailed information for your IBM BNT RackSwitch, including dimensions, electrical, power, temperature, environment, and service clearances.

Table 65. Dimensions

Height	Width	Depth	Weight (maximum)
44 mm (1.73 in.)	439 mm (17.3 in.)	381 mm (15.0 in.)	6.4 kg (14.1 lb)

Table 66. Electrical

Electrical characteristics	Properties
Power requirements	275 W
Voltage	100 - 240 V ac
Frequency	50 - 60 Hz
Maximum thermal output	938.3 Btu/hr
Phase	1
kVA	0.281

Table 67. Environmental and acoustical requirements

Environment/Acoustical	Operating	Storage
Airflow direction	Rear-to-front	
Temperature, ambient operating	0°C - 40°C (32°F - 104°F)	
Temperature (fan failure) operating	0°C - 35°C (32°F - 95°F)	
Temperature, storage		-40°C to +85°C (-40°F to 185°F)
Relative humidity range (non-condensing)	10% - 90% RH	10% - 95% RH
Maximum altitude	3050 m (10000 ft)	4573 m (15000 ft)
Heat dissipation	1100 Btu/hr	
Acoustic noise	Less than 65 dB	

G8264R RackSwitch specification sheet

Hardware specifications provide detailed information for your IBM BNT RackSwitch, including dimensions, electrical, power, temperature, environment, and service clearances.

Table 68. Dimensions

Height	Width	Depth	Weight (maximum)
44 mm (1.73 in.)	439 mm (17.3 in.)	513 mm (20.2 in.)	10.5 kg (23.1 lb)

Table 69. Electrical

Electrical characteristics	Properties
Power requirements	375 W
Voltage	100 - 240 V ac
Frequency	50 - 60 Hz
Maximum thermal output	1280 Btu/hr
Phase	1
kVA	0.383

Table 70. Environmental and acoustical requirements

Environment/Acoustical	Operating	Storage
Airflow direction	Rear-to-front	
Temperature, ambient operating	0°C - 40°C (32°F - 104°F)	
Temperature (fan failure) operating	0°C - 35°C (32°F - 95°F)	
Temperature, storage		-40°C to +85°C (-40°F to 185°F)
Relative humidity range (non-condensing)	10% - 90% RH	10% - 90% RH
Maximum altitude	1800 m (6000 ft)	12190 m (40000 ft)
Heat dissipation	1127 Btu/hr	
Acoustic noise	Less than 65 dB	

G8316R RackSwitch specification sheet

Hardware specifications provide detailed information for your IBM BNT RackSwitch, including dimensions, electrical, power, temperature, environment, and service clearances.

Table 71. Dimensions

Height	Width	Depth	Weight (maximum)
43.7 mm (1.72 in.)	439 mm (17.3 in.)	483 mm (19.0 in.)	9.98 kg (22.0 lb)

Table 72. Electrical

Electrical characteristics	Properties
Power requirements	400 W
Voltage	100 - 240 V ac
Frequency	50 - 60 Hz
Maximum thermal output	1365 Btu/hr
Phase	1
kVA	0.408

Table 73. Environmental requirements

Environment	Operating
Airflow direction	Rear-to-front
Temperature, ambient operating	0°C - 40°C (32°F - 104°F)
Relative humidity range (non-condensing)	10% - 90% RH
Maximum altitude	3050 m (10000 ft)
Heat dissipation	1100 Btu/hr

Rack installation specifications for racks not purchased from IBM

Learn the requirements and specifications for installing IBM systems into racks that were not purchased from IBM.

This topic provides requirements and specifications for 19-inch racks. These requirements and specifications are provided as an aid to help you understand the requirements to install IBM systems into racks. It is your responsibility, working with your rack manufacturer, to ensure that the rack chosen

meets the requirements and specifications that are listed here. Mechanical drawings of the rack, if available from the manufacturer, are recommended for comparison against the requirements and specifications.

IBM maintenance services and installation planning services do not cover verification of non-IBM racks for compliance to Power Systems™ rack specifications. IBM offers racks for IBM products that are tested and verified by IBM development labs to comply with applicable safety and regulatory requirements. These racks are also tested and verified to fit and function well with IBM products. The customer is responsible for verifying with their rack manufacturer that any non-IBM racks comply with IBM specifications.

Note: IBM 7014-T00, 7014-T42, 7014-B42, 0551, and 0553 racks meet all the requirements and specifications.

Rack specifications

The general rack specifications include the following specifications:

- The rack or cabinet must meet the EIA Standard EIA-310-D for 19-inch racks published August 24, 1992. The EIA-310-D standard specifies internal dimensions, for example, the width of the rack opening (width of the chassis), the width of the module mounting flanges, the mounting hole spacing, and the depth of the mounting flanges. The EIA-310-D standard does not control the overall external width of the rack. There are no restrictions on the location of side walls and corner posts relative to the internal mounting space.
- The front rack opening must be 450 mm wide + 0.75 mm (17.72 in. + 0.03 in.), and the rail-mounting holes must be 465 mm + 0.8 mm (18.3 in. + 0.03 in.) apart on center (horizontal width between vertical columns of holes on the two front-mounting flanges and on the two rear-mounting flanges).

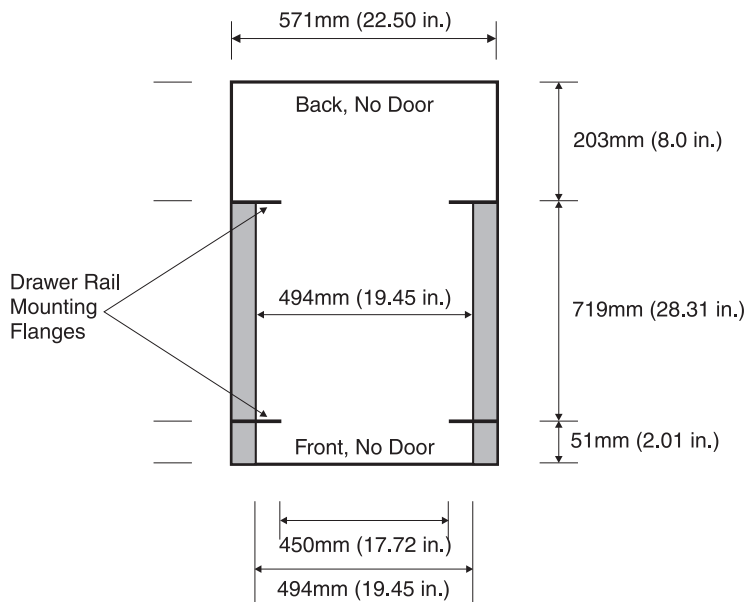

The vertical distance between mounting holes must consist of sets of three holes spaced (from bottom to top) 15.9 mm (0.625 in.), 15.9 mm (0.625 in.), and 12.67 mm (0.5 in.) on center (making each three-hole set of vertical hole spacing 44.45 mm (1.75 in.) apart on center). The front and rear mounting flanges in the rack or cabinet must be 719 mm (28.3 in.) apart and the internal width that is bounded by the mounting flanges at least 494 mm (19.45 in.), for the IBM rails to fit in your rack or cabinet (see the following figure).

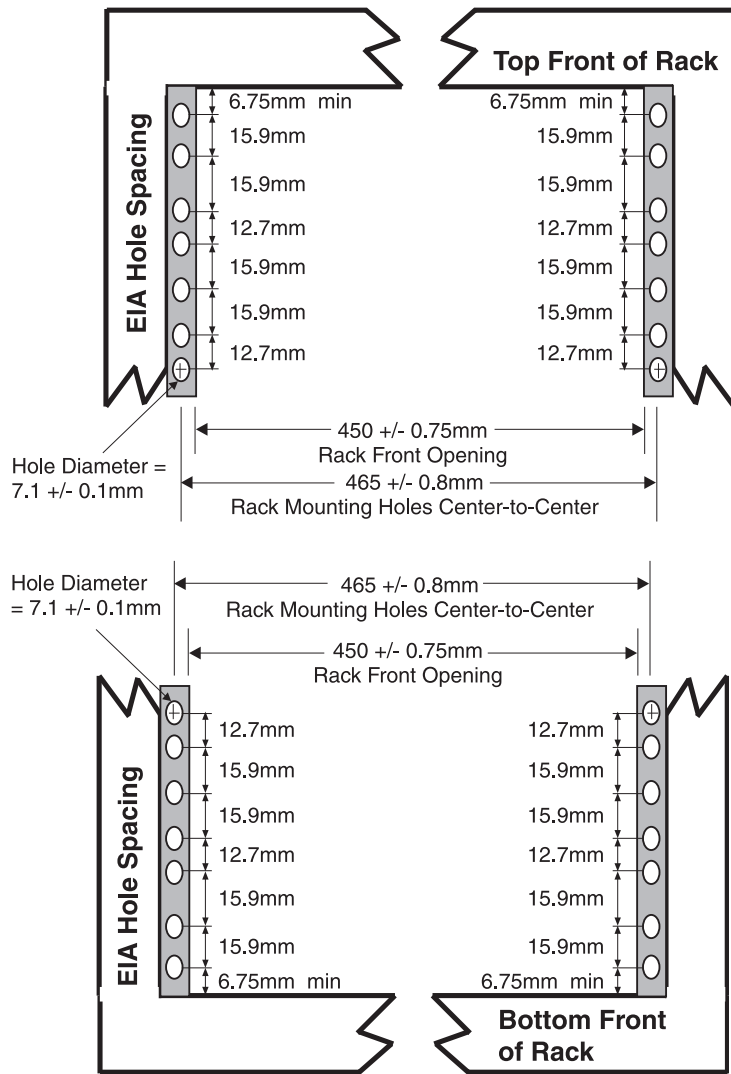

The front rack opening must be 535 mm (21.06 in.) wide for dimension C (the width between the outsides of the standard mounting flanges, see Figure 42 on page 69). The back rack opening must be 500 mm (19.69 in.) wide for dimension C (the width between the outsides of the standard mounting flanges).

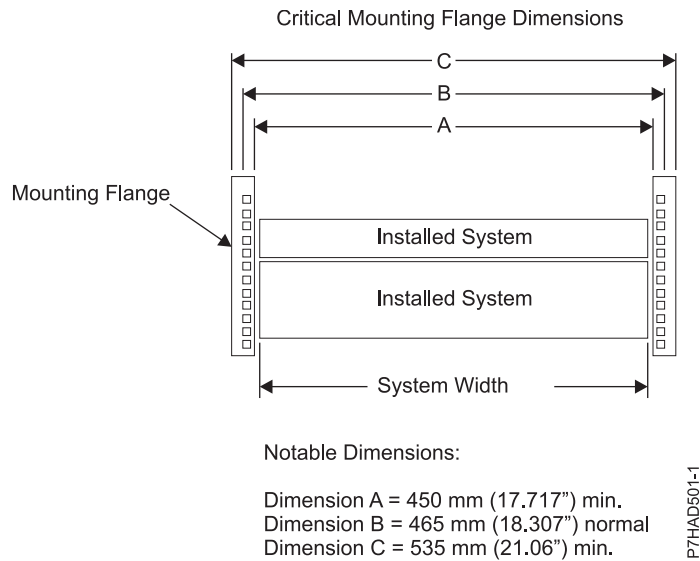
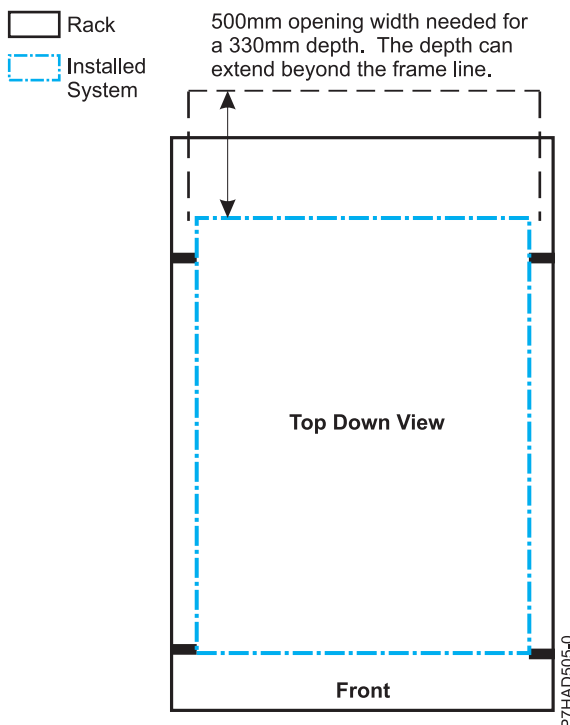

Figure 42. Critical mounting flange dimensions

- A minimum rack opening width of 500 mm (19.69 in.) for a depth of 330 mm (12.99 in.) is needed behind the installed system for maintenance and service. The depth can extend beyond the rack rear door. The 9080-MHE, 9080-MME, 9119-MHE, or 9119-MME server node needs at least 254 mm (10 in.) of depth within the rack from the rear rack mount flange to the frame line. This space is necessary for cable management.

Note: Power distribution units (PDUs) should be mounted horizontally in the U space so that the additional width of the rack can also be used for the 9080-MHE and 9119-MHE or 9080-MME and 9119-MME system cable management. If PDUs are mounted vertically in the side pockets, extra space is required either 2U below the server drawer or through an extra 127 mm (5 in.) of depth within the rack from the rear rack mount flange to the frame line.



- The rack or cabinet must be capable of supporting an average load of 15.9 kg (35 lb) of product weight per EIA unit.

For example, a four EIA drawer has a maximum drawer weight of 63.6 kg (140 lb).

The following rack hole sizes are supported for racks where IBM hardware is mounted:

- 7.1 mm plus or minus 0.1 mm
- 9.5 mm plus or minus 0.1 mm

- All parts that are shipped with the Power Systems products must be installed.
- Only ac power drawers are supported in the rack or cabinet. It is strongly recommended to use a power distribution unit that meets the same specifications as IBM power distribution units to supply rack power (for example, feature code 7188). Rack or cabinet power distribution devices must meet the drawer voltage, amperage, and power requirements, as well as that of any additional products that are connected to the same power distribution device.

The rack or cabinet power receptacle (power distribution unit, uninterruptible power supply, or multi-outlet strip) must have a compatible plug type for your drawer or device.

- The rack or cabinet must be compatible with the drawer-mounting rails. The rail-mounting pins and screws should fit securely and snugly into the rack or cabinet rail-mounting holes. It is strongly recommended that the IBM mounting rails and mounting hardware that are included with the product be used to install it in the rack. The mounting rails and mounting hardware that are provided with IBM products have been designed and tested to safely support the product during operation and service activities as well as to safely support the weight of your drawer or device. The rails must facilitate service access by allowing the drawer to be safely extended, if necessary, forward, backward, or both. Some rails, with IBM features for non-IBM racks, provide drawer-specific anti-tip brackets, rear lock-down brackets, and cable management guides that require clearance on the rear side of the rails.

Note: If the rack or cabinet has square holes on the mounting flanges, a plug-in hole adapter might be required.

If non-IBM rails are used, the rails must be product-safety certified for use with the IBM products. At a minimum, mounting rails must be able to support four times the maximum rated product weight in its worst-case position (fully extended front and rear positions) for one full minute without catastrophic failure.

- The rack or cabinet must have stabilization feet or brackets installed both in the front and rear of the rack, or have another means of preventing the rack/cabinet from tipping while the drawer or device is pulled into its extreme front or rear service positions.

Note: Examples of some acceptable alternatives: The rack or cabinet might be securely bolted to the floor, ceiling or walls, or to adjacent racks or cabinets in a long and heavy row of racks or cabinets.

- There must be adequate front and rear service clearances (in and around the rack or cabinet). The rack or cabinet must have sufficient horizontal width clearance in the front and rear to allow the drawer to be fully slid into the front and, if applicable, the rear service access positions (typically this requires 914.4 mm (36 in.) clearance in both the front and rear).
- If present, front and rear doors must be able to open far enough to provide unrestrained access for service or be easily removable. If doors must be removed for service, it is the customer's responsibility to remove them before service.
- The rack or cabinet must provide adequate clearance around the rack drawer.
- There must be adequate clearance around the drawer bezel so that it can be opened and closed, according to the product specifications.
- Front or rear doors must also maintain a minimum of 51 mm (2 in.) front, 203 mm (8 in.) rear, door to mounting flange clearance, and 494 mm (19.4 in.) front, 571 mm (22.5 in.) rear, side-to-side clearance for drawer bezels and cables.
- The rack or cabinet must provide adequate front-to-back ventilation.

Note: For optimum ventilation, it is recommended the rack or cabinet not have a front door. If the rack or cabinet has doors, the doors must be fully perforated so that there is proper front-to-back airflow to maintain the required drawer ambient inlet temperature as specified in the server specifications. The perforations should yield at least 34 % minimum open area per square inch. Rear doors should not create back pressure that can interfere with server fan operation.

General safety requirements for IBM products installed in a non-IBM rack or cabinet

The general safety requirements for IBM products that are installed in non-IBM racks are:

- Any product or component that plugs into either an IBM power distribution unit or mains power (via a power cord), or uses any voltage over 42 V ac or 60 V dc (considered to be hazardous voltage) must be Safety Certified by a Nationally Recognized Test Laboratory (NRTL) for the country in which it is installed.

Some of the items that require safety certification might include: the rack or cabinet (if it contains electrical components integral to the rack or cabinet), fan trays, power distribution unit, uninterruptible power supplies, multi-outlet strips, or any other products that are installed in the rack or cabinet that connect to hazardous voltage.

Examples of OSHA-approved NRTLs for the US:

- UL
- ETL
- CSA (with CSA NRTL or CSA US mark)

Examples of approved NRTLs for Canada:

- UL (ULc mark)
- ETL (ETLc mark)
- CSA

The European Union requires a CE mark and a Manufacturer's Declaration of Conformity (DOC).

Certified products should have the NRTL logos or marks somewhere on the product or product label. However, proof of certification must be made available to IBM upon request. Proof consists of such items as copies of the NRTL license or certificate, a CB Certificate, a Letter of Authorization to apply the NRTL mark, the first few pages of the NRTL certification report, Listing in an NRTL publication, or a copy of the UL Yellow Card. Proof should contain the manufacturer's name, product type, and model, standard to which it was certified, the NRTL name or logo, the NRTL file number or license number, and a list of any Conditions of Acceptance or Deviations. A Manufacturer's Declaration is not proof of certification by an NRTL.

- The rack or cabinet must meet all electrical and mechanical safety legal requirements for the country in which it is installed. The rack or cabinet must be free of exposed hazards (such as voltages over 60 V dc or 42 V ac, energy over 240 VA, sharp edges, mechanical pinch points, or hot surfaces).
- There must be an accessible and unambiguous disconnect device for each product in the rack, including any power distribution unit.

A disconnect device might consist of either the plug on the power cord (if the power cord is no longer than 1.8 m (6 ft)), the appliance inlet receptacle (if the power cord is of a detachable type), or a power on/off switch, or an Emergency Power Off switch on the rack, provided all power is removed from the rack or product by the disconnect device.

If the rack or cabinet has electrical components (such as fan trays or lights), the rack must have an accessible and unambiguous disconnect device.

- The rack or cabinet, power distribution unit and multi-outlet strips, and products that are installed in the rack or cabinet must all be properly grounded to the customer facility ground.

There must be no more than 0.1 Ohms between the ground pin of the power distribution unit or rack plug and any touchable metal or conductive surface on the rack and on the products that are installed in the rack. Grounding method must comply with applicable country's electric code (such as NEC or

CEC). Ground continuity can be verified by your IBM service personnel, after the installation is completed, and should be verified before the first service activity.

- The voltage rating of the power distribution unit and multi-outlet strips must be compatible with the products plugged into them.

The power distribution unit or multi-outlet strips current and power ratings are rated at 80% of the building supply circuit (as required by the National Electrical Code and the Canadian Electrical Code). The total load that is connected to the power distribution unit must be less than the rating of the power distribution unit. For example, a power distribution unit with a 30 A connection is rated for a total load of 24 A (30 A × 80 %). Therefore, the sum of all equipment that is connected to the power distribution unit in this example must be lower than the 24 A rating.

If an uninterruptible power supply is installed, it must meet all the electrical safety requirements as described for a power distribution unit (including certification by an NRTL).

- The rack or cabinet, power distribution unit, uninterruptible power supply, multi-outlet strips, and all products in the rack or cabinet must be installed according to the manufacturer's instructions, and in accordance with all national, state or province, and local codes and laws.

The rack or cabinet, power distribution unit, uninterruptible power supply, multi-outlet strips, and all products in the rack or cabinet must be used as intended by the manufacturer (per manufacturer's product documentation and marketing literature).

- All documentation for use and installation of the rack or cabinet, power distribution unit, uninterruptible power supply, and all products in the rack or cabinet, including safety information, must be available onsite.
- If there is more than one source of power in the rack cabinet, there must be clearly visible safety labels for Multiple Power Source (in the languages that are required for the country in which the product is installed).
- If the rack or cabinet or any products that are installed in the cabinet had safety or weight labels that are applied by the manufacturer, they must be intact and translated into the languages that are required for the country in which the product is installed.
- If the rack or cabinet has doors, the rack becomes a fire enclosure by definition and must meet the applicable flammability ratings (V-0 or better). Totally metal enclosures at least 1 mm (0.04 in.) thick are considered to comply.

Nonenclosure (decorative) materials must have a flammability rating of V-1 or better. If glass is used (such as in rack doors) it must be safety glass. If wood shelves are used in the rack/cabinet, they must be treated with a UL Listed flame-retardant coating.

- The rack or cabinet configuration must comply with all IBM requirements for "safe to service" (contact your IBM Installation Planning Representative for assistance in determining if the environment is safe). There must be no unique maintenance procedures or tools that are required for service.

Elevated service installations, where the products to be serviced are installed between 1.5 m and 3.7 m (5 ft and 12 ft) above the floor, require the availability of an OSHA- and CSA-approved nonconductive step ladder or ladders. If a ladder or ladders are required for service, the customer must supply the OSHA- and CSA- approved nonconductive step ladder (unless other arrangements have been made with the local IBM Service Branch Office). Some products can have rack installation limitations. Refer to the specific server or product specifications for any restrictions. Products that are installed over 2.9 m (9 ft) above the floor require a Special Bid to be completed before they can be serviced by IBM service personnel.

For products not intended for rack-mounting to be serviced by IBM, the products and parts that are replaced as part of that service must not weigh over 11.4 kg (25 lb) Contact your Installation Planning Representative if in doubt.

There must not be any special education or training that is required for safe servicing of any of the products that are installed in the racks. Contact your Installation Planning Representative if you are in doubt.

Planning for power

Planning the power for your system requires knowledge of your server's power requirements, the power requirements of compatible hardware, and the uninterruptible power supply needs for your server. Use this information to build a complete power plan.

Before you begin your planning tasks, be sure you have completed the items in the following checklist:

- Know your server power requirements.
- Know your compatible hardware requirements.
- Know your uninterruptible power supply needs.

Review power considerations

Complete the following checklist:

- Consult a qualified electrician regarding power needs.
- Determine an uninterruptible power supply vendor.
- Complete your server information form or forms.

Determining your power requirements

Use these guidelines to ensure that your server has the proper power to operate.

Your server can have power requirements different from a PC (such as, different voltage and different plugs). IBM supplies power cords with an attached plug that corresponds to the power outlet most commonly used in the country or region to which the product is being shipped. You are responsible for supplying the proper power outlets.

- Plan for system electrical service. For information on power requirements for a specific model, refer to the electrical section in the server specifications for that particular server. For information on power requirements for expansion units or peripherals, select the appropriate device from the list of compatible hardware specifications. For equipment not listed, check your equipment documentation (owner's manuals) for specifications.
- Determine your server's plug and receptacle types: By model so you can have the proper outlets installed.

Tip: Print a copy of your plug and receptacle table and give it to your electrician. The table contains information needed for installing outlets.

- Write down power information in your Server Information Form 3A. Include:
 - Plug type
 - Input voltage
 - Power cord length (optional)
- Plan for power outages. Consider purchasing an uninterruptible power supply to protect your system against power fluctuations and outages. If your company owns a uninterruptible power supply, involve your uninterruptible power supply vendor with any type of uninterruptible power supply modification.
- Plan an emergency power-off switch. As a safety precaution, you should provide some method for disconnecting power to all equipment in your server area. Put emergency power-off switches in locations readily accessible to your systems operator and at designated exits from the room.
- Ground your system. Electrical grounding is important both for safety and correct operation. Your electrician should follow your national and local electrical codes when installing the electrical wiring, outlets, and power panels. These codes take precedence over any other recommendations.

Use the following tables to determine the appropriate power cord to use with your system in your country.

Table 76 lists power cords to use from the server to the power mains. These power cords are not used with IBM supplied PDUs.

Table 77 on page 81 lists power cords that connect IBM servers to a PDU.

Table 76. Supported power cords for POWER8® systems¹







Feature codes (FC)	Description	Voltage, amperage, and length	IBM shipped plug	Matched female wall receptacle (on wall)	IBM part number
6460	Type 4 NEMA 5-15 plug	120 - 127 V ac, 12 A, 4.3 m (14 ft)	Plug type 4 	Receptacle type 4 	39M5513
6469	Type 5 NEMA 6-15 plug	200 - 240 V ac, 12 A (15 A derated), 4.3 m (14 ft)	Plug type 5 	Receptacle type 5 	39M5096
6470	Type 4 NEMA 5-15 plug	100 - 127 V ac, 12 A, 1.8 m (6 ft)	Plug type 4 	Receptacle type 4 	39M5080
6471	Type 70 INMETRO NBR 6147	100 - 127 V ac, 15 A, 2.7 m (9 ft)	Plug type 70 	Receptacle type 70 	39M5233
6472	Type 18 CEE (7) VII	200 - 240 V ac, 10 A, 2.7 m (9 ft)	Plug type 18 	Receptacle type 18 	39M5123

Table 76. Supported power cords for POWER8® systems¹ (continued)



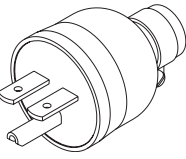
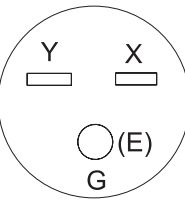

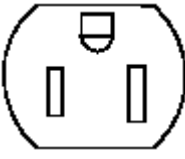
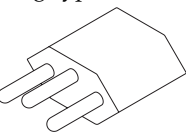
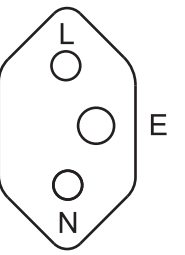
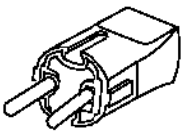



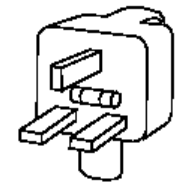

Feature codes (FC)	Description	Voltage, amperage, and length	IBM shipped plug	Matched female wall receptacle (on wall)	IBM part number
6473	Type 19 DK2-5a/S	200 - 240 V ac, 10 A, 2.7 m (9 ft)	Plug type 19 	Receptacle type 19 	39M5130
6474	Type 23 BS1363/A	200 - 240 V ac, 10 A, 2.7 m (9 ft)	Plug type 23 	Receptacle type 23 	39M5151
6475	Type 79 SI 32 or Type 32	200 - 240 V ac, 10 A, 2.7 m (9 ft)	Plug type 32 	Receptacle type 32 	39M5172
6476	Type 24 1011-S24507	200 - 240 V ac, 10 A, 2.7 m (9 ft)	Plug type 24 	Receptacle type 24 	39M5158
6477	Type 23 BS1363/A or Type 22 SANS 1661/SABS 164	200 - 240 V ac, 10 A, 2.7 m (9 ft)	Plug type 22 	Receptacle type 22 	39M5144
6478	Type 25 CEI 23-16	200 - 240 V ac, 10 A, 2.7 m (9 ft)	Plug type 25 	Receptacle type 25 	39M5165

Table 76. Supported power cords for POWER8® systems¹ (continued)





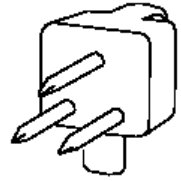
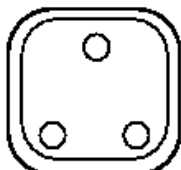

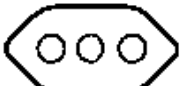

Feature codes (FC)	Description	Voltage, amperage, and length	IBM shipped plug	Matched female wall receptacle (on wall)	IBM part number
6479	Type 6 AS/NZS 3112:2000	200 - 240 V ac, 10 A, 2.7 m (9 ft)	Plug type 6 	Receptacle type 6 	39M5103
6488	Type 2 IRAM 2073	200 - 240 V ac, 10 A, 2.7 m (9 ft)	Plug type 2 	Receptacle type 2 	39M5068
6493	Type 62 GB 2099.1, 1002	200 - 240 V ac, 10 A, 2.7 m (9 ft)	Plug type 62 	Receptacle type 62 	39M5206
6494	Type 69 IS 6538	200 - 240 V ac, 16 A, 2.7 m (9 ft)	Plug type 69 	Receptacle type 69 	39M5226
6495	Type 73	200 - 240 V ac, 10 A, 2.7 m (9 ft)	Plug type 73  UNIAO CERTIFICADORA Type 73 nonlocking IPHAD940-0	Receptacle type 73 	39M5240
6496	Type 66 KSC 8305, K60884-1	200 - 240 V ac, 15 A, 2.7 m (9 ft)	Plug type 66 	Receptacle type 66 	39M5219

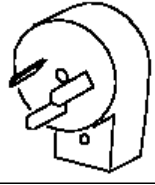
Table 76. Supported power cords for POWER8® systems¹ (continued)

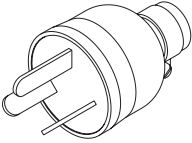
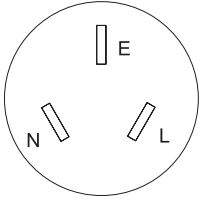
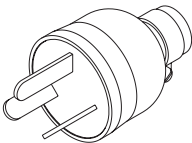
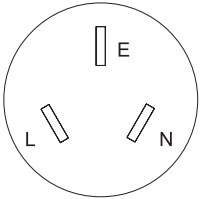



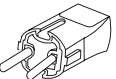







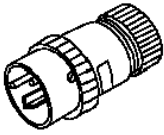

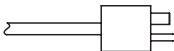
Feature codes (FC)	Description	Voltage, amperage, and length	IBM shipped plug	Matched female wall receptacle (on wall)	IBM part number
6497	Type NEMA L6-15P	200 - 240 V ac, 15 A, 1.8 m (6 ft)	Plug type 10 	Receptacle type 10 	41V1961
6498	Type 34	200 - 240 V ac, 12 A, 1.8 m (6 ft), water-resistant	Plug type 34 	Receptacle type 34 	73F4931
6651	Type 75 CNS 10917-3	100 - 127 V ac, 15 A, 2.7 m (9 ft)	Plug type 75 	Receptacle type 75 	39M5463
6659	Type 76 CNS 10917-3	200 - 240 V ac, 15 A, 2.7 m (9 ft)	Plug type 76 	Receptacle type 76 	39M5254
6660	Type 59 JIS C8303 C8306	100 - 127 V ac, 15 A, 2.7 m (9 ft)	Plug type 59 	Receptacle type 59 	39M5200
6665	Type 61	200 - 240 V ac, 10 A, 3.0 m (10 ft)	Plug type 61 	Receptacle type 61 	39M5392
6669	Type 57 JIS C8303 C8306	250 V ac, 15 A, 4.3 m (14 ft)	Plug type 57 	Receptacle type 57 	39M5187

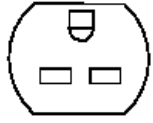
Table 76. Supported power cords for POWER8® systems¹ (continued)

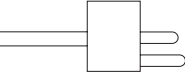
Feature codes (FC)	Description	Voltage, amperage, and length	IBM shipped plug	Matched female wall receptacle (on wall)	IBM part number
6672	Type 26	200 -240 V ac, 10 A, 1.5 m (5 ft)	Plug type 26  IPHAD941-0	Receptacle type 26  IPHAD989-0	39M5375
6680	Type 6 AS/NZS 3112:2000	250 V ac, 10 A, 2.7 m (9 ft)	Plug type 6 	Receptacle type 6 	39M5102
EPAD ²	Type Rong Feng RF-203P	192 - 400 V dc, 10 A, 2.5 m (8 ft)	HVDC plug HVDC plug 	HVDC receptacle HVDC receptacle 	00RR617
EB3H	DC power cable ³ , ⁴	-48 V dc, 25 A, 3 m (10 ft)	Multi-Beam XLX 3 position connector 	Two-hole, standard barrel lug ⁵ 	00RR437

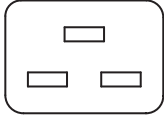
Notes:

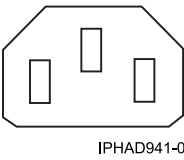
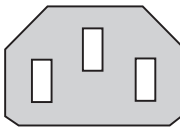
1. The part numbers that are mentioned in this table meet the European Union Directive 2002/95/EC on the Restriction of the Use of Certain Hazardous Substances in Electrical and Electronic Equipment.
2. FC EPAC can be used to allow IBM Manufacturing to select a length of cord (1.0 m (3.3 ft), 1.5 m (4.9 ft), or 2.5 m (8 ft)) during rack integration.
3. FC EB3H includes a 750 watt power supply and circuit breaker for FC EPB8 (power distribution panel).
4. Wire size is 10 AWG (American Wire Gauge).
5. FC EB3H attaches to FC EPB8.

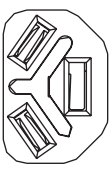
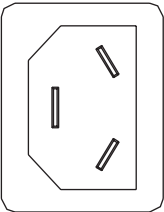
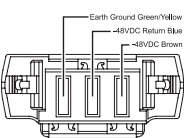
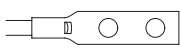
Table 77. Supported server to PDU power cords on POWER8 systems

Feature codes (FC)	Description	Voltage, amperage, and length	Power cord (left end)	Power cord (right end)	IBM part number
4558	IEC 320 C19/C20	200-240 V ac, 16 A, 2.5 m (8 ft)	Plug Type 56 IEC 320 C20 	Plug Type 61 IEC 320 C19 	39M5389
6458	Type 26 IEC320 C13/C14	200-240 V ac, 10 A, 4.3 m (14 ft)	Connector Type 26 IEC 320 C13  IPHAD941-0	Plug Type 26 IEC 320 C14  IPHAD989-0	39M5378
6665	IEC 320 C13/C20	200-240 V ac, 10 A, 4.3 m (9 ft)	Connector Type 26 IEC 320 C13  IPHAD941-0	Plug Type 56 IEC 320 C20 	39M5392

Table 78. Supported power cords by countries

FC	Supported countries
6460	American Samoa, Antigua and Barbuda, Aruba, Bahamas, Barbados, Belize, Bermuda, Bolivia, Canada, Cayman Islands, Columbia, Costa Rica, Cuba, Dominican Republic, Ecuador, El Salvador, Guam, Guatemala, Haiti, Honduras, Jamaica, Marshall Islands, Mexico, Micronesia (Federal States of), Montserrat, Netherlands Antilles, Nicaragua, Northern Mariana Islands, Palau, Panama, Peru, Philippines, Puerto Rico, San Marino, Saudi Arabia, Thailand, Turks and Caicos Islands, United States, Venezuela
6470	American Samoa, Antigua and Barbuda, Aruba, Bahamas, Barbados, Belize, Bermuda, Bolivia, Canada, Cayman Islands, Columbia, Costa Rica, Cuba, Dominican Republic, Ecuador, El Salvador, Guam, Guatemala, Haiti, Honduras, Jamaica, Marshall Islands, Mexico, Micronesia (Federal States of), Montserrat, Netherlands Antilles, Nicaragua, Northern Mariana Islands, Palau, Panama, Peru, Philippines, Puerto Rico, San Marino, Saudi Arabia, Thailand, Turks and Caicos Islands, United States, Venezuela
6471	Brazil

Table 78. Supported power cords by countries (continued)

FC	Supported countries
6472	Afghanistan, Albania, Algeria, American Samoa, Andorra, Angola, Antarctica, Armenia, Austria, Azerbaijan, Belarus, Belgium, Benin, Bhutan, Bosnia and Herzegovina, Bulgaria, Burkina Faso, Burundi, Cambodia, Cameroon, Cape Verde, Central African Republic, Chad, Christmas Islands, Cocos (Keeling) Islands, Comoros, Congo (Democratic Republic of), Congo (Republic of), Cote D'Ivoire (Ivory Coast), Croatia (Republic of), Czech Republic, Djibouti, Egypt, Equatorial Guinea, Eritrea, Estonia, Ethiopia, Faroe Islands, Finland, France, French Guyana, French Polynesia, Gabon, Georgia, Germany, Gibraltar, Greece, Greenland, Guadeloupe, Guinea, Guinea Bissau, Holy See (Vatican City State), Hungary, Iceland, Indonesia, Iran (Islamic Republic of), Kazakhstan, Kyrgyzstan, Laos (Peoples Democratic Republic of), Latvia, Lebanon, Lithuania, Luxembourg, Macedonia (former Yugoslav Republic of), Madagascar, Mali, Martinique, Mauritania, Mauritius, Mayotte, Moldova (Republic of), Monaco, Mongolia, Morocco, Mozambique, Netherlands, New Caledonia, Niger, Norfolk Island, Norway, Poland, Portugal, Reunion, Romania, Russian Federation, Rwanda, Saint Pierre and Miquelon, Sao Tome and Principe, Saudi Arabia, Senegal, Serbia and Montenegro, Slovakia, Slovenia (Republic of), Solomon Islands, Somalia, Spain, Suriname, Svalbard and Jan Mayen, Sweden, Syrian Arab Republic, Tajikistan, Timor-Leste, Togo, Tunisia, Turkey, Turkmenistan, Tuvalu, Ukraine, Uzbekistan, Vanuatu, Vietnam, Wallis and Futuna, Western Sahara
6473	Denmark, Falkland Islands (Malvinas), Faroe Islands
6474	Bahrain, Bangladesh, Bhutan, Botswana, British Indian Ocean Territory, Brunei Darussalam, Cyprus, Dominica, Falkland Islands (Malvinas), Gambia, Ghana, Gibraltar, Grenada, Guyana, Hong Kong S.A.R. of the PRC, Iraq, Ireland, Jordan, Kenya, Kuwait, Lesotho, Liberia, Macao S.A.R. of the PRC, Malawi, Malaysia, Maldives, Malta, Myanmar, Namibia, Nepal, Nigeria, Oman, Pakistan, Pitcairn, Qatar, Saint Helena, Saint Kitts and Nevis, Saint Lucia, Saint Vincent and the Grenadines, Samoa, Seychelles, Sierra Leone, Singapore, South Africa, Sudan, Swaziland, Tanzania (United Republic of), Timor-Leste, Trinidad and Tobago, Uganda, United Arab Emirates, United Kingdom, Yemen, Zambia, Zimbabwe
6475	Israel
6476	Liechtenstein, Switzerland
6477	Bahrain, Bangladesh, Bhutan, Botswana, British Indian Ocean Territory, Brunei Darussalam, Cyprus, Dominica, Falkland Islands (Malvinas), Gambia, Ghana, Gibraltar, Grenada, Guyana, Hong Kong S.A.R. of the PRC, Iraq, Ireland, Jordan, Kenya, Kuwait, Lesotho, Liberia, Macao S.A.R. of the PRC, Malawi, Malaysia, Maldives, Malta, Myanmar, Namibia, Nepal, Nigeria, Oman, Pakistan, Pitcairn, Qatar, Saint Helena, Saint Kitts and Nevis, Saint Lucia, Saint Vincent and the Grenadines, Samoa, Seychelles, Sierra Leone, Singapore, South Africa, Sudan, Swaziland, Tanzania (United Republic of), Timor-Leste, Trinidad and Tobago, Uganda, United Arab Emirates, United Kingdom, Yemen, Zambia, Zimbabwe
6478	Chile, Holy See (Vatican City State), Italy, Libyan Arab Jamahiriya
6479	Australia, New Zealand
6488	Argentina, Paraguay, Uruguay

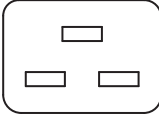
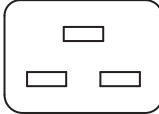
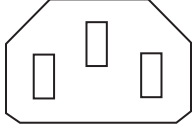
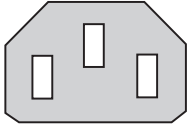
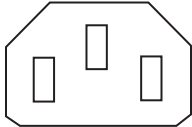
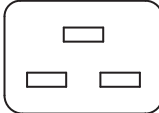
Table 78. Supported power cords by countries (continued)

FC	Supported countries
6489	<p>Afghanistan, Albania, Algeria, Andorra, Angola, Antarctica, Antigua and Barbuda, Argentina, Armenia, Azerbaijan, Bahrain, Bangladesh, Belarus, Belgium, Belize, Benin, Bhutan, Bolivia, Bosnia and Herzegovina, Botswana, Bouvet Island, Brazil, British Indian Ocean Territory, Brunei Darussalam, Bulgaria, Burkina Faso, Burundi, Cambodia, Cameroon, Cape Verde, Central African Republic, Chad, Chile, China, Christmas Island, Cocos (Keeling) Islands, Comoros, Congo, Congo (The Democratic Republic of the), Cook Islands, Cote D'Ivoire (Ivory Coast), Croatia (Republic of), Cuba, Cyprus, Djibouti, Dominica, Egypt, Equatorial Guinea, Eritrea, Ethiopia, Falkland Islands (Malvinas), Faroe Islands, Fiji, France, French Guyana, French Southern Territories, Gabon, Gambia, Georgia, Germany, Ghana, Gibraltar, Greece, Greenland, Grenada, Guadeloupe, Guinea, Guinea-Bissau, Guyana, Heard Island and McDonald Islands, Holy See (Vatican City State), Hong Kong, Hungary, Iceland, India, Indonesia, Iran (Islamic Republic of), Iraq, Ireland, Italy, Jordan, Kazakhstan, Kenya, Kiribati, Kuwait, Kyrgyzstan, Laos (Peoples Democratic Republic of), Lebanon, Lesotho, Libyan Arab Jamahiriya, Luxembourg, Macao, Macedonia (The former Yugoslav Republic of), Madagascar, Malawi, Malaysia, Maldives, Mali, Malta, Mauritania, Mauritius, Mayotte, Moldova (Republic of), Monaco, Mongolia, Montserrat, Morocco, Mozambique, Myanmar, Namibia, Nauru, Nepal, Netherlands, Netherlands Antilles, New Caledonia, Niger, Nigeria, Niue, Norfolk Island, Northern Mariana Islands, Norway, Oman, Pakistan, Palestinian Territory, Papua New Guinea, Paraguay, Pitcairn, Poland, Portugal, Qatar, Reunion, Romania, Rwanda, Saint Helena, Saint Kitts and Nevis, Saint Lucia, Saint Pierre and Miquelon, Saint Vincent and the Grenadines, Samoa, Saudi Arabia, Senegal, Serbia and Montenegro, Seychelles, Sierra Leone, Singapore, Slovakia, Slovenia (Republic of), Solomon Islands, Somalia, South Africa, South Georgia and the South Sandwich Islands, Spain, Sri Lanka, Sudan, Suriname, Svalbard and Jan Mayen, Swaziland, Syrian Arab Republic, Tajikistan, Tanzania (United Republic of), Thailand, Timor-Leste, Togo, Tokelau, Tonga, Tunisia, Turkey, Turkmenistan, Tuvalu, Uganda, Ukraine, United Arab Emirates, United Kingdom, Uruguay, Uzbekistan, Vanuatu, Vietnam, Virgin Islands (British), Wallis and Futuna, Western Sahara, Yemen, Zambia, Zimbabwe</p>
6491	<p>Afghanistan, Albania, Algeria, Andorra, Angola, Antarctica, Antigua and Barbuda, Argentina, Armenia, Azerbaijan, Bahrain, Bangladesh, Belarus, Belgium, Belize, Benin, Bhutan, Bolivia, Bosnia and Herzegovina, Botswana, Bouvet Island, Brazil, British Indian Ocean Territory, Brunei Darussalam, Bulgaria, Burkina Faso, Burundi, Cambodia, Cameroon, Cape Verde, Central African Republic, Chad, Chile, China, Christmas Island, Cocos (Keeling) Islands, Comoros, Congo, Congo (The Democratic Republic of the), Cook Islands, Cote D'Ivoire (Ivory Coast), Croatia (Republic of), Cuba, Cyprus, Djibouti, Dominica, Egypt, Equatorial Guinea, Eritrea, Ethiopia, Falkland Islands (Malvinas), Faroe Islands, Fiji, France, French Guyana, French Southern Territories, Gabon, Gambia, Georgia, Germany, Ghana, Gibraltar, Greece, Greenland, Grenada, Guadeloupe, Guinea, Guinea-Bissau, Guyana, Heard Island and McDonald Islands, Holy See (Vatican City State), Hong Kong, Hungary, Iceland, India, Indonesia, Iran (Islamic Republic of), Iraq, Ireland, Italy, Jordan, Kazakhstan, Kenya, Kiribati, Kuwait, Kyrgyzstan, Laos (Peoples Democratic Republic of), Lebanon, Lesotho, Libyan Arab Jamahiriya, Luxembourg, Macao, Macedonia (The former Yugoslav Republic of), Madagascar, Malawi, Malaysia, Maldives, Mali, Malta, Mauritania, Mauritius, Mayotte, Moldova (Republic of), Monaco, Mongolia, Montserrat, Morocco, Mozambique, Myanmar, Namibia, Nauru, Nepal, Netherlands, Netherlands Antilles, New Caledonia, Niger, Nigeria, Niue, Norfolk Island, Northern Mariana Islands, Norway, Oman, Pakistan, Palestinian Territory, Papua New Guinea, Paraguay, Pitcairn, Poland, Portugal, Qatar, Reunion, Romania, Rwanda, Saint Helena, Saint Kitts and Nevis, Saint Lucia, Saint Pierre and Miquelon, Saint Vincent and the Grenadines, Samoa, Saudi Arabia, Senegal, Serbia and Montenegro, Seychelles, Sierra Leone, Singapore, Slovakia, Slovenia (Republic of), Solomon Islands, Somalia, South Africa, South Georgia and the South Sandwich Islands, Spain, Sri Lanka, Sudan, Suriname, Svalbard and Jan Mayen, Swaziland, Syrian Arab Republic, Tajikistan, Tanzania (United Republic of), Thailand, Timor-Leste, Togo, Tokelau, Tonga, Tunisia, Turkey, Turkmenistan, Tuvalu, Uganda, Ukraine, United Arab Emirates, United Kingdom, Uruguay, Uzbekistan, Vanuatu, Vietnam, Virgin Islands (British), Wallis and Futuna, Western Sahara, Yemen, Zambia, Zimbabwe</p>

Table 78. Supported power cords by countries (continued)

FC	Supported countries
6492	Algeria, American Samoa, Anguilla, Antigua and Barbuda, Aruba, Bahamas, Barbados, Belarus, Belize, Bermuda, Bolivia, Brazil, Canada, Cayman Islands, Colombia, Congo, Congo (The Democratic Republic of the), Costa Rica, Cuba, Dominican Republic, Ecuador, El Salvador, French Polynesia, Guam, Guatemala, Haiti, Honduras, Jamaica, Japan, Kazakhstan, Liberia, Mali, Marshall Islands, Martinique, Mexico, Micronesia (Federal States of), Moldova (Republic of), Netherlands Antilles, Nicaragua, Northern Mariana Islands, Palau, Panama, Peru, Philippines, Puerto Rico, San Marino, Sao Tome and Principe, Saudi Arabia, Senegal, Somalia, Taiwan, Trinidad and Tobago, Turks and Caicos Islands, United States, United States Minor Outlying Islands, Venezuela, Vietnam, Virgin Islands (United States)
6493	China
6494	India
6495	Brazil
6496	Korea
6497	United States, Mexico
6498	Japan
6651	Taiwan
6653	Internationally available
6654	Algeria, American Samoa, Anguilla, Antigua and Barbuda, Aruba, Bahamas, Barbados, Belarus, Belize, Bermuda, Bolivia, Brazil, Canada, Cayman Islands, Colombia, Congo, Congo (The Democratic Republic of the), Costa Rica, Cuba, Dominican Republic, Ecuador, El Salvador, French Polynesia, Guam, Guatemala, Haiti, Honduras, Jamaica, Japan, Kazakhstan, Liberia, Mali, Marshall Islands, Martinique, Mexico, Micronesia (Federal States of), Moldova (Republic of), Netherlands Antilles, Nicaragua, Northern Mariana Islands, Palau, Panama, Peru, Philippines, Puerto Rico, San Marino, Sao Tome and Principe, Saudi Arabia, Senegal, Somalia, Taiwan, Trinidad and Tobago, Turks and Caicos Islands, United States, United States Minor Outlying Islands, Venezuela, Vietnam, Virgin Islands (United States)
6655	United States, Canada
6656	Internationally available
6657	Australia, New Zealand
6658	Korea
6659	Taiwan
6660	Japan
6662	Taiwan

Table 78. Supported power cords by countries (continued)

FC	Supported countries
6665	Afghanistan, Albania, Algeria, American Samoa, Andorra, Angola, Anguilla, Antarctica, Antigua and Barbuda, Argentina, Armenia, Aruba, Australia, Austria, Azerbaijan, Bahamas, Bahrain, Bangladesh, Barbados, Belarus, Belgium, Belize, Benin, Bermuda, Bhutan, Bolivia, Bosnia and Herzegovina, Bulgaria, Bouvet Island, Brazil, British Indian Ocean Territory, Brunei Darussalam, Bulgaria, Burkina Faso, Burundi, Cambodia, Cameroon, Canada, Cape Verde, Cayman Islands, Central African Republic, Chad, Chile, China, Christmas Island, Cocos (Keeling) Islands, Colombia, Comoros, Congo, Congo (The Democratic Republic of the), Cook Islands, Costa Rica, Cote D'Ivoire (Ivory Coast), Croatia (Republic of), Cuba, Cyprus, Czech Republic, Denmark, Djibouti, Dominica, Dominican Republic, Ecuador, Egypt, El Salvador, Equatorial Guinea, Eritrea, Estonia, Ethiopia, Falkland Islands (Malvinas), Faroe Islands, Fiji, Finland, France, French Guyana, French Polynesia, French Southern Territories, Gabon, Gambia, Georgia, Germany, Ghana, Gibraltar, Greece, Greenland, Grenada, Guadeloupe, Guam, Guatemala, Guinea, Guinea-Bissau, Guyana, Haiti, Heard Island and McDonald Islands, Holy See (Vatican City State), Honduras, Hong Kong, Hungary, Iceland, India, Indonesia, Iran (Islamic Republic of), Iraq, Ireland, Israel, Italy, Jamaica, Japan, Jordan, Kazakhstan, Kenya, Kiribati, Korea (Democratic Peoples Republic of), Korea (Republic of), Kuwait, Kyrgyzstan, Laos (Peoples Democratic Republic of), Latvia, Lebanon, Lesotho, Liberia, Libyan Arab Jamahiriya, Liechtenstein, Lithuania, Luxembourg, Macao, Macedonia (The former Yugoslav Republic of), Madagascar, Malawi, Malaysia, Maldives, Mali, Malta, Marshall Islands, Martinique, Mauritania, Mauritius, Mayotte, Mexico, Micronesia (Federated States of), Moldova (Republic of), Monaco, Mongolia, Montserrat, Morocco, Mozambique, Myanmar, Namibia, Nauru, Nepal, Netherlands, Netherlands Antilles, New Caledonia, New Zealand, Niger, Nigeria, Niue, Norfolk Island, Northern Mariana Islands, Norway, Oman, Pakistan, Palau, Palestinian Territory, Panama, Papua New Guinea, Paraguay, Peru, Philippines, Pitcairn, Poland, Portugal, Puerto Rico, Qatar, Reunion, Romania, Russian Federation, Rwanda, Saint Helena, Saint Kitts and Nevis, Saint Lucia, Saint Pierre and Miquelon, Saint Vincent and the Grenadines, Samoa, San Marino, Sao Tome and Principe, Saudi Arabia, Senegal, Serbia and Montenegro, Seychelles, Sierra Leone, Singapore, Slovakia, Slovenia (Republic of), Solomon Islands, Somalia, South Africa, South Georgia and the South Sandwich Islands, Spain, Sri Lanka, Sudan, Suriname, Svalbard and Jan Mayen, Swaziland, Sweden, Switzerland, Syrian Arab Republic, Taiwan, Tajikistan, Tanzania (United Republic of), Thailand, Timor-Leste, Togo, Tokelau, Tonga, Trinidad and Tobago, Tunisia, Turkey, Turkmenistan, Turks and Caicos Islands, Tuvalu, Uganda, Ukraine, United Arab Emirates, United Kingdom, United States, United States Minor Outlying Islands, Uruguay, Uzbekistan, Vanuatu, Venezuela, Vietnam, Virgin Islands (British), Virgin Islands (United States), Wallis and Futuna, Western Sahara, Yemen, Zambia, Zimbabwe
6669	Japan
6670	Japan
6680	Australia, Cook Islands, Fiji, Kiribati, Nauru, New Zealand, Niue, Papua New Guinea, Tokelau, Tonga

Supported PDU power cords

Find out which power distribution unit (PDU) power cords are supported for your system.

Use the following table to determine the appropriate PDU power cord to use with your system in your country.

Note: Horizontally mounted PDUs must be used for 9080-MHE, 9080-MME, 9119-MHE, and 9119-MME systems. Vertically mounted PDUs occupy and limit access to the cable routing space on the side of the rack and cannot be used.

Table 79. Supported PDU power cords for POWER8 systems











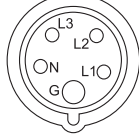
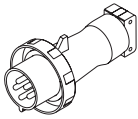
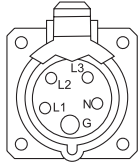

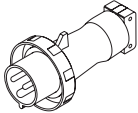

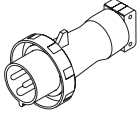
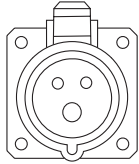

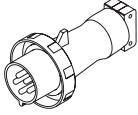
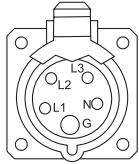
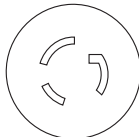
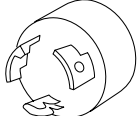
Feature code (FC)	Description <ul style="list-style-type: none"> • Voltage • Amperage • Phase • Length • Wall plug 	IBM shipped plug	View of plug	Matched female connector (on cord)	Matched female wall receptacle (on wall)	IBM part number	Countries
6489	Power cord, PDU to wall <ul style="list-style-type: none"> • 230 V ac output • 32 A • 3 phase wye • 4.3 m (14 ft) • IEC 309, 3P+N+G 	Plug type 532P6W 		Connector type 532C6W	Receptacle type 532R6W 	39M5413	Europe, Middle East, Africa (EMEA)
6491	Power cord, PDU to wall <ul style="list-style-type: none"> • 230 V ac • 63 A • Single phase • 4.3 m (14 ft) • IEC 309, P+N+G 	Plug type 363P6W 		Connector type 363C6W	Receptacle type 363R6W	39M5415	Europe, Middle East, Africa (EMEA)
6492	Power cord, PDU to wall <ul style="list-style-type: none"> • 200 - 208 V ac or 240 V ac • 60 A plug (48 A derated) • Single phase • 4.3 m (14 ft) • IEC 309, 2P+G 	Plug type 360P6W 		Connector type 360C6W	Receptacle type 360R6W 	39M5417	United States, Canada, Latin America, Japan, and Taiwan
6653	Power cord, PDU to wall <ul style="list-style-type: none"> • 230 V ac output • 16 A • 3 phase wye • 4.3 m (14 ft) • IEC 309, 3P+N+G 	Plug type 516P6W 		Connector type 516C6W	Receptacle type 516R6W 	39M5412	Switzerland
6654	Power cord, PDU to wall <ul style="list-style-type: none"> • 200 - 208 V ac or 240 V ac • 30 A plug (24 A derated) • Single phase • 4.3 m (14 ft) • NEMA L6-30 	Plug type NEMA L6-30P 			Receptacle type NEMA L6-30R 	39M5416	United States, Canada, Latin America, Japan, and Taiwan

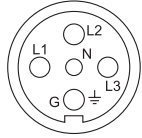
Table 79. Supported PDU power cords for POWER8 systems (continued)

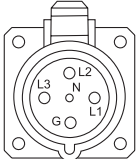
Feature code (FC)	Description <ul style="list-style-type: none"> Voltage Amperage Phase Length Wall plug 	IBM shipped plug	View of plug	Matched female connector (on cord)	Matched female wall receptacle (on wall)	IBM part number	Countries
6655	Power cord, PDU to wall <ul style="list-style-type: none"> 200 - 208 V ac or 240 V ac 30 A plug (24 A derated) Single phase 4.3 m (14 ft) RS 3750DP (Watertight) 					39M5418	United States, Canada, Latin America, Japan, and Taiwan
6656	Power cord, PDU to wall <ul style="list-style-type: none"> 230 V ac 32 A Single phase 4.3 m (14 ft) IEC 309, P+N+G 	Plug type 332P6W 		Connector type 332C6W	Receptacle type 332R6W 	39M5414	Europe, Middle East, Africa (EMEA)
6657	Power cord, PDU to wall <ul style="list-style-type: none"> 230 - 240 V ac 32 A Single phase 4.3 m (14 ft) PDL 	Plug type 56P332 		Connector type 56P332	Receptacle type 56CV332 	39M5419	Australia and New Zealand
6658	Power cord, PDU to wall <ul style="list-style-type: none"> 220 V ac 30 A plug (24 A derated) Single phase 4.3 m (14 ft) Korean plug SJ-P3302 	Plug type KP 32A 		Connector type KP	Receptacle type KP 	39M5420	South Korea

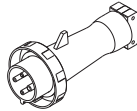
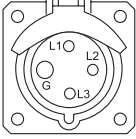
Table 79. Supported PDU power cords for POWER8 systems (continued)

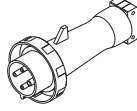
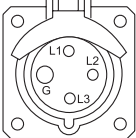
Feature code (FC)	Description <ul style="list-style-type: none"> • Voltage • Amperage • Phase • Length • Wall plug 	IBM shipped plug	View of plug	Matched female connector (on cord)	Matched female wall receptacle (on wall)	IBM part number	Countries
6667	Power cord, PDU to wall <ul style="list-style-type: none"> • 230 - 240 V ac output • 32 A • 3 phase wye • 4.3 m (14 ft) • PDL 56P532 	Plug type 56P532 		Connector type 56R532	Receptacle type 56R532 	69Y1619	Australia and New Zealand
7196	PDU with fixed cord <ul style="list-style-type: none"> • 200 - 208 V ac or 240 V ac • 60 A plug (48 A derated) • 3 phase delta • 4.3 m (14 ft) • IEC 309, 3P+G • Six IEC 320-C19 receptacles 	Plug type 460P9W 		Connector type 460C9W	Receptacle type 460R9W 		United States, Canada, Latin America, Japan, and Taiwan
EPTK/ EPTL	PDU with fixed cord <ul style="list-style-type: none"> • 200 - 208 V ac or 240 V ac • 60 A plug (48 A derated) • 3 phase delta • 4.3 m (14 ft) • IEC 309, 3P+G • Nine IEC 320-C19 receptacle 	Plug type 460P9W 		Connector type 460C9W	Receptacle type 460R9W 		United States, Canada, Latin America, Japan, and Taiwan
EPTP/ EPTQ	PDU with fixed cord <ul style="list-style-type: none"> • 200 - 208 V ac or 240 V ac • 60 A plug (48 A derated) • 3 phase delta • 4.3 m (14 ft) • IEC 309, 3P+G • Twelve IEC 320-C13 receptacles 	Plug type 460P9W 		Connector type 460C9W	Receptacle type 460R9W 		United States, Canada, Latin America, Japan, and Taiwan

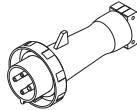
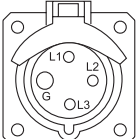
Modification of IBM-provided power cords

Modification of IBM-provided power cords should only be done in rare circumstances, because the power cords provided with IBM systems meet stringent design and manufacturing specifications.

IBM encourages the use of an IBM released power cord because of the specifications that must be met for both the design and manufacture of our IBM power cords. The specifications, the components used in the design, and the manufacturing process is an external safety agency approved process that is audited by safety agencies on a periodic and ongoing basis to ensure quality and compliance with design requirements.

When a server leaves the manufacturing site, it is safety agency listed, therefore, IBM does not recommend modifying IBM-provided power cords. In the rare circumstance where modification of an IBM provided power cord is deemed essential, you should:

- Discuss the modification with their insurance provider to assess the effect, if any, on insurance coverage
- Consult with a professional electrician regarding compliance with local codes

The following excerpts from the Services Reference Manual (SRM) explains IBM policy on power cord alteration and the liabilities involved.

SRM excerpts

A cable group associated with a purchased IBM machine, and bearing an IBM label, is the property of the IBM machine owner. All other IBM furnished cable groups (except those for which specific purchase invoices have been paid) are the property of IBM.

Customers assume all risks associated with turning a machine over to others for the performance of technical work such as, but not limited to, the installation or removal of features, alterations or attachments.

IBM will advise the customer of any limitation, resulting from the alteration, affecting IBM's ability to provide Warranty Service or Maintenance after review by the appropriate Service Delivery and Field Marketing Practices personnel.

Definition of an alteration

An alteration is any change to an IBM machine that deviates from IBM physical, mechanical, electrical, or electronic design (including microcode) whether or not additional devices or parts are used. An alteration is also an interconnection at some place other than an IBM defined interface. See the Multiple Supplier Systems Bulletin for more detail.

For an altered machine, service will be confined to the unaltered portions of the IBM machine.

After inspection, IBM will continue to make Warranty Service or Maintenance available, as appropriate, for the unaltered portion of an IBM machine.

IBM will not maintain the altered portion of an IBM machine under either an IBM Agreement or on an Hourly Service basis.

If you have more questions about power cord modification, contact an IBM service representative.

Uninterruptible power supply

Uninterruptible power supplies are available to meet the power protection needs of IBM servers. The uninterruptible power supply (UPS) is the IBM type 9910.

The IBM 9910 uninterruptible power supply solutions are compatible with the power requirements for Power Systems servers and pass IBM testing procedures. The uninterruptible power supplies are intended to provide a single source for purchase and protection of IBM servers. All 9910 uninterruptible

power supplies include a premium warranty package that is designed to enhance the potential for return on investment over the uninterruptible power supplies available on the market today.

Type 9910 uninterruptible power supply solutions are available from *Eaton*.

For more information about power warning and system shutdown events, or on making changes to the default configuration options such as system shutdown time when a power failure is detected, see:

- AIX®: rc.powerfail Command
- IBM i: Uninterruptible power supply delay time system value

Feature code ECCF (Part number 00FV631) - System Port Converter Cable for UPS

The ECCF is a converter cable that allows for communications from a UPS relay interface card to a service processor USB port. The server has two service processor USB 2.0 ports on the native I/O daughter card that are labeled 1 and 2. Either of these ports (1 or 2) can be used for the ECCF. Only one ECCF is allowed per server. The connectors on the ECCF include a male USB and a female 9-pin D-shell connector. The cable length is 1650 mm (65 inches).

The cable can be connected to either USB port 1 or USB port 2 at any time. It is not necessary to IPL the server for the server to recognize the cable. The cable contains active electronics that tell the service processor that a UPS is attached. The UPS can provide status information (such as UPS on, UPS utility fail, UPS battery low, and UPS bypass) over the cable to the physical hypervisor for broadcast to all partitions.

Notes:

1. The two service processor USB 2.0 ports that are labeled 1 and 2 correspond to location codes Un-P1-C1-T2 and Un-P1-C1-T3. For more information about location codes, see Part locations and location codes.
2. Feature code (FC) ECCF is available for 5148-21L, 5148-22L, 8247-21L, 8247-22L, 8247-42L, 8284-22A, 8286-41A, and 8286-42A systems.
3. The pin layout for the 9-pin D-shell connector is as follows:
 - 5 - Signal ground
 - 6 - UPS bypass
 - 7 - UPS battery low
 - 8 - UPS on
 - 9 - UPS utility fail

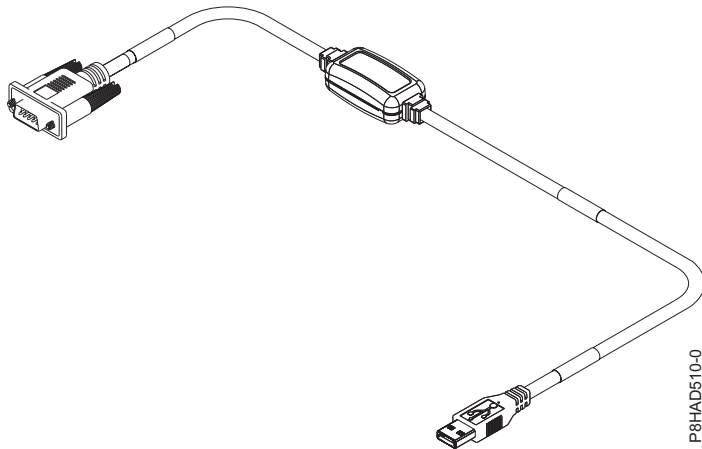

Figure 43. Feature code ECCF

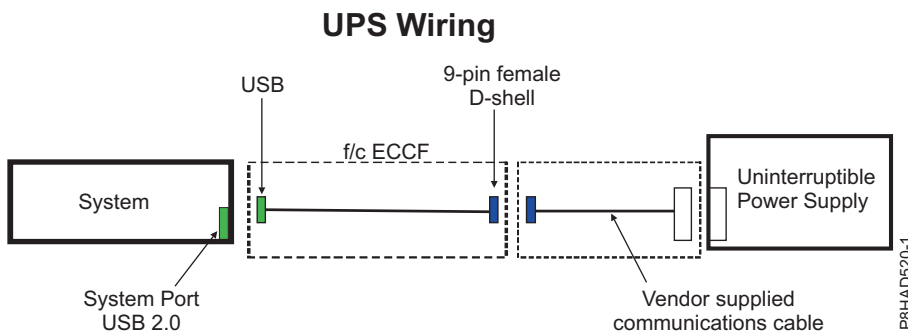

Figure 44. UPS wiring for the 5148-21L, 5148-22L, 8247-21L, 8247-21L, 8247-22L, 8247-42L, 8284-22A, 8286-41A, and 8286-42A

Power distribution unit and power cord options for 0551, 0553, 0555, 7014, 7953, and 7965 racks

Power distribution units (PDUs) can be used with the 0551, 0553, 0555, 7014, 7953, and 7965 racks. The various configurations and specifications are provided.

Power distribution unit

The following figure shows the four vertical PDU locations in a rack.

Note: Horizontally mounted PDUs must be used for 9080-MHE, 9080-MME, 9119-MHE, and 9119-MME systems. Vertically mounted PDUs occupy and limit access to the cable routing space on the side of the rack and cannot be used.

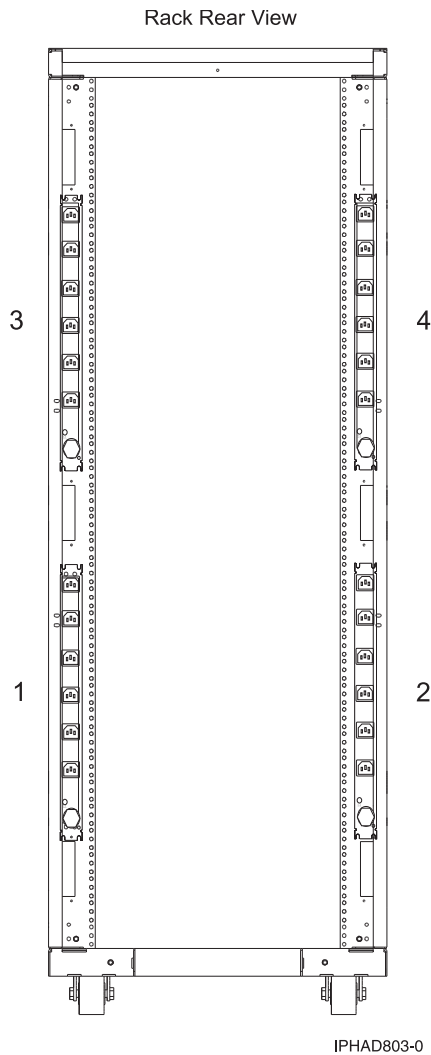

Figure 45. Power distribution unit vertical locations

Power distribution units (PDUs) are required with 7014-T00, 7014-T42 IBM racks and optional with 7014-B42, 0553, and 0555 racks, except with a 0578 or 0588 expansion unit. If a PDU is not defaulted or ordered, a power cord is provided with each individual rack-mounted drawer for connection to a country-specific utility mains receptacle or uninterruptible power supply. See the individual rack-mounted drawer specifications for the appropriate power cords.

7188 or 9188 universal PDU

Table 80. 7188 or 9188 universal PDU features

PDU Number	Racks usage	Supported power cords (PDU to wall)
7188 or 9188 universal PDU	7014-T00, 7014-T42, 7953-94X, 7965-94Y, 0551, 0553, and 0555 racks.	"Supported PDU power cords" on page 85

The amperage rating of the PDU is either 16 A, 24 A, or 48 A, single phase or three-phase, depending on the power cord.

Note: All power cords are 4.3 m (14 ft). For installation in Chicago, only 2.8 m (6 ft) of the 4.3 m (14 ft) power cord can extend beyond the perimeter of the rack frame. If more than 2.8 m (6 ft) can exit the rack,

retain any additional cordage within the rack frame with hook-and-loop fastener ties in the cable management space until 2.8 (6 ft) or less exits the rack.

The PDU has twelve customer-usable IEC 320-C13 outlets that are rated at 200-240 V ac. There are six groups of two outlets that are fed by six circuit breakers. Each outlet is rated up to 10 A (220 - 240 V ac) or 12 A (200 - 208 V ac), but each group of two outlets is fed from one 20 A circuit breaker derated to 16 A.

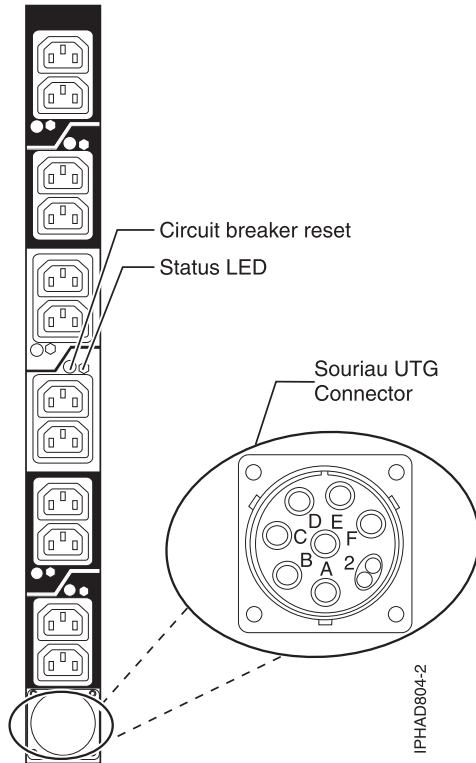

Figure 46. PDU outlet graphic

Typical rack and PDU configurations

See *0551, 0553, 7014, and 0555 rack configurations* for typical configurations and PDUs when the rack is populated with various server models.

Power distribution unit plus specifications

The power distribution unit plus (PDU+) has power-monitoring capabilities. The PDU+ is an intelligent AC power distribution unit (PDU+) that monitors the amount of power that is being used by the devices that are plugged into it. The PDU+ provides twelve C13 power outlets and receives power through a Souriau UTG connector. It can be used in many geographies and for many applications by varying the PDU-to-wall power cord, which must be ordered separately. Each PDU+ requires one PDU-to-wall power cord. When the PDU+ is connected to a dedicated power source, it conforms to UL60950, CSA C22.2-60950, EN-60950, and IEC-60950 standards.

7109 or 5889 PDU+

Table 81. 7109 or 5889 PDU+ features

PDU Number	Racks usage	Supported power cords (PDU to wall)
7109 or 5889 PDU+	7953-94X, 7965-94Y, 0551, 0553, and 0555 IBM racks	“Supported PDU power cords” on page 85

Table 82. 7109 PDU+ specifications

Characteristics	Properties
PDU number	7109
Height	43.9 mm (1.73 in.)
Width	447 mm (17.6 in.)
Depth	350 mm (13.78 in.)
Additional clearance	25 mm (0.98 in.) for circuit breakers
	3 mm (0.12 in.) for outlets
Weight (not including power cord)	6.3 kg (13.8 lb)
Weight of power cord (approximate)	5.4 kg (11.8 lb)
Operating temperature at 0 - 914 m (0 - 3000 ft) (room ambient)	10°C - 32°C (50°F - 90°F)
Operating temperature at 914 - 2133 m (3000 - 7000 ft) (room ambient)	10°C - 35°C (50°F - 95°F)
Operating humidity	8% - 80% (noncondensing)
Localized air temperature in PDU	60°C (140°F) maximum
Rated frequency (all feature codes)	50 - 60 Hz
Circuit breakers	Six double-pole branch rated circuit breakers that are rated at 20 A
Power outlet	12 IEC 320-C13 outlets that are rated at 10 A (VDE) or 15 A (UL/CSA)

7196 PDU+

Table 83. 7196 PDU+ features

PDU Number	Racks usage	Supported power cords (PDU to wall)
7196 PDU+	7014-B42	Fixed power cord with IEC 60309, 3P+E, 60 A plug

Table 84. 7196 PDU+ specifications

Characteristics	Properties
PDU number	7196
Height	43.9 mm (1.73 in.)
Width	447 mm (17.6 in.)
Depth	350 mm (13.78 in.)
Additional clearance	25 mm (0.98 in.) for circuit breakers
	3 mm (0.12 in.) for outlets
Weight (not including power cord)	6.3 kg (13.8 lb)
Weight of power cord (approximate)	5.4 kg (11.8 lb)

Table 84. 7196 PDU+ specifications (continued)

Characteristics	Properties
Operating temperature at 0 - 914 m (0 - 3000 ft) (room ambient)	10 - 32°C (50 - 90°F)
Operating temperature at 914 - 2133 m (3000 - 7000 ft) (room ambient)	10 - 35°C (50 - 95°F)
Operating humidity	8 - 80% (noncondensing)
Localized air temperature in PDU	60 °C (140 °F) maximum
Rated frequency (all feature codes)	50 - 60 Hz
Circuit breakers	Six double-pole branch rated circuit breakers rated at 20 A
Power outlet	Six IEC 320-C19 outlets rated at 16 A (VDE) or 20 A (UL/CSA)

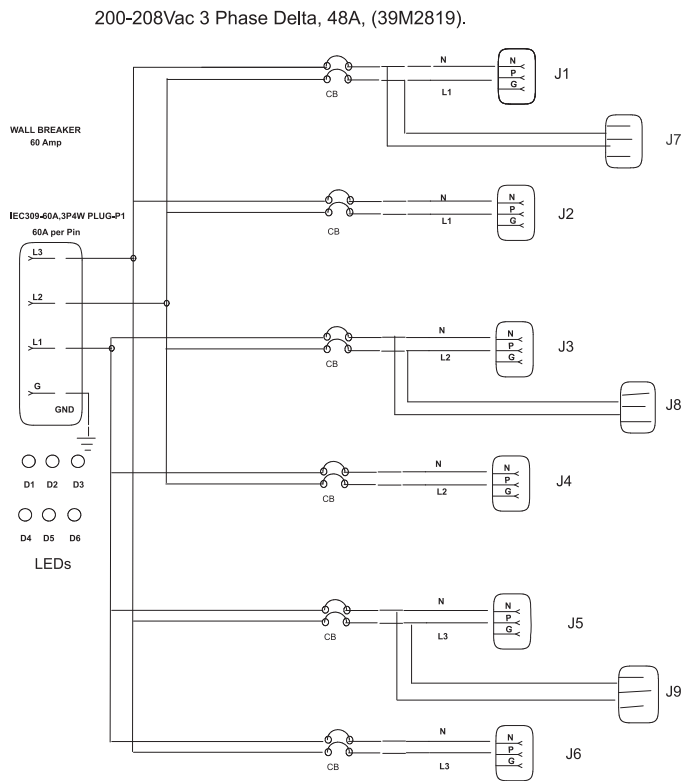

NOTES:

1. GND WIRE AT J (14 AWG).
2. P1 TO BREAKER, (6 AWG).
3. BREAKER TO RY or J, (14 AWG).
4. P1 TO GROUND, G (6 AWG).

PHAD006-0

Figure 47. Wiring diagram for the 7196 PDU+

HVDC PDU

Table 85. HVDC PDU features

PDU Number	Racks usage	Supported power cords (PDU to wall)
EPAA	7014-T00, 7014-T42, and 7965-94Y racks	Not applicable - fixed power cord

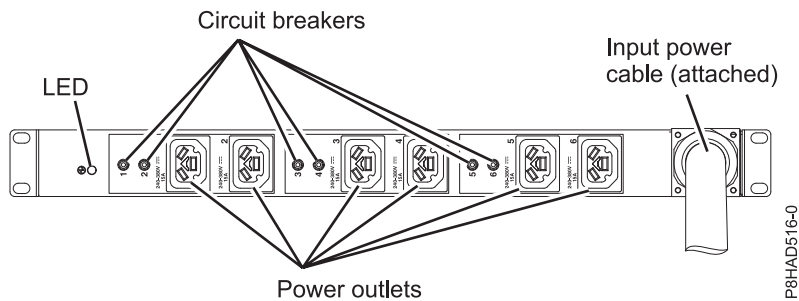

Figure 48. HVDC PDU

The rating of the HVDC PDU is 240 - 380 V dc, 90 A. The HVDC PDU has a permanently attached 4.3 m (14 ft) power cord and is unterminated (no plug). The minimum cross-sectional area of the two conductors and grounding conductor is 16 AWG (1.3 mm).

This PDU has six customer-usable Rong Feng RF-203P outlets that are rated at 240 - 380 V dc. Each outlet is rated up to 10 A and is fed from one 20 A circuit breaker derated to 16 A. The HVDC PDU does not have the nationally recognized test laboratory certification that is required for use in North America.

This PDU can be either vertically mounted in the rack side pockets or horizontally mounted by using feature code (FC) EBA5 (mounting kit). If horizontally mounted, the PDU uses 1U of rack space.

Intelligent Switched PDU

Table 86. Intelligent Switched PDU features

Feature code (FC)	Racks usage	Description	Provided power receptacles	Supported power cords (PDU to wall)
EPTG (PDU) EPTJ (Field Replaceable Unit (FRU) kit)	7014-T00 and 7014-T42 racks	<ul style="list-style-type: none"> Voltage Amperage Phase <ul style="list-style-type: none"> 200 - 240 V ac Single phase or three phase¹ 16 A, 24 A, 32 A, 48 A, or 63 A¹ 	9 IEC 320-C19 and 3 IEC 320-C13 receptacles	"Supported PDU power cords" on page 85
EPTK (PDU) EPTL (FRU kit)	7014-T00 and 7014-T42 racks	<ul style="list-style-type: none"> Voltage Amperage Phase <ul style="list-style-type: none"> 208 V ac 60 A Three-phase 	9 IEC 320-C19 and 3 IEC 320-C13 receptacles	Not applicable - fixed IEC 60309, 60 A, plug (3P+G) power cord
EPTM (PDU) EPTN (FRU kit)	7014-T00 and 7014-T42 racks	<ul style="list-style-type: none"> Voltage Amperage Phase <ul style="list-style-type: none"> 200 - 240 V ac Single phase or three phase¹ 16 A, 24 A, 32 A, 48 A, or 63 A¹ 	Twelve IEC 320-C13 receptacles	"Supported PDU power cords" on page 85
EPTP (PDU) EPTQ (FRU kit)	7014-T00 and 7014-T42 racks	<ul style="list-style-type: none"> Voltage Amperage Phase <ul style="list-style-type: none"> 208 V ac 60 A Three-phase 	Twelve IEC 320-C13 receptacles	Not applicable - fixed IEC 60309, 60 A, plug (3P+G) power cord

¹Amperage and phase depends on the power cord that is used.

Table 87. Intelligent Switched PDU specifications

Characteristics	Properties
Height	43.9 mm (1.73 in.)
Width	447 mm (17.6 in.)
Depth	350 mm (13.78 in.)
Additional clearance	25 mm (0.98 in.) for circuit breakers
	3 mm (0.12 in.) for outlets
Weight (not including power cord)	6.3 kg (13.8 lb)
Weight of power cord (approximate)	5.4 kg (11.8 lb)
Operating temperature at 0 - 914 m (0 - 3000 ft) (room ambient)	10°C - 60°C (50°F - 140°F)
Operating temperature at 914 - 2133 m (3000 - 7000 ft) (room ambient)	10°C - 60°C (50°F - 140°F)
Operating humidity	8 - 80% (noncondensing)
Localized air temperature in PDU	60 °C (140 °F) maximum
Rated frequency (all feature codes)	50 - 60 Hz
Circuit breakers	Nine double-pole branch rated circuit breakers rated at 20 amps for 1U C19 PDU models. Six double-pole branch rated circuit breakers rated at 20 amps for 1U C13 PDU models.

The intelligent, switched AC power distribution unit (PDU) provides the capability to monitor the amount of electrical power that is being used by devices that are plugged into the PDU. The PDU can also cycle power to individual receptacles by using the switched function.

Table 88. EPTK/EPTL circuit breaker wiring

Circuit breaker number	IEC 320-C19 receptacle	IEC 320-C13 receptacle
1	1	1
2	2	
3	3	
4	4	4
5	5	
6	6	
7	7	7
8	8	
9	9	

Calculating the power load for 7188 or 9188 power distribution units

Learn how to calculate the power load for power distribution units.

Rack-mounted 7188 or 9188 power distribution unit

Learn about the power loading requirements and proper loading sequence for the 7188 or 9188 power distribution unit.

The IBM 7188 or 9188 rack-mounted power distribution unit (PDU) contains 12 IEC 320-C13 outlets that are connected to six 20 amps (A) circuit breakers (two outlets per circuit breaker). The PDU employs an inlet current that allows various power cord options that are listed in the following chart. Based on the power cord that is used, the PDU can supply from 24 amps to 63 amps.

Table 89. Power cord options

Feature code	Power cord description	Amps
6489	Power cord, PDU to wall, 4.3 m (14 ft), 230 V ac, 3 phase wye, Souriau UTG, IEC 60309, 3P+N+E plug	96 A (32 A x 3)
6491	Power cord, PDU to wall, 4.3 m (14 ft), 200 - 240 V ac, single phase, Souriau UTG, IEC 60309, P+N+E plug	63 A
6492	Power cord, PDU to wall, 4.3 m (14 ft), 200 - 240 V ac, single phase, Souriau UTG, IEC 60309, 2P+E plug	60 A (48 A derated)
6653	Power cord, PDU to wall, 4.3 m (14 ft), 230 V ac, 3 phase wye, Souriau UTG, IEC 60309, 3P+N+E plug	48 A (16 A x 3)
6654	Power cord, PDU to wall, 4.3 m (14 ft), 200 - 240 V ac, single phase, Souriau UTG, plug type 12 plug	30 A (24 A derated)
6655	Power cord, PDU to wall, 4.3 m (14 ft), 200 - 240 V ac, single phase, Souriau UTG, plug type 40 plug	30 A (24 A derated)
6656	Power cord, PDU to wall, 4.3 m (14 ft), 200 - 240 V ac, single phase, Souriau UTG, IEC 60309, P+N+E plug	32 A
6657	Power cord, PDU to wall, 4.3 m (14 ft), 200 - 240 V ac, single phase, Souriau UTG, plug type PDL plug	32 A
6658	Power cord, PDU to wall, 4.3 m (14 ft), 200 - 240 V ac, single phase, Souriau UTG, plug type KP plug	30 A (24 A derated)
6667	Power cord, PDU to wall, 4.3 m (14 ft), 230 - 240 V ac, 3 phase wye, PDL 56P532	96 A (32 A x 3)

Loading requirements

The power loading of the 7188 or 9188 PDU must follow these rules:

1. Total power load that is connected to the PDU must be limited to below the amperage that is listed in the table.
2. Total power load that is connected to any one circuit breaker must be limited to 16 A (derating of circuit breaker).
3. Total power load that is connected to any one IEC320-C13 outlet must be limited to 10 A.

Note: The load on the PDU when a dual line configuration is used is only half the total load of the system. When you are calculating the power load on the PDU, you must include the total power load of each drawer even if the load is distributed over two PDUs.

Loading sequence

Follow these loading sequence steps:

1. Collect power requirements for all units that are connected to the 7188 or 9188 PDU. See your server specifications for specific power requirements.
2. Sort list by total power that is required from highest power draw to lowest power draw.
3. Connect highest power drawer to outlet 1 on circuit breaker 1.
4. Connect next highest power drawer to outlet 3 on circuit breaker 2.
5. Connect next highest power drawer to outlet 5 on circuit breaker 3.

6. Connect next highest power drawer to outlet 7 on circuit breaker 4.
7. Connect next highest power drawer to outlet 9 on circuit breaker 5.
8. Connect next highest power drawer to outlet 11 on circuit breaker 6.
9. Connect next highest power drawer to outlet 12 on circuit breaker 6.
10. Connect next highest power drawer to outlet 10 on circuit breaker 5.
11. Connect next highest power drawer to outlet 8 on circuit breaker 4.
12. Connect next highest power drawer to outlet 6 on circuit breaker 3.
13. Connect next highest power drawer to outlet 4 on circuit breaker 2.
14. Connect next highest power drawer to outlet 2 on circuit breaker 1.

Following these rules allow the load to be distributed more evenly across the six PDU circuit breakers. Ensure that your total power load is below the maximum that is listed in the table and that each circuit breaker is not loaded above 16 A.

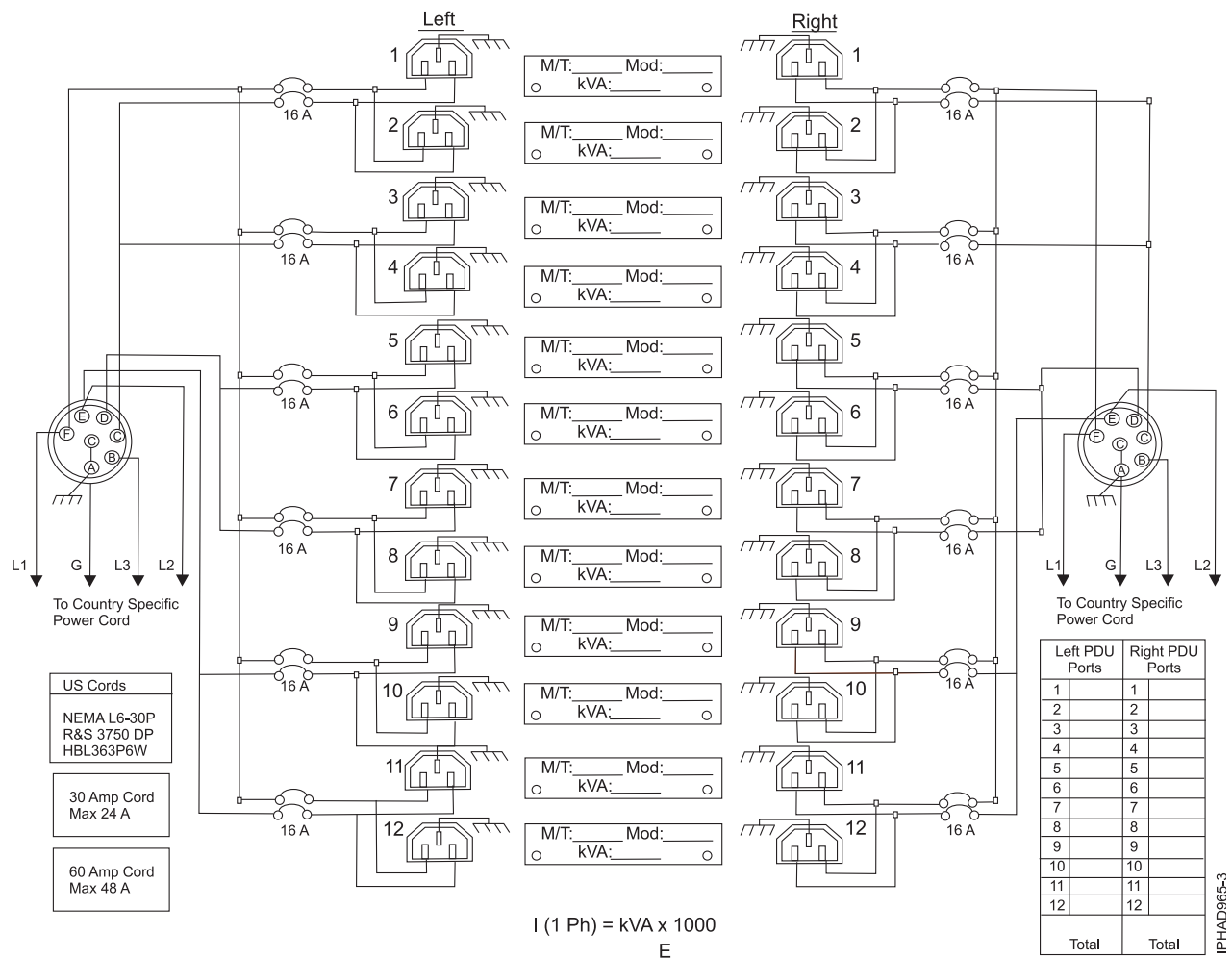

Related concepts:

“Supported PDU power cords” on page 85

Find out which power distribution unit (PDU) power cords are supported for your system.

Planning for cables

Learn how to develop plans for cabling your server and devices.

Cable management

These guidelines ensure that your system and its cables have optimal clearance for maintenance and other operations. The guidelines also provide guidance in correctly cabling your system and using the appropriate cables.

The following guidelines provide cabling information for installing, migrating, relocating, or upgrading your system:

- Position drawers in racks to allow enough space, where possible, for cable routing on the bottom and top of the rack, and between drawers.
- Shorter drawers should not be placed between longer drawers in the rack (for example, placing a 19-inch drawer between two 24-inch drawers).
- When a specific cable plugging sequence is required, for example, for concurrent maintenance (symmetric multiprocessing cables), label the cables appropriately and note the sequence order.
- To facilitate cable routing, install cables in the following order:
 1. Power cables
 2. Communications (serial attached SCSI, InfiniBand, remote input/output, and peripheral component interconnect express) cables

Note: Install and route the communications cables, starting with the smallest diameter first and then progressing to the largest diameter. This applies to installing them into the cable management arm and retaining them to the rack, brackets, and other features that may be provided for cable management.

- Install and route the communications cables, starting with smallest diameter first and then progressing to the largest diameter.
- Use the innermost cable-management bridge lances for power cables.
- Use the middle cable-management bridge lances for communications cables.
- The outermost row of cable-management bridge lances are available for use when routing cables.
- Use the cable raceways on the sides of the rack to manage excess power cables.
- There are four cable-management bridge lances on the top of the rack. Use these bridge lances to route the cables from one side of the rack to the other, by routing to the top of the rack, where possible. This routing helps to avoid having a cable bundle that blocks the cable exit opening at the bottom of the rack.
- Use the cable management brackets provided with the system to maintain concurrent maintenance routing.
- Maintain a minimum bend diameter of 101.6 mm (4 in.) for communications (SAS, IB, and PCIe) cables.
- Maintain a minimum bend diameter of 50.8 mm (2 in.) for power cables.
- Use the shortest-length cable available for each point-to-point connection.
- If cables have to be routed across the rear of a drawer, leave enough slack to reduce the tension on the cables for maintenance of the drawer.
- When routing cables, leave enough slack around the power connection on the power distribution unit (PDU) so that the wall-to-PDU line cord can be attached to the PDU.
- Use hook-and-loop fasteners where necessary.

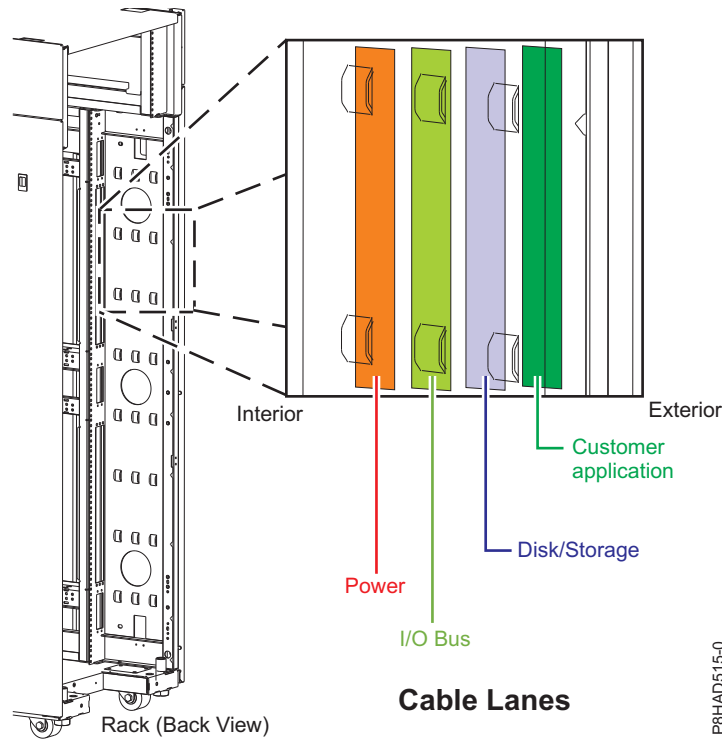

Figure 49. Cable management bridge lances

Cable bend radius

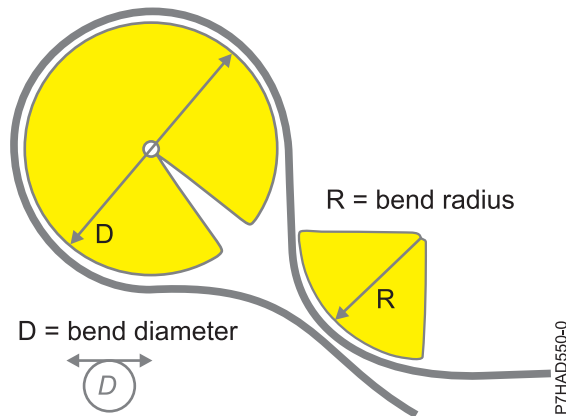

Figure 50. Cable bend radius

Power cord routing and retention

Proper power cord routing and retention ensures that your system remains connected to a power supply.

The primary purpose of power cord retention is to prevent unexpected power loss to your system that could potentially cause system operations to stop functioning.

Different types of power cord retention are available. Some of the most commonly used types of retention include:

- Cable management arms
- Rings

- Clamps
- Plastic straps
- Hook-and-loop fasteners

Power cord retainers are typically found at the rear of the unit and on the chassis or pedestal near the alternating current (AC) power cord input.

Systems that are rack mounted and are on rails should use the provided cable management arm.

Systems that are rack mounted, but are not on rails should use the provided rings, clamps, or straps.

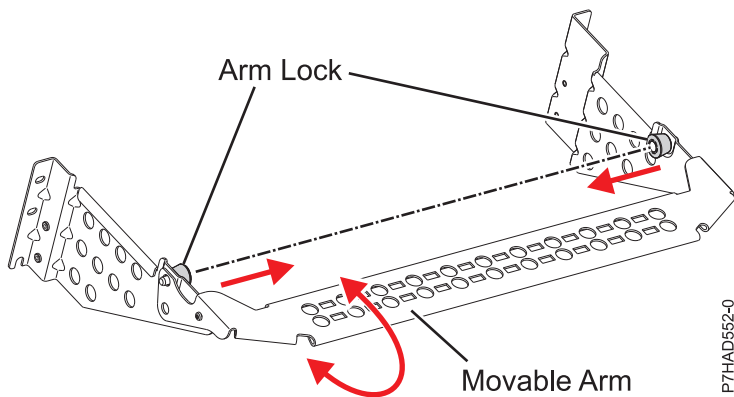

PTHAD562-0

Figure 51. Cable management bracket

Notices

This information was developed for products and services offered in the US.

IBM may not offer the products, services, or features discussed in this document in other countries. Consult your local IBM representative for information on the products and services currently available in your area. Any reference to an IBM product, program, or service is not intended to state or imply that only that IBM product, program, or service may be used. Any functionally equivalent product, program, or service that does not infringe any IBM intellectual property right may be used instead. However, it is the user's responsibility to evaluate and verify the operation of any non-IBM product, program, or service.

IBM may have patents or pending patent applications covering subject matter described in this document. The furnishing of this document does not grant you any license to these patents. You can send license inquiries, in writing, to:

*IBM Director of Licensing
IBM Corporation
North Castle Drive, MD-NC119
Armonk, NY 10504-1785
US*

INTERNATIONAL BUSINESS MACHINES CORPORATION PROVIDES THIS PUBLICATION "AS IS" WITHOUT WARRANTY OF ANY KIND, EITHER EXPRESS OR IMPLIED, INCLUDING, BUT NOT LIMITED TO, THE IMPLIED WARRANTIES OF NON-INFRINGEMENT, MERCHANTABILITY OR FITNESS FOR A PARTICULAR PURPOSE. Some jurisdictions do not allow disclaimer of express or implied warranties in certain transactions, therefore, this statement may not apply to you.

This information could include technical inaccuracies or typographical errors. Changes are periodically made to the information herein; these changes will be incorporated in new editions of the publication. IBM may make improvements and/or changes in the product(s) and/or the program(s) described in this publication at any time without notice.

Any references in this information to non-IBM websites are provided for convenience only and do not in any manner serve as an endorsement of those websites. The materials at those websites are not part of the materials for this IBM product and use of those websites is at your own risk.

IBM may use or distribute any of the information you provide in any way it believes appropriate without incurring any obligation to you.

The performance data and client examples cited are presented for illustrative purposes only. Actual performance results may vary depending on specific configurations and operating conditions.

Information concerning non-IBM products was obtained from the suppliers of those products, their published announcements or other publicly available sources. IBM has not tested those products and cannot confirm the accuracy of performance, compatibility or any other claims related to non-IBM products. Questions on the capabilities of non-IBM products should be addressed to the suppliers of those products.

Statements regarding IBM's future direction or intent are subject to change or withdrawal without notice, and represent goals and objectives only.

All IBM prices shown are IBM's suggested retail prices, are current and are subject to change without notice. Dealer prices may vary.

This information is for planning purposes only. The information herein is subject to change before the products described become available.

This information contains examples of data and reports used in daily business operations. To illustrate them as completely as possible, the examples include the names of individuals, companies, brands, and products. All of these names are fictitious and any similarity to actual people or business enterprises is entirely coincidental.

If you are viewing this information in softcopy, the photographs and color illustrations may not appear.

The drawings and specifications contained herein shall not be reproduced in whole or in part without the written permission of IBM.

IBM has prepared this information for use with the specific machines indicated. IBM makes no representations that it is suitable for any other purpose.

IBM's computer systems contain mechanisms designed to reduce the possibility of undetected data corruption or loss. This risk, however, cannot be eliminated. Users who experience unplanned outages, system failures, power fluctuations or outages, or component failures must verify the accuracy of operations performed and data saved or transmitted by the system at or near the time of the outage or failure. In addition, users must establish procedures to ensure that there is independent data verification before relying on such data in sensitive or critical operations. Users should periodically check IBM's support websites for updated information and fixes applicable to the system and related software.

Homologation statement

This product may not be certified in your country for connection by any means whatsoever to interfaces of public telecommunications networks. Further certification may be required by law prior to making any such connection. Contact an IBM representative or reseller for any questions.

Accessibility features for IBM Power Systems servers

Accessibility features assist users who have a disability, such as restricted mobility or limited vision, to use information technology content successfully.

Overview

The IBM Power Systems servers include the following major accessibility features:

- Keyboard-only operation
- Operations that use a screen reader

The IBM Power Systems servers use the latest W3C Standard, WAI-ARIA 1.0 (www.w3.org/TR/wai-aria/), to ensure compliance with US Section 508 (www.access-board.gov/guidelines-and-standards/communications-and-it/about-the-section-508-standards/section-508-standards) and Web Content Accessibility Guidelines (WCAG) 2.0 (www.w3.org/TR/WCAG20/). To take advantage of accessibility features, use the latest release of your screen reader and the latest web browser that is supported by the IBM Power Systems servers.

The IBM Power Systems servers online product documentation in IBM Knowledge Center is enabled for accessibility. The accessibility features of IBM Knowledge Center are described in the Accessibility section of the IBM Knowledge Center help (www.ibm.com/support/knowledgcenter/doc/kc_help.html#accessibility).

Keyboard navigation

This product uses standard navigation keys.

Interface information

The IBM Power Systems servers user interfaces do not have content that flashes 2 - 55 times per second.

The IBM Power Systems servers web user interface relies on cascading style sheets to render content properly and to provide a usable experience. The application provides an equivalent way for low-vision users to use system display settings, including high-contrast mode. You can control font size by using the device or web browser settings.

The IBM Power Systems servers web user interface includes WAI-ARIA navigational landmarks that you can use to quickly navigate to functional areas in the application.

Vendor software

The IBM Power Systems servers include certain vendor software that is not covered under the IBM license agreement. IBM makes no representation about the accessibility features of these products. Contact the vendor for accessibility information about its products.

Related accessibility information

In addition to standard IBM help desk and support websites, IBM has a TTY telephone service for use by deaf or hard of hearing customers to access sales and support services:

TTY service
800-IBM-3383 (800-426-3383)
(within North America)

For more information about the commitment that IBM has to accessibility, see IBM Accessibility (www.ibm.com/able).

Privacy policy considerations

IBM Software products, including software as a service solutions, (“Software Offerings”) may use cookies or other technologies to collect product usage information, to help improve the end user experience, to tailor interactions with the end user, or for other purposes. In many cases no personally identifiable information is collected by the Software Offerings. Some of our Software Offerings can help enable you to collect personally identifiable information. If this Software Offering uses cookies to collect personally identifiable information, specific information about this offering’s use of cookies is set forth below.

This Software Offering does not use cookies or other technologies to collect personally identifiable information.

If the configurations deployed for this Software Offering provide you as the customer the ability to collect personally identifiable information from end users via cookies and other technologies, you should seek your own legal advice about any laws applicable to such data collection, including any requirements for notice and consent.

For more information about the use of various technologies, including cookies, for these purposes, see IBM’s Privacy Policy at <http://www.ibm.com/privacy> and IBM’s Online Privacy Statement at <http://www.ibm.com/privacy/details> the section entitled “Cookies, Web Beacons and Other Technologies” and the “IBM Software Products and Software-as-a-Service Privacy Statement” at <http://www.ibm.com/software/info/product-privacy>.

Trademarks

IBM, the IBM logo, and ibm.com are trademarks or registered trademarks of International Business Machines Corp., registered in many jurisdictions worldwide. Other product and service names might be trademarks of IBM or other companies. A current list of IBM trademarks is available on the web at Copyright and trademark information at www.ibm.com/legal/copytrade.shtml.

INFINIBAND, InfiniBand Trade Association, and the INFINIBAND design marks are trademarks and/or service marks of the INFINIBAND Trade Association.

Linux is a registered trademark of Linus Torvalds in the United States, other countries, or both.

Electronic emission notices

When attaching a monitor to the equipment, you must use the designated monitor cable and any interference suppression devices supplied with the monitor.

Class A Notices

The following Class A statements apply to the IBM servers that contain the POWER8 processor and its features unless designated as electromagnetic compatibility (EMC) Class B in the feature information.

Federal Communications Commission (FCC) Statement

Note: This equipment has been tested and found to comply with the limits for a Class A digital device, pursuant to Part 15 of the FCC Rules. These limits are designed to provide reasonable protection against harmful interference when the equipment is operated in a commercial environment. This equipment generates, uses, and can radiate radio frequency energy and, if not installed and used in accordance with the instruction manual, may cause harmful interference to radio communications. Operation of this equipment in a residential area is likely to cause harmful interference, in which case the user will be required to correct the interference at his own expense.

Properly shielded and grounded cables and connectors must be used in order to meet FCC emission limits. IBM is not responsible for any radio or television interference caused by using other than recommended cables and connectors or by unauthorized changes or modifications to this equipment. Unauthorized changes or modifications could void the user's authority to operate the equipment.

This device complies with Part 15 of the FCC rules. Operation is subject to the following two conditions: (1) this device may not cause harmful interference, and (2) this device must accept any interference received, including interference that may cause undesired operation.

Industry Canada Compliance Statement

CAN ICES-3 (A)/NMB-3(A)

European Community Compliance Statement

This product is in conformity with the protection requirements of EU Council Directive 2014/30/EU on the approximation of the laws of the Member States relating to electromagnetic compatibility. IBM cannot accept responsibility for any failure to satisfy the protection requirements resulting from a non-recommended modification of the product, including the fitting of non-IBM option cards.

European Community contact:
IBM Deutschland GmbH
Technical Regulations, Abteilung M456

IBM-Allee 1, 71139 Ehningen, Germany
Tel: +49 800 225 5426
email: halloibm@de.ibm.com

Warning: This is a Class A product. In a domestic environment, this product may cause radio interference, in which case the user may be required to take adequate measures.

VCCI Statement - Japan

この装置は、クラスA 情報技術装置です。この装置を家庭環境で使用すると電波妨害を引き起こすことがあります。この場合には使用者が適切な対策を講ずるよう要求されることがあります。 VCCI-A

The following is a summary of the VCCI Japanese statement in the box above:

This is a Class A product based on the standard of the VCCI Council. If this equipment is used in a domestic environment, radio interference may occur, in which case, the user may be required to take corrective actions.

Japan Electronics and Information Technology Industries Association Statement

This statement explains the Japan JIS C 61000-3-2 product wattage compliance.

(一社) 電子情報技術産業協会 高調波電流抑制対策実施
要領に基づく定格入力電力値： Knowledge Centerの各製品の
仕様ページ参照

This statement explains the Japan Electronics and Information Technology Industries Association (JEITA) statement for products less than or equal to 20 A per phase.

高調波電流規格 JIS C 61000-3-2 適合品

This statement explains the JEITA statement for products greater than 20 A, single phase.

高調波電流規格 JIS C 61000-3-2 準用品

本装置は、「高圧又は特別高圧で受電する需要家の高調波抑制対策ガイドライン」対象機器（高調波発生機器）です。

- 回路分類 : 6 (単相、PFC回路付)
- 換算係数 : 0

This statement explains the JEITA statement for products greater than 20 A per phase, three-phase.

高調波電流規格 JIS C 61000-3-2 準用品

本装置は、「高圧又は特別高圧で受電する需要家の高調波抑制対策ガイドライン」対象機器（高調波発生機器）です。

- 回路分類 : 5 (3相、PFC回路付)
- 換算係数 : 0

Electromagnetic Interference (EMI) Statement - People's Republic of China

声 明

此为 A 级产品,在生活环境中,该产品可能会造成无线电干扰。在这种情况下,可能需要用户对其干扰采取切实可行的措施。

Declaration: This is a Class A product. In a domestic environment this product may cause radio interference in which case the user may need to perform practical action.

Electromagnetic Interference (EMI) Statement - Taiwan

警告使用者：

這是甲類的資訊產品，在居住的環境中使用時，可能會造成射頻干擾，在這種情況下，使用者會被要求採取某些適當的對策。

The following is a summary of the EMI Taiwan statement above.

Warning: This is a Class A product. In a domestic environment this product may cause radio interference in which case the user will be required to take adequate measures.

IBM Taiwan Contact Information:

台灣IBM 產品服務聯絡方式：
台灣國際商業機器股份有限公司
台北市松仁路7號3樓
電話：0800-016-888

Electromagnetic Interference (EMI) Statement - Korea

이 기기는 업무용 환경에서 사용할 목적으로 적합성평가를 받은 기기로서 가정용 환경에서 사용하는 경우 전파간섭의 우려가 있습니다.

Germany Compliance Statement

Deutschsprachiger EU Hinweis: Hinweis für Geräte der Klasse A EU-Richtlinie zur Elektromagnetischen Verträglichkeit

Dieses Produkt entspricht den Schutzanforderungen der EU-Richtlinie 2014/30/EU zur Angleichung der Rechtsvorschriften über die elektromagnetische Verträglichkeit in den EU-Mitgliedsstaaten und hält die Grenzwerte der EN 55022 / EN 55032 Klasse A ein.

Um dieses sicherzustellen, sind die Geräte wie in den Handbüchern beschrieben zu installieren und zu betreiben. Des Weiteren dürfen auch nur von der IBM empfohlene Kabel angeschlossen werden. IBM übernimmt keine Verantwortung für die Einhaltung der Schutzanforderungen, wenn das Produkt ohne Zustimmung von IBM verändert bzw. wenn Erweiterungskomponenten von Fremdherstellern ohne Empfehlung von IBM gesteckt/eingebaut werden.

EN 55022 / EN 55032 Klasse A Geräte müssen mit folgendem Warnhinweis versehen werden:
"Warnung: Dieses ist eine Einrichtung der Klasse A. Diese Einrichtung kann im Wohnbereich Funk-Störungen verursachen; in diesem Fall kann vom Betreiber verlangt werden, angemessene Maßnahmen zu ergreifen und dafür aufzukommen."

Deutschland: Einhaltung des Gesetzes über die elektromagnetische Verträglichkeit von Geräten

Dieses Produkt entspricht dem "Gesetz über die elektromagnetische Verträglichkeit von Geräten (EMVG)". Dies ist die Umsetzung der EU-Richtlinie 2014/30/EU in der Bundesrepublik Deutschland.

Zulassungsbescheinigung laut dem Deutschen Gesetz über die elektromagnetische Verträglichkeit von Geräten (EMVG) (bzw. der EMC Richtlinie 2014/30/EU) für Geräte der Klasse A

Dieses Gerät ist berechtigt, in Übereinstimmung mit dem Deutschen EMVG das EG-Konformitätszeichen - CE - zu führen.

Verantwortlich für die Einhaltung der EMV Vorschriften ist der Hersteller:
International Business Machines Corp.
New Orchard Road

Armonk, New York 10504
Tel: 914-499-1900

Der verantwortliche Ansprechpartner des Herstellers in der EU ist:
IBM Deutschland GmbH
Technical Relations Europe, Abteilung M456
IBM-Allee 1, 71139 Ehningen, Germany
Tel: +49 (0) 800 225 5426
email: HalloIBM@de.ibm.com

Generelle Informationen:

Das Gerät erfüllt die Schutzanforderungen nach EN 55024 und EN 55022 / EN 55032 Klasse A.

Electromagnetic Interference (EMI) Statement - Russia

ВНИМАНИЕ! Настоящее изделие относится к классу А.
В жилых помещениях оно может создавать
радиопомехи, для снижения которых необходимы
дополнительные меры

Class B Notices

The following Class B statements apply to features designated as electromagnetic compatibility (EMC) Class B in the feature installation information.

Federal Communications Commission (FCC) Statement

This equipment has been tested and found to comply with the limits for a Class B digital device, pursuant to Part 15 of the FCC Rules. These limits are designed to provide reasonable protection against harmful interference in a residential installation.

This equipment generates, uses, and can radiate radio frequency energy and, if not installed and used in accordance with the instructions, may cause harmful interference to radio communications. However, there is no guarantee that interference will not occur in a particular installation.

If this equipment does cause harmful interference to radio or television reception, which can be determined by turning the equipment off and on, the user is encouraged to try to correct the interference by one or more of the following measures:

- Reorient or relocate the receiving antenna.
- Increase the separation between the equipment and receiver.
- Connect the equipment into an outlet on a circuit different from that to which the receiver is connected.
- Consult an IBM-authorized dealer or service representative for help.

Properly shielded and grounded cables and connectors must be used in order to meet FCC emission limits. Proper cables and connectors are available from IBM-authorized dealers. IBM is not responsible for any radio or television interference caused by unauthorized changes or modifications to this equipment. Unauthorized changes or modifications could void the user's authority to operate this equipment.

This device complies with Part 15 of the FCC rules. Operation is subject to the following two conditions: (1) this device may not cause harmful interference, and (2) this device must accept any interference received, including interference that may cause undesired operation.

Industry Canada Compliance Statement

CAN ICES-3 (B)/NMB-3(B)

European Community Compliance Statement

This product is in conformity with the protection requirements of EU Council Directive 2014/30/EU on the approximation of the laws of the Member States relating to electromagnetic compatibility. IBM cannot accept responsibility for any failure to satisfy the protection requirements resulting from a non-recommended modification of the product, including the fitting of non-IBM option cards.

European Community contact:
IBM Deutschland GmbH
Technical Regulations, Abteilung M456
IBM-Allee 1, 71139 Ehningen, Germany
Tel: +49 800 225 5426
email: halloibm@de.ibm.com

VCCI Statement - Japan

この装置は、クラスB情報技術装置です。この装置は、家庭環境で使用することを目的としていますが、この装置がラジオやテレビジョン受信機に近接して使用されると、受信障害を引き起こすことがあります。

取扱説明書に従って正しい取り扱いをして下さい。 VCCI-B

Japan Electronics and Information Technology Industries Association Statement

This statement explains the Japan JIS C 61000-3-2 product wattage compliance.

(一社) 電子情報技術産業協会 高調波電流抑制対策実施
要領に基づく定格入力電力値 : Knowledge Centerの各製品の
仕様ページ参照

This statement explains the Japan Electronics and Information Technology Industries Association (JEITA) statement for products less than or equal to 20 A per phase.

高調波電流規格 JIS C 61000-3-2 適合品

This statement explains the JEITA statement for products greater than 20 A, single phase.

高調波電流規格 JIS C 61000-3-2 準用品

本装置は、「高圧又は特別高圧で受電する需要家の高調波抑制対策ガイドライン」対象機器（高調波発生機器）です。

- 回路分類 : 6 (単相、PFC回路付)
- 換算係数 : 0

This statement explains the JEITA statement for products greater than 20 A per phase, three-phase.

高調波電流規格 JIS C 61000-3-2 準用品

本装置は、「高圧又は特別高圧で受電する需要家の高調波抑制対策ガイドライン」対象機器（高調波発生機器）です。

- 回路分類 : 5 (3相、PFC回路付)
- 換算係数 : 0

IBM Taiwan Contact Information

台灣IBM 產品服務聯絡方式：
台灣國際商業機器股份有限公司
台北市松仁路7號3樓
電話：0800-016-888

Germany Compliance Statement

Deutschsprachiger EU Hinweis: Hinweis für Geräte der Klasse B EU-Richtlinie zur Elektromagnetischen Verträglichkeit

Dieses Produkt entspricht den Schutzanforderungen der EU-Richtlinie 2014/30/EU zur Angleichung der Rechtsvorschriften über die elektromagnetische Verträglichkeit in den EU-Mitgliedsstaaten und hält die Grenzwerte der EN 55022/ EN 55032 Klasse B ein.

Um dieses sicherzustellen, sind die Geräte wie in den Handbüchern beschrieben zu installieren und zu betreiben. Des Weiteren dürfen auch nur von der IBM empfohlene Kabel angeschlossen werden. IBM übernimmt keine Verantwortung für die Einhaltung der Schutzanforderungen, wenn das Produkt ohne Zustimmung von IBM verändert bzw. wenn Erweiterungskomponenten von Fremdherstellern ohne Empfehlung von IBM gesteckt/eingebaut werden.

Deutschland: Einhaltung des Gesetzes über die elektromagnetische Verträglichkeit von Geräten

Dieses Produkt entspricht dem "Gesetz über die elektromagnetische Verträglichkeit von Geräten (EMVG)". Dies ist die Umsetzung der EU-Richtlinie 2014/30/EU in der Bundesrepublik Deutschland.

Zulassungsbescheinigung laut dem Deutschen Gesetz über die elektromagnetische Verträglichkeit von Geräten (EMVG) (bzw. der EMC Richtlinie 2014/30/EU) für Geräte der Klasse B

Dieses Gerät ist berechtigt, in Übereinstimmung mit dem Deutschen EMVG das EG-Konformitätszeichen - CE - zu führen.

Verantwortlich für die Einhaltung der EMV Vorschriften ist der Hersteller:
International Business Machines Corp.
New Orchard Road
Armonk, New York 10504
Tel: 914-499-1900

Der verantwortliche Ansprechpartner des Herstellers in der EU ist:
IBM Deutschland GmbH
Technical Relations Europe, Abteilung M456
IBM-Allee 1, 71139 Ehningen, Germany
Tel: +49 (0) 800 225 5426
email: HalloIBM@de.ibm.com

Generelle Informationen:

Das Gerät erfüllt die Schutzanforderungen nach EN 55024 und EN 55022/ EN 55032 Klasse B.

Terms and conditions

Permissions for the use of these publications are granted subject to the following terms and conditions.

Applicability: These terms and conditions are in addition to any terms of use for the IBM website.

Personal Use: You may reproduce these publications for your personal, noncommercial use provided that all proprietary notices are preserved. You may not distribute, display or make derivative works of these publications, or any portion thereof, without the express consent of IBM.

Commercial Use: You may reproduce, distribute and display these publications solely within your enterprise provided that all proprietary notices are preserved. You may not make derivative works of these publications, or reproduce, distribute or display these publications or any portion thereof outside your enterprise, without the express consent of IBM.

Rights: Except as expressly granted in this permission, no other permissions, licenses or rights are granted, either express or implied, to the publications or any information, data, software or other intellectual property contained therein.

IBM reserves the right to withdraw the permissions granted herein whenever, in its discretion, the use of the publications is detrimental to its interest or, as determined by IBM, the above instructions are not being properly followed.

You may not download, export or re-export this information except in full compliance with all applicable laws and regulations, including all United States export laws and regulations.

IBM MAKES NO GUARANTEE ABOUT THE CONTENT OF THESE PUBLICATIONS. THE PUBLICATIONS ARE PROVIDED "AS-IS" AND WITHOUT WARRANTY OF ANY KIND, EITHER EXPRESSED OR IMPLIED, INCLUDING BUT NOT LIMITED TO IMPLIED WARRANTIES OF MERCHANTABILITY, NON-INFRINGEMENT, AND FITNESS FOR A PARTICULAR PURPOSE.



Printed in USA