

Power Systems

Site preparation and physical planning

IBM

Power Systems

Site preparation and physical planning

IBM

Note

Before using this information and the product it supports, read the information in “Safety notices” on page v, “Notices” on page 87, the *IBM Systems Safety Notices* manual, G229-9054, and the *IBM Environmental Notices and User Guide*, Z125-5823.

This edition applies to IBM Power Systems servers that contain the POWER8 processor and to all associated models.

© Copyright IBM Corporation 2014, 2016.

US Government Users Restricted Rights – Use, duplication or disclosure restricted by GSA ADP Schedule Contract with IBM Corp.

Contents

Safety notices	v
Site preparation and physical planning	1
Site selection	1
Access	1
Acclimation	2
Acoustics	3
Air conditioning determination	4
General guidelines for data centers	4
Computer room layout	12
Computer room location	14
Electromagnetic compatibility	16
Emergency planning for continuous operations	17
Environmental design criteria	18
Floor construction and floor loading	22
General power information	22
Dual-power installation configurations	23
Dual-power installation: Redundant distribution panel and switch	23
Dual-power installation: Redundant distribution panel	24
Single distribution panel: Dual circuit breakers	25
Lighting	25
Material and data storage protection	26
Overhead cabling	27
Planning for communications	29
Planning for the installation of rear door heat exchangers	30
Heat exchanger specifications	32
Heat exchanger performance	37
Water specifications for the secondary cooling loop	39
Water delivery specifications for secondary loops	41
Layout and mechanical installation	51
Heat exchanger installation overview	51
Heat exchanger filling and draining overview	51
Planning for heat exchangers in a raised floor environment	52
Planning for heat exchangers in a non-raised floor environment	59
Secondary cooling loop parts and services information	61
Miscellaneous parts supplier	62
Services supplier	62
Cooling distribution unit suppliers	63
Installation and support from IBM Integrated Technology Services offerings	65
Power load	66
Power quality	67
Power source	72
Raised floors	73
Conductive contamination	75
Relocation and temporary storage	76
Space requirements	77
Static electricity and floor resistance	78
System air distribution	79
Temperature and humidity recording instruments	83
Vibration and shock	83
Voltage and frequency limits	85
Notices	87
Accessibility features for IBM Power Systems servers	88
Privacy policy considerations	89

Trademarks	90
Electronic emission notices	90
Class A Notices	90
Class B Notices	94
Terms and conditions	98

Safety notices

Safety notices may be printed throughout this guide:

- **DANGER** notices call attention to a situation that is potentially lethal or extremely hazardous to people.
- **CAUTION** notices call attention to a situation that is potentially hazardous to people because of some existing condition.
- **Attention** notices call attention to the possibility of damage to a program, device, system, or data.

World Trade safety information

Several countries require the safety information contained in product publications to be presented in their national languages. If this requirement applies to your country, safety information documentation is included in the publications package (such as in printed documentation, on DVD, or as part of the product) shipped with the product. The documentation contains the safety information in your national language with references to the U.S. English source. Before using a U.S. English publication to install, operate, or service this product, you must first become familiar with the related safety information documentation. You should also refer to the safety information documentation any time you do not clearly understand any safety information in the U.S. English publications.

Replacement or additional copies of safety information documentation can be obtained by calling the IBM Hotline at 1-800-300-8751.

German safety information

Das Produkt ist nicht für den Einsatz an Bildschirmarbeitsplätzen im Sinne § 2 der Bildschirmarbeitsverordnung geeignet.

Laser safety information

IBM® servers can use I/O cards or features that are fiber-optic based and that utilize lasers or LEDs.

Laser compliance

IBM servers may be installed inside or outside of an IT equipment rack.

DANGER

When working on or around the system, observe the following precautions:

Electrical voltage and current from power, telephone, and communication cables are hazardous. To avoid a shock hazard:

- If IBM supplied the power cord(s), connect power to this unit only with the IBM provided power cord. Do not use the IBM provided power cord for any other product.
- Do not open or service any power supply assembly.
- Do not connect or disconnect any cables or perform installation, maintenance, or reconfiguration of this product during an electrical storm.
- The product might be equipped with multiple power cords. To remove all hazardous voltages, disconnect all power cords.
- Connect all power cords to a properly wired and grounded electrical outlet. Ensure that the outlet supplies proper voltage and phase rotation according to the system rating plate.
- Connect any equipment that will be attached to this product to properly wired outlets.
- When possible, use one hand only to connect or disconnect signal cables.
- Never turn on any equipment when there is evidence of fire, water, or structural damage.
- Do not attempt to switch on power to the machine until all possible unsafe conditions are corrected.
- Assume that an electrical safety hazard is present. Perform all continuity, grounding, and power checks specified during the subsystem installation procedures to ensure that the machine meets safety requirements.
- Do not continue with the inspection if any unsafe conditions are present.
- Disconnect the attached power cords, telecommunications systems, networks, and modems before you open the device covers, unless instructed otherwise in the installation and configuration procedures.
- Connect and disconnect cables as described in the following procedures when installing, moving, or opening covers on this product or attached devices.

To Disconnect:

1. Turn off everything (unless instructed otherwise).
2. Remove the power cords from the outlets.
3. Remove the signal cables from the connectors.
4. Remove all cables from the devices.

To Connect:

1. Turn off everything (unless instructed otherwise).
2. Attach all cables to the devices.
3. Attach the signal cables to the connectors.
4. Attach the power cords to the outlets.
5. Turn on the devices.

Sharp edges, corners and joints may be present in and around the system. Use care when handling equipment to avoid cuts, scrapes and pinching.

(D005)

(R001 part 1 of 2):

DANGER: Observe the following precautions when working on or around your IT rack system:

- Heavy equipment—personal injury or equipment damage might result if mishandled.
- Always lower the leveling pads on the rack cabinet.
- Always install stabilizer brackets on the rack cabinet.
- To avoid hazardous conditions due to uneven mechanical loading, always install the heaviest devices in the bottom of the rack cabinet. Always install servers and optional devices starting from the bottom of the rack cabinet.

- Rack-mounted devices are not to be used as shelves or work spaces. Do not place objects on top of rack-mounted devices.



- Each rack cabinet might have more than one power cord. Be sure to disconnect all power cords in the rack cabinet when directed to disconnect power during servicing.
- Connect all devices installed in a rack cabinet to power devices installed in the same rack cabinet. Do not plug a power cord from a device installed in one rack cabinet into a power device installed in a different rack cabinet.
- An electrical outlet that is not correctly wired could place hazardous voltage on the metal parts of the system or the devices that attach to the system. It is the responsibility of the customer to ensure that the outlet is correctly wired and grounded to prevent an electrical shock.

(R001 part 2 of 2):

CAUTION:

- Do not install a unit in a rack where the internal rack ambient temperatures will exceed the manufacturer's recommended ambient temperature for all your rack-mounted devices.
- Do not install a unit in a rack where the air flow is compromised. Ensure that air flow is not blocked or reduced on any side, front, or back of a unit used for air flow through the unit.
- Consideration should be given to the connection of the equipment to the supply circuit so that overloading of the circuits does not compromise the supply wiring or overcurrent protection. To provide the correct power connection to a rack, refer to the rating labels located on the equipment in the rack to determine the total power requirement of the supply circuit.
- *(For sliding drawers.)* Do not pull out or install any drawer or feature if the rack stabilizer brackets are not attached to the rack. Do not pull out more than one drawer at a time. The rack might become unstable if you pull out more than one drawer at a time.



- *(For fixed drawers.)* This drawer is a fixed drawer and must not be moved for servicing unless specified by the manufacturer. Attempting to move the drawer partially or completely out of the rack might cause the rack to become unstable or cause the drawer to fall out of the rack.

CAUTION:

Removing components from the upper positions in the rack cabinet improves rack stability during relocation. Follow these general guidelines whenever you relocate a populated rack cabinet within a room or building.

- Reduce the weight of the rack cabinet by removing equipment starting at the top of the rack cabinet. When possible, restore the rack cabinet to the configuration of the rack cabinet as you received it. If this configuration is not known, you must observe the following precautions:
 - Remove all devices in the 32U position (compliance ID RACK-001 or 22U (compliance ID RR001) and above.
 - Ensure that the heaviest devices are installed in the bottom of the rack cabinet.
 - Ensure that there are little-to-no empty U-levels between devices installed in the rack cabinet below the 32U (compliance ID RACK-001 or 22U (compliance ID RR001) level, unless the received configuration specifically allowed it.
- If the rack cabinet you are relocating is part of a suite of rack cabinets, detach the rack cabinet from the suite.
- If the rack cabinet you are relocating was supplied with removable outriggers they must be reinstalled before the cabinet is relocated.
- Inspect the route that you plan to take to eliminate potential hazards.
- Verify that the route that you choose can support the weight of the loaded rack cabinet. Refer to the documentation that comes with your rack cabinet for the weight of a loaded rack cabinet.
- Verify that all door openings are at least 760 x 230 mm (30 x 80 in.).
- Ensure that all devices, shelves, drawers, doors, and cables are secure.
- Ensure that the four leveling pads are raised to their highest position.
- Ensure that there is no stabilizer bracket installed on the rack cabinet during movement.
- Do not use a ramp inclined at more than 10 degrees.
- When the rack cabinet is in the new location, complete the following steps:
 - Lower the four leveling pads.
 - Install stabilizer brackets on the rack cabinet.
 - If you removed any devices from the rack cabinet, repopulate the rack cabinet from the lowest position to the highest position.
- If a long-distance relocation is required, restore the rack cabinet to the configuration of the rack cabinet as you received it. Pack the rack cabinet in the original packaging material, or equivalent. Also lower the leveling pads to raise the casters off of the pallet and bolt the rack cabinet to the pallet.

(R002)

(L001)



DANGER: Hazardous voltage, current, or energy levels are present inside any component that has this label attached. Do not open any cover or barrier that contains this label. (L001)

(L002)



DANGER: Rack-mounted devices are not to be used as shelves or work spaces. (L002)

(L003)

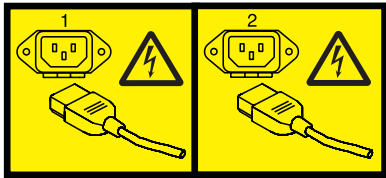

or



or



or

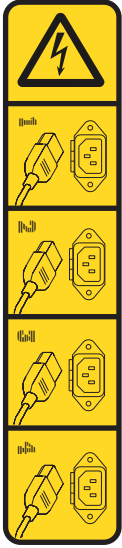

or

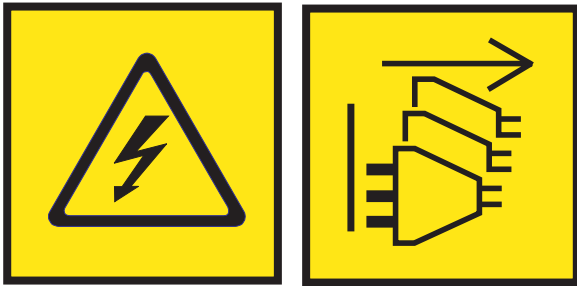

DANGER: Multiple power cords. The product might be equipped with multiple power cords. To remove all hazardous voltages, disconnect all power cords. (L003)

(L007)



CAUTION: A hot surface nearby. (L007)

(L008)



CAUTION: Hazardous moving parts nearby. (L008)

All lasers are certified in the U.S. to conform to the requirements of DHHS 21 CFR Subchapter J for class 1 laser products. Outside the U.S., they are certified to be in compliance with IEC 60825 as a class 1 laser product. Consult the label on each part for laser certification numbers and approval information.

CAUTION:

This product might contain one or more of the following devices: CD-ROM drive, DVD-ROM drive, DVD-RAM drive, or laser module, which are Class 1 laser products. Note the following information:

- Do not remove the covers. Removing the covers of the laser product could result in exposure to hazardous laser radiation. There are no serviceable parts inside the device.
- Use of the controls or adjustments or performance of procedures other than those specified herein might result in hazardous radiation exposure.

(C026)

CAUTION:

Data processing environments can contain equipment transmitting on system links with laser modules that operate at greater than Class 1 power levels. For this reason, never look into the end of an optical fiber cable or open receptacle. Although shining light into one end and looking into the other end of a disconnected optical fiber to verify the continuity of optic fibers many not injure the eye, this procedure is potentially dangerous. Therefore, verifying the continuity of optical fibers by shining light into one end and looking at the other end is not recommended. To verify continuity of a fiber optic cable, use an optical light source and power meter. (C027)

CAUTION:

This product contains a Class 1M laser. Do not view directly with optical instruments. (C028)

CAUTION:

Some laser products contain an embedded Class 3A or Class 3B laser diode. Note the following information: laser radiation when open. Do not stare into the beam, do not view directly with optical instruments, and avoid direct exposure to the beam. (C030)

CAUTION:

The battery contains lithium. To avoid possible explosion, do not burn or charge the battery.

Do Not:

- ___ Throw or immerse into water
- ___ Heat to more than 100°C (212°F)
- ___ Repair or disassemble

Exchange only with the IBM-approved part. Recycle or discard the battery as instructed by local regulations. In the United States, IBM has a process for the collection of this battery. For information, call 1-800-426-4333. Have the IBM part number for the battery unit available when you call. (C003)

(C048)

CAUTION regarding IBM provided **VENDOR LIFT TOOL**:

- Operation of **LIFT TOOL** by authorized personnel only.
- **LIFT TOOL** intended for use to assist, lift, install, remove units (load) up into rack elevations. It is not to be used loaded transporting over major ramps nor as a replacement for such designated tools like pallet jacks, walkies, fork trucks and such related relocation practices. When this is not practicable, specially trained persons or services must be used (for instance, riggers or movers).
- Read and completely understand the contents of **LIFT TOOL** operator's manual before using. Failure to read, understand, obey safety rules, and follow instructions may result in property damage and/or personal injury. If there are questions, contact the vendor's service and support. Local paper manual must remain with machine in provided storage sleeve area. Latest revision manual available on vendor's web site.
- Test verify stabilizer brake function before each use. Do not over-force moving or rolling the **LIFT TOOL** with stabilizer brake engaged.
- Do not move **LIFT TOOL** while platform is raised, except for minor positioning.
- Do not exceed rated load capacity. See **LOAD CAPACITY CHART** regarding maximum loads at center versus edge of extended platform.
- Only raise load if properly centered on platform. Do not place more than 200 lb (91 kg) on edge of sliding platform shelf also considering the load's center of mass/gravity (CoG).
- Do not corner load the platform tilt riser accessory option. Secure platform riser tilt option to main shelf in all four (4x) locations with provided hardware only, prior to use. Load objects are designed to slide on/off smooth platforms without appreciable force, so take care not to push or lean. Keep riser tilt option flat at all times except for final minor adjustment when needed.
- Do not stand under overhanging load.
- Do not use on uneven surface, incline or decline (major ramps).
- Do not stack loads.
- Do not operate while under the influence of drugs or alcohol.
- Do not support ladder against **LIFT TOOL**.
- Tipping hazard. Do not push or lean against load with raised platform.
- Do not use as a personnel lifting platform or step. No riders.
- Do not stand on any part of lift. Not a step.
- Do not climb on mast.
- Do not operate a damaged or malfunctioning **LIFT TOOL** machine.
- Crush and pinch point hazard below platform. Only lower load in areas clear of personnel and obstructions. Keep hands and feet clear during operation.
- No Forks. Never lift or move bare **LIFT TOOL MACHINE** with pallet truck, jack or fork lift.
- Mast extends higher than platform. Be aware of ceiling height, cable trays, sprinklers, lights, and other overhead objects.
- Do not leave **LIFT TOOL** machine unattended with an elevated load.
- Watch and keep hands, fingers, and clothing clear when equipment is in motion.
- Turn Winch with hand power only. If winch handle cannot be cranked easily with one hand, it is probably over-loaded. Do not continue to turn winch past top or bottom of platform travel. Excessive unwinding will detach handle and damage cable. Always hold handle when lowering, unwinding. Always assure self that winch is holding load before releasing winch handle.
- A winch accident could cause serious injury. Not for moving humans. Make certain clicking sound is heard as the equipment is being raised. Be sure winch is locked in position before releasing handle. Read instruction page before operating this winch. Never allow winch to unwind freely. Freewheeling will cause uneven cable wrapping around winch drum, damage cable, and may cause serious injury. (C048)

Power and cabling information for NEBS (Network Equipment-Building System) GR-1089-CORE

The following comments apply to the IBM servers that have been designated as conforming to NEBS (Network Equipment-Building System) GR-1089-CORE:

The equipment is suitable for installation in the following:

- Network telecommunications facilities
- Locations where the NEC (National Electrical Code) applies

The intrabuilding ports of this equipment are suitable for connection to intrabuilding or unexposed wiring or cabling only. The intrabuilding ports of this equipment *must not* be metallically connected to the interfaces that connect to the OSP (outside plant) or its wiring. These interfaces are designed for use as intrabuilding interfaces only (Type 2 or Type 4 ports as described in GR-1089-CORE) and require isolation from the exposed OSP cabling. The addition of primary protectors is not sufficient protection to connect these interfaces metallically to OSP wiring.

Note: All Ethernet cables must be shielded and grounded at both ends.

The ac-powered system does not require the use of an external surge protection device (SPD).

The dc-powered system employs an isolated DC return (DC-I) design. The DC battery return terminal *shall not* be connected to the chassis or frame ground.

The dc-powered system is intended to be installed in a common bonding network (CBN) as described in GR-1089-CORE.

Site preparation and physical planning

These guidelines help you prepare your site for the delivery and installation of your server.

Site selection

The selection of a site for information technology equipment is the first consideration in planning and preparing for the installation. Determine whether a new site is to be constructed or alterations are to be performed on an existing site.

This section provides specific information on building location, structure, and space requirements for present and future needs.

Utilities

Power and communication facilities must be available in the quantities required for operation. If these are inadequate, contact the utility company to determine if additional services can be made available.

Exposure to hazards

Pollution, flooding, radio or radar interference, and hazards caused by nearby industries can cause problems to information technology equipment and recorded media. Any indication of exposure in these areas should be recognized and included in the planning of the installation.

Access

Define an access route from your loading dock to your data processing area before delivery of your server.

A preliminary check of the building will show if adequate access for the normal delivery of supplies and servers exists. A small alley, a narrow door opening, or limited access to the delivery area can become inhibitive to installation. The loading dock, passageways, and elevators should be able to accommodate heavy, oversized data processing support equipment such as air conditioning equipment.

Access route

Define an access route from the loading dock to the data processing area. A small alley (cannot accommodate delivery truck), a narrow door opening <914 mm (<36 in.), low height 2032 mm (<80 in.), or limited access to the delivery area can become inconvenient during the delivery process. If the heights of the truck bed and the dock surface do not match, the ramp angle should be such that the machine frame does not bottom out while taking it from the truck bed to the dock surface.

Within your site, ramps from hallways to computer-room floors should conform to the American Disabilities Acts (ADA). The ADA requirement states that the ramp should have a 1:12 relationship. For each inch of vertical height of the raised floor, one foot of ramp length should be provided. As an example, if the raised floor height is 304.8 mm (12 in.), then the ramp length should be 3.66 m (12 ft). The ramps should also be strong enough to support the weight of the server while it is being moved over the surface. The hallways and doors should be wide enough and high enough to allow passage of the server, and ensure adequate turning radius in the hallway. The overhead clearance to pipes and ducts must be sufficient to allow movement of computer equipment, air conditioners, and electrical equipment. Most standard passenger elevators are rated for 1134 kg (2500 lb). Selected information technology equipment, and some site infrastructure equipment such as air conditioning units might exceed 1134 kg (2500 lb). Access to a freight elevator with a minimum rating of 1587 kg (3500 lb) is recommended.

Review the access route from the loading dock to the computer room to prevent problems when moving the frames. Consider making a cardboard template to check the access route for height, width, and length interference. Employ qualified experts if special rigging is required to get the server from the loading dock to the computer room.

Because the dynamic loads of rolling frames are higher than the static loads of stationary frames, floor protection is required at delivery time. It is also important to consider the caster point loads. Some floors cannot withstand the force exerted by the casters of heavier systems. For example, caster point loads on some servers can be as high as 455 kg (1,000 lb). This can penetrate, or otherwise damage, the surface of some floors.

It is also important to protect the raised floor from damage when moving servers or relocating processors in the computer room. Ten mm (3/8 in.) plywood sheeting provides adequate protection. For some of the heavier high-end servers, it is recommended that you use tempered masonite or plyron. Plywood might be too soft for the heavier servers.

Delivery and subsequent transportation of the equipment

DANGER

Heavy equipment—personal injury or equipment damage might result if mishandled. (D006)

You must prepare your environment to accept the new product based on the installation planning information provided, with assistance from an IBM Installation Planning Representative (IPR) or IBM authorized service provider. In anticipation of the equipment delivery, prepare the final installation site in advance so that professional movers or riggers can transport the equipment to the final installation site within the computer room. If for some reason, this is not possible at the time of delivery, you must make arrangements to have professional movers or riggers return to finish the transportation at a later date. Only professional movers or riggers should transport the equipment. The IBM authorized service provider can only perform minimal frame repositioning within the computer room, as needed, to perform required service actions. You are also responsible for using professional movers or riggers when you relocate or dispose of equipment.

Acclimation

Server and storage equipment (racks and frames) must be gradually acclimated to the surrounding environment to prevent condensation.

When server and storage equipment (racks and frames) is shipped in a climate where the outside temperature is below the dew point of the destination (indoor location), there is a possibility that water condensation can form on the cooler inside and outside surfaces of the equipment when the equipment is brought indoors.

Sufficient time must be allowed for the shipped equipment to gradually reach thermal equilibrium with the indoor environment before you remove the shipping bag and energize the equipment. Follow these guidelines to properly acclimate your equipment:

- Leave the system in the shipping bag. If the installation or staging environment allows it, leave the product in the full package to minimize condensation on or within the equipment.
- Allow the packaged product to acclimate for 24 hours.¹ If there are visible signs of condensation (either external or internal to the product) after 24 hours, acclimate the system without the shipping bag for an additional 12 - 24 hours or until no visible condensation remains.
- Acclimate the product away from perforated tiles or other direct sources of forced air convection to minimize excessive condensation on or within the equipment.

¹Unless otherwise stated by product-specific installation instructions.

Note: Condensation is a normal occurrence, especially when you ship equipment in cold-weather climates. All IBM products are tested and verified to withstand condensation that is produced under these circumstances. When sufficient time is provided to allow the hardware to gradually acclimate to the indoor environment, there should be no issues with long-term reliability of the product.

Acoustics

Acoustic noise emission data allows you to assess noise levels for your data processing equipment.

Acoustic noise emission data on IBM products is provided for the benefit of installation planners and consultants to help predict acoustical noise levels in data centers and other installations of information technology and telecommunications equipment. Such noise declarations also allow you to compare noise levels of one product to another and to compare the levels to any applicable specifications. The format of the data provided conforms to ISO 9296: Acoustics - Declared Noise Emission Values of Computer and Business Equipment. The measurement procedures used to acquire the data conform to International Standard ISO 7779 and its American National Standard equivalent ANSI S12.10. In addition to the individual product noise declarations that appear in the IBM product-specific documents, an index of links to most of IBM product noise declarations is available online at Acoustical Noise Declarations for Selected IBM Products.

The following terms are used to present acoustical data.

- $L_{WA,d}$ is the declared (upper limit) A-weighted sound power level for a random sample of machines.
- $L_{pA,m}$ is the mean value of the A-weighted sound pressure levels either at the operator position or at the bystander (1-meter) positions for a random sample of machines.
- $\langle L_{pA} \rangle_m$ is the mean value of the space-averaged sound-pressure-emission levels at the one-meter positions for a random sample of machines.

Acoustical treatment of data centers or other rooms, in which the equipment is installed, is recommended to achieve lower noise levels. Lower noise levels tend to enhance employee productivity and avoid mental fatigue, improve communications, reduce employee complaints, and generally improve employee comfort. Proper room design, including the use of acoustical treatment, might require the services of a specialist in acoustics.

The total noise level of an installation with information technology and telecommunications equipment is an accumulation of all the noise sources in the room. This level is affected by the physical arrangement of the products on the floor, the sound reflective (or absorptive) characteristics of the room surfaces, and the noise from other data center support equipment such as air conditioning units and backup power equipment. Noise levels might be reduced with proper spacing and orientation of the various noise-emitting equipment. Provide sufficient space around such machines: the farther apart they can be placed, the lower the overall room noise will be.

In smaller installations, such as small offices and general business areas, pay additional attention to the location of equipment relative to the work areas of the employees. At work areas, consider locating personal computers and computer workstations next to the desk rather than on top of it. Small servers should be located as far away from personnel as possible. Locate nearby work areas away from the exhaust of computer equipment.

The use of absorptive materials can reduce the overall noise level in most installations. Effective and economical sound reduction can be achieved by using a sound-absorptive ceiling. The use of acoustically absorbing free-standing barriers can reduce the direct noise, increase room absorption and provide privacy. The use of absorptive material, such as carpeting on the floor, results in further reduction of the sound level in the room. Any carpeting used in a computer room must meet the electrical continuity requirements stated in *Static electricity and floor resistance*. To prevent computer room noise from reaching

adjacent office areas, walls should be constructed from the structural floor to the structural ceiling. Also, ensure that doors and walls are properly sealed. Acoustical treatment of overhead ducts might further reduce noise transmitted to or from other rooms.

Many IBM large systems products are offered with optional acoustical front and rear doors to help attenuate the noise of the product itself. Smaller IBM products might also offer special acoustical packages. If noise exposure is a concern for the installation planners or employees, inquiries should be made to IBM on the availability of such product options.

Related concepts:

“Static electricity and floor resistance” on page 78

Use these guidelines to minimize static electricity buildup in your data center.

Air conditioning determination

The air conditioning system must provide year-round temperature and humidity control as a result of the heat dissipated during equipment operation.

Heat dissipation ratings are given in the server specifications for each server. Air conditioning units should not be powered from the computer power panel because of the high starting current drawn by their compressor units. The feeder line for the air conditioning system and the computer room power should not be in the same conduit.

Consider the following factors when determining the air conditioning capacity necessary for installation:

- Information technology equipment heat dissipation
- Number of personnel
- Lighting requirements
- Amount of fresh air introduced
- Possible reheating of circulated air
- Heat conduction through outer walls and windows
- Ceiling height
- Area of floors
- Number and placement of door openings
- Number and height of partitions

Most servers are air-cooled by internal blowers. A separate air conditioning system is recommended for data processing installation. A separate system might be required for small systems or individual servers intended for operation when the building air conditioning system is not adequate or is not operational. Server heat dissipation loads are given on the server specifications for each server. See the environmental requirements in the server specifications for your server.

General guidelines for data centers

Use these general guidelines to set up your data center.

Refer to the latest ASHRAE publication, "Thermal Guidelines for Data Processing Environments", dated January, 2004. This document can be purchased online at ashrae.org. A dedicated section outlines a detailed procedure for assessing the overall cooling health of the data center and optimizing for maximum cooling.

Server and storage considerations

Most IBM servers and storage products are designed to pull chilled air through the front of the server and exhaust hot air out of the back. The most important requirement is to ensure that the inlet air

temperature to the front of the equipment does not exceed IBM environmental specifications. See the environmental requirements in the server specifications or hardware specification sheets. Make sure that the air inlet and exit areas are not blocked by paper, cables, or other obstructions. When upgrading or repairing your server, be sure not to exceed, if specified, the maximum allowed time for having the cover removed with the unit running. After your work is completed, be sure to reinstall all fans, heat sinks, air baffles, and other devices per IBM documentation.

Manufacturers, including IBM, are reporting heat loads in a format suggested by the ASHRAE publication, "Thermal Guidelines for Data Processing Environments", dated January, 2004. Although this data is meant to be used to for heat load balancing, care is required when using the data to balance cooling supply and demand as many applications are transient and do not dissipate constant rates of heat. A thorough understanding of how the equipment and application behave with regard to heat load, including considerations for future growth, is required.

Rack or cabinet considerations

Note: Racks are used throughout this section to also mean cabinets, frames, and any other commonly used term to identify the unit that houses rack-mounted equipment.

IBM Enterprise 19-inch racks are designed to allow maximum airflow through the equipment installed in the rack. Chilled air is pulled through the front and exhausted through the rear by the fans in the rack-mounted equipment. Most IBM racks come with a perforated rear door and an optional front door that is perforated. Some racks have optional acoustical treatment to reduce the noise emissions from the rack. If non-IBM racks are used, solid doors or doors with significant amounts of decorative glass are not recommended as these will not allow sufficient air to flow into and out of the rack.

Recirculation of hot air exiting the back of the rack into the front of the rack must be eliminated. There are two actions that can be taken to prevent air recirculation. First, filler or blanking panels must fill all unoccupied rack space that is not occupied by equipment shipped in rack. 1U and 3U filler panels are used to block air recirculation within the rack. If you do not have filler panels installed in your rack, these are available from IBM.

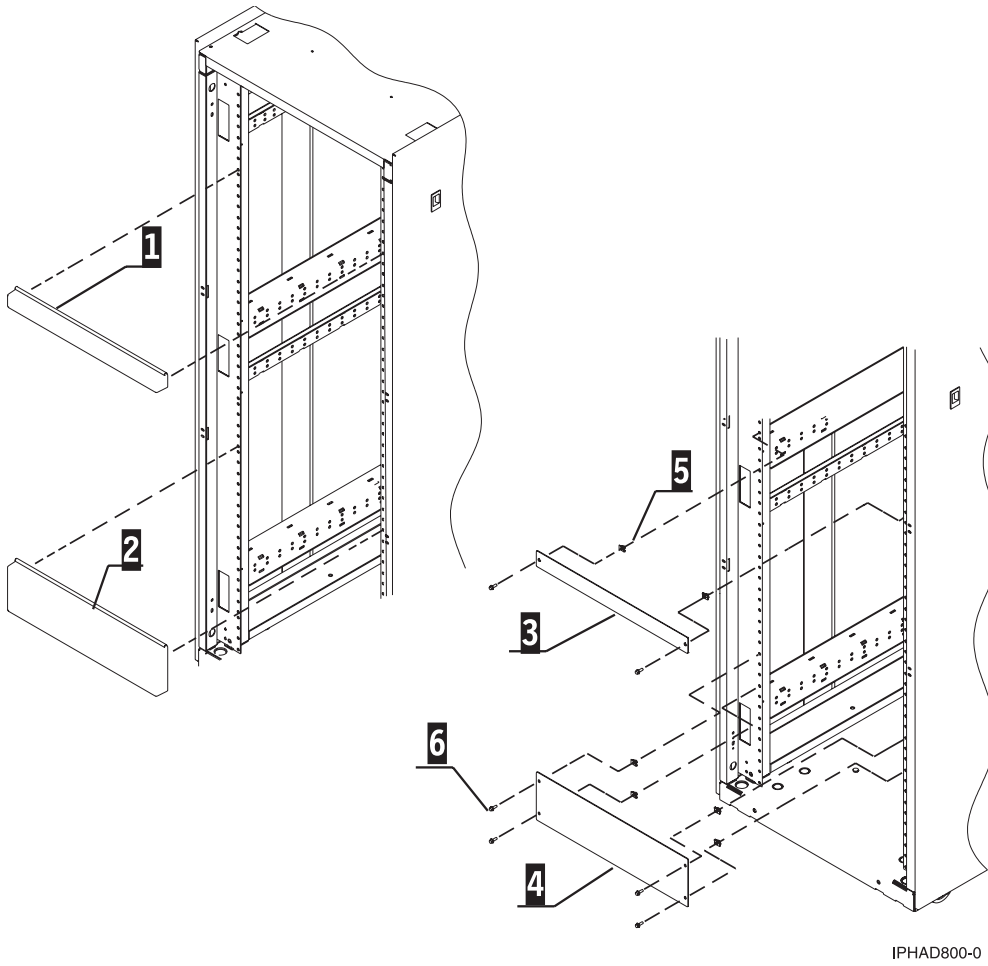

IPHAD800-0

Figure 1. 1U and 3U filler panel figure and part numbers.

1U and 3U filler panel figure and part numbers

Table 1. Parts

Index number	FRU part number	Units per assembly	Description
1	97H9754	As needed	1U Filler snap (black)
	62X3443	As needed	1U Filler snap (white)
2	97H9755	As needed	3U Filler snap (black)
	62X3444	As needed	3U Filler snap (white)
3	12J4072	As needed	1U Filler snap (black)
4	12J4073	As needed	3U Filler snap (black)
5	74F1823	2 per Item 3	M5 Nut clip
	74F1823	4 per Item 4	M5 Nut clip
6	1624779	2 per Item 3	M5 X 14 Hex flange
	1624779	4 per Item 4	M5 X 14 Hex flange

Second, allow proper operating clearance around all racks. See the clearance requirements in the server specifications or hardware specification sheets. The floor layout should not allow the hot air exhaust from the back of one rack to enter the front air inlet of another rack.

Finally, proper cable management is another important element of maximizing the airflow through the rack. Cables must be routed and tied down in such a way that they do not impede the movement of air into or out of the rack. Such impedance could significantly reduce the volumetric flow of air through the equipment.

Use a fan-assisted rack or cabinet with caution. Depending upon how much equipment is installed in the cabinet, the air movers in the cabinet may limit the amount of flow to less than what is required by the equipment.

Room considerations

Data centers designed and built in the last 10 years are typically capable of cooling up to 3KW of heat load per cabinet. These designs often involve raised floor air distribution plenums 18 to 24 inches in height, room ceiling heights of 8 to 9 feet, and Computer Room Air Conditioning (CRAC) units distributed around the perimeter of the room. IT equipment occupies roughly 30-35% of the total data center space. The remaining space is white space (for example, access aisles, service clearances), power distribution units (PDUs), and CRAC units. Until recently, little attention has been given to heat load assessments, equipment layout and air delivery paths, heat load distribution, and floor tile placement and openings.

Assessing the total heat load of your installation

A total heat load assessment should be conducted to determine your overall environment balance point. The purpose of the assessment is to see if you have enough sensible cooling, including redundancy, to handle the heat load that you plan to install or have installed. There are several ways to perform this assessment, but the most common is to review the heat load and cooling in logical sections defined by I-beams, airflow blockages, or CRAC unit locations.

Equipment layout and air delivery paths

The hot-aisle, cold-aisle arrangement that is explained in the ASHRAE publication, "Thermal Guidelines for Data Processing Environments", dated January, 2004, should be used. In the following figure, racks within the data center are arranged such that there are cold aisles and hot aisles. The cold aisle consists of perforated floor tiles separating two rows of racks. The chilled air from the perforated floor tiles is exhausted from the tiles and is drawn into the fronts of the racks. The inlets of each rack (front of each rack) face the cold aisle. This arrangement allows the hot air exhausting the rear of the racks to return to the CRAC units; thus, minimizing hot exhaust air from the rack circulating back into the inlets of the racks. CRAC units are placed at the end of the hot aisles to facilitate the return of the hot air to the CRAC unit and maximize static pressure to the cold aisle.

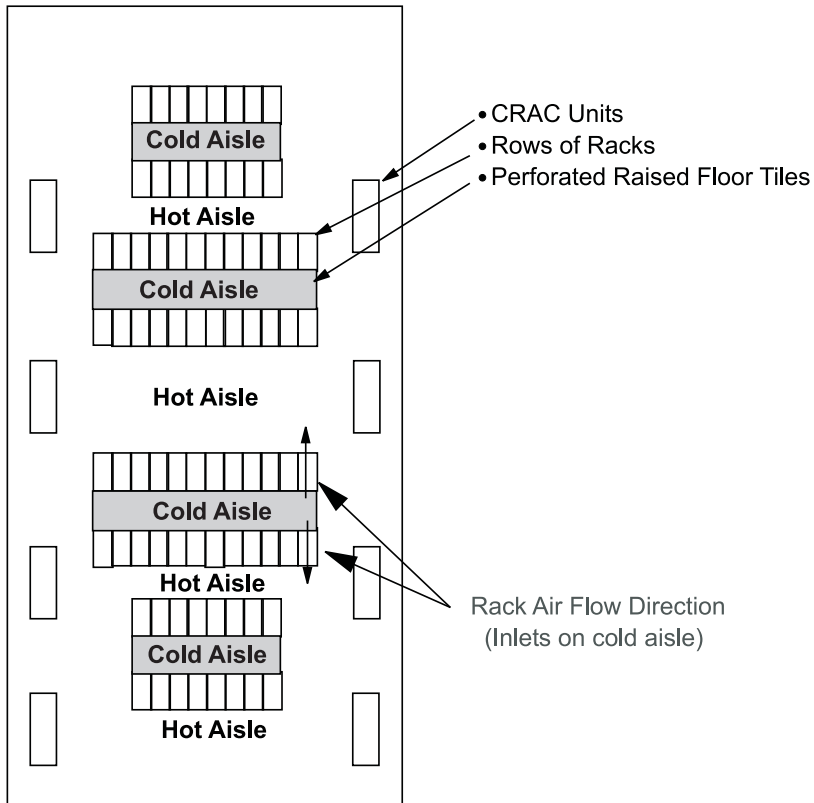

IPHAD807-0

Figure 2. Hot aisle and cold aisle arrangement

The key to heat load management of the data center is to provide inlet air temperatures to the rack that meet the manufacturer's specifications. Because the chilled air exhausting from the perforated tiles in the cold aisle may not satisfy the total chilled airflow required by the rack, additional flow will be drawn from other areas of the raised floor and may not be chilled. See the following figure. In many cases, the airflow drawn into the top of the rack, after the bottom of the rack has been satisfied, will be a mixture of hot air from the rear of the system and air from other areas. For those racks that are at the ends of a row, the hot airflow that exhausts from the rear of the rack and migrate to the front around the sides of the rack. These flow patterns have been observed in actual data centers and in flow modeling.

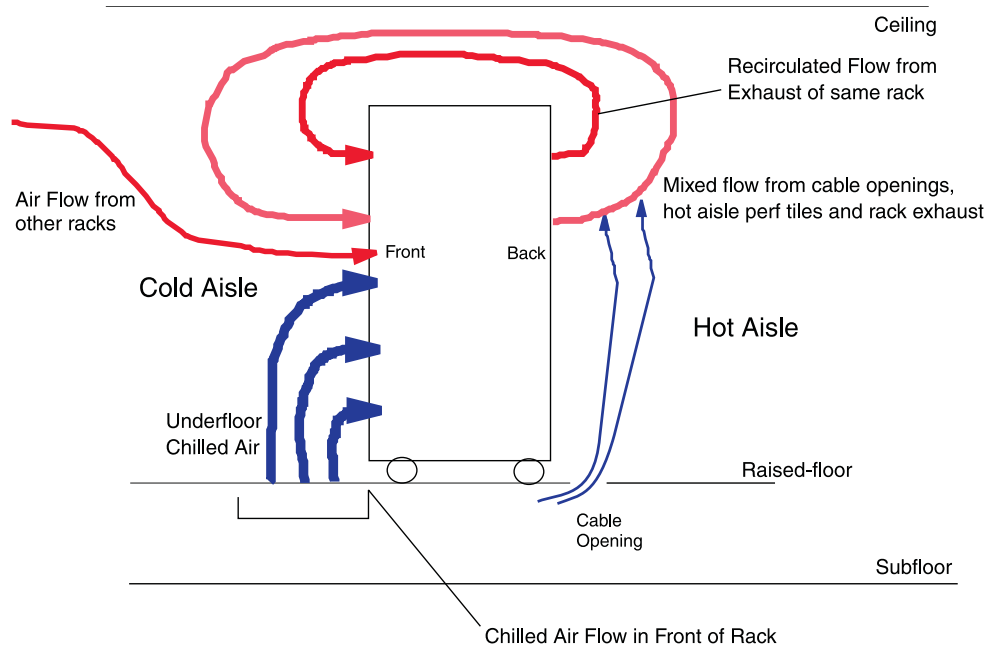

IPHAD808-0

Figure 3. Possible rack airflow patterns

For a data center that may not have the best chilled-air-flow distribution, the following figure gives guidance in providing adequate chilled airflow given a specific heat load. The chart takes into account worst-case locations in a data center and are the requirements to meet the maximum temperature specifications required by most IBM high-end equipment. Altitude corrections are noted on the bottom portion of the chart.

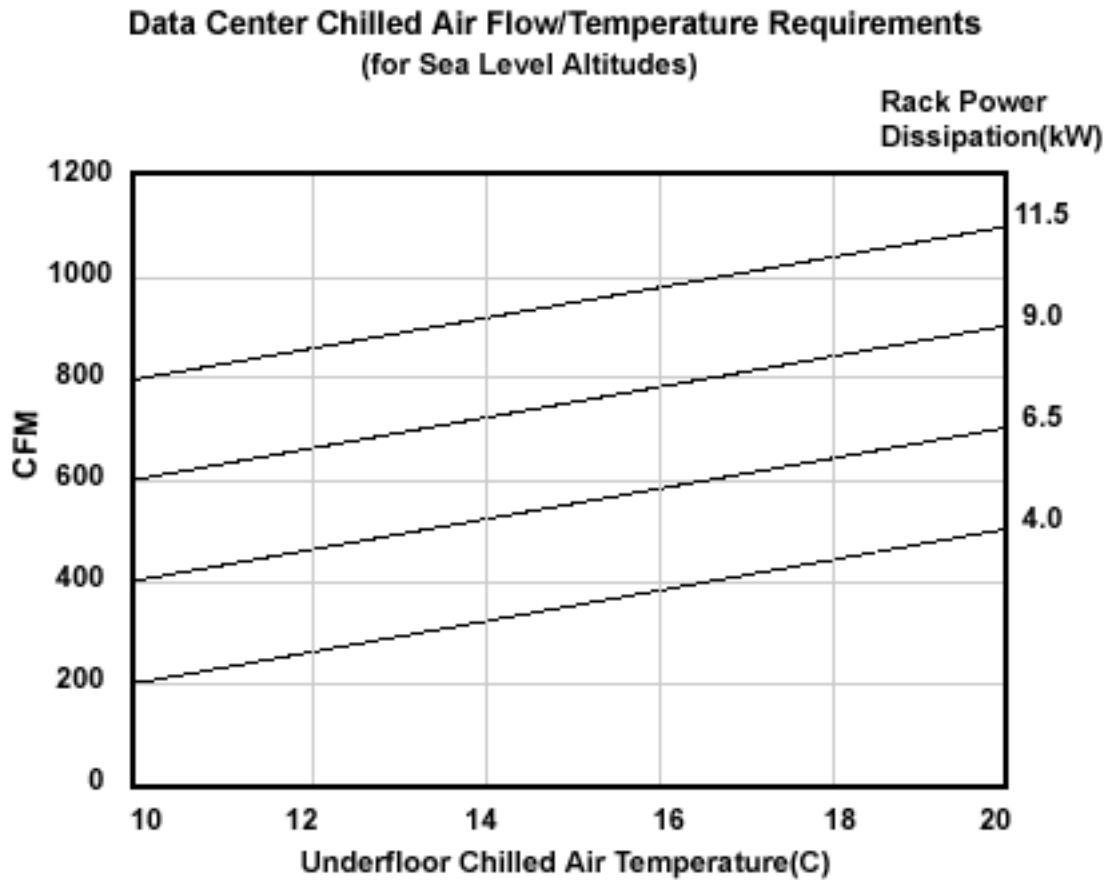

To determine the chilled air flowrates for higher altitudes add 1/2 C to the underfloor air temperature for every 1000 ft increase in altitude

Figure 4. High-end equipment chilled airflow and temperature requirements

The most common methods for delivering supply air to the racks can be found in *System air distribution*.

Heat load distribution

Increased performance capabilities and the accompanying heat load demands have caused data centers to have hot spots in the vicinity of heat loads that exceed 3KW. Facility owners are discovering that it is becoming increasingly difficult to plan cooling schemes for large-scale deployments of high-heat-load equipment. Essentially, two different approaches can be undertaken for a large-scale, high-end server or storage deployment:

- Provide ample cooling for maximum heat load requirements across the entire data center.
- Provide an average amount of cooling across the data center with the capability to increase cooling in limited, local areas.

Option 1 is very expensive and more conducive to new construction. For option 2, a number of things can be done to optimize cooling in existing data centers and possibly raise the cooling capability in limited sections.

One recommendation is to place floor tiles with high percent-open and flow ratings in front of the high-end racks. Another recommendation is to provide special means for removing hot exhaust air from the backs of the high-end racks immediately, before it has a chance to migrate back to the air intakes on racks in other parts of the room. This could be accomplished by installing special baffling or direct

ducting back to the air returns on the CRAC units. Careful engineering is required to ensure that any recommendation does not have an adverse effect on the dynamics of the underfloor static pressure and airflow distribution.

In centers where floor space is not an issue, it would be most practical to design the entire raised floor to a constant level of cooling and depopulate racks or observe a greater distance between racks in order to meet the per-cabinet capability of the floor.

Floor tile placement and openings

Perforated tiles should be placed exclusively in the cold aisles, aligned with the intakes of the equipment. No perforated tiles should be placed in the hot aisles, no matter how uncomfortably hot. Hot aisles are, by design, supposed to be hot. Placement of open tiles in the hot aisle artificially decreases the return air temperature to the CRAC units, thereby reducing their efficiency and available capacity. This phenomenon contributes to hot spot problems in the data center. Perforated tiles should not be placed in too close proximity to the CRAC units. In areas under the raised floor where air velocities exceed about 530 feet-per-minute, usually within about six tiles of the unit discharges, a Venturi effect may be created where room air will be sucked downward into the raised floor, opposite of the desired result of upward chilled air delivery.

The volumetric flow capabilities of floor tiles with various percent-open ratings are shown in the following figure.

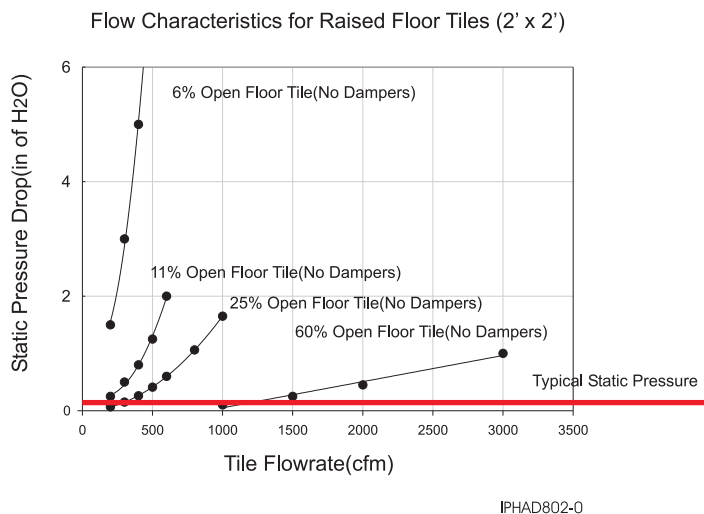

Figure 5. Volumetric flow capabilities of various raised floor tiles

Floor tiles in typical data centers deliver between 100 and 300 cfm. By optimizing the flow utilizing some of the guidelines set forth in this document, it may be possible to realize flows as high as 500 cfm. Flow rates as high as 700-800 cfm per tile are possible with tiles with the highest percent-open rating. Floor tiles must be aligned in the cold aisles with the intake locations on the equipment.

Openings in the raised-floor that are not there for the purpose of delivering chilled air directly to the equipment in the data center space should be completely sealed with brush assemblies or other cable opening material (for example, foam sheeting, fire pillows). Other openings that must be sealed are holes in data center perimeter walls, underfloor, and ceiling. Sealing all openings will help maximize under-floor static pressure, ensure optimal airflow to the cold aisles where it is needed, and eliminate short-circuiting of unused air to the CRAC unit returns.

Related concepts:

“System air distribution” on page 79

Careful attention should be given to the method of air distribution to eliminate areas of excessive air motion and hot spots.

Computer room layout

Effective computer room layout is dependent on several important factors.

The factors for effective computer room layout are as follows.

Service clearance and floor loading

Each piece of equipment that you plan to install has some minimum amount of space around it that is required to be kept clear so that service might be performed on that equipment, if it become necessary. Beyond keeping a clear area around the equipment, it is advisable that traffic patterns for work flow do not fall in service clearance boundaries. Do not allow the service clearance areas to be used for temporary or permanent storage. Exact clearance dimensions are supplied with the individual product specifications.

Generally, floor loading areas fall inside the service clearance boundaries. Consult individual product planning documentation and your seller for specific information about the equipment that you are planning to install. If you have not yet done so, review floor loading, weight distribution, service clearance, and machine area.

Physical and logical priority

Some types of peripheral equipment might require physical or logical positioning in relation to the processor or other equipment that might dictate where that equipment must be placed on your floor. Consult individual product planning documentation and your seller to determine if equipment that you are planning to install must be specifically placed. Such equipment should be situated in your floor layout diagrams first, before other equipment that does not require precise positioning.

Restrictive cable lengths

As computing power increases, cable lengths might decrease to support improvements in processing speed. Consult product-specific planning documentation and your seller to determine where cable lengths will allow you to place each piece of equipment on your floor. Review cabling and connectivity, especially if you are using Integrated Cluster Bus (ICB) cables.

Practical work space and safety

Allow enough room around equipment for normal movement of work flow. Consider the placement of equipment in relation to entrances and exits, windows, columns, wall-mounted equipment, such as circuit breaker boxes and electrical outlets, safety equipment, fire extinguishers, storage areas, and furniture. Be especially careful to allow easy access to things like the emergency power-off controls, smoke detectors, sprinkler systems, and under-floor or in-ceiling fire extinguishing systems.

If possible, make plans now to allow for future additional equipment. Plan cable routing and server locations to make it easy for additional units to be added.

Other equipment

In addition to the information technology equipment that you will be installing, allow room for office furniture and equipment, power and air conditioning, storage for operating supplies, and miscellaneous considerations, such as a meeting area, vending machine location, or water fountains.

It is highly recommended that scale drawings of your proposed layout be prepared and reviewed by both your seller and all service providers to ensure that your floor layout is physically capable and practically useful. Following is a chart of standard symbols used to create floor layouts.





















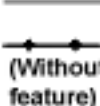

<u>In Plan Views:</u>	
	Cable Entry and Exit Area in the base of the machine. Locating dimensions are measured from the edge of the frame, not the cover. This does not indicate the floor cutout.
	Cable Exit Area, recommended
	Power Cord exit, 50/60
	Power Cord exit, 400 Hz
Power cords are supplied in 4.2 m (14 ft) lengths unless otherwise noted on the specification page. The length is measured from the symbol  or .	
	Swinging Gate
	Standard equipment outline (shows the machine with covers closed)
	Optional equipment outline
	Customer Engineer Indicator Panel
<u>In Cabling Schematics:</u>	
	Indicates a cable group coming from a machine
	Indicates a cable group going to a machine
	Service Area Boundary (Service clearances are measured from the machine with covers closed)
	Casters Locating dimensions are measured from the edge of the frame, not the cover.
	Leveling pads or glides (90 mm {3 1/2 in} typical diameter) Locating dimensions are measured from the edge of the frame, not the cover.
	Legs
	Non-raised floor cable exit
	Meter location
	Unit Emergency Switch
<u>Hinged Covers</u>	
	Single
	Bifold
	Offset Bifold

Figure 6. Standard symbols to create floor layouts

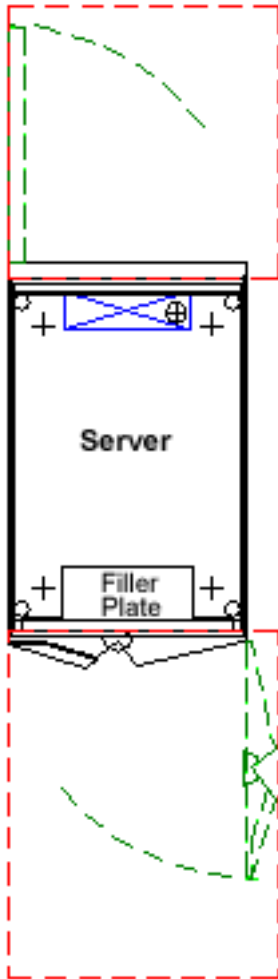

Figure 7. Sample plan view

Computer room location

Computer room location is affected by several factors.

Before selecting a location for the computer, give attention to these guidelines:

- The computer room should be in a noncombustible or fire-resistant building or room.
- The computer room should not be above, below, or adjacent to areas where hazardous materials or gases are stored, manufactured, or processed. If the computer must be located near such an area, take extra precautions to safeguard the area.
- If the computer room is below ground level, provide adequate drainage.

Safety consideration and fire prevention

Safety is a vital factor when planning computer installation. This consideration is reflected in the choice of the computer location, building materials used, fire prevention equipment, air conditioning and electrical systems, and personnel training.

If an inconsistency occurs between your server's recommendations and any local or national regulation, the more stringent of the recommendations or regulations should take precedence. The National Fire Protection Association standard, NFPA 75, provides guidelines for protection of information technology equipment. The customer is responsible for adherence to governmental regulations.

- Computer room walls should have a minimum of a 1-hour-fire-resistance rating and extend from the structural floor to the structural ceiling (slab-to-slab).
- In rooms used for critical operations, it is preferable to install processors in 1-hour-fire-rated rooms separate from the main computer room.
- If the computer room has one or more outside walls adjacent to a building that is susceptible to fire, consider taking the following precautionary actions:
 - Installing shatterproof windows in the computer room to improve the safety of personnel and equipment from flying debris and water damage. Usually, windows in the computer room are undesirable because of security concerns, and the negative effect they have on temperature control. They can cause excessive heating in the summer, and excessive cooling in the winter.
 - Installing sprinklers outside the windows to protect them with a blanket of water if a fire occurs in the adjacent area.
 - Sealing the windows with masonry.
- Where a false (or hung) ceiling or insulating material is to be added, ensure that it is noncombustible or fire-resistant material. All duct work should be noncombustible. If combustible material is used in the space between the structural ceiling and the false ceiling, appropriate protection should be provided.
- A raised floor that is installed over the structural floor should be constructed of noncombustible or fire-retardant materials. If the structural floor is of combustible material, it should be protected by water sprinklers on the ceiling of the room below.

Note: Before the information technology equipment is installed, the space between the raised and the structural floors should be cleared of debris. This space should also be checked periodically after installation to keep it free of accumulated dust, possible debris, and unused cables.

- The roof, ceiling, and floor above the computer room and the storage area for recorded media should be watertight. Liquid piping, roof drains, and other potential sources of liquid damage should be rerouted around the area.
- The space under the raised floor in the computer room should be provided with drainage to protect against flooding or trapped water.
- Waste material containers should be constructed of metal with a flame-suppressant lid.

Fire prevention equipment in a computer room

Fire prevention equipment in the computer room should be installed as an added safety measure. A fire suppression system is the responsibility of the customer. Your insurance underwriter, local fire marshall, and local building inspector are all parties that should be consulted in selecting a fire suppression system that provides the correct level of coverage and protection. IBM designs and manufactures equipment to internal and external standards that require certain environments for reliable operation. Because IBM does not test any equipment for compatibility with fire suppression systems, IBM does not make compatibility claims of any kind nor does IBM provide recommendations on fire suppression systems.

- An early-warning fire detection system should be installed to protect the computer room and storage areas for recorded media. This system should activate both an audible and a visual alarm in the rooms and at a monitored central station.
- Portable carbon dioxide fire extinguishers, of suitable size and number, should be provided in the computer room for use on electrical equipment.
- Portable, pressurized-water extinguishers should be provided for combustible material such as paper.
- Extinguishers should be readily accessible to individuals in the area, and extinguisher locations should be marked so they are visible.

- Automatic sprinkler systems and gaseous total flooding systems are acceptable forms of fixed protection. For information on environmentally friendly gases for total flooding systems, consult NFPA 2001 titled Standard on Clean Agent Fire Extinguishing Systems.
- Special consideration should be used if you prefer a gaseous total flooding system. If a gaseous total flooding system is installed, include a time delay feature that allows investigation and evacuation from the covered area of the gaseous total flooding system. A cross-zoned detection system is suggested.
- The protected area must be evacuated whenever the gaseous total flooding system or its controls are being serviced. Additionally, a master Disarm switch, available for use by the system service personnel, is required. With the switch set in the off position, the detonators used to release the gaseous total flooding system must be made inoperative, even if the circuit fails elsewhere in the system. This switch must be placed in the off (manual) position before servicing begins to prevent possible accidental discharge of the gaseous total flooding system.
- Alternatives to ordinary wet pipe sprinkler systems might include dry pipe systems or preaction systems. Water flows into preaction systems only if triggered by smoke or heat detectors. The detection systems should be independent of gaseous total flooding system detection systems. The On-Off type of sprinkler head is not recommended because it is more prone to leakage.

To determine the proper fire protection required for the computer room, consult with your insurance underwriter and your local code authority.

Electromagnetic compatibility

Use this information to plan for server installation in an environment that has a high electromagnetic-radiated field.

Information technology equipment installation might occasionally be planned in an area that has a high electromagnetic-radiated field environment. This condition results when the information technology equipment is near a radio frequency source such as a radio-transmitting antenna (AM, FM, TV, or two-core radio), civilian and military radar, and certain industrial machines (rf induction heaters, rf arc welders, and insulation testers). If any of these sources are near the proposed site, a planning review might be appropriate to assess the environment and determine whether any special installation or product considerations are advisable to reduce interference. Consult your seller. Workstations located near devices like transformers or buried electrical conduits can experience jitter on the workstation display in the presence of strong magnetic fields.

Most products can tolerate low-frequency to very-high-frequency rf levels of 3 volts per meter. Field strengths greater than 3 volts per meter might cause operational or serviceability problems. Products have different tolerance levels to electromagnetic-radiated fields in different frequency ranges. Radar (frequency of 1300 MHz, and 2800 MHz) signals with field strengths of a maximum of 5 volts per meter are acceptable. If problems occur, reorientation of the server or selective shielding might be required.

Two-core radio or cellular telephone usage should be properly controlled in the computer room. To reduce the likelihood of a problem, the following recommendations should be considered when operating such equipment:

- Keep hand-held transmitters (for example, walkie-talkies, radio paging, and cellular telephones) a minimum of 1.5 m (5 ft) from information technology equipment.
- Use only an operator-controlled transmitting device (no automatic transmissions). Develop specific rules, such as - Do not transmit within 1.5 m (5 ft) of a fully covered operating server. If covers are open, do not transmit.
- Choose the minimum output power that will accomplish your communication needs.

Extremely low frequency (ELF) fields

With the exception of some video display cathode ray tubes (CRT), most information technology equipment is tolerant of extremely low frequency (ELF) electromagnetic fields. The video displays that use cathode ray tubes are more sensitive because they use electromagnetic fields to position the electron beam in normal operation. The extremely low frequency range covers frequencies between 0 and 300 Hz. It is also referred to as electrical power frequency because most world electrical power is generated at either 50 or 60 Hz.

IBM products tolerate ELF electromagnetic fields in the following ranges:

- Cathode ray tube video display: 15-20 milligauss
- Liquid crystal display (LCD) : 10 Gauss
- Magnetic tape equipment: 20 Gauss
- Disk drive equipment : 20 Gauss
- Processors or servers : 20 Gauss

Typical information technology centers exhibit an ambient electromagnetic field between 3-8 milligauss. Some equipment within a center may, under normal operation, produce fields in excess of 100 milligauss. Examples of equipment that produces large magnetic fields include: power distribution units, electric motors, electrical transformers, laser printers and uninterruptible power systems. However, magnetic field density decreases rapidly with distance. If a CRT display is located near equipment that produces large electromagnetic fields, the display may exhibit distortion such as poor focus, change in image shape or slight motion in static display images. Moving the CRT away from the equipment may remedy the problem.

Emergency planning for continuous operations

Planning for emergencies ensures that your data center continues to operate in the event of a power outage.

If a power outage occurs, continued operation depends on information stored on cards, tapes, or disks, and the equipment used to process the information being available immediately. Arrangements should be made for emergency use of other equipment and transportation of personnel, data, and supplies to a temporary location. Arrangements should also be made to ensure the continuous operation of environment equipment, such as air conditioning. Duplicate or master records and programming data should be maintained in a remote area, from which the necessary information can be taken to resume operation.

Precautions and personnel training

Further plans should include training of personnel to act in an emergency situation.

- Sound alarm signals for fire detection and for other abnormal conditions to familiarize personnel with the alarm.
- Monitor the computer room, air conditioning equipment room, and electrical and data storage room at all times.
- Inspect steam pipes and water pipes above the false ceiling to guard against possible damage due to accidental breakage, leakage, or condensation.
- Locate emergency exit doors in the computer area. The number of doors depends on the size and location of the area. Train personnel in emergency measures such as:
 - Shutting off all electrical power
 - Shutting off the air conditioning system
 - Shutting off the chilled water to the information technology equipment
 - Calling the fire company

- Handling fire extinguishers in the approved manner
- Operating a small-diameter fire hose
- Evacuating records
- Evacuating personnel
- Administering first aid

Lightning protection for communication wiring

Be sure to install lightning protection devices to protect communication wiring and equipment from surges and transients induced into the communication wiring. In any area subject to lightning, surge suppressors should be installed at each end of every outdoor cable installation, whether installed above the ground (aerial) or buried below the ground.

Information about lightning surge suppressors for communication wiring and recommended methods for outdoor communication cables can be found in the information technology product's physical planning documentation.

Environmental design criteria

Use these environmental design criteria to ensure that your data center environment provides optimal conditions for your server operation.

The following environmental specifications are based on an altitude 1800 m (5906 ft above sea level). Some systems have more restrictive requirements on temperature, moisture, and altitude. For more information, see the individual system specifications.

Airborne particulates (including metal flakes or particles) and reactive gases that act alone or in combination with other environmental factors such as humidity or temperature might pose a risk to the server. Risks that are posed by the presence of excessive particulate levels or concentrations of harmful gases include damage that might cause the server to malfunction or cease functioning altogether. The environmental specifications present limits for particulates and gases that are intended to avoid such damage. The limits must not be viewed or used as definitive limits because numerous other factors, such as temperature or moisture content of the air, can influence the impact of particulates or environmental corrosives and gaseous contaminant transfer. In the absence of specific limits that are presented in the environmental specifications, you must implement practices that maintain particulate or gas levels that are consistent with the protection of human health and safety. If IBM determines that the levels of particulates or gases in your environment have caused damage to the server, IBM might condition provision of repair or replacement of servers or parts on the implementation of appropriate remedial measures to mitigate such environmental contamination. Implementation of such remedial measures is a customer responsibility.

Table 2. Operating environment^f

Characteristics	Environment
Recommended temperature range ¹	18°C (64.4°F) – 27°C (80.6°F) ⁴
Low-end moisture	5.5°C (41.9°F) dew point
High-end moisture	60% relative humidity or 15°C (59°F) dew point
Gaseous contamination	Severity level G1 according to ANSI/ISA 71.04-1985 ² , which states that the reactivity rate of copper coupons is fewer than 300 Angstroms per month (Å/month, ≈ 0.0039 µg/cm ² -hour weight gain). ⁶ In addition, the reactivity rate of silver coupons is less than 200Å/month (≈ 0.0035 µg/cm ² -hour weight gain). ⁷ The reactive monitoring of gaseous corrosivity must be conducted approximately 5 cm (2 in.) in front of the rack on the air inlet side at one-quarter and three-quarter frame height off the floor or where the air velocity is much higher.

Table 2. Operating environment⁵ (continued)

Characteristics	Environment
Particulate contamination	<p>Data centers must meet the cleanliness level of ISO 14644-1 class 8. For data centers without airside economizer, the ISO 14644-1 class 8 cleanliness might be met by any of the following filtration methods:</p> <ul style="list-style-type: none"> • The room air might be continuously filtered with MERV 8 filters. • Air entering a data center might be filtered with MERV 11 or preferably MERV 13 filters. <p>For data centers with airside economizers, the choice of filters to achieve ISO class 8 cleanliness depends on the specific conditions present at that data center.</p> <p>The deliquescent relative humidity of the particulate contamination must be more than 60% RH.³</p> <p>Data centers must be free of zinc whiskers.⁸</p>
Notes:	
<ol style="list-style-type: none"> 1. The data is from ASHRAE Thermal Guidelines for Data Processing Environments, third edition (2012). For extended periods of time, information technology (IT) manufacturers recommend that data center operators maintain the recommended environment for maximum reliability. The allowable environment is where IT manufacturers test their equipment operation to verify that the equipment operates. This testing is not a statement of reliability of the IT equipment, but one of functionality of the IT equipment within the tested environment. See Table 3 and Table 4 on page 20 for the allowable environment. 2. ANSI/ISA-S71.04. 1985. <i>Environmental conditions for process measurement and control systems: Airborne contaminants</i>, Instrument Society of America, Research Triangle Park, NC, 1985. 3. The deliquescent relative humidity of particulate contamination is the relative humidity at which the dust absorbs enough water to become wet and promote ionic conduction. 4. For ambient temperatures that exceed 25°C (77°F), the acoustical noise levels of the system might increase as the speed of the air moving devices increases. 5. For acclimation considerations for IT equipment, see “Acclimation” on page 2. 6. The derivation of the equivalence between the rate of copper corrosion product thickness growth in Å/month and the rate of weight gain assumes that Cu₂S and Cu₂O grow in equal proportions. 7. The derivation of the equivalence between the rate of silver corrosion product thickness growth in Å/month and the rate of weight gain assumes that Ag₂S is the only corrosion product. 8. Surface debris is randomly collected from 10 areas of the data center on a 1.5 cm diameter disk of sticky electrically conductive tape on a metal stub. If examination of the sticky tape in a scanning electron microscope reveals no zinc whiskers, the data center is considered free of zinc whiskers. 	

Table 3. Allowable environment (product operating)

Classes	Product operations				
	Dry-Bulb temperature	Humidity range (non-condensing)	Maximum dew point (DP)	Maximum elevation	Maximum rate of change
A1	15°C - 32°C (59°F - 90°F)	20% - 80% RH	17°C (63°F)	3050 m (10000 ft)	5°C per 20 hours
A2	10°C - 35°C (50°F - 95°F)	8% - 80% RH	21°C (70°F)	3050 m (10000 ft)	5°C per 20 hours
A3	5°C - 40°C (41°F - 104°F)	-12°C (10°F) DP and 8% - 85% RH	24°C (75°F)	3050 m (10000 ft)	5°C per 20 hours
A4	5°C - 45°C (41°F - 113°F)	-12°C (10°F) DP and 8% - 90% RH	24°C (75°F)	3050 m (10000 ft)	5°C per 20 hours
B	5°C - 35°C (41°F - 95°F)	8% - 80% RH	28°C (82°F)	3050 m (10000 ft)	N/A

Table 3. Allowable environment (product operating) (continued)

Classes	Product operations				
	Dry-Bulb temperature	Humidity range (non-condensing)	Maximum dew point (DP)	Maximum elevation	Maximum rate of change
C	5°C - 40°C (41°F - 104°F)	8% - 80% RH	28°C (82°F)	3050 m (10000 ft)	N/A

Table 4. Allowable environment (product power off)

Classes	Product power off		
	Dry-Bulb temperature	Relative humidity (RH)	Maximum dew point
A1	5°C - 45°C (41°F - 113°F)	8% - 80%	27°C (81°F)
A2	5°C - 45°C (41°F - 113°F)	8% - 80%	27°C (81°F)
A3	5°C - 45°C (41°F - 113°F)	8% - 85%	27°C (81°F)
A4	5°C - 45°C (41°F - 113°F)	8% - 90%	27°C (81°F)
B	5°C - 45°C (41°F - 113°F)	8% - 80%	29°C (84°F)
C	5°C - 45°C (41°F - 113°F)	8% - 80%	29°C (84°F)

Table 5. Nonoperating environment²

Characteristics	Environment
Temperature	5°C (41°F) – 45°C (113°F)
Relative humidity	8% – 80%
Dew point	Less than 27°C (81°F)
Gaseous contamination	Severity level G1 according to ANSI/ISA 71.04-1985 ¹ , which states that the reactivity rate of copper coupons is fewer than 300 Angstroms per month (Å/month, ≈ 0.0039 µg/cm ² -hour weight gain). ³ In addition, the reactivity rate of silver coupons is less than 200Å/month (≈ 0.0035 µg/cm ² -hour weight gain). ⁴ The reactive monitoring of gaseous corrosivity must be conducted approximately 2 in. (5 cm) in front of the rack on the air inlet side at one-quarter and three-quarter frame height off the floor or where the air velocity is much higher.

Notes:

1. ANSI/ISA-S71.04. 1985. *Environmental conditions for process measurement and control systems: Airborne contaminants*, Instrument Society of America, Research Triangle Park, NC, 1985.
2. The IT equipment acclimation period is 1 hour per 20°C (68°F) of temperature change from the shipping environment to the operating environment.
3. The derivation of the equivalence between the rate of copper corrosion product thickness growth in Å/month and the rate of weight gain assumes that Cu₂S and Cu₂O grow in equal proportions.
4. The derivation of the equivalence between the rate of silver corrosion product thickness growth in Å/month and the rate of weight gain assumes that Ag₂S is the only corrosion product.

Table 6. Shipping and storage environment

Characteristics	Shipping environment	Storage environment
Temperature	-40°C to 60°C (-40°F to 140°F)	1°C – 60°C (33.8°F - 140°F)
Relative humidity	5% – 100% (no condensation)	5% – 80% (no condensation)
Wet bulb	Less than 29°C (84.2°F)	Less than 29°C (84.2°F)

Table 6. Shipping and storage environment (continued)

Characteristics	Shipping environment	Storage environment
Shipping package	IBM-approved Vapor barrier bag with desiccant	IBM-approved Vapor barrier bag with desiccant
<p>Notes:</p> <p>Solid-state drives (SSD) have the following restrictive limits for data retention:</p> <ul style="list-style-type: none"> • Do not exceed 60°C (140°F). • Do not store at 60°C (140°F) or more for over 30 days when new. • Do not store at 37.8°C (100°F) or more for over 180 days when new. • Do not store at 60°C (140°F) or more for over 6 days when relocating (cumulative time at the specified temperature). • Do not store at 37.8°C (100°F) or more for over 90 days when relocating. <p>Ensure that you backup your data first, if applicable, before shipping.</p>		

Air quality

Many systems are installed in environments other than the typical data center, business office, or clean industrial location. These environments might exhibit various temperatures, relative humidity, and levels of airborne particles or corrosive gases. IBM systems are designed to work within the environmental specifications that are shown in the previous tables unless otherwise noted on an individual system specification.

An environment is considered unacceptable when the temperature, relative humidity, corrosive gases, or solid particles in the air exceed specific limits set by IBM. Equipment that operates in environments that are classified as unacceptable might be subject to degraded performance and permanent damage if the equipment is not designed for such environments.

Contaminants

Systems are being installed in increasingly diversified industries. Some of these industries, as a by-product of their processes, cause the atmosphere to contain measurable quantities of gases and solid particles that are potentially harmful to electronic equipment. Urban areas that are highly industrialized might have levels of gases and solid particles that cause an unacceptable environment exposure to exist throughout an entire area.

IBM is concerned with two classes of atmospheric contaminants; solid particles and gases. Solid particles in the air are referred to as particulates. Water vapor can combine with these tiny, solid particles and form compounds. Such matter is said to be hygroscopic. It can be harmful, depending on the particulate composition. Gases can form harmful acids or bases when combined with water. Because of the ability to absorb moisture, the relative humidity and temperature are significant factors in an unacceptable environment.

High concentrations of gases, such as sulfur dioxide, nitrogen dioxide, ozone, and acidic gaseous chlorine, which are associated with industrial processes, are known to cause corrosion and failure of electronic components. In addition to gases, some industrial processes produce particulate contamination. These particles can settle (in the form of dust) in surrounding areas even though the process that produces the particles might be some distance away.

Industries that are engaged in processing petroleum, chemicals, primary metals, food, mining, and paper have a higher probability of encountering an unacceptable environment. However, contamination can be a result of construction, cleaning, or other activities that can occur anywhere.

A visual inspection is the first step in determining the likelihood of contamination. Some indicators of an unacceptable environment might include corrosion of metal such as door handles and hinges. Often, the presence of contaminants can be determined by odor as in the case of chlorine or sulfur, which have a distinctive smell. Observe whether a heavy layer of dust settles on surfaces, especially in the primary metals industry. This dust is often conductive and can create electrical arcing or short circuits if drawn into electronic equipment.

To determine adherence to IBM requirements for gases and particulates, laboratory techniques are necessary. Testing for gases and particulates involves special equipment and procedures. Contact your IBM installation planning representative for guidance.

If the environment is contaminated, IBM can also provide guidance on remediation, prevention, and control. Recommended solutions might include, but are not limited to, room pressurization, tighter relative humidity control, filtration, maintenance, and monitoring.

Floor construction and floor loading

Calculate the floor loads for your server with these formulas.

A floor loading assessment is the evaluation of the concrete subfloor, not the raised floor. The weight of the raised floor is considered in the floor loading formula.

The building floor must support the weight of the equipment to be installed. Although older devices might impose 345 kg/m² (75 lb/ft²) on the building floor, a typical server design imposes a load of no more than 340 kg/m² (70 lb/ft²). The following pounds-per-square-foot (lb/ft²) formula is used to calculate floor loading. For assistance with floor load evaluation, contact a structural engineer.

Floor Loading is: (machine weight + (15 lb/ft² x 0.5 svc clear) + (10 lb/ft² x total area))/ total area

- The floor loading should not exceed 240 kg/m² (50 lb/ft²) with a partition allowance of 100 kg/m² (20 lb/ft²) for a total floor load rating of 340 kg/m² (70 lb/ft²).
- The raised-floor weight plus the cable weight adds 50 kg/m² (10 lb/ft²) uniformly across the total area used in calculations and is included in the 340 kg/m² (70 lb/ft²) floor loading. (The total area is defined as: machine area + 0.5 service clearance.)
- When the service clearance area is also used to distribute machine weight (weight distribution/service clearance), 75 kg/m² (15 lb/ft²) is considered for personnel and equipment traffic. The distribution weight is applied over 0.5 of the clearance up to a maximum of 760 mm (30 in.) as measured from the machine frame.

The raised floor on which the system will be installed must be capable of supporting the system's weight. Contact the raised floor tile manufacturer, a structural engineer, or both to verify that the raised floor is safe to support a concentrated load equal to one third of the total weight of one rack on a single raised floor tile. Under certain circumstances, such as relocation, it is possible that the concentrated load on a single raised floor tile can be as high as one half of the total weight of one rack per caster. When you are installing two adjacent racks, it is possible that one caster from each rack can be placed on the same raised floor tile. The load on the raised floor tile can be as high as one third of the total weight of both racks.

Depending on the type of raised floor tile, additional supports, such as pedestals, might be necessary to maintain the structural integrity of an uncut tile or to restore the integrity of a tile that is cut for cable entry or air supply. Contact the raised floor tile manufacturer, a structural engineer, or both to ensure that the raised floor tiles and pedestals can support the concentrated loads.

General power information

Reliable electrical power is required for the proper functioning of your data processing equipment.

IBM information technology equipment requires a reliable electrical power source that is free from interference or disturbance. Electrical power companies generally supply power of sufficient quality. The Power quality, Voltage and frequency limits, Power load, and Power source topics provide the guidance and specifications needed to meet the requirements of the equipment. Qualified personnel must ensure that electrical power distribution system is safe and meets local and national codes. They must also ensure that the voltage measured at the power receptacle is within the specified tolerance for the equipment. In addition, a separate power feeder is required for items such as lighting and air conditioning. A properly installed electrical power system will help to provide for reliable operation of your IBM equipment.

Other factors to consider when planning and installing the electrical system include a means of providing a low impedance conducting path to ground (path to earth) and lightning protection. Depending on the geographical location, special considerations may be required for lightning protection. Your electrical contractor should meet all local and national electrical code requirements. Building electrical power is normally derived from a three-phase power distribution system. General office areas are normally provided with single-phase power outlets, and data processing rooms are provided with three-phase power.

Some IBM IT equipment and devices may require standard three-phase power; others may require single-phase power. The power requirements for each device are specified in the individual server specifications for that server. Nominal voltage, plugs, receptacles, and in some cases, conduit and back boxes are listed in the specific server specifications. Refer to the respective server specifications to determine the power requirements. Ensure that existing branch circuit outlets are the correct type and are properly grounded.

Dual-power installation configurations

These dual-power installation configurations allow you to leverage the fully-redundant power features of your server.

Some IBM Systems models are designed with a fully redundant power system. The possible power installation configurations are:

Dual-power installation: Redundant distribution panel and switch

This configuration requires that the system receives power from two separate power distribution panels.

Each distribution panel receives power from a separate piece of building switch gear. This level of redundancy is not available in most facilities.

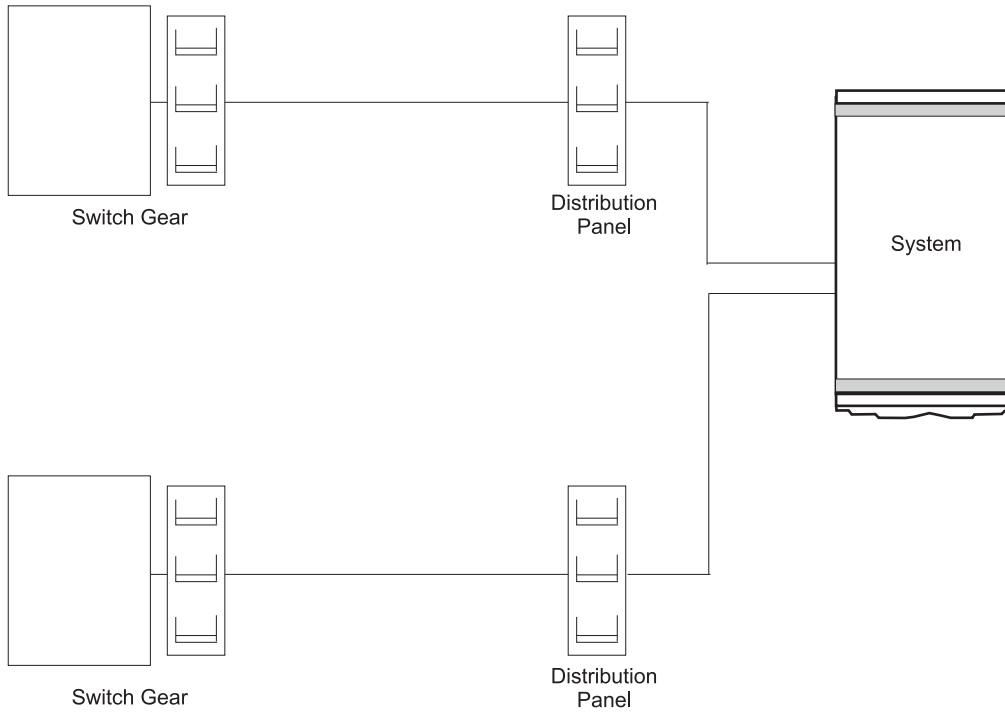

Figure 8. Dual power installation - Redundant distribution panel and switch

Dual-power installation: Redundant distribution panel

This configuration requires that the system receives power from two separate power distribution panels.

The two distribution panels receive power from the same piece of building switch gear. Most facilities should be able to achieve this level of redundancy.

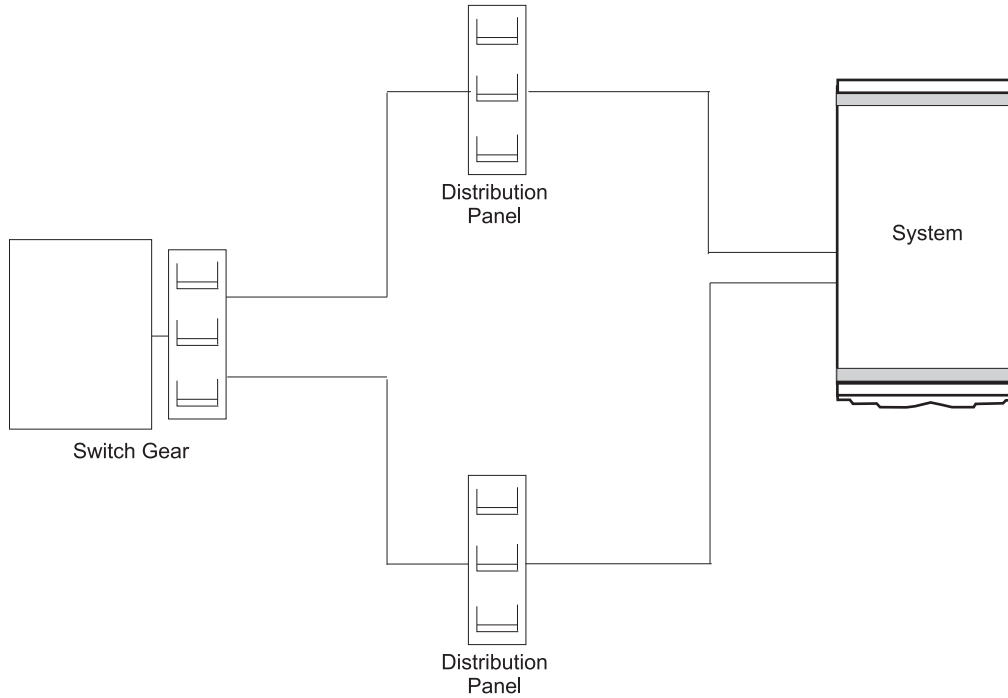

Figure 9. Dual power installation - Redundant distribution panel

Single distribution panel: Dual circuit breakers

This configuration requires that the system receives power from two separate circuit breakers in a single power panel.

This configuration does not make full use of the redundancy provided by the processor. It is, however, acceptable if a second power distribution panel is not available.

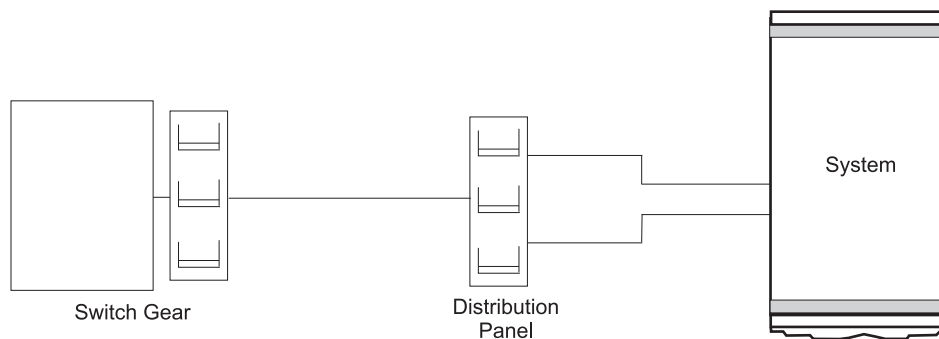

Figure 10. Single distribution panel - Dual circuit breakers

Lighting

Proper lighting is required to normally operate the server and when service is required.

Light sources in the equipment room and work station areas should have a general lighting level of 300 - 500 lumens/m² (lux) or 30 - 50 foot-candles. When preparing the equipment room and work areas, consider painting the room a light color with a white ceiling to reflect (rather than absorb) light. To lessen

any glare, windows should not be in an operator's field of vision or directly facing the display screen. Direct sunlight can cause light-sensing devices to malfunction and make observations of various signal lamps difficult.

To avoid eye fatigue, light sources should be compatible. Universal white fluorescent lamps are compatible with both incandescent lamps and daylight.

The following figure shows a suggested lighting layout for a workstation.

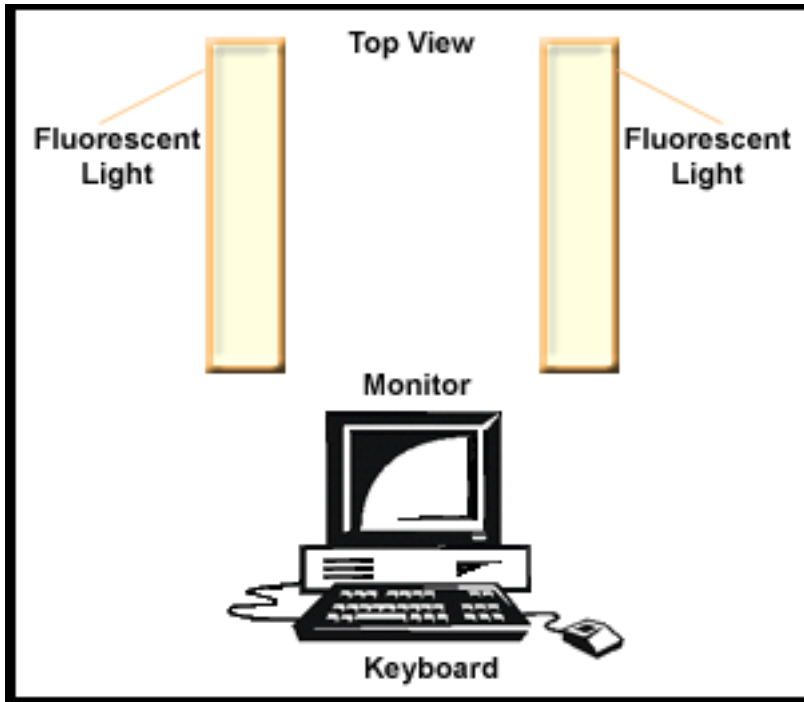

Figure 11. Typical lighting for a workstation

Provide and maintain emergency lighting, of sufficient intensity, to ensure a safe exit.

Material and data storage protection

Special safety considerations are required when storing data or other material.

Consider the following factors:

- Any data or material stored in the computer room, whether in the form of magnetic tapes, paper tapes, cards, or paper forms, should be limited to the minimum needed for safe, efficient operation and should be enclosed in metal cabinets or fire-resistant containers when not in use.
- For security purposes, and protection against fire, a separate room for material storage is strongly recommended. This room should be constructed of fire-resistant material (minimum 2-hour-fire-resistance rating). An approved fixed extinguishing system is recommended. Fixed extinguishing systems include automatic sprinklers and approved total flooding gaseous systems.

If continuity of operation is critical, plan a remote storage location for vital records if a disaster occurs. Key considerations in the choice of an off-site location for data storage are that the area is:

- Not subject to the same risk that might occur in the computer room.
- Suitable for long-term storage of hardcopy records and magnetic media files.

Air conditioning systems

In most installations, the computer area is controlled by a separate air conditioning system. Therefore, emergency power-off switches for the equipment and air conditioning should be placed in convenient locations, preferably near the console operator and next to the main exit doors. See National Fire Protection Association standard, NFPA 70 article 645, for information.

- When the regular building air conditioning system is used, with supplemental units in the computer area, the supplemental units would then be handled as stated above. The regular building air conditioning system should have an audible alarm to alert maintenance personnel of an emergency.
- Fire dampers should be located in all air ducts at fire walls.
- The air filters in the air conditioning system should contain noncombustible or self-extinguishing material.

Electrical systems

Provide a mainline disconnect control for the computer equipment at a remote location. The remote controls should be in a convenient location, preferably near the console operator and next to the main exit doors. They should be next to the power-off switch for the air conditioning system and should be properly marked. A light should be installed to indicate when power is on. The National Electric Code (NFPA 70) article 645 states that a single disconnecting means to control both the electronic equipment and the HVAC system is permitted.

- If continuity of operation is essential, a standby power source should be installed.
- It is advisable to install an automatic battery-operated lighting unit to illuminate an area if a power or lighting circuit failure occurs. This unit is wired to and controlled by the lighting circuit.
- Watertight connectors are recommended under raised floors because of the moisture exposures (water pipe leaks, high humidity levels) under raised floors.

Overhead cabling

Historically, cabling (power or signal) for computer systems has been done within a rack or under a raised floor. There has been growing customer interest in using nonraised floors, requiring some or all of the cabling to be overhead.

This information describes the considerations associated with overhead cabling of IBM 19-inch racks (7014-T00, 7014-T42, 7014-B42, 0551, or 0553) and 24-inch racks ordered with IBM Power Systems™ servers.

As with all electronic devices, cables and power cords can act as antennas, emitting electromagnetic energy. The levels released are small (less than a mobile phone) and are not dangerous to people, but can interfere with other electronic devices. For example, a mobile phone's emission is measured in volts per meter while a Power Systems cable emission is measured in microvolts per meter. However, small amounts of electromagnetic emissions can add up as several cables emit more electromagnetic energy than a single cable.

Laying cables on a concrete floor helps to reduce emissions as the floor absorbs some of the energy. Placing cables under a raised floor also helps to reduce emissions. However, when suspending cables in the air, this type of cable layout eliminates the emission reductions provided by a concrete subfloor, a raised floor, or both.

IBM supported configurations for servers and I/O units in racks have passed both industry and IBM tests requirements for electromagnetic compatibility (EMC). These tests are completed by laying cables on the floor. To support overhead cabling, additional testing is required by placing the cables overhead and

retesting selected configurations. Many overhead cabling configurations have not been tested and are not supported by IBM. Therefore, overhead cabling with a Power Systems server in IBM 19-inch and 24-inch racks is generally an unsupported configuration.

Generally, using overhead cabling is not a problem. The potential for causing interference with any device outside the data center is quite small. However, the only way to know if a configuration would be problematic is to test it and see if there are interference problems in the data center. If the overhead cabling is causing a problem, it could affect a wireless device in the data center (for example, a wireless temperature or humidity probe trying to report data at a constant rate, but which is sending wrong or intermittent data instead). The interference could be on a two-way radio that has more background noise than expected. Or, the interference could be poor reception in a radio or television.

It is possible that the emissions from overhead cabling could cause problems with another computer or storage equipment in the data center, but it is unlikely.

There are different actions that you can take to mitigate emissions when using overhead cabling. Note that, while helpful, using these mitigation techniques does not mean you have an IBM supported configuration because IBM has not conducted extensive testing for your specific configuration. The mitigations might address all the problems, but until tested and certified, the system is not officially supported by IBM.

Example mitigations are as follows:

- Use shielded (Ethernet) cables in place of unshielded (Ethernet) cables.
- Add shielding to the cable paths, and ground the shielding on both ends of the cable.
- Add shielding to the cables themselves.
- Add filters (chokes, pigtailed, ferrite cores, and other such filters) to the cables.

Filters reduce emissions over a specific frequency range. Different types of cables emit differently based on their composition, length, signals carried, and where they are attached. A fiber optic cable does not emit radio frequency (RF) like a metallic cable unless the fiber optic cable has a metallic shield. Power cords, Small Computer System Interface (SCSI), serial-attached SCSI (SAS), copper Fibre Channel, and system power control network (SPCN) cables typically have modest emissions. InfiniBand cables are significant emitters when compared to power cords. Unshielded Ethernet cables are probably the most significant emitters. Longer metallic cables can be thought of as bigger antennas and emit more. Shorter cables emit less. If you have multiple 19-inch or 24-inch racks and need to run cables from one rack to the other, you can reduce emissions by keeping the cables in the rack instead of going over the top and into the other rack.

Using overhead cables with your Power Systems servers does not void your IBM warranty or maintenance agreement.¹ However, if IBM service and support believes that a problem might be related to the use of overhead cabling, then IBM service and support has the right to suspend the warranty or maintenance agreement until the system is put back into compliance. Therefore, overhead cabling options should be discussed with your local IBM service and support organization before you implement a new cabling scheme.

Cables can always be routed out the bottom of the product in accordance with the product installation instructions. After the cables are routed to exit the bottom of the product, they can be externally routed upward to the overhead cabling trays using appropriate cable management techniques.

¹The customer must not cut or drill any additional holes or openings into the product enclosure under any circumstances. Similar to EMC testing, IBM must meet industry and internal standards for product safety. These requirements are not only for the safety of IBM customers, but also for service personnel. Any alteration of the physical structure of an enclosure voids the product safety certifications received for the product.

Planning for communications

Your installation requires a variety of communication equipment to support the computer installation. Telephone lines, fax lines, and the remote support facility (RSF) are just some of the types of communications that you will need to have installed.

You will have to refer to specific product planning documentation for each type of communication equipment that you are going to install. The main tasks to prepare for communication equipment are:

1. Get an exact list of the communication features that your company ordered:
 - a. Make copies of the communication-feature planning list.
 - b. Determine the specific communication features on order from your company's copy of the purchase agreement.
 - c. Check the types of communication features and enter the quantities of feature cards and cables on the communication-feature planning list. This list is your record of communication features to help in your planning and coordinating tasks.
2. Prepare a communication-feature planning list:
 - Use a separate planning list for each communication feature. On the list, connect the device and modem blocks with lines to indicate the feature's arrangement in the network. Indicate whether the network is switched or nonswitched. The network-diagram part of the list is for typical networks. If enough space is not available on the planning list, use additional lists or separate sheets of paper to draw the network.
 - Finally, check or fill in the remaining part of the communication-feature planning list. You might not be able to answer some items, such as the modem model, until you meet with the local communication company representative.
3. Meet with the local communication company representative to order needed equipment and to discuss service:
 - Define the equipment and wiring to be provided by the communication company.
 - Determine the power outlets needed for communication company equipment.
 - Place an order for the needed services.
 - Schedule the installation work the communication company will do before the arrival of your server.
 - Install a telephone for the service representative, if recommended.
 - Define the options when you order a handset with a switched line.
4. Meet with the modem vendor to discuss the following items:
 - Options such as switched or leased line, line speed, auto answer, and clocking must be known.
 - Who will install and who will service the original equipment manufacturer's (OEM) modem.
 - What modems will require couplers, jacks, and plugs.
 - Match the coupler and the modem.
 - The telephone company must be notified of the Federal Communications Commission (FCC) registration number and ringer equivalence number.
 - Modems that require power outlets.
5. Coordinate the installation of your equipment with remote locations to be sure the proper equipment is installed on time at both locations. Be sure the equipment at your location is compatible with the equipment at the remote location. Pay particular attention to these items:
 - The communicating devices must use the same type of communication features.
 - The devices must operate at the same speed (bits per second).
 - The modems must be compatible.
 - The couplers must match the modem.
 - The modem strapping (jumpers) must be the same at both ends of the line.

- Properly coordinating remote locations can prevent problems such as mismatched communication equipment. A copy of the completed communication feature planning list should be sent to the remote locations before the equipment is installed.
6. Determine and establish wiring practices for privately owned lines:
- Do not route your communication lines parallel with power lines. Power transients can cause electrical noise in your communication lines. Noise can also be caused by electric motors, radios, and radar equipment.
 - Use shielded outdoor-type cable where communication lines exit a building.
 - Install shunt-type lightning protection on all exterior communication lines, whether they are buried or overhead.
 - Ground the shields of overhead communication lines where cables enter or exit junction boxes or at other points where the shield is broken. For buried lines, ground the shield at each building exit or entry.
 - Shield continuity must not be broken where the ground conductor connects to the shield. Cable that includes a drain conductor is easier to install when multiple grounding is needed.

See the applicable national and local safety standards for communication regulations and requirements.

Planning for the installation of rear door heat exchangers

Use this information to prepare your location to facilitate the use of the IBM rear door heat exchanger.

The heat exchanger is a water-cooled device that is mounted on the rear of an IBM rack to cool the air that is heated and exhausted by devices inside the rack. A supply hose delivers chilled, conditioned water to the heat exchanger. A return hose delivers warmed water back to the water pump or chiller. In this document, this is referred to as a secondary cooling loop. The primary cooling loop supplies the building chilled water to secondary cooling loops, air conditioning units, and so on. The hoses for the secondary cooling loop are not included with this product. The rack on which you install the heat exchanger can be on a raised floor or a non-raised floor.

For heat exchanger performance information, see *Heat exchanger performance*.

For information about hoses, water treatment, and cooling distribution units for supplying conditioned water, see *Secondary cooling loop parts and services information*.

If you want to procure IBM installation planning services regarding what is needed to plan for supplying conditioned water and installing the rear door heat exchangers, see *Secondary cooling loop parts and services information*.

Planning considerations overview

As you plan the installation of the heat exchanger, include the following considerations:

- Providing chilled, conditioned water that meets the specifications that are outlined in *Water control and conditioning of the secondary cooling loop*.
- Procuring and installing the water supply system that is suitable for your data center. Details are provided in *Water delivery specifications for secondary loops*.
- Providing redundant secondary cooling loop water supply, or enough room air conditioning to handle a tolerable heat load if the function of one or more of the heat exchangers is compromised. If the rear door is opened for rack maintenance, or conditioned water supply to the door is stopped, the rack heat load is sent out into the room and must be handled by room air conditioning. This will occur until the conditioned water supply is restored.
- Providing floor or ceiling tile cutouts or protective coverings to avoid tripping hazards on non-raised floors as part of hose management.

Water control and conditioning of the secondary cooling loop

It is very important that the water that is being supplied to the heat exchanger meet the requirements that are described in this section. Otherwise, system failures might occur over time, as a result of any of the following problems:

- Leaks due to corrosion and pitting of the metal components of the heat exchanger or the water-supply system.
- Buildup of scale deposits inside the heat exchanger, which can cause the following problems:
 - A reduction of the ability of the heat exchanger to cool the air that is exhausted from the rack.
 - Failure of mechanical hardware, such as a hose quick-connect coupling.
- Organic contamination, such as bacteria, fungi, or algae. This contamination can cause the same problems as described for scale deposits. The water that is used to fill, refill, and supply the heat exchanger must be particle-free deionized water or particle-free distilled water with appropriate controls for avoiding these issues
 - Metal corrosion
 - Bacterial fouling
 - Scaling

The water cannot originate from the primary chilled-water system for the building but must be supplied as part of a secondary, closed-loop system.

Important: Do not use glycol solutions because they can adversely affect the cooling performance of the heat exchanger.

Water delivery specifications for secondary loops

This section describes the various hardware components that make up the delivery system secondary loop that provides the chilled, conditioned water to the heat exchanger. The delivery system includes pipes, hoses, and the required connection hardware to connect to the heat exchanger. Hose management in raised floor or non-raised-floor environments is also described.

The primary cooling loop is considered to be the building chilled-water supply or a modular chiller unit. The primary loop must not be used as a direct source of coolant for the heat exchanger for the following reasons:

- If the supply water temperature is below the room dew point, condensation forms and causes dripping from the door components.
- If a leak develops in the door, supply hose, or return hose, a large amount of water is available.

Procurement and installation of the components that are needed to create the secondary cooling loop system are required for this design and are your responsibility. See *Secondary cooling loop parts and services information* for information about suppliers of hoses and cooling distribution units.

Attention: The overpressure safety device must meet the following requirements:

- Comply with ISO 4126-1.

Note: Perform a search for ISO 4126-1.

- Be installed so that it is easily accessed for inspection, maintenance, and repair.
- Be connected as close as possible to the device that it is intended to protect.
- Be adjustable only with the use of a tool.
- Have a discharge opening that is directed so that discharged water or fluid will not create a hazard or be directed toward any person.
- Be of adequate discharge capacity to ensure that the maximum working pressure is not exceeded.
- Be installed without a shutoff valve between the overpressure safety device and the protected device.

Heat exchanger specifications

Heat exchanger specifications provide detailed information for your heat exchanger, including dimensions, weight, air source, water source, water pressure and water volume.

The following tables show the specifications for the heat exchanger.

Table 7. Operating specifications for 19-inch EIA-rail heat exchanger

Specifications	Specifications (continued)	Specifications (continued)
<p>Door size</p> <ul style="list-style-type: none"> • Depth: 142.6 mm (5.6 in.) • Height: 1945.4 mm (76.6 in.) • Width: 639 mm (25.2 in.) <p>Exchanger size</p> <ul style="list-style-type: none"> • Depth: 67 mm (2.6 in.) • Height: 1791.3 mm (70.5 in.) • Width: 438.6 mm (17.3 in.) <p>Door assembly weight</p> <ul style="list-style-type: none"> • Empty: 29.9 kg (66 lb) • Filled: 35.6 kg (78.5 lb) <p>Door heat removal capacity</p> <ul style="list-style-type: none"> • For examples of door heat removal capacity, see the illustrations in <i>Heat exchanger performance</i>. • In general, the door heat removal capacity percentage increases if one or more of the following events occur: <ul style="list-style-type: none"> – The water temperature decreases. – The water flow increases. – The server heat loads decrease. • The door heat removal capacity varies with water temperature, water flow rate, air temperature and flow, and total heat load of the servers. However, a typical high-load cabinet (20 - 32 kW or approximately 70 000 to 105 000 Btu per hour) can achieve 55 - 85% heat removal. 	<p>Air movement</p> <ul style="list-style-type: none"> • Provided by servers and other devices in the rack <p>Air source for servers</p> <ul style="list-style-type: none"> • Room air for front of rack. Air exhausts servers, moves through rear door heat exchanger and exits into the room (open loop) <p>Air temperature drop</p> <ul style="list-style-type: none"> • The temperature drop can be up to 25°C (45°F) between the air exiting the rack devices and the air exiting the heat exchanger on high heat load products. <p>Air impedance</p> <ul style="list-style-type: none"> • Air pressure drop across the heat exchanger is equivalent to the IBM acoustic 19-inch rear door 	<p>Water source</p> <ul style="list-style-type: none"> • User-supplied, compliant with specifications in this topic. <p>Water pressure</p> <ul style="list-style-type: none"> • Normal operation: 137.93 kPa (20 psi) • Maximum: 689.66 kPa (100 psi) • Pressure drop across heat exchanger: approximately 48 kPa (7 psi) <p>Water volume</p> <ul style="list-style-type: none"> • Exchanger: 2.8 liters (0.75 gallons) • Exchanger plus supply and return hoses to the pump unit: Maximum of approximately 15.1 liters (4.0 gallons) excluding pump unit piping and reservoir <p>Water temperature</p> <ul style="list-style-type: none"> • If no dew point control is available from the secondary loop cooling distribution unit, 18°C +/- 1 degree C (64.4°F +/- 1.8°F) must be maintained. • Lower temperature water is allowed as long as the water supply is monitored and adjusted to remain above room dew point (where heat exchanger is located). <p>Required water flow rate (as measured at the supply entrance to the heat exchanger)</p> <ul style="list-style-type: none"> • Minimum: 22.7 liters per minute (6 gallons per minute) • Maximum: 37.9 liters per minute (10 gallons per minute)

Table 8. Operating specifications for 24-inch EIA-rail heat exchanger

Specifications	Specifications (continued)	Specifications (continued)
<p>Door size</p> <ul style="list-style-type: none"> • Depth: 142.6 mm (5.6 in.) • Height: 1945.4 mm (76.6 in.) • Width: 771.8 mm (30.4 in.) <p>Exchanger size</p> <ul style="list-style-type: none"> • Depth: 67 mm (2.6 in.) • Height: 1791.3 mm (70.5 in.) • Width: 574.6 mm (22.6 in.) <p>Door assembly weight</p> <ul style="list-style-type: none"> • Empty: 31.7 kg (70 lb) • Filled: 39.9 kg (88.2 lb) <p>Door heat removal capacity</p> <ul style="list-style-type: none"> • Lab tests indicate 10 percent improvement over the 19-inch version of the door. • Up to 17 kW (58 000 Btu/hr) heat removal possible 	<p>Air movement</p> <ul style="list-style-type: none"> • Provided by servers and other devices in the rack <p>Air source for servers</p> <ul style="list-style-type: none"> • Room air for front of rack. Air exhausts servers, moves through rear door heat exchanger and exits into the room (open loop) <p>Air temperature drop</p> <ul style="list-style-type: none"> • The temperature drop can be up to 25°C (45°F) between the air exiting the rack devices and the air exiting the heat exchanger on high heat load products. <p>Air impedance</p> <ul style="list-style-type: none"> • Air pressure drop across the heat exchanger is equivalent to the IBM acoustic 24-inch rear door 	<p>Water source</p> <ul style="list-style-type: none"> • User-supplied, compliant with specifications in this topic. • 3/4-inch couplings on floor • Minimum 3/4-inch inside diameter hose required <p>Water pressure</p> <ul style="list-style-type: none"> • Normal operation: 137.93 kPa (20 psi) • Maximum: 689.66 kPa (100 psi) • Pressure drop across heat exchanger: approximately 48 kPa (7 psi) <p>Water volume</p> <ul style="list-style-type: none"> • Exchanger: 5.3 liters (1.4 gallons) • Exchanger plus supply and return hoses to the pump unit: Maximum of approximately 15.1 liters (4.0 gallons) excluding pump unit piping and reservoir <p>Water temperature</p> <ul style="list-style-type: none"> • If no dew point control is available from the secondary loop cooling distribution unit, 18°C +/- 1 degree C (64.4°F +/- 1.8°F) must be maintained. • Lower temperature water is allowed as long as the water supply is monitored and adjusted to remain above room dew point (where heat exchanger is located). <p>Required water flow rate (as measured at the supply entrance to the heat exchanger)</p> <ul style="list-style-type: none"> • Minimum: 22.7 liters per minute (6 gallons per minute) • Maximum: 37.9 liters per minute (10 gallons per minute)

Table 8. Operating specifications for 24-inch EIA-rail heat exchanger (continued)

Specifications	Specifications (continued)	Specifications (continued)
<p>Door size</p> <ul style="list-style-type: none"> • Depth: 142.6 mm (5.6 in.) • Height: 1945.4 mm (76.6 in.) • Width: 639 mm (25.2 in.) <p>Exchanger size</p> <ul style="list-style-type: none"> • Depth: 67 mm (2.6 in.) • Height: 1791.3 mm (70.5 in.) • Width: 438.6 mm (17.3 in.) <p>Door assembly weight</p> <ul style="list-style-type: none"> • Empty: 29.9 kg (66 lb) • Filled: 35.6 kg (78.5 lb) <p>Door heat removal capacity</p> <ul style="list-style-type: none"> • For examples of door heat removal capacity, see the illustrations in <i>Heat exchanger performance</i>. • In general, the door heat removal capacity percentage increases if one or more of the following events occur: <ul style="list-style-type: none"> – The water temperature decreases. – The water flow increases. – The server heat loads decrease. • The door heat removal capacity varies with water temperature, water flow rate, air temperature and flow, and total heat load of the servers. However, a typical high-load cabinet (20 - 32 kW or approximately 70 000 to 105 000 Btu per hour) can achieve 55 - 85% heat removal. 	<p>Air movement</p> <ul style="list-style-type: none"> • Provided by servers and other devices in the rack <p>Air source for servers</p> <ul style="list-style-type: none"> • Room air for front of rack. Air exhausts servers, moves through rear door heat exchanger and exits into the room (open loop) <p>Air temperature drop</p> <ul style="list-style-type: none"> • The temperature drop can be up to 25°C (45°F) between the air exiting the rack devices and the air exiting the heat exchanger on high heat load products. <p>Air impedance</p> <ul style="list-style-type: none"> • Air pressure drop across the heat exchanger is equivalent to the IBM acoustic 19-inch rear door 	<p>Water source</p> <ul style="list-style-type: none"> • User-supplied, compliant with specifications in this topic. <p>Water pressure</p> <ul style="list-style-type: none"> • Normal operation: 137.93 kPa (20 psi) • Maximum: 689.66 kPa (100 psi) • Pressure drop across heat exchanger: approximately 48 kPa (7 psi) <p>Water volume</p> <ul style="list-style-type: none"> • Exchanger: 2.8 liters (0.75 gallons) • Exchanger plus supply and return hoses to the pump unit: Maximum of approximately 15.1 liters (4.0 gallons) excluding pump unit piping and reservoir <p>Water temperature</p> <ul style="list-style-type: none"> • If no dew point control is available from the secondary loop cooling distribution unit, 18°C +/- 1 degree C (64.4°F +/- 1.8°F) must be maintained. • Lower temperature water is allowed as long as the water supply is monitored and adjusted to remain above room dew point (where heat exchanger is located). <p>Required water flow rate (as measured at the supply entrance to the heat exchanger)</p> <ul style="list-style-type: none"> • Minimum: 22.7 liters per minute (6 gallons per minute) • Maximum: 37.9 liters per minute (10 gallons per minute)

Heat exchanger option kit

The heat exchanger feature kit consists of the components listed below and shown in the following figures.

- Door assembly
- Hinge kit
- Air-purge tool

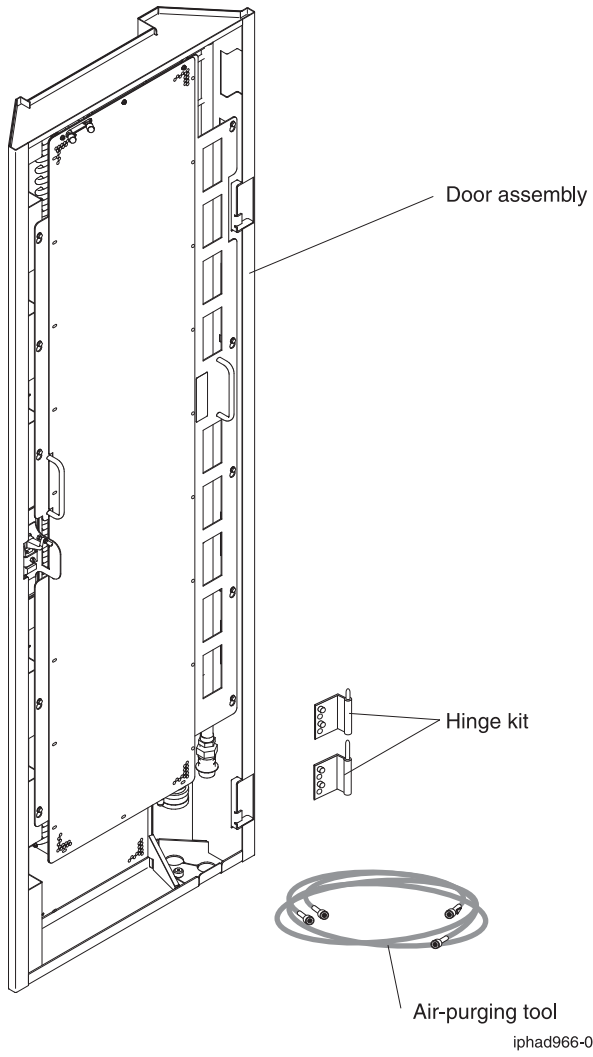
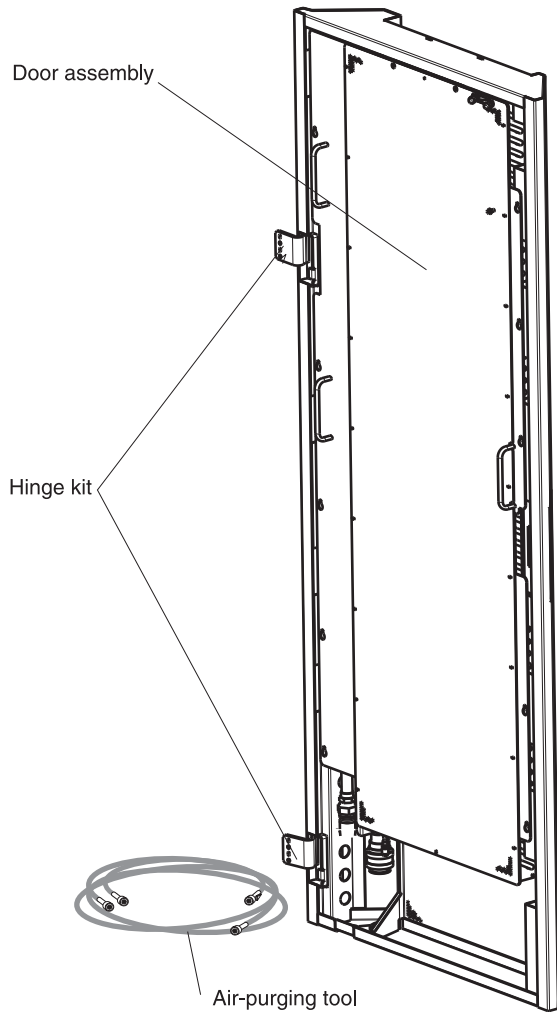

Figure 12. Components of the heat exchanger kit for 19-inch EIA-rail racks



iphad984-0

Figure 13. Components of the heat exchanger kit for 24-inch EIA-rail racks

Related concepts:

“Heat exchanger performance”

Learn about the heat exchanger performance of the rear door heat exchanger.

Heat exchanger performance

Learn about the heat exchanger performance of the rear door heat exchanger.

An example of expected performance of the rear door heat exchanger is illustrated in Typical performance of a rear door heat exchanger, 32 kW heat load load for a typical inlet air temperature of 24°C (75.2°F), with a fully populated rack near uniform power dissipation, 32 kW heat load, and the node fans running near nominal fan speed (1530 cfm). By selecting the water inlet temperature and water flow rate, you can estimate the indicated heat removal. These levels can be achieved with normal cable exits from the rack and with the small amount of hot air bypass at the base of the door (small amounts of hot air escaping from the rack without being cooled by the door).

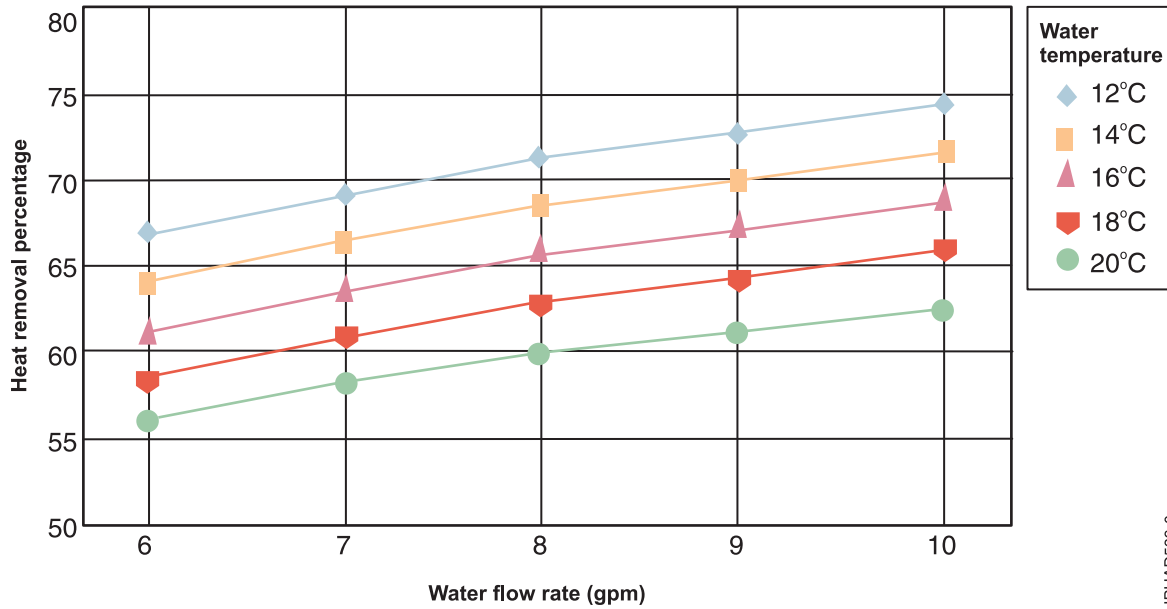

IPHAD589-0

Figure 14. Typical performance of a rear door heat exchanger, 32 kW heat load. Percentage heat removal as function of water temperature and flow rate. (24°C rack inlet air, 32 kW rack load, 1530 cfm air through the rear door heat exchanger)

As described in *Heat exchanger specifications*, water temperatures below 18°C (64.4°F) can be used only if the system that is supplying the water is able to measure the room dew point conditions, and automatically adjust the water temperature accordingly.

Another example of performance data is shown in Typical performance of a rear door heat exchanger, 20 kW heat load for identical conditions as in Typical performance of a rear door heat exchanger, 32 kW heat load, except reflecting a 20 kW heat load. Because of the lower heat load, a specific level of cooling can be achieved with warmer water, a lower flow rate, or both.

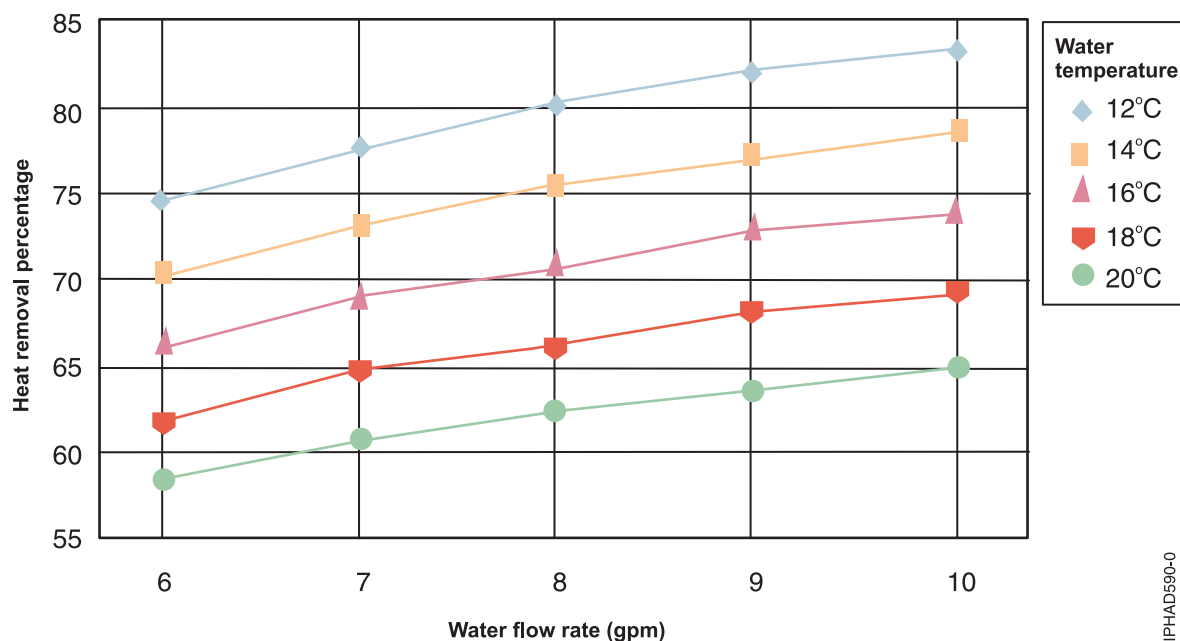

Figure 15. Typical performance of a rear door heat exchanger, 20 kW heat load. Percentage heat removal as function of water temperature and flow rate. (24°C rack inlet air, 20 kW rack load, 1530 cfm air through the rear door heat exchanger)

Water specifications for the secondary cooling loop

Learn about the water specifications required for the secondary cooling loop of your heat exchanger.

It is important that the water being supplied to the heat exchanger meet the requirements described in this topic; otherwise, system failures might occur over time, as a result of:

- Leaks due to corrosion and pitting of the metal components of the heat exchanger or the water supply system
- Buildup of scale deposits inside the heat exchanger, which can cause the following problems:
 - A reduction of the heat exchanger's ability to cool the air that is exhausted from the rack.
 - Failure of mechanical hardware, such as a hose quick-connect adapter.
- Organic contamination, such as bacteria, fungi, or algae. This contamination can cause the same problems as described for scale deposits.

Water control and conditioning for the secondary cooling loop

The water used to fill, refill, and supply the heat exchanger must be particle-free deionized water or particle-free distilled water with appropriate controls for avoiding the following issues.

- Metal corrosion
- Bacterial fouling
- Scaling

Because of typical water temperatures (described in *Water delivery specifications for secondary loops*), the water may not be able to originate from the primary building chilled-water system. Conditioned water for the heat exchanger should be supplied as part of a secondary, closed-loop system.

Important: Use of glycol solutions is not recommended because they can adversely affect the cooling performance of the heat exchanger.

Materials for secondary loops

This topic describes the materials for use in supply lines, connectors, manifolds, pumps, hoses, and any other hardware that makes up the closed-loop water-supply system at your location.

- Copper
- Brass with less than 30 percent zinc content
- Stainless steel – 303, 304, or 316
- Ethylene Propylene Diene Monomer (EPDM) rubber – peroxide cured, non-metal oxide

Materials to avoid in secondary loops

Do not use any of the following materials in any part of your water supply system.

- Oxidizing biocides, such as, chlorine, bromine, and chlorine dioxide
- Aluminum
- Brass with greater than 30 percent zinc
- Irons (non-stainless steel)

Water supply requirements for secondary loops

This topic describes specific characteristics of the system that supplies the chilled conditioned water to the heat exchanger.

Temperature

The heat exchanger, its supply hose and return hoses are not insulated and do not have features designed to address the creation and collection water from condensate. Avoid any condition that could cause condensation. The temperature of the water inside the supply hose, return hose, and the heat exchanger must be kept above the dew point of the location where the heat exchanger is being used.

Attention: Typical primary chilled water is too cold for use in this application because building chilled water can be as cold as 4°C - 6°C (39°F to 43°F).

Important: If the system supplying the cooling water does not have the ability to measure the room dew point and automatically adjust the water temperature accordingly, the minimum water temperature that must be maintained is 18°C plus or minus 1°C (64.4°F plus or minus 1.8°F). This is consistent with the ASHRAE Class 1 Environmental Specification that requires a maximum dew point of 17°C (62.6°F). Refer to the ASHRAE document entitled *Thermal Guidelines for Data Processing Environments*. Information on obtaining this document is found at the *ASHRAE Technical Committee* website. Search on document id ASHRAE TC 9.9.

Pressure

The water pressure in the secondary loop must be less than the maximum 689.66 kPa (100 pounds per square inch). Somewhere in the water circuit, a pressure relief valve, set to this maximum value, is required for safety reasons. Normal operating pressure at the rear door heat exchanger should be 137.93 kPa (20 psi) or less.

Flow rate

The flow rate of the water in the system must be in the range of 23 - 38 liters per minute (6 - 10 gallons per minute).

Pressure drop versus flow rate for heat exchangers (including quick-connect couplings) is defined as approximately 48 kPa (7 psi) at 30 liters per minute (8 gallons per minute). Adjustable flow valves are recommended for installation on all supply lines of the water circuit, to enable compliance, to this flow specification.

Water volume limits

The heat exchangers hold between 2.8 liters (0.75 gallons) and 5.3 liters (1.4 gallons). Fifteen meters (50 ft) of 19 mm (0.75 in.) supply and return hoses hold approximately 9.4 liters (2.5 gallons). To minimize exposure to flooding in the event of leaks, the entire product cooling system (heat exchanger, supply hose and return hose) excluding any reservoir tank should have a maximum 15.1 liters (4 gallons) of water. This is a cautionary statement not a functional requirement. Also consider using leak detection methods on the secondary loop that supplies water to the heat exchanger.

Air exposure

The secondary cooling loop is a closed loop, with no continuous exposure to room air. After you fill the loop, remove all air from the loop. Air bleed valves are provided at the top of each heat exchanger manifold for purging all air from the system.

Related concepts:

“Water delivery specifications for secondary loops”

The delivery system secondary loop provides chilled water to the heat exchanger. The secondary loop consists of the components listed.

Related information:

 ASHRAE Technical Committee
ASHRAE guidelines are available in this website

Water delivery specifications for secondary loops

The delivery system secondary loop provides chilled water to the heat exchanger. The secondary loop consists of the components listed.

This topic describes the various hardware components that make up the delivery system secondary loop that provides the chilled, conditioned water to the heat exchanger. The delivery system includes pipes, hoses and the required connection hardware to attach to the heat exchanger. Hose management on raised or non-raised floor environments is also described.

Attention: The overpressure safety device must meet the following requirements:

- Comply with ISO 4126-1

Note: Perform a search for ISO 4126-1.

- Be installed so that it is easily accessed for inspection, maintenance, and repair.
- Be connected as close as possible to the device that it is intended to protect.
- Be adjustable only with the use of a tool.
- Have a discharge opening that is directed so that discharged water or fluid will not create a hazard or be directed toward any person.
- Have an adequate discharge capacity to ensure that the maximum working pressure is not exceeded.
- Be installed without a shutoff valve between the overpressure safety device and the protected device.

The primary cooling loop is considered to be the low temperature building chilled-water supply or a modular chiller unit. The primary loop must not be used as a direct source of coolant for the heat exchanger for two main reasons. First, below-dew-point water will cause air moisture to form on the door heat exchanger as it operates (condensation will drip and gather under the rack). Second, if proper leak

detection is not established (for example, monitored leak tape, hose-in-trough with leak sensors and automatic shut-off valves) and a leak in the door, hoses or manifolds occurs, the constant, large supply of primary loop water could result in large amounts of water leaking into the data center. Water provided in a controlled and monitored secondary, closed loop, would limit the amount of water available in a leak situation, and prevent condensation from forming.

Procurement and the installation of the components needed to create the secondary cooling loop system are required for this design and are your responsibility. For suggestions on where to procure hoses and cooling distribution units, see *Flexible hose suppliers* and *Cooling distribution unit suppliers*. The main purpose of this topic is to provide examples of typical methods for secondary loop set-up and operating characteristics that are needed to provide an adequate, safe supply of water to the heat exchanger. Key components recommended for the water supply and return lines are:

- Couplings to match those provided on the heat exchanger
- Flexible hoses
- Thermal feedback to a flow valve that will adjust and control supply water temperature
- Pressure relief valve
- Shutoff valves for each line running to a door
- Adjustable flow valves for each supply line to a door

The actual number of heat exchangers connected to a secondary loop depends on the capacity of the secondary loop to transfer heat to the primary loop. For example, if the secondary loop can remove 100 kW of heat load and you have multiple 25 kW racks, you could have 12.5 kW per rack (assuming 50 percent door heat removal) going into the water loop, and attach eight doors per secondary loop.

The following figure shows an example of a facility water delivery system. The actual number of heat exchangers connected to a secondary loop depends on the capacity of the cooling distribution unit that is running the secondary loop.

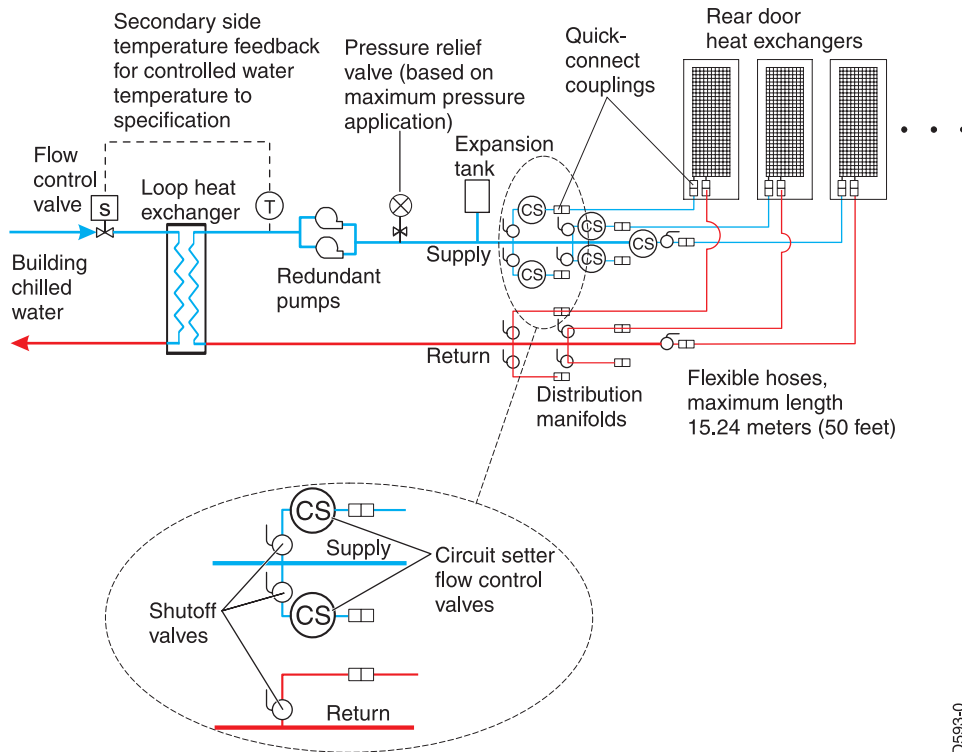

IPHAD593-0

Figure 16. Coolant distribution using a facility water delivery system

The following figure shows an example of an off-the-shelf modular cooling distribution unit. The actual number of heat exchangers connected to a secondary loop depends on the capacity of the cooling distribution unit that is running the secondary loop.

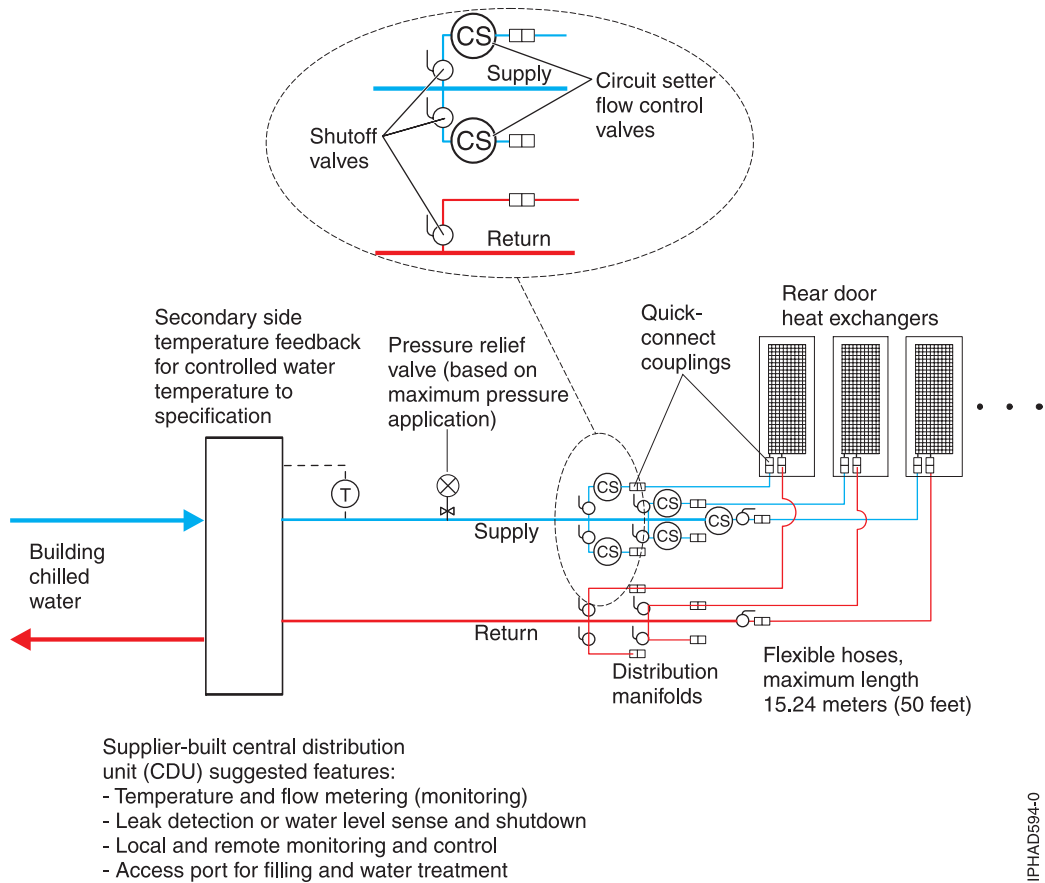
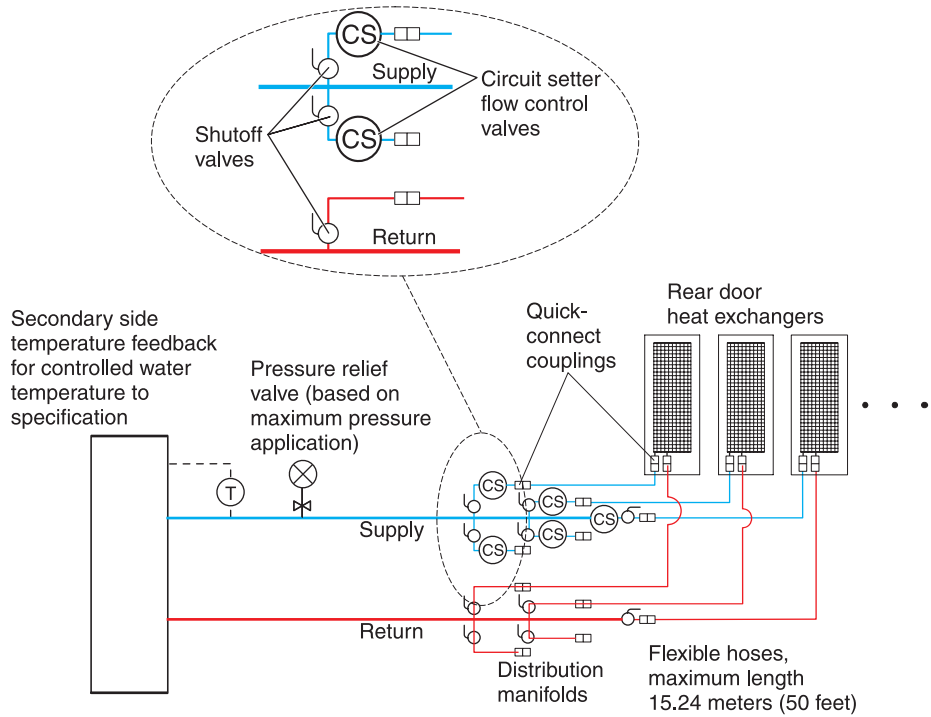

Figure 17. Coolant distribution using off-the-shelf supplier solutions

The following figure shows an example of a water chiller unit that supplies conditioned water to one or more heat exchangers. This must be a closed system (no exposure of the water to air) and meet all materials, water quality, water treatment, and temperature and flow specifications that are defined in this document. A water chiller unit is considered an acceptable alternative to use as a building chilled water source for removing heat from a rear door heat exchanger.



- Supplier-built water chiller unit required features:
- Temperature and flow metering (monitoring)
 - Leak detection or water level sense and shutdown
 - Local and remote monitoring and control
 - Access port for filling and water treatment

IPHAD591-0

Figure 18. Cooling distribution unit that uses a water chiller unit to provide conditioned water

The following figure shows a typical cooling solution and defines the components of the primary cooling loop and the components of the secondary cooling loop.

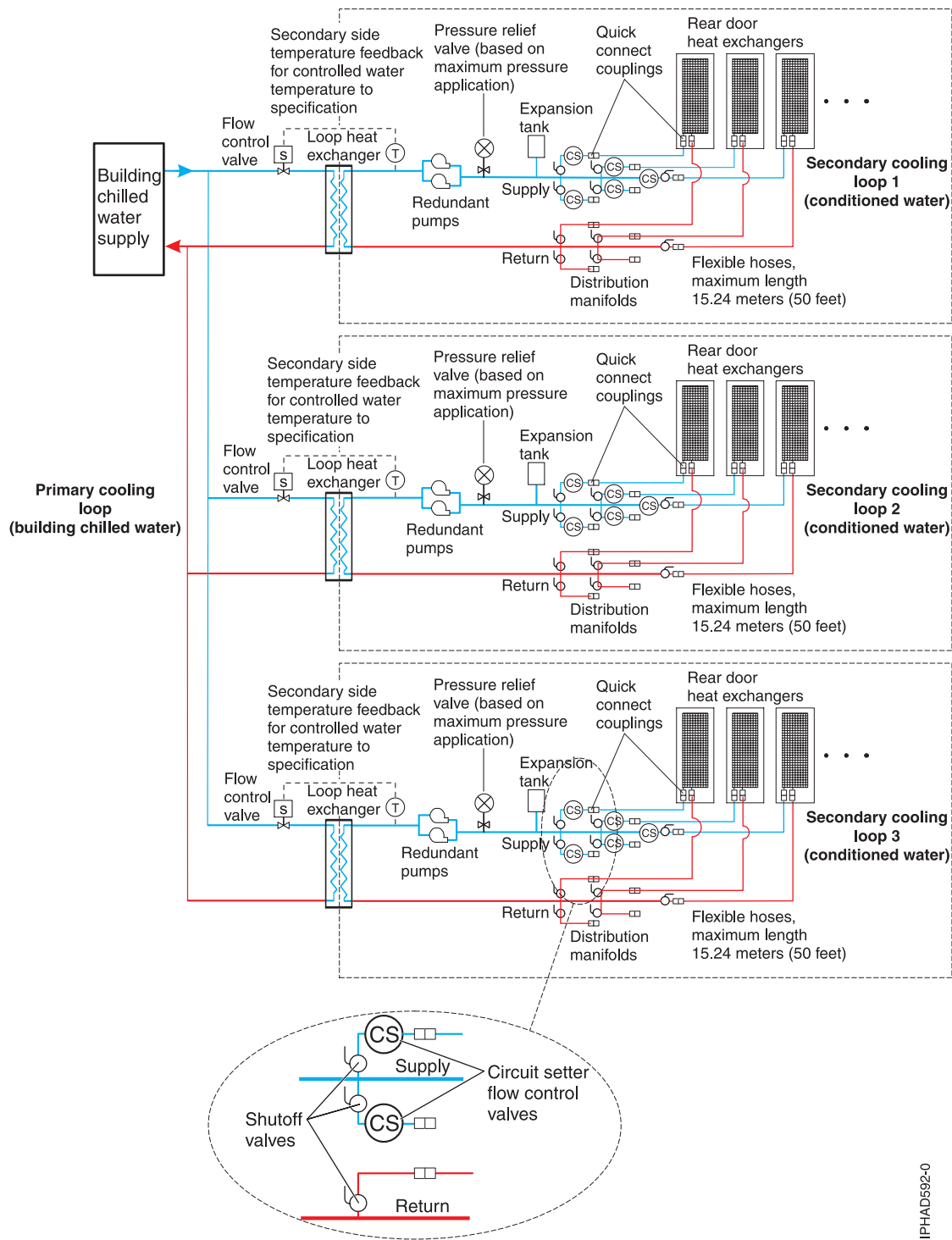

IPHAD592-0

Figure 19. Primary and secondary cooling loops

Manifolds and piping

Manifolds that accept large-diameter feed pipes from a pump unit are the preferred method for splitting the flow of water to smaller diameter pipes or hoses that are routed to individual heat exchangers. Manifolds must be constructed of materials compatible with the pump unit and related piping. See *Water*

specifications for the secondary cooling loop. The manifolds must provide enough connection points to allow a matching number of supply and return lines to be attached and the manifolds must match the capacity rating of the pumps and heat exchanger (between the secondary cooling loop and building chilled-water source). Anchor or restrain all manifolds to provide the required support to avoid movement when quick-connect couplings are plugged to the manifolds and when valves are opened or closed.

Example manifold supply pipe sizes

- Use a 50.8 mm (2 in.) supply pipe to provide the correct flow to six (100 kW CDU) 19 mm (0.75 in.) supply hoses.
- Use a 63.5 mm (2.50 in.) supply pipe to provide the correct flow to eight (120 kW CDU) 19 mm (0.75 in.) supply hoses.
- Use an 88.9 mm (3.50 in.) supply pipe to provide the correct flow to twenty (300 kW CDU) 19 mm (0.75 in.) supply hoses.

Shutoff valves are suggested for each supply and return line that exits the manifold to allow stopping the flow of water in individual lines of multiple circuit loops. This provides a way of servicing or replacing an individual heat exchanger without affecting the operation of other heat exchangers in the loop.

Adjustable flow valves (called circuit setters) are also suggested for each supply line that exits a supply manifold so changes can be made to the flow to each individual rack, in the event that door heat exchangers are added or removed from the secondary loop (this method keeps water flow within specification to each door heat exchanger).

Temperature and flow metering (monitoring) are suggested in secondary loops, to provide assurance that water specifications are being met and that the optimum heat removal is taking place.

Anchor or restrain all manifolds and pipes to provide the required support, and to avoid movement when quick-connect couplings are being attached to the manifolds.

The following figure shows an example of a typical central manifold layout that supplies water to multiple heat exchangers.

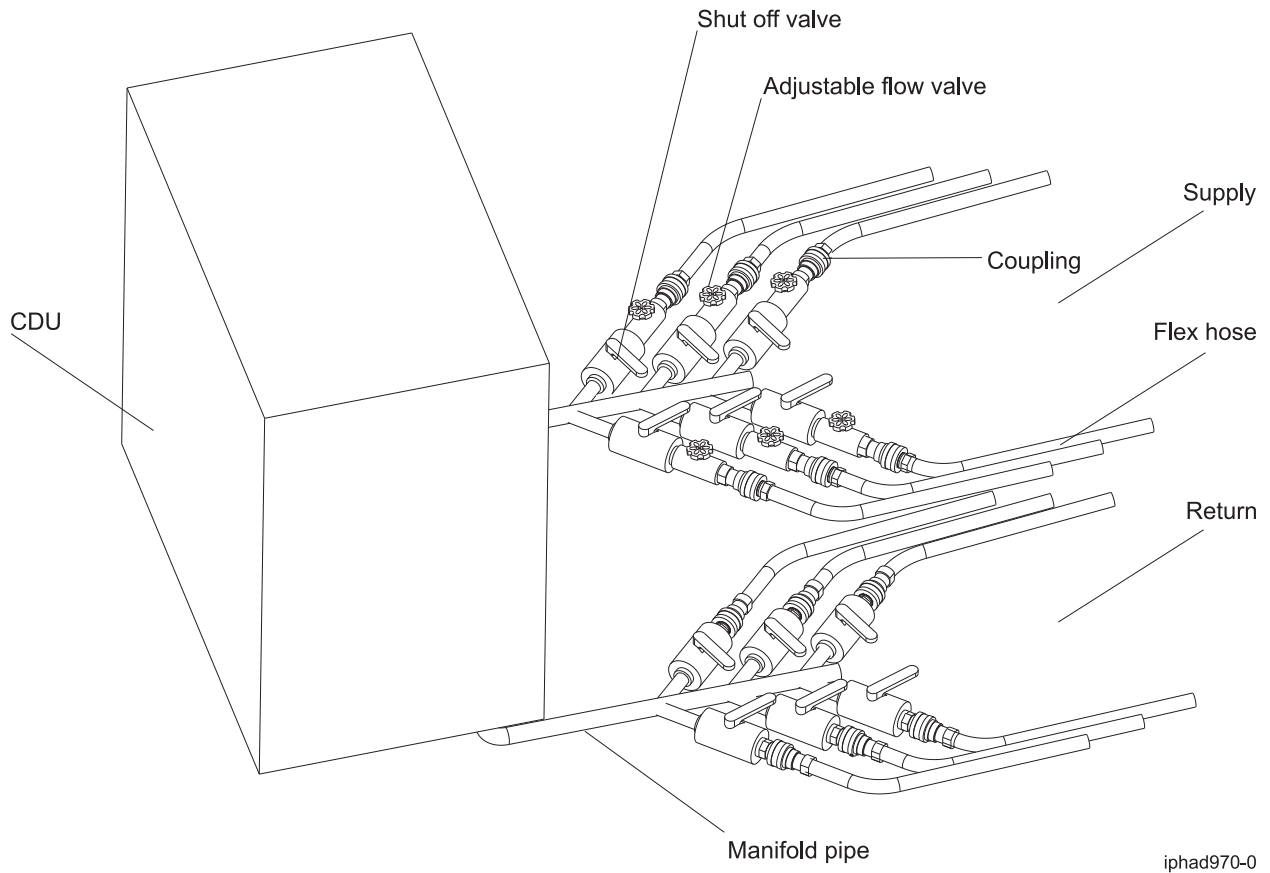

iphad970-0

Figure 20. Typical central distribution manifold layout in a central location

The following figure shows another layout for multiple water circuits.

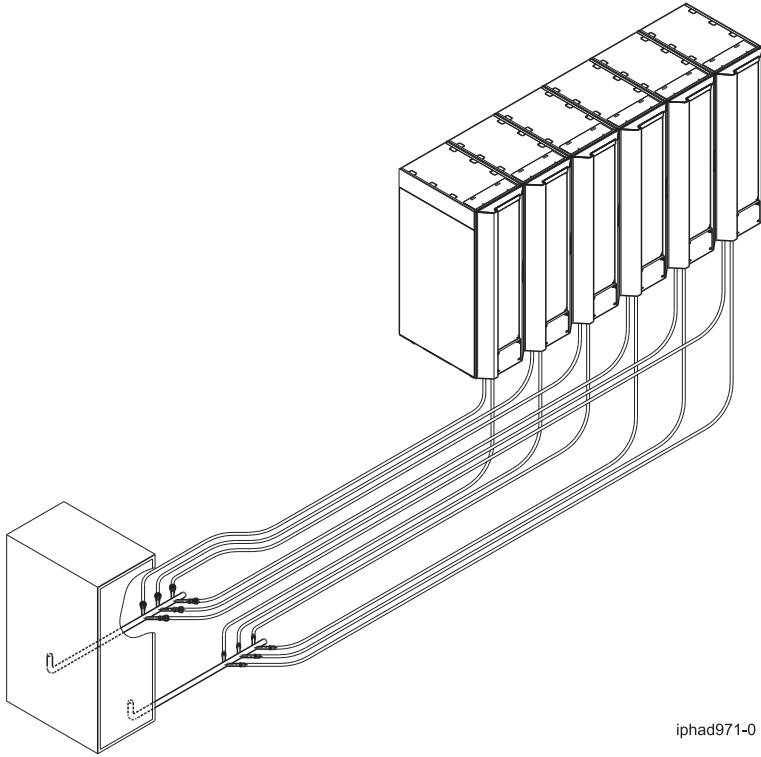

iphad971-0

Figure 21. Typical central manifold (located at a central location for multiple water circuits)

The following figure shows an extended manifold layout.

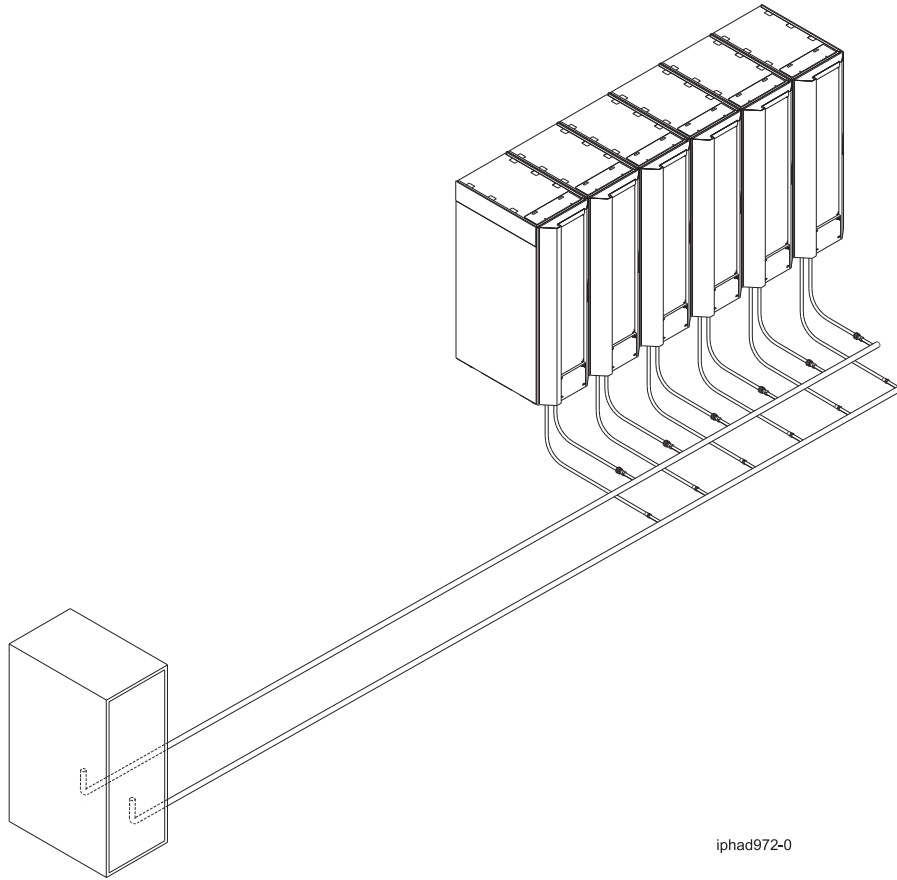

iphad972-0

Figure 22. Typical extended manifold (located along aisles between racks)

Flexible hoses and connections to manifolds and heat exchangers

Pipes and hose configurations can vary and are determined by analyzing the needs of your facilities, or a site preparation representative can provide this analysis.

Flexible hoses are needed to supply and return water between your hard plumbing (manifolds and cooling distribution units) and the heat exchanger, (allowing needed movement when opening and closing the rack rear door).

Hoses are available that provide water with acceptable pressure-drop characteristics and that help prevent depletion of some corrosion inhibitors. These hoses must be made of Ethylene Propylene Diene Monomer (EPDM) rubber - peroxide cured, non-metal oxide material and will have Parker Fluid quick-connect couplings at each end. These couplings are defined below and are compatible with the heat exchanger couplings. Hose lengths from 3 - 15 m (10 - 50 ft), in increments of 3 m (10 ft) are available. Hoses longer than 15 m (50 ft) may create unacceptable pressure loss in the secondary circuit and reduce the water flow, and thus reduce the heat removal capabilities of the heat exchanger.

For a suggested supplier of these hoses, see the table in *Miscellaneous parts supplier*. Use solid piping or tubing that has a minimum inner diameter of 19 mm (0.75 in.) and the least number of joints possible between a manifold and a heat exchanger in each secondary loop.

Quick-connect couplings are used to attach the hoses or fixed pipes to the distribution manifolds and the rear door heat exchangers. Hose couplings that attach to the heat exchanger must have the following characteristics.

- The couplings should be constructed of passivated 300-L series stainless steel or brass couplings with less than 30 percent zinc content. The coupling size is 19 mm (0.75 in.).
- The supply hose must have a Parker (male) quick-coupling nipple part number SH6-63-W, or equivalent. The return hose must have a Parker (female) quick-connect couplings part number SH6-62-W, or equivalent.
- At the opposite (manifold) end of the hoses, it is suggested that similar quick-connect couplings be used. However, if other types are desired, it is also suggested that positive locking mechanisms be used to prevent loss of water when the hoses are disconnected. The connections must minimize water spill and air inclusion into the system when they are disconnected.

Note: When creating supply and return loops, it is recommended to avoid placement of electrical connections directly below water connections. These would be areas prone to water drips or splash when working with the water loop. Water dripping or splashing onto electrical connections can cause electrical problems or an unsafe environment.

Related concepts:

“Water specifications for the secondary cooling loop” on page 39

Learn about the water specifications required for the secondary cooling loop of your heat exchanger.

Related reference:

“Cooling distribution unit suppliers” on page 63

This topic provides a list of possible suppliers for cooling distribution units.

“Miscellaneous parts supplier” on page 62

Supplier and contact information for miscellaneous secondary loop parts is provided.

Layout and mechanical installation

The layout and mechanical installation of your heat exchanger is dependent upon several factors. Use this information to plan for your specific configuration.

The following provide an overview of the installation steps. It also provides examples of typical layouts for water circuits.

Heat exchanger installation overview

These are the major tasks for installing the heat exchanger.

1. Preparing your facility to provide water to the rack per the required specifications.
2. Removing the existing rack rear door, and installing new hinge assemblies, and installing new latch plate.
3. Attaching the heat exchanger door assembly to the rack.
4. Routing flexible hoses, leaving enough length at the rack end to easily make connections to the heat exchanger.
5. Connecting the water-supply and water-return hose that runs from the cooling distribution unit or distribution manifold to the heat exchanger.
6. Filling the heat exchanger with water.
7. Adjusting and inspecting the hoses to ensure there are no kinks in the hoses and that the hoses are not lying against any sharp edges.
8. Adjusting the door latch assembly to ensure the door fits flatly to the rack and that all gaskets seal to the rack.

Note: For safety reasons, trained service personnel (or qualified professionals) must perform the installation of the heat exchanger.

Heat exchanger filling and draining overview

Follow these steps to ensure that your heat exchanger is drained and filled properly.

1. Filling a heat exchanger with water includes using the air purge tool supplied with the heat exchanger to purge any air from the heat exchanger manifolds.

Note: Attachment and detachment of air purge tool should be done with the tool valve open to reduce water pressure at the air bleed valves and reduce water that might escape at the valves during attaching or detaching.

Containers must be available for capturing water. The container must hold a minimum of 2 L (0.5 gal) capacity for purging air and a minimum 6 L (1.6 gal) capacity for draining a heat exchanger.

2. Draining a heat exchanger is required before the door containing the heat exchanger can be removed from the rack, or before a rack with a heat exchanger installed can be moved. The air purge tool can be connected to the drain port on the bottom of the heat exchanger to drain the water.
3. Use absorbent materials, such as cloth, under the work area to capture any water that might spill when filling or draining a heat exchanger.

Planning for heat exchangers in a raised floor environment

Plan for your heat exchangers in a raised floor environment.

On a raised floor, hoses are routed under the floor tiles and are brought up from beneath the rack through special tile cut outs. The hoses attach to the quick-connect couplings on the bottom of the heat exchanger.

Note: In the following examples, figures show optimal placement and size of openings for hose exit. In some products, IBM installation planning documents recommend other hole locations (for example, heavy racks may not have openings allowed in tiles that casters are resting on). Specific product requirements should be followed over those provided in this topic. Recommendations for openings in reinforced pedestal or stringer type tiles versus non-reinforced pedestal tiles should also be followed. Existing tile cutouts for electrical or other cables can be used (or expanded) for the hoses, if enough opening space is available to allow easy movement of both hoses when the door is opened and closed. In general, hoses should exit the tiles at locations that will not put high forces on the hoses, or cause rubbing that will abrade the hose surface and lead to premature hose failure (leaks).

Raised floor hose requirements and management

In a typical example, each heat exchanger requires a special cut 0.6 m by 0.6 m (2 ft by 2 ft) floor tile below it and in front of the rack. A portion of the tile is cut away and correctly covered to protect against sharp edges. The corner opening is placed directly under the hinge side of the rack rear door. The opening size of the cut is 152.4 mm wide and 190.5 mm long +/- 12.7 mm (6.0 in. wide and 7.5 in. long +/- 0.5 in.) in the direction parallel to the door. The following figures provide examples of hose management methods.

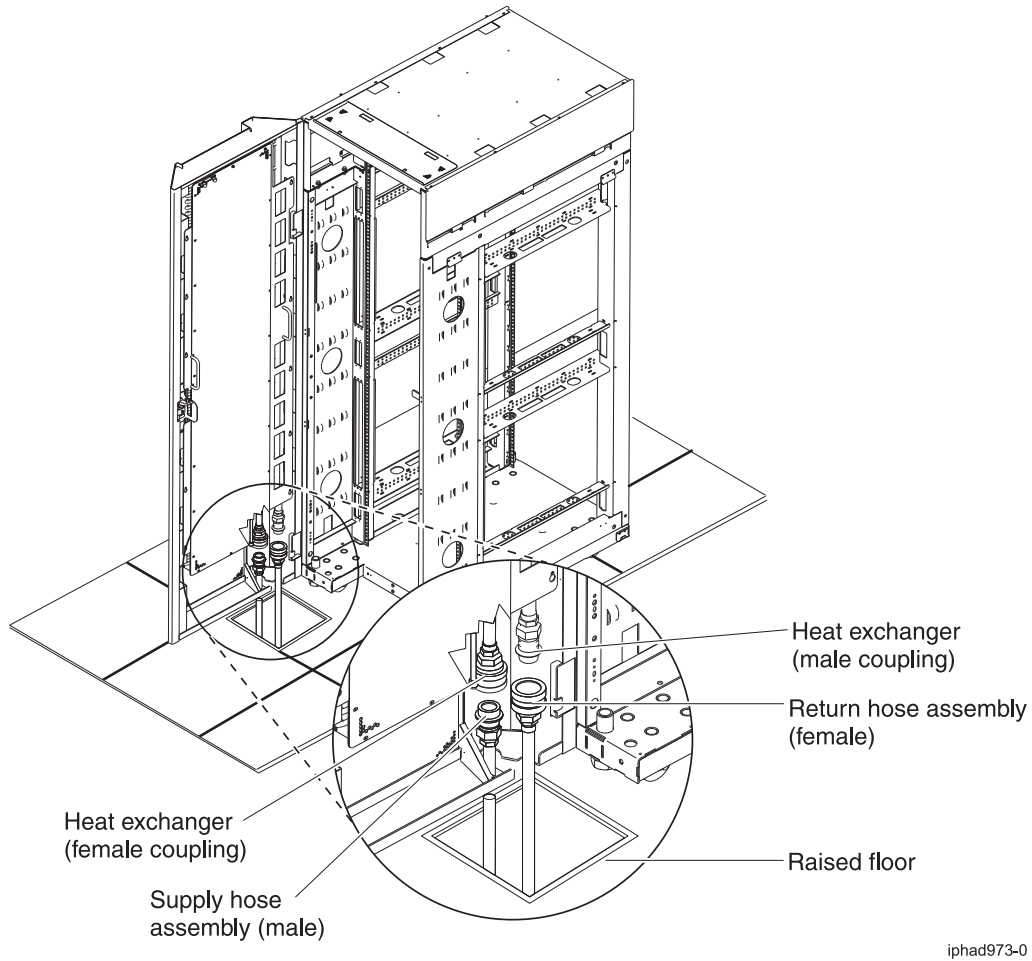

Figure 23. Raised floor hose management example 1; tile cut out size and position for 19-inch EIA-rail racks

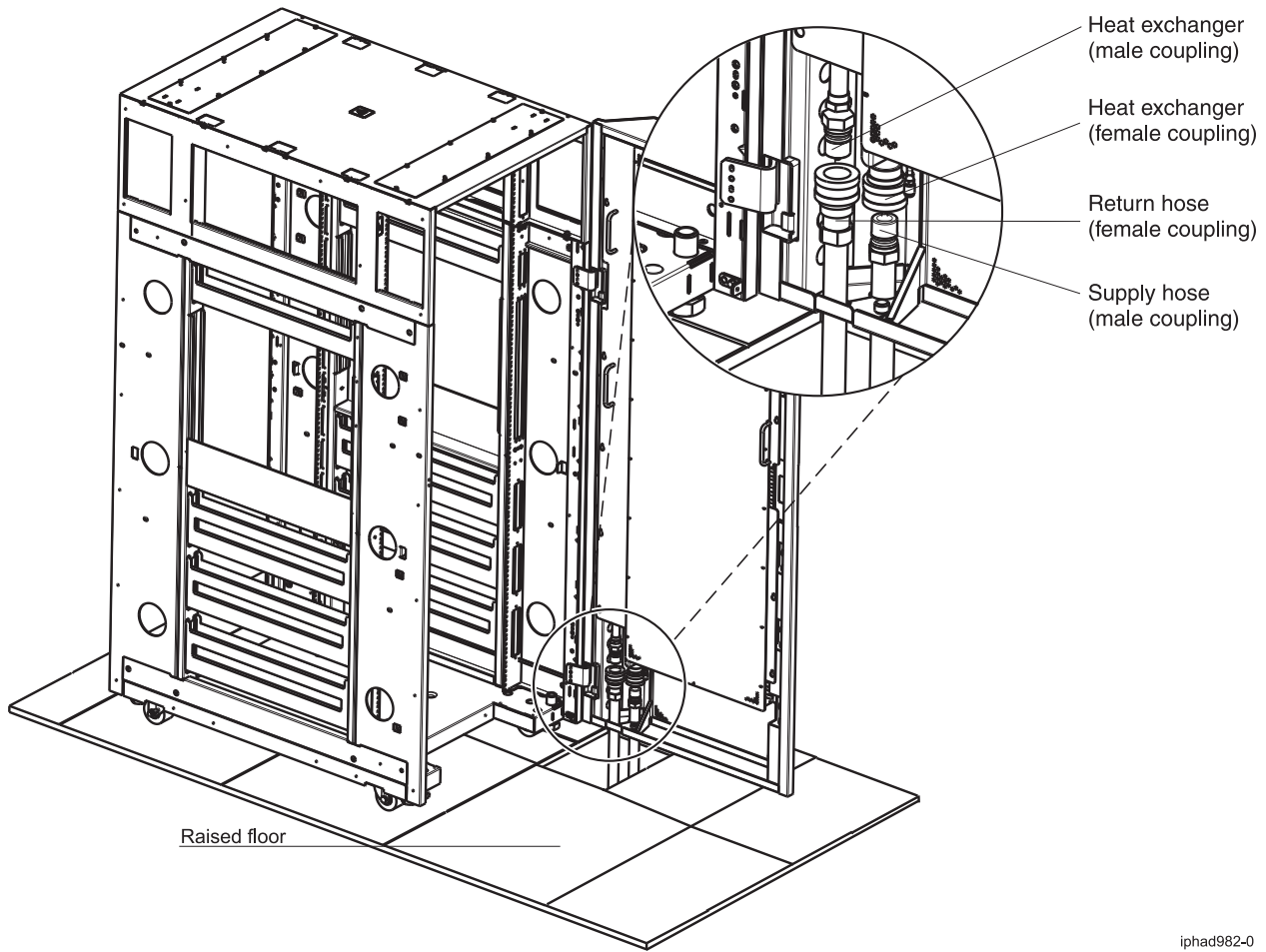

Figure 24. Raised floor hose management example 1; tile cut out size and position for 24-inch EIA-rail racks

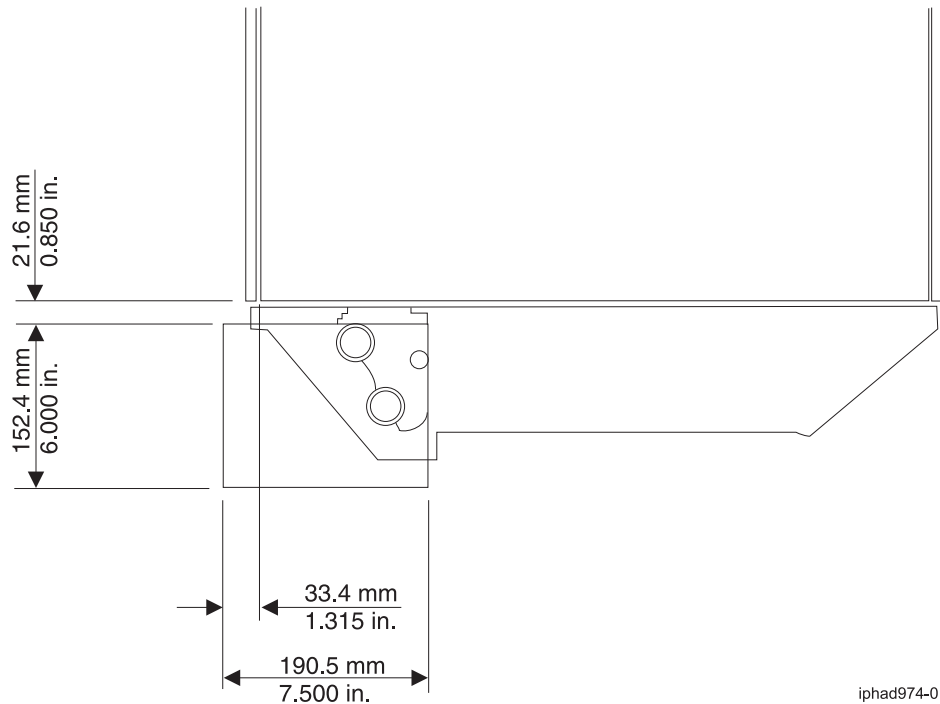

Figure 25. Raised floor hose management example 1; tile cut out definition and location for 19-inch EIA-rail racks

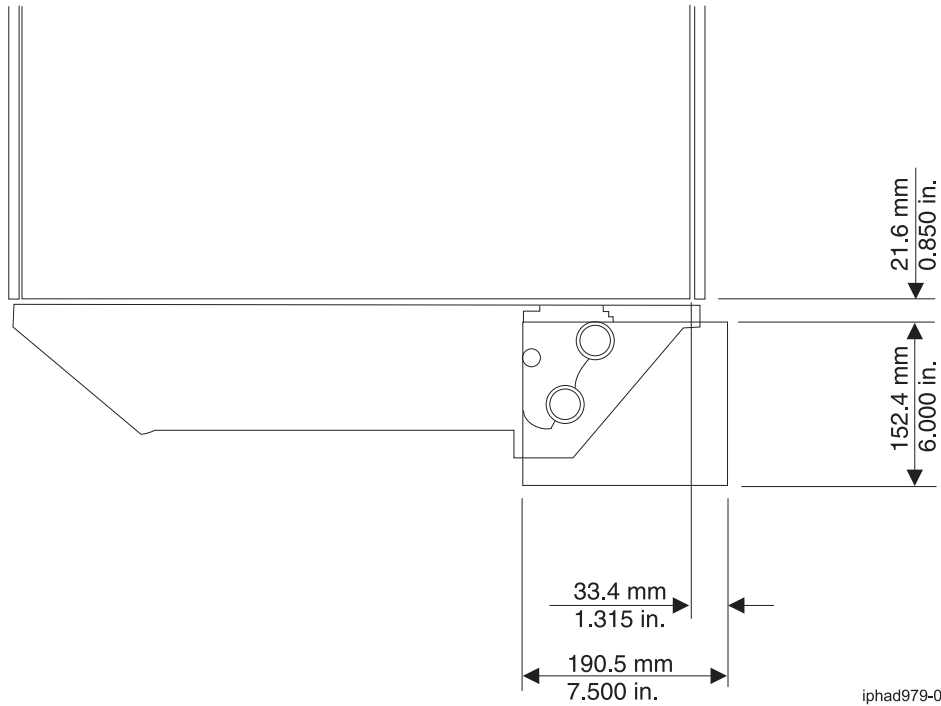
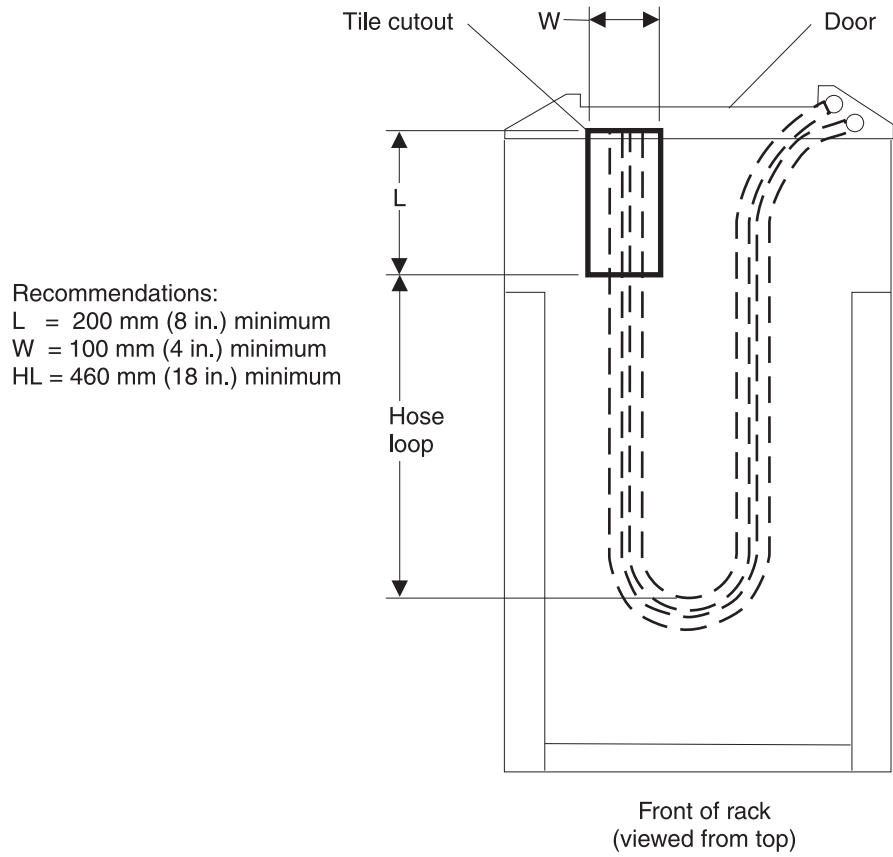

Figure 26. Raised floor hose management example 1; tile cut out definition and location for 24-inch EIA-rail racks

In another example, for racks being installed at the same time a heat exchanger is being installed, and in cases where installation planning allows floor tile cutouts under the rack, each heat exchanger still requires a special cut 0.6 m by 0.6 m (2 ft by 2 ft) floor tile. However, the floor tile will be positioned

completely within the footprint of the rack. A modified cable opening or independent hose cut out is used. Flexible hoses that contain a right-angle elbow are used to route the hoses under the rack in a large loop to allow hose movement when the door is opened and closed. The following figures show how to route hoses under the rack with enough hose length to allow the hose to move freely as the door is opened and closed.



Recommendations:
 L = 200 mm (8 in.) minimum
 W = 100 mm (4 in.) minimum
 HL = 460 mm (18 in.) minimum

iphad975-0

Figure 27. Raised floor and non-raised floor hose management example 2; loop under the 19-inch EIA-rail rack with door closed

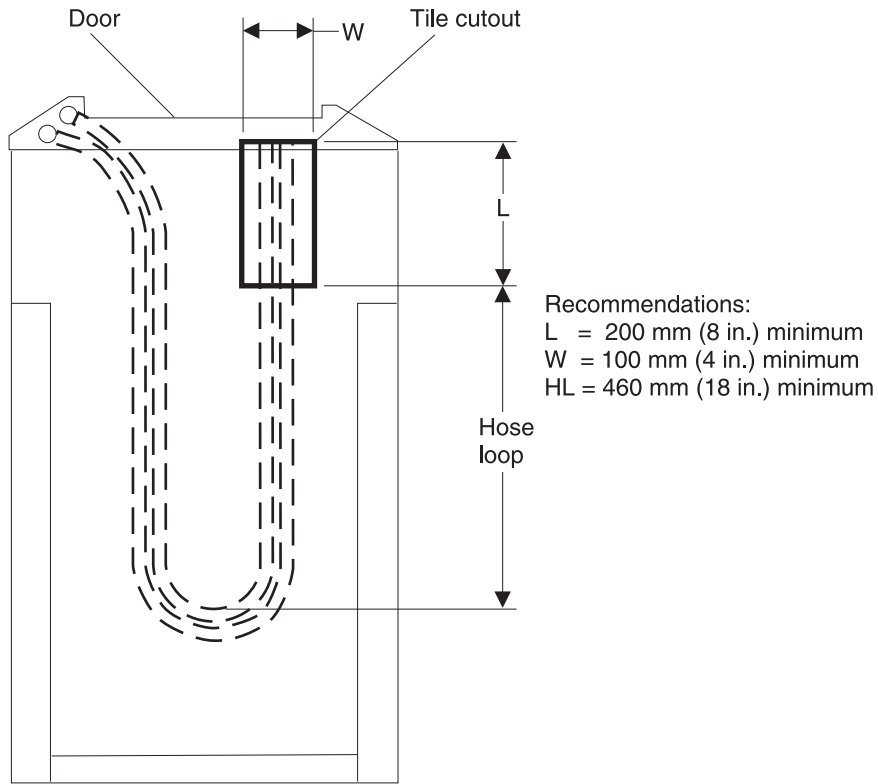

Front of 24 inch EIA-rail rack
(viewed from top)

iphad980-0

Figure 28. Raised floor and non-raised floor hose management example 2; loop under the 24-inch EIA-rail rack with door closed

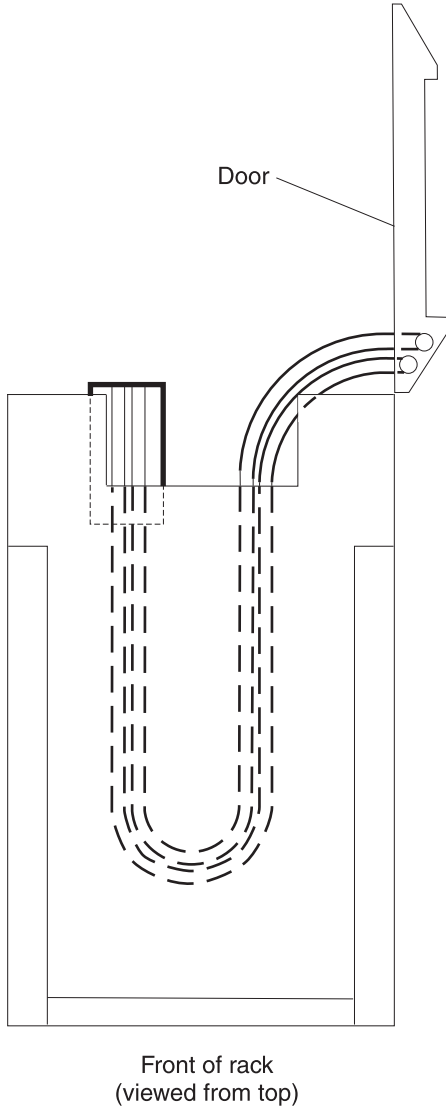

iphad976-0

Figure 29. Raised floor and non-raised floor hose management example 2; loop under the 19-inch EIA-rail rack with door open

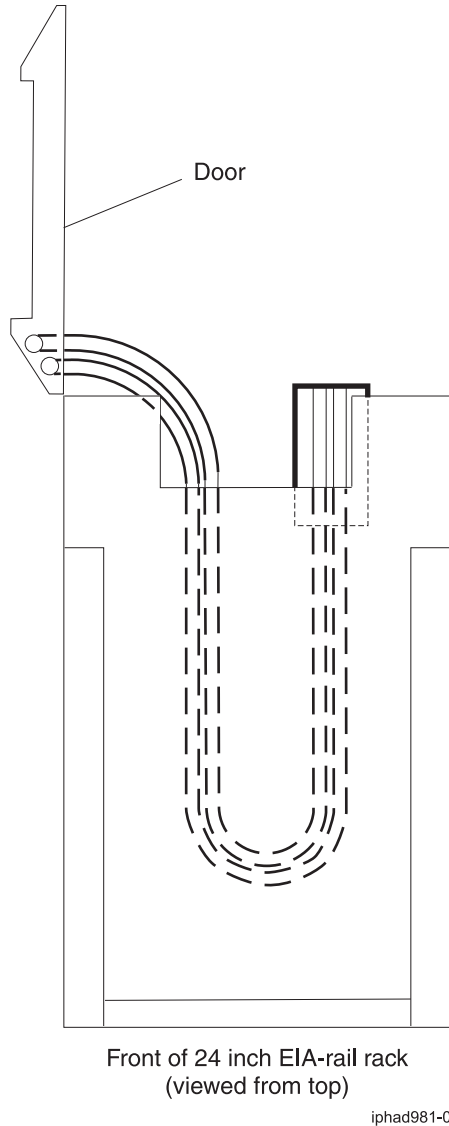

Figure 30. Raised floor and non-raised floor hose management example 2; loop under the 24-inch EIA-rail rack with door open

Lay hoses side-by-side as they run between the heat exchanger and the supply and return manifolds, and allow the hoses to freely move. Leave enough slack in the hoses below the rear door so that minimum forces are exerted on the door when the hoses are attached and operating. When routing hoses, avoid sharp bends that cause hose kinks, and avoid hose contact with sharp edges.

Planning for heat exchangers in a non-raised floor environment

Plan for your heat exchangers in a non-raised floor environment.

Non-raised floor hose requirements and management

In data centers without a raised floor, straight hose assemblies cannot make the sharp bend to exit between the floor and the rack door without kinking the hose.

Hose assemblies with right-angle metal elbows are needed. This allows the hoses to be routed along the floor, make the 90 degree turn upwards within the gap between the bottom of the heat exchanger door and the floor surface, and then connect to the heat exchanger couplings. This is shown in the following

figures.

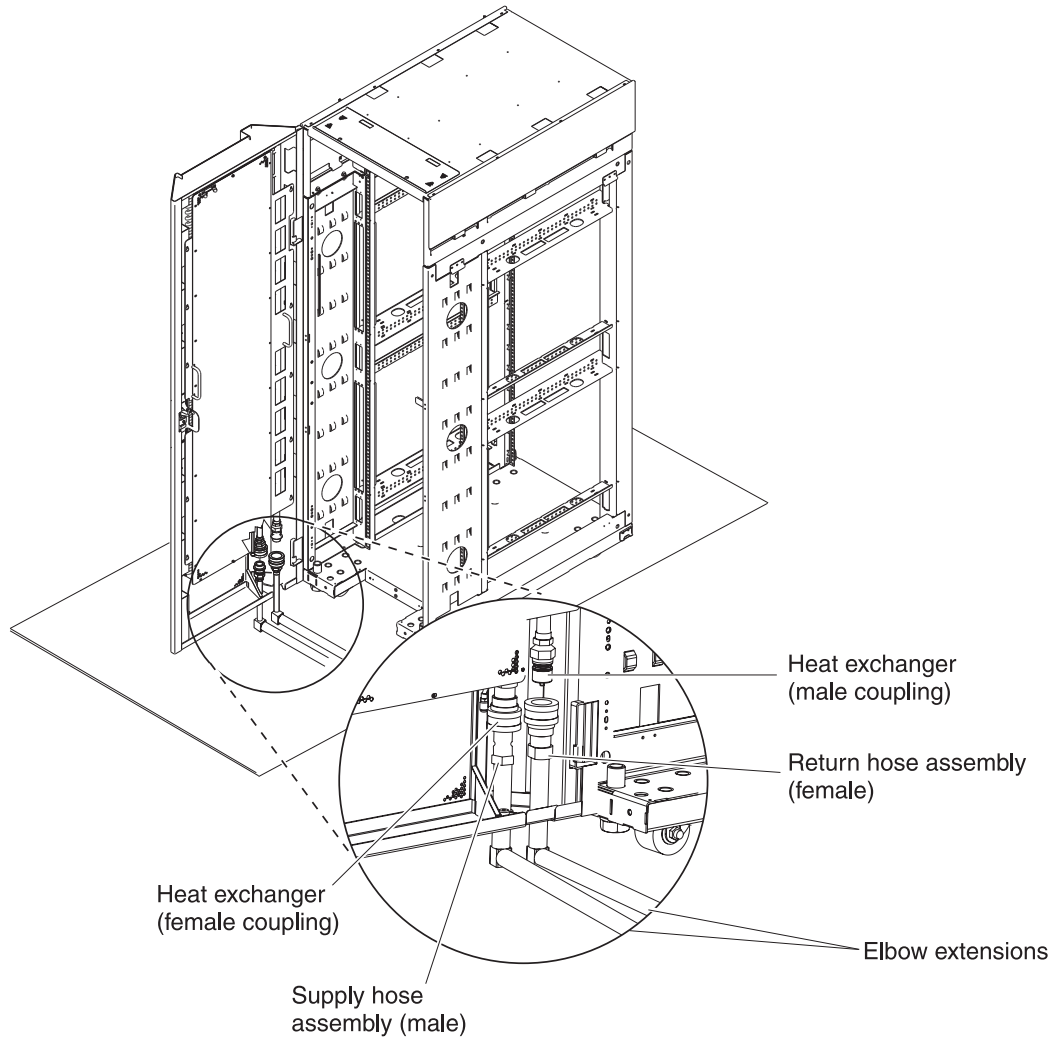

iphad977-0

Figure 31. Non-raised floor hose requirements for 19-inch EIA-rail rack

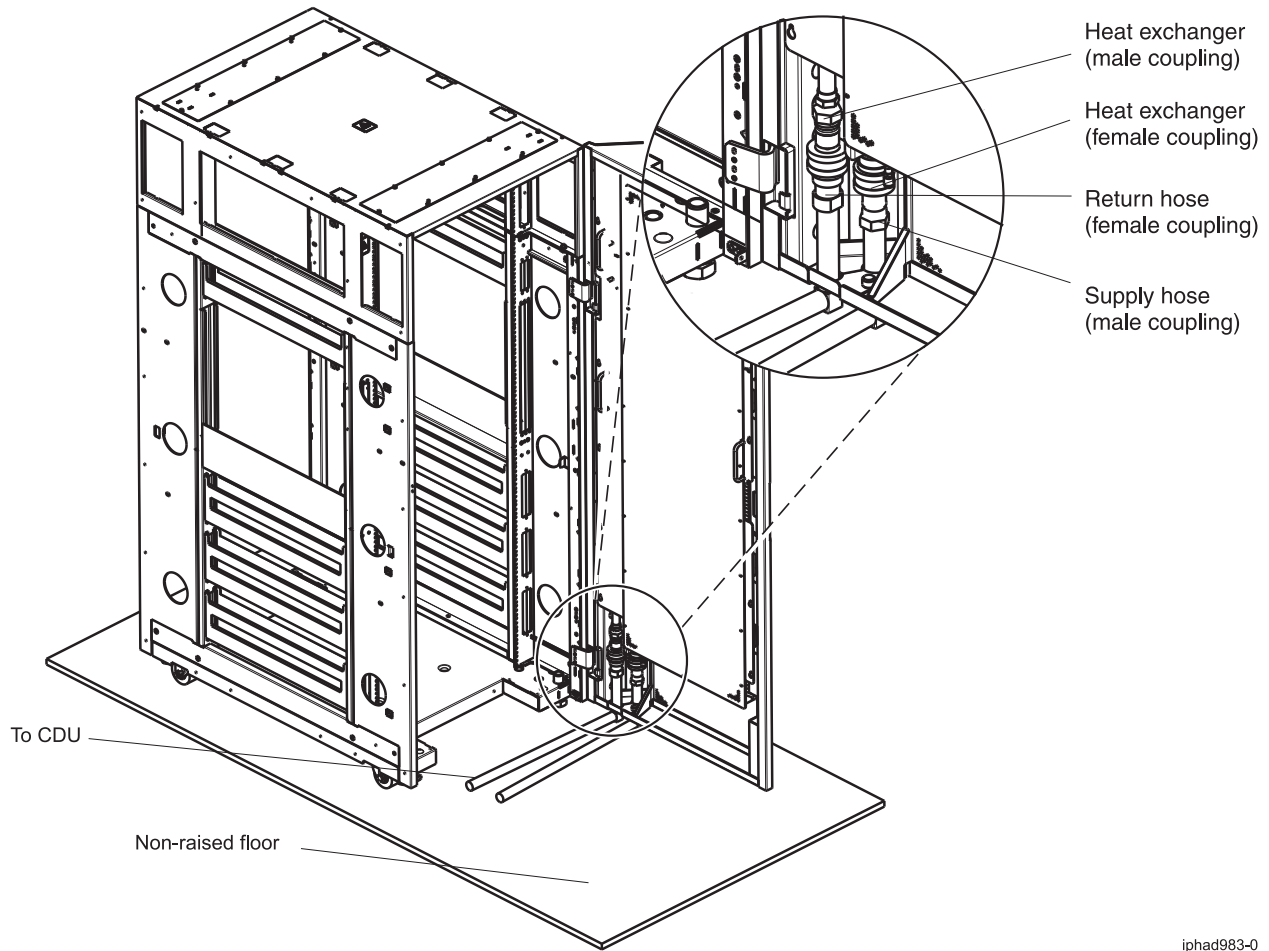

Figure 32. Non-raised floor hose requirements 24-inch EIA-rail rack

Hoses exiting the heat exchanger can be routed in a manner similar to that of power cables in a non-raised floor data center. For example, place the hoses side-by-side and allow them to move freely as they approach the rack (within approximately 3 m (10 ft) of the rack). When the door is opened, it is acceptable for the hoses to move slightly and rotate in parallel at the coupling interface inside the door. As the door is closed, the hoses rotate back to their original positions.

Note: When opening or closing the door, some manipulation of the hose along the floor might be necessary to prevent unwanted forces on the door and to make it easier to open and close the door.

Another method for non-raised floor hose routing is described using Figures 10 and 11 (without the hoses exiting a tile cutout). Hose exiting the heat exchanger turns and loops under the rack. In that method, the hose can then exit from under the rack at any place and in any direction that is convenient in your data center.

In either of these examples, hose coverings or protective devices are not provided by IBM. Routing and protection of the hose assemblies exterior to the rack is your responsibility.

Secondary cooling loop parts and services information

IBM supplies the rear door designed for IBM Enterprise server racks. For other parts and services needed for proper function and reliability of the secondary water loop, this section provides sources and information.

This sections lists suggested suppliers that you can contact:

Miscellaneous parts supplier

Supplier and contact information for miscellaneous secondary loop parts is provided.

Table 9. Miscellaneous secondary loop parts supplier for customers in North America, Europe, Middle East, Africa, Asia Pacific

Supplier	Solution	Contact information
Vette Corporation ¹	Installation of door and/or secondary loop items Preventive maintenance	Web: http://www.vettecorp.com Location: Vette Corp Datacom Facilities Division 201 Boston Post Road West Marlborough, MA 01752 Email: datacom_facilities@vettecorp.com Phone: 877-248-3883 or 508-203-4690
¹ This supplier will provide individual items in this list, or all the items, depending on needs and desires of each customer.		

Services supplier

Supplier and contact information for services that can be provided for secondary loop parts is provided.

Table 10. Services supplier for customers in North America, Europe, Middle East, Africa, Asia Pacific

Supplier	Solution	Contact information
Vette Corporation	Installation of door and/or secondary loop items Preventive maintenance	Web: http://www.vettecorp.com Location: Vette Corp Datacom Facilities Division 201 Boston Post Road West Marlborough, MA 01752 Email: datacom_facilities@vettecorp.com Phone: 877-248-3883 or 508-203-4690

Cooling distribution unit suppliers

This topic provides a list of possible suppliers for cooling distribution units.

Table 11. Cooling distribution unit supplier for customers in Europe. This table provides supplier and contact information for a coolant distribution unit (CDU), which was designed specifically for the IBM rear door heat exchanger.

Supplier	Solution	Contact Information
Eaton-Williams Group, Ltd.	Coolant distribution units (CDUs) CDU120 (120 kW, 400 - 480 V ac) CDU121 (120 kW, 208 V ac) CDU150 (150 kW, 400 - 480 V ac) CDU151 (150 kW, 208 V ac)	www.eaton-williams.com Location: Eaton-Williams Group, Ltd. Station Road Edenbridge Kent TN8 6EZ Phone: (0) 1732 866055 Fax: (0) 1732 867937

The following figure shows a cooling distribution unit with unit parts labeled.

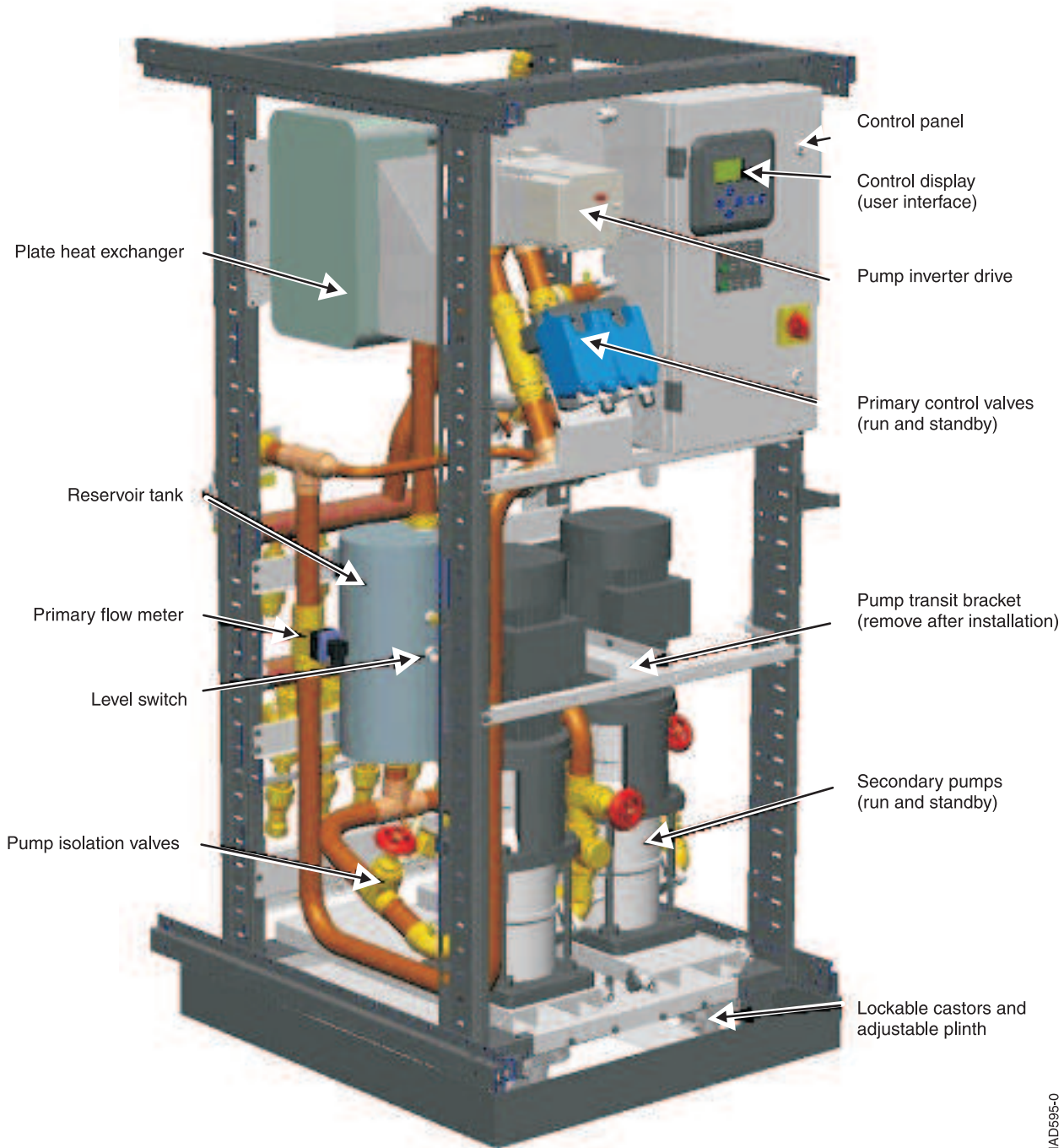

IPHAD595-0

Figure 33. Cooling distribution unit

The following tables show performance, electrical, and physical information of a cooling distribution unit.

Table 12. Performance

Performance	Properties
Maximum Cooling Capacity	120 kW (409450 BTU/Hr) or 150kW (511815 BTU/Hr)
Pump Capacity (design flow)	240 L/min (63.4 GPM)
Maximum Pump Head Pressure	355 kPa (51.5 psi) at design duty, excluding cabinet losses
Coolant (Liquid) Type	Chilled water (with up to 30% glycol)

Table 12. Performance (continued)

Performance	Properties
Primary Liquid Connections	1 1/2 in. flex tail for sweat connection, top or bottom
Secondary Liquid Connections	3/4 in. quick connects, hydraulic ISO-B
Unit Internal Primary Circuit Liquid Capacity	Approximately 10.0 liters (2.6 gallons)
Unit Internal Secondary Circuit Liquid Capacity	Approximately 32.0 liters (8.5 gallons)
Noise	Less than 55 dBA at 3 meters

Table 13. Electrical

Power Supply	Maximum Power Consumption
200 - 230 V ac, 30, 50/60 Hz or 400 - 480 V ac, 30, 50/60Hz	5.6 kVA at 480 V ac, 4.9 kVA at 208 V ac

Table 14. Physical

Height	Width	Depth	Weight (empty)	Weight (filled)
1825 mm (72 in.)	800 mm (31. in.)	1085 mm (43 in.)	396 kg (870 lb)	438 kg (965 lb)

Note: Other industrial coolant distribution units can be used in a secondary cooling loop, with the IBM rear door heat exchanger, if they meet the specifications and requirements described or referenced in this document.

Installation and support from IBM Integrated Technology Services offerings

Integrated Technology Services can assist in the planning and installation of your heat exchanger.

Services offered by IBM Integrated Technology Services include business consulting, outsourcing, hosting services, applications, and other technology management. These services help you learn about, plan, install, manage, or optimize your information technology infrastructure to be an On Demand business.

If you would like assistance with coordinating and managing the installation and support of rear door heat exchangers is desired, IBM can supply a focal point.

Before calling the 800 number shown in the table, have the following information available:

- Serial numbers of the racks
- Telephone number where the racks are located
- Contact name and phone number
- Building location and location of the racks within the building

To access the correct contact area in OSC Dispatch, dial the 800 number, request option 1, 1, 1 and when prompted, enter your 4-digit rack machine type.

Table 15. IBM Integrated Technology Services contact information

Geography	Contact information
North America	1-800-426-7378 (OSC Dispatch) Request contact with an IBM Installation Planning Representative in the service branch office closest to your location.

Table 15. IBM Integrated Technology Services contact information (continued)

Geography	Contact information
Europe, Middle East, Africa, Asia Pacific	Glen Yuan (Site Services Executive - AP Network & Site Integration Services) Phone: 886-910-007690 E-mail: glenyuan@tw.ibm.com

Power load

A preliminary sizing for total power load can be obtained by adding the total power requirements for all devices to be connected.

For a more precise analysis of power distribution system requirements, you can request an IBM System Power Profile Program printout from your seller. The System Power Profile Program, controlled and operated by the service office installation planning representative, provides a vector analysis rather than an arithmetic summation of total power. The vector analysis takes into consideration power factor and phase relationships. In addition, it considers waveform distortions caused by the load and inrush requirements. Additional capacity should be planned for future expansion. Contact your service office installation planning representative for information on how to obtain a System Power Profile.

Primary power problem areas

Your server is designed to operate on the normal power supplied by most electrical utility companies. However, possible computer malfunctions can be caused by outside (radiated or conducted) transient electrical noise signals being superimposed on the power line to the computer. To guard against this interference, power distribution design should comply with the specifications discussed in this topic.

Failures caused by the power source are basically of three types:

- Power line disturbances, such as, short duration dips in voltage as well as prolonged outages. If the frequency of such power failures is not acceptable for your operation, installing standby or buffered power might be necessary.
- Transient electrical noise superimposed on power lines might be caused by a variety of industrial, medical, communication, or other equipment:
 - Within the computing facilities
 - Adjacent to the computing facilities
 - In the vicinity of the power company's distribution lines

Switching large electrical loads can cause problems, even though the source is on a different branch circuit. If you suspect such a condition, it might be advisable to provide a separate, dedicated feeder or transformer for your server directly from your power source.

If the transient-producing devices have been eliminated from the feeder and the computer room power panel and power line disturbances are still present, it might be necessary for you to install isolation equipment (for example, transformers, motor generators, or other power conditioning equipment).

Lightning protection

Installing lightning protection devices is recommended on the computer power source when:

- The primary power is supplied by an overhead power service.
- The utility company installs lightning protectors on the primary power source.

- The area is subject to electrical storms or an equivalent type of power surge.

Lightning protection for communication wiring

Be sure to install lightning protection devices to protect communication wiring and equipment from surges and transients induced into the communication wiring. In any area subject to lightning, surge suppressors should be installed at each end of every outdoor cable installation, whether installed above the ground (aerial) or buried below the ground.

Information about lightning surge suppressors for communication wiring systems and recommended installation methods for outdoor communication cables can be found in the manuals for the specific type of data processing system that is being considered.

Power quality

The quality of electrical power significantly impacts the performance of sensitive electronic equipment. These guidelines ensure that quality electrical power is provided to your data center.

IBM equipment can tolerate some power disturbances or transients. However, large disturbances can cause equipment power failures or errors. Transients can come into the site on the power utility company lines but are often caused by electrical equipment installed in the building. For example, transients can be produced by welders, cranes, motors, induction heaters, elevators, copy machines, and other office equipment. The best way to prevent problems caused by power disturbances is to have transient-producing equipment on a separate power service than the one that supplies power to your information technology equipment.

Ground or earth

When used in reference to electrical power systems, Ground is a conducting connection between an electrical circuit and the earth or some conducting body that serves in place of the earth. The term ground is the most common name used, however it is also referred to as earth or terra in several international geographies. In this topic, these terms and other local language equivalents are interchangeable.

Ground is a critical component of an electrical power distribution system. A properly installed ground system allows for safe operation of equipment that is connected to the electrical power source under normal and electrical or equipment fault conditions. The life safety function of ground and grounding methods is addressed by the appropriate local and national electrical wiring codes. In the United States, this code is known as the National Electric Code or publication 70 of the National Fire Protection Association. Many countries have adopted the National Electric Code or have developed an equivalent code.

The National Electric Code and its equivalents have a primary objective to provide safe operation of electrical power distribution systems and electrical equipment installations. Compliance with these codes does not guarantee efficient operation of equipment connected to the power distribution systems. When sensitive electronic equipment is connected, there are often times when additional ground connections may be required. Typically, additional ground connections are recommended when there is a concern for high frequency or radio frequency (RF) interference, which may impact electronic circuits. These additional ground requirements will be found with the installation documentation for specific equipment. Additional ground requirements may also be recommendations from engineering or data center evaluations, reviews or surveys. Local or national codes allow for these additional grounds to be installed.

Grounding

IBM equipment, unless double insulated, has power cords containing an insulated grounding conductor (color-coded green or green with yellow stripe) that connects the frame of the equipment to the ground terminal at the power receptacle. The power receptacles for IBM equipment are identified in the equipment documentation and should match the equipment power plug. In some cases, there may be options for different manufacturer equivalent receptacles. IBM equipment plugs should not be changed or altered to match existing connectors or receptacles. To do so may create a safety hazard and void product warranty. The connectors or receptacles for IBM equipment should be installed to a branch circuit with an equipment grounding conductor, connected to the grounding bus bar in the branch-circuit distribution panel. The grounding bus bar in the panel should then be connected back to the service entrance or suitable building ground by an equipment grounding conductor.

Information technology equipment must be properly grounded. It is recommended that an insulated green wire ground, the same size as the phase wire, be installed between the branch circuit panel and the receptacle.

For personnel safety, the ground must have sufficiently low impedance to limit the voltage to ground and to facilitate the operation of protective devices in the circuit. For example, the ground path shall not exceed 1 ohm for 120-volt, 20-ampere branch circuit devices.

The ground path impedance limit is 0.5 ohms for 120 volt branch circuits protected by 30 ampere circuit breakers. The limit is 0.1 ohms for 120 volt 60 to 100 ampere circuits.

All grounds entering the room should be interconnected somewhere within the building to provide a common ground potential. This includes any separate power sources, lighting and convenience outlets, and other grounded objects, such as building steel, plumbing, and duct work.

The equipment grounding conductor must be electrically attached to both the enclosure of the computer power center and the connector grounding terminal. Conduit must not be used as the only grounding means, and it must be connected in parallel with any grounding conductors it contains.

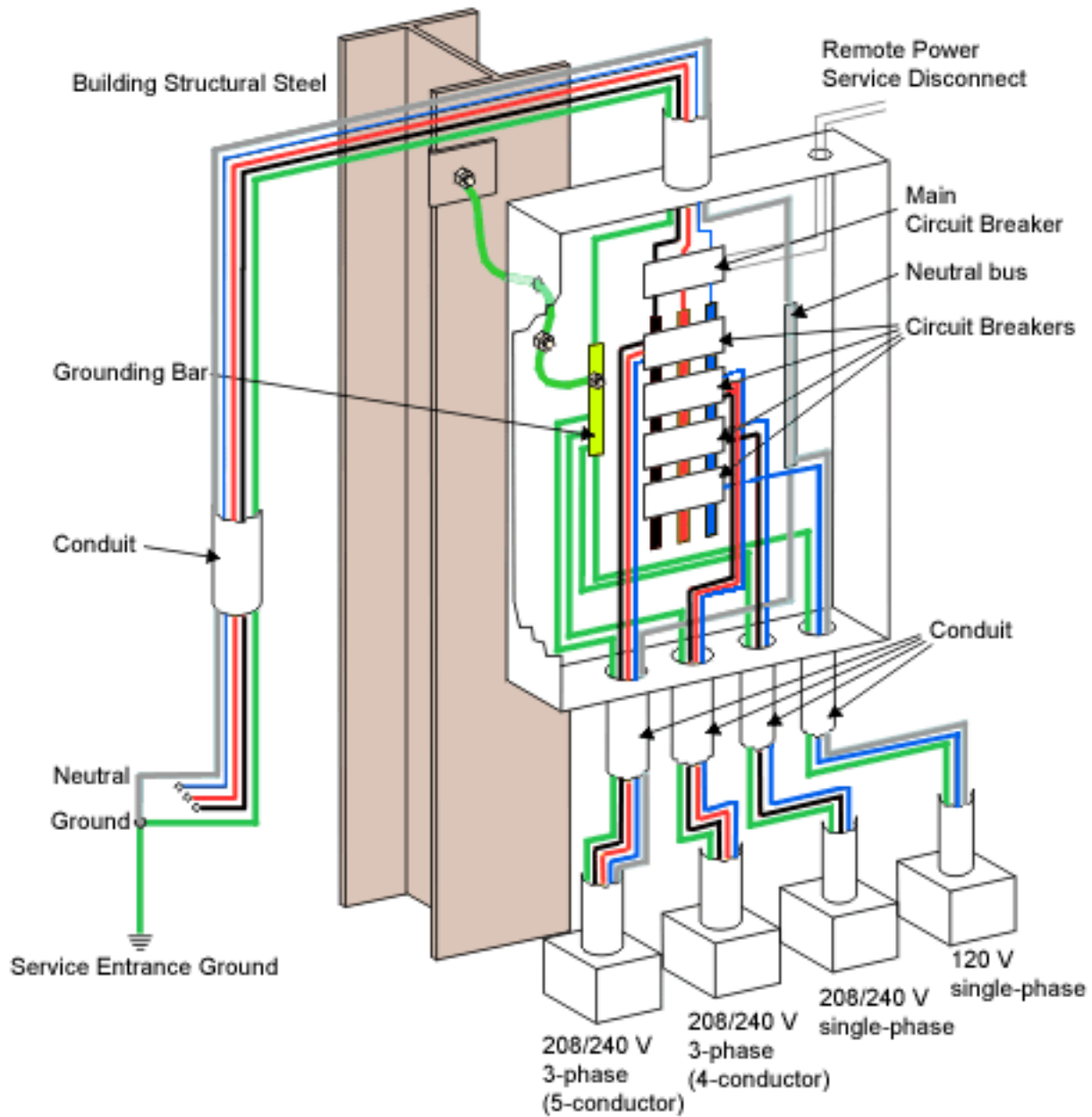

Figure 34. Transient grounding plate

Transient grounding

To minimize the effects of high-frequency electrical noise, the branch circuit power panel servicing the equipment should be mounted in contact with bare building steel or connected to it by a short length of cable. If this is not possible, a metal area of at least 1 m² (10 ft²) in contact with masonry can be used. The plate should be connected to the green-conductor common.

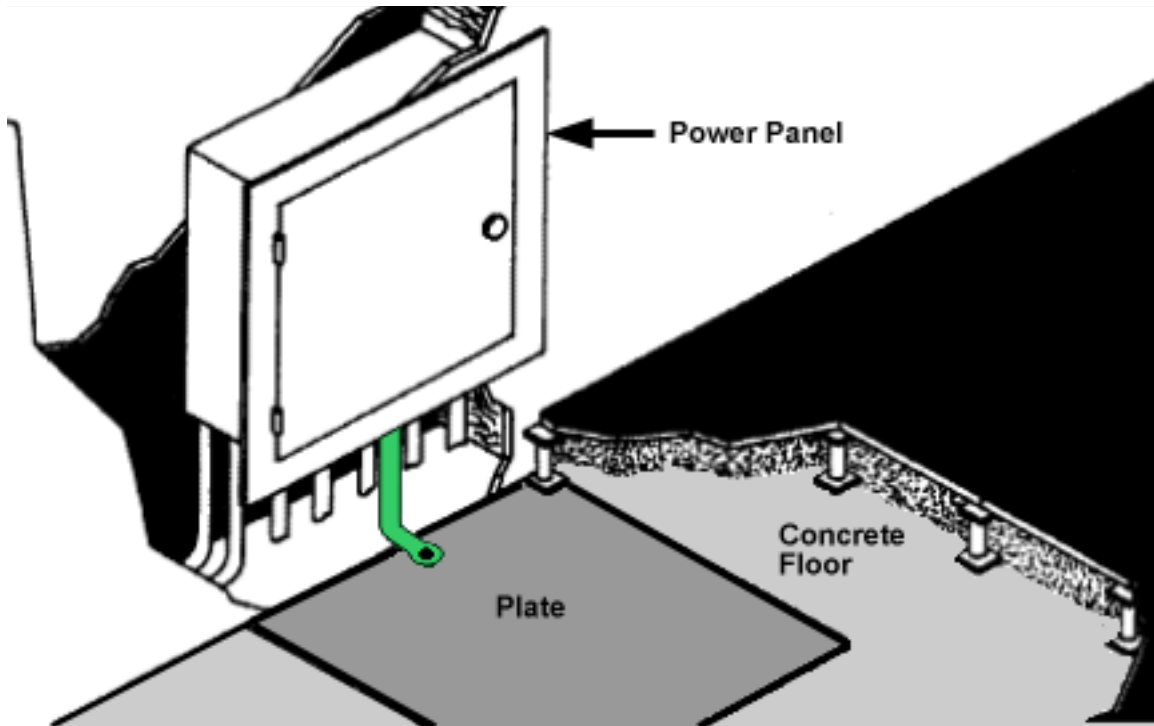

Figure 35. Transient grounding plate

The preferred connection is with a braided strap. If a braided strap is not available, the connection should consist of no. 12 AWG (3.3 mm or 0.0051 in.) or larger conductor and should not be more than 1.5 m (5 ft) long. To minimize this length, the preferred connection of this braided strap or conductor is to the nearest portion of the enclosure on the panel, if the enclosure is electrically continuous from the green-conductor common point to this point of connection.

The raised-floor-supporting substructure can be used as a substitute for the transient plate if the structure has a consistently low-impedance path. If the raised floor has stringers or other subframing that makes electrical connection between the pedestals, the floor itself can be used for the signal reference plane. Some raised floors are stringerless and the floor tiles lock into isolated pedestals by gravity alone. If there is no reliable electrical connection between the pedestals, a signal reference grid can be constructed by connecting the pedestals together with conductors. A minimal grid would interconnect every other pedestal in the immediate area of the power panel and extend at least 3 m (10 ft) in all directions.

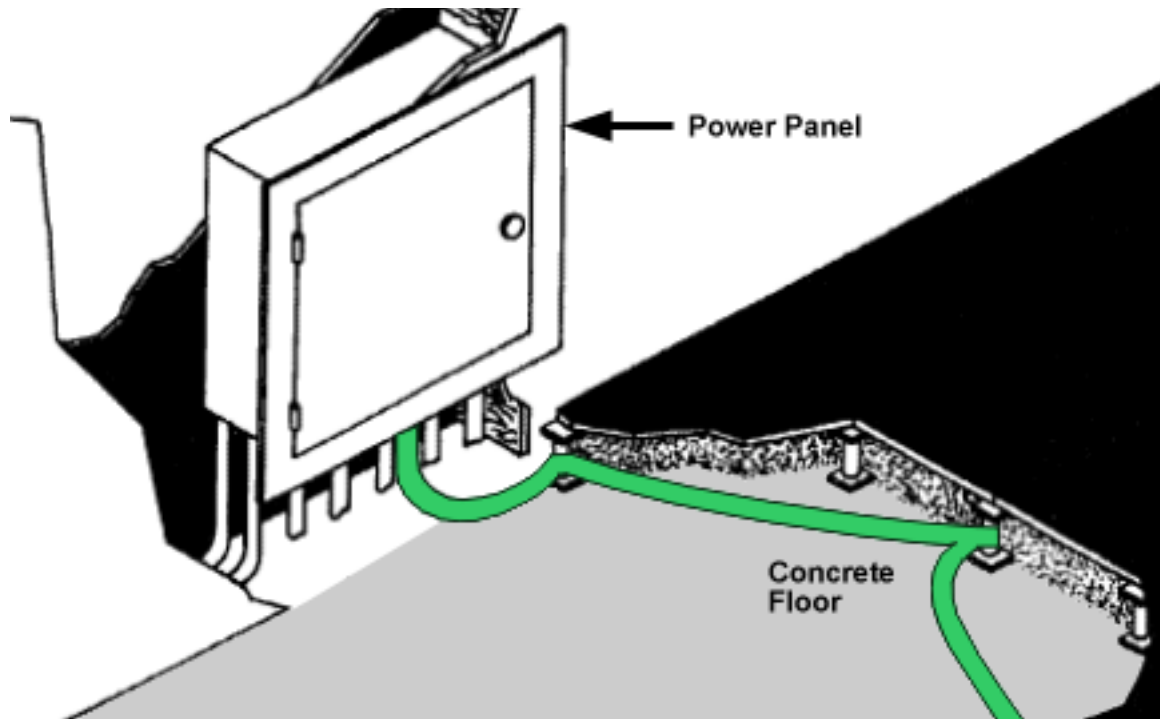

Figure 36. Transient grounding using the raised floor support structure

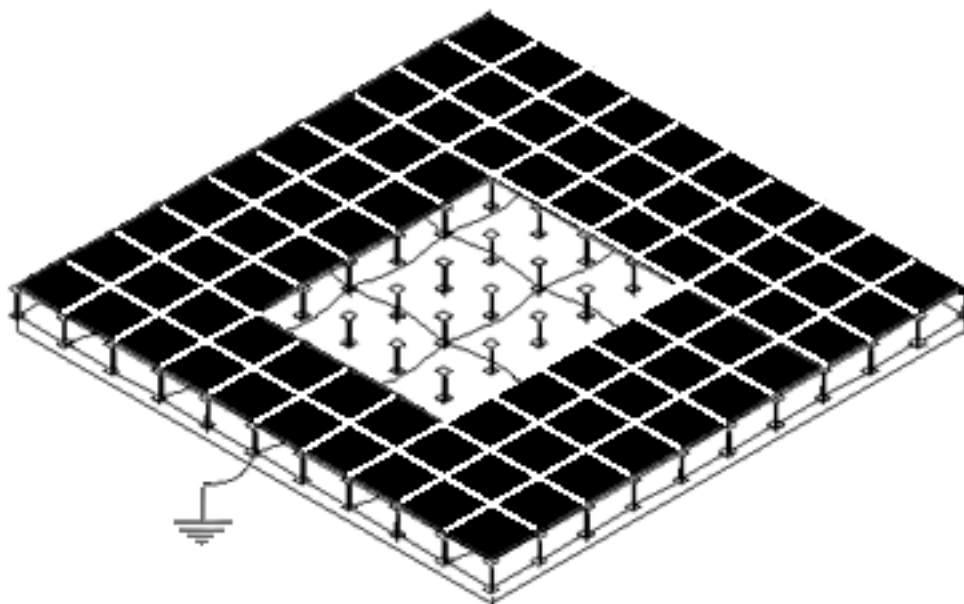

Figure 37. Signal reference grid

Stranded bare or insulated conductor of at least no. 8 AWG (8 mm or 0.0124 in.) copper is required. This conductor provides a low-impedance path and is strong enough to make physical damage unlikely. Any connection method is acceptable as long as it provides a reliable electrical and mechanical connection.

A customer's self-contained, separately derived power system (computer power centers, transformers, motor generators), installed on a raised floor, has the same requirements.

Power specifications

Your server is normally furnished with power-supply provision to meet the 50-Hz or 60-Hz voltage standards shown in the following tables, respectively.

Table 16. . 50-Hz standard voltages

Phases	Voltages					
Single phase	100	110	200	220	230	240
Three phase	200	220	380	400	415	

Note:

1. This table lists the nominal voltages available at the specified frequency. The columns for single phase and three phase do not imply a phasor relationship.

Table 17. . 60-Hz standard voltages

Phases	Voltages								
Single phase	100	110	120	127	200	208	220	240	277
Three phase	200	208	220	240	480				

Note:

1. This table lists the nominal voltages available at the specified frequency. The columns for single phase and three phase do not imply a phasor relationship.

Power source

These guidelines help to ensure that your data center has a quality power source.

The primary power source is normally a wye-type or delta-type, three-phase service coming from a service entrance or a separately derived source with appropriate overcurrent protection and suitable ground (service entrance or building ground). A three-phase, five-wire power distribution system should be provided for flexibility in your data processing installation. However, depending on the type of equipment installed, a single-phase distribution system might be sufficient. The five wire system enables you to provide power for three-phase line-to-line, single phase line-to-line, and single phase line-to-Neutral. The five wires consist of three phase conductors, one neutral conductor, and one insulated equipment grounding conductor (green, or green with yellow trace).

Conduit must not be used as the only grounding means.

Power panel feeders

Ensure that the feeder wires to the branch-circuit distribution panel (shown in *Power quality*) are large enough to handle the total server power load. It is recommended that these feeders service no other loads.

Branch circuits

The computer branch circuit panel should be in an unobstructed, well-lighted area in the computer room.

The individual branch circuits on the panel should be protected by suitable circuit breakers properly rated according to manufacturer specifications and applicable codes. Each circuit breaker should be labeled to identify the branch circuit it is controlling. The receptacle should also be labeled.

Where a branch circuit and receptacle are installed to service your server, it is recommended that the grounding conductor of the branch circuit be insulated and equal in size to the phase conductors. The grounding conductor is an insulated, dedicated-equipment-grounding conductor, not the neutral.

Branch circuit receptacles installed under a raised floor should be within 0.9 m (3 ft) of the server that they supply power to. If the branch circuits are contained in a metallic conduit, either rigid or nonrigid, the conduit system should be grounded. This is accomplished by bonding the conduit to the power distribution panel, which in turn, is tied to the building or transformer ground.

Power cords are supplied in 4.3 m (14 ft) lengths unless otherwise noted in the server specifications. The length is measured from the exit symbol on the plan views. Some power plugs furnished by your seller are watertight, and should be located under the computer room raised floor.

Phase rotation

The three-phase power receptacles for some equipment, such as printers, must be wired for correct phase rotation. When looking at the face of the receptacle and counting clockwise from the ground pin, the sequence is phase 1, phase 2, and phase 3.

Emergency power control

A disconnecting means should be provided to disconnect the power from all electronic equipment in the computer room. This disconnecting means should be controlled from locations readily accessible to the operator at the principal exit doors. A similar disconnecting means to disconnect the air conditioning system serving this area should be available. Consult the local and national codes to determine the requirements for your installation. National Electric Code (NFPA 70) article 645 provides the requirements for this room EPO.

See *Emergency planning for continuous operations*.

Convenience outlets

A suitable number of convenience outlets should be installed in the computer room and the Service Representative area for use by building maintenance personnel and service representatives. Convenience outlets should be on the lighting or other building circuits, not on the computer power panel or feeder. Under no circumstances are the service convenience outlets on your servers to be used for any purpose other than normal servicing.

Related concepts:

“Power quality” on page 67

The quality of electrical power significantly impacts the performance of sensitive electronic equipment. These guidelines ensure that quality electrical power is provided to your data center.

“Emergency planning for continuous operations” on page 17

Planning for emergencies ensures that your data center continues to operate in the event of a power outage.

Raised floors

Learn how a raised floor environment improves data center operational efficiency.

A raised floor accomplishes the following major objectives:

- Improves operational efficiency and allows greater flexibility in the arrangement of equipment
- Permits the space between the two floors to be used to supply cooling air to the equipment or area
- Allows for future layout change with minimum reconstruction cost
- Protects the interconnecting cables and power receptacles

- Prevents tripping hazards

A raised floor should be constructed of fire-resistant or noncombustible material. The two general floor types are shown in the following figure. The first figure is of a stringerless floor, and the second figure is a floor with stringers.

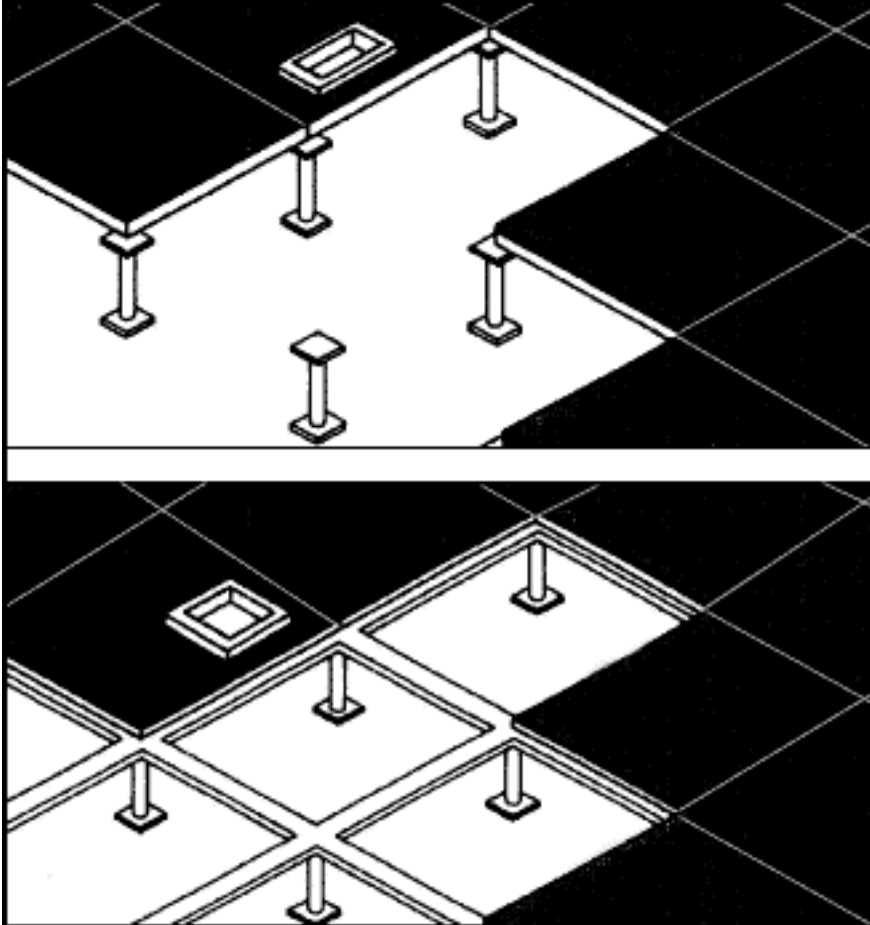

Figure 38. Raised floors types

Raised floor factors:

- No metal or highly-conductive material that might be at ground potential should be exposed to the walking surface when a metallic raised-floor structure is used. Such exposure is considered an electrical safety hazard.
- The raised-floor height should be between 155 mm (6 in.) and 750 mm (30 in.). For processors with multiple channels, a minimum raised-floor height of 305 mm (12 in.) is recommended. Clearance must be adequate to accommodate interconnecting cables, fiber cable raceways, power distribution, and any piping that is present under the floor. Experience has shown that higher raised-floor heights allow better air-conditioning balance in the room.
- Caster point loads on some servers can be as high as 455 kg (1,000 lb) concentrated load anywhere on the panel with a 2 mm (0.080 in.) maximum deflection .
- When a raised-floor panel is cut for cable entry or air supply, an additional panel support (pedestal) might be required to restore the structural integrity of the panel to the above requirement.
- Use protective covering (such as plywood, tempered masonite, or plyon panels) to prevent damage to floor tiles, carpeting, and panels while equipment is being moved into or is relocated within the installation. When the equipment is moved, the dynamic load on the casters is significantly greater than when the equipment is stationary.

- Concrete subfloors require treatment to prevent the release of dust.
- Use noncombustible protective molding to eliminate sharp edges on all floor cutouts to prevent damage to cables and hoses and to prevent casters from rolling into the floor cutout.
- Pedestals must be firmly attached to the structural (concrete) floor using an adhesive.
- Cable cutout size information is determined by the volume of cables passing through the cutout. See the server's documentation for recommendations on the cable cutout size.

Signal reference ground

To minimize the effects of high-frequency (HF) interference and other undesired electrical signals (commonly referred to as electrical noise), a Signal Reference System (SRS) may be recommended. An SRS may be made up of a Signal Reference Ground or Grid (SRG), or a Signal Reference Plane (SRP). A Signal Reference Ground or Grid may also be known as a Zero Signal Reference Ground (ZSRG). Regardless of the name used, the intent is to provide an equal potential point of reference for equipment installed in a contiguous area for a wide range of frequencies. This is accomplished by installing a network of low impedance conductors throughout the information technology room.

Access (raised) flooring systems that utilize bolted stringer construction can be used to provide a simple SRG. Floor systems that have either no stringer or snap-in stringers do not provide for an effective SRG, and other methods for installing a SRG should be used.

For safety requirements, the SRG must be connected to earth ground. SRG practices recommend that all metallic objects that cross the SRG area are to be bonded (mechanically connected) to the SRG.

For more information on Signal Reference Grounds, contact your IBM installation planning representative.

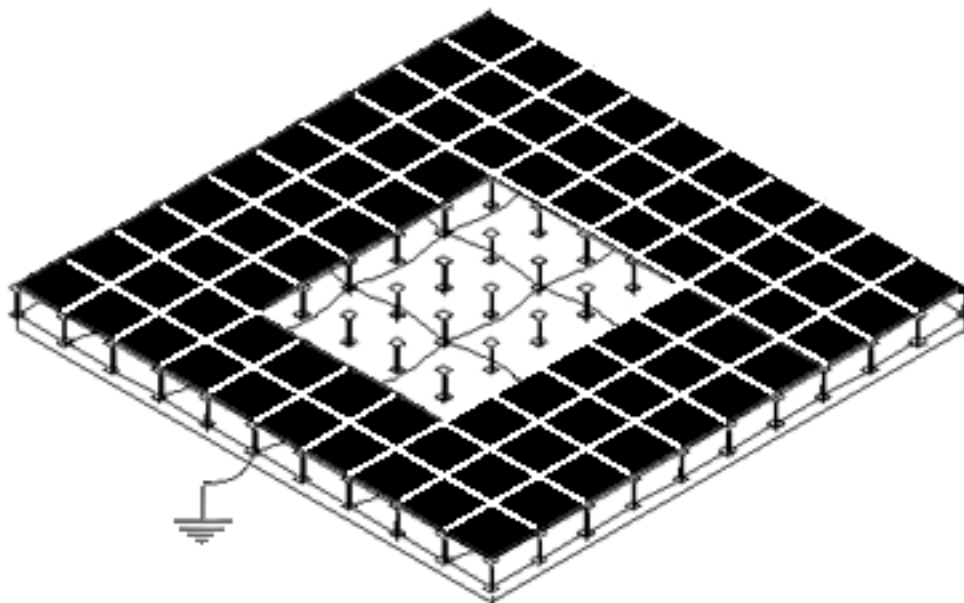

Figure 39. Signal reference ground

Conductive contamination

Contaminants that conduct electricity need to be reduced in data center environments.

Semiconductors and sensitive electronics used in current information technology equipment have allowed for the manufacture of very high density electronic circuitry. Although new technology allows for significant increases or capacity in a smaller physical space, it is susceptible to contamination, especially

contamination particles that will conduct electricity. Since the early 1990s, it has been determined that data center environments may contain sources of conductive contamination. Contaminants include: carbon fibers, metallic debris such as aluminum, copper and steel filings from construction, and zinc whiskers from zinc-electroplated materials used in raised floor structures.

Although very small, and at times not easily seen without the visual aid of magnifying lenses, this type of contamination can have disastrous impact on equipment availability and reliability. Errors, component damage and equipment outages caused by conductive contamination can be difficult to diagnose. Failures may be at first attributed to other more common factors such as lightning events or electrical power quality or even just presumed to be defective parts.

Zinc whiskers

The most common conductive contamination in raised-floor data centers is what is known as zinc whiskers. It is the most common because it is frequently found on the underside of certain types of access floor tiles. Typically, the wood core style floor tile has a flat steel bottom. The steel may be coated with zinc either by a hot-dip-galvanize process or by zinc electroplate. The zinc electroplate steel exhibits a phenomena that appears as whisker-like growths on the surface. These small particles of approximately 1-2 mm (.04-.08 in.) in length can break away from the surface and get pulled into the cooling air stream. Eventually they might be ingested by the equipment air, settle on a circuit board and create a problem. If you suspect that you may have this type of problem, contact your IBM Service representative.

The following figure shows light reflection from zinc whiskers.

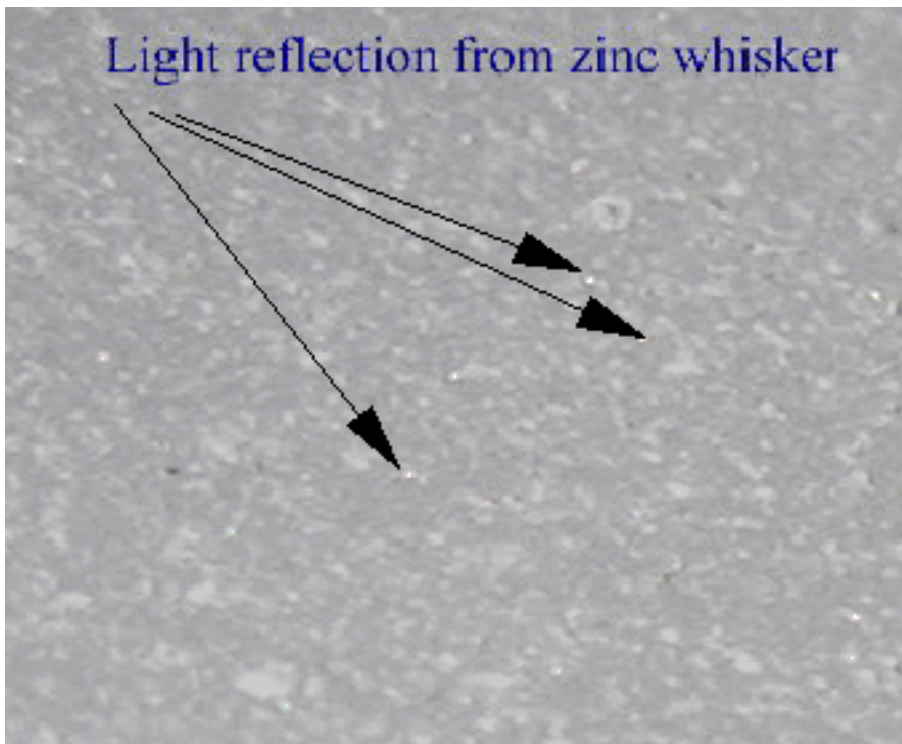

Figure 40. Light reflection from zinc whiskers

Relocation and temporary storage

Shipment or storage conditions that exceed the specified limits can cause permanent damage to your server. These guidelines should be followed when relocating or temporarily storing your server.

Care should be taken to ensure that a server is not stored with chemicals that can cause corrosion damage.

When a server is removed in preparation for shipment or storage, use the packaging bill of material. This might include a protective package, including blocks, braces, and preparation instructions, designed uniquely for each server. This is available from any IBM branch office. IBM large processors are designed for operation in a controlled temperature and relative humidity range, and require the environment be kept within this range even when they are in a storage area or in transit. See the individual server specifications for operating environment limits. Shipment of large processors should be in an environmentally controlled van with appropriate strapping and padding to avoid any transit damage.

Table 18. Typical shipping environment

Properties	Shipping environment
Temperature	-40°C - 60°C (-40°F - 140°F)
Relative humidity	5% to 100% (no condensation)
Maximum wet bulb	1°C - 27°C (33.8°F - 80.6°F)

If shipping a large processor in a nonenvironmentally controlled van, contact your seller for packing and unpacking instructions.

Table 19. Typical storage environment

Properties	Storage environment
Temperature	1°C - 60°C (33.8°F - 140°F)
Relative humidity	5% - 80%
Maximum wet bulb	1°C - 29°C (33.8°F - 84.2°F)

Space requirements

The floor area required for the equipment is determined by the specific servers to be installed, the location of columns, floor loading capacity, and provisions for future expansion.

See *Floor construction and floor loading* to review floor loading and weight distribution for your system. When the amount of space is determined, allow for the addition of furniture, carts, and storage cabinets. Additional space, not necessarily in the computer area, is required for air conditioning, electrical, security systems, and fire protection equipment as well as for the storage of tapes, forms, and other supplies. Additional space might be needed to access the server (for example, rack-door-opening clearance). Plan to store all combustible materials in properly designed and protected storage areas.

A computer room or area should be separated from adjacent areas to allow for air conditioning, fire protection, and security. The floor-to-ceiling height must be sufficient to allow server top covers to open for service and should be adequate to allow air circulation from the data processing machine. Recommended heights are 2.6 m to 2.9 m (8 ft 6 in. to 9 ft 6 in.) from the building floor or (if used) from the raised floor to ceiling, but higher ceilings are acceptable. In new construction or remodeling, the computer room area should have a minimum door width of 914 mm (36 in.). Because many machine frames are close to 914 mm (36 in.) in width, the use of a 1067 mm (42 in.) door width would be preferable. The door height should be a minimum of 2032 mm (80 in.) of unobstructed height (no threshold plate).

Related concepts:

“Floor construction and floor loading” on page 22
Calculate the floor loads for your server with these formulas.

Static electricity and floor resistance

Use these guidelines to minimize static electricity buildup in your data center.

Floor covering material can contribute to buildup of high static electrical charges as a result of the motion of people, carts, and furniture in contact with the floor material. Abrupt discharge of the static charges causes discomfort to personnel and might cause malfunction of electronic equipment.

Static buildup and discharge can be minimized by:

- Maintaining the relative humidity of the room within the server operating limits. Choose a control point that normally keeps the humidity between 35 percent and 60 percent. See the *Air conditioning determination* for further guidance.
- Providing a conductive path to ground from a metallic raised floor structure including the metal panels.
- Grounding the raised floor metallic support structure (stringer, pedestals) to building steel at several places within the room. The number of ground points is based on the size of the room. The larger the room, the more ground points are required.
- Ensuring the maximum resistance for the flooring system is 2×10^{10} ohms, measured between the floor surface and the building (or an applicable ground reference). Flooring material with a lower resistance will further decrease static buildup and discharge. For safety, the floor covering and flooring system should provide a resistance of no less than 150 kilohms when measured between any two points on the floor space 1 m (3 ft) apart.
- Maintenance of antistatic floor coverings (carpet and tile) should be in agreement with the individual supplier's recommendations. Carpeted floor coverings must meet electrical conductivity requirements. Use only antistatic materials with low-propensity ratings.
- Using ESD-resistant furniture with conductive casters to prevent static buildup.

Measuring floor resistance

The following equipment is required for measuring floor resistance:

- A test instrument similar to an AEMC-1000 megohmmeter is required for measuring floor conductivity.

The following figure shows the typical test connection to measure floor conductivity.

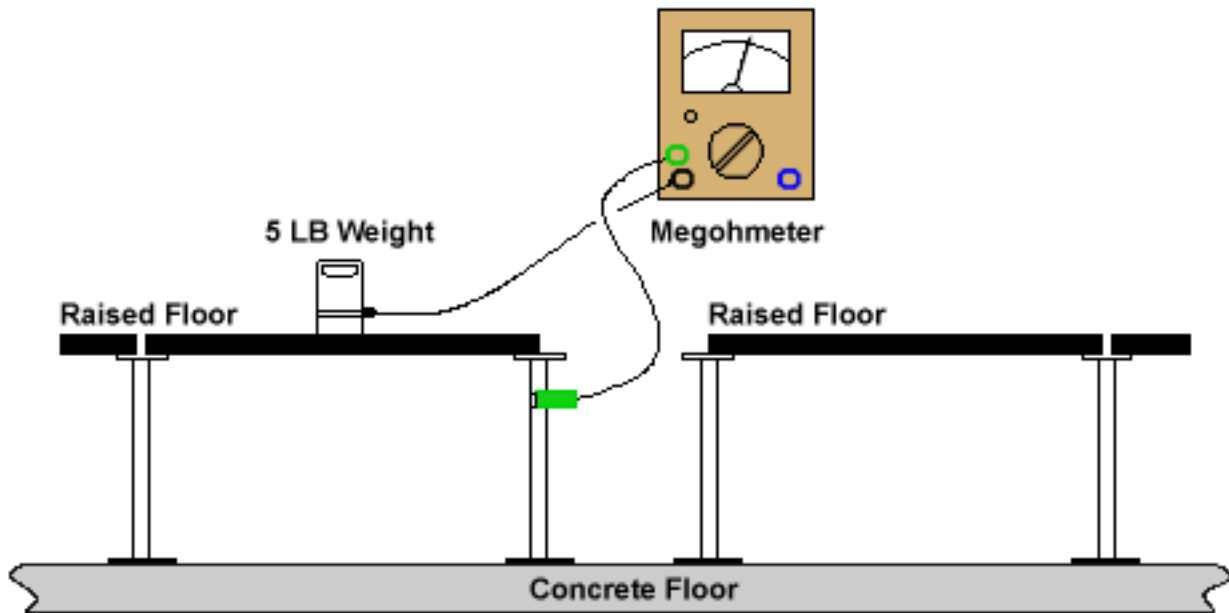

Figure 41. Typical test connection to measure floor conductivity

Related concepts:

“Air conditioning determination” on page 4

The air conditioning system must provide year-round temperature and humidity control as a result of the heat dissipated during equipment operation.

System air distribution

Careful attention should be given to the method of air distribution to eliminate areas of excessive air motion and hot spots.

Regardless of the type of system, it should use predominantly recirculated air with a set minimum of fresh air for personnel. This helps eliminate the introduction of dust, reduces the latent load, and allows the system to carry on a sensible cooling operation. The various methods of air distribution and computer room air conditioning (CRAC) are shown in the following figures.

In general you should ensure that the design supply and return air temperatures are within the manufacturer's specifications for CRAC units.

Underfloor air distribution

In underfloor air distribution, the space between the regular building floor and the raised floor is used as a means to supply air for equipment cooling (see the following figure). Concrete subfloors might require treatment to prevent the release of dust. Air is discharged into the room through perforated panel floor registers. The air is returned directly to the air conditioning system or by means of a ceiling return system. Remove obsolete cabling (as required in the United States National Electrical Code) and seal all raised-floor openings that are not specifically intended to supply cool air to equipment intakes.

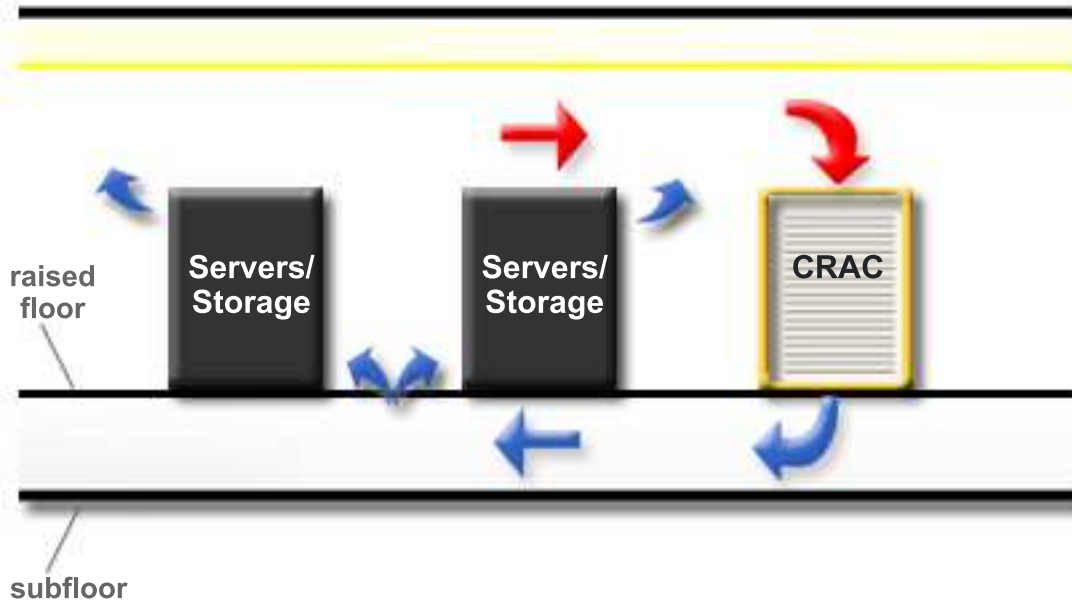

Figure 42. Underfloor air distribution

A higher return air temperature can be tolerated in underfloor air distribution without affecting the design conditions of the overall room. The underfloor design takes into consideration a heat transfer factor through the raised metal floor and also provides some reheated air to control the relative humidity before it enters the room.

A temperature control system would consist of the same controls as described for the single duct system. In addition, the system must have controls for air temperature in the under floor supply system to prevent under floor temperatures from getting below the room dew point. Air entering the server through the cable holes must be within operating limits. (See *Temperature and humidity design criteria*).

Combination overhead and under floor system

For a combination overhead and under floor air circulation design, the primary air conditioning unit is inside the room and the secondary air conditioning unit is outside the room. See following figure.

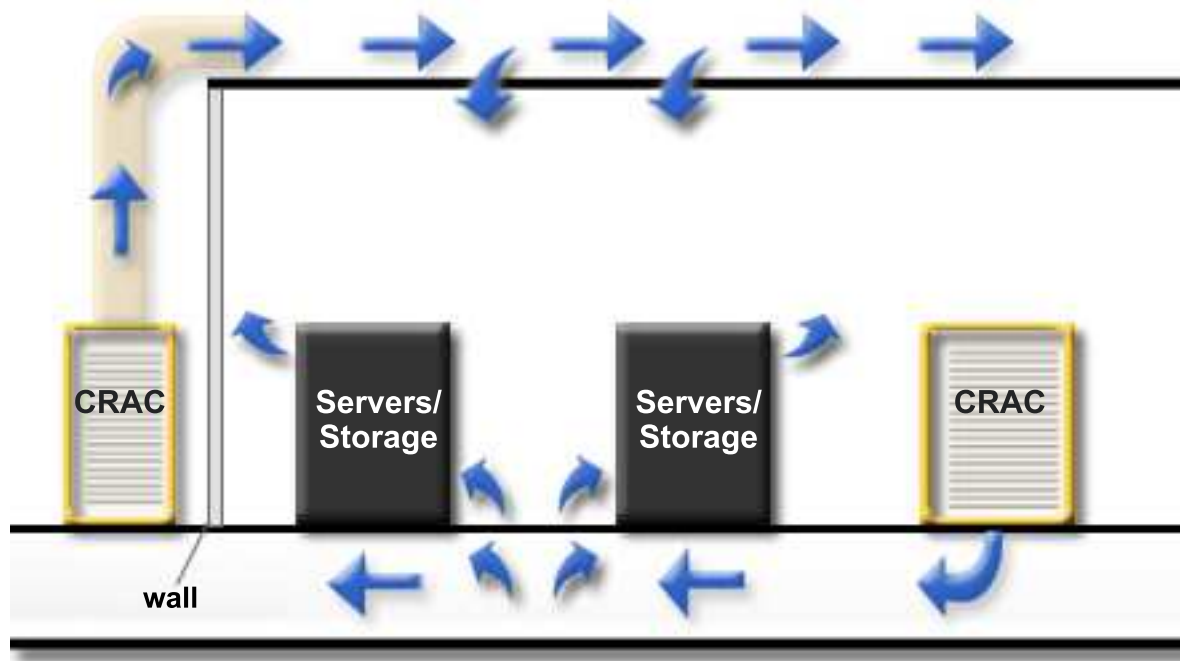

Figure 43. Combination overhead and underfloor air conditioning system

An air handler, with separate controls, supplies conditioned and filtered air to the area under the raised floor. The air is discharged into the room through floor panels or registers. This air absorbs the heat generated by the server and is discharged from the top or rear of the servers into the room. The relative humidity of the air supplied to the information technology equipment should be below 80 percent and the temperature should be controlled to prevent condensation on or within the servers. It might be necessary to provide for a reheating system to operate with the cooling unit to control relative humidity.

The second air handling system supplies air directly to the room through a separate supply system and should be large enough to absorb the remaining heat load in the computer room. It should maintain room temperature and relative humidity as specified and give continuous air conditioning and ventilation.

Overhead air circulation

In overhead air circulation, the entire heat load of the room or area, including the heat generated by the information technology equipment, is absorbed by the air supplied to the computer room and the area diffuser system or by a pressurized ceiling supply.

The air returned to the air conditioning system is from either ceiling return registers above the heat-producing servers, or from a fixed pattern of return registers both in the ceiling and on the walls of the room. The following figure shows an overhead air circulation system.

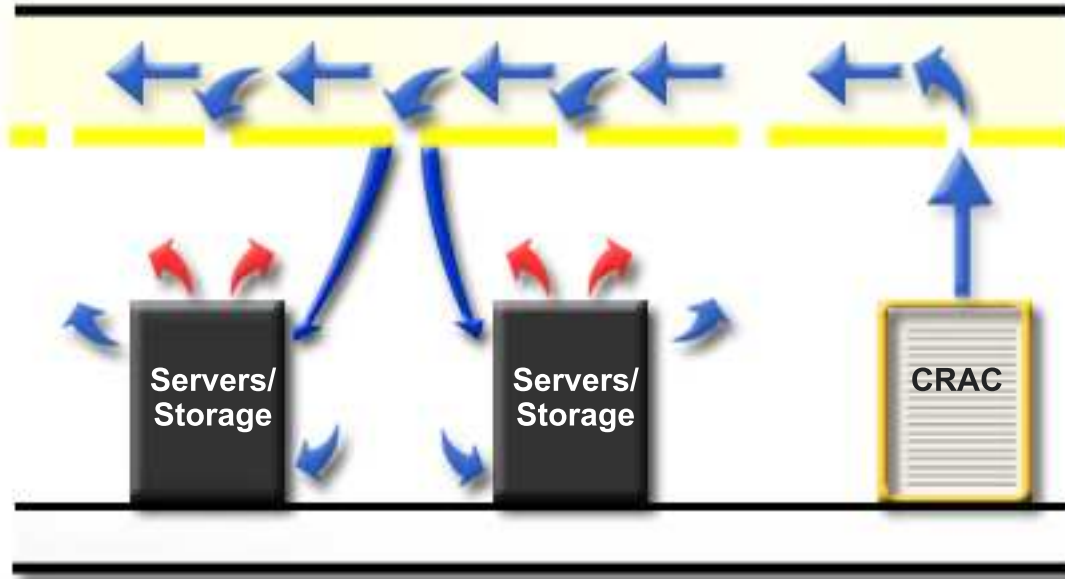

Figure 44. Overhead air distribution system

To maximize the cooling capability of such an arrangement, it is imperative to align the supply discharges with the cold aisles and the return grilles with the hot aisles. The supply discharges should force air directly down into the cold aisles and not use diffusers that distribute air laterally. Such diffusion can cause cool air to migrate undesirably into the return air path prior to having the opportunity to transfer heat from the equipment.

A temperature control system should consist of temperature and humidity controls. These controls should be placed in a representative location within the machine room. The temperature and humidity recorder (described in *Temperature and humidity design criteria*) should be mounted next to the controls to monitor conditions.

Air filtration

A high efficiency filter should be installed to filter all air supplied to the computer room. Because mechanical and electrostatic air cleaners operate on different principles, a different rating is specified for each type. Ratings are determined by using the test methods outlined in the American Society of Heating, Refrigeration and Air Conditioning Engineers (ASHRAE) Standard No. 52-76 (or national equivalent). Special air filtration is necessary where installations are exposed to corrosive gases, salt air, or unusual dirt or dust conditions.

Mechanical air filters must be rated at a minimum initial atmospheric dust-spot efficiency of 40 percent.

Electrostatic air filters are designed to operate at 85 to 90 percent efficiency at a given face velocity. The filter must be operated in accordance with the manufacturer's recommendation to prevent bypass and ozone buildup, which can be detrimental to certain servers.

Related concepts:

“Environmental design criteria” on page 18

Use these environmental design criteria to ensure that your data center environment provides optimal conditions for your server operation.

Temperature and humidity recording instruments

Temperature and humidity recording instruments should be installed to provide a continuous record of the environmental conditions.

Direct-reading instruments with seven-day charts are suggested to monitor the ambient room conditions. Any under-floor air conditioning supply should also be monitored.

Monitoring provides the ability to:

- Assure the air conditioning system is continuously performing as designed.
- Determine whether a mandatory drying-out period is necessary when the humidity limitations are exceeded. The duration of the drying-out period is determined by the extent and duration of excess humidity.
- Determine whether a mandatory warm-up period is necessary when the building temperature has dropped below server operating specifications during off-shift hours.

A visual or audible signal should be incorporated with the recording instrument to alert personnel that ambient conditions are approaching the maximum limitations.

Vibration and shock

Use this information to plan for possible vibration and shock in your data center.

It might be necessary to install the information technology equipment in an area subject to minor vibrations. The following information supplies vibration and shock limits for your equipment and some basic definitions concerning vibration. The vibration levels normally present in computer-room and industrial installations are well within the indicated levels.

However, mounting the equipment in racks, stackers, or similar equipment might increase the risks of vibration-related problems. It is important to consult the manufacturer of such equipment to ensure that vibration factors will not exceed the specifications provided in the following tables.

Some useful definitions of vibration include:

Acceleration:

Normally measured in g multiples of the acceleration because of the force of gravity. If the frequency is also known for a sine wave, acceleration can be calculated from displacement. is the unit of acceleration caused by the force of gravity.

Continuous:

Vibrations present over an extended period and cause a sustained resonant response in the equipment.

Displacement:

Magnitude of the wave shape; normally given in peak-to-peak displacement in English or metric units:

- Normally used to measure floor vibrations at low frequencies
- If the frequency is also known, it can be converted to displacement g for a sine wave.

Note: Many measuring instruments can convert displacement to g for either sinusoidal or complex wave shapes.

Peak: The maximum value of a sinusoidal or random vibration. This can be expressed as peak-to-peak in cases of sinusoidal vibration displacement.

Random:

A complex vibration wave form varying in amplitude and frequency content.

rms (root mean square):

The long-term average of the acceleration or amplitude values. Normally used as a measure of overall vibration for random vibration.

Shock:

Intermittent inputs that occur and then decay to zero prior to a recurrence of the event. Typical examples are foot traffic, fork lifts in aisles, and external events such as railroad, highway traffic, or construction activities (including blasting).

Sinusoidal:

Vibrations with the characteristic shape of the classical sine wave (for example, 60-Hz ac power).

Transient:

Vibrations that are intermittent and do not cause a sustained resonant response in the equipment.

If you need to make any calculations or require information regarding the above definitions, consult a mechanical engineer, a vibration consulting engineer, or your seller.

The three classes of a vibration environment are shown in the following table.

Table 20. Vibration environment

Class	Vibration environment
V1	Floor-mounted machines in an office environment
V2	Table-top and wall-mounted machines
V3	Heavy industrial and mobile equipment

A summary of the vibration limits for each of the three classes is shown in the following table. A legend follows the table.

Note: Vibration levels at any discrete frequency should not exceed a level of 1/2 the g rms values for the class listed in the Operational vibration and shock limits table.

Table 21. Operational vibration and shock limits

Class	g rms	g peak	Mils	Shock
V1 L	0.10	0.30	3.4	3 g at 3 ms
V1 H	0.05	0.15	1.7	3 g at 3 ms
V2	0.10	0.30	3.4	3 g at 3 ms
V3	0.27	0.80	9.4	application dependent

L: Light, weight less than 600 kg (1322.8 lb).

H: Heavy, weight equal to or greater than 600 kg (1322.8 lb).

g rms: Overall average g level over the 5 to 500 Hz frequency range.

g peak:

Maximum real-time instantaneous peak value of the vibration time history wave form (excluding events defined as shocks).

Mils: Peak-to-peak displacement of a discrete frequency in the 5 to 17 Hz range. One mil equal .001 inch.

Shock:

Amplitude and pulse width of a classical 1/2 sine shock pulse.

The values given in the Operational vibration and shock limits table are based on worst-case field data measured at customer installations for current and previously released products. The vibration and shock environment will not exceed these values except for abnormal cases involving earthquakes or direct impacts. Your seller can contact the IBM Standards Authority for Vibration and Shock in case of specific technical questions.

Earthquakes

Special frame-strengthening features or RPQs might be required in earthquake prone areas. Local codes might require the information technology equipment to be tied down to the concrete floor. If sufficient information on equipment tie down is not provided in the product's physical planning documentation, consult with your seller.

Voltage and frequency limits

Voltage and frequency limits must be maintained to ensure proper functioning of your server.

The phase-to-phase steady-state voltage must be maintained within plus six percent to minus 10 percent of the normal rated voltage, measured at the receptacle when the system is operating. A voltage surge or sag condition must not exceed plus 15 percent or minus 18 percent of the nominal voltage and must return to within a steady-state tolerance of plus 6 percent or minus 10 percent of normal rated voltage within 0.5 second.

Some servers might require special considerations and might have more or less restrictive specifications. See the individual server specifications for actual requirements. Because of the possibility of brownouts (planned voltage reduction by the utility company) or other marginal voltage conditions, installing a voltage monitor might be advisable.

The phase frequency must be maintained at 50 or 60 Hz + 0.5 Hz.

The value of any of the three phase-to-phase equipment voltages in the three-phase system must not differ by more than 2.5 percent from the arithmetic average of the three voltages. All three line-to-line voltages must be within the limits specified above.

The maximum total harmonic content of the power system voltage waveforms on the equipment feeder must not exceed 5 percent with the equipment operating.

Notices

This information was developed for products and services offered in the US.

IBM may not offer the products, services, or features discussed in this document in other countries. Consult your local IBM representative for information on the products and services currently available in your area. Any reference to an IBM product, program, or service is not intended to state or imply that only that IBM product, program, or service may be used. Any functionally equivalent product, program, or service that does not infringe any IBM intellectual property right may be used instead. However, it is the user's responsibility to evaluate and verify the operation of any non-IBM product, program, or service.

IBM may have patents or pending patent applications covering subject matter described in this document. The furnishing of this document does not grant you any license to these patents. You can send license inquiries, in writing, to:

*IBM Director of Licensing
IBM Corporation
North Castle Drive, MD-NC119
Armonk, NY 10504-1785
US*

INTERNATIONAL BUSINESS MACHINES CORPORATION PROVIDES THIS PUBLICATION "AS IS" WITHOUT WARRANTY OF ANY KIND, EITHER EXPRESS OR IMPLIED, INCLUDING, BUT NOT LIMITED TO, THE IMPLIED WARRANTIES OF NON-INFRINGEMENT, MERCHANTABILITY OR FITNESS FOR A PARTICULAR PURPOSE. Some jurisdictions do not allow disclaimer of express or implied warranties in certain transactions, therefore, this statement may not apply to you.

This information could include technical inaccuracies or typographical errors. Changes are periodically made to the information herein; these changes will be incorporated in new editions of the publication. IBM may make improvements and/or changes in the product(s) and/or the program(s) described in this publication at any time without notice.

Any references in this information to non-IBM websites are provided for convenience only and do not in any manner serve as an endorsement of those websites. The materials at those websites are not part of the materials for this IBM product and use of those websites is at your own risk.

IBM may use or distribute any of the information you provide in any way it believes appropriate without incurring any obligation to you.

The performance data and client examples cited are presented for illustrative purposes only. Actual performance results may vary depending on specific configurations and operating conditions.

Information concerning non-IBM products was obtained from the suppliers of those products, their published announcements or other publicly available sources. IBM has not tested those products and cannot confirm the accuracy of performance, compatibility or any other claims related to non-IBM products. Questions on the capabilities of non-IBM products should be addressed to the suppliers of those products.

Statements regarding IBM's future direction or intent are subject to change or withdrawal without notice, and represent goals and objectives only.

All IBM prices shown are IBM's suggested retail prices, are current and are subject to change without notice. Dealer prices may vary.

This information is for planning purposes only. The information herein is subject to change before the products described become available.

This information contains examples of data and reports used in daily business operations. To illustrate them as completely as possible, the examples include the names of individuals, companies, brands, and products. All of these names are fictitious and any similarity to actual people or business enterprises is entirely coincidental.

If you are viewing this information in softcopy, the photographs and color illustrations may not appear.

The drawings and specifications contained herein shall not be reproduced in whole or in part without the written permission of IBM.

IBM has prepared this information for use with the specific machines indicated. IBM makes no representations that it is suitable for any other purpose.

IBM's computer systems contain mechanisms designed to reduce the possibility of undetected data corruption or loss. This risk, however, cannot be eliminated. Users who experience unplanned outages, system failures, power fluctuations or outages, or component failures must verify the accuracy of operations performed and data saved or transmitted by the system at or near the time of the outage or failure. In addition, users must establish procedures to ensure that there is independent data verification before relying on such data in sensitive or critical operations. Users should periodically check IBM's support websites for updated information and fixes applicable to the system and related software.

Homologation statement

This product may not be certified in your country for connection by any means whatsoever to interfaces of public telecommunications networks. Further certification may be required by law prior to making any such connection. Contact an IBM representative or reseller for any questions.

Accessibility features for IBM Power Systems servers

Accessibility features assist users who have a disability, such as restricted mobility or limited vision, to use information technology content successfully.

Overview

The IBM Power Systems servers include the following major accessibility features:

- Keyboard-only operation
- Operations that use a screen reader

The IBM Power Systems servers use the latest W3C Standard, WAI-ARIA 1.0 (www.w3.org/TR/wai-aria/), to ensure compliance with US Section 508 (www.access-board.gov/guidelines-and-standards/communications-and-it/about-the-section-508-standards/section-508-standards) and Web Content Accessibility Guidelines (WCAG) 2.0 (www.w3.org/TR/WCAG20/). To take advantage of accessibility features, use the latest release of your screen reader and the latest web browser that is supported by the IBM Power Systems servers.

The IBM Power Systems servers online product documentation in IBM Knowledge Center is enabled for accessibility. The accessibility features of IBM Knowledge Center are described in the Accessibility section of the IBM Knowledge Center help (www.ibm.com/support/knowledgcenter/doc/kc_help.html#accessibility).

Keyboard navigation

This product uses standard navigation keys.

Interface information

The IBM Power Systems servers user interfaces do not have content that flashes 2 - 55 times per second.

The IBM Power Systems servers web user interface relies on cascading style sheets to render content properly and to provide a usable experience. The application provides an equivalent way for low-vision users to use system display settings, including high-contrast mode. You can control font size by using the device or web browser settings.

The IBM Power Systems servers web user interface includes WAI-ARIA navigational landmarks that you can use to quickly navigate to functional areas in the application.

Vendor software

The IBM Power Systems servers include certain vendor software that is not covered under the IBM license agreement. IBM makes no representation about the accessibility features of these products. Contact the vendor for accessibility information about its products.

Related accessibility information

In addition to standard IBM help desk and support websites, IBM has a TTY telephone service for use by deaf or hard of hearing customers to access sales and support services:

TTY service
800-IBM-3383 (800-426-3383)
(within North America)

For more information about the commitment that IBM has to accessibility, see IBM Accessibility (www.ibm.com/able).

Privacy policy considerations

IBM Software products, including software as a service solutions, (“Software Offerings”) may use cookies or other technologies to collect product usage information, to help improve the end user experience, to tailor interactions with the end user, or for other purposes. In many cases no personally identifiable information is collected by the Software Offerings. Some of our Software Offerings can help enable you to collect personally identifiable information. If this Software Offering uses cookies to collect personally identifiable information, specific information about this offering’s use of cookies is set forth below.

This Software Offering does not use cookies or other technologies to collect personally identifiable information.

If the configurations deployed for this Software Offering provide you as the customer the ability to collect personally identifiable information from end users via cookies and other technologies, you should seek your own legal advice about any laws applicable to such data collection, including any requirements for notice and consent.

For more information about the use of various technologies, including cookies, for these purposes, see IBM’s Privacy Policy at <http://www.ibm.com/privacy> and IBM’s Online Privacy Statement at <http://www.ibm.com/privacy/details> the section entitled “Cookies, Web Beacons and Other Technologies” and the “IBM Software Products and Software-as-a-Service Privacy Statement” at <http://www.ibm.com/software/info/product-privacy>.

Trademarks

IBM, the IBM logo, and ibm.com are trademarks or registered trademarks of International Business Machines Corp., registered in many jurisdictions worldwide. Other product and service names might be trademarks of IBM or other companies. A current list of IBM trademarks is available on the web at Copyright and trademark information at www.ibm.com/legal/copytrade.shtml.

INFINIBAND, InfiniBand Trade Association, and the INFINIBAND design marks are trademarks and/or service marks of the INFINIBAND Trade Association.

Electronic emission notices

When attaching a monitor to the equipment, you must use the designated monitor cable and any interference suppression devices supplied with the monitor.

Class A Notices

The following Class A statements apply to the IBM servers that contain the POWER8[®] processor and its features unless designated as electromagnetic compatibility (EMC) Class B in the feature information.

Federal Communications Commission (FCC) Statement

Note: This equipment has been tested and found to comply with the limits for a Class A digital device, pursuant to Part 15 of the FCC Rules. These limits are designed to provide reasonable protection against harmful interference when the equipment is operated in a commercial environment. This equipment generates, uses, and can radiate radio frequency energy and, if not installed and used in accordance with the instruction manual, may cause harmful interference to radio communications. Operation of this equipment in a residential area is likely to cause harmful interference, in which case the user will be required to correct the interference at his own expense.

Properly shielded and grounded cables and connectors must be used in order to meet FCC emission limits. IBM is not responsible for any radio or television interference caused by using other than recommended cables and connectors or by unauthorized changes or modifications to this equipment. Unauthorized changes or modifications could void the user's authority to operate the equipment.

This device complies with Part 15 of the FCC rules. Operation is subject to the following two conditions: (1) this device may not cause harmful interference, and (2) this device must accept any interference received, including interference that may cause undesired operation.

Industry Canada Compliance Statement

This Class A digital apparatus complies with Canadian ICES-003.

Avis de conformité à la réglementation d'Industrie Canada

Cet appareil numérique de la classe A est conforme à la norme NMB-003 du Canada.

European Community Compliance Statement

This product is in conformity with the protection requirements of EU Council Directive 2004/108/EC on the approximation of the laws of the Member States relating to electromagnetic compatibility. IBM cannot accept responsibility for any failure to satisfy the protection requirements resulting from a non-recommended modification of the product, including the fitting of non-IBM option cards.

This product has been tested and found to comply with the limits for Class A Information Technology Equipment according to European Standard EN 55022. The limits for Class A equipment were derived for commercial and industrial environments to provide reasonable protection against interference with licensed communication equipment.

European Community contact:
IBM Deutschland GmbH
Technical Regulations, Department M372
IBM-Allee 1, 71139 Ehningen, Germany
Tele: +49 (0) 800 225 5423 or +49 (0) 180 331 3233
email: halloibm@de.ibm.com

Warning: This is a Class A product. In a domestic environment, this product may cause radio interference, in which case the user may be required to take adequate measures.

VCCI Statement - Japan

この装置は、クラスA情報技術装置です。この装置を家庭環境で使用すると電波妨害を引き起こすことがあります。この場合には使用者が適切な対策を講ずるよう要求されることがあります。 VCCI-A

The following is a summary of the VCCI Japanese statement in the box above:

This is a Class A product based on the standard of the VCCI Council. If this equipment is used in a domestic environment, radio interference may occur, in which case, the user may be required to take corrective actions.

Japan Electronics and Information Technology Industries Association Statement

This statement explains the Japan JIS C 61000-3-2 product wattage compliance.

(一社) 電子情報技術産業協会 高調波電流抑制対策実施
要領に基づく定格入力電力値： Knowledge Centerの各製品の
仕様ページ参照

This statement explains the Japan Electronics and Information Technology Industries Association (JEITA) statement for products less than or equal to 20 A per phase.

高調波電流規格 JIS C 61000-3-2 適合品

This statement explains the JEITA statement for products greater than 20 A, single phase.

高調波電流規格 JIS C 61000-3-2 準用品

本装置は、「高圧又は特別高圧で受電する需要家の高調波抑制対策ガイドライン」対象機器（高調波発生機器）です。

- 回路分類 : 6 (単相、PFC回路付)
- 換算係数 : 0

This statement explains the JEITA statement for products greater than 20 A per phase, three-phase.

高調波電流規格 JIS C 61000-3-2 準用品

本装置は、「高圧又は特別高圧で受電する需要家の高調波抑制対策ガイドライン」対象機器（高調波発生機器）です。

- 回路分類 : 5 (3相、PFC回路付)
- 換算係数 : 0

Electromagnetic Interference (EMI) Statement - People's Republic of China

声 明

此为 A 级产品,在生活环境中,该产品可能会造成无线电干扰。在这种情况下,可能需要用户对其干扰采取切实可行的措施。

Declaration: This is a Class A product. In a domestic environment this product may cause radio interference in which case the user may need to perform practical action.

Electromagnetic Interference (EMI) Statement - Taiwan

警告使用者：

這是甲類的資訊產品，在居住的環境中使用時，可能會造成射頻干擾，在這種情況下，使用者會被要求採取某些適當的對策。

The following is a summary of the EMI Taiwan statement above.

Warning: This is a Class A product. In a domestic environment this product may cause radio interference in which case the user will be required to take adequate measures.

IBM Taiwan Contact Information:

台灣IBM 產品服務聯絡方式：
台灣國際商業機器股份有限公司
台北市松仁路7號3樓
電話：0800-016-888

Electromagnetic Interference (EMI) Statement - Korea

이 기기는 업무용(A급)으로 전자파적합기기로서 판매자 또는 사용자는 이 점을 주의하시기 바라며, 가정외의 지역에서 사용하는 것을 목적으로 합니다.

Germany Compliance Statement

Deutschsprachiger EU Hinweis: Hinweis für Geräte der Klasse A EU-Richtlinie zur Elektromagnetischen Verträglichkeit

Dieses Produkt entspricht den Schutzanforderungen der EU-Richtlinie 2004/108/EG zur Angleichung der Rechtsvorschriften über die elektromagnetische Verträglichkeit in den EU-Mitgliedsstaaten und hält die Grenzwerte der EN 55022 Klasse A ein.

Um dieses sicherzustellen, sind die Geräte wie in den Handbüchern beschrieben zu installieren und zu betreiben. Des Weiteren dürfen auch nur von der IBM empfohlene Kabel angeschlossen werden. IBM übernimmt keine Verantwortung für die Einhaltung der Schutzanforderungen, wenn das Produkt ohne Zustimmung von IBM verändert bzw. wenn Erweiterungskomponenten von Fremdherstellern ohne Empfehlung von IBM gesteckt/eingebaut werden.

EN 55022 Klasse A Geräte müssen mit folgendem Warnhinweis versehen werden:

"Warnung: Dieses ist eine Einrichtung der Klasse A. Diese Einrichtung kann im Wohnbereich Funk-Störungen verursachen; in diesem Fall kann vom Betreiber verlangt werden, angemessene Maßnahmen zu ergreifen und dafür aufzukommen."

Deutschland: Einhaltung des Gesetzes über die elektromagnetische Verträglichkeit von Geräten

Dieses Produkt entspricht dem "Gesetz über die elektromagnetische Verträglichkeit von Geräten (EMVG)". Dies ist die Umsetzung der EU-Richtlinie 2004/108/EG in der Bundesrepublik Deutschland.

Zulassungsbescheinigung laut dem Deutschen Gesetz über die elektromagnetische Verträglichkeit von Geräten (EMVG) (bzw. der EMC EG Richtlinie 2004/108/EG) für Geräte der Klasse A

Dieses Gerät ist berechtigt, in Übereinstimmung mit dem Deutschen EMVG das EG-Konformitätszeichen - CE - zu führen.

Verantwortlich für die Einhaltung der EMV Vorschriften ist der Hersteller:

International Business Machines Corp.

New Orchard Road

Armonk, New York 10504

Tel: 914-499-1900

Der verantwortliche Ansprechpartner des Herstellers in der EU ist:

IBM Deutschland GmbH

Technical Regulations, Abteilung M372

IBM-Allee 1, 71139 Ehningen, Germany

Tel: +49 (0) 800 225 5423 or +49 (0) 180 331 3233

email: halloibm@de.ibm.com

Generelle Informationen:

Das Gerät erfüllt die Schutzanforderungen nach EN 55024 und EN 55022 Klasse A.

Electromagnetic Interference (EMI) Statement - Russia

**ВНИМАНИЕ! Настоящее изделие относится к классу А.
В жилых помещениях оно может создавать
радиопомехи, для снижения которых необходимы
дополнительные меры**

Class B Notices

The following Class B statements apply to features designated as electromagnetic compatibility (EMC) Class B in the feature installation information.

Federal Communications Commission (FCC) Statement

This equipment has been tested and found to comply with the limits for a Class B digital device, pursuant to Part 15 of the FCC Rules. These limits are designed to provide reasonable protection against harmful interference in a residential installation.

This equipment generates, uses, and can radiate radio frequency energy and, if not installed and used in accordance with the instructions, may cause harmful interference to radio communications. However, there is no guarantee that interference will not occur in a particular installation.

If this equipment does cause harmful interference to radio or television reception, which can be determined by turning the equipment off and on, the user is encouraged to try to correct the interference by one or more of the following measures:

- Reorient or relocate the receiving antenna.
- Increase the separation between the equipment and receiver.
- Connect the equipment into an outlet on a circuit different from that to which the receiver is connected.
- Consult an IBM-authorized dealer or service representative for help.

Properly shielded and grounded cables and connectors must be used in order to meet FCC emission limits. Proper cables and connectors are available from IBM-authorized dealers. IBM is not responsible for any radio or television interference caused by unauthorized changes or modifications to this equipment. Unauthorized changes or modifications could void the user's authority to operate this equipment.

This device complies with Part 15 of the FCC rules. Operation is subject to the following two conditions: (1) this device may not cause harmful interference, and (2) this device must accept any interference received, including interference that may cause undesired operation.

Industry Canada Compliance Statement

This Class B digital apparatus complies with Canadian ICES-003.

Avis de conformité à la réglementation d'Industrie Canada

Cet appareil numérique de la classe B est conforme à la norme NMB-003 du Canada.

European Community Compliance Statement

This product is in conformity with the protection requirements of EU Council Directive 2004/108/EC on the approximation of the laws of the Member States relating to electromagnetic compatibility. IBM cannot accept responsibility for any failure to satisfy the protection requirements resulting from a non-recommended modification of the product, including the fitting of non-IBM option cards.

This product has been tested and found to comply with the limits for Class B Information Technology Equipment according to European Standard EN 55022. The limits for Class B equipment were derived for typical residential environments to provide reasonable protection against interference with licensed communication equipment.

European Community contact:
IBM Deutschland GmbH
Technical Regulations, Department M372
IBM-Allee 1, 71139 Ehningen, Germany
Tele: +49 (0) 800 225 5423 or +49 (0) 180 331 3233
email: halloibm@de.ibm.com

VCCI Statement - Japan

この装置は、クラスB情報技術装置です。この装置は、家庭環境で使用することを目的としていますが、この装置がラジオやテレビジョン受信機に近接して使用されると、受信障害を引き起こすことがあります。

取扱説明書に従って正しい取り扱いをして下さい。 VCCI-B

Japan Electronics and Information Technology Industries Association Statement

This statement explains the Japan JIS C 61000-3-2 product wattage compliance.

(一社) 電子情報技術産業協会 高調波電流抑制対策実施
要領に基づく定格入力電力値： Knowledge Centerの各製品の
仕様ページ参照

This statement explains the Japan Electronics and Information Technology Industries Association (JEITA) statement for products less than or equal to 20 A per phase.

高調波電流規格 JIS C 61000-3-2 適合品

This statement explains the JEITA statement for products greater than 20 A, single phase.

高調波電流規格 JIS C 61000-3-2 準用品

本装置は、「高圧又は特別高圧で受電する需要家の高調波抑制対策ガイドライン」対象機器（高調波発生機器）です。

- 回路分類：6（単相、PFC回路付）
- 換算係数：0

This statement explains the JEITA statement for products greater than 20 A per phase, three-phase.

高調波電流規格 JIS C 61000-3-2 準用品

本装置は、「高圧又は特別高圧で受電する需要家の高調波抑制対策ガイドライン」対象機器（高調波発生機器）です。

- 回路分類：5（3相、PFC回路付）
- 換算係数：0

IBM Taiwan Contact Information

台灣IBM 產品服務聯絡方式：
台灣國際商業機器股份有限公司
台北市松仁路7號3樓
電話：0800-016-888

Electromagnetic Interference (EMI) Statement - Korea

이 기기는 가정용(B급)으로 전자과적합기기로
서 주로 가정에서 사용하는 것을 목적으로 하
며, 모든 지역에서 사용할 수 있습니다.

Germany Compliance Statement

Deutschsprachiger EU Hinweis: Hinweis für Geräte der Klasse B EU-Richtlinie zur Elektromagnetischen Verträglichkeit

Dieses Produkt entspricht den Schutzanforderungen der EU-Richtlinie 2004/108/EG zur Angleichung der Rechtsvorschriften über die elektromagnetische Verträglichkeit in den EU-Mitgliedsstaaten und hält die Grenzwerte der EN 55022 Klasse B ein.

Um dieses sicherzustellen, sind die Geräte wie in den Handbüchern beschrieben zu installieren und zu betreiben. Des Weiteren dürfen auch nur von der IBM empfohlene Kabel angeschlossen werden. IBM übernimmt keine Verantwortung für die Einhaltung der Schutzanforderungen, wenn das Produkt ohne Zustimmung von IBM verändert bzw. wenn Erweiterungskomponenten von Fremdherstellern ohne Empfehlung von IBM gesteckt/eingebaut werden.

Deutschland: Einhaltung des Gesetzes über die elektromagnetische Verträglichkeit von Geräten

Dieses Produkt entspricht dem "Gesetz über die elektromagnetische Verträglichkeit von Geräten (EMVG)". Dies ist die Umsetzung der EU-Richtlinie 2004/108/EG in der Bundesrepublik Deutschland.

Zulassungsbescheinigung laut dem Deutschen Gesetz über die elektromagnetische Verträglichkeit von Geräten (EMVG) (bzw. der EMC EG Richtlinie 2004/108/EG) für Geräte der Klasse B

Dieses Gerät ist berechtigt, in Übereinstimmung mit dem Deutschen EMVG das EG-Konformitätszeichen - CE - zu führen.

Verantwortlich für die Einhaltung der EMV Vorschriften ist der Hersteller:
International Business Machines Corp.
New Orchard Road
Armonk, New York 10504
Tel: 914-499-1900

Der verantwortliche Ansprechpartner des Herstellers in der EU ist:
IBM Deutschland GmbH
Technical Regulations, Abteilung M372
IBM-Allee 1, 71139 Ehningen, Germany
Tel: +49 (0) 800 225 5423 or +49 (0) 180 331 3233
email: halloibm@de.ibm.com

Generelle Informationen:

Das Gerät erfüllt die Schutzanforderungen nach EN 55024 und EN 55022 Klasse B.

Terms and conditions

Permissions for the use of these publications are granted subject to the following terms and conditions.

Applicability: These terms and conditions are in addition to any terms of use for the IBM website.

Personal Use: You may reproduce these publications for your personal, noncommercial use provided that all proprietary notices are preserved. You may not distribute, display or make derivative works of these publications, or any portion thereof, without the express consent of IBM.

Commercial Use: You may reproduce, distribute and display these publications solely within your enterprise provided that all proprietary notices are preserved. You may not make derivative works of these publications, or reproduce, distribute or display these publications or any portion thereof outside your enterprise, without the express consent of IBM.

Rights: Except as expressly granted in this permission, no other permissions, licenses or rights are granted, either express or implied, to the publications or any information, data, software or other intellectual property contained therein.

IBM reserves the right to withdraw the permissions granted herein whenever, in its discretion, the use of the publications is detrimental to its interest or, as determined by IBM, the above instructions are not being properly followed.

You may not download, export or re-export this information except in full compliance with all applicable laws and regulations, including all United States export laws and regulations.

IBM MAKES NO GUARANTEE ABOUT THE CONTENT OF THESE PUBLICATIONS. THE PUBLICATIONS ARE PROVIDED "AS-IS" AND WITHOUT WARRANTY OF ANY KIND, EITHER EXPRESSED OR IMPLIED, INCLUDING BUT NOT LIMITED TO IMPLIED WARRANTIES OF MERCHANTABILITY, NON-INFRINGEMENT, AND FITNESS FOR A PARTICULAR PURPOSE.



Printed in USA