

Power Systems

*Site and hardware planning*

**IBM**



Power Systems

*Site and hardware planning*

**IBM**

**Note**

Before using this information and the product it supports, read the information in "Safety notices" on page vii, "Notices" on page 201, the *IBM Systems Safety Notices* manual, G229-9054, and the *IBM Environmental Notices and User Guide*, Z125-5823.

This edition applies to IBM Power Systems servers that contain the POWER7 processor and to all associated models.

© Copyright IBM Corporation 2010, 2013.

US Government Users Restricted Rights – Use, duplication or disclosure restricted by GSA ADP Schedule Contract with IBM Corp.

---

# Contents

<b>Safety notices</b>	<b>vii</b>
<b>Site and hardware physical planning overview</b>	<b>1</b>
<b>What's new in Site and hardware planning</b>	<b>3</b>
<b>Planning activities</b>	<b>5</b>
Planning task checklist	5
General considerations	5
Site preparation and physical planning guidelines	6
<b>Hardware specification sheets</b>	<b>9</b>
Server specifications	9
Model 8202-E4B, 8202-E4C, 8202-E4D, 8205-E6B, 8205-E6C, and 8205-E6D server specifications	9
8205-E6B ENERGY STAR Power and Performance Data Sheet	15
8205-E6C ENERGY STAR Power and Performance Data Sheet	18
Power 720 Express (Machine Type: 8202) Technical Documentation for EU Regulation 617/2013	21
Power 740 Express (Machine Type: 8205) Technical Documentation for EU Regulation 617/2013	22
Plan view for model 8202-E4B, 8202-E4C, 8202-E4D, 8205-E6B, 8205-E6C, and 8205-E6D	24
Expansion unit and migration tower specifications	24
5786 expansion unit	24
5796 expansion unit	26
5802 expansion unit	27
5877 expansion unit	28
5886 expansion unit	29
5887 expansion unit	30
5888 expansion unit	31
EDR1 expansion unit	32
Rack specifications	33
0550 model 9406-830 rack	33
0551 rack	35
0551, 0553, 0555, and 7014 rack configurations	37
0551 model 9406-270 rack system units	44
Model 0554 and 7014-S11 rack	46
Model 0555 and 7014-S25 rack	48
Planning for the 7014-T00 and 7014-T42 racks	52
Model 7014-T00 rack	52
Model 7014-T42, 7014-B42, and 0553 rack	54
7014-T00, 7014-T42, and 0553 service clearances and caster location	56
7014-T00, 7014-T00, and 0553 racks multiple attachment	57
7014-T00, 7014-T42, and 0553 rack weight distribution and floor loading	58
Planning for the 7953-94X and 7965-94Y rack	59
Model 7953-94X and 7965-94Y rack	59
Cabling the 7953-94X and 7965-94Y rack	61
Side stabilizing outriggers	63
Multiple racks	64
Model 1164-95X rear door heat exchanger	65
Hardware Management Console specifications	67
7042-C07 desktop Hardware Management Console specifications	67
7042-C08 Hardware Management Console specifications	68
7042-CR7 Hardware Management Console specifications	69
Systems Director Management Console specifications	70
7042-CR6 rack-mounted Systems Director Management Console specifications	70
Rack switch specifications	71

G8052R RackSwitch specification sheet . . . . .	71
G8124ER RackSwitch specification sheet . . . . .	71
G8264R RackSwitch specification sheet . . . . .	72
G8316R RackSwitch specification sheet . . . . .	73
Rack installation specifications for racks not purchased from IBM . . . . .	73

**Planning for power . . . . . 81**

Determining your power requirements . . . . .	81
Server Information Form 3A . . . . .	82
Workstation Information Form 3B . . . . .	83
Plugs and receptacles . . . . .	83
Connecting your server to a country specific receptacle . . . . .	84
Supported feature codes . . . . .	84
Internationally available . . . . .	87
Cord feature code 6489 . . . . .	87
Cord feature code 6491 . . . . .	88
Cord feature code 6653 . . . . .	89
Cord feature code 6656 . . . . .	89
Anguilla . . . . .	90
Cord feature code 6460 . . . . .	90
Antigua and Barbuda . . . . .	91
Cord feature code 6469 . . . . .	91
Australia . . . . .	92
Cord feature code 6657 . . . . .	92
Brazil . . . . .	93
Cord feature code 6471 . . . . .	94
Bulgaria . . . . .	94
Cord feature code 6472 . . . . .	95
Canada . . . . .	96
Cord feature code 6492 . . . . .	96
Cord feature code 6497 . . . . .	96
Cord feature code 6654 . . . . .	97
Cord feature code 6655 . . . . .	98
Chile . . . . .	99
Cord feature code 6478 . . . . .	99
Cord feature code 6672 . . . . .	100
China . . . . .	101
Cord feature code 6493 . . . . .	101
Denmark . . . . .	102
Cord feature code 6473 . . . . .	103
Dominica . . . . .	104
Cord feature code 6474 . . . . .	104
Italy . . . . .	105
Cord feature code 6672 . . . . .	105
Great Britain . . . . .	105
Cord feature code 6458 . . . . .	106
Cord feature code 6474 . . . . .	106
Cord feature code 6477 . . . . .	107
Cord feature code 6577 . . . . .	108
Cord feature code 6665 . . . . .	109
Cord feature code 6671 . . . . .	110
Cord feature code 6672 . . . . .	111
Israel . . . . .	111
Cord feature code 6475 . . . . .	111
Japan . . . . .	112
Cord feature code 6487 . . . . .	112
Cord feature code 6660 . . . . .	113
Liechtenstein . . . . .	114
Cord feature code 6476 . . . . .	114
Macao . . . . .	115
Cord feature code 6477 . . . . .	115

Paraguay . . . . .	116
Cord feature code 6488 . . . . .	116
India . . . . .	118
Cord feature code 6494 . . . . .	118
Kiribati . . . . .	118
Cord feature code 6680 . . . . .	118
Korea . . . . .	119
Cord feature code 6496 . . . . .	119
Cord feature code 6658 . . . . .	120
New Zealand . . . . .	121
Cord feature code 6657 . . . . .	121
Taiwan . . . . .	122
Cord feature code 6651 . . . . .	122
Cord feature code 6659 . . . . .	123
United States, territories, and possessions . . . . .	124
Cord feature code 6492 . . . . .	124
Cord feature code 6497 . . . . .	125
Cord feature code 6654 . . . . .	126
Cord feature code RPQ 8A1871 . . . . .	127
Connecting your server to a PDU . . . . .	128
Cord feature code 6458 . . . . .	128
Cord feature code 6459 . . . . .	129
Cord feature code 6577 . . . . .	130
Cord feature code 6665 . . . . .	130
Cord feature code 6671 . . . . .	131
Cord feature code 6672 . . . . .	132
Modification of IBM-provided power cords . . . . .	132
Uninterruptible power supply . . . . .	133
Power distribution unit and power cord options for 7014, 0551, 0553, and 0555 racks . . . . .	138
Calculating the power load for 7188 or 9188 power distribution units . . . . .	144
<b>Planning for cables . . . . .</b>	<b>147</b>
Cable management . . . . .	147
Power cord routing and retention . . . . .	148
Planning for serial-attached SCSI cables . . . . .	149
SAS cabling for the 5887 drawer . . . . .	175
<b>Rack installation specifications for racks not purchased from IBM . . . . .</b>	<b>193</b>
<b>Notices . . . . .</b>	<b>201</b>
Trademarks . . . . .	202
Electronic emission notices . . . . .	202
Class A Notices. . . . .	202
Class B Notices. . . . .	206
Terms and conditions. . . . .	209





---

## Safety notices

Safety notices may be printed throughout this guide:

- **DANGER** notices call attention to a situation that is potentially lethal or extremely hazardous to people.
- **CAUTION** notices call attention to a situation that is potentially hazardous to people because of some existing condition.
- **Attention** notices call attention to the possibility of damage to a program, device, system, or data.

### World Trade safety information

Several countries require the safety information contained in product publications to be presented in their national languages. If this requirement applies to your country, safety information documentation is included in the publications package (such as in printed documentation, on DVD, or as part of the product) shipped with the product. The documentation contains the safety information in your national language with references to the U.S. English source. Before using a U.S. English publication to install, operate, or service this product, you must first become familiar with the related safety information documentation. You should also refer to the safety information documentation any time you do not clearly understand any safety information in the U.S. English publications.

Replacement or additional copies of safety information documentation can be obtained by calling the IBM Hotline at 1-800-300-8751.

### German safety information

Das Produkt ist nicht für den Einsatz an Bildschirmarbeitsplätzen im Sinne § 2 der Bildschirmarbeitsverordnung geeignet.

### Laser safety information

IBM® servers can use I/O cards or features that are fiber-optic based and that utilize lasers or LEDs.

#### Laser compliance

IBM servers may be installed inside or outside of an IT equipment rack.

## DANGER

When working on or around the system, observe the following precautions:

Electrical voltage and current from power, telephone, and communication cables are hazardous. To avoid a shock hazard:

- Connect power to this unit only with the IBM provided power cord. Do not use the IBM provided power cord for any other product.
- Do not open or service any power supply assembly.
- Do not connect or disconnect any cables or perform installation, maintenance, or reconfiguration of this product during an electrical storm.
- The product might be equipped with multiple power cords. To remove all hazardous voltages, disconnect all power cords.
- Connect all power cords to a properly wired and grounded electrical outlet. Ensure that the outlet supplies proper voltage and phase rotation according to the system rating plate.
- Connect any equipment that will be attached to this product to properly wired outlets.
- When possible, use one hand only to connect or disconnect signal cables.
- Never turn on any equipment when there is evidence of fire, water, or structural damage.
- Disconnect the attached power cords, telecommunications systems, networks, and modems before you open the device covers, unless instructed otherwise in the installation and configuration procedures.
- Connect and disconnect cables as described in the following procedures when installing, moving, or opening covers on this product or attached devices.

To Disconnect:

1. Turn off everything (unless instructed otherwise).
2. Remove the power cords from the outlets.
3. Remove the signal cables from the connectors.
4. Remove all cables from the devices.

To Connect:

1. Turn off everything (unless instructed otherwise).
2. Attach all cables to the devices.
3. Attach the signal cables to the connectors.
4. Attach the power cords to the outlets.
5. Turn on the devices.

(D005)

## DANGER

Observe the following precautions when working on or around your IT rack system:

- Heavy equipment—personal injury or equipment damage might result if mishandled.
- Always lower the leveling pads on the rack cabinet.
- Always install stabilizer brackets on the rack cabinet.
- To avoid hazardous conditions due to uneven mechanical loading, always install the heaviest devices in the bottom of the rack cabinet. Always install servers and optional devices starting from the bottom of the rack cabinet.
- Rack-mounted devices are not to be used as shelves or work spaces. Do not place objects on top of rack-mounted devices.



- Each rack cabinet might have more than one power cord. Be sure to disconnect all power cords in the rack cabinet when directed to disconnect power during servicing.
- Connect all devices installed in a rack cabinet to power devices installed in the same rack cabinet. Do not plug a power cord from a device installed in one rack cabinet into a power device installed in a different rack cabinet.
- An electrical outlet that is not correctly wired could place hazardous voltage on the metal parts of the system or the devices that attach to the system. It is the responsibility of the customer to ensure that the outlet is correctly wired and grounded to prevent an electrical shock.

#### CAUTION

- Do not install a unit in a rack where the internal rack ambient temperatures will exceed the manufacturer's recommended ambient temperature for all your rack-mounted devices.
- Do not install a unit in a rack where the air flow is compromised. Ensure that air flow is not blocked or reduced on any side, front, or back of a unit used for air flow through the unit.
- Consideration should be given to the connection of the equipment to the supply circuit so that overloading of the circuits does not compromise the supply wiring or overcurrent protection. To provide the correct power connection to a rack, refer to the rating labels located on the equipment in the rack to determine the total power requirement of the supply circuit.
- *(For sliding drawers.)* Do not pull out or install any drawer or feature if the rack stabilizer brackets are not attached to the rack. Do not pull out more than one drawer at a time. The rack might become unstable if you pull out more than one drawer at a time.
- *(For fixed drawers.)* This drawer is a fixed drawer and must not be moved for servicing unless specified by the manufacturer. Attempting to move the drawer partially or completely out of the rack might cause the rack to become unstable or cause the drawer to fall out of the rack.

(R001)

**CAUTION:**

Removing components from the upper positions in the rack cabinet improves rack stability during relocation. Follow these general guidelines whenever you relocate a populated rack cabinet within a room or building:

- Reduce the weight of the rack cabinet by removing equipment starting at the top of the rack cabinet. When possible, restore the rack cabinet to the configuration of the rack cabinet as you received it. If this configuration is not known, you must observe the following precautions:
  - Remove all devices in the 32U position and above.
  - Ensure that the heaviest devices are installed in the bottom of the rack cabinet.
  - Ensure that there are no empty U-levels between devices installed in the rack cabinet below the 32U level.
- If the rack cabinet you are relocating is part of a suite of rack cabinets, detach the rack cabinet from the suite.
- Inspect the route that you plan to take to eliminate potential hazards.
- Verify that the route that you choose can support the weight of the loaded rack cabinet. Refer to the documentation that comes with your rack cabinet for the weight of a loaded rack cabinet.
- Verify that all door openings are at least 760 x 230 mm (30 x 80 in.).
- Ensure that all devices, shelves, drawers, doors, and cables are secure.
- Ensure that the four leveling pads are raised to their highest position.
- Ensure that there is no stabilizer bracket installed on the rack cabinet during movement.
- Do not use a ramp inclined at more than 10 degrees.
- When the rack cabinet is in the new location, complete the following steps:
  - Lower the four leveling pads.
  - Install stabilizer brackets on the rack cabinet.
  - If you removed any devices from the rack cabinet, repopulate the rack cabinet from the lowest position to the highest position.
- If a long-distance relocation is required, restore the rack cabinet to the configuration of the rack cabinet as you received it. Pack the rack cabinet in the original packaging material, or equivalent. Also lower the leveling pads to raise the casters off of the pallet and bolt the rack cabinet to the pallet.

(R002)

(L001)



(L002)



(L003)

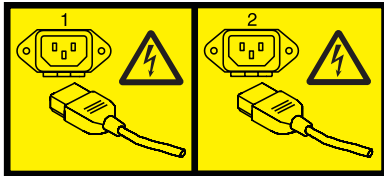

or



All lasers are certified in the U.S. to conform to the requirements of DHHS 21 CFR Subchapter J for class 1 laser products. Outside the U.S., they are certified to be in compliance with IEC 60825 as a class 1 laser product. Consult the label on each part for laser certification numbers and approval information.

**CAUTION:**

This product might contain one or more of the following devices: CD-ROM drive, DVD-ROM drive, DVD-RAM drive, or laser module, which are Class 1 laser products. Note the following information:

- Do not remove the covers. Removing the covers of the laser product could result in exposure to hazardous laser radiation. There are no serviceable parts inside the device.
- Use of the controls or adjustments or performance of procedures other than those specified herein might result in hazardous radiation exposure.

(C026)

**CAUTION:**

Data processing environments can contain equipment transmitting on system links with laser modules that operate at greater than Class 1 power levels. For this reason, never look into the end of an optical fiber cable or open receptacle. (C027)

**CAUTION:**

This product contains a Class 1M laser. Do not view directly with optical instruments. (C028)

**CAUTION:**

Some laser products contain an embedded Class 3A or Class 3B laser diode. Note the following information: laser radiation when open. Do not stare into the beam, do not view directly with optical instruments, and avoid direct exposure to the beam. (C030)

**CAUTION:**

The battery contains lithium. To avoid possible explosion, do not burn or charge the battery.

*Do Not:*

- \_\_\_ Throw or immerse into water
- \_\_\_ Heat to more than 100°C (212°F)
- \_\_\_ Repair or disassemble

Exchange only with the IBM-approved part. Recycle or discard the battery as instructed by local regulations. In the United States, IBM has a process for the collection of this battery. For information, call 1-800-426-4333. Have the IBM part number for the battery unit available when you call. (C003)

## **Power and cabling information for NEBS (Network Equipment-Building System) GR-1089-CORE**

The following comments apply to the IBM servers that have been designated as conforming to NEBS (Network Equipment-Building System) GR-1089-CORE:

The equipment is suitable for installation in the following:

- Network telecommunications facilities
- Locations where the NEC (National Electrical Code) applies

The intrabuilding ports of this equipment are suitable for connection to intrabuilding or unexposed wiring or cabling only. The intrabuilding ports of this equipment *must not* be metallically connected to the interfaces that connect to the OSP (outside plant) or its wiring. These interfaces are designed for use as intrabuilding interfaces only (Type 2 or Type 4 ports as described in GR-1089-CORE) and require isolation from the exposed OSP cabling. The addition of primary protectors is not sufficient protection to connect these interfaces metallically to OSP wiring.

**Note:** All Ethernet cables must be shielded and grounded at both ends.

The ac-powered system does not require the use of an external surge protection device (SPD).

The dc-powered system employs an isolated DC return (DC-I) design. The DC battery return terminal *shall not* be connected to the chassis or frame ground.

---

## Site and hardware physical planning overview

Successful installation requires effective planning of your physical and operational environment. You are the most valuable resource in site planning because you know where and how your system, and devices attached to it, will be used.

Site preparation for the complete system is the responsibility of the customer. The primary task of your site planner is to ensure that each system is installed so that it can operate and be serviced efficiently.

This topic collection provides the basic information you need to plan for your system installation. It provides an overview of each planning task, as well as valuable reference information useful throughout the performance of these tasks. Depending on the complexity of the system you ordered and your existing computing resource, you might not need to perform all the steps noted here.

First, with the help of your systems engineer, sales representative, or with the help of those coordinating your installation, list the hardware for which you need to plan. Use the summary of your order to help you when making your list. This list is now your "To Do" list. You can use the Planning task checklist to assist you.

While you are responsible for planning, vendors, contractors, and your sales representative are also available to help with any aspect of the planning. For some system units, a customer service representative will install your system unit and verify correct operation. Some system units are considered customer-installed. If you are not sure, check with your sales representative.

The physical planning section of this topic collection provides the physical characteristics of many system units, and associated products. For information on products not included in this topic collection, contact your sales representative or your authorized dealer.

Before proceeding with planning, ensure that the hardware and software you have chosen meets your needs. Your sales representative is available to answer questions.

While this information is for hardware planning, the system memory and disk storage needed are a function of the software to be used, therefore some things to consider are listed below. Information on software products is generally in or with the software Licensed Program Product itself.

In assessing the adequacy of hardware and software, consider the following:

- Available disk space and system memory for accommodating software, online documentation, and data (including future growth needs resulting from additional users, more data, and new applications)
- Compatibility of all devices
- Compatibility of software packages with each other and with the hardware configuration
- Adequate redundancy or backup capabilities in hardware and software
- Software portability to the new system, if necessary
- Prerequisites and corequisites of chosen software have been satisfied
- Data to be transferred to the new system





---

## What's new in Site and hardware planning

Read about new or significantly changed information in Site and hardware planning since the previous update of this topic collection.

### March 2013

The following updates have been made to the content:

- Added the Model 8202-E4D and 8205-E6D server specifications topic.
- Added the “Model 1164-95X rear door heat exchanger” on page 65 topic.
- Updated the “Planning for the 7953-94X and 7965-94Y rack” on page 59 topic.

### October 2012

The following update has been made to the content:

- Added the “7042-CR7 Hardware Management Console specifications” on page 69 topic.
- Added the “EDR1 expansion unit” on page 32 topic.
- Added the “Rack switch specifications” on page 71 topic.

### May 2012

The following update has been made to the content:

- Added the “5888 expansion unit” on page 31 topic.

### October 2011

The following updates have been made to the content:

- Added the topic: “Cable management” on page 147.
- Added the topic: Model 8202-E4B, 8202-E4C, 8205-E6B, and 8205-E6C server specifications.



---

## Planning activities

You can use this information to help you plan the physical installation for your server.

Proper planning for your system will facilitate a smooth installation and fast system start-up. Sales and installation planning representatives are also available to help you with installation planning.

As part of your planning activity, you will make decisions about where to locate your server and who will operate the system

---

## Planning task checklist

Use this checklist to document your planning progress.

Working with your sales representative, establish completion dates for each of the tasks. You might want to review your planning schedule periodically with your sales representative.

*Table 1. Planning task checklist*

Planning step	Person responsible	Target date	Completion date
Plan your office or computer room layout (physical planning)			
Prepare for power cords and electrical needs			
Prepare for cables and cabling			
Create or modify communications networks			
Perform building alterations, as needed			
Prepare maintenance, recovery, and security plans			
Develop an education plan			
Order supplies			
Prepare for system delivery			

---

## General considerations

Planning your system requires attention to the numerous details.

When determining the placement of your system, consider the following:

- Adequate space for the devices.
- Working environment of personnel who will be using the devices (their comfort, ability to access the devices, supplies, and reference materials).
- Adequate space for maintaining and servicing the devices.
- Physical security requirements necessary for the devices.
- Weight of the devices.
- Heat output of the devices.
- Operating temperature requirements of the devices.

- Humidity requirements of the devices.
- Air flow requirements of the devices.
- Air quality of the location where the devices will be used. For example, excess dust could damage your system.

**Note:** The system and devices are designed to operate in normal office environments. Dirty or other poor environments might damage the system or the devices. You are responsible for providing the proper operating environment.

- Altitude limitations of the devices.
- Noise emission levels of the devices.
- Any vibration of equipment near where the devices will be placed.
- Paths of power cords.

The following pages contain the information you need to evaluate these considerations.

---

## Site preparation and physical planning guidelines

These guidelines help you prepare your site for the delivery and installation of your server.

Information contained in the Site preparation and physical planning might be helpful for preparing your data center for the arrival of a server.

The Site preparation and physical planning topic covers the following information:

### Site selection, building and space considerations

- Site selection
- Access
- Static electricity and floor resistance
- Space requirements
- Floor construction and floor loading
- Raised floors
- Conductive contamination
- Computer room layout

### Site environment, safety, and security

- Vibration and shock
- Lighting
- Acoustics
- Electromagnetic compatibility
- Computer room location
- Material and data storage protection
- Emergency planning for continuous operations

### Electrical power and grounding

- General power information
- Power quality
- Voltage and frequency limits
- Power load
- Power source

- Dual power installations

#### **Air conditioning**

- Air conditioning determination
- General guidelines for data centers
- Temperature and humidity design criteria
- Temperature and humidity recording instruments
- Relocation and temporary storage
- Acclimation
- System air distribution

#### **Planning for the installation of rear door heat exchangers**

- Planning for the installation of rear door heat exchangers
- Heat exchanger specifications
- Water specifications for the secondary cooling loop
- Water delivery specifications for secondary loops
- Layout and mechanical installation
- Suggested sources for secondary loop components

#### **Communications**

- Planning for communications



---

## Hardware specification sheets

Hardware specification sheets provide detailed information for your hardware, including dimensions, electrical, power, temperature, environment, and service clearances.

---

### Server specifications

Server specifications provide detailed information for your server, including dimensions, electrical, power, temperature, environment, and service clearances.

Select the appropriate models to view the specifications for your server.

### Model 8202-E4B, 8202-E4C, 8202-E4D, 8205-E6B, 8205-E6C, and 8205-E6D server specifications

Server specifications provide detailed information for your server, including dimensions, electrical, power, temperature, environment, and service clearances.



Limited configurations of the IBM Power<sup>®</sup> 740 Express (8205-E6B and 8205-E6C) two-processor socket servers are qualified to the EPA ENERGY STAR Computer Server requirements. The qualified configurations require a minimum of 128 GB of memory. The ENERGY STAR Power and Performance Data Sheet is provided as follows:

- 8205-E6B
- 8205-E6C

Use the following specifications to plan for your server.

*Table 2. Dimensions - rack-mounted drawer*

Width	Depth	Height	EIA units <sup>1</sup>	Weight
440 mm (17.3 in.)	610 mm (24.0 in.)	173 mm (6.8 in.)	4	39.5 kg (87 lb )

*Table 3. Dimensions - stand-alone model*

Width	Depth	Height	Weight
328.5 mm (13 in.) (with tip foot)	688 mm (27.0 in. )	541 mm (21.3 in.)	50 kg (111 lb)
183 mm (7.2 in.) (without tip foot)			

Table 4. Shipping dimensions - rack-mounted drawer

Width	Depth	Height	Weight <sup>1</sup>
610 mm (24 in.)	711 mm (28 in.)	1016 mm (40 in.)	68 - 113 kg (150 - 250 lb)
<sup>1</sup> This is an estimated value.			

Table 5. Shipping dimensions - Stand-alone model

Width	Depth	Height	Weight <sup>1</sup>
660 mm (26 in.)	737 mm (29 in.)	1016 mm (40 in.)	68 - 113 kg (150 - 250 lb)
<sup>1</sup> This is an estimated value.			

Table 6. Shipping dimensions - Stand-alone model (China)

Width	Depth	Height	Weight <sup>1</sup>
660 mm (26 in.)	622 mm (24.5 in.)	1016 mm (40 in.)	68 - 113 kg (150 - 250 lb)
<sup>1</sup> This is an estimated value.			

Table 7. Electrical

Electrical characteristics	Properties
Rated voltage and frequency <sup>1</sup>	100 - 127 V ac <sup>3</sup> or 200 - 240 V ac at 47 - 63 Hz (8202-E4B, 8202-E4C, 8205-E6B, and 8205-E6C)
	100 - 127 V ac, 200 - 208 V ac, and 220 - 240 V ac (8202-E4D)
	200 - 208 V ac and 220 - 240 V ac (8205-E6D)
Thermal output (maximum) <sup>2</sup>	2560 Btu/hr (8202-E4B (Power 720 Express))
	2867 Btu/hr (8202-E4C (Power 720 Express))
	3395 Btu/hr (8202-E4D (Power 720 Express))
	4778 Btu/hr (8205-E6B (Power 740 Express))
	5358 Btu/hr (8205-E6C (Power 740 Express))
	5562 Btu/hr (8205-E6D (Power 740 Express))
Maximum power consumption <sup>2</sup>	750 W (8202-E4B (Power 720 Express))
	840 W (8202-E4C (Power 720 Express))
	995 W (8202-E4D (Power 720 Express))
	1400 W (8205-E6B (Power 740 Express))
	1570 W (8205-E6C (Power 740 Express))
	1630 W (8205-E6D (Power 740 Express))
Maximum kVA <sup>4</sup>	0.765 (8202-E4B (Power 720 Express))
	0.857 (8202-E4C (Power 720 Express))
	1.015 (8202-E4D (Power 720 Express))
	1.429 (8205-E6B (Power 740 Express))
	1.602 (8205-E6C (Power 740 Express))
	1.664 (8205-E6D (Power 740 Express))
Power factor	0.98



Table 7. Electrical (continued)

Electrical characteristics	Properties
Inrush current (maximum)	85 A (8202-E4B, 8202-E4C, 8205-E6B, and 8205-E6C)
	12 A, 6 A, and 6 A (8202-E4D)
	9 A and 9 A (8205-E6D)
Leakage current (maximum)	0.74 mA
Phase	Single
Dual power feature code	2 x 5603
Branch circuit breaker	20 A maximum
Drawer mounted in 7014-T00 and 7014-T42 racks, and power distribution unit (PDU)	0298 or 0299
<b>Notes:</b>	
<ol style="list-style-type: none"> <li>The power supplies automatically accept any voltage with the published, rated-voltage range. If dual power supplies are installed and operating, the power supplies draw approximately equal current from the utility (electrical supply) and provide approximately equal current to the load.</li> <li>Power draw and heat load vary greatly by configuration. When planning for an electrical system, it is important to use maximum values. However, when planning for heat load, you can use the IBM Systems Energy Estimator to obtain a heat output estimate based on a specific configuration. See The IBM Systems Energy Estimator website for more information.</li> <li>Power 720 servers are rated 100 - 127 V ac and 200 - 240 V ac. Power 740 servers are rated at 200 - 240 V ac.</li> <li>To calculate the amperage, multiply kVA by 1000 and divide that number by the operating voltage.</li> </ol>	

Table 8. Environment requirements

Environment	Temperature
Recommended operating temperature	18°C - 27°C (64°F - 80°F)
Allowable operating temperature	5°C - 35°C (41°F - 95°F) (Models 8202-E4B, 8202-E4C, 8205-E6B, and 8205-E6C)
	5°C - 40°C (41°F - 104°F) (Models 8202-E4D and 8205-E6D)
Nonoperating temperature	5°C - 45°C (41°F - 113°F)
Recommended relative humidity range	5.5°C (42°F) dew point to 60% RH and 15°C (59°F) dew point
Allowable relative humidity range	20% - 80%
Nonoperating relative humidity range	8% - 80%
Shipping temperature <sup>1</sup>	-40°C to 60°C (-40°F to 140°F)
Shipping humidity range	5% - 100%
Operating dew point	28°C (84°F)
Altitude range	0 - 3050 m (0 - 10000 ft) <sup>2</sup>
<sup>1</sup> The maximum wet bulb temperature is 29°C (84°F). If one or more feature codes that are listed in Table 9 are installed, then the maximum wet bulb temperature is 28°C (82°F).	
<sup>2</sup> Derate maximum dry-bulb temperature 1°C/300 m above 900 m.	

Table 9. Supported feature codes that affect environmental requirements<sup>1</sup>

Feature codes (FCs)	Feature code names
1738 / EQ38	856 GB (IBM i) 10K RPM SAS HDD (Gen2-S)

Table 9. Supported feature codes that affect environmental requirements<sup>1</sup> (continued)

Feature codes (FCs)	Feature code names
1752 / EQ52	900 GB (AIX/Linux) 10K RPM SAS HDD (Gen2-S)
1917 / 1866	146 GB (AIX/Linux) 15K RPM SAS HDD (Gen2-S)
1925 / 1869	300 GB (AIX/Linux) 10K RPM SAS HDD (Gen2-S)
1947 / 1868	139 GB (IBM i) 15K RPM SAS HDD (Gen2-S)
1948 / 1927	283 GB (IBM i) 15K RPM SAS HDD (Gen2-S)
1953 / 1929	300 GB (AIX/Linux) 15K RPM SAS HDD (Gen2-S)
1956 / 1844	283 GB (IBM i) 10K RPM SAS HDD (Gen2-S)
1962 / 1817	571 GB (IBM i) 10K RPM SAS HDD (Gen2-S)
1964 / 1818	600 GB (AIX/Linux) 10K RPM SAS HDD (Gen2-S)
ESD2 / EQD2	1.14 TB (IBM i) 10K RPM SAS HDD (Gen2-S)
ESD3 / EQD3	1.2 TB (AIX/Linux) 10K RPM SAS HDD (Gen2-S)
<b>Note:</b>	
1. Any feature code that is listed in this table and is installed in your system decreases the maximum wet bulb temperature that is allowed during shipping from 29°C (84°F) to 28°C (82°F).	

Table 10. Noise emissions for the IBM Power 720 Express (8202-E4B, 8202-E4C, and 8202-E4D)

Product description	Declared A-weighted sound power level, L <sub>Wad</sub> (B)		Declared A-weighted sound pressure level, L <sub>pAm</sub> (dB)	
	Operating	Idle	Operating	Idle
8202-E4B, 8202-E4C, and 8202-E4D single-socket processor, rack-integrated configuration, 2 power supplies, 6 hard drives.	5.6	5.5	40	38
8202-E4B, 8202-E4C, and 8202-E4D single-socket processor, 2 power supplies, 6 hard drives. Stand-alone system feature code (7572)	5.6	5.5	39	37
8202-E4B, 8202-E4C, and 8202-E4D single-socket processor, rack-integrated configuration, 2 power supplies, low profile PCIe riser card, 6 hard drives	6.3	6.3	47	47

Table 10. Noise emissions for the IBM Power 720 Express (8202-E4B, 8202-E4C, and 8202-E4D) (continued)

Product description	Declared A-weighted sound power level, $L_{Wad}$ (B)		Declared A-weighted sound pressure level, $L_{pAm}$ (dB)	
8202-E4B, 8202-E4C, and 8202-E4D single-socket processor, rack-integrated configuration, 2 power supplies, 6 hard drives, and acoustic mode off	6.5	6.5	49	49
8202-E4B, 8202-E4C, and 8202-E4D single-socket processor, rack-integrated configuration, 1 power supply, 6 hard drives	6.5	6.5	51	51
8202-E4B, 8202-E4C, and 8202-E4D single-socket processor, rack-integrated configuration, 1 power supply, 6 hard drives, and low profile PCIe riser card.	6.7	6.7	52	52
<b>Notes:</b> <ol style="list-style-type: none"> <li>1. <math>L_{Wad}</math> is the statistical upper-limit A-weighted sound power level (rounded to the nearest 0.1 B).</li> <li>2. <math>L_{pAm}</math> is the mean A-weighted emission sound pressure level measured at the 1-meter bystander position (rounded to the nearest dB).</li> <li>3. 10 dB (decibel) equals 1 B (bel).</li> <li>4. All measurements are made in conformance with ISO 7779 and declared in conformance with ISO 9296. Measured at 25° Celsius at a 500 meter altitude.</li> </ol>				

Table 11. Noise emissions for the IBM Power 740 Express (8205-E6B, 8205-E6C, and 8205-E6D)

Product description	Declared A-weighted sound power level, $L_{Wad}$ (B)		Declared A-weighted sound pressure level, $L_{pAm}$ (dB)	
	Operating	Idle	Operating	Idle
8205-E6B, 8205-E6C, and 8205-E6D 2 socket processor, 2 power supplies, and IBM rack	6.0	5.9	44	43
8205-E6B, 8205-E6C, and 8205-E6D 2 socket processor, 2 power supplies, IBM rack, and low-profile PCIe riser card	6.1	6.1	42	42

Table 11. Noise emissions for the IBM Power 740 Express (8205-E6B, 8205-E6C, and 8205-E6D) (continued)

Product description	Declared A-weighted sound power level, $L_{Wad}$ (B)		Declared A-weighted sound pressure level, $L_{pAm}$ (dB)	
	8205-E6B, 8205-E6C, and 8205-E6D 2 socket processor, 2 power supplies, 8 hard drives, IBM rack, and acoustic mode off	6.4	6.4	48
8205-E6B, 8205-E6C, and 8205-E6D 2 socket processor, 2 power supplies, 8 hard drives, IBM rack, acoustic mode off, and low-profile PCI riser card	6.6	6.6	50	50
8205-E6B, 8205-E6C, and 8205-E6D 2 socket processor, 1 power supply, rack-integrated configuration, and low-profile PCI riser card	6.7	6.7	52	52
8205-E6B, 8205-E6C, and 8205-E6D 2 socket processor, 8 hard drives, 2 power supplies, IBM rack, acoustic mode off, low-profile PCI riser card, and rack acoustical doors FC 6248 or 6249.	6.1	6.1	42	42
<p><b>Notes:</b></p> <ol style="list-style-type: none"> <li><math>L_{Wad}</math> is the statistical upper-limit A-weighted sound power level (rounded to the nearest 0.1 B).</li> <li><math>L_{pAm}</math> is the mean A-weighted emission sound pressure level measured at the 1-meter bystander position (rounded to the nearest dB).</li> <li>10 dB (decibel) equals 1 B (bel).</li> <li>All measurements are made in conformance with ISO 7779 and declared in conformance with ISO 9296. Measured at 25° Celsius at a 500 meter altitude.</li> </ol>				

Table 12. Service clearances

Clearances	Front	Back	Left or right	Top
Operating	762 mm (30 in.)	762 mm (30 in.)		
Nonoperating	762 mm (30 in.)	762 mm (30 in.)	762 mm (30 in.)	762 mm (30 in.)

**Electromagnetic compatibility compliance:** CISPR 22; CISPR 24; FCC, CFR 47, Part 15 (US); VCCI (Japan); Directive 2004/108/EC (EEA); ICES-003, Issue 4 (Canada); ACMA radio communications standard (Australia, New Zealand); CNS 13438 (Taiwan); Radio Waves Act, MIC Rule No. 210 (Korea); Commodity Inspection Law (China); TCVN 7189 (Vietnam); MoCI (Saudi Arabia); SI 961 (Israel); GOST R 51318.22, 51318.24 (Russia).

**Safety compliance:** IEC 60950; UL 60950; CSA 60950; EN 60950

## Special Hardware Management Console considerations

When the server is managed by a Hardware Management Console (HMC), the console must be provided within the same room and within 8 m (26 ft) of the server. For additional considerations, see Planning for HMC installation and configuration.

**Note:** As an alternative to the local HMC requirement, you can provide a supported device, such as a PC, with connectivity and authority to operate through a remotely attached HMC. This local device must be in the same room and within 8 m (26 ft) of your server. It must provide functional capabilities equivalent to the HMC that it replaces, and is needed by the service representative to service the system.

## 8205-E6B ENERGY STAR® Power and Performance Data Sheet

IBM 8205-E6B



Table 13. System Characteristics

System Characteristics	
Form Factor	4U
Available Processor Sockets	2
Available DIMM Slots / Max Memory Capacity	32 / 256 GB
ECC and/or Fully Buffered DIMMs	Yes
Available Expansion Slots	8 PCIe
Minimum and Maximum # of Hard Drives	1 to 6
Redundant Power Supply Capable?	Yes
Power Supply Make and Model	Emerson Network Power 7001490-J000
Power Supply Output Rating* (watts)	1725
Minimum and Maximum # of Power Supplies	2 and 2
Input Power Range (AC or DC)	200-240 V ac
Power Supply Efficiency at Specified Loadings*	85.3@10%, 90.7@20%, 92.3@50%, 89.2@100%
Power Supply Power Factor at Specified Loadings*	0.861@10%, 0.941@20%, 0.986@50%, 0.997@100%
Operating Systems Supported	AIX® 6.1L, AIX 7.1, SUSE Linux Enterprise Server 11 Service Pack 1, IBM i 7.1
Installed Operating System for Testing	AIX 6.1L

\* **Note: Power supply information is for a single power supply only**

Table 14. System Configurations

System Configurations	Minimum	Typical	Maximum
Configuration ID	FC 8355 (2x), FC 4529 (8x)	FC 8355 (2x), FC 4529 (12x)	FC 8355 (2x), FC 4529 (16x)

Table 14. System Configurations (continued)

System Configurations	Minimum	Typical	Maximum
Processor Information	2 x 8-core 3.55 GHz POWER7 <sup>®</sup> processor card	2 x 8-core 3.55 GHz POWER7 processor card	2 x 8-core 3.55 GHz POWER7 processor card
Memory Information	16 x 8GB DIMMs, 1067 MHz, 2Gb DDR3 DRAM	24 x 8GB DIMMs, 1067 MHz, 2Gb DDR3 DRAM	32 x 8GB DIMMs, 1067 MHz, 2Gb DDR3 DRAM
Internal Storage	1 x 2.5 inch, 15 kRPM SAS	4 x 2.5 inch, 15 kRPM SAS	6 x 2.5 inch, 15 kRPM SAS
I/O Devices	1 x 4-Port 1Gb Integrated Virtual Ethernet	1 x 4-Port 1Gb Integrated Virtual Ethernet, 3 x 2-Port Fibre Channel Adapter, 1 x 4-Port 10/100/1000 Base-TX Ethernet	1 x 4-Port 1Gb Integrated Virtual Ethernet, 1 x GX++ Dual-port 12X Channel Adapter, 7 x 2-Port Fibre Channel Adapter, 1 x 4-Port 10/100/1000 Base-TX Ethernet
Power Supply Number and Redundancy Configuration	2	2	2
Management Controller or Service Processor Installed?	Yes	Yes	Yes
Other Hardware Features / Accessories	None	DVD-ROM, HHLTO tape	DVD-RAM, HHLTO tape

Table 15. Power Data

Power Data	Minimum	Typical	Maximum
Idle Category (1S and 2S only)	Category D: Managed Dual Installed Processor (2P) Servers		
ENERGY STAR Idle Power Allowance (1S and 2S only)	426	610	802
Measured Idle Power (watts)	304	467	569
Power at Full Load* (watts)	624	805	939
Benchmark / Method Used for Full Load Test	LINPACK		
Test Voltage and Frequency for Idle and Full Load Test	230 V 50Hz or 60Hz		
Range of Total Estimated Energy Usage ** (kWh/year)	5,326 to 10,932	8,182 to 14,104	9,969 to 16,451
Link to Detailed Power Calculator (if available)	<a href="http://www-912.ibm.com/see/EnergyEstimator">http://www-912.ibm.com/see/EnergyEstimator</a>		

\* Note: Full load power represents the sustained, average power at 100% load of the given workload, and does not necessarily represent the absolute peak power or the highest average, sustained power possible for other workloads.

\*\* Note: Estimated kWh/year gives the absolute range of energy use a user could expect from continuous operation (24x7x365) and ranges from 100% Idle usage to 100% full load operation. The calculation also includes typical data center overhead at a ratio of 1 watt of overhead to every 1 watt of IT load (corresponding to a PUE of 2.0). Closer approximations may be found by using established power calculators and specific information about the intended operating environment (e.g., average time at Idle, data center PUE, etc.).

Table 16. Power and Performance for Benchmark #1

Power and Performance for Benchmark #1	Minimum	Typical	Maximum
Benchmark Used and Type of Workload	LINPACK		
Avg. Power Measured During Benchmark Run	624 Watts	805 Watts	939 Watts
Benchmark Performance Score	381.8 Gflops	383.9 Gflops	405.1 Gflops
Power Performance Ratio (perf score/avg. power)	0.612	0.477	0.431
Link to Full Benchmark Report (Where Available)			

Table 17. Power Saving Features

Power Saving Features	Enabled on Shipment	End-User Enabling Required
Processor Dynamic Voltage and Frequency Scaling	No	Yes
Processor or Core Reduced Power States	Yes	No
Power Capping	No	Yes
Variable Speed Fan Control Based on Power or Thermal Readings	Yes	No
Low Power Memory States	Yes	No
Low Power I/O States	No	No
Liquid Cooling Capability	No	No
Other1:		
Other2:		
Other3:		
Other4:		

Table 18. Power and Temperature Measurement and Reporting

Power and Temperature Measurement and Reporting	
Input Power Available & Accuracy?	Yes, +/- 3%
Input Air Temp Available & Accuracy?	Yes, +/- 1°C typical, +/- 2°C maximum
Processor Utilization Available?	Yes
Other Data Measurements Available & Accuracy?	
Compatible Protocols for Data Collection	REST
Averaging method and time period	30 second average, 1 second peak

Table 19. Thermal Information\*

Thermal Information*	Minimum	Typical	Maximum
Total Power Dissipation (watts)	624.0	805.0	939.0
Delta Temperature at Exhaust at Peak Temp. ( $\Delta C$ )	4.4	5.7	6.6

Table 19. Thermal Information\* (continued)

Thermal Information*	Minimum	Typical	Maximum
Airflow at Maximum Fan Speed (CFM) at Peak Temp.	250.0	250.0	250.0
Airflow at Nominal Fan Speed (CFM) at Nominal Temp.	60.0	60.0	80.0

\* References: ASHRAE Extended Environmental Envelope Final August 1, 2008

Thermal Guidelines for Data Processing Environments, ASHRAE, 2004, ISBN 1-931862-43-5

Peak temperature is defined as 35 °C, Nominal Temperature is defined as 18 - 27 °C

**Notes:**

1. SPECpower\_ssj2008 is a registered trademark of the Standard Performance Evaluation Corporation (SPEC). Benchmark results stated above reflect results published on XX/XX/XX. For the latest SPECpower\_ssj2008 benchmark results, visit [http://www.spec.org/power\\_ssj2008](http://www.spec.org/power_ssj2008).

**8205-E6C ENERGY STAR® Power and Performance Data Sheet**  
IBM 8205-E6C



Table 20. System Characteristics

System Characteristics	
Form Factor	4U
Available Processor Sockets	2
Available DIMM Slots / Max Memory Capacity	32 / 512 GB
ECC and/or Fully Buffered DIMMs	Yes
Available Expansion Slots	9 PCIe
Minimum and Maximum # of Hard Drives	1 to 6
Redundant Power Supply Capable?	Yes
Power Supply Make and Model	Emerson Network Power 7001490-J000
Power Supply Output Rating* (watts)	1725
Minimum and Maximum # of Power Supplies	1 and 2
Input Power Range (AC or DC)	200 - 240 V ac
Power Supply Efficiency at Specified Loadings*	85.3@10%, 90.7@20%, 92.3@50%, 89.2@100%
Power Supply Power Factor at Specified Loadings*	0.861@10%, 0.941@20%, 0.986@50%, 0.997@100%
Operating Systems Supported	AIX, IBM i, i5/OS, OS/400, Linux
Installed Operating System for Testing	AIX 7.1.0.0



**\* Note: Power supply information is for a single power supply only**

*Table 21. System Configurations*

System Configurations	Minimum	Typical	Maximum
Configuration ID	FC EPCB (2x), FC EM16 (8x)	FC EPCB (2x), FC EM16 (12x)	FC EPCB (2x), FC EM32 (16x)
Processor Information	2 x 8-core 3.55 GHz POWER7 processor card	2 x 8-core 3.55 GHz POWER7 processor card	2 x 8-core 3.55 GHz POWER7 processor card
Memory Information	16 x 8GB DIMMs, 1067 MHz, 2Gb DDR3 DRAM	24 x 8GB DIMMs, 1067 MHz, 2Gb DDR3 DRAM	32 x 16GB DIMMs, 1067 MHz, 2Gb DDR3 DRAM
Internal Storage	1 x 2.5 inch, 15 kRPM SAS	3 x 2.5 inch, 15 kRPM SAS	6 x 2.5 inch, 15 kRPM SAS
I/O Devices	1 x 2-Port 10/100/1000 Base-TX Ethernet	3 x 2-Port 10/100/1000 Base-TX Ethernet, 1 x 2-Port Gigabit Ethernet-SX	4 x 2-Port 10/100/1000 Base-TX Ethernet, 1 x 2-Port Gigabit Ethernet-SX, 3 x 4-Port 10/100/1000 Base-TX, 2 x 2-port 4Gb Dual Port Fibre Channel
Power Supply Number and Redundancy Configuration	2	2	2
Management Controller or Service Processor Installed?	Yes	Yes	Yes
Other Hardware Features / Accessories	DVD-RAM, LTO-5 tape	DVD-RAM, LTO-5 tape	DVD-RAM, LTO-5 tape

*Table 22. Power Data*

Power Data	Minimum	Typical	Maximum
Idle Category (1S and 2S only)	Category D: Managed Dual Installed Processor (2P) Servers		
ENERGY STAR Idle Power Allowance (1S and 2S only)	418	574	1282
Measured Idle Power (watts)	393	446	585
Power at Full Load* (watts)	638	704	884
Benchmark / Method Used for Full Load Test	LINPACK		
Test Voltage and Frequency for Idle and Full Load Test	230 V 50Hz or 60Hz		
Range of Total Estimated Energy Usage ** (kWh/year)	6,885 to 11,178	7,814 to 12,334	10,249 to 15,488
Link to Detailed Power Calculator (if available)	<a href="http://www-912.ibm.com/see/EnergyEstimator">http://www-912.ibm.com/see/EnergyEstimator</a>		

**\* Note: Full load power represents the sustained, average power at 100% load of the given workload, and does not necessarily represent the absolute peak power or the highest average, sustained power possible for other workloads.**

**\*\* Note: Estimated kWh/year gives the absolute range of energy use a user could expect from continuous operation (24x7x365) and ranges from 100% Idle usage to 100% full load operation. The calculation also includes typical data center overhead at a ratio of 1 watt of overhead to every 1 watt of**

IT load (corresponding to a PUE of 2.0). Closer approximations may be found by using established power calculators and specific information about the intended operating environment (e.g., average time at Idle, data center PUE, etc.).

Table 23. Power and Performance for Benchmark #1

Power and Performance for Benchmark #1	Minimum	Typical	Maximum
Benchmark Used and Type of Workload	LINPACK		
Avg. Power Measured During Benchmark Run	638 Watts	704 Watts	884 Watts
Benchmark Performance Score	388.0 Gflops	397.4 Gflops	406.6 Gflops
Power Performance Ratio (perf score/avg. power)	0.608	0.564	0.460
Link to Full Benchmark Report (Where Available)			

Table 24. Power Saving Features

Power Saving Features	Enabled on Shipment	End-User Enabling Required
Processor Dynamic Voltage and Frequency Scaling	No	Yes
Processor or Core Reduced Power States	Yes	No
Power Capping	No	Yes
Variable Speed Fan Control Based on Power or Thermal Readings	Yes	No
Low Power Memory States	Yes	No
Low Power I/O States	No	No
Liquid Cooling Capability	No	No
Other1:		
Other2:		
Other3:		
Other4:		

Table 25. Power and Temperature Measurement and Reporting

Power and Temperature Measurement and Reporting	
Input Power Available & Accuracy?	Yes, +/- 3%
Input Air Temp Available & Accuracy?	Yes, +/- 1°C typical, +/- 2°C maximum
Processor Utilization Available?	Yes
Other Data Measurements Available & Accuracy?	
Compatible Protocols for Data Collection	REST
Averaging method and time period	30 second average, 1 second peak

Table 26. Thermal Information\*

Thermal Information*	Minimum	Typical	Maximum
Total Power Dissipation (watts)	638.0	704.0	884.0
Delta Temperature at Exhaust at Peak Temp. ( $\Delta C$ )	4.5	5.0	6.2
Airflow at Maximum Fan Speed (CFM) at Peak Temp.	250.0	250.0	250.0
Airflow at Nominal Fan Speed (CFM) at Nominal Temp.	60.0	60.0	80.0

\* References: ASHRAE Extended Environmental Envelope Final August 1, 2008

Thermal Guidelines for Data Processing Environments, ASHRAE, 2004, ISBN 1-931862-43-5

Peak temperature is defined as 35  $\Delta C$ , Nominal Temperature is defined as 18 - 27  $\Delta C$

**Notes:**

1. SPECpower\_ssj2008 is a registered trademark of the Standard Performance Evaluation Corporation (SPEC). Benchmark results stated above reflect results published on XX/XX/XX. For the latest SPECpower\_ssj2008 benchmark results, visit [http://www.spec.org/power\\_ssj2008](http://www.spec.org/power_ssj2008).

**Power 720 Express (Machine Type: 8202) Technical Documentation for EU Regulation 617/2013**

International Business Machines Corporation  
 New Orchard Road  
 Armonk, New York 10504  
<http://www.ibm.com/customersupport/>

For more information, see <http://www-03.ibm.com/systems/power/hardware/energy-star/>.

Table 27. System characteristics

System characteristics	Properties
Product type	Computer server
Year first manufactured	2011

Table 28. Power characteristics

Power characteristics	Properties
Internal/external power supply efficiency	80 PLUS Verification and Testing Report
Maximum power (watts)	995 W
Idle state power (watts)	229 W
Sleep mode power (watts)	N/A for servers
Off mode power (watts)	25 W

Table 29. Noise levels (Declared A-weighted sound pressure level,  $L_{pAm}$ )

Product description	Declared A-weighted sound pressure level, $L_{pAm}$ (dB)	
	Operating	Idle

Table 29. Noise levels (Declared A-weighted sound pressure level,  $L_{pAm}$ ) (continued)

Product description	Declared A-weighted sound pressure level, $L_{pAm}$ (dB)	
8202-E4D single-socket processor, rack-integrated configuration, two power supplies, and six hard disk drives.	40	38
8202-E4D single-socket processor, two power supplies, six hard disk drives, and stand-alone system feature code (7572)	39	37
8202-E4D single-socket processor, rack-integrated configuration, two power supplies, low profile PCIe riser card, and six hard disk drives	47	47
8202-E4D single-socket processor, rack-integrated configuration, two power supplies, six hard disk drives, and acoustic mode off.	49	49
8202-E4D single-socket processor, rack-integrated configuration, one power supply, and six hard disk drives	51	51
8202-E4D single-socket processor, rack-integrated configuration, one power supply, six hard disk drives, and low profile PCIe riser card.	52	52

Table 30. Test parameters for measurements

Test parameters	Properties
Test voltage and frequency	230 V ac at 50 Hz or 60 Hz
Total harmonic distortion of the electricity supply system	The maximum harmonic content of the input voltage waveform is equal to or less than 2%. The qualification is compliant with EN 61000-3-2.
Information and documentation on the instrumentation setup and circuits that are used for electrical testing	ENERGY STAR Test Method for Computer Servers; ECOVA Generalized Test Protocol for Calculating the Energy Efficiency of Internal Ac-Dc and Dc-Dc Power Supplies
Measurement methodology that is used to determine information in this document	ENERGY STAR Servers Version 2.0 Program Requirements; ECOVA Generalized Test Protocol for Calculating the Energy Efficiency of Internal Ac-Dc and Dc-Dc Power Supplies

## Power 740 Express (Machine Type: 8205) Technical Documentation for EU Regulation 617/2013

International Business Machines Corporation  
 New Orchard Road  
 Armonk, New York 10504  
<http://www.ibm.com/customersupport/>

For more information, see <http://www-03.ibm.com/systems/power/hardware/energy-star/>.

Table 31. System characteristics

System characteristics	Properties
Product type	Computer server

Table 31. System characteristics (continued)

System characteristics	Properties
Year first manufactured	2010

Table 32. Power characteristics

Power characteristics	Properties
Internal/external power supply efficiency	80 PLUS Verification and Testing Report
Maximum power (watts)	1630 W
Idle state power (watts)	501 W
Sleep mode power (watts)	N/A for servers
Off mode power (watts)	26 W

Table 33. Noise levels (Declared A-weighted sound pressure level,  $L_{pAm}$ )

Product description	Declared A-weighted sound pressure level, $L_{pAm}$ (dB)	
	Operating	Idle
8205-E6D 2 socket processor, 2 power supplies, and IBM rack	44	43
8205-E6D 2 socket processor, 2 power supplies, IBM rack, and low-profile PCIe riser card	42	42
8205-E6D 2 socket processor, 2 power supplies, 8 hard drives, IBM rack, and acoustic mode off	48	48
d 8205-E6D 2 socket processor, 2 power supplies, 8 hard drives, IBM rack, acoustic mode off, and low-profile PCI riser card	50	50
8205-E6D 2 socket processor, 1 power supply, rack-integrated configuration, and low-profile PCI riser card	52	52
8205-E6D 2 socket processor, 8 hard drives, 2 power supplies, IBM rack, acoustic mode off, low-profile PCI riser card, and rack acoustical doors FC 6248 or 6249.	42	42

Table 34. Test parameters for measurements

Test parameters	Properties
Test voltage and frequency	230 V ac at 50 Hz or 60 Hz
Total harmonic distortion of the electricity supply system	The maximum harmonic content of the input voltage waveform is equal to or less than 2%. The qualification is compliant with EN 61000-3-2.
Information and documentation on the instrumentation setup and circuits that are used for electrical testing	ENERGY STAR Test Method for Computer Servers; ECOVA Generalized Test Protocol for Calculating the Energy Efficiency of Internal Ac-Dc and Dc-Dc Power Supplies
Measurement methodology that is used to determine information in this document	ENERGY STAR Servers Version 2.0 Program Requirements; ECOVA Generalized Test Protocol for Calculating the Energy Efficiency of Internal Ac-Dc and Dc-Dc Power Supplies

## Plan view for model 8202-E4B, 8202-E4C, 8202-E4D, 8205-E6B, 8205-E6C, and 8205-E6D

Dimensional planning information is shown in this top-down view of your server.

The following figure shows dimensional planning information for model 8202-E4B, 8202-E4C, 8202-E4D, 8205-E6B, 8205-E6C, and 8205-E6D.

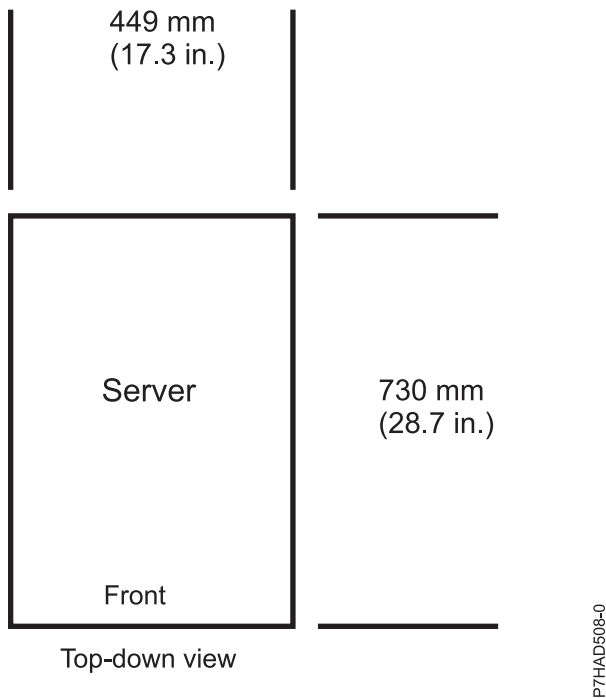

Figure 1. Model 8202-E4B, 8202-E4C, 8202-E4D, 8205-E6B, 8205-E6C, and 8205-E6D plan view (rack-mounted servers)

## Expansion unit and migration tower specifications

Expansion unit and migration tower specifications provide detailed information for your hardware, including dimensions, electrical, power, temperature, environment, and service clearances.

Select a model to view its specifications.

### 5786 expansion unit

Hardware specifications provide detailed information for your expansion unit, including dimensions, electrical, power, temperature, environment, and service clearances.

Table 35. Dimensions for rack-mounted expansion unit

Width	Depth	Height	Maximum configuration weight
447 mm (17.5 in.)	660 mm (26 in.)	171 mm (6.75 in.)	54 kg (120 lb)

Table 36. Dimensions for stand-alone expansion unit with stabilizer foot and decorative covers

Width	Depth	Height	Maximum configuration weight
305 mm (12.0 in.)	655 mm (26.0 in.)	508 mm (20.0 in.)	66 kg (145 lb)

Table 37. Electrical

Electrical characteristics	Properties
kVA	0.740
Rated voltage and frequency	100 - 127 V ac at 50 - 60 Hz plus or minus 3 Hz and 12 A 200 - 240 V ac at 50 - 60 Hz plus or minus 3 Hz and 6.2 A Machine rating with two redundant power cords
Maximum thermal output	2382 Btu/hr
Maximum power requirements <sup>1</sup>	700 W
Power factor	0.95
Inrush current	55 A per power cord
Maximum leakage current	3.10 mA
Phase	1

<sup>1</sup>All measurements made in conformance with ISO 7779 and declared in conformance with ISO 9296.

Table 38. Temperature requirements

Operating	Nonoperating
10°C - 38°C (50°F - 100.4°F) <sup>1</sup>	-40°C to 60°C (-40°F to 140°F)

<sup>1</sup>The maximum 38°C (100.4°F) temperature must be derated 1°C (1.8°F) per 137 m (450 ft) above 1295 m (4250 ft). Maximum altitude is 2134 m (7000 ft).

Table 39. Environment requirements

Properties	Operating	Nonoperating	Maximum altitude
Noncondensing Humidity	20 - 80% (allowable) 40 - 55% (recommended)	8 - 80% (including condensing)	2134 m (7000 ft) above sea level
Wet bulb temperature	21°C (69.8°F)	27°C (80.6°F)	

Table 40. Noise emissions

Models	Properties	Operating	Idle
5786	L <sub>WAd</sub>	6.6 Bels	6.5 Bels
Single 5786 drawer in standard 19-inch rack with 24 hard drives, nominal environmental conditions, and no front or rear doors on rack.	L <sub>pAm</sub> (1-meter bystander)	49 dB	49 dB

<sup>1</sup>All measurements made in conformance with ISO 7779 and declared in conformance with ISO 9296.

Table 41. Service clearances for rack-mounted expansion unit

Front	Back	Sides <sup>1</sup>
914 mm (36 in.)	914 mm (36 in.)	914 mm (36 in.)
<sup>1</sup> Side and top clearances are optional during operation.		

Table 42. Service clearances for stand-alone expansion unit

Front	Back
368.3 mm (14.5 in.)	381 mm (15 in.)

**Safety compliance:** This hardware is designed and certified to meet the following safety standards: UL 60950; CAN/CSA C22.2 No. 60950-00; EN 60950; IEC 60950 including all National Differences

**Related information:**

 Acoustics

## 5796 expansion unit

Hardware specifications provide detailed information for your expansion unit, including dimensions, electrical, power, temperature, environment, and service clearances.

Table 43. Dimensions I/O drawer only

Height	Width	Depth
172 mm (6.8 in.)	224 mm (8.8 in.)	800 mm (31.5 in.)

Table 44. Dimensions - with required I/O drawer mounting enclosure

Height	Width	Depth
176 mm (6.9 in.)	473 mm (18.6 in.)	800 mm (31.5 in.)

Table 45. Maximum configuration weight

One I/O drawer	Two I/O drawers plus the mounting enclosure
20 kg (44 lb)	45.9 kg (101 lb)

Table 46. Electrical

Electrical characteristics	Properties
kVA	0.275
Rated voltage and frequency	200 - 240 V ac at 50 - 60 Hz, V dc not supported
Thermal output	853 Btu/hr
Power requirements (maximum)	250 W
Power factor	0.91

Table 47. Temperature requirements

Operating	Nonoperating	Storage
10°C - 38°C (50°F - 100°F)	1°C - 60°C (33.8°F - 140°F)	1°C - 60°C (33.8°F - 140°F)
The upper limit of the dry-bulb temperature must be derated 1°C per 137 m (450 ft) above 915 m (3000 ft).		



Table 48. Environment requirements

Environment	Operating	Nonoperating	Storage	Maximum altitude
Noncondensing humidity	8% - 80%	8% - 80%	5% - 80%	3048 m (10 000 ft)
Wet bulb temperature <sup>4</sup>	23°C (73.4°F)	27°C (80.6°F)	29°C (84.2°F)	
The upper limit of the wet bulb temperature must be derated 1°C per 274 m (900 ft) above 305 m (1000 ft).				

Table 49. Noise emissions

Properties	Operating	Idle
$L_{WA,d}$	6.2 bels	6.1 bels
$\langle L_{pA} \rangle_m$	44 dB	43 dB

Table 50. Service clearances

Front	Back	Sides
915 mm (36 in.)	915 mm (36 in.)	915 mm (36 in.)

**Related information:**

 Acoustics

## 5802 expansion unit

Hardware specifications provide detailed information for your expansion unit, including dimensions, electrical, power, temperature, environment, and service clearances.

Table 51. Dimensions for rack-mounted expansion unit

Maximum configuration weight	Width	Depth	Height
54 kg (120 lb)	444.5 mm (17.5 in.)	711.2 mm (28 in.)	4U

Table 52. Electrical

Electrical characteristics	Properties
kVA (maximum)	.768 kVA
Rated voltage and frequency	100 - 127 V ac or 200 - 240 V ac at 50 - 60Hz
Thermal output (maximum)	2542 BTU/hr
Power requirements (maximum)	745 W
Power factor	.97
Leakage current (maximum)	3.5 mA
Phase	Single
Plug type (Canada and U.S.)	26
Power cord length	14 ft

Table 53. Temperature requirements

Operating	Storage	Shipping
10°C - 38°C (32°F - 100.4°F)	1°C - 60°C (33.8°F - 140°F)	-40°C to 60°C (-40°F to 140°F)

Table 54. Environment requirements

Properties	Operating	Nonoperating	Storage	Shipping	Maximum altitude
Noncondensing humidity	Recommended: 34% - 54%  Allowable: 20% - 80%	5% - 80%	5% - 80%	5% - 100%	3048 m (10 000 ft)

Table 55. Noise emissions

Models	Properties	Operating	Idle
Feature Code 5802 - 4U I/O drawer consists of 18 SSF disk drives, 10 PCI-Express 8x slots, and 2 DCAs	L <sup>WAd</sup> (B)	7.0	7.0
	L <sup>pAm</sup> (dB)	52	52
<b>Notes:</b> 1. L <sup>WAd</sup> is the statistical upper-limit A-weighted sound power level (rounded to the nearest 0.1 B). 2. L <sup>pAm</sup> is the mean A-weighted emission sound pressure level measured at the 1-meter bystander positions (rounded to the nearest dB). 3. 10 dB (decibel) = 1 B (bel). 4. All measurements made in conformance with ISO 7779 and declared in conformance with ISO 9296.			

Table 56. Service clearances

Front	Back	Sides
915 mm (36 in.)	915 mm (36 in.)	914 mm (36 in.)

## 5877 expansion unit

Hardware specifications provide detailed information for your expansion unit, including dimensions, electrical, power, temperature, environment, and service clearances.

Table 57. Dimensions for rack-mounted expansion unit

Maximum configuration weight	Width	Depth	Height
48 kg (105 lb)	444.5 mm (17.5 in.)	711.2 mm (28 in.)	4U

Table 58. Electrical

Electrical characteristics	Properties
kVA (maximum)	0.531 kVA
Rated voltage and frequency	100 - 127 V ac or 200 - 240 V ac at 50 - 60 Hz
Thermal output (maximum)	1760 BTU/hr
Power requirements (maximum)	515 W
Power factor	0.97
Leakage current (maximum)	3.5 mA
Phase	Single
Plug type (Canada and U.S.)	26
Power cord length	14 ft

Table 59. Temperature requirements

Operating	Storage	Shipping
10°C - 38°C (32°F - 100.4°F)	1°C - 60°C (33.8°F - 140°F)	-40°C to 60°C (-40°F to 140°F)

Table 60. Environment requirements

Properties	Operating	Nonoperating	Storage	Shipping	Maximum altitude
Noncondensing humidity	Recommended: 34% - 54%  Allowable: 20% - 80%	5% - 80%	5% - 80%	5% - 100%	3048 m (10 000 ft)

Table 61. Service clearances

Front	Back	Sides
915 mm (36 in.)	915 mm (36 in.)	914 mm (36 in.)

## 5886 expansion unit

Hardware specifications provide detailed information for your expansion unit, including dimensions, electrical, power, temperature, environment, and service clearances.

Table 62. Dimensions for rack-mounted expansion unit

Weight (with no drives installed)	Width	Depth (including front bezel)	Height
17.7 kg (39 lb)	445 mm (17.5 in.)	521 mm (20.5 in.)	89 mm (3.5 in.)

Table 63. Electrical

Electrical characteristics	Properties
kVA <sup>1</sup>	0.358
Rated voltage and frequency	100 - 240 V ac at 50 - 60 Hz
Thermal output <sup>1</sup>	1160 Btu/hr
Power requirements (maximum)	340 W
Power factor	0.95
Inrush current	55 A per power cord
Leakage current (maximum)	3.10 mA
Phase	1

<sup>1</sup>All measurements made in conformance with ISO 7779 and declared in conformance with ISO 9296.

Table 64. Temperature requirements

Operating	Nonoperating
10 - 38°C (50 - 100.4°F) <sup>1</sup>	-40 - 60°C (-40 - 140°F)

<sup>1</sup>The maximum 38°C (100.4°F) temperature must be derated 1°C (1.8 °F) per 137 m (450 ft) above 1295 m (4250 ft).

Table 65. Environmental requirements

Environment	Operating	Nonoperating	Maximum altitude
Noncondensing humidity	20 - 80% (allowable) 40 - 55% (recommended)	8 - 80% (including condensing)	2134 m (7000 ft) above sea level
Wet bulb temperature	21°C (69.8°F)	27°C (80.6°F)	

Table 66. Noise emissions<sup>1</sup>

Properties	Operating	Idle
L <sub>WAd</sub>	6.6 bels	6.5 bels
L <sub>pAm</sub> (1-meter bystander)	49 dB	49 dB

<sup>1</sup>Single drawer in standard 19-inch rack with 24 hard drives, nominal environmental conditions, and no front or rear doors on rack.

For a description of noise emission values, see *Acoustics*.

All measurements made in conformance with ISO 7779 and declared in conformance with ISO 9296.

Table 67. Service clearances for rack-mounted expansion unit

Front	Back	Sides
914 mm (36 in.)	914 mm (36 in.)	914 mm (36 in.)

Side and top clearances are optional during operation.

Table 68. Service clearances for stand-alone expansion unit

Front	Back
368.3 mm (14.5 in.)	381 mm (15 in.)

**Safety compliance:** This hardware is designed and certified to meet the following safety standards: UL 60950; CAN/CSA C22.2 No. 60950-00; EN 60950; IEC 60950 including all National Differences

**Related information:**

 Acoustics

## 5887 expansion unit

Hardware specifications provide detailed information for your expansion unit, including dimensions, electrical, power, temperature, environment, and service clearances.

Table 69. Dimensions for rack-mounted expansion unit

Weight (with drives installed)	Width	Depth (including front bezel)	Height (with support rails)
25.4 kg (56.0 lb)	448.6 mm (17.7 in.)	530 mm (20.9 in.)	87.4 mm (3.4 in.)

Table 70. Electrical

Electrical characteristics	Properties
kVA (maximum) <sup>1</sup>	0.32
Rated voltage and frequency	100 - 127 V ac or 200 - 240 V ac at 50 - 60 Hz
Thermal output (maximum) <sup>1</sup>	1024 Btu/hr
Power requirements (maximum)	300 W

Table 70. Electrical (continued)

Electrical characteristics	Properties
Power factor	0.94
Leakage current (maximum)	1.2 mA
Phase	1
<sup>1</sup> All measurements made in conformance with ISO 7779 and declared in conformance with ISO 9296.	

Table 71. Temperature requirements

Operating	Nonoperating
10°C - 38°C (50°F - 100.4°F) <sup>1</sup>	-40°C - 60°C (-40°F - 140°F)
<sup>1</sup> The maximum 38°C (100.4°F) temperature must be derated 1°C (1.8 °F) per 137 m (450 ft) above 1295 m (4250 ft).	

Table 72. Environmental requirements

Environment	Operating	Nonoperating	Maximum altitude
Noncondensing humidity	20% - 80% (allowable) 40% - 55% (recommended)	8% - 80% (including condensing)	2134 m (7000 ft) above sea level
Wet bulb temperature	21°C (69.8°F)	27°C (80.6°F)	

Table 73. Noise emissions<sup>1</sup>

Properties	Operating	Idle
L <sub>WAd</sub>	6.0 bels	6.0 bels
L <sub>pAm</sub> (1-meter bystander)	43 dB	43 dB
<sup>1</sup> Single drawer in standard 19-inch rack with 24 hard drives, nominal environmental conditions, and no front or rear doors on rack.		
For a description of noise emission values, see <i>Acoustics</i> .		
All measurements made in conformance with ISO 7779 and declared in conformance with ISO 9296.		

Table 74. Service clearances for rack-mounted expansion unit

Front	Back	Sides
914 mm (36 in.)	914 mm (36 in.)	914 mm (36 in.)
Side and top clearances are optional during operation.		

**Safety compliance:** This hardware is designed and certified to meet the following safety standards: UL 60950; CAN/CSA C22.2 No. 60950-00; EN 60950; IEC 60950 including all National Differences

**Related information:**

 Acoustics

## 5888 expansion unit

Hardware specifications provide detailed information for your expansion unit, including dimensions, electrical, power, temperature, environment, and service clearances.

Table 75. Dimensions for rack-mounted expansion unit

Weight (with drives installed)	Width	Depth (including front bezel)	Height (with support rails)
21.8 kg (48.0 lb)	444.5 mm (17.5 in.)	762 mm (30 in.)	44.5 mm (1.75 in.)

Table 76. Electrical

Electrical characteristics	Properties
kVA (maximum) <sup>1</sup>	0.46
Rated voltage and frequency	100 - 127 V ac or 200 - 240 V ac at 50 - 60 Hz
Thermal output (maximum) <sup>1</sup>	1501 Btu/hr
Power requirements (maximum)	440 W
Phase	1

<sup>1</sup>All measurements are made in conformance with ISO 7779 and declared in conformance with ISO 9296.

Table 77. Temperature requirements

Operating	Nonoperating
10°C - 38°C (50°F - 100.4°F) <sup>1</sup>	-40°C to 60°C (-40°F to 140°F)

<sup>1</sup>The maximum 38°C (100.4°F) temperature must be derated 1°C (1.8 °F) per 137 m (450 ft) above 1295 m (4250 ft).

Table 78. Environmental requirements

Environment	Operating	Nonoperating	Maximum altitude
Noncondensing humidity	20% - 80% (allowable) 40% - 55% (recommended)	8% - 80% (including condensing)	2134 m (7000 ft) above sea level
Wet bulb temperature	21°C (69.8°F)	27°C (80.6°F)	

**Safety compliance:** This hardware is designed and certified to meet the following safety standards: UL 60950; CAN/CSA C22.2 No. 60950-00; EN 60950; IEC 60950 including all national differences

**Related information:**

- [↗ Acoustics](#)
- [↗ 5888 PCIe storage enclosure](#)

## EDR1 expansion unit

Hardware specifications provide detailed information for your expansion unit, including dimensions, electrical, power, temperature, environment, and service clearances.

Table 79. Dimensions for rack-mounted expansion unit

Weight (with drives installed)	Width	Depth (including front bezel)	Height (with support rails)
21.8 kg (48.0 lb)	444.5 mm (17.5 in.)	762 mm (30 in.)	44.5 mm (1.75 in.)

Table 80. Electrical

Electrical characteristics	Properties
kVA (maximum) <sup>1</sup>	0.46
Rated voltage and frequency	100 - 127 V ac or 200 - 240 V ac at 50 - 60 Hz

Table 80. Electrical (continued)

Electrical characteristics	Properties
Thermal output (maximum) <sup>1</sup>	1501 Btu/hr
Power requirements (maximum)	440 W
Phase	1
<sup>1</sup> All measurements are made in conformance with ISO 7779 and declared in conformance with ISO 9296.	

Table 81. Temperature requirements

Operating	Nonoperating
10°C - 38°C (50°F - 100.4°F) <sup>1</sup>	-40°C to 60°C (-40°F to 140°F)
<sup>1</sup> The maximum 38°C (100.4°F) temperature must be derated 1°C (1.8 °F) per 137 m (450 ft) above 1295 m (4250 ft).	

Table 82. Environmental requirements

Environment	Operating	Nonoperating	Maximum altitude
Noncondensing humidity	20% - 80% (allowable)	8% - 80% (including condensing)	2134 m (7000 ft) above sea level
	40% - 55% (recommended)		
Wet bulb temperature	21°C (69.8°F)	27°C (80.6°F)	

**Safety compliance:** This hardware is designed and certified to meet the following safety standards: UL 60950; CAN/CSA C22.2 No. 60950-00; EN 60950; IEC 60950 including all national differences

## Rack specifications

Rack specifications provide detailed information for your rack, including dimensions, electrical, power, temperature, environment, and service clearances.

For non-IBM rack specifications, see Rack installation procedures for racks not purchased at IBM.

Select your rack model to view its specifications.

### Related reference:

“Rack installation specifications for racks not purchased from IBM” on page 73

Learn the requirements and specifications for installing IBM systems into racks that were not purchased from IBM.

## 0550 model 9406-830 rack

Rack specifications provide detailed information for your rack, including dimensions, electrical, power, temperature, environment, and service clearances.



Figure 2. 0550 rack

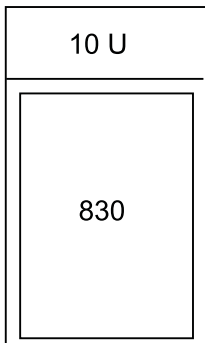

RBAGP815-0

Figure 3. 0550 rack configuration

Table 83. Dimensions

Maximum configuration weight	Width	Depth	Height	EIA units
644 kg (1417 lb)	650 mm (25.5 in.)	1020 mm (40.0 in. )	1800 mm (71.0 in. )	36

The 1.8 meter rack has 10 EIA units of space remaining. This space will be filled with a 5 EIA filler panel, a 3 EIA filler panel, and two of the 1 EIA filler panels. Because the rack does not have power distribution, the model 9406-830 requires a power cord of sufficient length to reach the receptacle. The power cord for model 9406-830 must be used to determine the appropriate receptacle.

Table 84. Electrical

Electrical characteristics	Properties
kVA (maximum)	1.684
Rated voltage and frequency	200 - 240 V ac at 50 - 60 plus or minus 0.5 Hz
Thermal output (maximum)	5461 Btu/hr



Table 84. Electrical (continued)

Electrical characteristics	Properties
Power requirements (maximum)	1600 W
Power factor	0.95
Inrush current	80 A
Leakage current (maximum)	3.5 mA
Phase	1

Table 85. Service clearance

Front	Back	Sides	Top
762 mm (30 in.)	762 mm (30 in.)	762 mm (30 in.)	762 mm (30 in.)
Side and top clearances are optional when operating.			

Feature Code	Top rack specify	Bottom rack specify	PDU support	Power cords
0550 <sup>1</sup>	None	None	0 to 4 <sup>2</sup>	Model 9406-830 <sup>3</sup> , PDU
<sup>1</sup> Ten EIA units of space not managed by the configurator.				
<sup>2</sup> Feature codes 5160, 5161, and 5162.				
<sup>3</sup> Model 9406-830 does not plug into a power distribution unit.				

## 0551 rack

The 0551 rack specifications provide detailed information for your rack.

The 0551 provides an empty 1.8 m rack (36 EIA units of total space).

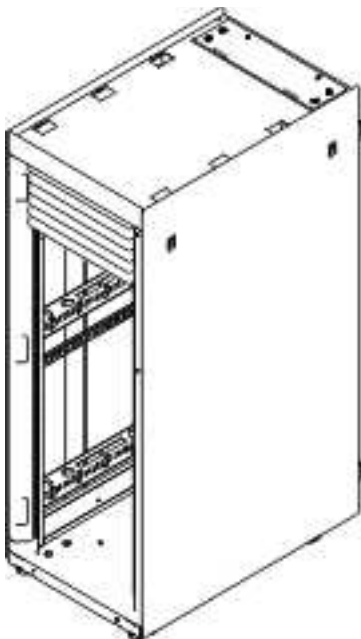

Figure 4. 0551 rack

Table 86. Dimensions

Maximum configuration weight	Width	Depth	Height
The weight of the empty rack is 244 kg (535 lb).	650 mm (25.5 in.)	1020 mm (40.0 in.)	1800 mm (71.0 in.)

Table 87. Temperature requirements

Operating	Nonoperating
10°C - 38°C (50°F - 100.4°F)	1°C - 60°C (33.8°F - 140°F )

Table 88. Environment requirements

Environment	Operating	Nonoperating
Noncondensing humidity	8% - 80%	8% - 80%
Wet bulb temperature	22.8°C (73°F)	22.8°C (73°F)
Maximum altitude	3048 m (10000 ft)	3048 m (10000 ft)
Noise emissions	Rack noise levels are a function of the number and type of drawers installed. See your server or hardware specifications for specific requirements	Rack noise levels are a function of the number and type of drawers installed. See your server or hardware specifications for specific requirements

Table 89. Service clearances

Front	Back	Sides	Top
762 mm (30 in. )	762 mm (30 in.)	762 mm (30 in.)	762 mm (30 in.)
Side and top clearances are optional during operation			

**Notes:**

1. The 1.8 meter rack has 10 EIA units of space remaining. This space will be filled with a 5 EIA filler panel, a 3 EIA filler panel, and two of the 1 EIA filler panels. Because the rack does not have power distribution, the model 830 requires a power cord of sufficient length to reach the receptacle. The power cord for model 830 must be used to determine the appropriate receptacle.
2. Acoustic doors are available for the IBM racks. Feature code 6248 is available for the 0551 and 7014-T00 racks. Feature code 6249 is available for the 0553 and 7014-T42 racks. The overall sound reduction is approximately 6 dB. The doors add 381 mm (15 in.) to the depth of the racks.
3. For a description of noise emission values, see Acoustics.

**Caster and leveler locations**

Figure 5 on page 37 provides the caster and leveler locations for the 7014-T00, 7014-T42, 0551, 0553 and 0555 racks.

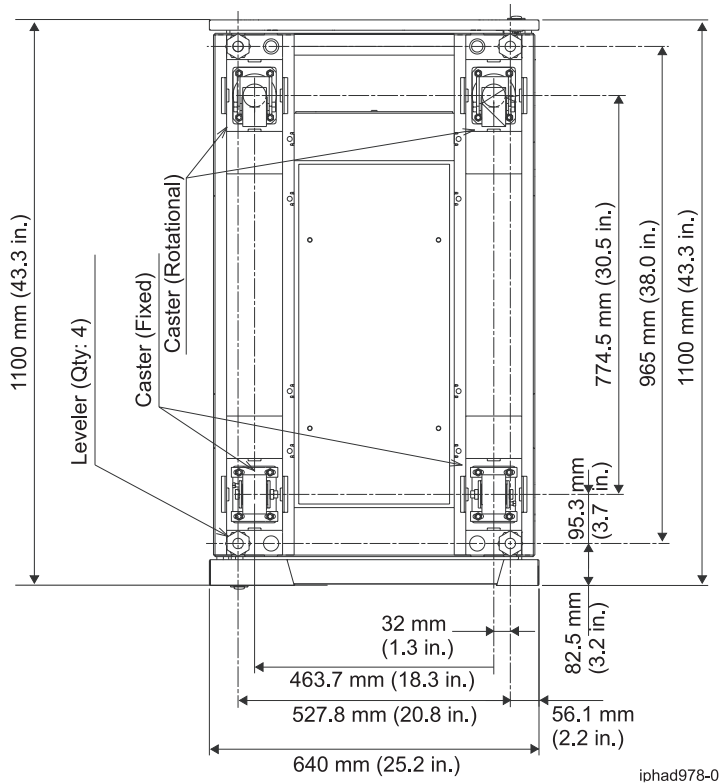

Figure 5. Caster and leveler locations

**Related information:**

Acoustics

**0551, 0553, 0555, and 7014 rack configurations**

The 0551 or 7014-T00 provide a 1.8 meter rack (36 EIA units of total space). The 7014-T42 or 0553 provides a 2.0 meter rack (42 EIA units of total space).

**Model 9406 feature code 7884 and model 9111 rack content specify code 0229. 9406-520 and 9111-520 in rack**

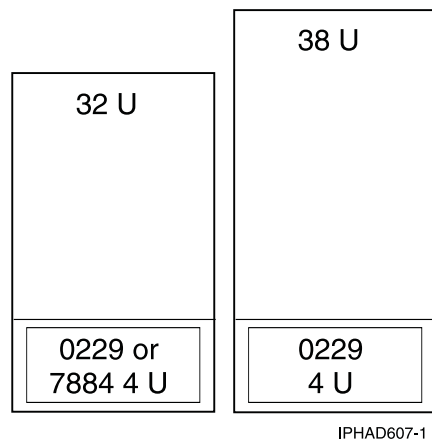
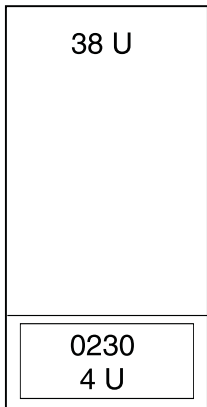

Figure 6. Feature code 7884: 9406-520 and 9111-520 in a rack

IBM rack	Rack, specify code	PDU support	Power cords
0551 <sup>1</sup> 0553 <sup>1</sup> 7014 <sup>4</sup> 0555	7884, 0229	0 to 4 <sup>2</sup>	7884, PDU <sup>3</sup>
<p><sup>1</sup>0551 is an empty 1.8 meter rack with 36 EIA units of total space. 0553 is a 2.0 meter rack with 42 EIA units of total space.</p> <p><sup>2</sup>0551, 0553, and 0555 feature codes 5160, 5161, 5163, and 7188. 7014 feature codes 7176, 7177, 7178, and 7188.</p> <p><sup>3</sup>If units plug into a power distribution unit (PDU), power jumper cord feature code 6458, 6459, 6095, or 9911 is required. If redundant power supply (feature code 5158) is ordered, a second power jumper cord feature code is required.</p> <p><sup>4</sup>7014-T00 is a 1.8 meter rack with 36 EIA units of total space. 7014-T42 is a 2.0 meter rack with 42 EIA units of total space. The rack includes one PDU, feature code 9188, 9176, 9177, or 9178.</p>			

**9113 rack content, specify code 0230; 9406 rack content, specify code 7886**



IPHAD613-0

Figure 7. 550 in rack

IBM rack	Rack, specify code	PDU support	Power cords
7014 <sup>1</sup>	0230 (9113-550), 7886 (9406-550)	0 to 4 <sup>2</sup>	PDU <sup>3</sup>
<p><sup>1</sup>7014-T00 is a 1.8 meter rack with 36 EIA units of total space. 7014-T42 is a 2.0 meter rack with 42 EIA units of total space. The rack includes one PDU, feature code 9188, 9176, 9177, or 9178.</p> <p><sup>2</sup>0551, 0553, and 0555 feature codes 5160, 5161, 5163, and 7188. 7014 feature codes 7176, 7177, 7178, and 7188.</p> <p><sup>3</sup>If unit plugs into a PDU, two feature code 6458, 6459, 6095, or 9911 power jumper cords are required.</p>			

**9406-570 in rack, 9117-570 rack content, specify codes 0231, 0232, 0241, 0242**

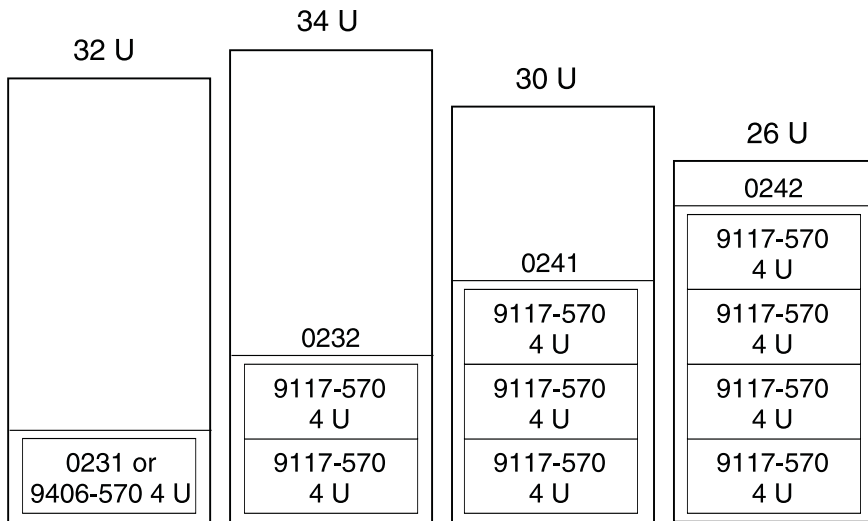

IPHAD608-1

Figure 8. 570 in rack

IBM rack	Rack, specify code	PDU support	Power cords
0551 <sup>1</sup>	0231, 0232, 0241, 0242	0 to 4 <sup>2</sup>	PDU <sup>4</sup>
0553 <sup>1</sup>			
7014 <sup>3</sup>			
0555			

<sup>1</sup>0551 is an empty 1.8 meter rack with 36 EIA units of total space. 0553 is a 2.0 meter rack with 42 EIA units of total space.

<sup>2</sup>0551, 0553, and 0555 feature codes 5160, 5161, 5163, and 7188. 7014 feature codes 7176, 7177, 7178, and 7188.

<sup>3</sup>7014-T00 is a 1.8 meter rack with 36 EIA units of total space. 7014-T42 is a 2.0 meter rack with 42 EIA units of total space. The rack includes one PDU, feature code 9188, 9176, 9177, or 9178.

<sup>4</sup>If unit plugs into a PDU, two feature code 6458, 6459, 6095, or 9911 power jumper cords are required.

**Feature code 0123 - 5074 lower expansion unit in rack; feature code 0574 - 5074 equivalent**

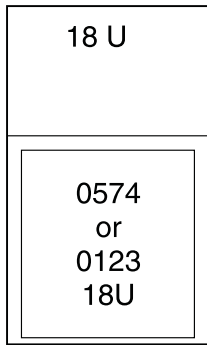

IPHAD600-0

Figure 9. Feature code 0123

IBM rack	Bottom rack, specify code	Rack, specify code	PDU support	Power cords
0551 <sup>1</sup> 0553 <sup>1</sup> 0555	0123	0574	0 to 4 <sup>2</sup>	0123, 0574, PDU <sup>3</sup>
<p><sup>1</sup>0551 is an empty 1.8 meter rack with 36 EIA units of total space. 0553 is a 2.0 meter rack with 42 EIA units of total space.</p> <p><sup>2</sup>0551, 0553, and 0555 feature codes 5160, 5161, 5163, and 7188. 7014 feature codes 7176, 7177, 7178, and 7188.</p> <p><sup>3</sup>Feature code 0123 or 0574 do not plug into a PDU.</p>				

**Feature code 0694 - 5094 equivalent**

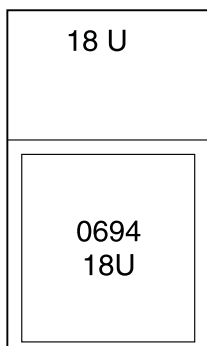

IPHAD601-0

Figure 10. Feature code 0694 - 5094 equivalent

IBM rack	Rack, specify code	PDU support	Power cords
0551 <sup>1</sup> 0553 <sup>1</sup> 0555	0694	0 to 4 <sup>2</sup>	0694, PDU <sup>3</sup>

IBM rack	Rack, specify code	PDU support	Power cords
<sup>1</sup> 0551 is an empty 1.8 meter rack with 36 EIA units of total space. 0553 is a 2.0 meter rack with 42 EIA units of total space. <sup>2</sup> 0551, 0553, and 0555 feature codes 5160, 5161, 5163, and 7188. 7014 feature codes 7176, 7177, 7178, and 7188. <sup>3</sup> Feature code 0125 does not plug into a PDU.			

**Feature code 0133 - Manufacturing installation in rack (models 9406-800 and 9406-810); feature code 0137 - IBM service representation installation in rack (models 9406-800 and 9406-810)**

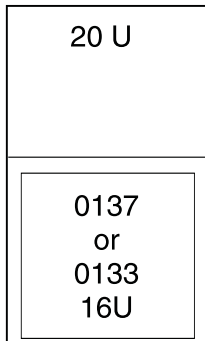

IPHAD602-0

Figure 11. Feature code 0133

IBM rack	Rack, specify code	PDU support	Power cords
0551 <sup>1</sup> 0553 <sup>1</sup> 0555	0133 <sup>3</sup> , 0137 <sup>3</sup>	0 to 4 <sup>2</sup>	0133, 0137, PDU <sup>4</sup>
<sup>1</sup> 0551 is an empty 1.8 meter rack with 36 EIA units of total space. 0553 is a 2.0 meter rack with 42 EIA units of total space. <sup>2</sup> 0551, 0553, and 0555 feature codes 5160, 5161, 5163, and 7188. 7014 feature codes 7176, 7177, 7178, and 7188. <sup>3</sup> IBM service representation installation in rack feature is used to mount a model 9406-270, 9406-800, or 9406-810 system unit (14 U) with attached expansion unit. This feature provides a rack shelf (2 U) with rail assembly, cable-management-arm assembly, adapter plate, and a pair of lift covers. <sup>4</sup> If unit plugs into a PDU, two feature code 6458, 6459, 6095, or 9911 power jumper cords are required.			

**Feature code 0134 - IBM service representation installation in rack (model 9406-825); feature code 0138 - IBM service representation installation in rack (model 9406-825)**

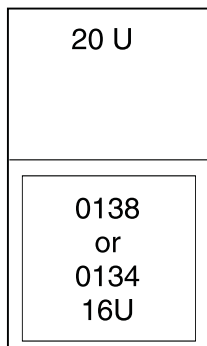

IPHAD603-0

Figure 12. Feature code 0134

IBM rack	Rack, specify code	PDU support	Power cords
0551 <sup>1</sup> 0553 <sup>1</sup> 0555	0134 <sup>3</sup> , 0138 <sup>3</sup>	0 to 4 <sup>2</sup>	0134, 0138, PDU <sup>4</sup>
<p><sup>1</sup>0551 is an empty 1.8 meter rack with 36 EIA units of total space. 0553 is a 2.0 meter rack with 42 EIA units of total space.</p> <p><sup>2</sup>0551, 0553, and 0555 feature codes 5160, 5161, 5163, and 7188. 7014 feature codes 7176, 7177, 7178, and 7188.</p> <p><sup>3</sup>IBM service representation installation in rack feature is used to mount a model 9406-825 system unit (14 U). This feature provides a rack shelf (2 U), cable-management-arm assembly, adapter plate, and a pair of lift covers.</p> <p><sup>4</sup>If unit plugs into a PDU, two feature code 6458, 6459, 6095, or 9911 power jumper cords are required.</p>			

**Feature code 0578 - PCI-X expansion unit in rack**

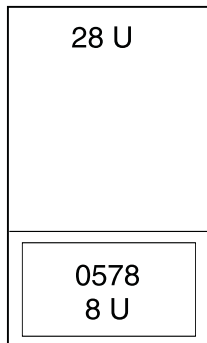

IPHAD604-0

Figure 13. Feature code 0578 - PCI-X expansion unit in rack



IBM rack	Rack, specify code	PDU support	Power cords
0551 <sup>1</sup>	0578	0 to 4 <sup>2</sup>	PDU <sup>3</sup>
0553 <sup>1</sup>			
0555			
<p><sup>1</sup>0551 is an empty 1.8 meter rack with 36 EIA units of total space. 0553 is a 2.0 meter rack with 42 EIA units of total space.</p> <p><sup>2</sup>0551, 0553, and 0555 feature codes 5160, 5161, 5163, and 7188. 7014 feature codes 7176, 7177, 7178, and 7188.</p> <p><sup>3</sup>0578 includes two rack power cords that plug into a PDU.</p>			

### Feature code 0588 - PCI-X expansion unit in rack

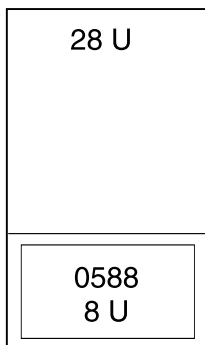

IPHAD605-0

Figure 14. Feature code 0588 - PCI-X expansion unit in rack

IBM rack	Rack, specify code	PDU support	Power cords
0551 <sup>1</sup>	0588	0 to 4 <sup>2</sup>	PDU <sup>3</sup>
0553 <sup>1</sup>			
0555			
<p><sup>1</sup>0551 is an empty 1.8 meter rack with 36 EIA units of total space. 0553 is a 2.0 meter rack with 42 EIA units of total space.</p> <p><sup>2</sup>0551, 0553, and 0555 feature codes 5160, 5161, 5163, and 7188. 7014 feature codes 7176, 7177, 7178, and 7188.</p> <p><sup>3</sup>0588 comes with two rack power cords that plug into a PDU.</p>			

## Feature code 0595 - PCI-X expansion unit in rack

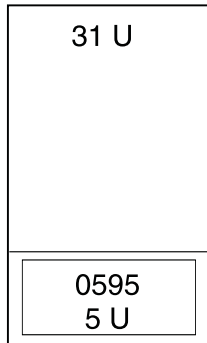

IPHAD606-0

IBM rack	Rack, specify code	PDU support	Power cords
0551 <sup>1</sup>	0595	0 to 4 <sup>2</sup>	0595, PDU <sup>3</sup>
0553 <sup>1</sup>			
0555			
<p><sup>1</sup>0551 is an empty 1.8 meter rack with 36 EIA units of total space. 0553 is a 2.0 meter rack with 42 EIA units of total space.</p> <p><sup>2</sup>0551, 0553, and 0555 feature codes 5160, 5161, 5163, and 7188. 7014 feature codes 7176, 7177, 7178, and 7188.</p> <p><sup>3</sup>If unit plugs into a PDU, feature code 1422 is required. If redundant power supply (feature code 5138) is ordered, a second feature code 1422 is required.</p>			

**Note:** Supported only on MES orders and includes a rack shelf with rail assembly, adapter plate, and cable-management-arm assembly.

## 0551 model 9406-270 rack system units

Server specifications provide detailed information for your server, including dimensions, electrical, power, temperature, environment, and service clearances.

Pictured is the 0551 model 9406-270 Rack system units. The 0551 consists of two models 9406-270 with 7104 system unit expansions installed in a 1.8 m rack. Specify code 0121 represents the first model 9406-270 in the rack (on the bottom). Specify code 0122 represents the second model 9406-270 in the rack (on the top).



Figure 15. 0551 model 9406-270 Rack system units

Table 90. Dimensions

Maximum configuration weight <sup>1</sup>	Height	Width	Depth
403 kg (885 lb)	1800 mm (71.0 in.)	650 mm (25.5 in.)	1020 mm (40.0 in.)
<sup>1</sup> Side and top clearances are optional when operating.			

Table 91. Electrical

Electrical characteristics	Properties
kVA (maximum)	0.789
Rated voltage and frequency	100 - 127 or 200 - 240 V ac at 50 - 60 plus or minus 0.5 Hz
Thermal output (maximum)	2560 Btu/hr
Power requirements (maximum)	750 W
Power factor	0.95
Inrush current	41 A
Leakage current (maximum)	3.5 mA
Phase	1

Table 92. Temperature requirements

Operating	Nonoperating
10 - 38°C (50 - 100.4°F)	1 - 60°C (33.8 - 140°F)

Table 93. Environment requirements

Environment	Operating	Nonoperating
Wet bulb temperature	23°C (73.4°F)	27°C (80.6°F)

Table 93. Environment requirements (continued)

Environment	Operating	Nonoperating
Maximum altitude	3048 m (10 000 ft)	3048 m (10 000 ft)

Table 94. Noise emissions

Properties	Operating	Idle
$L_{WAd}$ (Category 2E, General business)	6.6 bels	6.3 bels
$\langle L_{pA} \rangle_m$	48 dB	46 dB
For a description of noise emission values, see Acoustics.		



Table 95. Service clearances

Front	Back	Sides	Top
762 mm (30 in. )	762 mm (30 in. )	762 mm (30 in. )	762 mm (30 in. )
Side and top clearances are optional when operating.			

**Notes:**

1. The 1.8 meter rack has six EIA units of space remaining. This space will be filled with a three-EIA filler panel and three of the one-EIA filler panels.
2. Only the 4.3 m (14 ft) power cord features are offered for racked 9406-270 systems. There are a total of four power cords that are routed through cable management arms. Also, there is a cable management device that might be used to restrict the length of the power cord exiting the bottom of the rack. See model 9406-270 Cable Poster Addendum included with the 0551 model 9406-270 rack.
3. The rack does not have power distribution. Each model 9406-270 and 7104 requires a power cord of sufficient length to reach the receptacle. The power cord feature codes for model 9406-270s must be used to determine the appropriate receptacles.

**Related information:**

-  [Planning for the installation of rear door heat exchangers](#)
-  [Acoustics](#)

**Model 0554 and 7014-S11 rack**

Hardware specifications provide detailed information for your rack, including dimensions, electrical, power, temperature, environment, and service clearances.

Table 96. Dimensions

Dimension	Properties
Height	611 mm (24 in.)
Capacity	11 usable EIA units
Height with PDP - DC only	Not applicable
Width without side panels	Not applicable
Width with side panels	518 mm (20.4 in.)
Depth without doors	820 mm (32.3 in.)
Depth with front door	873 mm (34.4 in.)
Depth with sculptured style front door	Not applicable
Weight Base rack (empty)	36 kg (80 lb)
Weight Full rack <sup>1</sup>	218 kg (481 lb)

Table 97. Electrical

Electrical characteristics	Properties
DC rack voltage (nominal)	Not applicable
Power source loading maximum in kVa	Not applicable
Voltage range (V dc)	Not applicable
AC rack	See your server or hardware specifications for specific requirements
Power source loading maximum in kVa (per PDU)	See your server or hardware specifications for specific requirements
Voltage range (V ac)	See your server or hardware specifications for specific requirements
Frequency (Hz)	50 or 60
The 7188 power distribution unit used with this rack is mounted horizontally and requires one EIA unit of space.	

Table 98. Service clearances

Front	Back	Sides
915 mm (36 in.)	254 mm (10 in.)	71 mm (2.8 in.)
Recommended minimum vertical service clearance from floor is 2439 mm (8 ft).		

See your server or hardware specifications for specific temperature requirements and humidity requirements.

Rack noise levels are a function of the number and type of drawers installed. See your server or hardware specifications for specific requirements.

Rack airflow requirements are a function of the number and type of drawers installed. Refer to the individual drawer specifications.

**Note:** Configuration dependent, base rack weight plus the weight of the drawers mounted in the rack. The rack can support up to a maximum weight of 15.9 kg (35 lb) per EIA unit.

### Model 0554 and 7014-S11 rack operational clearances

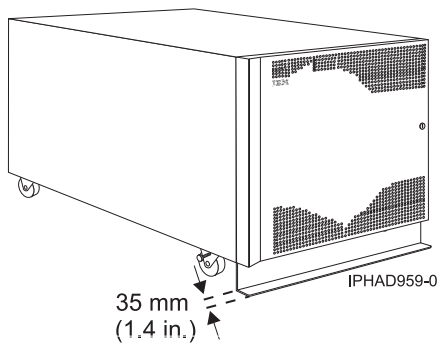

Figure 16. Model 0554 and 7014-S11 with stabilizer bar

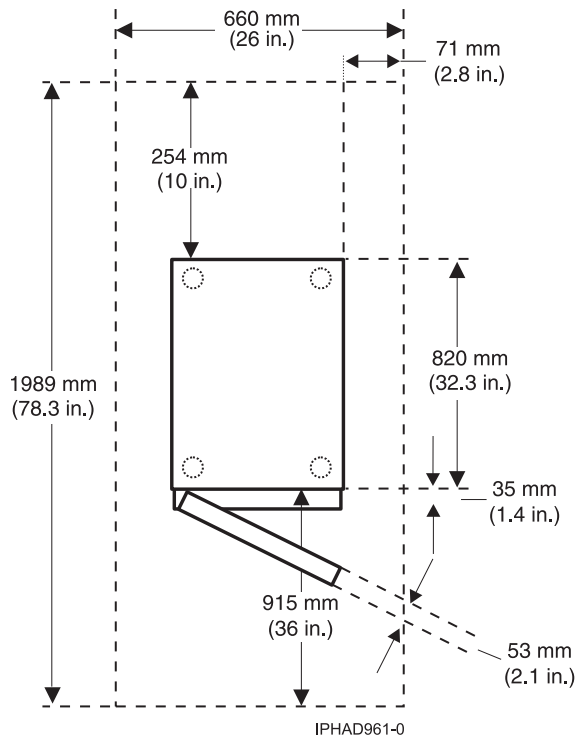

Figure 17. Model 0554 and 7014-S11 plan view

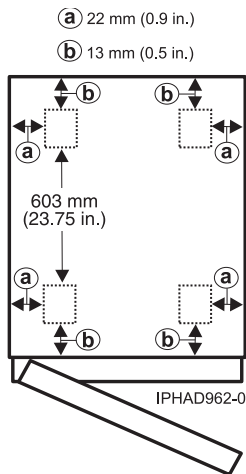

Figure 18. Model 0554 and 7014-S11 caster locations

## Model 0555 and 7014-S25 rack

Hardware specifications provide detailed information for your rack, including dimensions, electrical, power, temperature, environment, and service clearances.

Table 99. Dimensions

Dimensions	Properties
Height	1240 mm (49 in.)
Capacity	25 usable EIA units

Table 99. Dimensions (continued)

Dimensions	Properties
Height with PDP - DC only	Not applicable
Width without side panels	590 mm (23.2 in.)
Width with side panels	610 mm (24 in.)
Depth with back door only	996 mm (39.2 in.)
Depth with back door and front door	1000 mm (39.4 in.)
Depth with sculptured style front door	Not applicable
Base rack (empty)	98 kg (217 lb)
Full rack <sup>1</sup>	665 kg (1467 lb)

Table 100. Electrical

Electrical characteristics	Properties
DC rack voltage (nominal)	Not applicable
Power source loading maximum in kVa	Not applicable
Voltage range (V dc)	Not applicable
AC rack	See your server or hardware specifications for specific requirements
Power source loading maximum in kVa (per PDU)	See your server or hardware specifications for specific requirements
Voltage range (V ac)	See your server or hardware specifications for specific requirements
Frequency (Hz)	50 or 60
The 7188 power distribution unit used with this rack is mounted horizontally and requires one EIA unit of space.	

Table 101. Service clearance

Front	Back	Sides
915 mm (36 in.)	760 mm (30 in.)	915 mm (36 in.)

See your server or hardware specifications for specific temperature and humidity requirements.

Rack noise levels are a function of the number and type of drawers installed. See your server or hardware specifications for specific requirements.

Rack airflow requirements are a function of the number and type of drawers installed. Refer to the individual drawer specifications.

**Notes:**

1. Configuration dependent, base rack weight plus the weight of the drawers mounted in the rack. The rack can support up to a maximum weight of 22.7 kg (50 lb) per EIA unit.
2. Recommended minimum vertical service clearance from floor is 2439 mm (8 ft).

## Model 0555 and 7014-S25 rack operational clearances

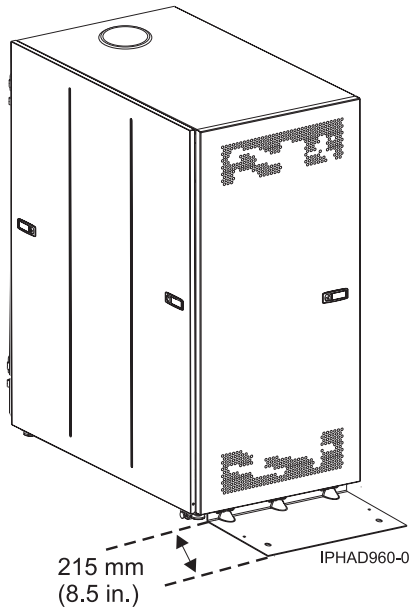

Figure 19. Model 0555 and 7014-S25 with stabilizer foot



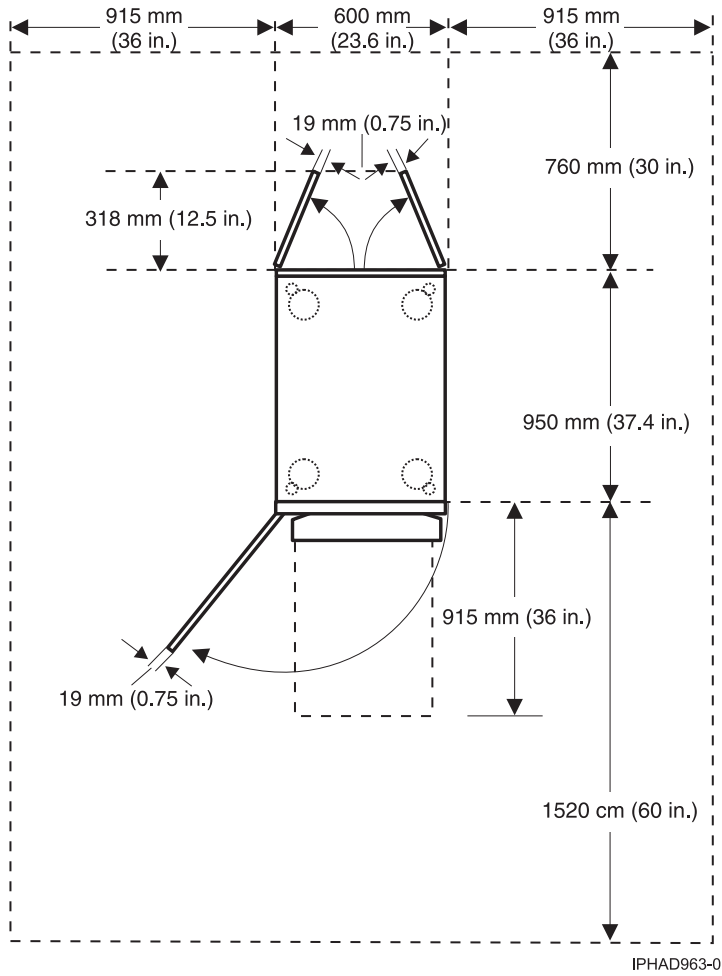

Figure 20. Model 0555 and 7014-S25 plan view

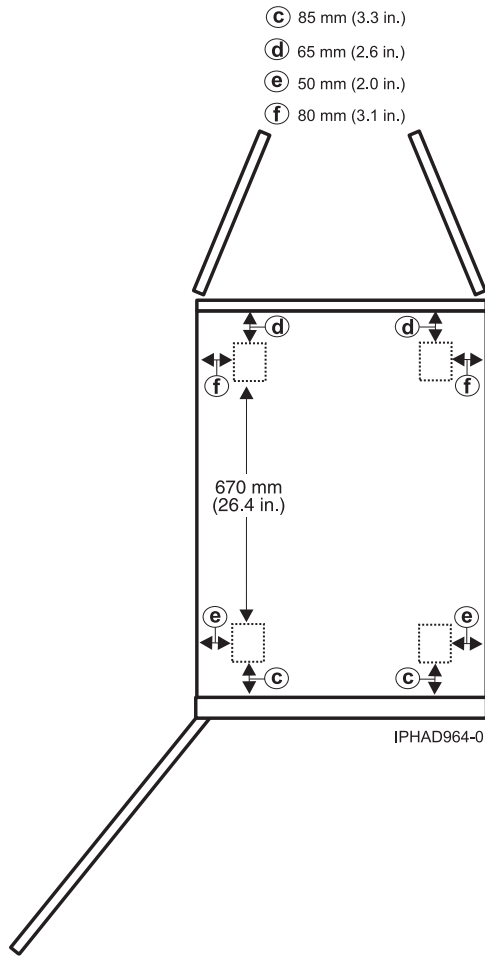

Figure 21. Model 0555 and 7014-S25 caster locations

## Planning for the 7014-T00 and 7014-T42 racks

Rack specifications provide detailed information for your rack, including dimensions, electrical, power, temperature, environment, and service clearances.

The following provide specifications for the 7014-T00, and 7014-T42 or 0553 racks.

### Model 7014-T00 rack

Hardware specifications provide detailed information for your rack, including dimensions, electrical, power, temperature, environment, and service clearances.

Table 102. Dimensions

Dimensions	Properties
Height	1804 mm (71.0 in.)
Capacity	36 usable EIA units
Height with PDP - DC only	1926 mm (75.8 in.)
Width without side panels	623 mm (24.5 in.)
Width with side panels	644 mm (25.4 in.)
Depth with rear door only	1042 mm (41.0 in.)

Table 102. Dimensions (continued)

Dimensions	Properties
Depth with rear door and front door	1098 mm (43.3 in.)
Depth with sculptured style front door	1147 mm (45.2 in.)

Table 103. Weight

Base rack (empty)	Full rack
244 kg (535 lb)	816 kg (1795 lb) See 7014-T00, 7014-T42 and 0553 rack weight distribution and floor loading

Table 104. Electrical<sup>1</sup>

Electrical characteristics	Properties
DC rack voltage (nominal)	-48 V dc
Power source loading maximum in kVa <sup>2</sup>	See Power distribution unit and power cord options for 7014, 0551, 0553, and 0555 rack for details
Voltage range (V dc)	-40 - -60
AC rack	683 Btu/hr
Power source loading maximum in kVa (per PDB) <sup>3</sup>	135 W
Voltage range (V ac)	200 - 240
Frequency (Hz)	50 or 60
<sup>1</sup> The total rack power should be derived from the sum of the power used by the drawers in the rack. <sup>2</sup> The power distribution panel (PDP) on the DC-powered rack can hold up to eighteen (nine per power source) 48-volt, 20 - 50 amperes circuit breakers (configuration dependent). Each power source supports up to 8.4 kVa. <sup>3</sup> Each ac power distribution bus (PDB) can supply 4.8 kVa. A rack can have up to four PDBs as required by the drawers mounted in the rack.	

Table 105. Service clearances

Front	Back	Sides
915 mm (36 in.)	915 mm (36 in.)	915 mm (36 in.)

See your server or hardware specifications for specific temperature and humidity requirements.

Rack noise levels are a function of the number and type of drawers installed. See your server or hardware specifications for specific requirements.

**Note:** All rack installations require careful site and facilities planning designed to both address the cumulative drawer heat output and provide the airflow volume rates necessary to comply with drawer temperature requirements.

Rack airflow requirements are a function of the number and type of drawers installed.

**Note:** Acoustic doors are available for the IBM racks. Feature code 6248 is available for the 0551 and 7014-T00 racks. Feature code 6249 is available for the 0553 and 7014-T42 racks. The overall sound reduction is approximately 6 dB. The doors add 381 mm (15 in.) to the depth of the racks. Refer to the individual drawer specifications.

**Related reference:**

“7014-T00, 7014-T42, and 0553 rack weight distribution and floor loading” on page 58

Racks can be heavy when populated with several drawers. Use the Weight distribution distances for racks when loaded and Floor loading for racks when loaded tables to ensure proper floor loading and weight distribution.

**Model 7014-T42, 7014-B42, and 0553 rack**

Hardware specifications provide detailed information for your rack, including dimensions, electrical, power, temperature, environment, and service clearances.

**Note:** Before installing rear door heat exchangers on your 7014-T42 rack, see Planning for the installation of rear door heat exchangers.

*Table 106. Dimensions*

Dimensions	Properties
Height	2015 mm (79.3 in.)
Capacity	42 usable EIA units
Height with PDP - DC only	Not applicable
Width without side panels	623 mm (24.5 in.)
Width with side panels	644 mm (25.4 in)
Depth with back door only	1042 mm (41.0 in.)
Depth with back door and front door	1098 mm (43.3 in.)
Depth with sculptured style front door	1147 mm (45.2 in.)
Depth with ERG7 front door	1176 mm (46.3 in.)
Weight base rack (empty)	261 kg (575 lb)
Weight full rack	930 kg (2045 lb)  See “7014-T00, 7014-T42, and 0553 rack weight distribution and floor loading” on page 58.
Weight slim doors	15.4 kg (34 lb)
Weight side covers	16.3 kg (36 lb)
Weight ERG7 doors	16.8 kg (37 lb)

*Table 107. Electrical<sup>1</sup>*

Electrical characteristics	Properties
DC rack voltage (nominal)	-48 V dc
Power source loading maximum in kVa <sup>2</sup>	See “Power distribution unit and power cord options for 7014, 0551, 0553, and 0555 racks” on page 138.
Voltage range (V dc)	-40 to -60
AC rack	683 Btu/hr
Power source loading maximum in kVa (per PDB) <sup>3</sup>	135 W
Voltage range (V ac)	200 - 240 V ac
Frequency (Hz)	50 or 60

Table 107. Electrical<sup>1</sup> (continued)

Electrical characteristics	Properties
<sup>1</sup> Recommended minimum vertical service clearance from floor is 2439 mm (8 ft).	
<sup>2</sup> When installing a model 9117-MMB or 9179-MHB in a 7014-T42 rack, there are restrictions to what height the rack installation can begin so that SMP and FSP flex assemblies are accommodated. The installation configurations are as follows:	
<ul style="list-style-type: none"> <li>• 16-core configurations (16U) start installation between EIA 1 through EIA 21</li> <li>• 12-core configurations (12U) start installation between EIA 1 through EIA 25</li> <li>• 8-core configurations (8U) start installation between EIA 1 through EIA 29</li> <li>• 4-core configurations (4U) start installation between EIA 1 through EIA 37, EIA 37 through 39 (does not use SMP or SMP flex assemblies)</li> </ul>	
Associated I/O platforms can be mounted in the upper locations of the rack.	
<sup>3</sup> Acoustic doors are available for the IBM racks. Feature code 6248 is available for the 0551 and 7014-T00 racks. Feature code 6249 is available for the 0553 and 7014-T42 racks. The overall sound reduction is approximately 6 dB. The doors add 381 mm (15 in.) to the depth of the racks.	

Table 108. Service clearances

Front	Back	Sides
915 mm (36 in.)	915 mm (36 in.)	915 mm (36 in.)
Recommended minimum vertical service clearance from floor is 2439 mm (8 ft).		

See your server or hardware specifications for specific requirements.

Rack noise levels are a function of the number and type of drawers installed. See your server or hardware specifications for specific requirements.

**Note:** Acoustic doors are available for the IBM racks. Feature code 6248 is available for the 0551 and 7014-T00 racks. Feature code 6249 is available for the 0553 and 7014-T42 racks. The overall sound reduction is approximately 6 dB. The doors add 381 mm (15 in.) to the depth of the racks.

Rack airflow requirements are a function of the number and type of drawers installed.

**Note:** All rack installations require careful site and facilities planning designed to address both the cumulative drawer heat output and provide the airflow volume rates necessary to comply with drawer temperature requirements.

Refer to the individual drawer specifications.

### Caster and leveler locations

The following figure provides the caster and leveler locations for the 7014-T00, 7014-T42, 0551, 0553, and 0555 racks.

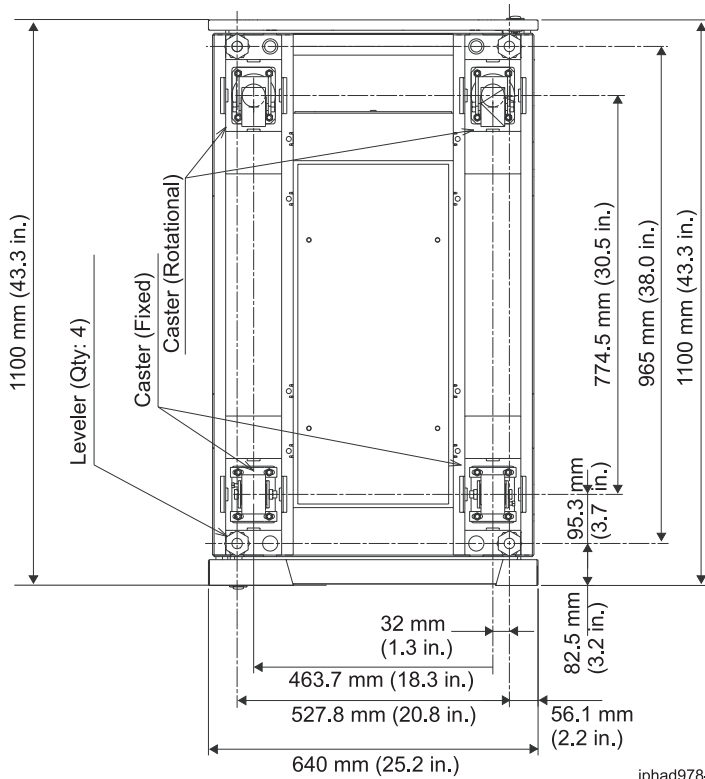

Figure 22. Caster and leveler locations

**Related reference:**

“7014-T00, 7014-T42, and 0553 rack weight distribution and floor loading” on page 58  
 Racks can be heavy when populated with several drawers. Use the Weight distribution distances for racks when loaded and Floor loading for racks when loaded tables to ensure proper floor loading and weight distribution.

**Related information:**

➡ Planning for the installation of rear door heat exchangers

**7014-T00, 7014-T42, and 0553 service clearances and caster location**

Use the service clearances and caster location for 7014-T00, 7014-T42 and 0553 racks figure to plan the correct service clearances and caster locations for your rack.

The service clearances and caster locations are shown in the following figure:

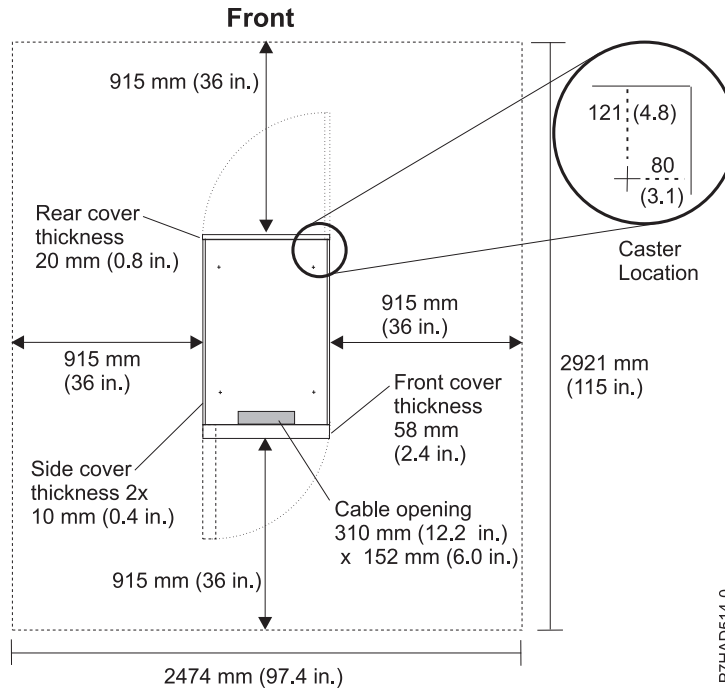
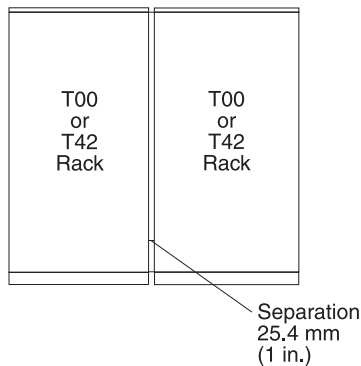

Figure 23. Service clearances and caster location for 7014-T00, 7014-T42, and 0553 racks

**Note:** Rack units are large and heavy and are not easily moved. Because maintenance activities require access at both the front and back, extra room needs to be allowed. The footprint shows the radius of the swinging doors on the I/O rack. The figure shows the minimum space required.

### 7014-T00, 7014-T00, and 0553 racks multiple attachment

7014-T00, 7014-T42 or 0553 racks can be bolted together in a multiple rack arrangement. This figure shows that arrangement.



A kit is available including the bolts, spacers, and decorative trim pieces to cover the 25.4 mm (1 in.) space. For service clearances, see the service clearances as shown in the table for the model 7014-T00 rack.

#### Related reference:

“Model 7014-T00 rack” on page 52

Hardware specifications provide detailed information for your rack, including dimensions, electrical, power, temperature, environment, and service clearances.

## 7014-T00, 7014-T42, and 0553 rack weight distribution and floor loading

Racks can be heavy when populated with several drawers. Use the Weight distribution distances for racks when loaded and Floor loading for racks when loaded tables to ensure proper floor loading and weight distribution.

The 7014-T00, 7014-T42, and 0553 racks can be extremely heavy when several drawers are present. The following table shows the necessary weight distribution distances for the 7014-T00, 7014-T42, and 0553 racks when loaded.

Table 109. Weight distribution distances for racks when loaded

Rack	System weight <sup>1</sup>	Width <sup>2</sup>	Depth <sup>2</sup>	Weight distribution distance <sup>3</sup>	
				Front and back	Left and right
7014-T00 <sup>4</sup>	816 kg (1795 lb)	623 mm (24.5 in)	1021 mm (40.2 in)	515.6 mm (20.3 in), 477.5 mm (18.8 in)	467.4 mm (18.4 in)
7014-T00 <sup>5</sup>	816 kg (1795 lb)	623 mm (24.5 in)	1021 mm (40.2 in)	515.6 mm (20.3 in), 477.5 mm (18.8 in)	0
7014-T00 <sup>6</sup>	816 kg (1795 lb)	623 mm (24.5 in)	1021 mm (40.2 in)	515.6 mm (20.3 in), 477.5 mm (18.8 in)	559 mm (22 in)
7014-T42 and 0553 <sup>4</sup>	930 kg (2045 lb)	623 mm (24.5 in)	1021 mm (40.2 in)	515.6 mm (20.3 in), 477.5 mm (18.8 in)	467.4 mm (18.4 in)
7014-T42 and 0553 <sup>5</sup>	930 kg (2045 lb)	623 mm (24.5 in)	1021 mm (40.2 in)	515.6 mm (20.3 in), 477.5 mm (18.8 in)	0
7014-T42 and 0553 <sup>6</sup>	930 kg (2045 lb)	623 mm (24.5 in)	1021 mm (40.2 in)	515.6 mm (20.3 in), 477.5 mm (18.8 in)	686 mm (27 in)

**Notes:**

1. Maximum weight of fully populated rack, units are lb with kg in parentheses.
2. Dimensions without covers, units are inches with mm in parentheses.
3. The weight distribution distance in all four directions is the area around the rack perimeter (minus covers) necessary to distribute the weight beyond the perimeter of the rack. Weight distribution areas cannot overlap with adjacent computer equipment weight distribution areas. Units are inches with mm in parentheses.
4. Weight distribution distance is 1/2 the service clearance values shown in the figure plus cover thickness.
5. No left and right weight distribution distance.
6. Left and right weight distribution distance required for a 70 lb/ft<sup>2</sup> raised floor loading objective.

The following table shows the necessary floor loading for the 7014-T00, 7014-T42 and 0553 racks when loaded.

Table 110. Floor loading for racks when loaded

Rack	Floor loading			
	Raised kg/m <sup>1</sup>	Non-raised kg/m <sup>1</sup>	Raised lb/ft <sup>1</sup>	Non-raised lb/ft <sup>1</sup>
7014-T00 <sup>2</sup>	366.7	322.7	75	66
7014-T00 <sup>3</sup>	734.5	690.6	150.4	141.4
7014-T00 <sup>4</sup>	341	297	70	61
7014-T42 and 0553 <sup>2</sup>	403	359	82.5	73.5
7014-T42 and 0553 <sup>3</sup>	825	781	169	160
7014-T42 and 0553 <sup>4</sup>	341.4	297.5	70	61



Table 110. Floor loading for racks when loaded (continued)

Rack	Floor loading			
	Raised kg/m <sup>1</sup>	Non-raised kg/m <sup>1</sup>	Raised lb/ft <sup>1</sup>	Non-raised lb/ft <sup>1</sup>
<b>Notes:</b>				
1. Dimensions without covers, units are inches with mm in parentheses.				
2. Weight distribution distance is 1/2 the service clearance values shown in the figure plus cover thickness.				
3. No left and right weight distribution distance.				
4. Left and right weight distribution distance required for a 70 lb/ft <sup>2</sup> raised floor loading objective.				

**Related reference:**

“Model 7014-T42, 7014-B42, and 0553 rack” on page 54

Hardware specifications provide detailed information for your rack, including dimensions, electrical, power, temperature, environment, and service clearances.

“Model 7014-T00 rack” on page 52

Hardware specifications provide detailed information for your rack, including dimensions, electrical, power, temperature, environment, and service clearances.

**Planning for the 7953-94X and 7965-94Y rack**

Rack specifications provide detailed information for your rack, including dimensions, electrical, power, temperature, environment, and service clearances.

The following provide specifications for the 7953-94X and 7965-94Y rack.

**Model 7953-94X and 7965-94Y rack**

Hardware specifications provide detailed information for your rack, including dimensions, electrical, power, temperature, environment, and service clearances.

Table 111. Dimensions for rack

	Width	Depth	Height	Weight (Empty)	Weight (Maximum configuration)	EIA unit capacity
Rack only	600 mm (23.6 in.)	1095 mm (43.1 in.)	2002 mm (78.8 in.)	130 kg (287 lb)	1140 kg (2512 lb)	42 EIA units
Rack with standard doors	600 mm (23.6 in.)	1145.5 mm (45. in.)	2002 mm (78.8 in.)	138 kg (304 lb)	N/A	N/A
Rack with triplex doors	600 mm (23.6 in.)	1206.2 - 1228.8 mm (47.5 - 48.4 in.)	2002 mm (78.8 in.)	147 kg (324 lb)	N/A	N/A
Rack with rear door heat exchanger indicator	600 mm (23.6 in.)	1224 mm (48.2 in.)	2002 mm (78.8 in.)	169 kg (373 lb)	N/A	N/A

**Note:** When the rack is delivered or is moved, outriggers are needed for stability. For more information about outriggers, see “Side stabilizing outriggers” on page 63.

Table 112. Dimensions for doors

Door model	Width	Height	Depth	Weight
Standard front door (FC EC01) and standard back door (FC EC02)	597 mm (23.5 in.)	1925 mm (75.8 in.)	22.5 mm (0.9 in.)	7.7 kg (17 lb)
Triplex door (FC EU21) <sup>3</sup>	597.1 mm (23.5 in.)	1923.6 mm (75.7 in.)	105.7 mm (4.2 in.) <sup>1</sup>	16.8 kg (37 lb)
			128.3 mm (5.2 in.) <sup>2</sup>	
<sup>1</sup> Measured from the front flat surface of the door. <sup>2</sup> Measured from the IBM logo on the front of the door. <sup>3</sup> Multiple racks that are placed side-by-side must have a 6 mm (0.24 in.) minimum clearance between racks to allow the triplex front door to hinge properly. Feature code EC04 (Rack suite attachment kit) can be used to maintain the 6 mm (0.24 in.) minimum clearance between racks.				

Table 113. Dimensions for side covers<sup>1</sup>

Depth	Height	Weight
885 mm (34.9 in.)	1870 mm (73.6 in.)	17.7 kg (39 lb)
<sup>1</sup> Side covers do not increase the overall width of the rack.		

Table 114. Temperature requirements

Operating	Nonoperating
10°C - 38°C (50°F - 100.4°F) <sup>1</sup>	-40°C to 60°C (-40°F to 140°F)
<sup>1</sup> The maximum 38°C (100.4°F) temperature must be derated 1°C (1.8 °F) per 137 m (450 ft) above 1295 m (4250 ft).	

Table 115. Environmental requirements

Environment	Operating	Nonoperating	Maximum altitude
Noncondensing humidity	20% - 80% (allowable)	8% - 80% (including condensing)	2134 m (7000 ft) above sea level
	40% - 55% (recommended)		
Wet bulb temperature	21°C (69.8°F)	27°C (80.6°F)	

Table 116. Service clearances

Front	Back	Side <sup>1</sup>
915 mm (36 in.)	915 mm (36 in.)	610 mm (24 in.)
<sup>1</sup> Side service clearance is only required when outriggers are on the rack. Side service clearance is not required during normal operation of the rack when outriggers are not installed.		

## Rear door heat exchanger

Specifications for Power orderable feature code (FC): EC05 - Rear door heat exchanger indicator (Model 1164-95X).

Table 117. Dimensions for rear door heat exchanger

Width	Depth	Height	Weight (empty)	Weight (filled)
600 mm (23.6 in.)	129 mm (5.0 in.)	1950 mm (76.8 in.)	39 kg (85 lb)	48 kg (105 lb)
For more information, see "Model 1164-95X rear door heat exchanger" on page 65.				

## Electrical

For electrical requirements, see Power distribution unit and power cord options.

## Features

The 7953-94X and 7965-94Y rack has the following features available for use:

- Recirculation prevention plate that is installed at the bottom, front of the rack.
- Stabilizer bracket that is installed at the front of the rack.

## Caster locations

The following diagram provides the caster locations for the 7953-94X and 7965-94Y rack.

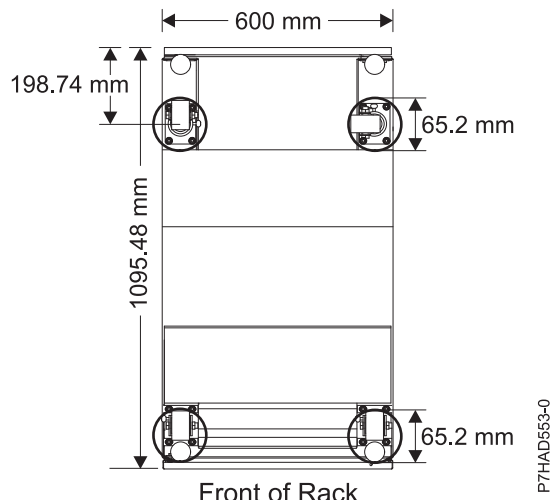

Figure 24. Caster locations

## Cabling the 7953-94X and 7965-94Y rack

Learn about the different cable routing options available for the 7953-94X and 7965-94Y rack.

### Cabling within the rack

Side cable channels are available in the rack to route cables. There are two cable channels on each side of the rack as shown in Figure 25 on page 62.

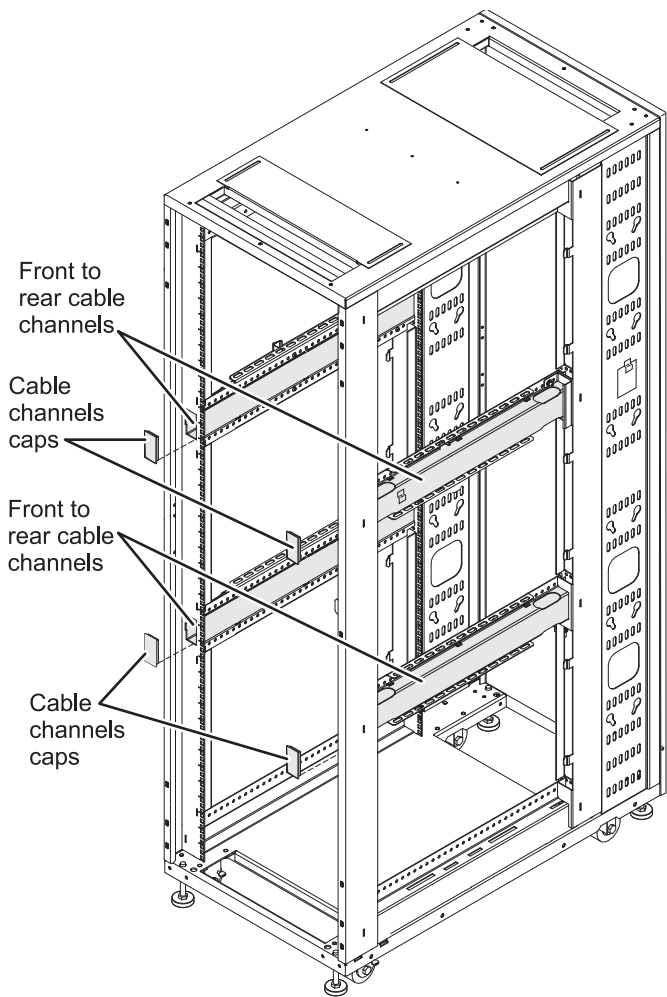

Figure 25. Cabling within the rack

### Cabling under the floor

A cable access bar located on the bottom rear of the rack helps to route the cables, leaving the rack in place. This bar can be removed for installation and then reattached after the rack is installed and cabled.

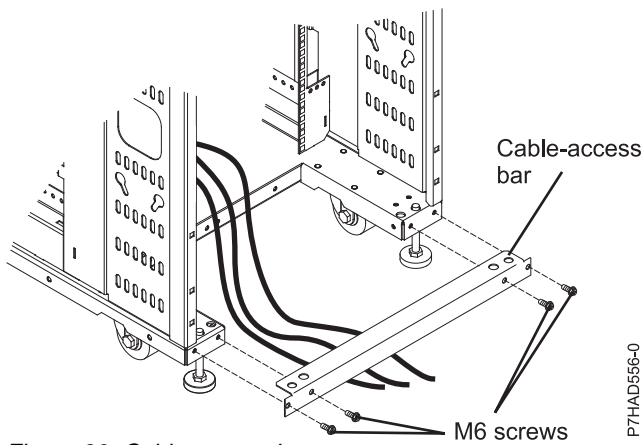

Figure 26. Cable access bar

## Cabling overhead

Front and rear rectangular cable access openings located on the top of the rack cabinet allow cables to be routed up and out of the rack. Cable access covers are adjustable by loosening the side screws and sliding the covers forward or backward.

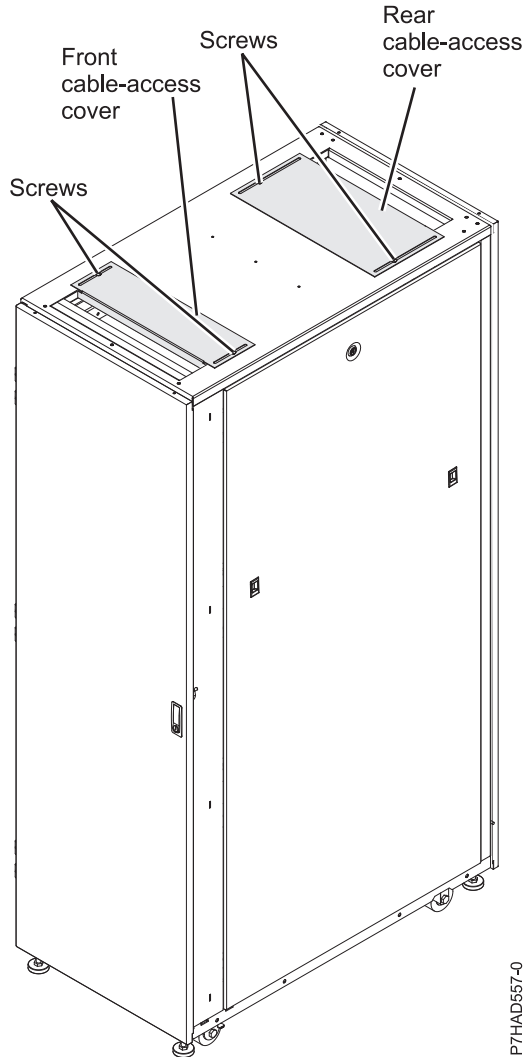

Figure 27. Cable access covers

## Side stabilizing outriggers

Learn about the side stabilizing outriggers available for the 7953-94X and 7965-94Y rack.

The outriggers are stabilizers with wheels installed on the sides of the rack cabinet. The outriggers can be removed only after the rack is in the final location and will not be moved more than 2 m (6 ft) away in any direction.

To remove the outriggers, use a 6 mm hex wrench to remove the four bolts that attach each outrigger to the rack cabinet.

Keep each of the outriggers and bolts in a safe place for future use when moving the rack. Reinstall the outriggers to move the rack cabinet to another location that is greater than 2 m (6 ft) away from its current location.

Table 118. Dimensions for rack with outriggers

Width	Depth	Height	Weight	EIA unit capacity
780 mm (30.7 in.)	1095 mm (43.1 in.)	2002 mm (78.8 in.)	261 kg (575 lb)	42 EIA units

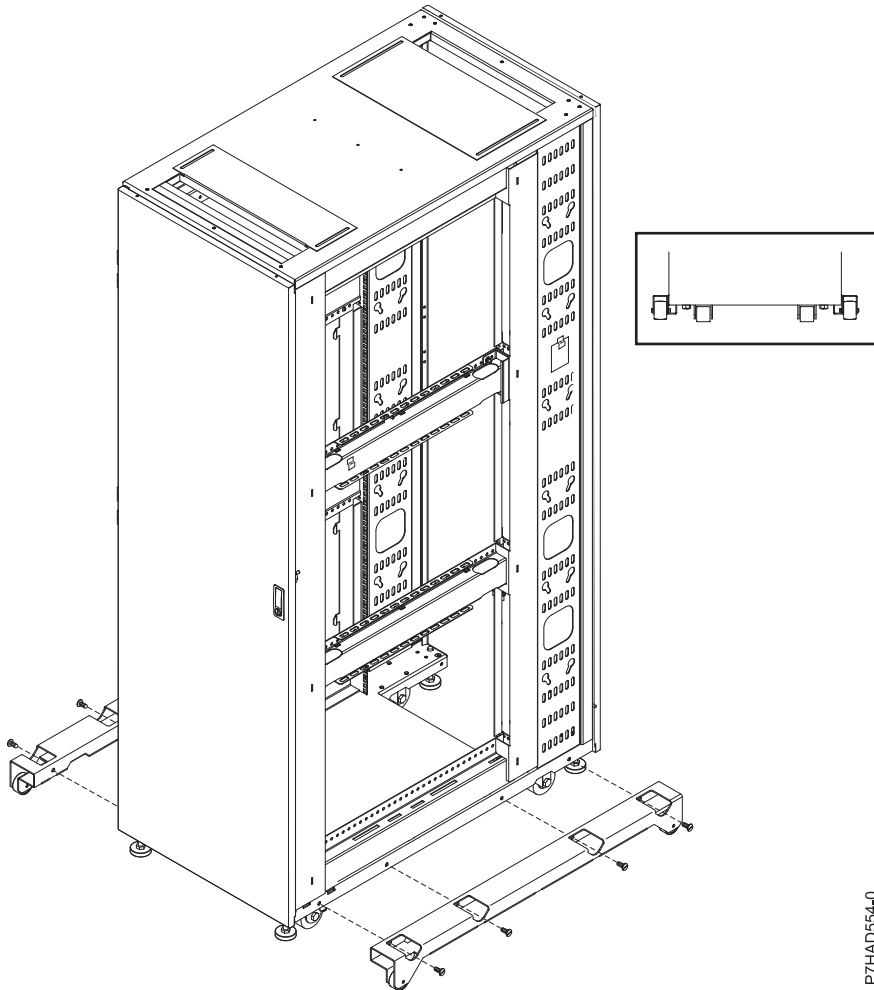

Figure 28. Outrigger locations

P7HAD554-0

## Multiple racks

Learn how to attach multiple 7953-94X and 7965-94Y racks together.

Multiple 7953-94X and 7965-94Y racks can be attached together via attachment brackets connecting the units at the front of the rack. See Figure 29 on page 65.

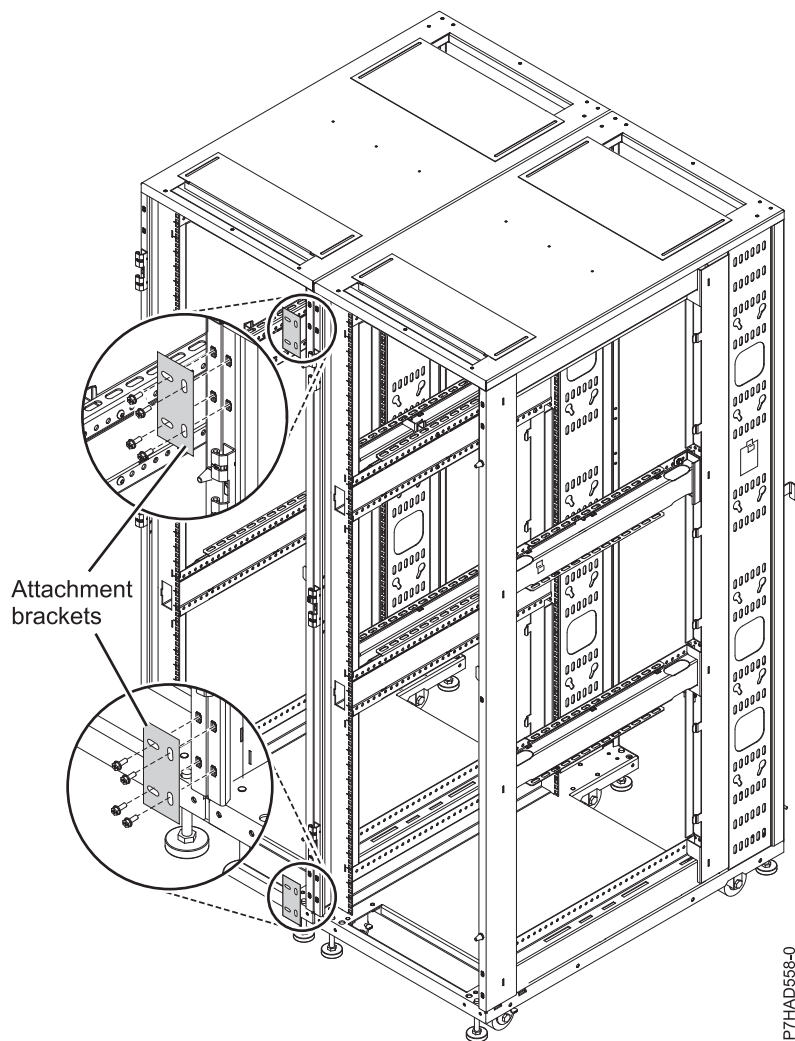

Figure 29. Attachment brackets

## Model 1164-95X rear door heat exchanger

Learn about the specifications of the 1164-95X rear door heat exchanger (feature code EC05).

### Water specifications

- Pressure
  - Normal operation: <math>< 137.93 \text{ kPa}</math> (20 psi)
  - Maximum: 689.66 kPa (100 psi)
- Volume
  - Approximately 9 liters (2.4 gallons)
- Temperature
  - Water temperature must be above the dew point in the data center
  - $18^{\circ}\text{C} \pm 1^{\circ}\text{C}$  ( $64.4^{\circ}\text{F} \pm 1.8^{\circ}\text{F}$ ) for ASHRAE Class 1 Environment
  - $22^{\circ}\text{C} \pm 1^{\circ}\text{C}$  ( $71.6^{\circ}\text{F} \pm 1.8^{\circ}\text{F}$ ) for ASHRAE Class 2 Environment
- Required water flow rate (as measured from the supply entrance to the heat exchanger)
  - Minimum: 22.7 liters (6 gallons) per minute
  - Maximum: 56.8 liters (15 gallons) per minute

## Heat exchanger performance

A heat removal of 100% indicates that an amount of heat that is equivalent to that generated by the devices has been removed by the heat exchanger and the average air temperature leaving the heat exchanger is identical to that entering the rack (27°C (80.6°F) in this example). Heat removal in excess of 100% indicates that the heat exchanger not only removed all of the heat that was generated by the devices, but further cooled the air so that the average air temperature that is leaving the rack is actually lower than air temperature that is entering the rack.

## Water specifications for the secondary cooling loop

**Important:** The water that is being supplied to the heat exchanger must meet the requirements that are described in this section. Otherwise, system failures might occur over time as a result of any of the following problems:

- Leaks due to corrosion and pitting of the metal components of the heat exchanger or of the water-supply system.
- Buildup of scale deposits inside the heat exchanger, which can cause the following problems:
  - A reduction in the ability of the heat exchanger to cool the air that is exhausted from the rack
  - Failure of mechanical hardware, such as a hose quick-connect coupling
- Organic contamination, such as bacteria, fungi, or algae. This contamination can cause the same problems as described for scale deposits.

Contact a water quality and water distribution services expert for designing and implementing the infrastructure and water chemistry of the secondary loop.

## Control and conditioning of the secondary cooling loop

The water that is used to fill, refill, and supply the heat exchanger must be particle-free deionized water or particle-free distilled water with appropriate controls for avoiding the following problems::

- Metal corrosion
- Bacterial fouling
- Scaling

The water cannot originate from the primary chilled-water system for the building but must be supplied as part of a secondary closed-loop system.

**Important:** Do not use glycol solutions because they can adversely affect the cooling performance of the heat exchanger.

## Materials to use in secondary loops

You can use any of the following materials in supply lines, connectors, manifolds, pumps and any other hardware that makes up the closed-loop water-supply system at your location:

- Copper v brass with less than 30% zinc content
- Brass with less than 30% zinc content
- Stainless steel 303 or 316
- Peroxide cured ethylene propylene diene monomer (EPDM) rubber, non-metal-oxide material

## Materials to avoid in secondary loops

Do not use any of the following materials in any part of your water-supply system:

- Oxidizing biocides, such as chlorine, bromine, and chlorine dioxide



- Aluminum
- Brass with greater than 30% zinc
- Irons (nonstainless steel)

## Hardware Management Console specifications

Hardware Management Console (HMC) specifications provide detailed information for your HMC, including dimensions, electrical, power, temperature, environment, and service clearances.

### 7042-C07 desktop Hardware Management Console specifications

Hardware specifications provide detailed information for your Hardware Management Console (HMC), including dimensions, electrical, power, temperature, and environmental specifications.

The HMC controls managed systems, including the management of logical partitions and the use of capacity on demand. Using service applications, the HMC communicates with managed systems to detect, consolidate, and send information to IBM for analysis. The HMC provides service technicians with diagnostic information for systems that can operate in a multiple-partitioned environment.

Use the following specifications to plan for your HMC.

Table 119. Hardware Management Console specifications

Measurements	Width	Depth	Height	Weight (minimum configuration as shipped)	Weight (maximum configuration)
Metric	438 mm	540 mm	216 mm	16.3 kg	25.2 kg
English	17.25 in.	21.25 in.	8.5 in.	36 lb	56 lb
<b>Electrical<sup>1</sup></b>					
Power source loading			0.106 kVa to 0.352 kVa		
Input voltage			100 - 127 V ac (low range)		
			200 - 240 V ac (high range)		
Frequency (hertz)			47 Hz to 53 Hz (low range)		
			57 Hz to 63 Hz (high range)		
Thermal output (minimum)			630 Btu/hr. (185 watts)		
Thermal output (maximum)			1784 Btu/hr. (523 watts)		
Maximum altitude (Server off)			2133 m (7000 ft)		
<b>Air temperature requirements</b>					
<b>Operating</b>			<b>Shipping</b>		
10°C to 32°C (50°F to 89.6°F)			-40°C to 60°C (-40°F to 140°F)		
<b>Humidity requirements</b>					
	<b>Operating</b>		<b>Nonoperating</b>		
Noncondensing humidity	8% - 80%		8% - 80%		
<b>Noise emissions<sup>2</sup></b>					
<b>Product description</b>	<b>Declared A-weighted sound power level, <math>L_{WAd}</math> (bels)</b>		<b>Declared A-weighted sound pressure level, <math>L_{pAm}</math> (dB)</b>		
	Operating	Nonoperating	Operating		Nonoperating

Table 119. Hardware Management Console specifications (continued)

One hard disk drive configuration	5.2	4.8	37	33
<b>Notes:</b>				
<ol style="list-style-type: none"> <li>1. Power consumption and heat output vary depending on the number and type of optional features installed and the power management optional features in use.</li> <li>2. These levels were measured in controlled acoustical environments according to the procedures specified by the American National Standards Institute (ANSI) S12.10 and ISO 7779 and are reported in accordance with IS) 9296. Actual sound-pressure levels in a given location might exceed the average values stated because of room reflections and other nearby noise sources. The declared sound-power levels indicate an upper limit, below which a large number of computers will operate.</li> </ol>				

## 7042-C08 Hardware Management Console specifications

Hardware specifications for model 7042-C08 provide detailed information for your Hardware Management Console (HMC), including dimensions, electrical, power, temperature, and environmental specifications.

The HMC controls managed systems, including the management of logical partitions and the use of capacity on demand. Using service applications, the HMC communicates with managed systems to detect, consolidate, and send information to IBM for analysis. The HMC provides service technicians with diagnostic information for systems that can operate in a multiple-partitioned environment.

Use the following specifications to plan for your HMC.

Table 120. Dimensions

Width	Depth	Height	Weight
216 mm (8.5 in.)	540 mm (21.25 in.)	438 mm (17.25 in)	19.6 - 21.4 kg (43 - 47 lb)

Table 121. Electrical

Electrical characteristics	Properties
Maximum measured power	523 W
Maximum kVA	.55
Frequency	50 or 60 Hz
Maximum thermal output	1784 BTU/hr
Input voltage low range	100 - 127 V ac
Input voltage high range	200 - 240 V ac

Table 122. Environment requirements

Environment	System requirements	Altitude
Recommended operating temperature	10°C - 35°C (50°F - 95°F)	0 - 914.4 m (0 - 3000 ft)
	10°C - 32°C (50°F - 89.6°F)	914.4 - 2133.6 m (3000 - 7000 ft)
Nonoperating temperature	10°C - 43°C (50°F - 109.4°F)	2133.6 m (7000 ft)
Maximum altitude	NA	2133.6 m (7000 ft)
Shipping temperature	-40°C to 60°C (-40°F to 140°F)	
Operating humidity	8% - 80%	
Nonoperating humidity	8% - 80%	

## 7042-CR7 Hardware Management Console specifications

Hardware specifications provide detailed information about your Hardware Management Console (HMC), including dimensions, electrical, environmental requirements, and noise emissions.

The HMC controls managed systems, including the management of logical partitions and the use of capacity on demand (CoD). By using service applications, the HMC communicates with managed systems to detect, consolidate, and send information to IBM for analysis. The HMC provides service technicians with diagnostic information for systems that can operate in a multiple-partitioned environment.

Use the following specifications to plan for your HMC.

*Table 123. Dimensions*

Width	Depth	Height	Weight (maximum configuration)
429 mm (16.9 in.)	734 mm (28.9 in.)	43 mm (1.7 in.)	16.4 kg (36.16 lb)

*Table 124. Electrical requirements*

Electrical characteristics	Properties
Maximum measured power	351 W
Maximum thermal output	1198 Btu/hr
Input voltage low range	100 - 127 V ac
Input voltage high range	200 - 240 V ac
Frequency (Hertz)	50 or 60 Hz (+/- 3 Hz)

*Table 125. Environmental requirements*

Environment	System requirements	Altitude
Recommended operating temperature	10°C - 35°C (50°F - 95°F)	0 - 915 m (0 - 3000 ft)
	10°C - 32°C (50°F - 90°F)	915 - 2134 m (3000 - 7000 ft)
	10°C - 28°C (50°F - 83°F)	2134 - 3050 m (7000 - 10,000 ft)
Nonoperating temperature	5°C - 45°C (41°F - 113°F)	
Shipping temperature	-40°C to 60°C (-40°F to 140°F)	
Maximum altitude	3048 m (10,000 ft)	
Operating humidity	20% - 80%	
Operating dew point (maximum)	21°C (70°F)	
Nonoperating humidity	8% - 80%	
Nonoperating dew point (maximum)	27°C (81°F)	

*Table 126. Noise emissions (Maximum configuration)<sup>1</sup>*

Acoustical characteristics	Idling	Operating
L <sub>WAd</sub>	6.2 bels	6.5 bels
<p>1. These levels were measured in controlled acoustical environments according to the procedures specified by the American National Standards Institute (ANSI) S12.10 and ISO 7779 and are reported in accordance with ISO 9296. Actual sound-pressure levels in a specific location might exceed the average values stated because of room reflections and other nearby noise sources. The declared sound-power levels indicate an upper limit, below which a large number of computers will operate.</p>		

## Systems Director Management Console specifications

IBM Systems Director Management Console (SDMC) specifications provide detailed information for your SDMC, including dimensions, electrical, power, temperature, environment, and service clearances.

### 7042-CR6 rack-mounted Systems Director Management Console specifications

Hardware specifications provide detailed information for your IBM Systems Director Management Console (SDMC), including dimensions, electrical, environmental requirements, and noise emissions.

The SDMC controls managed systems, including the management of logical partitions and the use of capacity on demand. Using service applications, the SDMC communicates with managed systems to detect, consolidate, and send information to IBM for analysis. The SDMC provides service technicians with diagnostic information for systems that can operate in a multiple-partitioned environment.

Use the following specifications to plan for your SDMC.

Table 127. Dimensions

Width	Depth	Height	Weight (maximum configuration)
440 mm (17.3 in.)	711 mm (28.0)	43 mm (1.7 in.)	15.9 kg (35.1 lb)

Table 128. Electrical requirements

Electrical characteristics	Properties
Maximum measured power	675 W
Maximum kVA	0.7 kVA
Minimum thermal output	662 BTU/hr
Maximum thermal output	2302 BTU/hr
Input voltage low range	100 V ac - 127 V ac
Input voltage high range	200 V ac - 240 V ac
Frequency (Hertz)	47 Hz - 63 Hz

Table 129. Environmental requirements

Environment	Temperature
Recommended operating temperature	10°C - 35°C (50°F - 95°F)
Nonoperating temperature	5°C - 45°C (41°F - 113°F)
Maximum altitude	3048 m (10000 ft)
Operating humidity	8% - 80%
Nonoperating humidity	20% - 80%

Table 130. Noise emissions (maximum configuration)<sup>1</sup>

	Idling	Operating
L <sub>WAd</sub>	6.1 bels	6.1 bels

<sup>1</sup> These levels were measured in controlled acoustical environments according to the procedures specified by the American National Standards Institute (ANSI) S12.10 and ISO 7779 and are reported in accordance with ISO 9296. Actual sound-pressure levels in a specific location might exceed the average values stated because of room reflections and other nearby noise sources. The declared sound-power levels indicate an upper limit, below which a large number of computers will operate.

## Rack switch specifications

Rack switch specifications provide detailed information for your IBM BNT RackSwitch, including dimensions, electrical, power, temperature, environment, and service clearances.

Select the appropriate models to view the specifications for your rack switch.

### G8052R RackSwitch specification sheet

Hardware specifications provide detailed information for your IBM BNT RackSwitch, including dimensions, electrical, power, temperature, environment, and service clearances.

Table 131. Dimensions

Height	Width	Depth	Weight (maximum)
44 mm (1.73 in.)	439 mm (17.3 in.)	445 mm (17.5 in.)	8.3 kg (18.3 lb)

Table 132. Electrical

Electrical characteristics	Properties
Power requirements	200 W
Voltage	90 - 264 V ac
Frequency	47 - 63 Hz
Maximum thermal output	682.4 Btu/hr
Phase	1

Table 133. Environmental and acoustical requirements

Environment/Acoustical	Operating	Storage
Airflow direction	Rear-to-front	
Temperature, ambient operating	0°C - 40°C (32°F - 104°F)	
Temperature, (fan failure) operating	0°C - 35°C (32°F - 95°F)	
Temperature, storage		-40°C to +85°C (-40°F to 185°F)
Relative humidity range (non-condensing)	10% - 90% RH	10% - 90% RH
Maximum altitude	3050 m (10000 ft)	12190 m (40000 ft)
Heat dissipation	444 Btu/hr	
Acoustic noise	Less than 65 dB	

### G8124ER RackSwitch specification sheet

Hardware specifications provide detailed information for your IBM BNT RackSwitch, including dimensions, electrical, power, temperature, environment, and service clearances.

Table 134. Dimensions

Height	Width	Depth	Weight (maximum)
44 mm (1.73 in.)	439 mm (17.3 in.)	381 mm (15.0 in.)	6.4 kg (14.1 lb)

Table 135. Electrical

Electrical characteristics	Properties
Power requirements	275 W
Voltage	100 - 240 V ac
Frequency	50 - 60 Hz
Maximum thermal output	938.3 Btu/hr
Phase	1

Table 136. Environmental and acoustical requirements

Environment/Acoustical	Operating	Storage
Airflow direction	Rear-to-front	
Temperature, ambient operating	0°C - 40°C (32°F - 104°F)	
Temperature (fan failure) operating	0°C - 35°C (32°F - 95°F)	
Temperature, storage		-40°C to +85°C (-40°F to 185°F)
Relative humidity range (non-condensing)	10% - 90% RH	10% - 95% RH
Maximum altitude	3050 m (10000 ft)	4573 m (15000 ft)
Heat dissipation	1100 Btu/hr	
Acoustic noise	Less than 65 dB	

## G8264R RackSwitch specification sheet

Hardware specifications provide detailed information for your IBM BNT RackSwitch, including dimensions, electrical, power, temperature, environment, and service clearances.

Table 137. Dimensions

Height	Width	Depth	Weight (maximum)
44 mm (1.73 in.)	439 mm (17.3 in.)	513 mm (20.2 in.)	10.5 kg (23.1 lb)

Table 138. Electrical

Electrical characteristics	Properties
Power requirements	375 W
Voltage	100 - 240 V ac
Frequency	50 - 60 Hz
Maximum thermal output	1280 Btu/hr
Phase	1

Table 139. Environmental and acoustical requirements

Environment/Acoustical	Operating	Storage
Airflow direction	Rear-to-front	
Temperature, ambient operating	0°C - 40°C (32°F - 104°F)	
Temperature (fan failure) operating	0°C - 35°C (32°F - 95°F)	
Temperature, storage		-40°C to +85°C (-40°F to 185°F)
Relative humidity range (non-condensing)	10% - 90% RH	10% - 90% RH

Table 139. Environmental and acoustical requirements (continued)

Environment/Acoustical	Operating	Storage
Maximum altitude	1800 m (6000 ft)	12190 m (40000 ft)
Heat dissipation	1127 Btu/hr	
Acoustic noise	Less than 65 dB	

## G8316R RackSwitch specification sheet

Hardware specifications provide detailed information for your IBM BNT RackSwitch, including dimensions, electrical, power, temperature, environment, and service clearances.

Table 140. Dimensions

Height	Width	Depth	Weight (maximum)
43.7 mm (1.72 in.)	439 mm (17.3 in.)	483 mm (19.0 in.)	9.98 kg (22.0 lb)

Table 141. Electrical

Electrical characteristics	Properties
Power requirements	400 W
Voltage	100 - 240 V ac
Frequency	50 - 60 Hz
Maximum thermal output	1365 Btu/hr
Phase	1

Table 142. Environmental requirements

Environment	Operating
Airflow direction	Rear-to-front
Temperature, ambient operating	0°C - 40°C (32°F - 104°F)
Relative humidity range (non-condensing)	10% - 90% RH
Maximum altitude	3050 m (10000 ft)
Heat dissipation	1100 Btu/hr

## Rack installation specifications for racks not purchased from IBM

Learn the requirements and specifications for installing IBM systems into racks that were not purchased from IBM.

This topic provides requirements and specifications for 19-inch racks. These requirements and specifications are provided as an aid to help you understand the requirements to install IBM systems into racks. It is your responsibility, working with your rack manufacturer, to ensure that the rack chosen meets the requirements and specifications listed here. Mechanical drawings of the rack, if available from the manufacturer, are recommended for comparison against the requirements and specifications.

IBM maintenance services and installation planning services do not cover verification of non-IBM racks for compliance to Power Systems rack specifications. IBM offers racks for IBM products that are tested and verified by IBM development labs to comply with applicable safety and regulatory requirements. These racks are also tested and verified to fit and function well with IBM products. The customer is responsible for verifying with their rack manufacturer that any non-IBM racks comply with IBM specifications.

**Note:** The IBM 7014-T00, 7014-T42, 7014-B42, 0551, and 0553 racks meet all the requirements and specifications.

## Rack specifications

The general rack specifications are:

- The rack or cabinet must meet the EIA Standard EIA-310-D for 19-inch racks published August 24, 1992. The EIA-310-D standard specifies internal dimensions, for example, the width of the rack opening (width of the chassis), the width of the module mounting flanges, the mounting hole spacing, and the depth of the mounting flanges. The EIA-310-D standard does not control the overall external width of the rack. There are no restrictions on the location of side walls and corner posts relative to the internal mounting space.
- The front rack opening must be 451 mm wide + 0.75 mm (17.75 in. + 0.03 in.), and the rail-mounting holes must be 465 mm + 0.8 mm (18.3 in. + 0.03 in.) apart on center (horizontal width between vertical columns of holes on the two front-mounting flanges and on the two rear-mounting flanges).

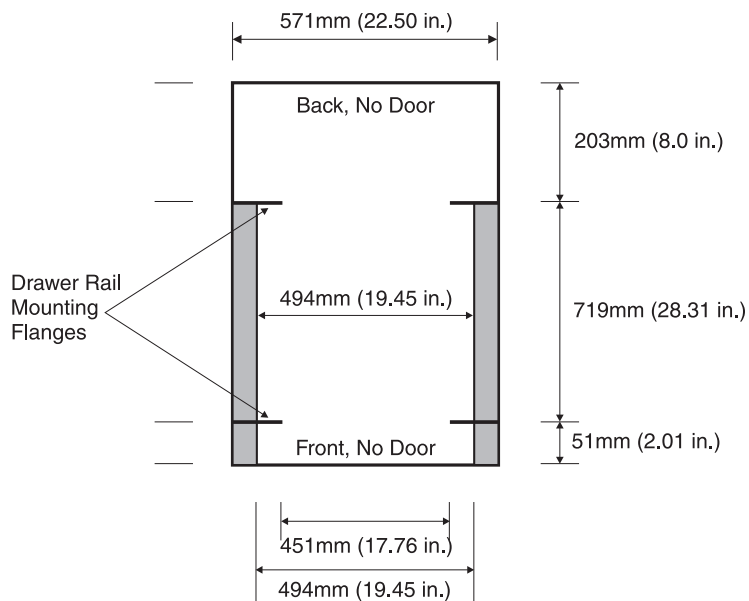

The vertical distance between mounting holes must consist of sets of three holes spaced (from bottom to top) 15.9 mm (0.625 in.), 15.9 mm (0.625 in.), and 12.67 mm (0.5 in.) on center (making each three hole set of vertical hole spacing 44.45 mm (1.75 in.) apart on center). The front and rear mounting flanges in the rack or cabinet must be 719 mm (28.3 in.) apart and the internal width bounded by the mounting flanges at least 494 mm (19.45 in.), for the IBM rails to fit in your rack or cabinet (see the following figure).



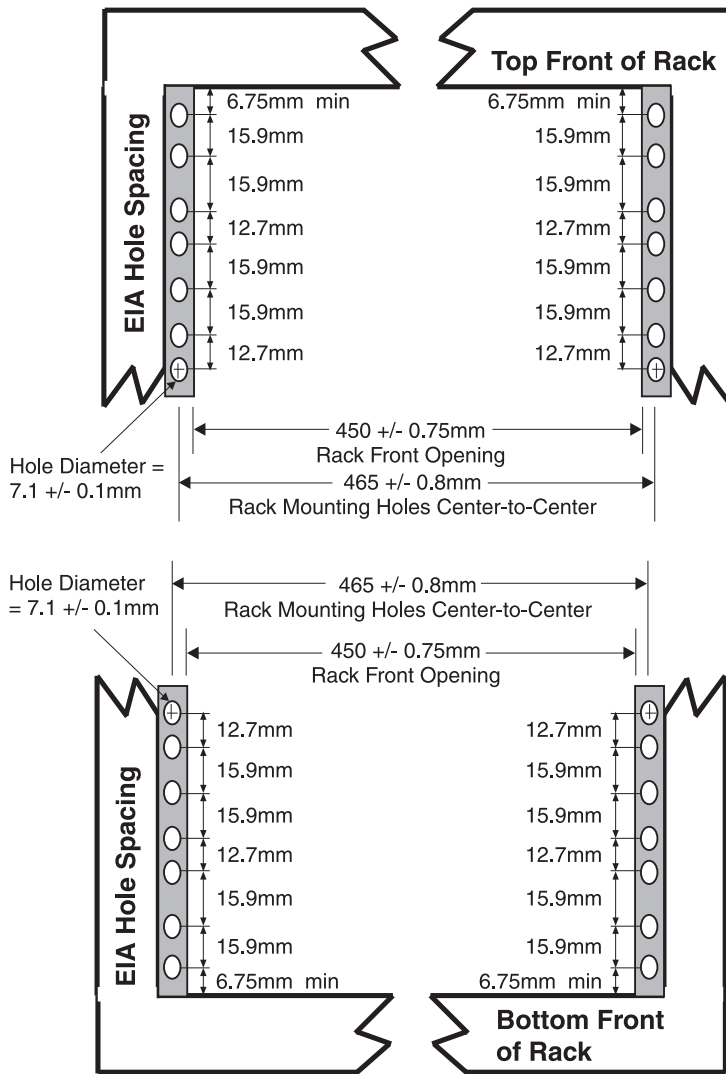

Models 9117-MMB, 9117-MMC, 9117-MMD, 9179-MHB, 9179-MHC, and 9179-MHD use SMP and FSP flex assemblies that extend beyond the rack mount post width.

The front rack opening must be 535 mm (21.06 in.) wide for dimension C (the width between the outsides of the standard mounting flanges, see Figure 30 on page 76). The back rack opening must be 500 mm (19.69 in.) wide for dimension C (the width between the outsides of the standard mounting flanges).

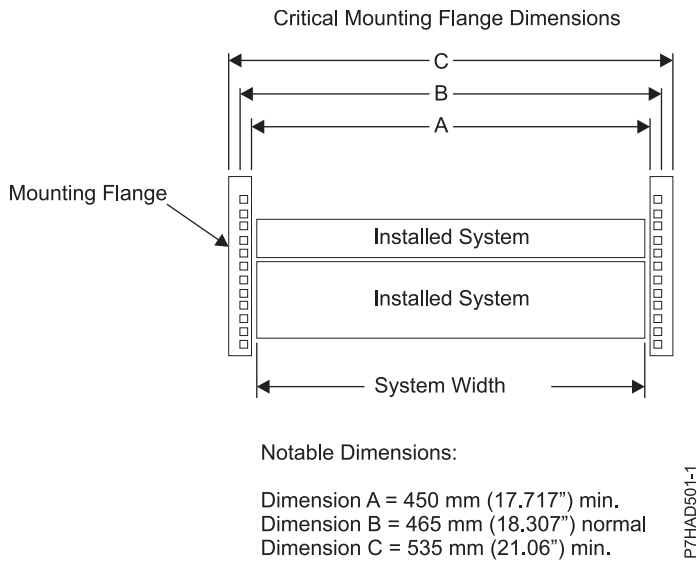
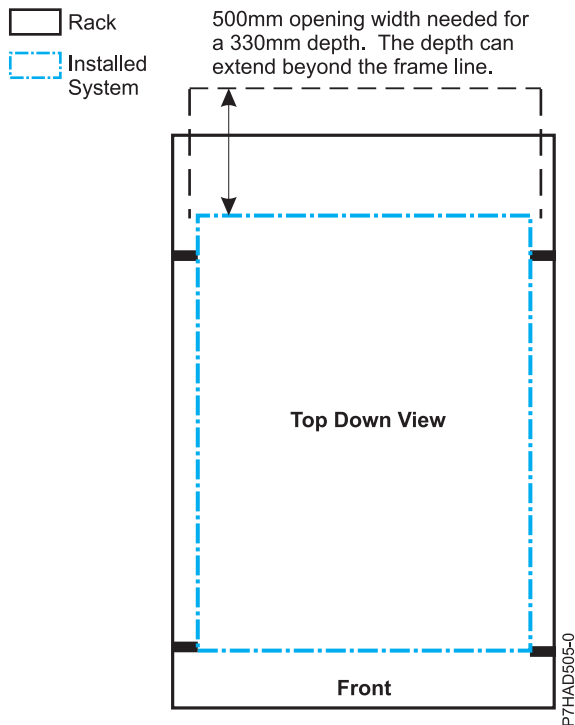

Figure 30. Critical mounting flange dimensions

- A minimum rack opening width of 500 mm (19.69 in.) for a depth of 330 mm (12.99 in.) is needed behind the installed system for maintenance and service. The depth can extend beyond the rack rear door.



- The rack or cabinet must be capable of supporting an average load of 15.9 kg (35 lb) of product weight per EIA unit.  
 For example, a four EIA drawer has a maximum drawer weight of 63.6 kg (140 lb).  
 The following rack hole sizes are supported for racks where IBM hardware is mounted:
  - 7.1 mm plus or minus 0.1 mm
  - 9.2 mm plus or minus 0.1 mm
  - 12 mm plus or minus 0.1 mm

- All parts shipped with the Power Systems products must be installed.
- Only ac power drawers are supported in the rack or cabinet. It is strongly recommended to use a power distribution unit that meets the same specifications as IBM power distribution units to supply rack power (for example, feature code 7188). Rack or cabinet power distribution devices must meet the drawer voltage, amperage, and power requirements, as well as that of any additional products that will be connected to the same power distribution device.

The rack or cabinet power receptacle (power distribution unit, uninterruptible power supply, or multi-outlet strip) must have a compatible plug type for your drawer or device.

- The rack or cabinet must be compatible with the drawer-mounting rails. The rail-mounting pins and screws should fit securely and snugly into the rack or cabinet rail-mounting holes. It is strongly recommended that the IBM mounting rails and mounting hardware that are included with the product be used to install it in the rack. The mounting rails and mounting hardware that are provided with IBM products have been designed and tested to safely support the product during operation and service activities as well as to safely support the weight of your drawer or device. The rails must facilitate service access by allowing the drawer to be safely extended, if necessary, forward, backward, or both. Some rails, with IBM features for non-IBM racks, provide drawer specific anti-tip brackets, rear lock-down brackets, and cable management guides that require clearance on the rear side of the rails.

**Note:** If the rack or cabinet has square holes on the mounting flanges, a plug-in hole adapter might be required.

If non-IBM rails are used, the rails must be product-safety certified for use with the IBM products. At a minimum, mounting rails must be able to support four times the maximum rated product weight in its worst-case position (fully-extended front and rear positions) for one full minute without catastrophic failure.

- The rack or cabinet must have stabilization feet or brackets installed both in the front and rear of the rack, or have another means of preventing the rack/cabinet from tipping while the drawer or device is pulled into its extreme front or rear service positions.

**Note:** Examples of some acceptable alternatives: The rack or cabinet might be securely bolted to the floor, ceiling or walls, or to adjacent racks or cabinets in a long and heavy row of racks or cabinets.

- There must be adequate front and rear service clearances (in and around the rack or cabinet). The rack or cabinet must have sufficient horizontal width clearance in the front and rear to allow the drawer to be fully slid into the front and, if applicable, the rear service access positions (typically this requires 914.4 mm (36 in.) clearance in both the front and rear).
- If present, front and rear doors must be able to open far enough to provide unrestrained access for service or be easily removable. If doors must be removed for service, it is the customer's responsibility to remove them prior to service.
- The rack or cabinet must provide adequate clearance around the rack drawer.
- There must be adequate clearance around the drawer bezel so that it can be opened and closed, according to the product specifications.
- Front or rear doors must also maintain a minimum of 51 mm (2 in.) front, 203 mm (8 in.) rear, door to mounting flange clearance, and 494 mm (19.4 in.) front, 571 mm (22.5 in.) rear, side-to-side clearance for drawer bezels and cables.
- The rack or cabinet must provide adequate front-to-back ventilation.

**Note:** For optimum ventilation, it is recommended the rack or cabinet not have a front door. If the rack or cabinet has doors, the doors must be fully perforated so that there is proper front-to-back airflow to maintain the required drawer ambient inlet temperature as specified in the server specifications. The perforations should yield at least 34 % minimum open area per square inch.

## General safety requirements for IBM products installed in a non-IBM rack or cabinet

The general safety requirements for IBM products installed in non-IBM racks are:

- Any product or component that plugs into either an IBM power distribution unit or mains power (via a power cord), or uses any voltage over 42 V ac or 60 V dc (considered to be hazardous voltage) must be Safety Certified by a Nationally Recognized Test Laboratory (NRTL) for the country in which it will be installed.

Some of the items that require safety certification might include: the rack or cabinet (if it contains electrical components integral to the rack or cabinet), fan trays, power distribution unit, uninterruptible power supplies, multi-outlet strips, or any other products installed in the rack or cabinet that connect to hazardous voltage.

Examples of OSHA-approved NRTLs for the U.S.:

- UL
- ETL
- CSA (with CSA NRTL or CSA US mark)

Examples of approved NRTLs for Canada:

- UL (ULc mark)
- ETL (ETLc mark)
- CSA

The European Union requires a CE mark and a Manufacturer's Declaration of Conformity (DOC).

Certified products should have the NRTL logos or marks somewhere on the product or product label. However, proof of certification must be made available to IBM upon request. Proof consists of such items as copies of the NRTL license or certificate, a CB Certificate, a Letter of Authorization to apply the NRTL mark, the first few pages of the NRTL certification report, Listing in an NRTL publication, or a copy of the UL Yellow Card. Proof should contain the manufacturer's name, product type and model, standard to which it was certified, the NRTL name or logo, the NRTL file number or license number, and a list of any Conditions of Acceptance or Deviations. A Manufacturer's Declaration is not proof of certification by an NRTL.

- The rack or cabinet must meet all electrical and mechanical safety legal requirements for the country in which it is installed. The rack or cabinet must be free of exposed hazards (such as voltages over 60 V dc or 42 V ac, energy over 240 VA, sharp edges, mechanical pinch points, or hot surfaces).
- There must be an accessible and unambiguous disconnect device for each product in the rack, including any power distribution unit.

A disconnect device might consist of either the plug on the power cord (if the power cord is no longer than 1.8 m (6 ft)), the appliance inlet receptacle (if the power cord is of a detachable type), or a power on/off switch, or an Emergency Power Off switch on the rack, provided all power is removed from the rack or product by the disconnect device.

If the rack or cabinet has electrical components (such as fan trays or lights), the rack must have an accessible and unambiguous disconnect device.

- The rack or cabinet, power distribution unit and multi-outlet strips, and products installed in the rack or cabinet must all be properly grounded to the customer facility ground.

There must be no more than 0.1 Ohms between the ground pin of the power distribution unit or rack plug and any touchable metal or conductive surface on the rack and on the products installed in the rack. Grounding method must comply with applicable country's electric code (such as NEC or CEC). Ground continuity can be verified by your IBM service personnel, after the installation is completed, and should be verified prior to the first service activity.

- The voltage rating of the power distribution unit and multi-outlet strips must be compatible with the products plugged into them.

The power distribution unit or multi-outlet strips current and power ratings are rated at 80% of the building supply circuit (as required by the National Electrical Code and the Canadian Electrical Code).

The total load connected to the power distribution unit must be less than the rating of the power distribution unit. For example, a power distribution unit with a 30 A connection will be rated for a total load of 24 A (30 A x 80 %). Therefore, the sum of all equipment connected to the power distribution unit in this example must be lower than the 24 A rating.

If an uninterruptible power supply is installed, it must meet all the electrical safety requirements as described for a power distribution unit (including certification by an NRTL).

- The rack or cabinet, power distribution unit, uninterruptible power supply, multi-outlet strips and all products in the rack or cabinet must be installed according to the manufacturer's instructions, and in accordance with all national, state or province, and local codes and laws.

The rack or cabinet, power distribution unit, uninterruptible power supply, multi-outlet strips and all products in the rack or cabinet must be used as intended by the manufacturer (per manufacturer's product documentation and marketing literature).

- All documentation for use and installation of the rack or cabinet, power distribution unit, uninterruptible power supply, and all products in the rack or cabinet, including safety information, must be available on-site.
- If there is more than one source of power in the rack cabinet, there must be clearly visible safety labels for Multiple Power Source (in the languages required for the country in which the product is installed).
- If the rack or cabinet or any products installed in the cabinet had safety or weight labels applied by the manufacturer, they must be intact and translated into the languages required for the country in which the product is installed.
- If the rack or cabinet has doors, the rack becomes a fire enclosure by definition and must meet the applicable flammability ratings (V-0 or better). Totally metal enclosures at least 1 mm (0.04 in.) thick are considered to comply.

Nonenclosure (decorative) materials must have a flammability rating of V-1 or better. If glass is used (such as in rack doors) it must be safety glass. If wood shelves are used in the rack/cabinet, they must be treated with a UL Listed flame-retardant coating.

- The rack or cabinet configuration must comply with all IBM requirements for "safe to service" (contact your IBM Installation Planning Representative for assistance in determining if the environment is safe). There must be no unique maintenance procedures or tools required for service.

Elevated service installations, where the products to be serviced are installed between 1.5 m and 3.7 m (5 ft and 12 ft) above the floor, require the availability of an OSHA- and CSA-approved nonconductive step ladder. If a ladder is required for service, the customer must supply the OSHA- and CSA-approved nonconductive step ladder (unless other arrangements have been made with the local IBM Service Branch Office). Products installed over 2.9 m (9 ft) above the floor require a Special Bid to be completed before they can be serviced by IBM service personnel.

For products not intended for rack-mounting to be serviced by IBM, the products and parts that will be replaced as part of that service must not weigh over 11.4 kg (25 lb) Contact your Installation Planning Representative if in doubt.

There must not be any special education or training required for safe servicing of any of the products installed in the racks. Contact your Installation Planning Representative if you are in doubt.

**Related reference:**

“Rack specifications” on page 33

Rack specifications provide detailed information for your rack, including dimensions, electrical, power, temperature, environment, and service clearances.



---

## Planning for power

Planning the power for your system requires knowledge of your server's power requirements, the power requirements of compatible hardware, and the uninterruptible power supply needs for your server. Use this information to build a complete power plan.

Before you begin your planning tasks, be sure you have completed the items in the following checklist:

- Know your server power requirements.
- Know your compatible hardware requirements.
- Know your uninterruptible power supply needs.

### Review power considerations

Complete the following checklist:

- Consult a qualified electrician regarding power needs.
- Determine an uninterruptible power supply vendor.
- Complete your server information form or forms.

---

## Determining your power requirements

Use these guidelines to ensure that your server has the proper power to operate.

Your server can have power requirements different from a PC (such as, different voltage and different plugs). IBM supplies power cords with an attached plug that corresponds to the power outlet most commonly used in the country or region to which the product is being shipped. You are responsible for supplying the proper power outlets.

- Plan for system electrical service. For information on power requirements for a specific model, refer to the electrical section in the server specifications for that particular server. For information on power requirements for expansion units or peripherals, select the appropriate device from the list of compatible hardware specifications. For equipment not listed, check your equipment documentation (owner's manuals) for specifications.
- Determine your server's plug and receptacle types: By model so you can have the proper outlets installed.

**Tip:** Print a copy of your plug and receptacle table and give it to your electrician. The table contains information needed for installing outlets.

- Write down power information in your Server Information Form 3A. Include:
  - Plug type
  - Input voltage
  - Power cord length (optional)
- Plan for power outages. Consider purchasing an uninterruptible power supply to protect your system against power fluctuations and outages. If your company owns a uninterruptible power supply, involve your uninterruptible power supply vendor with any type of uninterruptible power supply modification.
- Plan an emergency power-off switch. As a safety precaution, you should provide some method for disconnecting power to all equipment in your server area. Put emergency power-off switches in locations readily accessible to your systems operator and at designated exits from the room.

- Ground your system. Electrical grounding is important both for safety and correct operation. Your electrician should follow your national and local electrical codes when installing the electrical wiring, outlets, and power panels. These codes take precedence over any other recommendations.
- Contact an electrician. Contact a qualified electrician to take care of your server power requirements and install needed power outlets. Give the electrician a copy of your power information. You can print the recommended power distribution wiring diagram as a reference for your electrician.

### Server Information Form 3A

Use this form to record the type and quantity of power cords that you need for your server.

Frame	Device type	Device description feature code	Plug type/input voltage

### Licensed programs

Table 143. Licensed programs list



## Workstation Information Form 3B

Use this form to record the type and quantity of cables you need for your server.

Part number	Device type	Device description	Device location	Cable length	Plug type/input voltage	Telephone contact

## Licensed programs

Table 144. Licensed programs list

---

## Plugs and receptacles

Select the country or region link to see plugs and receptacles available by country. Or, if you use a PDU select Connecting your sever to a PDU.

## Connecting your server to a country specific receptacle

Choose the country or region in which your system will be installed to assist in determining the feature cord of your system.

### Supported feature codes

Find out which feature codes (FC) are supported for each system and country.

Use the following tables to determine the appropriate feature code to use with your system in your country.

Table 145. Supported feature codes for POWER7 systems

FC	8202-E4B, 8202-E4C, and 8202-E4D (IBM Power 720 Express)	8205-E6B, 8205-E6C, and 8205-E6D (IBM Power 740 Express)	8231-E2B, 8231-E1C, 8231-E2C, 8231-E1D, 8231-E2D, and 8268-E1D (IBM Power 710 Express and IBM Power 730 Express)	8233-E8B (IBM Power 750 Express)	8236-E8C (IBM Power 755)	9117-MMB, 9117-MMC, and 9117-MMD (IBM Power 770)	9119-FHB (IBM Power 795)	9179-MHB, 9179-MHC, and 9179-MHD (IBM Power 780)
6460	X	X	X	X	X	X	X	X
6469	X	X	X	X	X	X	X	X
6470	X	X	X	X	X	S	X	S
6471	X	X	X	X	X	X	X	X
6472	X	X	X	X	X	X	X	X
6473	X	X	X	X	X	X	X	X
6474	X	X	X	X	X	X	X	X
6475	X	X	X	X	X	X	X	X
6476	X	X	X	X	X	X	X	X
6477	X	X	X	X	X	X	X	X
6478	X	X	X	X	X	X	X	X
6479	S	S	S	S	N/S	S	S	S
6488	X	X	X	X	X	X	X	X
6489	X	X	X	X	X	X	X	X
6491	X	X	X	X	X	X	X	X
6492	X	X	X	X	X	X	X	X
6493	X	X	X	X	X	X	X	X
6494	X	X	X	X	X	X	X	X
6495	S	S	S	S	N/S	S	S	S
6496	X	X	X	X	X	X	X	X
6497	S	S	S	S	N/S	X	X	X
6498	S	S	S	S	N/S	S	S	S
6651	X	X	X	X	X	X	X	X
6653	X	X	X	X	X	X	X	X

Table 145. Supported feature codes for POWER7 systems (continued)

FC	8202-E4B, 8202-E4C, and 8202-E4D (IBM Power 720 Express)	8205-E6B, 8205-E6C, and 8205-E6D (IBM Power 740 Express)	8231-E2B, 8231-E1C, 8231-E2C, 8231-E1D, 8231-E2D, and 8268-E1D (IBM Power 710 Express and IBM Power 730 Express)	8233-E8B (IBM Power 750 Express)	8236-E8C (IBM Power 755)	9117-MMB, 9117-MMC, and 9117-MMD (IBM Power 770)	9119-FHB (IBM Power 795)	9179-MHB, 9179-MHC, and 9179-MHD (IBM Power 780)
6654	X	X	X	X	X	X	X	X
6655	X	X	X	X	X	X	X	X
6656	X	X	X	X	X	X	X	X
6657	X	X	X	X	X	X	X	X
6658	X	X	X	X	X	X	X	X
6659	X	X	X	X	X	X	X	X
6660	X	X	X	X	X	X	X	X
6662	S	S	S	S	N/S	S	S	S
6670	S	S	S	S	N/S	S	S	S
6680	X	X	X	X	X	X	X	X
6687	S	S	S	S	N/S	S	S	S
6690	S	S	S	S	N/S	S	S	S
6691	S	S	S	S	N/S	S	S	S
6692	S	S	S	S	N/S	S	S	S
<b>RPQ 8A1871</b>	N/S	N/S	N/S	N/S	N/S	N/S	X	N/S
<p>X = FC is supported and can be purchased.</p> <p>S = FC is supported, but is no longer available for purchase.</p> <p>N/S = FC is not supported.</p>								

Table 146. Supported FCs by countries

FC	Supported countries
6470	United States, Canada
6471	Brazil

Table 146. Supported FCs by countries (continued)

FC	Supported countries
6472	Afghanistan, Albania, Algeria, Andorra, Angola, Armenia, Austria, Azerbaijan, Belarus, Belgium, Benin, Bosnia and Herzegovina, Bulgaria, Burkina Faso, Burundi, Cambodia, Cameroon, Cape Verde, Central African Republic, Chad, Comoros, Congo (Democratic Republic of), Congo (Republic of), Cote D'Ivoire (Ivory Coast), Croatia (Republic of), Czech Republic, Dahomey, Djibouti, Egypt, Equatorial Guinea, Eritrea, Estonia, Ethiopia, Finland, France, French Guyana, French Polynesia, Gabon, Georgia, Germany, Greece, Guadeloupe, Guinea, Guinea Bissau, Hungary, Iceland, Indonesia, Iran, Kazakhstan, Kyrgyzstan, Laos (Peoples Democratic Republic of), Latvia, Lebanon, Lithuania, Luxembourg, Macedonia (former Yugoslav Republic of), Madagascar, Mali, Martinique, Mauritania, Mauritius, Mayotte, Moldova (Republic of), Monaco, Mongolia, Morocco, Mozambique, Netherlands, New Caledonia, Niger, Norway, Poland, Portugal, Reunion, Romania, Russian Federation, Rwanda, Sao Tome and Principe, Saudi Arabia, Senegal, Serbia, Slovakia, Slovenia (Republic of), Somalia, Spain, Suriname, Sweden, Syrian Arab Republic, Tajikistan, Tahiti, Togo, Tunisia, Turkey, Turkmenistan, Ukraine, Upper Volta, Uzbekistan, Vanuatu, Vietnam, Wallis and Futuna, Yugoslavia (Federal Republic of), Zaire
6473	Denmark
6474	Abu Dhabi, Bahrain, Botswana, Brunei Darussalam, Channel Islands, Cyprus, Dominica, Gambia, Ghana, Grenada, Guyana, Hong Kong, Iraq, Ireland, Jordan, Kenya, Kuwait, Liberia, Malawi, Malaysia, Malta, Myanmar (Burma), Nigeria, Oman, Qatar, Saint Kitts & Nevis, Saint Lucia, Saint Vincent and the Grenadines, Seychelles, Sierra Leone, Singapore, Sudan, Tanzania (United Republic of), Trinidad & Tobago, United Arab Emirates (Dubai), United Kingdom, Yemen, Zambia, Zimbabwe, Uganda
6475	Israel
6476	Liechtenstein, Switzerland
6477	Bangladesh, Lesotho, Macao, Maldives, Namibia, Nepal, Pakistan, Samoa, South Africa, Sri Lanka, Swaziland, Uganda
6478	Italy
6479	Australia, New Zealand
6488	Argentina
6489	Internationally available
6491	Europe
6492	United States, Canada
6493	China
6494	India
6495	Brazil
6496	Korea
6497	United States, Canada
6498	Japan
6651	Taiwan
6653	Internationally available
6654	United States, Canada
6655	United States, Canada
6656	Internationally available
6657	Australia, New Zealand
6658	Korea
6659	Taiwan

Table 146. Supported FCs by countries (continued)

FC	Supported countries
6660	Japan
6662	Taiwan
6670	Japan
6680	Australia, Fiji, Kiribati, Nauru, New Zealand, Papua New Guinea
6687	Japan
6690	Brazil
6691	Japan
6692	Australia, Fiji, Kiribati, Nauru, New Zealand, Papua New Guinea
RPQ 8A1871	Internationally available

### Internationally available

The plug and receptacles for this system are available internationally.

Select your system's feature code for more information.

#### Cord feature code 6489:

Find your plug and receptacle information, voltage and amperage, part number, and cord length.

#### Plug and receptacle

The plug and receptacle type is IEC 60309 3P+N+E.

**Note:** This feature code connects the power distribution unit (PDU) in a rack to the wall receptacle.

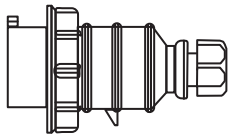

Figure 31. Plug type IEC 60309 3P+N+E

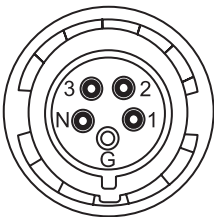

Figure 32. Plug pinout

#### Voltage and amperage

The voltage is 240 - 415 V ac, and the amperage is 32 A.

### Part number

The part number is:

- 39M5413

**Note:** This part number meets the European Union Directive 2002/95/EC on the Restriction of the Use of Certain Hazardous Substances in Electrical and Electronic Equipment.

### Cord length

The cord length is 4.3 m (14 ft).

### Cord feature code 6491:

Find your plug and receptacle information, voltage and amperage, part number, and cord length.

### Plug and receptacle

The plug and receptacle type is IEC 60309 P+N+E.

**Note:** This feature code connects the power distribution unit (PDU) in a rack to the wall receptacle.

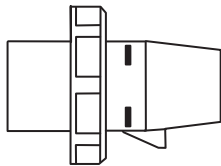

Figure 33. Plug type IEC 60309 P+N+E

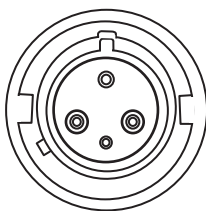

Figure 34. Receptacle type IEC 60309 P+N+E

### Voltage and amperage

The voltage is 200 - 240 V ac, and the amperage is 48 A.

### Part number

The part number is:

- 39M5415

**Note:** This part number meets the European Union Directive 2002/95/EC on the Restriction of the Use of Certain Hazardous Substances in Electrical and Electronic Equipment.

### **Cord length**

The cord length is 4.3 m (14 ft).

### **Cord feature code 6653:**

Find your plug and receptacle information, voltage and amperage, part number, and cord length.

### **Plug and receptacle**

The plug and receptacle type is IEC 60309 3P+N+E.

**Note:** This feature code connects the power distribution unit (PDU) in a rack to the wall receptacle.

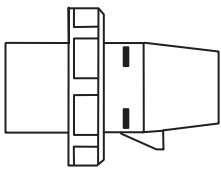

*Figure 35. Plug type IEC 60309 3P+N+E*

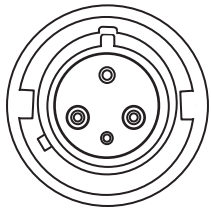

*Figure 36. Receptacle type IEC 60309 3P+N+E*

### **Voltage and amperage**

The voltage is 415 V ac and the amperage is 16 A.

### **Part number**

The part number is:

- 39M5412

**Note:** This part number meets the European Union Directive 2002/95/EC on the Restriction of the Use of Certain Hazardous Substances in Electrical and Electronic Equipment.

### **Cord length**

The cord length is 4.3 m (14 ft).

### **Cord feature code 6656:**

Find your plug and receptacle information, voltage and amperage, part number, and cord length.

## Plug and receptacle

The plug and receptacle type is IEC 60309 P+N+E.

**Note:** This feature code connects the power distribution unit (PDU) in a rack to the wall receptacle.

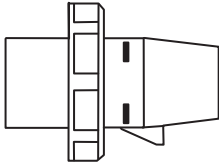

Figure 37. Plug type 60309 P+N+E

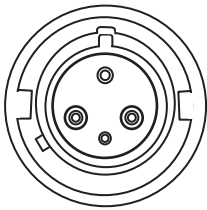

Figure 38. Receptacle type 60309 P+N+E

## Voltage and amperage

The voltage is 200 - 240 V ac, and the amperage is 32 A.

## Part number

The part number is:

- 39M5414

**Note:** This part number meets the European Union Directive 2002/95/EC on the Restriction of the Use of Certain Hazardous Substances in Electrical and Electronic Equipment.

## Cord length

The cord length is 4.3 m (14 ft).

## Anguilla

The plug and receptacles for this system are available in Anguilla.

Select your system's feature code for more information.

## Cord feature code 6460:

Find your plug and receptacle information, voltage and amperage, part number, and cord length.

## Plug and receptacle

The plug and receptacle type is 4.





Figure 39. Plug type 4

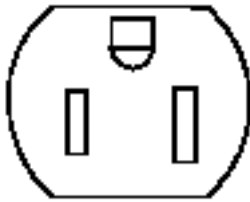

Figure 40. Receptacle type 4

#### **Voltage and amperage**

The voltage is 100 - 127 V ac, and the amperage is 15 A.

#### **Part number**

The part number is:

- 39M5513

**Note:** This part number meets the European Union Directive 2002/95/EC on the Restriction of the Use of Certain Hazardous Substances in Electrical and Electronic Equipment.

#### **Cord length**

The cord length is 4.3 m (14 ft).

#### **Antigua and Barbuda**

The plug and receptacles for this system are available in Antigua and Barbuda.

Select your system's feature code for more information.

#### **Cord feature code 6469:**

Find your plug and receptacle information, voltage and amperage, part number, and cord length.

#### **Plug and receptacle**

The plug and receptacle type is 5.



Figure 41. Plug type 5

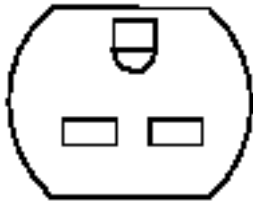

Figure 42. Receptacle type 5

### **Voltage and amperage**

The voltage is 200 - 240 V ac, and the amperage is 15 A.

### **Part number**

The part numbers are:

- 1838573
- 39M5096

**Note:** This part number meets the European Union Directive 2002/95/EC on the Restriction of the Use of Certain Hazardous Substances in Electrical and Electronic Equipment.

### **Cord rating**

The cord rating is 2.4 kVA.

### **Cord length**

The cord length is 4.3 m (14 ft).

### **Australia**

The plug and receptacles for this system are available in Australia.

Select your system's feature code for more information.

### **Cord feature code 6657:**

Find your plug and receptacle information, voltage and amperage, part number, and cord length.

## Plug and receptacle

The plug and receptacle type is PDL.

**Note:** This feature code connects the power distribution unit (PDU) in a rack to the wall receptacle.

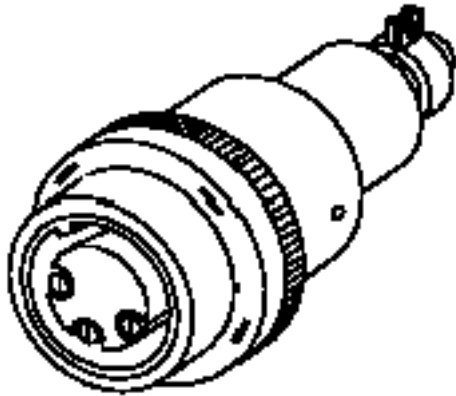

Figure 43. Plug type PDL

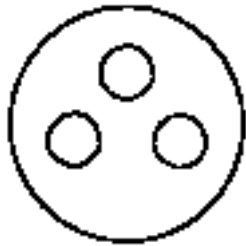

Figure 44. Receptacle type PDL

## Voltage and amperage

The voltage is 200 - 240 V ac, and the amperage is 32 A.

## Part number

The part number is:

- 39M5419

**Note:** This part number meets the European Union Directive 2002/95/EC on the Restriction of the Use of Certain Hazardous Substances in Electrical and Electronic Equipment.

## Cord length

The cord length is 4.3 m (14 ft).

## Brazil

The plug and receptacles for this system are available in Brazil.

Select your system's feature code for more information.

### **Cord feature code 6471:**

Find your plug and receptacle information, voltage and amperage, part number, and cord length.

**Note:** Line cord FC 6471 is for use in Brazil and cannot be used in the United States.

### **Plug and receptacle**

The plug and receptacle type is 70.



*Figure 45. Plug type 70*

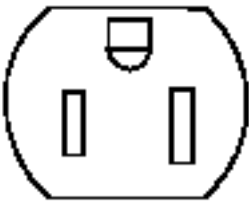

*Figure 46. Receptacle type 70*

### **Voltage and amperage**

The voltage is 100 - 127 V ac, and the amperage is 10 A.

### **Part number**

The part numbers are:

- 49P2110
- 39M5233

**Note:** This part number meets the European Union Directive 2002/95/EC on the Restriction of the Use of Certain Hazardous Substances in Electrical and Electronic Equipment.

### **Cord length**

The cord length is 2.7 m (9 ft).

### **Bulgaria**

The plug and receptacles for this system are available in Bulgaria.

Select your system's feature code for more information.

### **Cord feature code 6472:**

Find your plug and receptacle information, voltage and amperage, part number, and cord length.

### **Plug and receptacle**

The plug and receptacle type is 18.

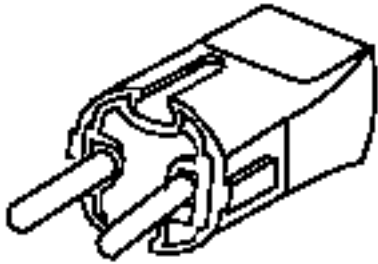

*Figure 47. Plug type 18*



*Figure 48. Receptacle type 18*

### **Voltage and amperage**

The voltage is 200 - 240 V ac, and the amperage is 10 A.

### **Part number**

The part numbers are:

- 13F9979
- 39M5123

**Note:** This part number meets the European Union Directive 2002/95/EC on the Restriction of the Use of Certain Hazardous Substances in Electrical and Electronic Equipment.

### **Cord rating**

The cord rating is 2.4 kVA.

### **Cord length**

The cord length is 2.7 m (9 ft).

## Canada

The plug and receptacles for this system are available in Canada.

Select your system's feature code for more information.

### Cord feature code 6492:

Find your plug and receptacle information, voltage and amperage, part number, and cord length.

### Plug and receptacle

The plug and receptacle type is IEC 60309 2P+E.

**Note:** This feature code connects the power distribution unit (PDU) in a rack to the wall receptacle.

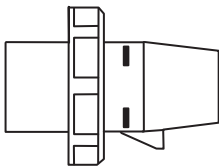

Figure 49. Plug type IEC 60309 2P+E

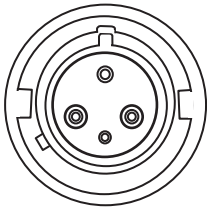

Figure 50. Receptacle type IEC 60309 2P+E

### Voltage and amperage

The voltage is 200 - 240 V ac, and the amperage is 63 A.

### Part number

The part number is:

- 39M5417

**Note:** This part number meets the European Union Directive 2002/95/EC on the Restriction of the Use of Certain Hazardous Substances in Electrical and Electronic Equipment.

### Cord length

The cord length is 4.3 m (14 ft).

### Cord feature code 6497:

Find your plug and receptacle information, voltage and amperage, part number, and cord length.

## Plug and receptacle

The plug and receptacle type is 10.



Figure 51. Plug type 10



Figure 52. Receptacle type 10

## Voltage and amperage

The voltage is 200 - 240 V ac, and the amperage is 10 A.

## Part number

The part number is:

- 41V1961

**Note:** This part number meets the European Union Directive 2002/95/EC on the Restriction of the Use of Certain Hazardous Substances in Electrical and Electronic Equipment.

## Cord length

The cord length is 1.8 m (6 ft).

## Cord feature code 6654:

Find your plug and receptacle information, voltage and amperage, part number, and cord length.

## Plug and receptacle

The plug and receptacle type is 12.

**Note:** This feature code connects the power distribution unit (PDU) in a rack to the wall receptacle.



Figure 53. Plug type 12



Figure 54. Receptacle type 12

### **Voltage and amperage**

The voltage is 200 - 240 V ac, and the amperage is 24 A.

### **Part number**

The part number is:

- 39M5416

**Note:** This part number meets the European Union Directive 2002/95/EC on the Restriction of the Use of Certain Hazardous Substances in Electrical and Electronic Equipment.

### **Cord length**

The cord length is 4.3 m (14 ft).

### **Cord feature code 6655:**

Find your plug and receptacle information, voltage and amperage, part number, and cord length.

### **Plug and receptacle**

The plug and receptacle type is 40.

**Note:** This feature code connects the power distribution unit (PDU) in a rack to the wall receptacle.



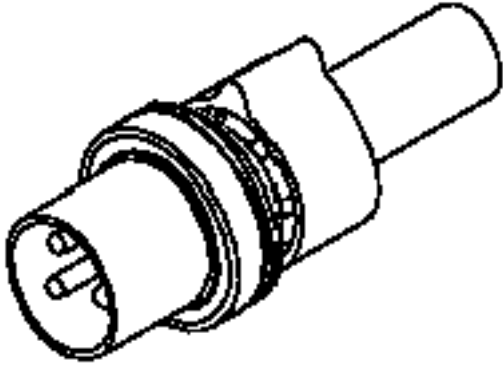

Figure 55. Plug type 40



Figure 56. Receptacle type 40

---

### Voltage and amperage

The voltage is 200 - 240 V and the amperage is ac 24 A.

### Part number

The part number is:

- 39M5418

**Note:** This part number meets the European Union Directive 2002/95/EC on the Restriction of the Use of Certain Hazardous Substances in Electrical and Electronic Equipment.

### Cord length

The cord length is 4.3 m (14 ft).

### Chile

The plug and receptacles for this system are available in Chile.

Select your system's feature code for more information.

### Cord feature code 6478:

Find your plug and receptacle information, voltage and amperage, part number, and cord length.

## Plug and receptacle

The plug and receptacle type is 25.



Figure 57. Plug type 25



Figure 58. Receptacle type 25

## Voltage and amperage

The voltage is 200 - 240 V ac, and the amperage is 10 A.

## Part number

The part numbers are:

- 14F0069
- 39M5165

**Note:** This part number meets the European Union Directive 2002/95/EC on the Restriction of the Use of Certain Hazardous Substances in Electrical and Electronic Equipment.

## Cord rating

The cord rating is 2.4 kVA.

## Cord length

The cord length is 2.7 m (9 ft).

## Cord feature code 6672:

Find your plug and receptacle information, voltage and amperage, part number, and cord length.

## Plug and receptacle

The plug and receptacle type is 26.

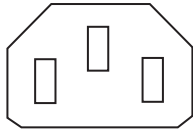

IPHAD941-0

Figure 59. Plug type 26

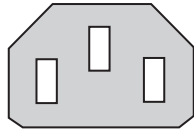

IPHAD989-0

Figure 60. Receptacle type 26

### Voltage and amperage

The voltage is 200 - 240 V ac, and the amperage is 10 A.

### Part number

The part numbers are:

- 36L8860
- 39M5375

**Note:** This part number meets the European Union Directive 2002/95/EC on the Restriction of the Use of Certain Hazardous Substances in Electrical and Electronic Equipment.

### Cord length

The cord length is 1.5 m (5 ft).

### China

The plug and receptacles for this system are available in China.

Select your system's feature code for more information.

### Cord feature code 6493:

Find your plug and receptacle information, voltage and amperage, part number, and cord length.

### Plug and receptacle

The plug and receptacle type is 62.



Figure 61. Plug type 62



Figure 62. Receptacle type 62

### **Voltage and amperage**

The voltage is 200 - 240 V ac, and the amperage is 10 A.

### **Part number**

The part numbers are:

- 02K0546
- 39M5206

**Note:** This part number meets the European Union Directive 2002/95/EC on the Restriction of the Use of Certain Hazardous Substances in Electrical and Electronic Equipment.

### **Cord rating**

The cord rating is 2.4 kVA.

### **Cord length**

The cord length is 2.7 m (9 ft).

### **Denmark**

The plug and receptacles for this system are available in Denmark.

Select your system's feature code for more information.

### **Cord feature code 6473:**

Find your plug and receptacle information, voltage and amperage, part number, and cord length.

### **Plug and receptacle**

The plug and receptacle type is 19.



*Figure 63. Plug type 19*



*Figure 64. Receptacle type 19*

### **Voltage and amperage**

The voltage is 200 - 240 V ac, and the amperage is 10 A.

### **Part number**

The part numbers are:

- 13F9997
- 39M5130

**Note:** This part number meets the European Union Directive 2002/95/EC on the Restriction of the Use of Certain Hazardous Substances in Electrical and Electronic Equipment.

### **Cord rating**

The cord rating is 2.4 kVA.

### **Cord length**

The cord length is 2.7 m (9 ft).

## Dominica

The plug and receptacles for this system are available in Dominica.

Select your system's feature code for more information.

### Cord feature code 6474:

Find your plug and receptacle information, voltage and amperage, part number, and cord length.

### Plug and receptacle

The plug and receptacle type is 23

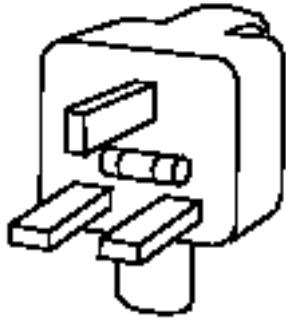

Figure 65. Plug type 23

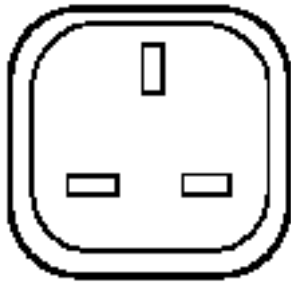

Figure 66. Receptacle type 23

### Voltage and amperage

The voltage is 200 - 240 V ac, and the amperage is 10 A.

### Part number

The part numbers are:

- 14F0034
- 39M5151

**Note:** This part number meets the European Union Directive 2002/95/EC on the Restriction of the Use of Certain Hazardous Substances in Electrical and Electronic Equipment.

### Cord length

The cord length is 2.7 m (9 ft).

### Italy

The plug and receptacles for this system are available in Italy.

Select your system's feature code for more information.

#### Cord feature code 6672:

Find your plug and receptacle information, voltage and amperage, part number, and cord length.

### Plug and receptacle

The plug and receptacle type is 26.

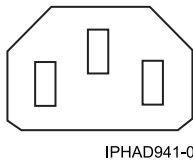

Figure 67. Plug type 26

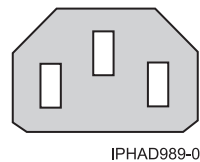

Figure 68. Receptacle type 26

### Voltage and amperage

The voltage is 200 - 240 V ac, and the amperage is 10 A.

### Part number

The part numbers are:

- 36L8860
- 39M5375

**Note:** This part number meets the European Union Directive 2002/95/EC on the Restriction of the Use of Certain Hazardous Substances in Electrical and Electronic Equipment.

### Cord length

The cord length is 1.5 m (5 ft).

### Great Britain

The plug and receptacles for this system are available in Great Britain.

Select your system's feature code for more information.

### **Cord feature code 6458:**

Find your plug and receptacle information, voltage and amperage, part number, and cord length.

#### **Plug and receptacle**

The plug and receptacle type is 26.

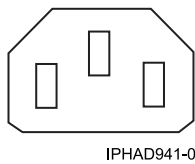

*Figure 69. Plug type 26*

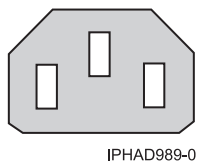

*Figure 70. Receptacle type 26*

#### **Voltage and amperage**

The voltage is 200 - 240 V ac, and the amperage is 10 A.

#### **Part number**

The part numbers are:

- 36L8861
- 39M5378

**Note:** This part number meets the European Union Directive 2002/95/EC on the Restriction of the Use of Certain Hazardous Substances in Electrical and Electronic Equipment.

#### **Cord length**

The cord length is 4.3 m (14 ft).

### **Cord feature code 6474:**

Find your plug and receptacle information, voltage and amperage, part number, and cord length.

#### **Plug and receptacle**

The plug and receptacle type is 23



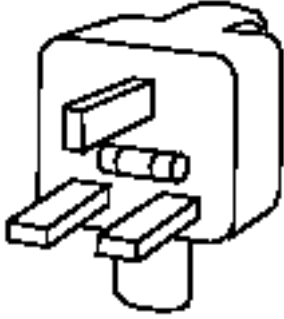

Figure 71. Plug type 23

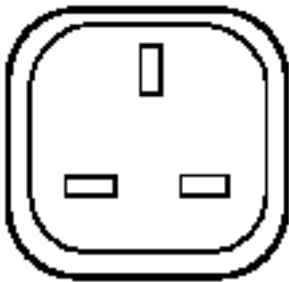

Figure 72. Receptacle type 23

### **Voltage and amperage**

The voltage is 200 - 240 V ac, and the amperage is 10 A.

### **Part number**

The part numbers are:

- 14F0034
- 39M5151

**Note:** This part number meets the European Union Directive 2002/95/EC on the Restriction of the Use of Certain Hazardous Substances in Electrical and Electronic Equipment.

### **Cord length**

The cord length is 2.7 m (9 ft).

### **Cord feature code 6477:**

Find your plug and receptacle information, voltage and amperage, part number, and cord length.

### **Plug and receptacle**

The plug and receptacle type is 22.



Figure 73. Plug type 22

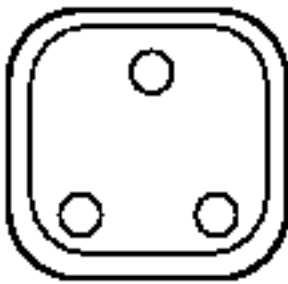

Figure 74. Receptacle type 22

#### **Voltage and amperage**

The voltage is 200 - 240 V ac, and the amperage is 16 A.

#### **Part number**

The part numbers are:

- 14F0015
- 39M5144

**Note:** This part number meets the European Union Directive 2002/95/EC on the Restriction of the Use of Certain Hazardous Substances in Electrical and Electronic Equipment.

#### **Cord length**

The cord length is 2.7 m (9 ft).

#### **Cord feature code 6577:**

Find your plug and receptacle information, voltage and amperage, part number, and cord length.

#### **Plug and receptacle**

The plug and receptacle type 15.

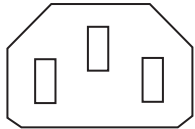

IPHAD941-0

Figure 75. Plug type 15

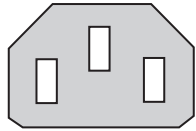

IPHAD989-0

Figure 76. Receptacle type 15

### Voltage and amperage

The voltage is 200 - 240 V ac, and the amperage is 10 A.

### Cord length

There are three different cord lengths<sup>1</sup>:

- 1.5 m (5 ft)
- 2.7 m (9 ft)
- 4.2 m (13.8 ft)

<sup>1</sup> For this feature, IBM Manufacturing chooses the optimum cord length when assembling systems into a rack.

### Cord feature code 6665:

Find your plug and receptacle information, voltage and amperage, part number, and cord length.

### Plug and receptacle

The plug and receptacle type is 61.

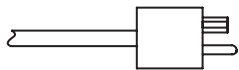

Figure 77. Plug type 61

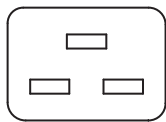

Figure 78. Receptacle type 61

## Voltage and amperage

The voltage is 200 - 240 V ac, and the amperage is 10 A.

## Part number

The part numbers are:

- 74P4430
- 39M5392

**Note:** This part number meets the European Union Directive 2002/95/EC on the Restriction of the Use of Certain Hazardous Substances in Electrical and Electronic Equipment.

## Cord length

The cord length is 3.0 m (10 ft).

## Cord feature code 6671:

Find your plug and receptacle information, voltage and amperage, part number, and cord length.

## Plug and receptacle

The plug and receptacle type is 26.

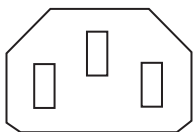

IPHAD941-0

Figure 79. Plug type 26

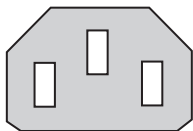

IPHAD989-0

Figure 80. Receptacle type 26

## Voltage and amperage

The voltage is 200 - 240 V ac, and the amperage is 10 A.

## Part number

The part numbers are:

- 36L8886
- 39M5377

**Note:** This part number meets the European Union Directive 2002/95/EC on the Restriction of the Use of Certain Hazardous Substances in Electrical and Electronic Equipment.

### **Cord length**

The cord length is 2.8 m (9 ft).

### **Cord feature code 6672:**

Find your plug and receptacle information, voltage and amperage, part number, and cord length.

### **Plug and receptacle**

The plug and receptacle type is 26.

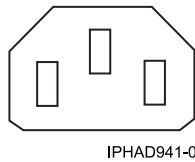

*Figure 81. Plug type 26*

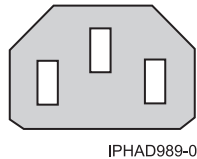

*Figure 82. Receptacle type 26*

### **Voltage and amperage**

The voltage is 200 - 240 V ac, and the amperage is 10 A.

### **Part number**

The part numbers are:

- 36L8860
- 39M5375

**Note:** This part number meets the European Union Directive 2002/95/EC on the Restriction of the Use of Certain Hazardous Substances in Electrical and Electronic Equipment.

### **Cord length**

The cord length is 1.5 m (5 ft).

### **Israel**

The plug and receptacles for this system are available in Israel.

Select your system's feature code for more information.

### **Cord feature code 6475:**

Find your plug and receptacle information, voltage and amperage, part number, and cord length.

## Plug and receptacle

The plug and receptacle type is 59.



Figure 83. Plug type 59

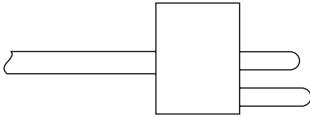

Figure 84. Receptacle type 59

## Voltage and amperage

The voltage is 200 - 240 V ac, and the amperage is 10 A.

## Part number

The part numbers are:

- 14F0087
- 39M5172

**Note:** This part number meets the European Union Directive 2002/95/EC on the Restriction of the Use of Certain Hazardous Substances in Electrical and Electronic Equipment.

## Cord rating

The cord rating is 2.4 kVA.

## Cord length

The cord length is 2.7 m (9 ft).

## Japan

The plug and receptacles for this system are available in Japan.

Select your system's feature code for more information.

## Cord feature code 6487:

Find your plug and receptacle information, voltage and amperage, part number, and cord length.

## Plug and receptacle

The plug and receptacle type is 5.



Figure 85. Plug type 5

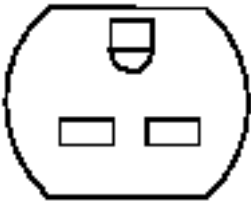

Figure 86. Receptacle type 5

### **Voltage and amperage**

The voltage is 200 - 240 V ac, and the amperage is 15 A.

### **Part number**

The part numbers are:

- 1838576
- 39M5094

**Note:** This part number meets the European Union Directive 2002/95/EC on the Restriction of the Use of Certain Hazardous Substances in Electrical and Electronic Equipment.

### **Cord rating**

The cord rating is 2.4 kVA.

### **Cord length**

The cord length is 1.8 m (6 ft).

### **Cord feature code 6660:**

Find your plug and receptacle information, voltage and amperage, part number, and cord length.

### **Plug and receptacle**

The plug and receptacle type is 59.



JIS C-8303-1983  
Type 59  
nonlocking

IPHAD939-0

*Figure 87. Plug type 59*

### **Voltage and amperage**

The voltage is 100 - 127 V ac, and the amperage is 15 A.

### **Part number**

The part number is:

- 39M5200

**Note:** This part number meets the European Union Directive 2002/95/EC on the Restriction of the Use of Certain Hazardous Substances in Electrical and Electronic Equipment.

### **Cord length**

The cord length is 4.3 m (14 ft).

### **Liechtenstein**

The plug and receptacles for this system are available in Liechtenstein.

Select your system's feature code for more information.

### **Cord feature code 6476:**

Find your plug and receptacle information, voltage and amperage, part number, and cord length.

### **Plug and receptacle**

The plug and receptacle type is 24.



---

*Figure 88. Plug type 24*





Figure 89. Receptacle type 24

### **Voltage and amperage**

The voltage is 200 - 240 V ac, and the amperage is 10 A.

### **Part number**

The part numbers are:

- 14F0051
- 39M5158

**Note:** This part number meets the European Union Directive 2002/95/EC on the Restriction of the Use of Certain Hazardous Substances in Electrical and Electronic Equipment.

### **Cord rating**

The cord rating is 2.4 kVA.

### **Cord length**

The cord length is 2.7 m (9 ft).

### **Macao**

The plug and receptacles for this system are available in Macao.

Select your system's feature code for more information.

### **Cord feature code 6477:**

Find your plug and receptacle information, voltage and amperage, part number, and cord length.

### **Plug and receptacle**

The plug and receptacle type is 22.



Figure 90. Plug type 22

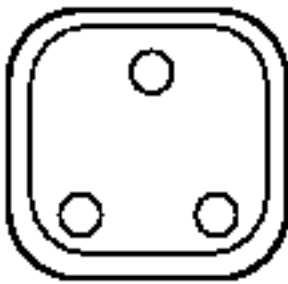

Figure 91. Receptacle type 22

### **Voltage and amperage**

The voltage is 200 - 240 V ac, and the amperage is 16 A.

### **Part number**

The part numbers are:

- 14F0015
- 39M5144

**Note:** This part number meets the European Union Directive 2002/95/EC on the Restriction of the Use of Certain Hazardous Substances in Electrical and Electronic Equipment.

### **Cord length**

The cord length is 2.7 m (9 ft).

### **Paraguay**

The plug and receptacles for this system are available in Paraguay.

Select your system's feature code for more information.

### **Cord feature code 6488:**

Find your plug and receptacle information, voltage and amperage, part number, and cord length.

## Plug and receptacle

The plug and receptacle type is 2.



Figure 92. Plug type 2



Figure 93. Receptacle type 2

## Voltage and amperage

The voltage is 200 - 240 V ac, and the amperage is 10 A.

## Part number

The part numbers are:

- 36L8880
- 39M5068

**Note:** This part number meets the European Union Directive 2002/95/EC on the Restriction of the Use of Certain Hazardous Substances in Electrical and Electronic Equipment.

## Cord rating

The cord rating is 2.4 kVA.

## Cord length

The cord length is 2.7 m (9 ft).

## India

The plug and receptacles for this system are available in India.

Select your system's feature code for more information.

### Cord feature code 6494:

Find your plug and receptacle information, voltage and amperage, part number, and cord length.

### Plug and receptacle

The plug and receptacle type is 69.



Figure 94. Plug type 69



Figure 95. Receptacle type 69

### Voltage and amperage

The voltage is 200 - 240 V ac, and the amperage is 10 A.

### Part number

The part number is:

- 39M5226

**Note:** This part number meets the European Union Directive 2002/95/EC on the Restriction of the Use of Certain Hazardous Substances in Electrical and Electronic Equipment.

### Cord length

The cord length is 2.7 m (9 ft).

## Kiribati

The plug and receptacles for this system are available in Kiribati.

Select your system's feature code for more information.

### Cord feature code 6680:

Find your plug and receptacle information, voltage and amperage, part number, and cord length.

### Plug and receptacle

The plug and receptacle type is 6.



Figure 96. Plug type 6



Figure 97. Receptacle type 6

### **Voltage and amperage**

The voltage is 250 V ac and the amperage is 10 A.

### **Part number**

The part number is:

- 39M5102

**Note:** This part number meets the European Union Directive 2002/95/EC on the Restriction of the Use of Certain Hazardous Substances in Electrical and Electronic Equipment.

### **Cord length**

The cord length is 2.7 m (9 ft).

### **Korea**

The plug and receptacles for this system are available in Korea.

Select your system's feature code for more information.

### **Cord feature code 6496:**

Find your plug and receptacle information, voltage and amperage, part number, and cord length.

## Plug and receptacle

The plug and receptacle type is 66.

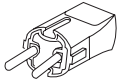

Figure 98. Plug type 66



Figure 99. Receptacle type 66

## Voltage and amperage

The voltage is 200 - 240 V ac, and the amperage is 10 A.

## Part number

The part numbers are:

- 24P6873
- 39M5219

**Note:** This part number meets the European Union Directive 2002/95/EC on the Restriction of the Use of Certain Hazardous Substances in Electrical and Electronic Equipment.

## Cord length

The cord length is 2.7 m (9 ft).

## Cord feature code 6658:

Find your plug and receptacle information, voltage and amperage, part number, and cord length.

## Plug and receptacle

The plug and receptacle type is KP.

**Note:** This feature code connects the power distribution unit (PDU) in a rack to the wall receptacle.



Figure 100. Plug type KP



Figure 101. Receptacle type KP

### **Voltage and amperage**

The voltage is 200 - 240 V ac, and the amperage is 24 A.

### **Part number**

The part number is:

- 39M5420

**Note:** This part number meets the European Union Directive 2002/95/EC on the Restriction of the Use of Certain Hazardous Substances in Electrical and Electronic Equipment.

### **Cord length**

The cord length is 4.3 m (14 ft).

### **New Zealand**

The plug and receptacles for this system are available in New Zealand.

Select your system's feature code for more information.

### **Cord feature code 6657:**

Find your plug and receptacle information, voltage and amperage, part number, and cord length.

### **Plug and receptacle**

The plug and receptacle type is PDL.

**Note:** This feature code connects the power distribution unit (PDU) in a rack to the wall receptacle.

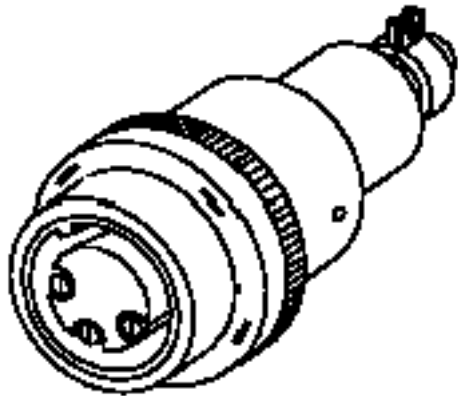

Figure 102. Plug type PDL

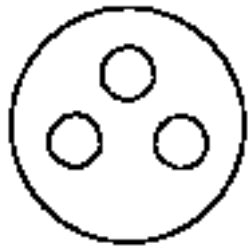

Figure 103. Receptacle type PDL

### **Voltage and amperage**

The voltage is 200 - 240 V ac, and the amperage is 32 A.

### **Part number**

The part number is:

- 39M5419

**Note:** This part number meets the European Union Directive 2002/95/EC on the Restriction of the Use of Certain Hazardous Substances in Electrical and Electronic Equipment.

### **Cord length**

The cord length is 4.3 m (14 ft).

### **Taiwan**

The plug and receptacles for this system are available in Taiwan.

Select your system's feature code for more information.

### **Cord feature code 6651:**

Find your plug and receptacle information, voltage and amperage, part number, and cord length.



### Plug and receptacle

The plug and receptacle type is 75.

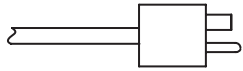

Figure 104. Plug type 75



Figure 105. Receptacle type 75

### Voltage and amperage

The voltage is 100 -127 V ac, and the amperage is 15 A.

### Part number

The part number is:

- 39M5463

**Note:** This part number meets the European Union Directive 2002/95/EC on the Restriction of the Use of Certain Hazardous Substances in Electrical and Electronic Equipment.

### Cord length

The cord length is 2.7 m (9 ft).

### Cord feature code 6659:

Find your plug and receptacle information, voltage and amperage, part number, and cord length.

### Plug and receptacle

The plug and receptacle type is 76.



Figure 106. Plug type 76

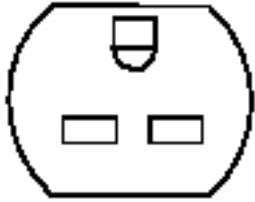

Figure 107. Receptacle type 76

### Voltage and amperage

The voltage is 200 - 240 V ac, and the amperage is 15 A.

### Part number

The part number is:

- 39M5254

**Note:** This part number meets the European Union Directive 2002/95/EC on the Restriction of the Use of Certain Hazardous Substances in Electrical and Electronic Equipment.

### Cord length

The cord length is 2.7 m (9 ft).

### United States, territories, and possessions

The plug and receptacles for this system are available in the United States, territories, and possessions.

Select your system's feature code for more information.

### Cord feature code 6492:

Find your plug and receptacle information, voltage and amperage, part number, and cord length.

### Plug and receptacle

The plug and receptacle type is IEC 60309 2P+E.

**Note:** This feature code connects the power distribution unit (PDU) in a rack to the wall receptacle.

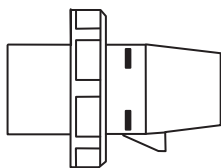

Figure 108. Plug type IEC 60309 2P+E

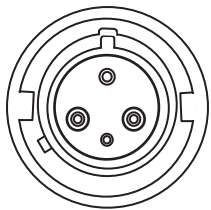

Figure 109. Receptacle type IEC 60309 2P+E

### Voltage and amperage

The voltage is 200 - 240 V ac, and the amperage is 63 A.

### Part number

The part number is:

- 39M5417

**Note:** This part number meets the European Union Directive 2002/95/EC on the Restriction of the Use of Certain Hazardous Substances in Electrical and Electronic Equipment.

### Cord length

The cord length is 4.3 m (14 ft).

### Cord feature code 6497:

Find your plug and receptacle information, voltage and amperage, part number, and cord length.

### Plug and receptacle

The plug and receptacle type is 10.



Figure 110. Plug type 10



---

Figure 111. Receptacle type 10

### Voltage and amperage

The voltage is 200 - 240 V ac, and the amperage is 10 A.

### Part number

The part number is:

- 41V1961

**Note:** This part number meets the European Union Directive 2002/95/EC on the Restriction of the Use of Certain Hazardous Substances in Electrical and Electronic Equipment.

### Cord length

The cord length is 1.8 m (6 ft).

### Cord feature code 6654:

Find your plug and receptacle information, voltage and amperage, part number, and cord length.

### Plug and receptacle

The plug and receptacle type is 12.

**Note:** This feature code connects the power distribution unit (PDU) in a rack to the wall receptacle.



---

Figure 112. Plug type 12



Figure 113. Receptacle type 12

### Voltage and amperage

The voltage is 200 - 240 V ac, and the amperage is 24 A.

### Part number

The part number is:

- 39M5416

**Note:** This part number meets the European Union Directive 2002/95/EC on the Restriction of the Use of Certain Hazardous Substances in Electrical and Electronic Equipment.

### Cord length

The cord length is 4.3 m (14 ft).

### Cord feature code RPQ 8A1871:

Find your plug and receptacle information, voltage and amperage, part number, and cord length.

### Plug and receptacle

The plug type is RS 7328DP and the receptacle type is RS 7324-78.

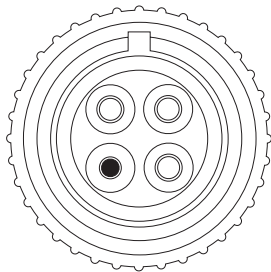

Figure 114. Plug type RS 7328DP

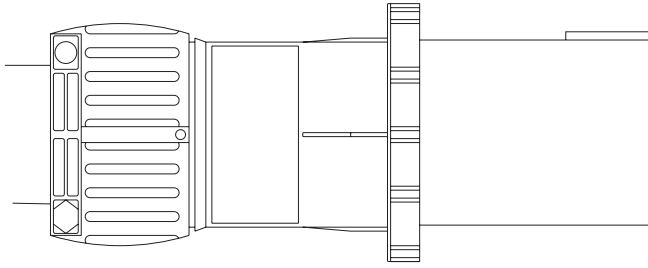

Figure 115. Receptacle type RS 7324-78

### Voltage and amperage

The voltage is 380 - 415 V ac, and the amperage is 60 A.

### Part number

The part number is:

- 45D9456

**Note:** This part number meets the European Union Directive 2002/95/EC on the Restriction of the Use of Certain Hazardous Substances in Electrical and Electronic Equipment.

### Cord length

The cord length is 4.3 m (14 ft).

## Connecting your server to a PDU

Select this option if your system uses a power distribution unit (PDU). These cords are available worldwide as they connect the system to a PDU (instead of a wall plug outlet where the receptacle is country specific).

Select your system's feature code for more information.

### Cord feature code 6458

Find your plug and receptacle information, voltage and amperage, part number, and cord length.

### Plug and receptacle

The plug and receptacle type is 26.

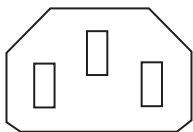

IPHAD941-0

Figure 116. Plug type 26

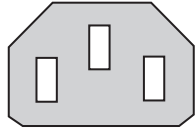

IPHAD989-0

Figure 117. Receptacle type 26

### Voltage and amperage

The voltage is 200 - 240 V ac, and the amperage is 10 A.

### Part number

The part numbers are:

- 36L8861
- 39M5378

**Note:** This part number meets the European Union Directive 2002/95/EC on the Restriction of the Use of Certain Hazardous Substances in Electrical and Electronic Equipment.

### Cord length

The cord length is 4.3 m (14 ft).

### Cord feature code 6459

Find your plug and receptacle information, voltage and amperage, part number, and cord length.

### Plug and receptacle

The plug and receptacle type is a 26 Right angle.

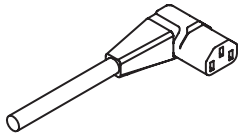

Figure 118. Plug and receptacle type 26

### Voltage and amperage

The voltage is 250 V ac and the amperage is 10 A.

### Part number

The part numbers are:

- 00P2401
- 41U0114

**Note:** This part number meets the European Union Directive 2002/95/EC on the Restriction of the Use of Certain Hazardous Substances in Electrical and Electronic Equipment.

## Cord length

The cord length is 3.7 m (12 ft).

## Cord feature code 6577

Find your plug and receptacle information, voltage and amperage, part number, and cord length.

## Plug and receptacle

The plug and receptacle type 15.

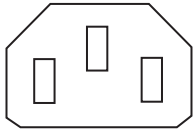

IPHAD941-0

Figure 119. Plug type 15

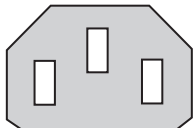

IPHAD989-0

Figure 120. Receptacle type 15

## Voltage and amperage

The voltage is 200 - 240 V ac, and the amperage is 10 A.

## Cord length

There are three different cord lengths<sup>1</sup>:

- 1.5 m (5 ft)
- 2.7 m (9 ft)
- 4.2 m (13.8 ft)

<sup>1</sup> For this feature, IBM Manufacturing chooses the optimum cord length when assembling systems into a rack.

## Cord feature code 6665

Find your plug and receptacle information, voltage and amperage, part number, and cord length.

## Plug and receptacle

The plug and receptacle type is 61.

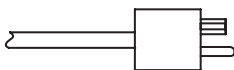

Figure 121. Plug type 61



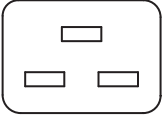

Figure 122. Receptacle type 61

### Voltage and amperage

The voltage is 200 - 240 V ac, and the amperage is 10 A.

### Part number

The part numbers are:

- 74P4430
- 39M5392

**Note:** This part number meets the European Union Directive 2002/95/EC on the Restriction of the Use of Certain Hazardous Substances in Electrical and Electronic Equipment.

### Cord length

The cord length is 3.0 m (10 ft).

### Cord feature code 6671

Find your plug and receptacle information, voltage and amperage, part number, and cord length.

### Plug and receptacle

The plug and receptacle type is 26.

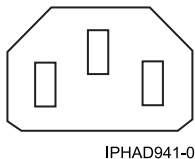

IPHAD941-0

Figure 123. Plug type 26

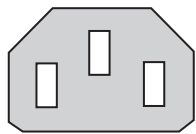

IPHAD989-0

Figure 124. Receptacle type 26

### Voltage and amperage

The voltage is 200 - 240 V ac, and the amperage is 10 A.

### Part number

The part numbers are:

- 36L8886

- 39M5377

**Note:** This part number meets the European Union Directive 2002/95/EC on the Restriction of the Use of Certain Hazardous Substances in Electrical and Electronic Equipment.

### **Cord length**

The cord length is 2.8 m (9 ft).

### **Cord feature code 6672**

Find your plug and receptacle information, voltage and amperage, part number, and cord length.

### **Plug and receptacle**

The plug and receptacle type is 26.

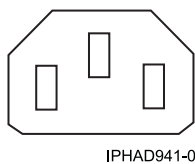

*Figure 125. Plug type 26*

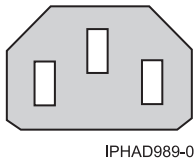

*Figure 126. Receptacle type 26*

### **Voltage and amperage**

The voltage is 200 - 240 V ac, and the amperage is 10 A.

### **Part number**

The part numbers are:

- 36L8860
- 39M5375

**Note:** This part number meets the European Union Directive 2002/95/EC on the Restriction of the Use of Certain Hazardous Substances in Electrical and Electronic Equipment.

### **Cord length**

The cord length is 1.5 m (5 ft).

---

## **Modification of IBM-provided power cords**

Modification of IBM-provided power cords should only be done in rare circumstances, because the power cords provided with IBM systems meet stringent design and manufacturing specifications.

IBM encourages the use of an IBM released power cord because of the specifications that must be met for both the design and manufacture of our IBM power cords. The specifications, the components used in the design, and the manufacturing process is an external safety agency approved process that is audited by safety agencies on a periodic and ongoing basis to ensure quality and compliance with design requirements.

When a server leaves the manufacturing site, it is safety agency listed, therefore, IBM does not recommend modifying IBM-provided power cords. In the rare circumstance where modification of an IBM provided power cord is deemed essential, you should:

- Discuss the modification with their insurance provider to assess the effect, if any, on insurance coverage
- Consult with a professional electrician regarding compliance with local codes

The following excerpts from the Services Reference Manual (SRM) explains IBM policy on power cord alteration and the liabilities involved.

### **SRM excerpts**

A cable group associated with a purchased IBM machine, and bearing an IBM label, is the property of the IBM machine owner. All other IBM furnished cable groups (except those for which specific purchase invoices have been paid) are the property of IBM.

Customers assume all risks associated with turning a machine over to others for the performance of technical work such as, but not limited to, the installation or removal of features, alterations or attachments.

IBM will advise the customer of any limitation, resulting from the alteration, affecting IBM's ability to provide Warranty Service or Maintenance after review by the appropriate Service Delivery and Field Marketing Practices personnel.

### **Definition of an alteration**

An alteration is any change to an IBM machine that deviates from IBM physical, mechanical, electrical, or electronic design (including microcode) whether or not additional devices or parts are used. An alteration is also an interconnection at some place other than an IBM defined interface. See the Multiple Supplier Systems Bulletin for more detail.

For an altered machine, service will be confined to the unaltered portions of the IBM machine.

After inspection, IBM will continue to make Warranty Service or Maintenance available, as appropriate, for the unaltered portion of an IBM machine.

IBM will not maintain the altered portion of an IBM machine under either an IBM Agreement or on an Hourly Service basis.

If you have more questions about power cord modification, contact an IBM service representative.

---

## **Uninterruptible power supply**

Uninterruptible power supplies are available to meet the power protection needs of IBM servers. The uninterruptible power supply is the IBM type 9910.

The IBM 9910 uninterruptible power supply solutions are compatible with the power requirements for Power Systems™ servers and have passed IBM testing procedures. The uninterruptible power supplies are intended to provide a single source for purchase and protection of IBM servers. All 9910 uninterruptible

power supplies include a premium warranty package that is designed to enhance the potential for return on investment over the uninterruptible power supplies available on the market today.

Type 9910 uninterruptible power supply solutions are available from *Eaton*.

### **Feature code 1827 service processor communications port to uninterruptible power supply cable**

The 1827 is a 140 mm (5.5 in.) service processor communications port to uninterruptible power supply cable for Power Systems models. Uninterruptible power supply communications are supported through a designated service processor communications port through the 1827 cable.

Both ends of the cable have a female 9-pin D-shell connector. The following figure shows the serial to uninterruptible power supply converter cable end (designated B) that plugs into the service processor communications port. It has external threads that mate with the cable retention on the service processor communications port. The other end of the cable (designated A) plugs into the uninterruptible power supply vendor-supplied cable for System i<sup>®</sup> communications. It has threads that mate with the cable's external threads on the uninterruptible power supply.

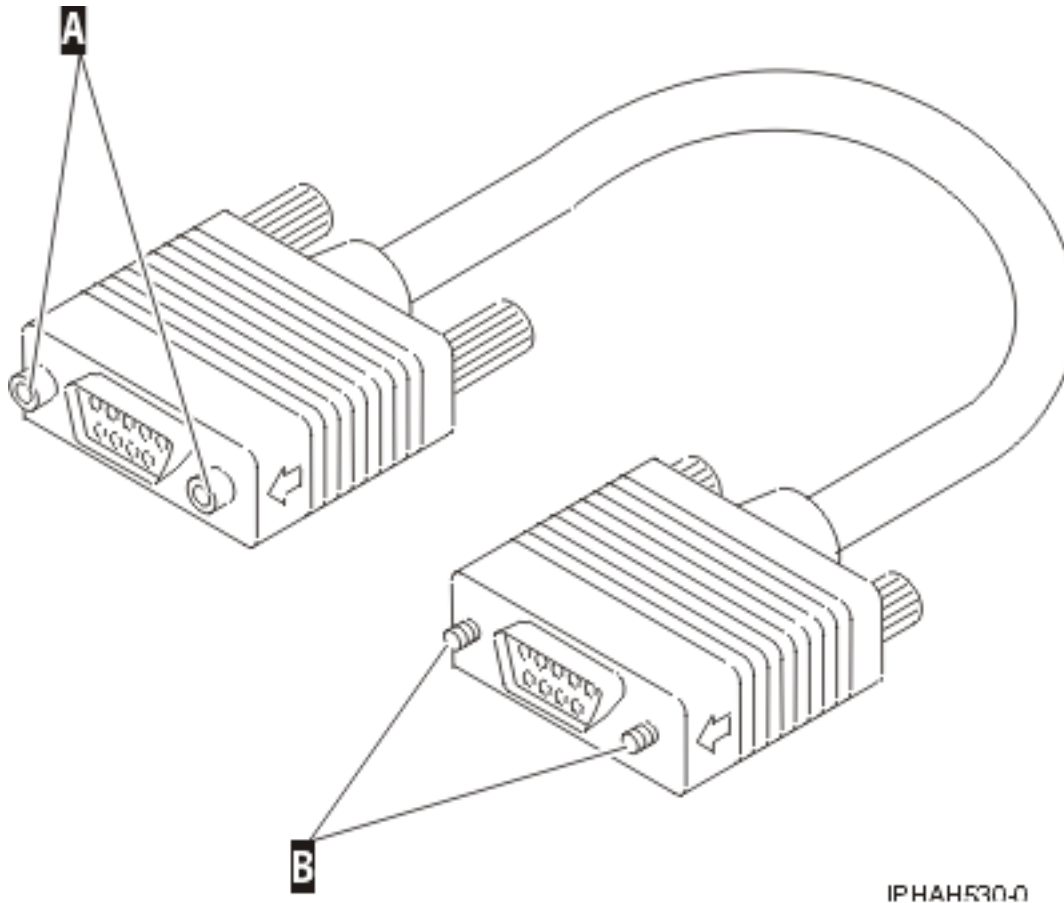

*Figure 127. Uninterruptible power supply connector for the uninterruptible power supply communications cable*

The service processor communications port supports two modes: RS-232 service processor communications port mode and uninterruptible power supply mode. Only one mode is supported at a time. The service processor will detect the presence of an uninterruptible power supply when the 1827 cable is attached and the server is started. The service processor will set the control hardware to condition the signals for the uninterruptible power supply. The mode cannot be changed unless the

system is started again. The following figure shows the converter cable wiring.

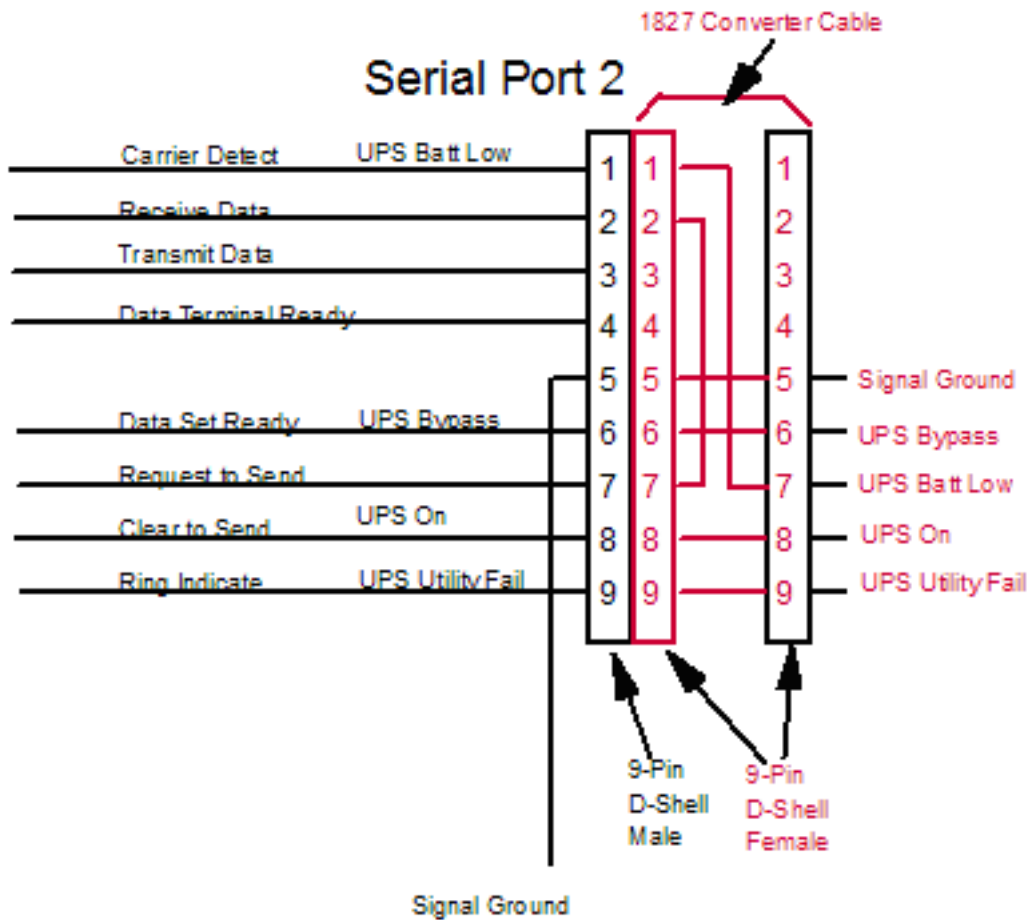

Figure 128. 1827 cable wiring

### Feature code 3930 RJ45 service processor communications port to uninterruptible power supply cable

FC 3930 (part number 46K5108) is a 290 mm (11.4 in.) RJ45 service processor communications power to uninterruptible power supply cable for certain Power System models.

Figure 3 shows the 3930 cable. One end of the cable, letter A, has an RJ45 connector that plugs into the service processor communications port. The other end of the cable, letter B, has a male 9-pin D-shell connector that plugs into the uninterruptible power supply vendor-supplied cable for System i communications. It has threads that mate with the cable external threads on the uninterruptible power supply.

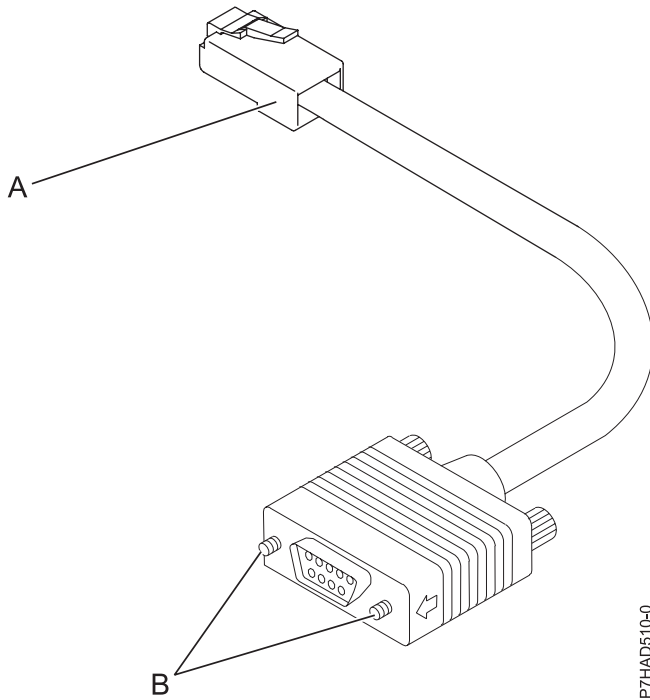

Figure 129. Feature code 3930

## Connecting POWER® product uninterruptible power supply communications for IBM i operating system

Use the following information to connect communications for a POWER system operating IBM i operating system.

**Note:** Serial ports are rendered useless for AIX® use when a Hardware Management Console (HMC) is connected. However, platform connection to the uninterruptible power supply, which is managed by the FSP, is independent of an HMC being attached. Whether or not an HMC is connected, the designated serial port for uninterruptible power supply attach will setup correctly in feature code 1827 is connected before power is applied to the server (uninterruptible power supply attach is detected on FSP IPL). The serial ports are not standard EIA-232 ports. Therefore, the uninterruptible power supply must be attached through the 1827 cable and a relay contact interface (such as IBM type 9910, feature code 2939) via the uninterruptible power supply to use the IBM platform managed solution.

To use a standard uninterruptible power supply manufacturer serial interface and uninterruptible power supply monitoring application for the AIX operating system, an asynchronous adapter (such as 2943 and 5723) must be installed and configured in AIX. The IBM i operating system only supports the IBM platform managed solution.

### 8233-E8B and 8236-E8C uninterruptible power supply communications

Attach the 1827 cable to the POWER server at the P1-T2 location.

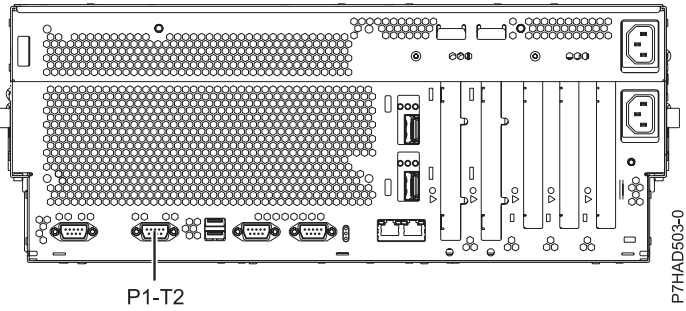

Figure 130. 8233-E8B and 8236-E8C rear view with cable installation location

**8412-EAD, 9117-MMB, 9117-MMC, 9117-MMD, 9179-MHB, 9179-MHC, 9179-MHD, and 5208 or 5877 uninterruptible power supply communications**

Uninterruptible power supply support via the Serial to SPCN feature code (1827) is not supported on the 8412-EAD, 9117-MMB, 9117-MMC, 9117-MMD, 9179-MHB, 9179-MHC, and 9179-MHD. Uninterruptible power supply support may be added by using a 5802 or 5877 expansion unit. SPCN cables are used to attach the 8412-EAD, 9117-MMB, 9117-MMC, 9117-MMD, 9179-MHB, 9179-MHC, and 9179-MHD, and 5802 or 5877 SPCN ports, as shown in Figure 131. The connection from the uninterruptible power supply to the 5802 or 5877 is made directly from the uninterruptible power supply to the port labelled P2-T1. The 1827 is not needed.

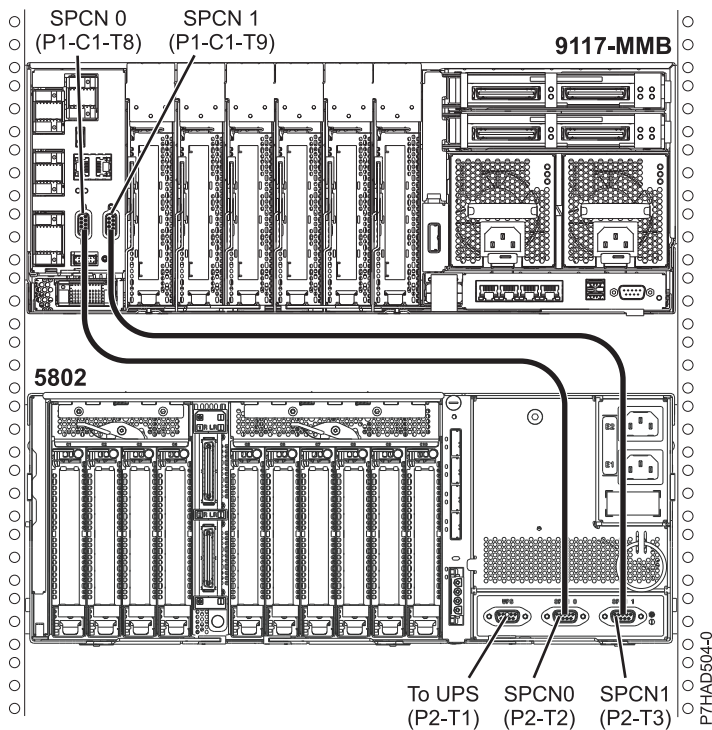

Figure 131. 8412-EAD, 9117-MMB, 9117-MMC, 9117-MMD, 9179-MHB, 9179-MHC, 9179-MHD, and 5208 or 5877 rear view cable installation location

## 8202-E4B, 8202-E4C, 8202-E4D, 8205-E6B, 8205-E6C, 8205-E6D, 8231-E2B, 8231-E1C, 8231-E1D, 8231-E2C, 8231-E2D, and 8268-E1D uninterruptible power supply communications

For IBM Power 710 Express and IBM Power 730 Express (8231-E2B, 8231-E1C, 8231-E1D, 8231-E2C, 8231-E2D, and 8268-E1D), IBM Power 720 Express (8202-E4B, 8202-E4C, and 8202-E4D), and IBM Power 740 Express (8205-E6B, 8205-E6C, and 8205-E6D), feature code 3930 is used in addition to feature code 1827. Uninterruptible power supply communications are supported through a designated RJ45 port via the 3930 cable. See Figure 132 and Figure 133. The 9 pin, male end of the 3930 cable then attaches to the end of the 9 pin, female end of the 1827 cable. See Figure 134.

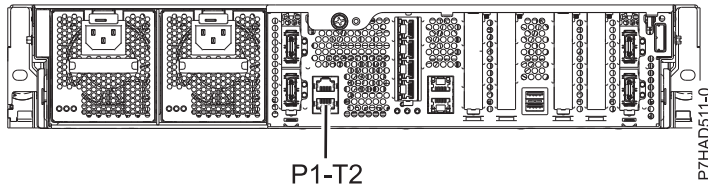

Figure 132. 8231-E2B, 8231-E1C, 8231-E1D, 8231-E2C, 8231-E2D, and 8268-E1D rear view with cable installation location

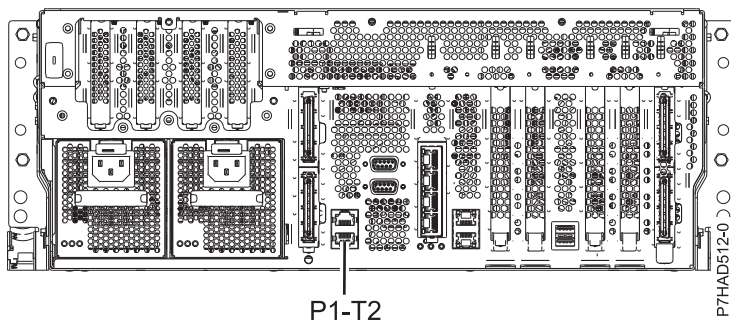

Figure 133. 8202-E4B, 8202-E4C, 8202-E4D, 8205-E6B, 8205-E6C, and 8205-E6D rear view with cable installation location

### UPS Wiring

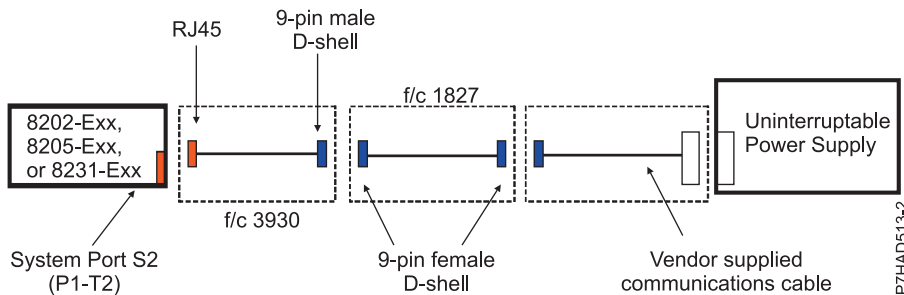

Figure 134. Uninterruptible power supply wiring for the 8202-E4B, 8202-E4C, 8205-E6B, 8205-E6C, 8231-E2B, 8231-E1C, 8231-E1D, 8231-E2C, 8231-E2D, and 8268-E1D

## Power distribution unit and power cord options for 7014, 0551, 0553, and 0555 racks

Power distribution units (PDUs) can be used with the 7014, 0551, 0553 and 0555 racks. The various configurations and specifications are provided.



## Power distribution unit

The following figure shows the four vertical PDU locations in a rack.

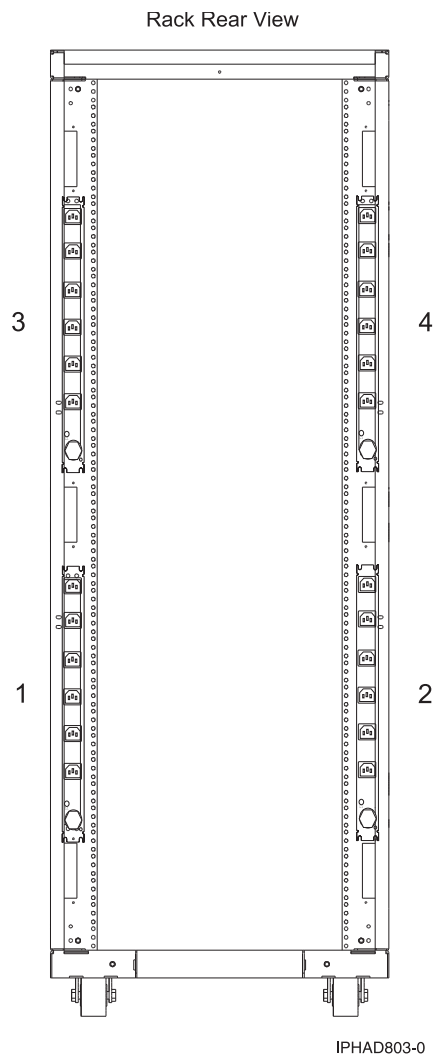

Power distribution units (PDUs) are required with 7014-T00, 7014-T42 IBM racks and optional with 7014-B42, 0553, and 0555 racks, except with a 0578 or 0588 expansion unit. If a PDU is not defaulted or ordered, a power cord is provided with each individual rack-mounted drawer for connection to a country-specific utility mains receptacle or uninterruptible power supply. See the individual rack-mounted drawer specifications for the appropriate power cords.

## 9188 or 7188 universal PDU

Table 147. 9188 universal PDU features

PDU Number	Racks usage	Supported power cords PDU to wall
9188 universal PDU	7014-T00 and 7014-T42 racks	<ul style="list-style-type: none"><li>• 6489</li><li>• 6491</li><li>• 6492</li><li>• 6653</li><li>• 6654</li><li>• 6655</li><li>• 6656</li><li>• 6657</li><li>• 6658</li></ul>

Table 148. 7188 universal PDU features

PDU Number	Racks usage	Supported power cords PDU to wall
7188 universal PDU	7014-T00, 7014-T42, 0551, 0553, and 0555 racks.	<ul style="list-style-type: none"><li>• 6489</li><li>• 6491</li><li>• 6492</li><li>• 6653</li><li>• 6654</li><li>• 6655</li><li>• 6656</li><li>• 6657</li><li>• 6658</li></ul>

The amperage rating of the PDU is either 16 A, 24 A, or 48 A, single phase or three-phase, depending on the power cord.

**Note:** All power cords are 4.3 m (14 ft). For installation in Chicago, only 2.8 m (6 ft) of the 4.3 m (14 ft) power cord can extend beyond the perimeter of the rack frame. If more than 2.8 m (6 ft) can exit the rack, retain any additional cordage within the rack frame with hook-and-loop fastener ties in the cable management space until 2.8 (6 ft) or less exits the rack.

The PDU has twelve customer-usable IEC 320-C13 outlets rated at 200-240 V ac. There are six groups of two outlets fed by six circuit breakers. Each outlet is rated up to 10 A (220 - 240 V ac) or 12 A (200 - 208 V ac), but each group of two outlets is fed from one 20 A circuit breaker derated to 16 A.

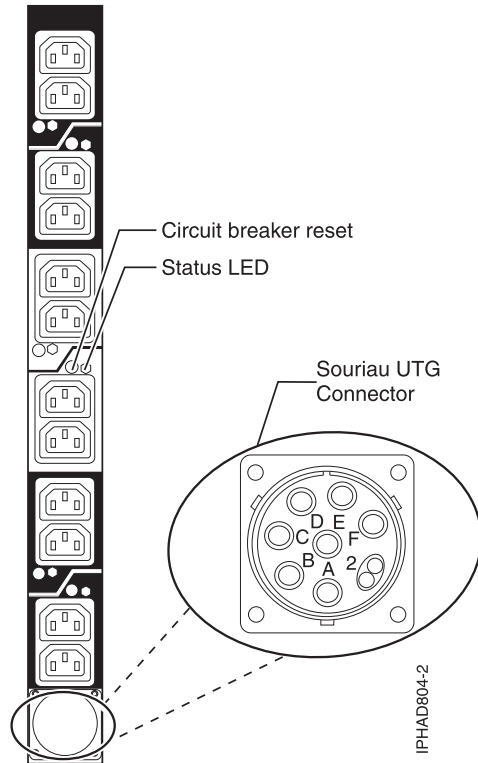

## 5160 single phase PDU

Table 149. 5160 single phase PDU features

PDU Number	Racks usage	Supported power cords PDU to wall
5160 single phase PDU	0551, 0553, and 0555 IBM racks	This is a hard wired power cord with a NEMA L6-30P (30A, 250VAC).

## Typical rack and PDU configurations

See *0551, 0553, 7014, and 0555 rack configurations* for typical configurations and PDUs when the rack is populated with various server models.

## Power distribution unit plus specifications

The power distribution unit plus (PDU+) has power-monitoring capabilities. The PDU+ is an intelligent ac power distribution unit (PDU+) that monitors the amount of power being used by the devices that are plugged into it. The PDU+ provides twelve C13 power outlets and receives power through a Souriau UTG connector. It can be used in many geographies and for many applications by varying the PDU-to-wall power cord, which must be ordered separately. Each PDU+ requires one PDU-to-wall power cord. When the PDU+ is connected to a dedicated power source, it conforms to UL60950, CSA C22.2-60950, EN-60950, and IEC-60950 standards.

## 5889 PDU+

Table 150. 5889 PDU+ features

PDU Number	Racks usage	Supported power cords PDU to wall
5889 PDU+	7014 IBM racks	<ul style="list-style-type: none"> <li>• 6489</li> <li>• 6491</li> <li>• 6492</li> <li>• 6653</li> <li>• 6654</li> <li>• 6655</li> <li>• 6656</li> <li>• 6657</li> <li>• 6658</li> </ul>

Table 151. 5889 PDU+ specifications

Characteristics	Properties
PDU number	5889
Height	43.9 mm (1.73 in.)
Width	447 mm (17.6 in.)
Depth	350 mm (13.78 in.)
Additional clearance	25 mm (0.98 in.) for circuit breakers
	3 mm (0.12 in.) for outlets
Weight (not including power cord)	6.3 kg (13.8 lb)
Weight of power cord (approximate)	5.4 kg (11.8 lb)
Operating temperature at 0 - 914 m (0 - 3000 ft) (room ambient)	10 - 32°C (50 - 90°F)
Operating temperature at 914 - 2133 m (3000 - 7000 ft) (room ambient)	10 - 35°C (50 - 95°F)
Operating humidity	8 - 80% (noncondensing)
Localized air temperature in PDU	60 °C (140°F) maximum
Rated frequency (all feature codes)	50 - 60 Hz
Circuit breakers	Six double-pole branch rated circuit breakers rated at 20 A
Power outlet	12 IEC 320-C13 outlets rated at 10 A (VDE) or 15 A (UL/CSA)

## 7189 PDU+

Table 152. 7189 PDU+ features

PDU number	Racks usage	Supported power cords PDU to wall
7189 PDU+	7014-B42 rack	<ul style="list-style-type: none"> <li>• 6489</li> <li>• 6491</li> <li>• 6492</li> <li>• 6653</li> </ul>

Table 153. 7189 PDU+ specifications

Characteristics	Properties
PDU number	7189
Height	43.9 mm (1.73 in.)
Width	447 mm (17.6 in.)
Depth	350 mm (13.78 in.)
Additional clearance	25 mm (0.98 in.) for circuit breakers
	3 mm (0.12 in.) for outlets
Weight (not including power cord)	6.3 kg (13.8 lb)
Weight of power cord (approximate)	5.4 kg (11.8 lb)
Operating temperature at 0 - 914 m (0 - 3000 ft) (room ambient)	10 - 32°C (50 - 90°F)
Operating temperature at 914 - 2133 m (3000 - 7000 ft) (room ambient)	10 - 35°C (50 - 95°F)
Operating humidity	8 - 80% (noncondensing)
Localized air temperature in PDU	60°C (140°F) maximum
Rated frequency (all feature codes)	50 - 60 Hz
Circuit breakers	Six double-pole branch rated circuit breakers rated at 20 A
Power outlet	Six IEC 320-C19 outlets rated at 16 A (VDE) or 20 A (UL/CSA)

## 7196 PDU+

Table 154. 7196 PDU+ features

PDU Number	Racks usage	Supported power cords PDU to wall
7196 PDU+	7014-B42	Fixed power cord with IEC 60309, 3P+E, 60 A plug

Table 155. 7196 PDU+ specifications

Characteristics	Properties
PDU number	7196
Height	43.9 mm (1.73 in.)
Width	447 mm (17.6 in.)
Depth	350 mm (13.78 in.)
Additional clearance	25 mm (0.98 in.) for circuit breakers
	3 mm (0.12 in.) for outlets
Weight (not including power cord)	6.3 kg (13.8 lb)
Weight of power cord (approximate)	5.4 kg (11.8 lb)
Operating temperature at 0 - 914 m (0 - 3000 ft) (room ambient)	10 - 32°C (50 - 90°F)
Operating temperature at 914 - 2133 m (3000 - 7000 ft) (room ambient)	10 - 35°C (50 - 95°F)
Operating humidity	8 - 80% (noncondensing)
Localized air temperature in PDU	60 °C (140 °F) maximum
Rated frequency (all feature codes)	50 - 60 Hz
Circuit breakers	Six double-pole branch rated circuit breakers rated at 20 A

Table 155. 7196 PDU+ specifications (continued)

Characteristics	Properties
Power outlet	Six IEC 320-C19 outlets rated at 16 A (VDE) or 20 A (UL/CSA)

## 7109 PDU+

Table 156. 7109 PDU+ features

PDU Number	Racks usage	Supported power cords PDU to wall
7109 PDU+	0551, 0553, and 0555 IBM racks	<ul style="list-style-type: none"> <li>• 6489</li> <li>• 6491</li> <li>• 6492</li> <li>• 6653</li> <li>• 6654</li> <li>• 6655</li> <li>• 6656</li> <li>• 6657</li> <li>• 6658</li> </ul>

Table 157. 7109 PDU+ specifications

Characteristics	Properties
PDU number	7109
Height	43.9 mm (1.73 in.)
Width	447 mm (17.6 in.)
Depth	350 mm (13.78 in.)
Additional clearance	25 mm (0.98 in.) for circuit breakers
	3 mm (0.12 in.) for outlets
Weight (not including power cord)	6.3 kg (13.8 lb)
Weight of power cord (approximate)	5.4 kg (11.8 lb)
Operating temperature at 0 - 914 m (0 - 3000 ft) (room ambient)	10°C - 32°C (50°F - 90°F)
Operating temperature at 914 - 2133 m (3000 - 7000 ft) (room ambient)	10°C - 35°C (50°F - 95°F)
Operating humidity	8% - 80% (noncondensing)
Localized air temperature in PDU	60°C (140°F) maximum
Rated frequency (all feature codes)	50 - 60 Hz
Circuit breakers	Six double-pole branch rated circuit breakers rated at 20 A
Power outlet	12 IEC 320-C13 outlets rated at 10 A (VDE) or 15 A (UL/CSA)

## Calculating the power load for 7188 or 9188 power distribution units

Learn how to calculate the power load for power distribution units.

### Rack-mounted 7188 or 9188 power distribution unit

This topic provides the power loading requirements and proper loading sequence for the 7188 or 9188 power distribution unit.

The IBM 7188 or 9188 rack-mounted power distribution unit (PDU) contains 12 IEC 320-C13 outlets connected to six 20 A circuit breakers (two outlets per circuit breaker). The PDU employs an inlet current that allows a variety of power cord options that are listed in the following chart. Based on the power cord that is used, the PDU can supply from 4.8 kVa to 19.2 kVa.

*Table 158. Power cord options*

Feature code	Power cord description	kVa available
6489	Power cord, PDU to wall, 4.3 m (14 ft), 3-phase, Souriau UTG, IEC 60309 32 A 3P+N+E plug	21.0
6491	Power cord, PDU to wall, 4.3 m (14 ft), 200 - 240 V ac, Souriau UTG, IEC 60309 63 A P+N+E plug	9.6
6492	Power cord, PDU to wall, 4.3 m (14 ft), 200 - 240 V ac, Souriau UTG, IEC 60309 60 A 2P+E plug	9.6
6653	Power cord, PDU to wall, 4.3 m (14 ft), 3-phase, Souriau UTG, IEC 60309 16A 3P+N+E plug	9.6
6654	Power cord, PDU to wall, 4.3 m (14 ft), 200 - 240 V ac, Souriau UTG, Plug type 12 plug	4.8
6655	Power cord, PDU to wall, 4.3 m (14 ft), 200 - 240 V ac, Souriau UTG, Plug type 40 plug	4.8
6656	Power cord, PDU to wall, 4.3 m (14 ft), 200 - 240 V ac, Souriau UTG, IEC 60309 32 A P+N+E plug	4.8
6657	Power cord, PDU to wall, 4.3 m (14 ft), 200 - 240 V ac, Souriau UTG, Plug type PDL plug	4.8
6658	Power cord, PDU to wall, 4.3 m (14 ft), 200 - 240 V ac, Souriau UTG, Plug type KP plug	4.8

## Loading requirements

The power loading of the 7188 or 9188 PDU must follow these rules:

1. Total power load connected to the PDU must be limited to below the kVa listed in the table.
2. Total power load connected to any one circuit breaker must be limited to 16 A (derating of circuit breaker).
3. Total power load connected to any one IEC320-C13 outlet must be limited to 10 A.

**Note:** The load on the PDU when a dual line configuration is used will only be half the total load of the system. When calculating the power load on the PDU, you must include the total power load of each drawer even if the load is distributed over two PDUs.

## Loading sequence

Follow these loading sequence steps:

1. Collect power requirements for all units that will be connected to the 7188 or 9188 PDU. See your server specifications for specific power requirements.
2. Sort list by total power required from highest power draw to lowest power draw.
3. Connect highest power drawer to outlet 1 on circuit breaker 1.
4. Connect next highest power drawer to outlet 3 on circuit breaker 2.
5. Connect next highest power drawer to outlet 5 on circuit breaker 3.
6. Connect next highest power drawer to outlet 7 on circuit breaker 4.
7. Connect next highest power drawer to outlet 9 on circuit breaker 5.

8. Connect next highest power drawer to outlet 11 on circuit breaker 6.
9. Connect next highest power drawer to outlet 12 on circuit breaker 6.
10. Connect next highest power drawer to outlet 10 on circuit breaker 5.
11. Connect next highest power drawer to outlet 8 on circuit breaker 4.
12. Connect next highest power drawer to outlet 6 on circuit breaker 3.
13. Connect next highest power drawer to outlet 4 on circuit breaker 2.
14. Connect next highest power drawer to outlet 2 on circuit breaker 1.

Following these rules will allow the load to be distributed more evenly across the six PDU circuit breakers. Ensure that your total power load is below the maximum listed in the table and that each circuit breaker is not loaded above 15 A.

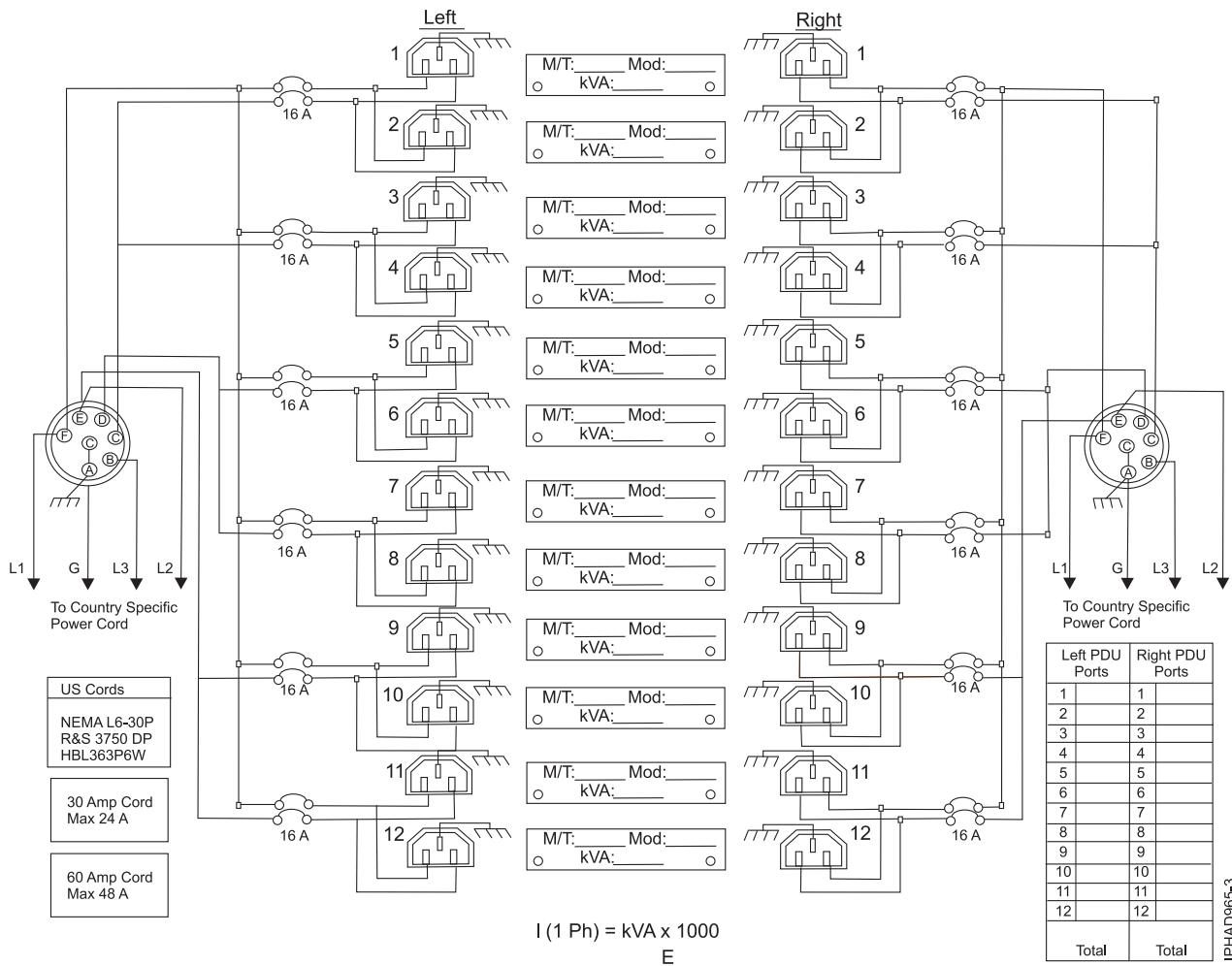



---

## Planning for cables

Learn how to develop plans for cabling your server and devices.

---

### Cable management

These guidelines ensure that your system and its cables have optimal clearance for maintenance and other operations. The guidelines also provide guidance in correctly cabling your system and using the appropriate cables.

The following guidelines provide cabling information for installing, migrating, relocating, or upgrading your system:

- Position drawers in racks to allow enough space, where possible, for cable routing on the bottom and top of the rack, and between drawers.
- Shorter drawers should not be placed between longer drawers in the rack (for example, placing a 19-inch drawer between two 24-inch drawers).
- When a specific cable plugging sequence is required, for example, for concurrent maintenance (symmetric multiprocessing cables), label the cables appropriately and note the sequence order.
- To facilitate cable routing, install cables in the following order:
  1. System power control network (SPCN) cables
  2. Power cables
  3. Communications (serial attached SCSI, InfiniBand, remote input/output, and peripheral component interconnect express) cables

**Note:** Install and route the communications cables, starting with the smallest diameter first and then progressing to the largest diameter. This applies to installing them into the cable management arm and retaining them to the rack, brackets, and other features that may be provided for cable management.

- Install and route the communications cables, starting with smallest diameter first and then progressing to the largest diameter.
- Use the innermost cable-management bridge lances for SPCN cables.
- Use the middle cable-management bridge lances for power and communications cables.
- The outermost row of cable-management bridge lances are available for use when routing cables.
- Use the cable raceways on the sides of the rack to manage excess SPCN and power cables.
- There are four cable-management bridge lances on the top of the rack. Use these bridge lances to route the cables from one side of the rack to the other, by routing to the top of the rack, where possible. This routing helps to avoid having a cable bundle that blocks the cable exit opening at the bottom of the rack.
- Use the cable management brackets provided with the system to maintain concurrent maintenance routing.
- Maintain a minimum bend diameter of 101.6 mm (4 in.) for communications (SAS, IB, RIO, and PCIe) cables.
- Maintain a minimum bend diameter of 50.8 mm (2 in.) for power cables.
- Maintain a minimum bend diameter of 25.4 mm (1 in.) for SPCN cables.
- Use the shortest-length cable available for each point-to-point connection.
- If cables have to be routed across the rear of a drawer, leave enough slack to reduce the tension on the cables for maintenance of the drawer.

- When routing cables, leave enough slack around the power connection on the power distribution unit (PDU) so that the wall-to-PDU line cord can be attached to the PDU.
- Use hook-and-loop fasteners where necessary.

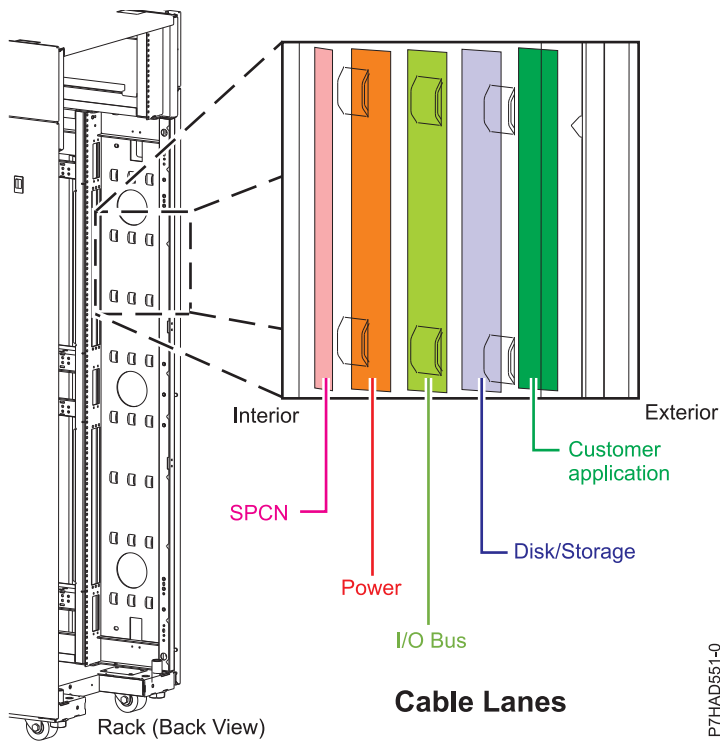

Figure 135. Cable management bridge lances

## Cable bend radius

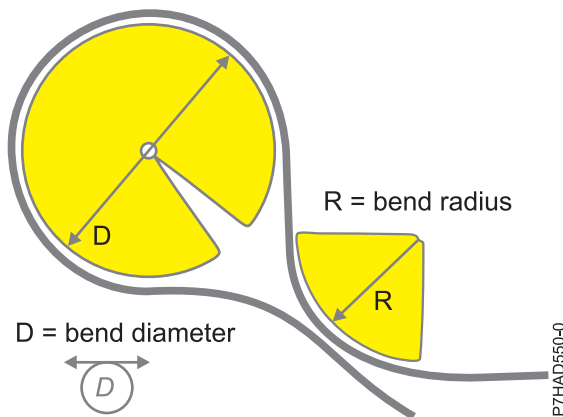

Figure 136. Cable bend radius

## Power cord routing and retention

Proper power cord routing and retention ensures that your system remains connected to a power supply.

The primary purpose of power cord retention is to prevent unexpected power loss to your system that could potentially cause system operations to stop functioning.

Different types of power cord retention are available. Some of the most commonly used types of retention include:

- Cable management arms
- Rings
- Clamps
- Plastic straps
- Hook-and-loop fasteners

Power cord retainers are typically found at the rear of the unit and on the chassis or pedestal near the alternating current (AC) power cord input.

Systems that are rack mounted and are on rails should use the provided cable management arm.

Systems that are rack mounted, but are not on rails should use the provided rings, clamps, or straps.

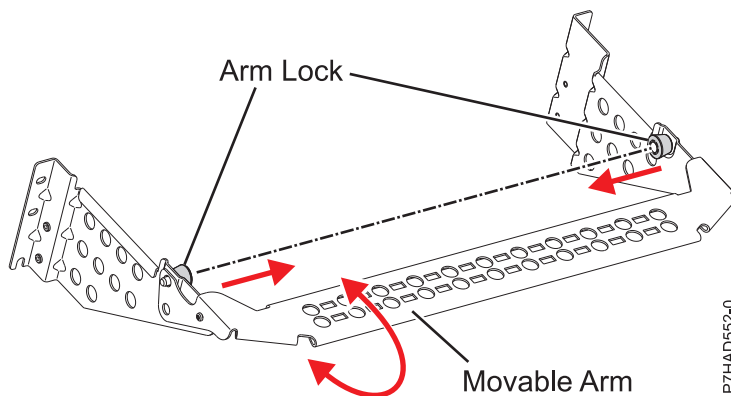

Figure 137. Cable management bracket

---

## Planning for serial-attached SCSI cables

Serial-attached SCSI (SAS) cables provide serial communication for transfer of data for directly attached devices, such as hard disk drives, solid-state drives, and CD-ROM drives.

### SAS cable overview

Serial-attached SCSI (SAS) is an evolution of the parallel SCSI device interface into a serial point-to-point interface. SAS physical links are a set of four wires used as two differential signal pairs. One differential signal transmits in one direction while the other differential signal transmits in the opposite direction. Data might be transmitted in both directions simultaneously. SAS physical links are contained in ports. A port contains one or more SAS physical links. A port is a wide port if there are more than one SAS physical link in the port. Wide ports are designed to enhance performance and provide redundancy in case an individual SAS physical link fail.

There are two types of SAS connectors, mini SAS and mini SAS high density (HD). High density cables are typically needed to support 6 Gb/s SAS.

Each SAS cable contains four SAS physical links that are typically organized into either a single 4x SAS port or two 2x SAS ports. Each end of the cable uses a mini SAS or mini SAS HD 4x connector. Review the following design and installation criteria before installing your SAS cables:

- Only specific cabling configurations are supported. Many configurations could be constructed that are not supported and will either not function correctly or will generate errors. See “SAS cabling configurations” on page 155 for figures of the supported cabling configurations.

- Each mini-SAS 4x connector is keyed to help prevent cabling an unsupported configuration.
- Each cable end has a label that graphically describes the correct component port to which it is connected, such as:
  - SAS adapter
  - Expansion drawer
  - System external SAS port
  - Internal SAS disk slots connection.
- Cable routing is important. For example, YO, YI, and X cables must be routed along the right side of the rack frame (as viewed from the rear) when connecting to a disk expansion drawer. Additionally, X cables must be attached to the same numbered port on both SAS adapters to which it connects.
- When a choice of cable lengths is available, select the shortest cable that will provide the needed connectivity.
- Always use care when inserting or removing a cable. The cable should slide easily into the connector. Forcing a cable into a connector can cause damage to the cable or connector.
- The X cables are only supported on all SAS PCI (RAID) adapters and only when RAID is enabled.
- Not all cabling configurations are supported when using solid-state drives (SSD). See *Installing and configuring Solid State Drives* for more information.

## Supported SAS cable information

The following table contains a list of the supported serial-attached SCSI (SAS) cable types and their designed usage.

*Table 159. Functions for supported SAS cables*

Cable type	Function
AA cable	This cable is used to connect between the top ports on two tri-port SAS adapters in a RAID configuration.
AI cable	This cable is used to connect from a SAS adapter to internal SAS disk slots that uses an FC 3650 or FC 3651 cable card, or by using an FC 3669 to the system external SAS port on your system.
AE cable	These cables are used to connect a SAS adapter to a media expansion drawer. These cables can also be used to connect two SAS adapters to a disk expansion drawer in a unique JBOD configuration.
AT cable	This cable is used with a PCIe 12X I/O drawer to connect from a PCIe SAS adapter to the internal SAS disk slots.
EE cable	This cable is used to connect one disk expansion drawer to another in a cascaded configuration. Disk expansion drawers can only be cascaded one level deep, and only in certain configurations.
YO cable	This cable is used to connect a SAS adapter to a disk expansion drawer. The cable must be routed along the right side of the rack frame (as viewed from the rear) when connecting to a disk expansion drawer.
YI cable	This cable is used to connect a system external SAS port to a disk expansion drawer. The cable must be routed along the right side of the rack frame (as viewed from the rear) when connecting to a disk expansion drawer.

Table 159. Functions for supported SAS cables (continued)

Cable type	Function
X cable	This cable is used to connect two SAS adapters to a disk expansion drawer in a RAID configuration. The cable must be routed along the right side of the rack frame (as viewed from the rear) when connecting to a disk expansion drawer.

The following table contains specific information about each supported SAS cable.

Table 160. Supported SAS cables

Name	Length	IBM part number	Feature code
SAS 6x AA cable	1.5 m (4.9 ft)	74Y9029	5917
	3 m (9.8 ft)	74Y9030	5915
	6 m (19.6 ft)	74Y9031	5916
SAS 6x AT cable	0.6 m (1.9 ft)	74Y9035	3689
SAS 6x YO cable	1.5 m (4.9 ft)	74Y9036	3450
	3 m (9.8 ft)	74Y9037	3451
	6 m (19.6 ft)	74Y9038	3452
	10 m (32.8 ft)	74Y9039	3453
	15 m (49.2 ft)	74Y9040	3457
SAS 6x X cable	3 m (9.8 ft)	74Y9041	3454
	6 m (19.6 ft)	74Y9042	3455
	10 m (32.8 ft)	74Y9043	3456
	15 m (49.2 ft)	74Y9044	3458
SAS 4x AI cable	1 m (3.2 ft)	44V4041	3679
SAS 4x AE cable	3 m (9.8 ft)	44V4163	3684
	6 m (19.6 ft)	44V4164	3685
SAS 4x AT cable	0.6 m (1.9 ft)	44V5132	3688
SAS 4x EE cable	1 m (3.2 ft)	44V4147	3652
	3 m (9.8 ft)	44V4148	3653
	6 m (19.6 ft)	44V4149	3654
HD SAS 4x AT cable	0.6 m (1.9 ft)	74Y6260	3689
HD SAS AA cable	0.6 m (1.9 ft)	00J0094	5918
	1.5 m (4.9 ft)	74Y9029	5917
	3 m (9.8 ft)	74Y9030	5915
	6 m (19.6 ft)	74Y9031	5916
HD SAS EX cable	1.5 m (4.9 ft)	00E5648	5926
	3 m (9.8 ft)	74Y9033	3675
	6 m (19.6 ft)	74Y9034	3680
HD SAS X cable	3 m (9.8 ft)	74Y9041	3454
	6 m (19.6 ft)	74Y9042	3455
	10 m (32.8 ft)	74Y9043	3456

Table 160. Supported SAS cables (continued)

Name	Length	IBM part number	Feature code
HD SAS YO cable	1.5 m (4.9 ft)	74Y9036	3450
	3 m (9.8 ft)	74Y9037	3451
	6 m (19.6 ft)	74Y9038	3452
	10 m (32.8 ft)	74Y9039	3453
SAS AA cable	3 m (9.8 ft)	44V8231	3681
	6 m (19.6 ft)	44V8230	3682
SAS YO cable	1.5 m (4.9 ft)	44V4157	3691
	3 m (9.8 ft)	44V4158	3692
	6 m (19.6 ft)	44V4159	3693
	15 m (49.2 ft)	44V4160	3694
SAS YI cable	1.5 m (4.9 ft)	44V4161	3686
	3 m (9.8 ft)	44V4162	3687
SAS X cable	3 m (9.8 ft)	44V4154	3661
	6 m (19.6 ft)	44V4155	3662
	15 m (49.2 ft)	44V4156	3663
Disk backplane to rear bulkhead, cascading. (internal cable)		42R5751	3668
Split disk backplane to rear bulkhead (internal cable)		44V5252	3669

The following table contains specific information about each supported SAS cable feature with narrow HD connectors for PCIe3 SAS adapters.

Table 161. Supported SAS cables for PCIe3 SAS adapters

Name	Length	IBM part number	Feature code
HD SAS 4x AT narrow connector cable	0.6 m (1.9 ft)	00E6291	ECBB
HD SAS AA narrow connector cable	0.6 m (1.9 ft)	00E6287	ECC0
	1.5 m (4.9 ft)	00E6288	ECC2
	3 m (9.8 ft)	00E6289	ECC3
	6 m (19.6 ft)	00E6290	ECC4
HD SAS X narrow connector cable	3 m (9.8 ft)	00E6297	ECBJ
	6 m (19.6 ft)	00E6298	ECBK
	10 m (32.8 ft)	00E6299	ECBL
	15 m (49.2 ft)	00E6300	ECBM
HD SAS YO narrow connector cable	1.5 m (4.9 ft)	00E6292	ECBT
	3 m (9.8 ft)	00E6293	ECBU
	6 m (19.6 ft)	00E6294	ECBV
	10 m (32.8 ft)	00E6295	ECBW
	15 m (49.2 ft)	00E6296	ECBX

Table 161. Supported SAS cables for PCIe3 SAS adapters (continued)

Name	Length	IBM part number	Feature code
HD SAS AE1 narrow connector cable	4 m (13.1 ft)	46C2900	ECBY/5507
HD SAS YE1 narrow connector cable	3 m (9.8 ft)	46C2902	ECBZ/5509
HD SAS AS narrow connector cable	3 m (9.8 ft)	00FW799	ECC5

The following table contains cable label information. The graphic labels are designed to match the correct component port to which the cable end is to be attached.

Table 162. SAS cable labeling



Name	Connects	Label
SAS 6x AA cable	Top connectors on tri-port SAS adapter to tri-port SAS adapter	
SAS 6x AT cable	PCIe SAS adapter in PCIe 12X I/O drawer to the internal SAS disk slots	
SAS 6x YO cable	SAS adapter	
SAS 6x X cable	Two SAS adapters to a disk expansion drawer in a RAID configuration	
SAS 4x AE cable	SAS adapter to a media expansion drawer or two SAS adapters to a disk expansion drawer in a unique JBOD configuration	

Table 162. SAS cable labeling (continued)

Name	Connects	Label
SAS 4x AI cable	SAS adapter to internal SAS disk slots to the system external SAS port on your system	
SAS 4x AT cable	PCIe SAS adapter in PCIe 12X I/O drawer to the internal SAS disk slots	
SAS 4x EE cable	One disk expansion drawer to another disk expansion drawer in a cascaded configuration	
SAS AA cable	Top connectors on tri-port SAS adapter to tri-port SAS adapter	
SAS YO cable	SAS adapter	
SAS X cable	Two SAS adapters to a disk expansion drawer in a RAID configuration	
SAS YI cable	System external SAS port to a disk expansion drawer	

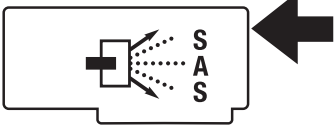

## Cable section lengths

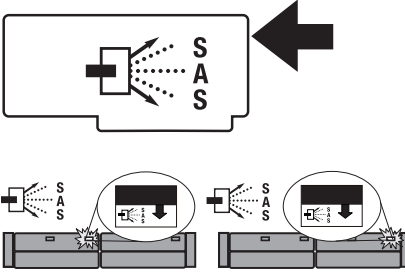
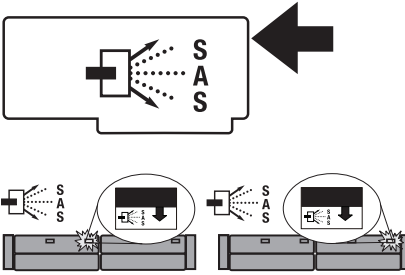
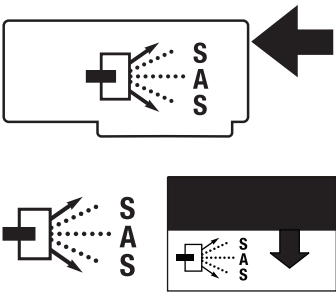
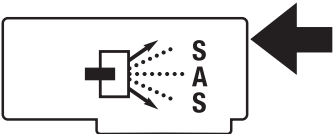
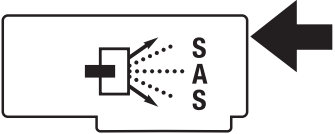
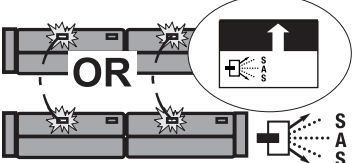
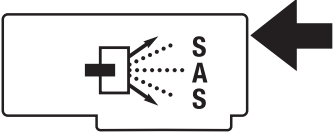
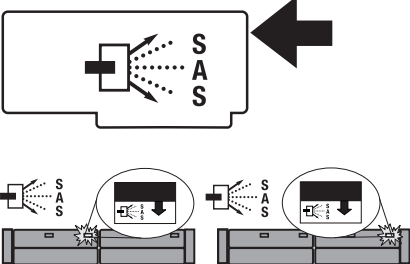
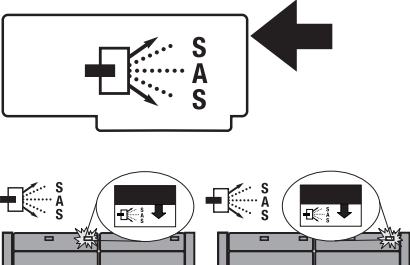
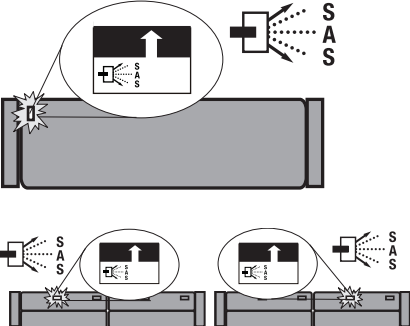
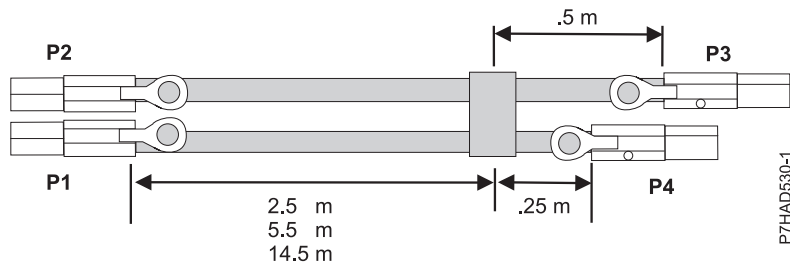

Figure 138. SAS external X cable assembly cable lengths

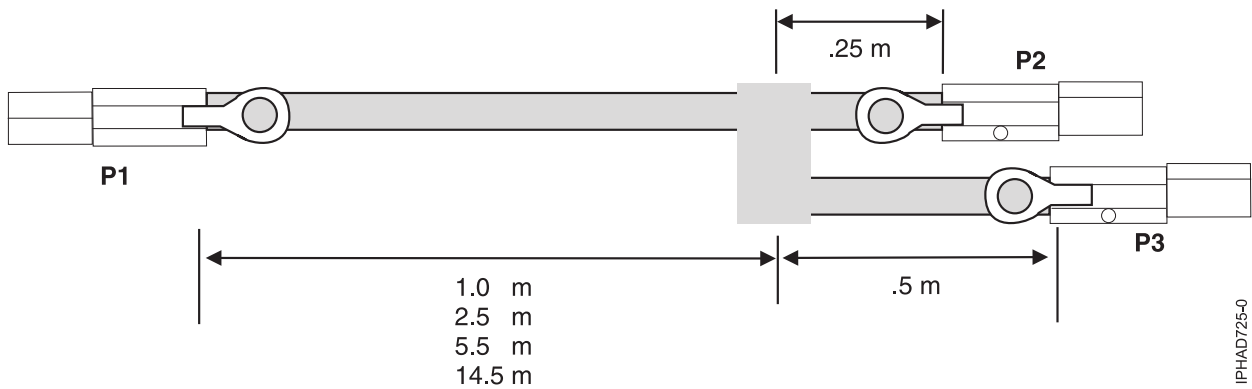

Figure 139. SAS external YO-cable assembly cable lengths

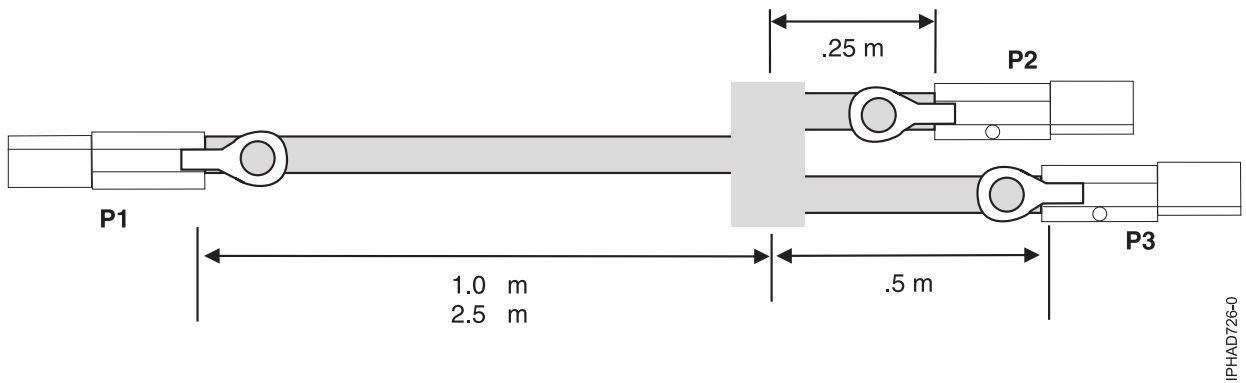

Figure 140. SAS external YI-cable assembly cable lengths

## SAS cabling configurations

The following sections provide the typical supported SAS cabling configurations. Many configurations could be constructed that are not supported and will either not function correctly or will generate errors. To avoid problems, restrict cabling to only the general types of configurations shown in the following sections.

- "SAS adapter to disk expansion drawers" on page 156
- "SAS adapter to media expansion drawer" on page 159
- "SAS adapter to expansion drawer combinations" on page 160
- "System external SAS port to disk expansion drawer" on page 161

- “SAS adapter to internal SAS disk slots ” on page 162
- “Two SAS adapters to disk expansion drawer multi-initiator high availability (HA) RAID configuration” on page 164
- “Two RAID SAS adapters with HD connectors to disk expansion drawer in a multi-initiator high availability (HA) mode” on page 168
- “Two SAS adapters to disk expansion drawer - multi-initiator HA JBOD configuration” on page 172
- PCIe SAS adapter in PCIe 12X I/O drawer to the internal SAS disk slots
- SAS cabling to the 5887 drawer

## SAS adapter to disk expansion drawers

Figure 141, Figure 142 on page 157, Figure 143 on page 158, and Figure 144 on page 159 illustrate connecting a SAS adapter to one, two, three, or four disk expansion drawers. It is also possible to connect three disk expansion drawers by omitting one of the cascaded drawers shown in Figure 143 on page 158. Disk expansion drawers can be cascaded only one level deep.

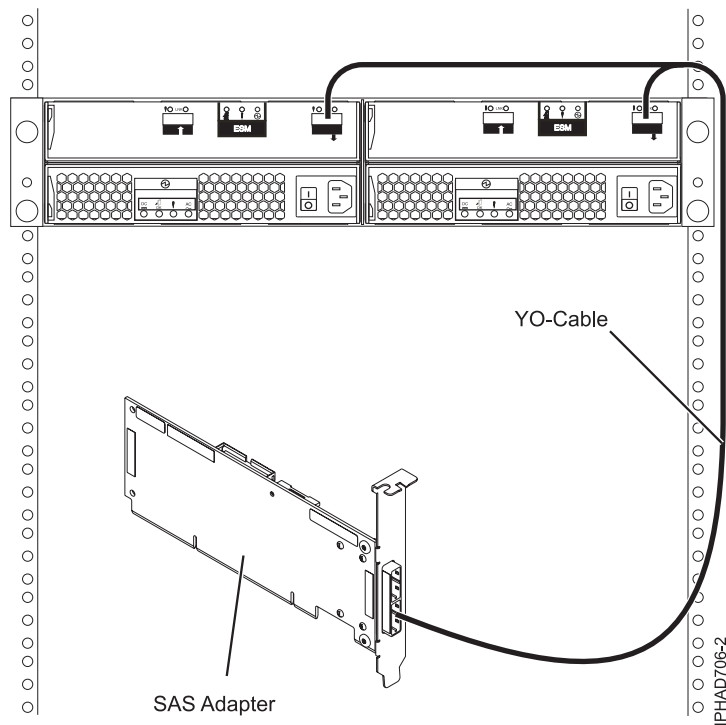

Figure 141. SAS adapter to a disk expansion drawer

**Note:** The YO cable must be routed along the right side of the rack frame.

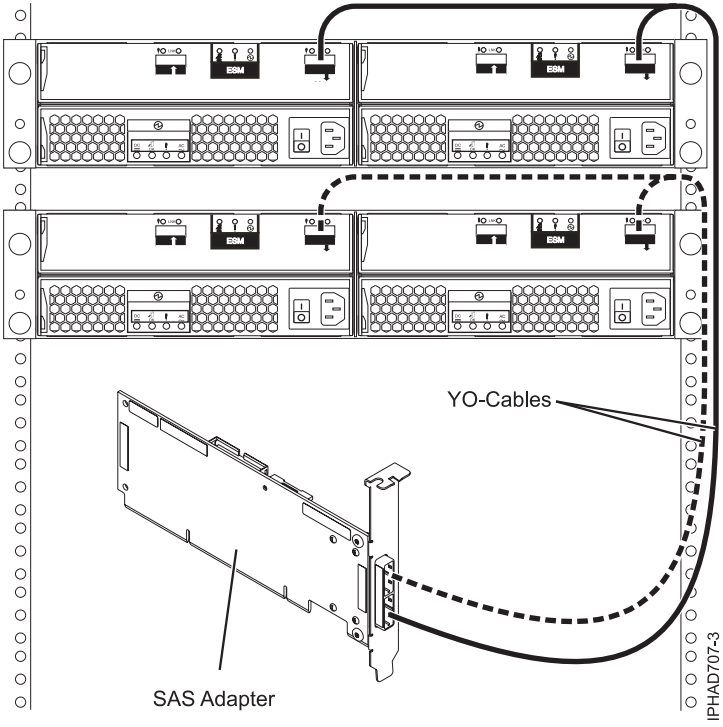

Figure 142. SAS adapter to two disk expansion drawers

**Note:** The YO cable must be routed along the right side of the rack frame.

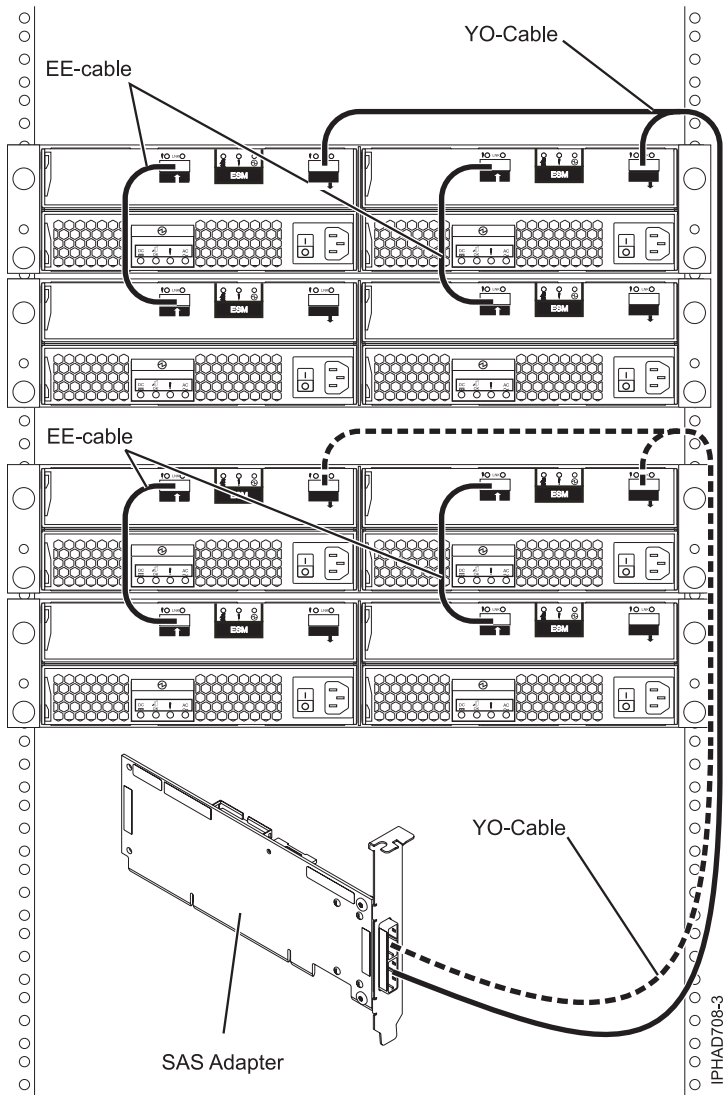

Figure 143. SAS adapter to four disk expansion drawers

**Note:** The YO cable must be routed along the right side of the rack frame.

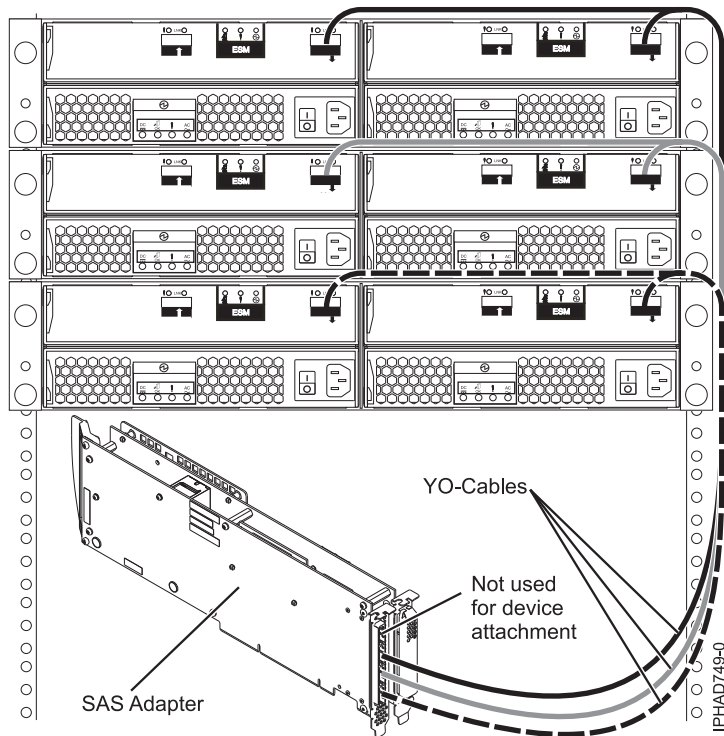

Figure 144. Tri-port SAS adapter to disk expansion drawers

When attaching only hard disk drives, it is also possible to cascade a second disk expansion drawer off of two out of the three drawers for a maximum of five disk expansion drawers per adapter. See Figure 143 on page 158. Disk expansion drawers can be cascaded only one level deep.

**Note:** The YO cable must be routed along the right side of the rack frame.

### SAS adapter to media expansion drawer

Figure 145 on page 160 illustrates connecting a SAS adapter to a media expansion drawer. It is also possible to connect a second media expansion drawer to the second port of the SAS adapter.

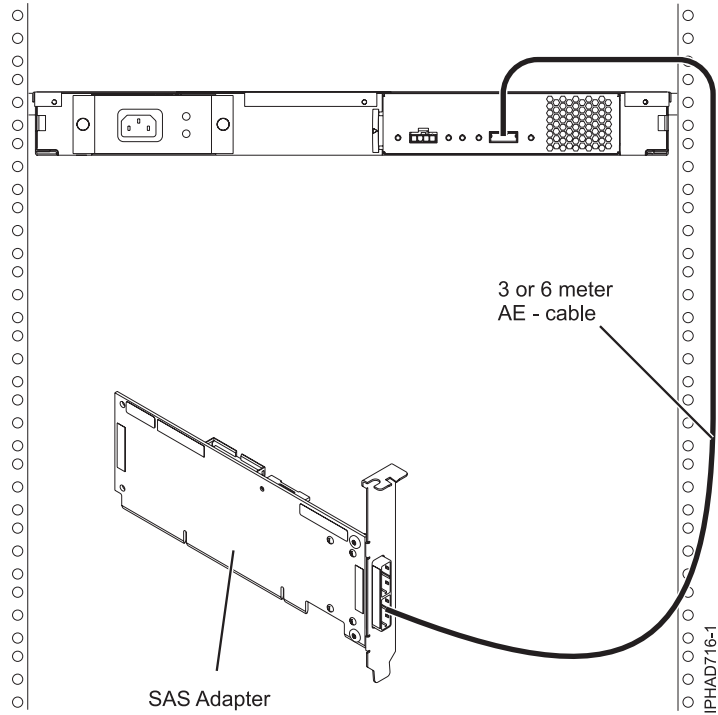

Figure 145. SAS adapter to a media expansion drawer

### SAS adapter to expansion drawer combinations

Figure 146 on page 161 illustrates connecting a SAS adapter to both a disk expansion drawer and a media expansion drawer on separate adapter ports. It is also possible to cascade a second disk expansion drawer (see Figure 143 on page 158).

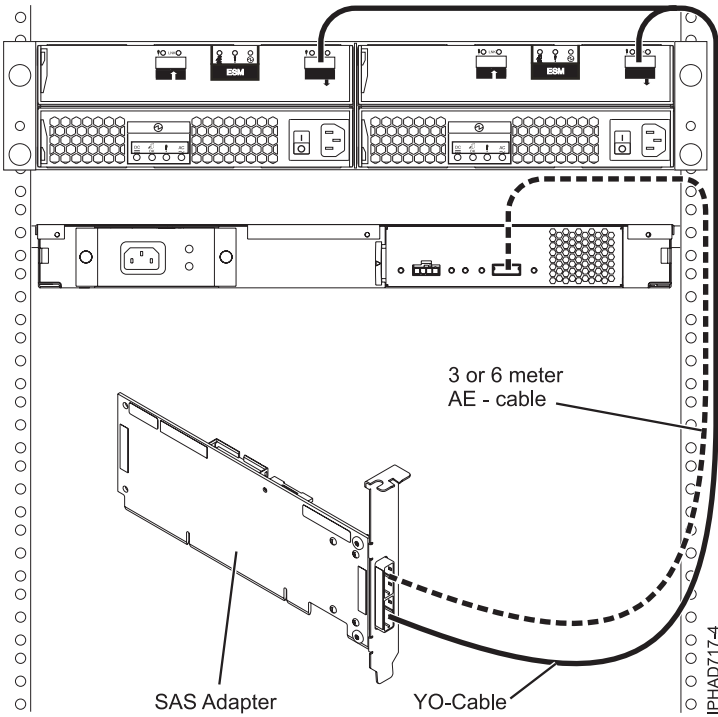

Figure 146. SAS adapter to both a disk expansion drawer and a media expansion drawer

**Note:** The YO cable must be routed along the right side of the rack frame.

### System external SAS port to disk expansion drawer

Figure 147 on page 162 illustrates connecting a system external SAS port to a disk expansion drawer. Disk expansion drawers cannot be cascaded.

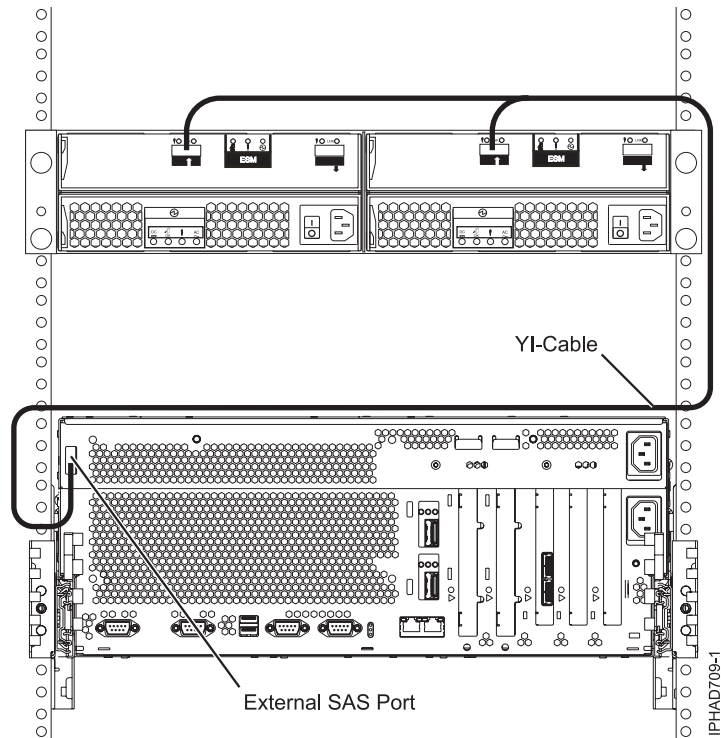

Figure 147. System external SAS adapter port to a disk expansion drawer

**Note:** The YI cable must be routed along the right side of the rack frame.

### SAS adapter to internal SAS disk slots

Figure 148 on page 163 illustrates connecting a SAS adapter to internal SAS disk slots through the system external SAS port.

**Note:** Internal cable FC 3669 must be installed to enable this configuration. For more information, see Installing the external SAS port.



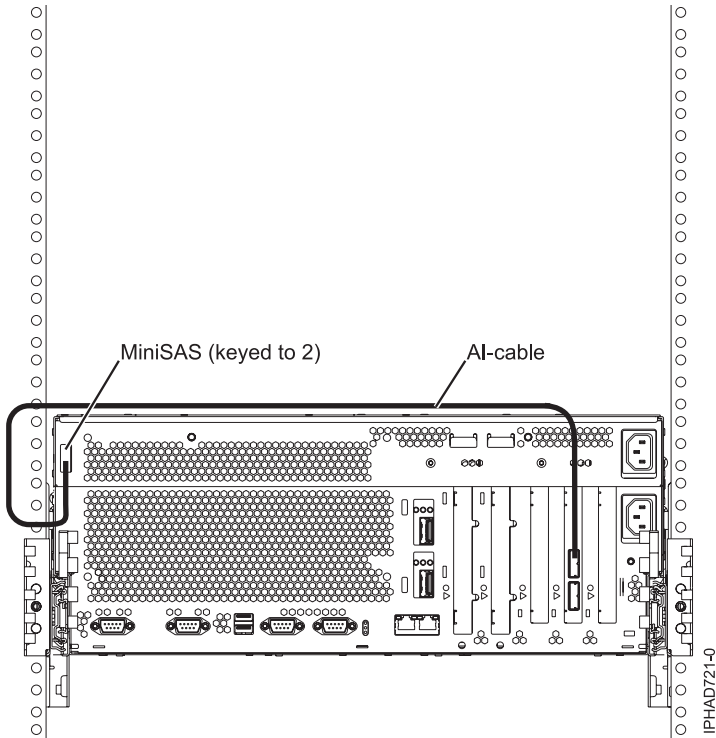

Figure 148. SAS adapter to internal SAS disk slots through the system external SAS port

**Notes:**

- Internal cable FC 3669 must be installed to enable this configuration (Models 8233-E8B and 8236-E8C). For more information, see Installing the external SAS port.
- The second connector on the adapter can be used to attach a disk expansion or media expansion drawer as shown in Figure 141 on page 156 or Figure 145 on page 160.

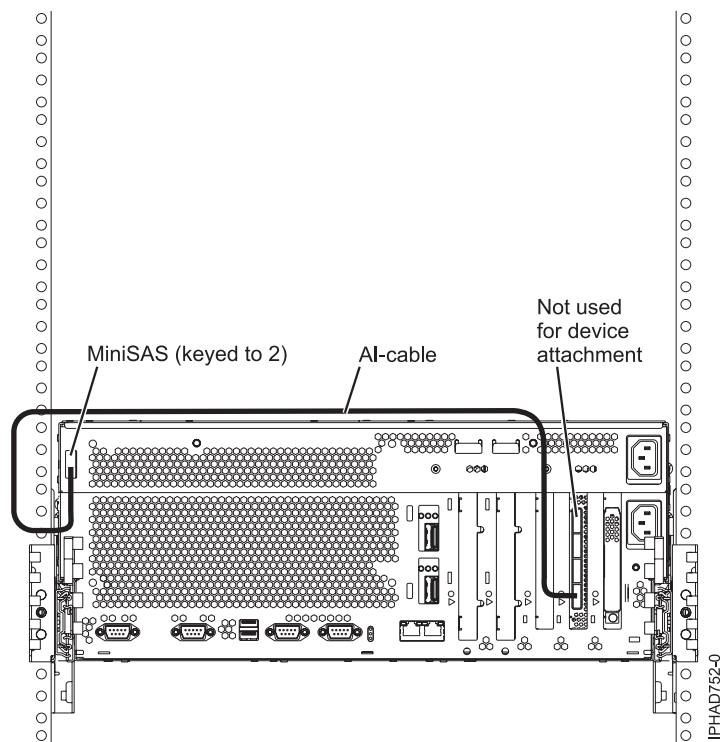

Figure 149. FC5904 or FC5908 adapter attached to disk expansion drawers

**Note:**

- The remaining two connectors on the adapter can be used to attach disk expansion drawers as shown in Figure 144 on page 159.

**Two SAS adapters to disk expansion drawer multi-initiator high availability (HA) RAID configuration**

Figure 150 on page 165, Figure 151 on page 166, Figure 152 on page 167, and Figure 153 on page 168 illustrate connecting two SAS adapters to one, two, or four disk expansion drawers in a RAID configuration. It is also possible to connect three disk expansion drawers by omitting one of the cascaded drawers shown in Figure 152 on page 167. Disk expansion drawers can be cascaded only one level deep.

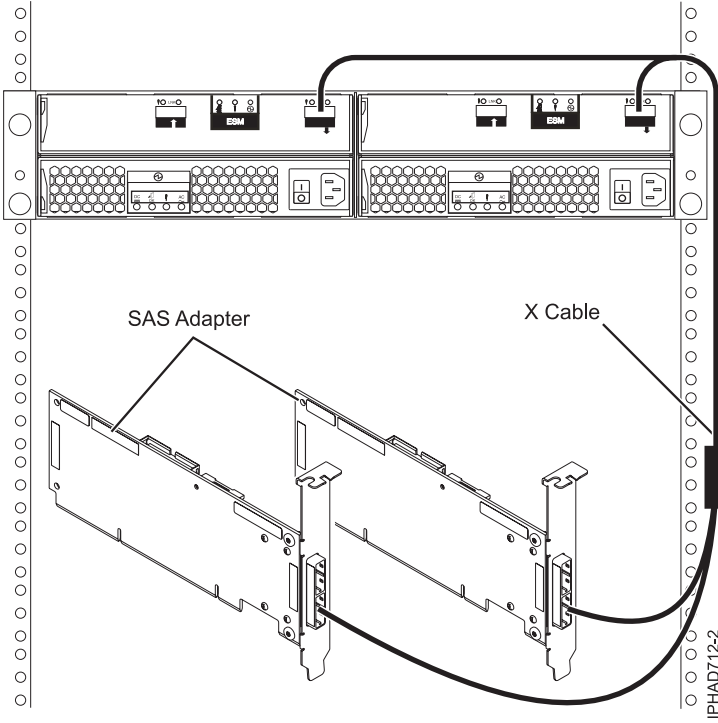

Figure 150. Two SAS RAID adapters to a disk expansion drawer in a multi-initiator HA RAID configuration

**Notes:**

- The X cable must be routed along the right side of the rack frame.
- The X cable must be attached to the same numbered port on all adapters.

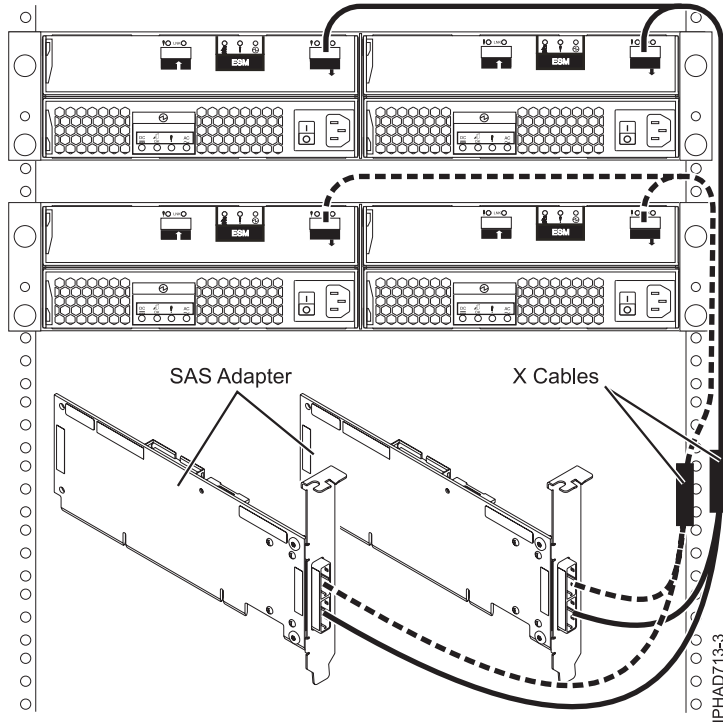

Figure 151. Two SAS RAID adapters to two disk expansion drawers in a multi-initiator HA RAID configuration

**Notes:**

- The X cable must be routed along the right side of the rack frame.
- The X cable must be attached to the same numbered port on all adapters.

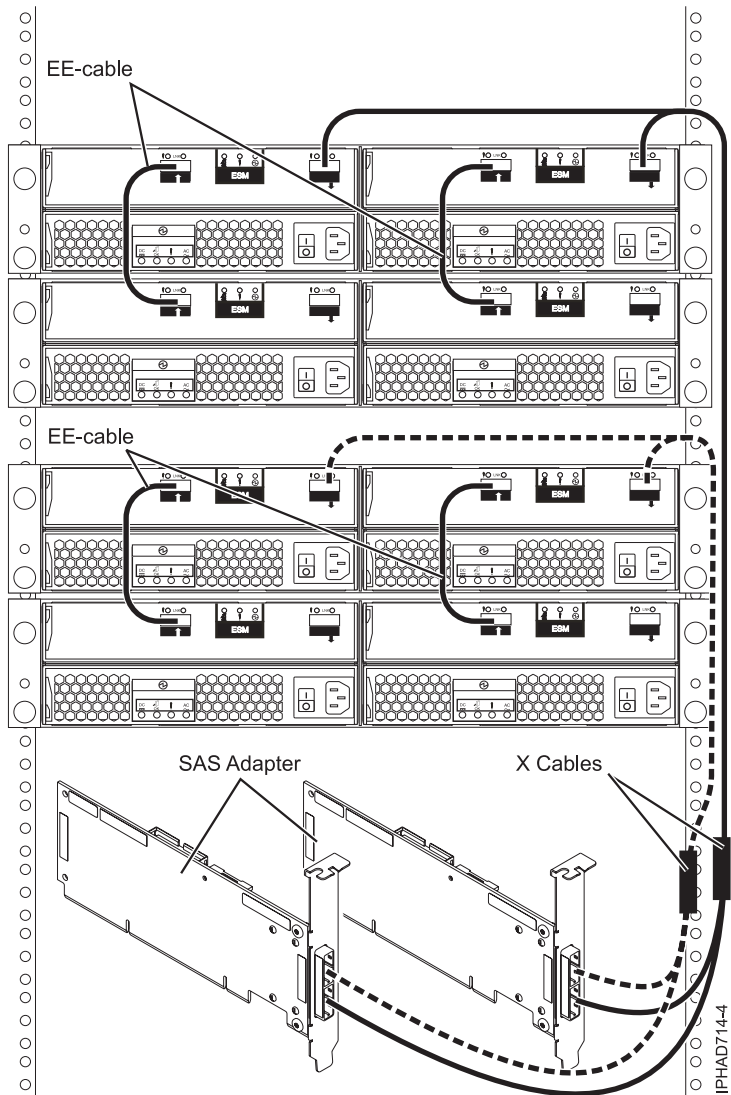
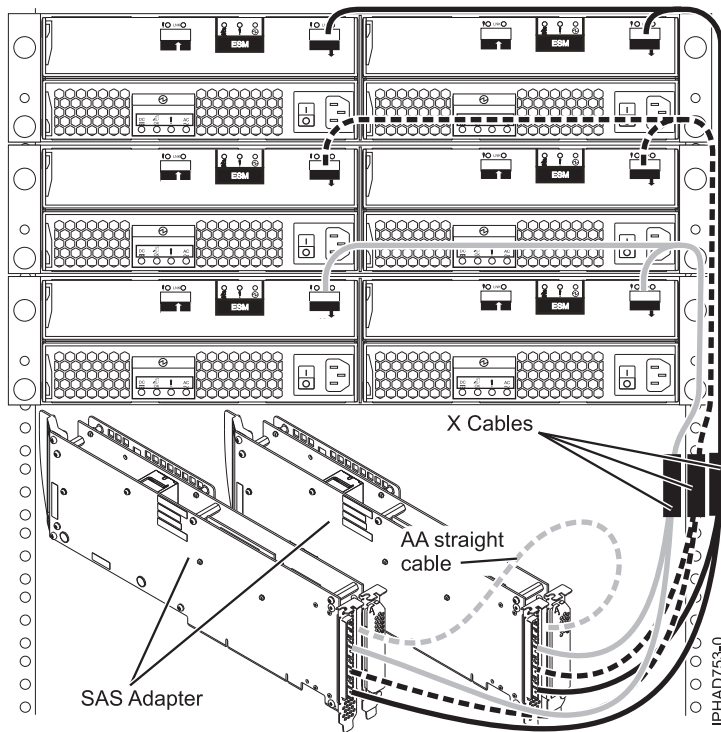

Figure 152. Two SAS RAID adapters to four disk expansion drawers in a multi-initiator HA RAID configuration

**Notes:**

- The X cable must be routed along the right side of the rack frame.
- The X cable must be attached to the same numbered port on all adapters.



When attaching only hard disk drives, it is also possible to cascade a second disk expansion drawer off of two out of the three drawers for a maximum of five disk expansion drawers per adapter. See Figure 143 on page 158.

**Notes:**

- Disk expansion drawers can be cascaded only one level deep.
- The X cable must be routed along the right side of the rack frame.
- The X cable must be attached to the same numbered port on all adapters.
- Any multi-initiator configuration with FC 5904, FC 5906, and FC 5908 adapters require an AA cable for connecting the two adapters with each other.

*Figure 153. Two PCI-X DDR 1.5 GB cache SAS RAID adapters to disk expansion drawers in a multi-initiator HA raid configuration*

**Two RAID SAS adapters with HD connectors to disk expansion drawer in a multi-initiator high availability (HA) mode**

Figure 154 on page 169, Figure 155 on page 170, and Figure 156 on page 171 illustrate connecting two SAS RAID adapters with HD connectors to one, two, or three disk expansion drawers in a multi-initiator HA mode.

Figure 157 on page 172 illustrates connecting two pair of SAS RAID adapters with HD connectors to one disk expansion drawer in a multi-initiator HA mode.

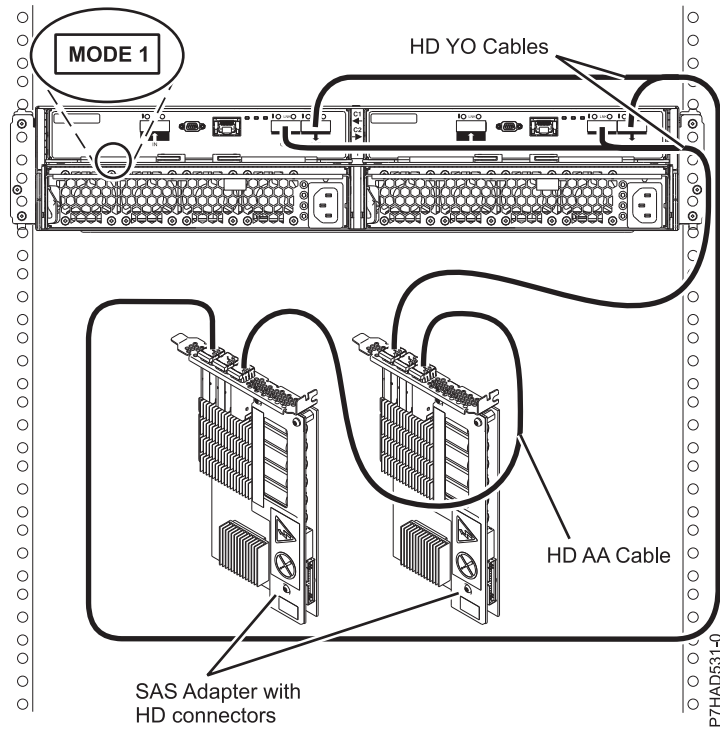

**Notes:**

- No cascading allowed for the 5887 storage drawer.
- HD AA cable is required.

*Figure 154. Two RAID SAS adapters with HD connectors to a disk expansion drawer in a multi-initiator HA mode*

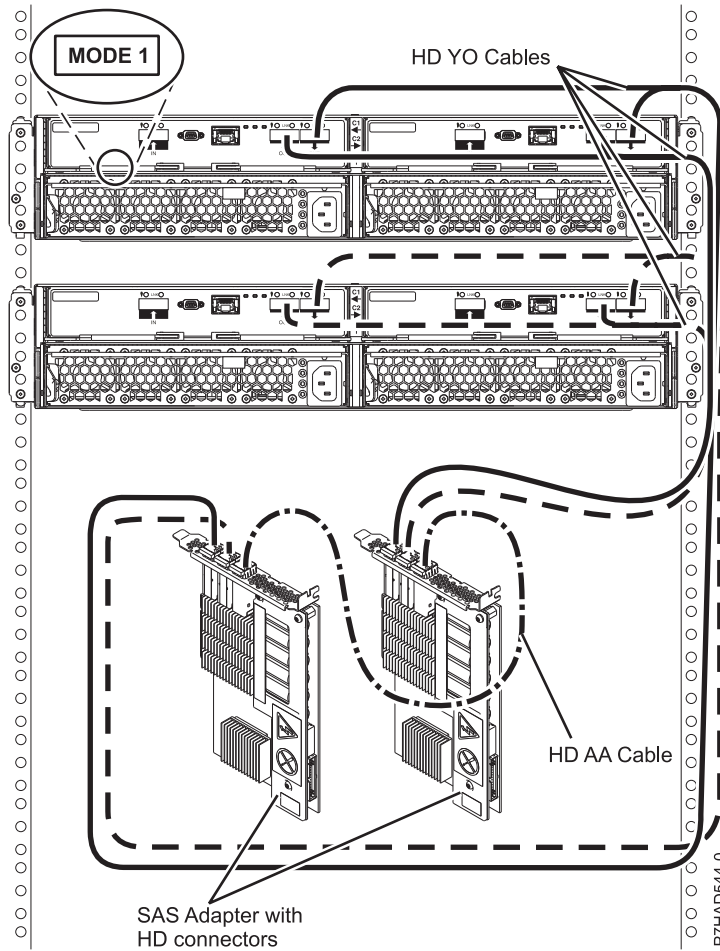

**Notes:**

- No cascading allowed for the 5887 storage drawer.
- HD AA cable is required.

*Figure 155. Two RAID SAS adapters with HD connectors to two disk expansion drawer in a multi-initiator HA mode*



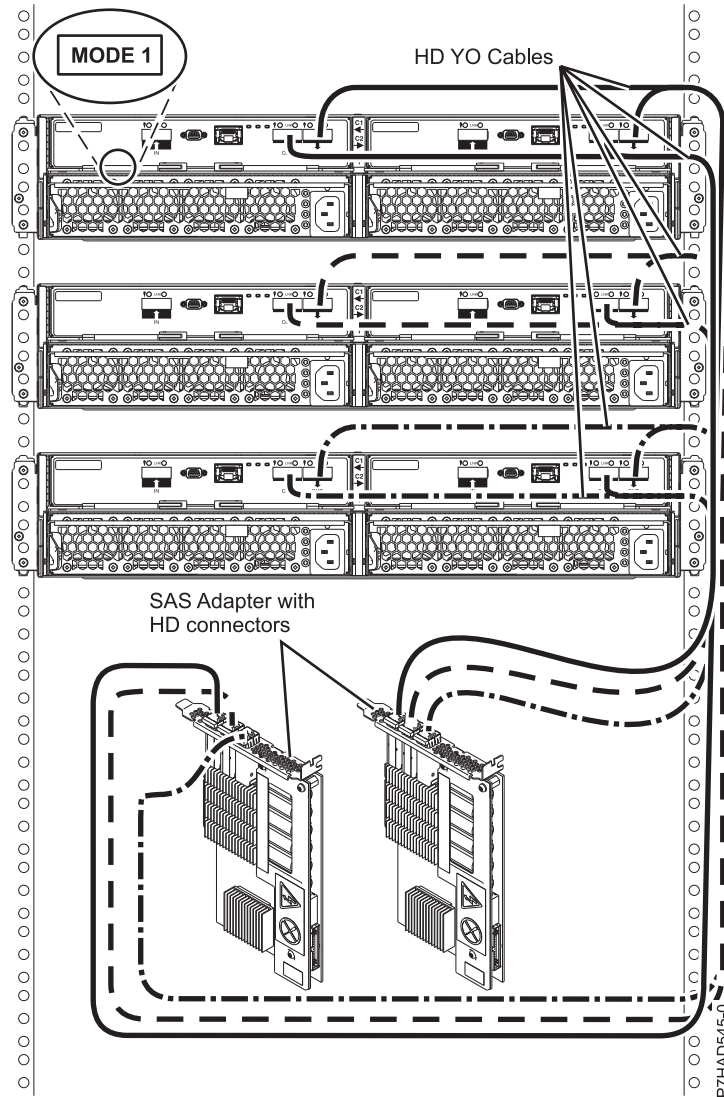

**Note:**

- No cascading allowed for the 5887 storage drawer.

Figure 156. Two RAID SAS adapters with HD connectors to three disk expansion drawers in a multi-initiator HA mode

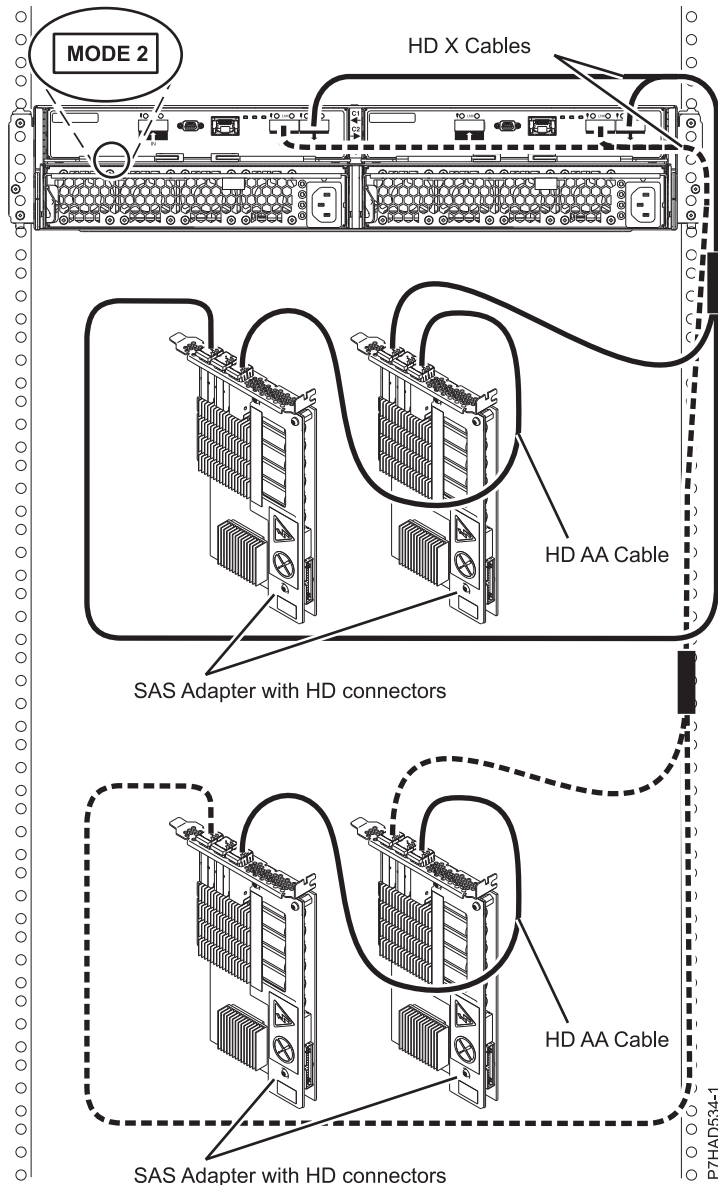

**Notes:**

- No cascading allowed for the 5887 storage drawer.
- HD AA cable is required.

Figure 157. Two pairs of RAID SAS adapters with HD connectors to a disk expansion drawer – Mode 2 in a multi-initiator HA mode

**Two SAS adapters to disk expansion drawer - multi-initiator HA JBOD configuration**

Figure 158 on page 173 illustrates connecting two SAS adapters to a disk expansion drawer in a unique JBOD configuration.

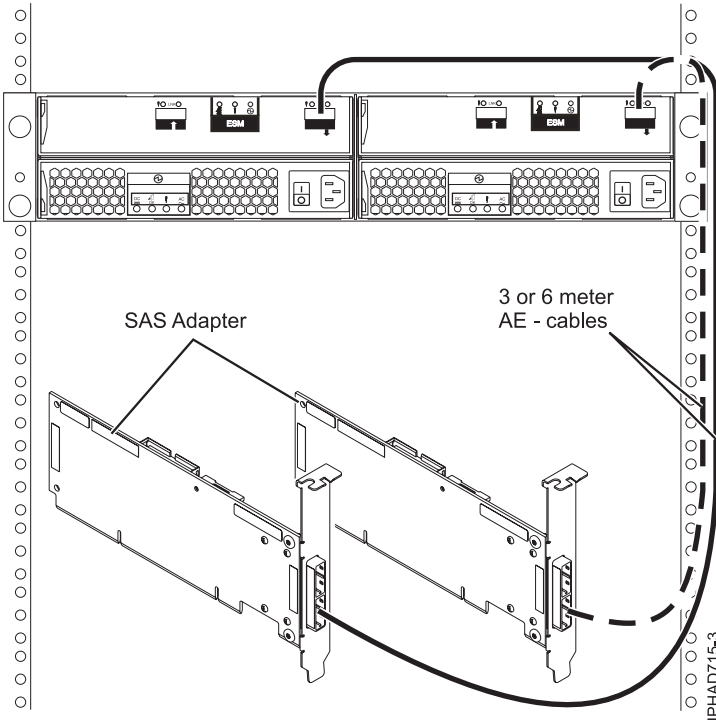

Figure 158. Two RAID SAS adapters to a disk expansion drawer in a multi-initiator HA JBOD configuration

**Note:** This configuration is only supported by the AIX and Linux operating systems with specific SAS adapters and requires special user configuration setup. See SAS RAID controllers for AIX or SAS RAID controllers for Linux for additional information.

### PCIe SAS adapter in PCIe 12x I/O drawer to the internal SAS disk slots

There are several possible configurations for attaching PCIe SAS adapters to the internal SAS disk slots in the PCIe 12X I/O drawer, and multiple ways of setting up the disk layout within the drawer. The disk unit partitions switch setting on the rear of the PCIe 12X I/O drawer controls the grouping of the disk units within the drawer. This will also affect the way the adapter or adapters are cabled to specific ports on the PCIe 12X I/O drawer. The desired switch position should be selected before attaching the AT cables. If the disk unit partitions switch is changed, the PCIe 12X I/O drawer must be powered off and on for the new position to be detected.

All internal disk units are attached using AT cables. There are also options where other external expansion drawers might be connected to these same SAS adapters. External disk expansion drawers are attached using YO cables for single adapter configurations or X cables for two adapter configurations. External media expansion drawers are attached using AE cables for single adapter configurations. External media expansion drawers are not supported for two adapter configurations.

For complete details and examples of these configurations within the PCIe 12X I/O drawer, see Configuring the 5802 disk-drive subsystem. Figure 159 on page 174 illustrates the rear view of a typical connection from two PCIe SAS adapters to the PCIe 12X I/O drawer. Use the AT cable to attach from an adapter port to a SAS port on the PCIe 12X I/O drawer.

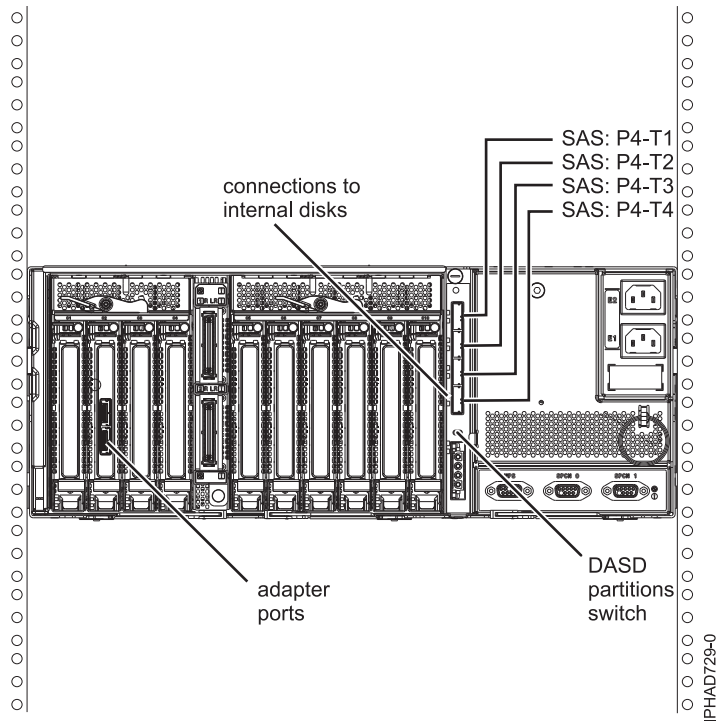

Figure 159. Two RAID SAS adapters to a disk expansion drawer in a multi-initiator HA JBOD configuration

## Internal disk drive sharing

The following information is for use after the FC 5901 SAS Storage adapter is installed. Install the adapter and then return here. For more information on the PCI adapters topic, see PCI adapters for the 8233-E8B or 8236-E8C.

Please review the tasks in the Before you begin section before proceeding with the below procedure.

This feature allows you to split the internal disks in the system unit enclosure into groups which you can manage separately.

1. Stop and power off the system. For more information, see Stopping a system or logical partition.
2. Cable a single system unit enclosure by doing the following:
  - a. Attach the cable to the SAS port on the rear bulkhead of the system unit enclosure to the top port in the SAS Storage Controller as shown in the following figure.

**Restriction:** Internal disk drive sharing is only available when internal cable feature FC 1815 is installed from the DASD backplane to the read bulkhead of the system unit enclosure. Also FC 5662 175 MB cache RAID - dual IOA enablement card must not be installed. The SAS Storage Controller may be in any of the other slots that support it.

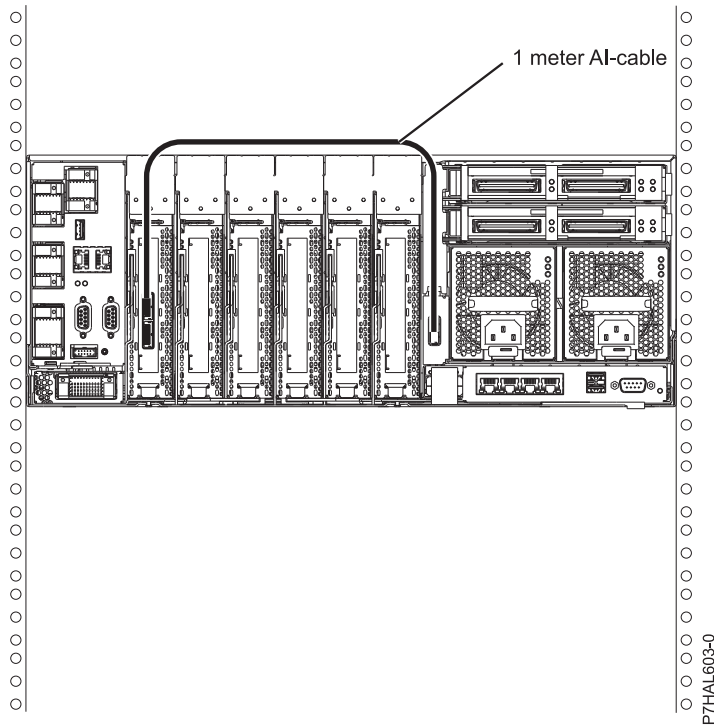

- b. Secure any extra cable.
3. Start the system. For more information, see *Starting the system* or *logical partition*.
4. Verify that the feature is installed and is working. For more information, see *Verifying the installed part*.

With this function installed, two of the six disks (D3 and D6) in the system enclosure will be managed by the SAS storage controller adapter.

**Note:** The removable media device is always controlled by the separate embedded SAS controller on the system planar. For more information on installing and removing SAS media devices, see *Removing and replacing media devices*.

**Related information:**

 [Connecting the SAS adapter to the 5887 disk drive enclosure](#)

---

## SAS cabling for the 5887 drawer

Learn about the different serial-attached SCSI (SAS) cabling configurations available for the 5887 drawer and mixed configurations of the 5886 and 5887 drawers.

- “SAS adapter (FC 5901 or FC 5278) to the 5887” on page 176
- “SAS adapter (FC 5805 and FC 5903) to the 5887” on page 180
- “SAS adapter (FC 5904, FC 5906, and FC 5908) to the 5887” on page 182
- “SAS adapter (FC 5913) to the 5887” on page 185
- “SAS adapters with high density (HD) connectors” on page 186
- FC EDR1 PCIe storage enclosure to the 5887

## SAS adapter (FC 5901 or FC 5278) to the 5887

There are seven supported configurations to connect the FC 5901 or FC 5278 adapters to a 5887.

### Notes:

1. No solid-state drives (SSDs) supported with the FC 5901 or FC 5278 adapters.
2. No cascading of 5887 drawers.
3. No mixed configurations of 5886 and 5887 drawers supported.
4. No support for IBM i.
5. The long end (0.5 m) of the YO cable must be connected to the left side of the drawer (as viewed from the rear). The short end (0.25 m) of the YO cable must be connected to the right side of the drawer (as viewed from the rear).

The following list describes the supported configurations for connecting the FC 5901 or FC 5278 adapter to a 5887:

1. Single FC 5901 or FC 5278 adapter to one 5887 drawer via a mode 1 connection.
  - 5887 drawer with one set of 24 hard disk drives (HDDs).
  - Connection using SAS YO cables to connect to the 5887 drawer.
  - Supported only on AIX and Linux systems.

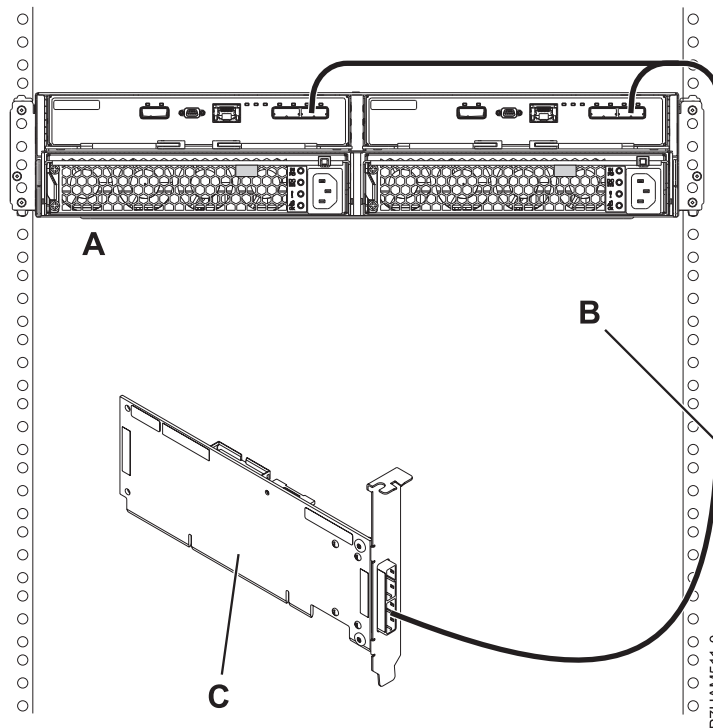

Figure 160. Mode 1 connection of a 5887 drawer by using a YO cable to a single SAS adapter

2. Single FC 5901 or FC 5278 adapter to two 5887 drawers via a mode 1 connection.
  - 5887 drawers with two sets of 24 hard disk drives (HDDs).
  - Connection using SAS YO cables to connect to the 5887 drawers.
  - Supported only on AIX and Linux systems.
3. Dual FC 5901 or FC 5278 adapters to one 5887 drawer via a mode 1 connection.
  - 5887 drawer with one set of 24 hard disk drives (HDDs).

- Connection using dual SAS YO cables to connect to the 5887 drawer.
- Supported only on AIX and Linux systems.

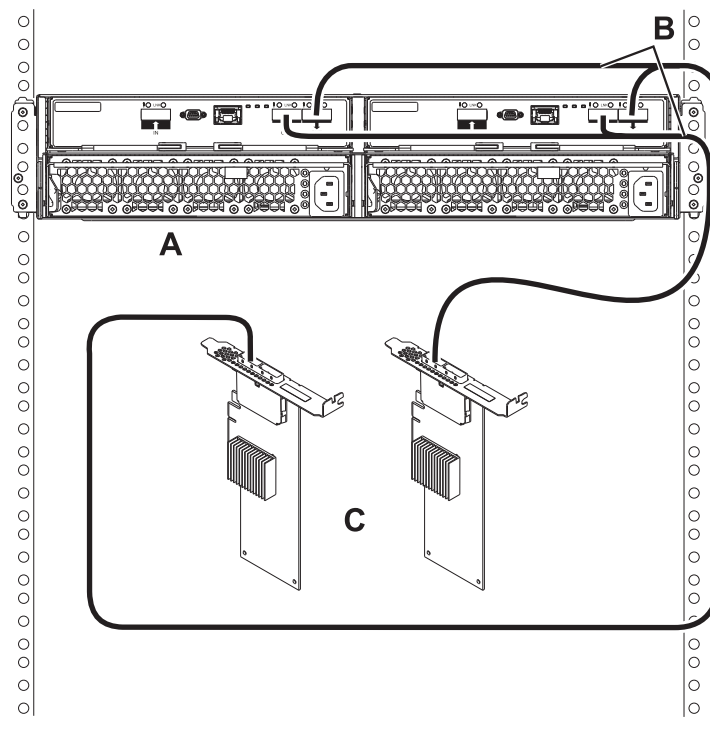

Figure 161. Mode 1 connection of a 5887 drawer by using YO cables to dual SAS adapters

4. Dual FC 5901 or FC 5278 adapters to two 5887 drawers via a mode 1 connection.
  - 5887 drawers with two sets of 24 hard disk drives (HDDs).
  - Connection using dual SAS YO cables to connect to the 5887 drawer.
  - Supported only on AIX and Linux systems.
5. Two single FC 5901 or FC 5278 adapters to one 5887 drawer via a mode 2 connection.
  - 5887 drawer with two sets of 12 hard disk drives (HDDs).
  - Connection using two SAS YO cables to connect to the 5887 drawer.
  - Each pair of FC 5901 adapters controls half of the 5887 drawer.
  - Supported only on AIX and Linux systems.

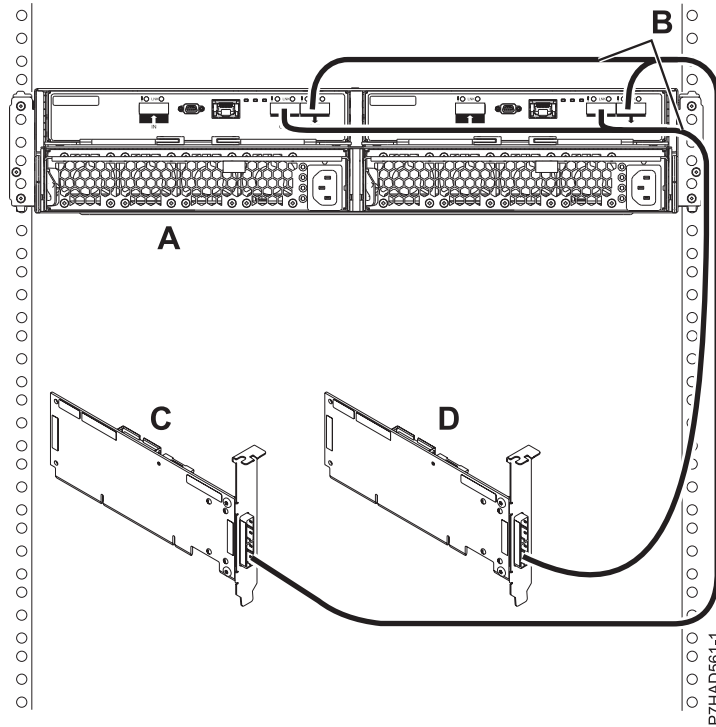

Figure 162. Mode 2 connection of a 5887 drawer by using YO cables to two single SAS adapters

6. Two pairs of dual FC 5901 or FC 5278 adapters to one 5887 drawer via a mode 2 connection.
  - 5887 drawer with two sets of 12 hard disk drives (HDDs).
  - Connection using dual SAS X cables to connect to the 5887 drawer.
  - Each pair of FC 5901 adapters controls half of the 5887 drawer.
  - Supported only on AIX and Linux systems.



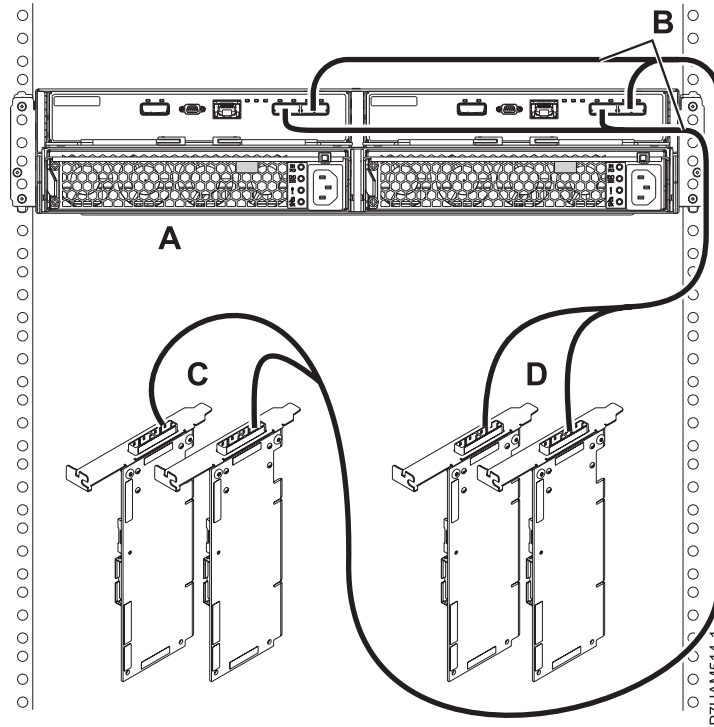

Figure 163. Mode 2 connection of a 5887 drawer by using X cables to two pairs of SAS adapters

7. Four single FC 5901 or FC 5278 adapters to one 5887 drawer via a mode 4 connection.
  - 5887 drawer with four sets of six hard disk drives (HDDs).
  - Connection using dual SAS X cables to connect to the 5887 drawer.
  - Supported only on AIX and Linux systems.

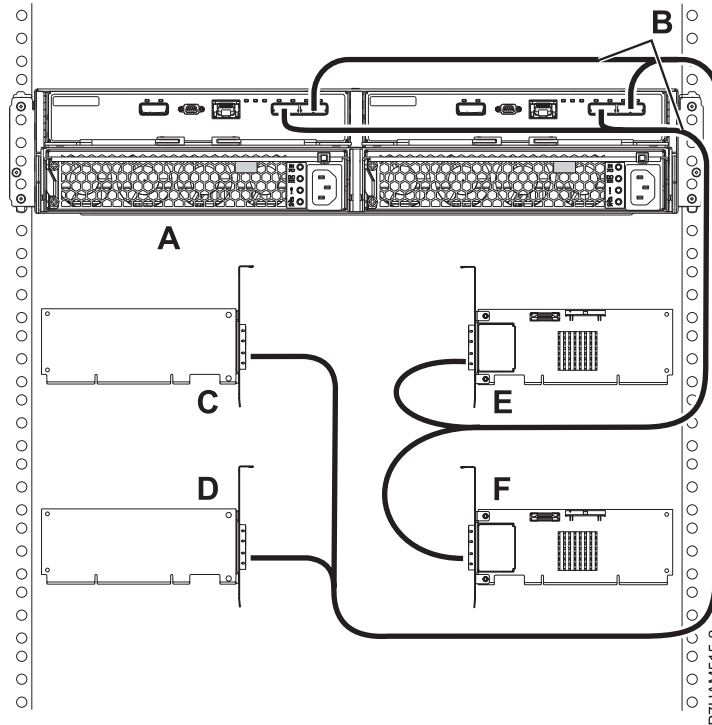

Figure 164. Mode 4 connection of a 5887 drawer by using X cables to four single SAS adapters

**Note:** You must match the drive slots that you are using to the connector on the 5887 drawer, and then to the correct leg of the X cable. For details, see Connecting the SAS adapter to the 5887 disk drive enclosure.

### SAS adapter (FC 5805 and FC 5903) to the 5887

There are three supported configurations to connect the FC 5805 or FC 5903 adapters to a 5887 and one supported mixed configuration to a 5886 and 5887.

#### Notes:

1. Maximum of eight SSDs in single drawer configurations.
2. No cascading of 5887 drawers.
3. No cascading of 5886 drawers in mixed configurations.
4. IBM i only supports mode 1 connections.
5. The long end (0.5 m) of the YO cable must be connected to the left side of the drawer (as viewed from the rear). The short end (0.25 m) of the YO cable must be connected to the right side of the drawer (as viewed from the rear).

The following list describes the supported configurations:

1. Dual FC 5805 or FC 5903 adapters to one 5887 drawer via a mode 1 connection.
  - 5887 drawer with 1 - 24 HDDs or 1 - 8 SSDs.
  - Connection using dual SAS YO cables to connect to the 5887 drawer.

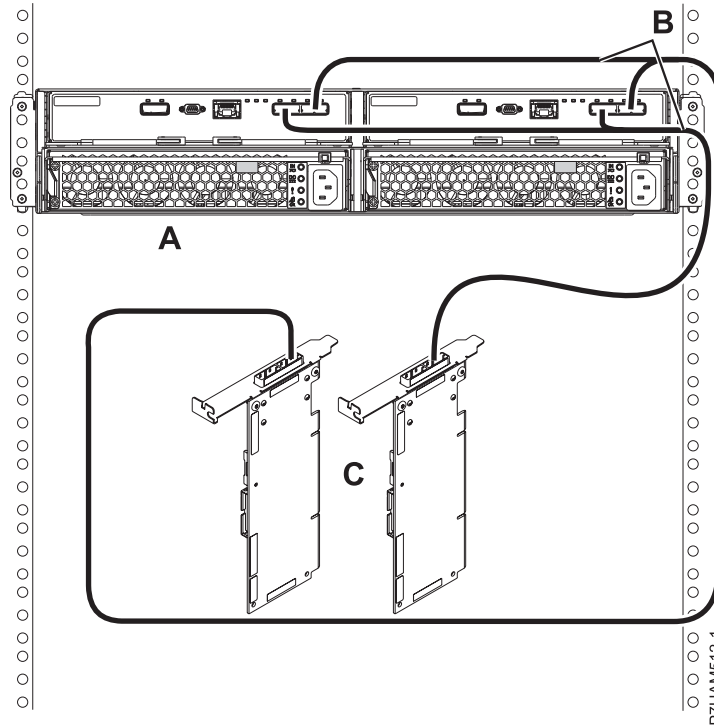

Figure 165. Mode 1 connection of a 5887 drawer by using YO cables to dual SAS adapters

2. Dual FC 5805 or FC 5903 adapters to two 5887 drawers via a mode 1 connection.
  - 5887 drawers with HDDs only.
  - Connection using dual SAS YO cables to connect to the 5887 drawers.
3. Dual FC 5805 or FC 5903 adapters to one 5886 drawer and one 5887 drawer via a mode 1 connection.
  - 5886 and 5887 drawer with HDDs only.
  - Connection using one SAS X cable to connect to the 5886 drawer and two SAS YO cables to the 5887 drawers.
4. Two pairs of FC 5805 or FC 5903 adapters to one 5887 drawer via a mode 2 connection.
  - 5887 drawer with 1 - 12 HDDs or 1 - 8 SSDs.
  - Connection using dual SAS X cables to connect to the 5887 drawer.
  - Supported only on AIX and Linux systems. No support for IBM i.

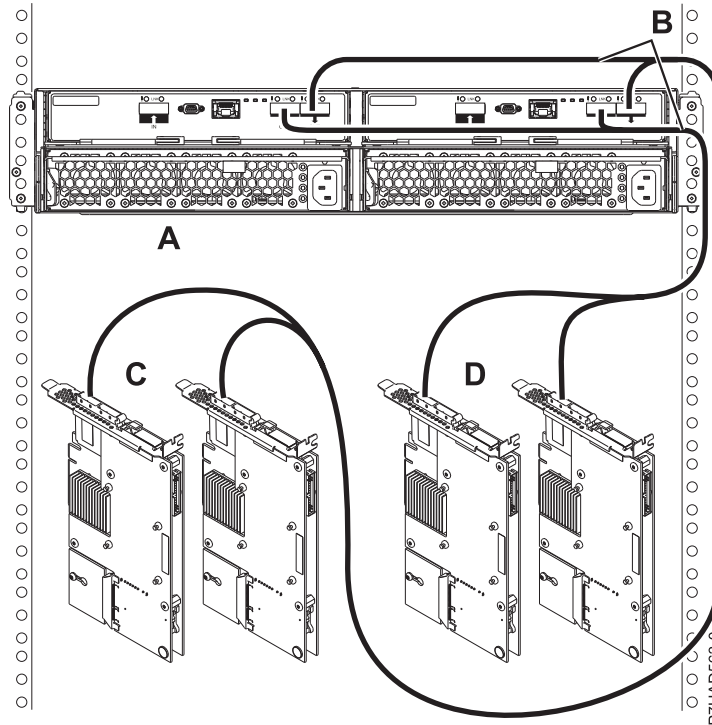

Figure 166. Two pairs of FC 5805 or FC 5903 adapters to one 5887 drawer via a mode 2 connection

### SAS adapter (FC 5904, FC 5906, and FC 5908) to the 5887

There are four supported configurations to connect FC 5904, FC 5906, or FC 5908 adapters to a 5887 and six supported mixed configurations to a 5886 and 5887.

#### Notes:

1. Mode 1 connections only.
2. Maximum of two 5887 drawers on an FC 5904, FC 5906, or FC 5908 adapter or a pair of FC 5904, FC 5906, or FC 5908 adapters.
3. No cascading of 5887 drawers.
4. No cascading of 5886 drawers in mixed configurations.
5. Maximum of eight SSDs in single drawer configurations.
6. The long end (0.5 m) of the YO cable must be connected to the left side of the drawer (as viewed from the rear). The short end (0.25 m) of the YO cable must be connected to the right side of the drawer (as viewed from the rear).
7. Dual initiator configurations require an AA cable to connect the top port (T3) of each adapter in the pair with each other.

The following list describes the supported configurations:

1. Single FC 5904, FC 5906, or FC 5908 adapter to one 5887 drawer via a mode 1 connection.
  - 5887 drawers with 1 - 24 HDDs or 1 - 8 SSDs.
  - Connection using dual SAS YO cables to connect to the 5887 drawer.

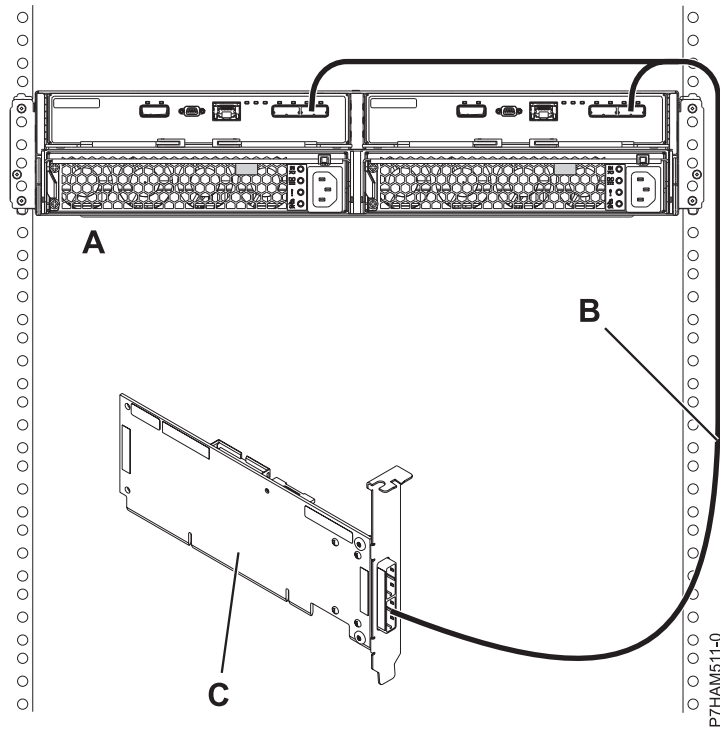

Figure 167. Mode 1 connection of a 5887 drawer by using a YO cable to a single SAS adapter

2. Single FC 5904, FC 5906, or FC 5908 adapter to two 5887 drawers via a mode 1 connection.
  - 5887 drawers with HDDs only.
  - Connection using SAS YO cables to connect to the 5887 drawers.
3. Dual FC 5904, FC 5906, or FC 5908 adapters to one 5887 drawer via a mode 1 connection.
  - 5887 drawers with 1 - 24 HDDs or 1 - 8 SSDs.
  - Connection using dual SAS YO cables to connect to the 5887 drawer.
  - SAS AA cable is required to connect the top port (T3) of each adapter in the pair with each other.

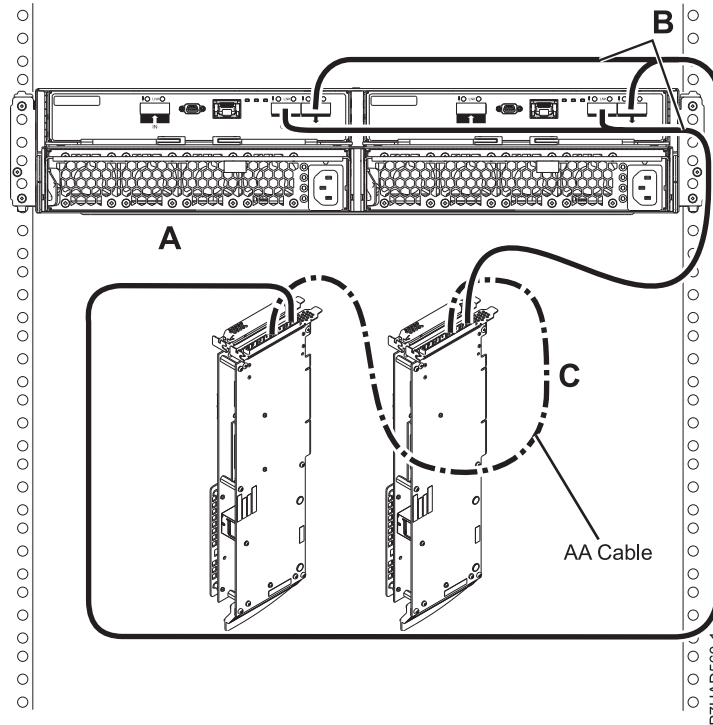

Figure 168. Mode 1 connection of a 5887 drawer by using YO cables to dual SAS adapters

4. Dual FC 5904, FC 5906, or FC 5908 adapters to two 5887 drawers via a mode 1 connection.
  - 5887 drawers with HDDs only.
  - Connection using SAS YO cables to connect to the 5887 drawers.
  - SAS AA cable is required to connect the top port (T3) of each adapter in the pair with each other.
5. Single FC 5904, FC 5906, or FC 5908 adapter to one 5886 drawer and one 5887 drawer via a mode 1 connection.
  - 5886 and 5887 drawers with HDDs only.
  - Connection using SAS YO cables to connect to both the 5886 drawer and the 5887 drawer.
6. Single FC 5904, FC 5906, or FC 5908 adapter to one 5886 drawer and two 5887 drawers via a mode 1 connection.
  - 5886 and 5887 drawers with HDDs only.
  - Connection using SAS YO cables to connect to both the 5886 drawer and the 5887 drawers.
7. Single FC 5904, FC 5906, or FC 5908 adapter to two 5886 drawers and one 5887 drawer via a mode 1 connection.
  - 5886 and 5887 drawers with HDDs only.
  - Connection using SAS YO cables to connect to both the 5886 drawers and the 5887 drawer.
8. Dual FC 5904, FC 5906, or FC 5908 adapters to one 5886 drawer and one 5887 drawer via a mode 1 connection.
  - 5886 and 5887 drawers with HDDs only.
  - Connection using SAS X cables to connect to the 5886 drawer and SAS YO cables to the 5887 drawer.
  - SAS AA cable is required to connect the top port (T3) of each adapter in the pair with each other.
9. Dual FC 5904, FC 5906, or FC 5908 adapters to one 5886 drawer and two 5887 drawers via a mode 1 connection.
  - 5886 and 5887 drawers with HDDs only.

- Connection using SAS X cables to connect to the 5886 drawer and SAS YO cables to the 5887 drawers.
  - SAS AA cable is required to connect the top port (T3) of each adapter in the pair with each other.
10. Dual FC 5904, FC 5906, or FC 5908 adapters to two 5886 drawers and one 5887 drawer via a mode 1 connection.
- 5886 and 5887 drawers with HDDs only.
  - Connection using SAS X cables to connect to the 5886 drawers and SAS YO cables to the 5887 drawer.
  - SAS AA cable is required to connect the top port (T3) of each adapter in the pair with each other.

## **SAS adapter (FC 5913) to the 5887**

There are four supported configurations to connect the FC 5913 adapter to a 5887 and three supported mixed configurations to a 5886 and 5887.

### **Notes:**

1. Maximum of 24 SSDs for a pair of FC 5913s.
2. Allowed to have 24 SSDs in a single drawer or split between two drawers.
3. No cascading of 5887 drawers.
4. No cascading of 5886 drawers in mixed configurations.
5. In mode 2, the 5887 appears as two logical drawers.
6. The long end (0.5 m) of the YO cable must be connected to the left side of the drawer (as viewed from the rear). The short end (0.25 m) of the YO cable must be connected to the right side of the drawer (as viewed from the rear).
7. Dual initiator configurations require an AA cable to connect the top port (T3) of each adapter in the pair with each other, except for configurations with three 5887 drawers.

The following list describes the supported configurations:

1. Dual FC 5913 adapters to one 5887 drawer via a mode 1 connection.
  - 5887 drawers with 1 - 24 HDDs or SSDs.
  - Connection using SAS 6x YO cables to connect to the 5887 drawer (both cables must be attached to the same port on each adapter).
  - SAS 6x AA cable is required for connecting the pair of FC 5913 adapters.
2. Dual FC 5913 adapters to two 5887 drawers via a mode 1 connection.
  - 5887 drawers with either a maximum of 48 HDDs or 24 SSDs only (cannot have a mix of HDDs and SSDs in the same drawer).
  - Connection using SAS 6x YO cables to connect to the 5887 drawers.
  - SAS 6x AA cable is required for connecting the pair of FC 5913 adapters.
3. Dual FC 5913 adapters to three 5887 drawers via a mode 1 connection.
  - 5887 drawers with either a maximum of 72 HDDs or 24 SSDs only (cannot have a mix of HDDs and SSDs in the same drawer).
  - Connection using SAS 6x YO cables to connect to the 5887 drawers.
4. Two pairs of FC 5913 adapters to one 5887 drawer via a split connection.
  - 1 - 12 SSDs or 1 - 12 HDDs per FC 5913 pair.
  - Connection using SAS 6x X cables to connect to the 5887 drawer (both cables must be attached to the same port on each adapter).
  - SAS 6x AA cable is required for connecting each pair of FC 5913 adapters.
  - Supported only on AIX and Linux systems.
  - No IBM i support.

- POWER7 only support.
5. Dual FC 5913 adapters to one 5886 drawer and one 5887 drawer via a mode 1 connection.
    - 5886 drawer with 1 - 8 SSDs or 1 - 12 HDDs.
    - 5887 drawer with 1 - 24 SSDs or HDDs.
    - Maximum of 24 SSDs.
    - Connection using SAS 6x X cables to connect to the 5886 drawer.
    - Connection using SAS 6x YO cables to connect to the 5887 drawer.
    - SAS 6x AA cable is required for connecting the pair of FC 5913 adapters.
  6. Dual FC 5913 adapters to one 5886 drawer and two 5887 drawers via a mode 1 connection.
    - 5886 drawer with 1 - 8 SSDs or 1 - 12 HDDs.
    - 5887 drawers with 1 - 24 SSDs or HDDs.
    - Maximum of 24 SSDs.
    - Connection using SAS 6x X cables to connect to the 5886 drawer.
    - Connection using SAS 6x YO cables to connect to the 5887 drawers.
  7. Dual FC 5913 adapters to two 5886 drawers and one 5887 drawer via a mode 1 connection.
    - 5886 drawers with 1 - 8 SSDs or 1 - 12 HDDs.
    - 5887 drawer with 1 - 24 SSDs or HDDs.
    - Maximum of 24 SSDs.
    - Connection using SAS 6x X cables to connect to the 5886 drawers.
    - Connection using SAS 6x YO cables to connect to the 5887 drawer.

### **SAS adapters with high density (HD) connectors**

Learn about the various configurations available using HD connectors.

1. Two SAS adapters with HD connectors to one 5887 drawer via a mode 1 connection.
  - No cascading allowed.
  - HD AA cable is required.



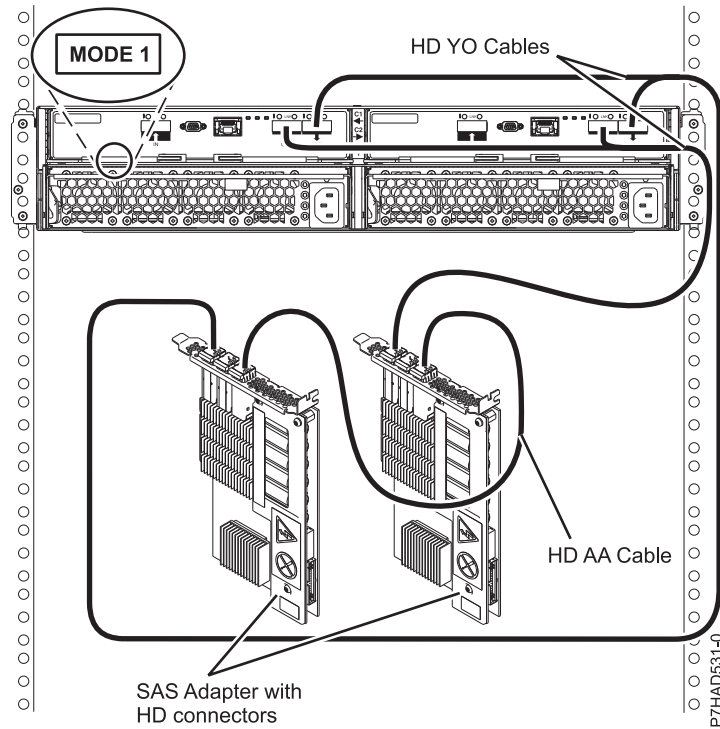

Figure 169. Mode 1 connection of a 5887 drawer to two SAS adapters with HD connectors

2. Two SAS adapters with HD connectors to two 5887 drawers via a mode 1 connection.
  - No cascading allowed.
  - HD AA cable is required.

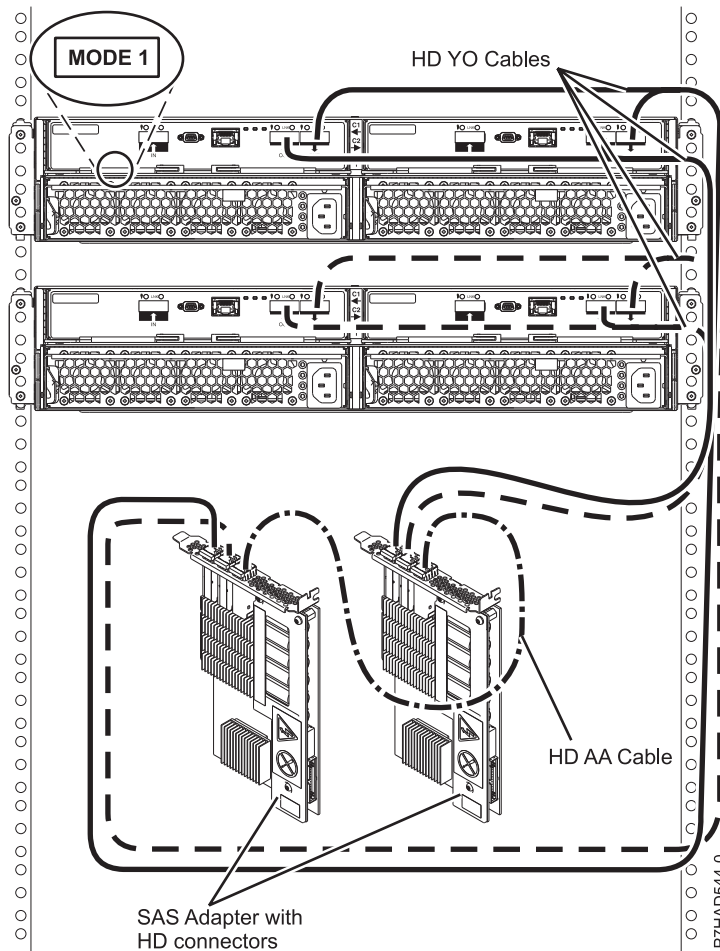

Figure 170. Mode 1 connection of two 5887 drawers by using HD connectors to two SAS adapters

3. Two SAS adapters with HD connectors to three 5887 drawers via a mode 1 connection.
  - No cascading allowed.

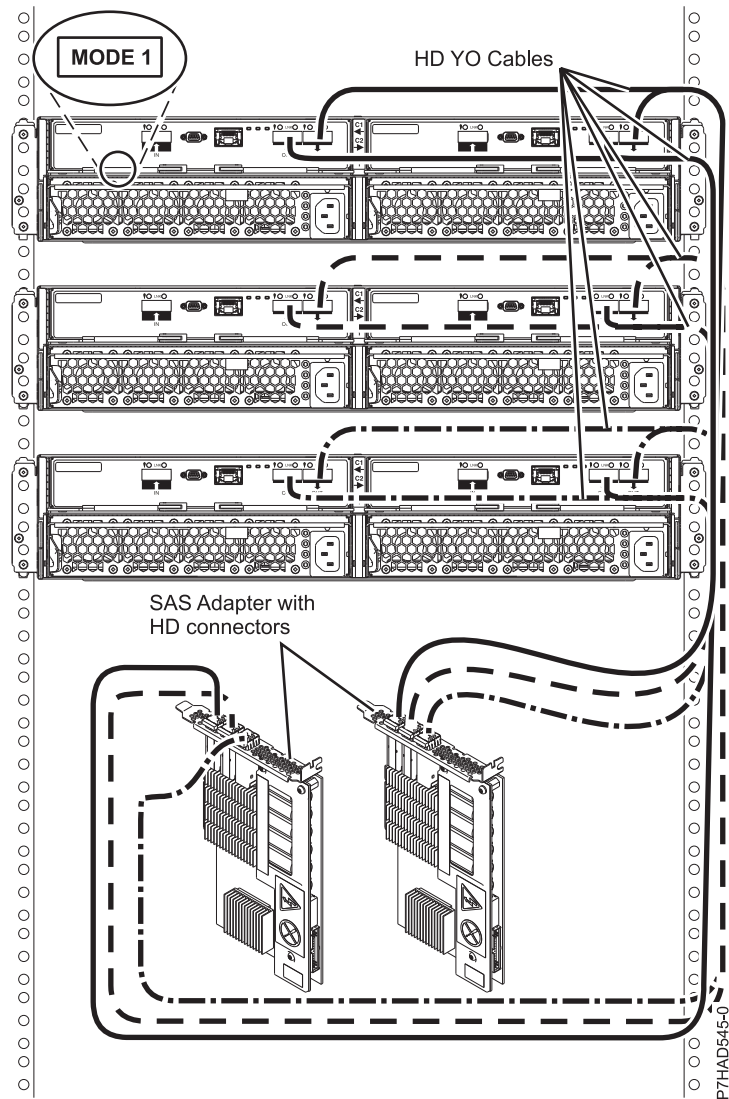

Figure 171. Mode 1 connection of three 5887 drawers to two SAS adapters with HD connectors

4. Two pairs of SAS adapters with HD connectors to one 5887 drawer via a mode 2 connection.
  - FC EJOL
  - No cascading allowed
  - 2 HD AA and 2 HD X cables are required

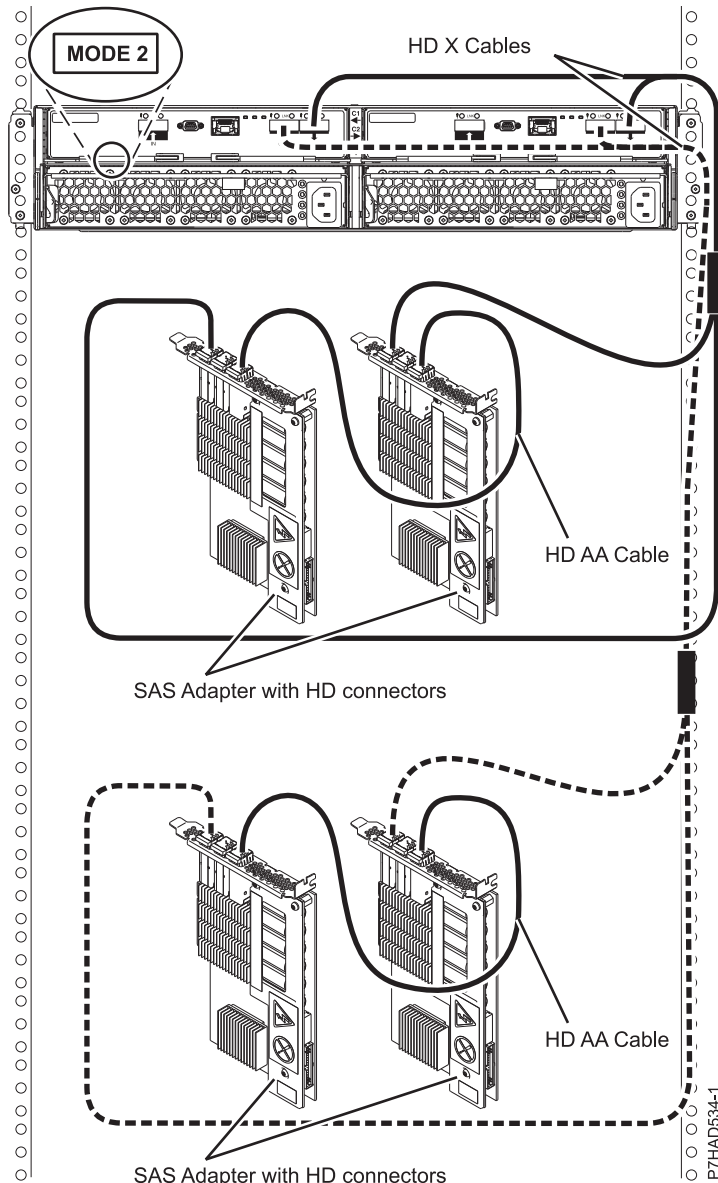

Figure 172. Mode 2 connection of a 5887 drawer by using HD connectors to two pairs of SAS adapters

### PCIe storage enclosure (FC EDR1) to the 5887

The following list describes the supported configurations to connect the EDR1 to the 5887.

1. One EDR1 to one 5887 drawer.
  - Both HD EX cables from the 5887 must be attached to the same numbered port on each EDR1.

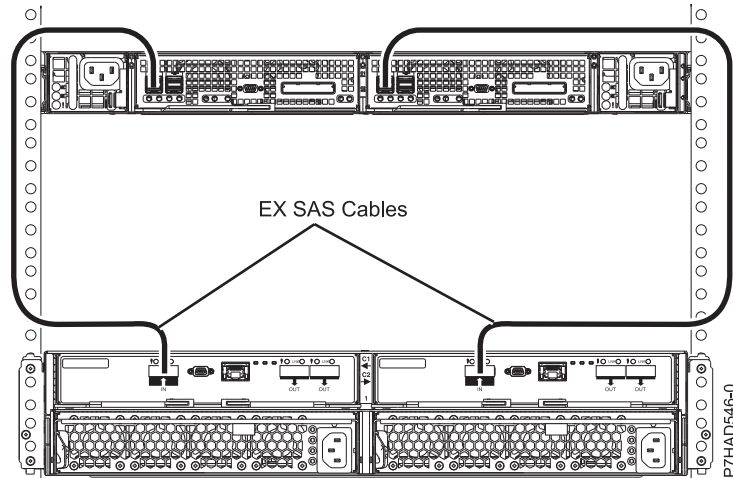

Figure 173. Connection of one 5887 drawer by using HD EX cables to one EDR1

2. One EDR1 to two 5887 drawers.

- Both HD EX cables from the same 5887 must be attached to the same numbered port on each EDR1.

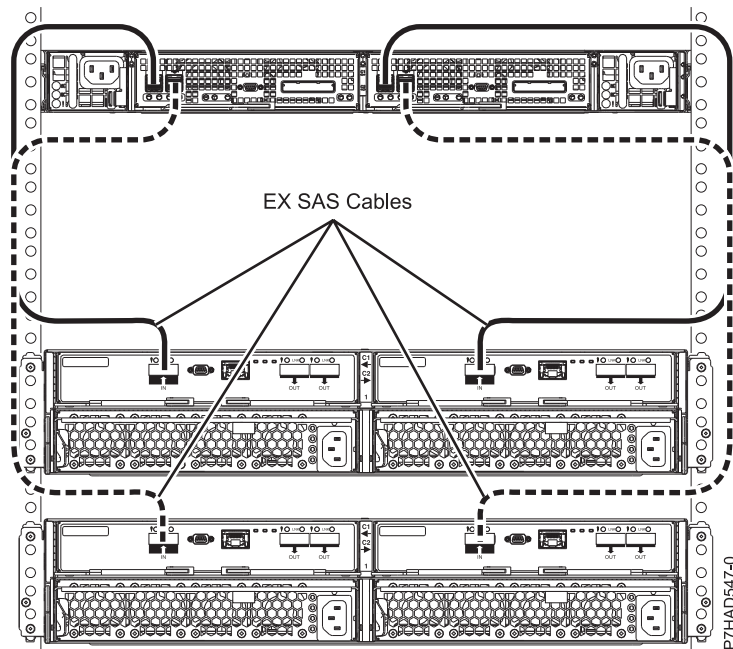

Figure 174. Connection of two 5887 drawers by using HD EX cables to one EDR1



---

## Rack installation specifications for racks not purchased from IBM

Learn the requirements and specifications for installing IBM systems into racks that were not purchased from IBM.

This topic provides requirements and specifications for 19-inch racks. These requirements and specifications are provided as an aid to help you understand the requirements to install IBM systems into racks. It is your responsibility, working with your rack manufacturer, to ensure that the rack chosen meets the requirements and specifications listed here. Mechanical drawings of the rack, if available from the manufacturer, are recommended for comparison against the requirements and specifications.

IBM maintenance services and installation planning services do not cover verification of non-IBM racks for compliance to Power Systems rack specifications. IBM offers racks for IBM products that are tested and verified by IBM development labs to comply with applicable safety and regulatory requirements. These racks are also tested and verified to fit and function well with IBM products. The customer is responsible for verifying with their rack manufacturer that any non-IBM racks comply with IBM specifications.

**Note:** The IBM 7014-T00, 7014-T42, 7014-B42, 0551, and 0553 racks meet all the requirements and specifications.

### Rack specifications

The general rack specifications are:

- The rack or cabinet must meet the EIA Standard EIA-310-D for 19-inch racks published August 24, 1992. The EIA-310-D standard specifies internal dimensions, for example, the width of the rack opening (width of the chassis), the width of the module mounting flanges, the mounting hole spacing, and the depth of the mounting flanges. The EIA-310-D standard does not control the overall external width of the rack. There are no restrictions on the location of side walls and corner posts relative to the internal mounting space.
- The front rack opening must be 451 mm wide + 0.75 mm (17.75 in. + 0.03 in.), and the rail-mounting holes must be 465 mm + 0.8 mm (18.3 in. + 0.03 in.) apart on center (horizontal width between vertical columns of holes on the two front-mounting flanges and on the two rear-mounting flanges).

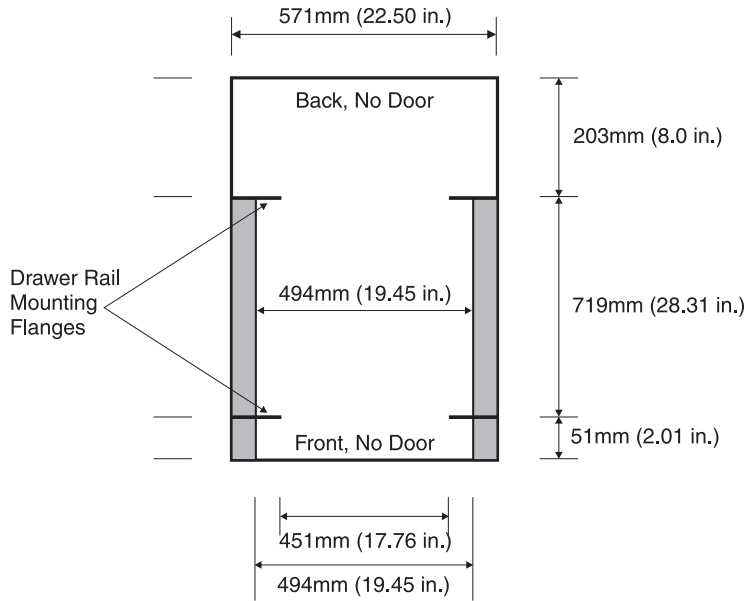

The vertical distance between mounting holes must consist of sets of three holes spaced (from bottom to top) 15.9 mm (0.625 in.), 15.9 mm (0.625 in.), and 12.67 mm (0.5 in.) on center (making each three hole set of vertical hole spacing 44.45 mm (1.75 in.) apart on center). The front and rear mounting flanges in the rack or cabinet must be 719 mm (28.3 in.) apart and the internal width bounded by the mounting flanges at least 494 mm (19.45 in.), for the IBM rails to fit in your rack or cabinet (see the following figure).

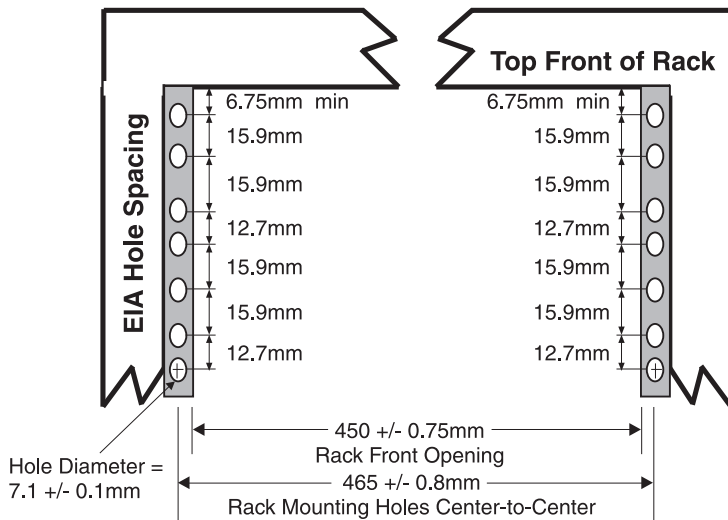



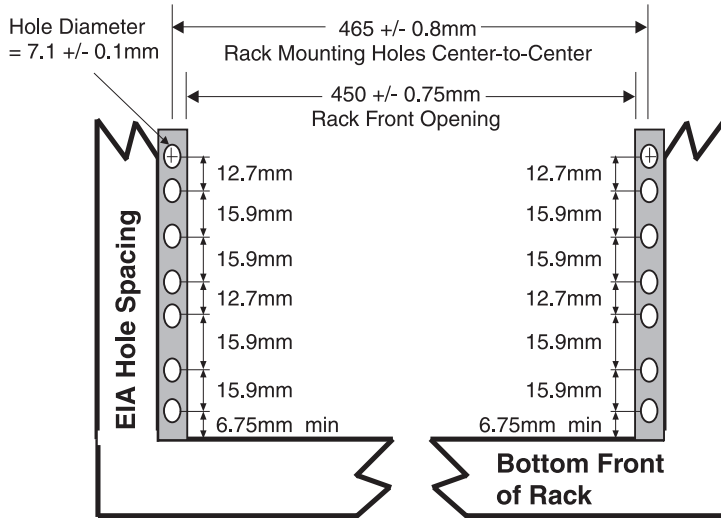

Models 9117-MMB, 9117-MMC, 9117-MMD, 9179-MHB, 9179-MHC, and 9179-MHD use SMP and FSP flex assemblies that extend beyond the rack mount post width.

The front rack opening must be 535 mm (21.06 in.) wide for dimension C (the width between the outsides of the standard mounting flanges, see Figure 30 on page 76). The back rack opening must be 500 mm (19.69 in.) wide for dimension C (the width between the outsides of the standard mounting flanges).

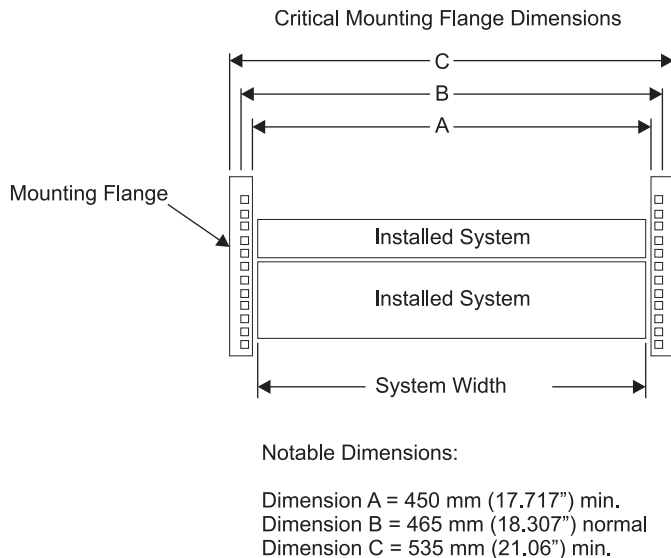
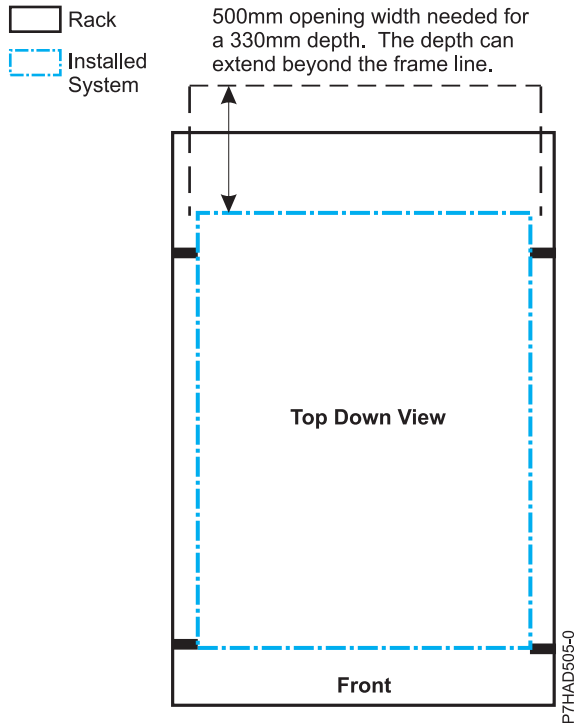

Figure 175. Critical mounting flange dimensions

- A minimum rack opening width of 500 mm (19.69 in.) for a depth of 330 mm (12.99 in.) is needed behind the installed system for maintenance and service. The depth can extend beyond the rack rear door.



- The rack or cabinet must be capable of supporting an average load of 15.9 kg (35 lb) of product weight per EIA unit.  
 For example, a four EIA drawer has a maximum drawer weight of 63.6 kg (140 lb).  
 The following rack hole sizes are supported for racks where IBM hardware is mounted:
    - 7.1 mm plus or minus 0.1 mm
    - 9.2 mm plus or minus 0.1 mm
    - 12 mm plus or minus 0.1 mm
  - All parts shipped with the Power Systems products must be installed.
  - Only ac power drawers are supported in the rack or cabinet. It is strongly recommended to use a power distribution unit that meets the same specifications as IBM power distribution units to supply rack power (for example, feature code 7188). Rack or cabinet power distribution devices must meet the drawer voltage, amperage, and power requirements, as well as that of any additional products that will be connected to the same power distribution device.  
 The rack or cabinet power receptacle (power distribution unit, uninterruptible power supply, or multi-outlet strip) must have a compatible plug type for your drawer or device.
  - The rack or cabinet must be compatible with the drawer-mounting rails. The rail-mounting pins and screws should fit securely and snugly into the rack or cabinet rail-mounting holes. It is strongly recommended that the IBM mounting rails and mounting hardware that are included with the product be used to install it in the rack. The mounting rails and mounting hardware that are provided with IBM products have been designed and tested to safely support the product during operation and service activities as well as to safely support the weight of your drawer or device. The rails must facilitate service access by allowing the drawer to be safely extended, if necessary, forward, backward, or both. Some rails, with IBM features for non-IBM racks, provide drawer specific anti-tip brackets, rear lock-down brackets, and cable management guides that require clearance on the rear side of the rails.
- Note:** If the rack or cabinet has square holes on the mounting flanges, a plug-in hole adapter might be required.

If non-IBM rails are used, the rails must be product-safety certified for use with the IBM products. At a minimum, mounting rails must be able to support four times the maximum rated product weight in its worst-case position (fully-extended front and rear positions) for one full minute without catastrophic failure.

- The rack or cabinet must have stabilization feet or brackets installed both in the front and rear of the rack, or have another means of preventing the rack/cabinet from tipping while the drawer or device is pulled into its extreme front or rear service positions.

**Note:** Examples of some acceptable alternatives: The rack or cabinet might be securely bolted to the floor, ceiling or walls, or to adjacent racks or cabinets in a long and heavy row of racks or cabinets.

- There must be adequate front and rear service clearances (in and around the rack or cabinet). The rack or cabinet must have sufficient horizontal width clearance in the front and rear to allow the drawer to be fully slid into the front and, if applicable, the rear service access positions (typically this requires 914.4 mm (36 in.) clearance in both the front and rear).
- If present, front and rear doors must be able to open far enough to provide unrestrained access for service or be easily removable. If doors must be removed for service, it is the customer's responsibility to remove them prior to service.
- The rack or cabinet must provide adequate clearance around the rack drawer.
- There must be adequate clearance around the drawer bezel so that it can be opened and closed, according to the product specifications.
- Front or rear doors must also maintain a minimum of 51 mm (2 in.) front, 203 mm (8 in.) rear, door to mounting flange clearance, and 494 mm (19.4 in.) front, 571 mm (22.5 in.) rear, side-to-side clearance for drawer bezels and cables.
- The rack or cabinet must provide adequate front-to-back ventilation.

**Note:** For optimum ventilation, it is recommended the rack or cabinet not have a front door. If the rack or cabinet has doors, the doors must be fully perforated so that there is proper front-to-back airflow to maintain the required drawer ambient inlet temperature as specified in the server specifications. The perforations should yield at least 34 % minimum open area per square inch.

## **General safety requirements for IBM products installed in a non-IBM rack or cabinet**

The general safety requirements for IBM products installed in non-IBM racks are:

- Any product or component that plugs into either an IBM power distribution unit or mains power (via a power cord), or uses any voltage over 42 V ac or 60 V dc (considered to be hazardous voltage) must be Safety Certified by a Nationally Recognized Test Laboratory (NRTL) for the country in which it will be installed.

Some of the items that require safety certification might include: the rack or cabinet (if it contains electrical components integral to the rack or cabinet), fan trays, power distribution unit, uninterruptible power supplies, multi-outlet strips, or any other products installed in the rack or cabinet that connect to hazardous voltage.

Examples of OSHA-approved NRTLs for the U.S.:

- UL
- ETL
- CSA (with CSA NRTL or CSA US mark)

Examples of approved NRTLs for Canada:

- UL (ULc mark)
- ETL (ETLc mark)
- CSA

The European Union requires a CE mark and a Manufacturer's Declaration of Conformity (DOC).

Certified products should have the NRTL logos or marks somewhere on the product or product label. However, proof of certification must be made available to IBM upon request. Proof consists of such items as copies of the NRTL license or certificate, a CB Certificate, a Letter of Authorization to apply the NRTL mark, the first few pages of the NRTL certification report, Listing in an NRTL publication, or a copy of the UL Yellow Card. Proof should contain the manufacturer's name, product type and model, standard to which it was certified, the NRTL name or logo, the NRTL file number or license number, and a list of any Conditions of Acceptance or Deviations. A Manufacturer's Declaration is not proof of certification by an NRTL.

- The rack or cabinet must meet all electrical and mechanical safety legal requirements for the country in which it is installed. The rack or cabinet must be free of exposed hazards (such as voltages over 60 V dc or 42 V ac, energy over 240 VA, sharp edges, mechanical pinch points, or hot surfaces).
- There must be an accessible and unambiguous disconnect device for each product in the rack, including any power distribution unit.

A disconnect device might consist of either the plug on the power cord (if the power cord is no longer than 1.8 m (6 ft)), the appliance inlet receptacle (if the power cord is of a detachable type), or a power on/off switch, or an Emergency Power Off switch on the rack, provided all power is removed from the rack or product by the disconnect device.

If the rack or cabinet has electrical components (such as fan trays or lights), the rack must have an accessible and unambiguous disconnect device.

- The rack or cabinet, power distribution unit and multi-outlet strips, and products installed in the rack or cabinet must all be properly grounded to the customer facility ground.

There must be no more than 0.1 Ohms between the ground pin of the power distribution unit or rack plug and any touchable metal or conductive surface on the rack and on the products installed in the rack. Grounding method must comply with applicable country's electric code (such as NEC or CEC). Ground continuity can be verified by your IBM service personnel, after the installation is completed, and should be verified prior to the first service activity.

- The voltage rating of the power distribution unit and multi-outlet strips must be compatible with the products plugged into them.

The power distribution unit or multi-outlet strips current and power ratings are rated at 80% of the building supply circuit (as required by the National Electrical Code and the Canadian Electrical Code). The total load connected to the power distribution unit must be less than the rating of the power distribution unit. For example, a power distribution unit with a 30 A connection will be rated for a total load of 24 A (30 A x 80 %). Therefore, the sum of all equipment connected to the power distribution unit in this example must be lower than the 24 A rating.

If an uninterruptible power supply is installed, it must meet all the electrical safety requirements as described for a power distribution unit (including certification by an NRTL).

- The rack or cabinet, power distribution unit, uninterruptible power supply, multi-outlet strips and all products in the rack or cabinet must be installed according to the manufacturer's instructions, and in accordance with all national, state or province, and local codes and laws.

The rack or cabinet, power distribution unit, uninterruptible power supply, multi-outlet strips and all products in the rack or cabinet must be used as intended by the manufacturer (per manufacturer's product documentation and marketing literature).

- All documentation for use and installation of the rack or cabinet, power distribution unit, uninterruptible power supply, and all products in the rack or cabinet, including safety information, must be available on-site.
- If there is more than one source of power in the rack cabinet, there must be clearly visible safety labels for Multiple Power Source (in the languages required for the country in which the product is installed).
- If the rack or cabinet or any products installed in the cabinet had safety or weight labels applied by the manufacturer, they must be intact and translated into the languages required for the country in which the product is installed.

- If the rack or cabinet has doors, the rack becomes a fire enclosure by definition and must meet the applicable flammability ratings (V-0 or better). Totally metal enclosures at least 1 mm (0.04 in.) thick are considered to comply.

Nonenclosure (decorative) materials must have a flammability rating of V-1 or better. If glass is used (such as in rack doors) it must be safety glass. If wood shelves are used in the rack/cabinet, they must be treated with a UL Listed flame-retardant coating.

- The rack or cabinet configuration must comply with all IBM requirements for "safe to service" (contact your IBM Installation Planning Representative for assistance in determining if the environment is safe). There must be no unique maintenance procedures or tools required for service.

Elevated service installations, where the products to be serviced are installed between 1.5 m and 3.7 m (5 ft and 12 ft) above the floor, require the availability of an OSHA- and CSA-approved nonconductive step ladder. If a ladder is required for service, the customer must supply the OSHA- and CSA-approved nonconductive step ladder (unless other arrangements have been made with the local IBM Service Branch Office). Products installed over 2.9 m (9 ft) above the floor require a Special Bid to be completed before they can be serviced by IBM service personnel.

For products not intended for rack-mounting to be serviced by IBM, the products and parts that will be replaced as part of that service must not weigh over 11.4 kg (25 lb) Contact your Installation Planning Representative if in doubt.

There must not be any special education or training required for safe servicing of any of the products installed in the racks. Contact your Installation Planning Representative if you are in doubt.

**Related reference:**

"Rack specifications" on page 33

Rack specifications provide detailed information for your rack, including dimensions, electrical, power, temperature, environment, and service clearances.



---

## Notices

This information was developed for products and services offered in the U.S.A.

The manufacturer may not offer the products, services, or features discussed in this document in other countries. Consult the manufacturer's representative for information on the products and services currently available in your area. Any reference to the manufacturer's product, program, or service is not intended to state or imply that only that product, program, or service may be used. Any functionally equivalent product, program, or service that does not infringe any intellectual property right of the manufacturer may be used instead. However, it is the user's responsibility to evaluate and verify the operation of any product, program, or service.

The manufacturer may have patents or pending patent applications covering subject matter described in this document. The furnishing of this document does not grant you any license to these patents. You can send license inquiries, in writing, to the manufacturer.

**The following paragraph does not apply to the United Kingdom or any other country where such provisions are inconsistent with local law:** THIS PUBLICATION IS PROVIDED "AS IS" WITHOUT WARRANTY OF ANY KIND, EITHER EXPRESS OR IMPLIED, INCLUDING, BUT NOT LIMITED TO, THE IMPLIED WARRANTIES OF NON-INFRINGEMENT, MERCHANTABILITY OR FITNESS FOR A PARTICULAR PURPOSE. Some states do not allow disclaimer of express or implied warranties in certain transactions, therefore, this statement may not apply to you.

This information could include technical inaccuracies or typographical errors. Changes are periodically made to the information herein; these changes will be incorporated in new editions of the publication. The manufacturer may make improvements and/or changes in the product(s) and/or the program(s) described in this publication at any time without notice.

Any references in this information to websites not owned by the manufacturer are provided for convenience only and do not in any manner serve as an endorsement of those websites. The materials at those websites are not part of the materials for this product and use of those websites is at your own risk.

The manufacturer may use or distribute any of the information you supply in any way it believes appropriate without incurring any obligation to you.

Any performance data contained herein was determined in a controlled environment. Therefore, the results obtained in other operating environments may vary significantly. Some measurements may have been made on development-level systems and there is no guarantee that these measurements will be the same on generally available systems. Furthermore, some measurements may have been estimated through extrapolation. Actual results may vary. Users of this document should verify the applicable data for their specific environment.

Information concerning products not produced by this manufacturer was obtained from the suppliers of those products, their published announcements or other publicly available sources. This manufacturer has not tested those products and cannot confirm the accuracy of performance, compatibility or any other claims related to products not produced by this manufacturer. Questions on the capabilities of products not produced by this manufacturer should be addressed to the suppliers of those products.

All statements regarding the manufacturer's future direction or intent are subject to change or withdrawal without notice, and represent goals and objectives only.

The manufacturer's prices shown are the manufacturer's suggested retail prices, are current and are subject to change without notice. Dealer prices may vary.

This information is for planning purposes only. The information herein is subject to change before the products described become available.

This information contains examples of data and reports used in daily business operations. To illustrate them as completely as possible, the examples include the names of individuals, companies, brands, and products. All of these names are fictitious and any similarity to the names and addresses used by an actual business enterprise is entirely coincidental.

If you are viewing this information in softcopy, the photographs and color illustrations may not appear.

The drawings and specifications contained herein shall not be reproduced in whole or in part without the written permission of the manufacturer.

The manufacturer has prepared this information for use with the specific machines indicated. The manufacturer makes no representations that it is suitable for any other purpose.

The manufacturer's computer systems contain mechanisms designed to reduce the possibility of undetected data corruption or loss. This risk, however, cannot be eliminated. Users who experience unplanned outages, system failures, power fluctuations or outages, or component failures must verify the accuracy of operations performed and data saved or transmitted by the system at or near the time of the outage or failure. In addition, users must establish procedures to ensure that there is independent data verification before relying on such data in sensitive or critical operations. Users should periodically check the manufacturer's support websites for updated information and fixes applicable to the system and related software.

## **Homologation statement**

This product may not be certified in your country for connection by any means whatsoever to interfaces of public telecommunications networks. Further certification may be required by law prior to making any such connection. Contact an IBM representative or reseller for any questions.

---

## **Trademarks**

IBM, the IBM logo, and [ibm.com](http://ibm.com) are trademarks or registered trademarks of International Business Machines Corp., registered in many jurisdictions worldwide. Other product and service names might be trademarks of IBM or other companies. A current list of IBM trademarks is available on the web at [www.ibm.com/legal/copytrade.shtml](http://www.ibm.com/legal/copytrade.shtml).

INFINIBAND, InfiniBand Trade Association, and the INFINIBAND design marks are trademarks and/or service marks of the INFINIBAND Trade Association.

Linux is a registered trademark of Linus Torvalds in the United States, other countries, or both.

---

## **Electronic emission notices**

When attaching a monitor to the equipment, you must use the designated monitor cable and any interference suppression devices supplied with the monitor.

## **Class A Notices**

The following Class A statements apply to the IBM servers that contain the POWER7 processor and its features unless designated as electromagnetic compatibility (EMC) Class B in the feature information.



## **Federal Communications Commission (FCC) statement**

**Note:** This equipment has been tested and found to comply with the limits for a Class A digital device, pursuant to Part 15 of the FCC Rules. These limits are designed to provide reasonable protection against harmful interference when the equipment is operated in a commercial environment. This equipment generates, uses, and can radiate radio frequency energy and, if not installed and used in accordance with the instruction manual, may cause harmful interference to radio communications. Operation of this equipment in a residential area is likely to cause harmful interference, in which case the user will be required to correct the interference at his own expense.

Properly shielded and grounded cables and connectors must be used in order to meet FCC emission limits. IBM is not responsible for any radio or television interference caused by using other than recommended cables and connectors or by unauthorized changes or modifications to this equipment. Unauthorized changes or modifications could void the user's authority to operate the equipment.

This device complies with Part 15 of the FCC rules. Operation is subject to the following two conditions: (1) this device may not cause harmful interference, and (2) this device must accept any interference received, including interference that may cause undesired operation.

## **Industry Canada Compliance Statement**

This Class A digital apparatus complies with Canadian ICES-003.

## **Avis de conformité à la réglementation d'Industrie Canada**

Cet appareil numérique de la classe A est conforme à la norme NMB-003 du Canada.

## **European Community Compliance Statement**

This product is in conformity with the protection requirements of EU Council Directive 2004/108/EC on the approximation of the laws of the Member States relating to electromagnetic compatibility. IBM cannot accept responsibility for any failure to satisfy the protection requirements resulting from a non-recommended modification of the product, including the fitting of non-IBM option cards.

This product has been tested and found to comply with the limits for Class A Information Technology Equipment according to European Standard EN 55022. The limits for Class A equipment were derived for commercial and industrial environments to provide reasonable protection against interference with licensed communication equipment.

European Community contact:  
IBM Deutschland GmbH  
Technical Regulations, Department M372  
IBM-Allee 1, 71139 Ehningen, Germany  
Tele: +49 7032 15 2941  
email: [lugi@de.ibm.com](mailto:lugi@de.ibm.com)

**Warning:** This is a Class A product. In a domestic environment, this product may cause radio interference, in which case the user may be required to take adequate measures.

## VCCI Statement - Japan

この装置は、クラスA 情報技術装置です。この装置を家庭環境で使用すると電波妨害を引き起こすことがあります。この場合には使用者が適切な対策を講ずるよう要求されることがあります。

VCCI-A

The following is a summary of the VCCI Japanese statement in the box above:

This is a Class A product based on the standard of the VCCI Council. If this equipment is used in a domestic environment, radio interference may occur, in which case, the user may be required to take corrective actions.

### Japanese Electronics and Information Technology Industries Association (JEITA) Confirmed Harmonics Guideline (products less than or equal to 20 A per phase)

高調波ガイドライン適合品

### Japanese Electronics and Information Technology Industries Association (JEITA) Confirmed Harmonics Guideline with Modifications (products greater than 20 A per phase)

高調波ガイドライン準用品

## Electromagnetic Interference (EMI) Statement - People's Republic of China

### 声 明

此为 A 级产品, 在生活环境中, 该产品可能会造成无线电干扰。在这种情况下, 可能需要用户对其干扰采取切实可行的措施。

Declaration: This is a Class A product. In a domestic environment this product may cause radio interference in which case the user may need to perform practical action.

## Electromagnetic Interference (EMI) Statement - Taiwan

警告使用者：  
這是甲類的資訊產品，在居住的環境中使用時，可能會造成射頻干擾，在這種情況下，使用者會被要求採取某些適當的對策。

The following is a summary of the EMI Taiwan statement above.

Warning: This is a Class A product. In a domestic environment this product may cause radio interference in which case the user will be required to take adequate measures.

### IBM Taiwan Contact Information:

台灣IBM 產品服務聯絡方式：  
台灣國際商業機器股份有限公司  
台北市松仁路7號3樓  
電話：0800-016-888

## Electromagnetic Interference (EMI) Statement - Korea

이 기기는 업무용(A급)으로 전자파적합기기로서 판매자 또는 사용자는 이 점을 주의하시기 바라며, 가정외의 지역에서 사용하는 것을 목적으로 합니다.

## Germany Compliance Statement

### Deutschsprachiger EU Hinweis: Hinweis für Geräte der Klasse A EU-Richtlinie zur Elektromagnetischen Verträglichkeit

Dieses Produkt entspricht den Schutzanforderungen der EU-Richtlinie 2004/108/EG zur Angleichung der Rechtsvorschriften über die elektromagnetische Verträglichkeit in den EU-Mitgliedsstaaten und hält die Grenzwerte der EN 55022 Klasse A ein.

Um dieses sicherzustellen, sind die Geräte wie in den Handbüchern beschrieben zu installieren und zu betreiben. Des Weiteren dürfen auch nur von der IBM empfohlene Kabel angeschlossen werden. IBM übernimmt keine Verantwortung für die Einhaltung der Schutzanforderungen, wenn das Produkt ohne Zustimmung von IBM verändert bzw. wenn Erweiterungskomponenten von Fremdherstellern ohne Empfehlung von IBM gesteckt/eingebaut werden.

EN 55022 Klasse A Geräte müssen mit folgendem Warnhinweis versehen werden:  
"Warnung: Dieses ist eine Einrichtung der Klasse A. Diese Einrichtung kann im Wohnbereich Funk-Störungen verursachen; in diesem Fall kann vom Betreiber verlangt werden, angemessene Maßnahmen zu ergreifen und dafür aufzukommen."

#### **Deutschland: Einhaltung des Gesetzes über die elektromagnetische Verträglichkeit von Geräten**

Dieses Produkt entspricht dem "Gesetz über die elektromagnetische Verträglichkeit von Geräten (EMVG)". Dies ist die Umsetzung der EU-Richtlinie 2004/108/EG in der Bundesrepublik Deutschland.

#### **Zulassungsbescheinigung laut dem Deutschen Gesetz über die elektromagnetische Verträglichkeit von Geräten (EMVG) (bzw. der EMC EG Richtlinie 2004/108/EG) für Geräte der Klasse A**

Dieses Gerät ist berechtigt, in Übereinstimmung mit dem Deutschen EMVG das EG-Konformitätszeichen - CE - zu führen.

Verantwortlich für die Einhaltung der EMV Vorschriften ist der Hersteller:  
International Business Machines Corp.  
New Orchard Road  
Armonk, New York 10504  
Tel: 914-499-1900

Der verantwortliche Ansprechpartner des Herstellers in der EU ist:  
IBM Deutschland GmbH  
Technical Regulations, Abteilung M372  
IBM-Allee 1, 71139 Ehningen, Germany  
Tel: +49 7032 15 2941  
email: lugi@de.ibm.com

Generelle Informationen:

**Das Gerät erfüllt die Schutzanforderungen nach EN 55024 und EN 55022 Klasse A.**

#### **Electromagnetic Interference (EMI) Statement - Russia**

**ВНИМАНИЕ!** Настоящее изделие относится к классу А.  
В жилых помещениях оно может создавать радиопомехи, для снижения которых необходимы дополнительные меры

#### **Class B Notices**

The following Class B statements apply to features designated as electromagnetic compatibility (EMC) Class B in the feature installation information.

#### **Federal Communications Commission (FCC) statement**

This equipment has been tested and found to comply with the limits for a Class B digital device, pursuant to Part 15 of the FCC Rules. These limits are designed to provide reasonable protection against harmful interference in a residential installation.

This equipment generates, uses, and can radiate radio frequency energy and, if not installed and used in accordance with the instructions, may cause harmful interference to radio communications. However, there is no guarantee that interference will not occur in a particular installation.

If this equipment does cause harmful interference to radio or television reception, which can be determined by turning the equipment off and on, the user is encouraged to try to correct the interference by one or more of the following measures:

- Reorient or relocate the receiving antenna.
- Increase the separation between the equipment and receiver.
- Connect the equipment into an outlet on a circuit different from that to which the receiver is connected.
- Consult an IBM-authorized dealer or service representative for help.

Properly shielded and grounded cables and connectors must be used in order to meet FCC emission limits. Proper cables and connectors are available from IBM-authorized dealers. IBM is not responsible for any radio or television interference caused by unauthorized changes or modifications to this equipment. Unauthorized changes or modifications could void the user's authority to operate this equipment.

This device complies with Part 15 of the FCC rules. Operation is subject to the following two conditions: (1) this device may not cause harmful interference, and (2) this device must accept any interference received, including interference that may cause undesired operation.

### **Industry Canada Compliance Statement**

This Class B digital apparatus complies with Canadian ICES-003.

### **Avis de conformité à la réglementation d'Industrie Canada**

Cet appareil numérique de la classe B est conforme à la norme NMB-003 du Canada.

### **European Community Compliance Statement**

This product is in conformity with the protection requirements of EU Council Directive 2004/108/EC on the approximation of the laws of the Member States relating to electromagnetic compatibility. IBM cannot accept responsibility for any failure to satisfy the protection requirements resulting from a non-recommended modification of the product, including the fitting of non-IBM option cards.

This product has been tested and found to comply with the limits for Class B Information Technology Equipment according to European Standard EN 55022. The limits for Class B equipment were derived for typical residential environments to provide reasonable protection against interference with licensed communication equipment.

European Community contact:  
IBM Deutschland GmbH  
Technical Regulations, Department M372  
IBM-Allee 1, 71139 Ehningen, Germany  
Tele: +49 7032 15 2941  
email: [lugi@de.ibm.com](mailto:lugi@de.ibm.com)

## VCCI Statement - Japan

この装置は、クラスB情報技術装置です。この装置は、家庭環境で使用することを目的としていますが、この装置がラジオやテレビジョン受信機に近接して使用されると、受信障害を引き起こすことがあります。

取扱説明書に従って正しい取り扱いをして下さい。 VCCI-B

## Japanese Electronics and Information Technology Industries Association (JEITA) Confirmed Harmonics Guideline (products less than or equal to 20 A per phase)

高調波ガイドライン適合品

## Japanese Electronics and Information Technology Industries Association (JEITA) Confirmed Harmonics Guideline with Modifications (products greater than 20 A per phase)

高調波ガイドライン準用品

## IBM Taiwan Contact Information

台灣IBM 產品服務聯絡方式：  
台灣國際商業機器股份有限公司  
台北市松仁路7號3樓  
電話：0800-016-888

## Electromagnetic Interference (EMI) Statement - Korea

이 기기는 가정용(B급)으로 전자과적합기기로  
서 주로 가정에서 사용하는 것을 목적으로 하  
며, 모든 지역에서 사용할 수 있습니다.

## Germany Compliance Statement

Deutschsprachiger EU Hinweis: Hinweis für Geräte der Klasse B EU-Richtlinie zur  
Elektromagnetischen Verträglichkeit

Dieses Produkt entspricht den Schutzanforderungen der EU-Richtlinie 2004/108/EG zur Angleichung der Rechtsvorschriften über die elektromagnetische Verträglichkeit in den EU-Mitgliedsstaaten und hält die Grenzwerte der EN 55022 Klasse B ein.

Um dieses sicherzustellen, sind die Geräte wie in den Handbüchern beschrieben zu installieren und zu betreiben. Des Weiteren dürfen auch nur von der IBM empfohlene Kabel angeschlossen werden. IBM übernimmt keine Verantwortung für die Einhaltung der Schutzanforderungen, wenn das Produkt ohne Zustimmung von IBM verändert bzw. wenn Erweiterungskomponenten von Fremdherstellern ohne Empfehlung von IBM gesteckt/eingebaut werden.

#### **Deutschland: Einhaltung des Gesetzes über die elektromagnetische Verträglichkeit von Geräten**

Dieses Produkt entspricht dem "Gesetz über die elektromagnetische Verträglichkeit von Geräten (EMVG)". Dies ist die Umsetzung der EU-Richtlinie 2004/108/EG in der Bundesrepublik Deutschland.

#### **Zulassungsbescheinigung laut dem Deutschen Gesetz über die elektromagnetische Verträglichkeit von Geräten (EMVG) (bzw. der EMC EG Richtlinie 2004/108/EG) für Geräte der Klasse B**

Dieses Gerät ist berechtigt, in Übereinstimmung mit dem Deutschen EMVG das EG-Konformitätszeichen - CE - zu führen.

Verantwortlich für die Einhaltung der EMV Vorschriften ist der Hersteller:  
International Business Machines Corp.  
New Orchard Road  
Armonk, New York 10504  
Tel: 914-499-1900

Der verantwortliche Ansprechpartner des Herstellers in der EU ist:  
IBM Deutschland GmbH  
Technical Regulations, Abteilung M372  
IBM-Allee 1, 71139 Ehningen, Germany  
Tel: +49 7032 15 2941  
email: [lugi@de.ibm.com](mailto:lugi@de.ibm.com)

Generelle Informationen:

**Das Gerät erfüllt die Schutzanforderungen nach EN 55024 und EN 55022 Klasse B.**

---

## **Terms and conditions**

Permissions for the use of these publications are granted subject to the following terms and conditions.

**Applicability:** These terms and conditions are in addition to any terms of use for the IBM website.

**Personal Use:** You may reproduce these publications for your personal, noncommercial use provided that all proprietary notices are preserved. You may not distribute, display or make derivative works of these publications, or any portion thereof, without the express consent of IBM.

**Commercial Use:** You may reproduce, distribute and display these publications solely within your enterprise provided that all proprietary notices are preserved. You may not make derivative works of these publications, or reproduce, distribute or display these publications or any portion thereof outside your enterprise, without the express consent of IBM.

**Rights:** Except as expressly granted in this permission, no other permissions, licenses or rights are granted, either express or implied, to the Publications or any information, data, software or other intellectual property contained therein.

IBM reserves the right to withdraw the permissions granted herein whenever, in its discretion, the use of the publications is detrimental to its interest or, as determined by IBM, the above instructions are not being properly followed.

You may not download, export or re-export this information except in full compliance with all applicable laws and regulations, including all United States export laws and regulations.

IBM MAKES NO GUARANTEE ABOUT THE CONTENT OF THESE PUBLICATIONS. THE PUBLICATIONS ARE PROVIDED "AS-IS" AND WITHOUT WARRANTY OF ANY KIND, EITHER EXPRESSED OR IMPLIED, INCLUDING BUT NOT LIMITED TO IMPLIED WARRANTIES OF MERCHANTABILITY, NON-INFRINGEMENT, AND FITNESS FOR A PARTICULAR PURPOSE.







Printed in USA