

Power775
SAS Cable Service Procedure
Last Modified 11/03/2011

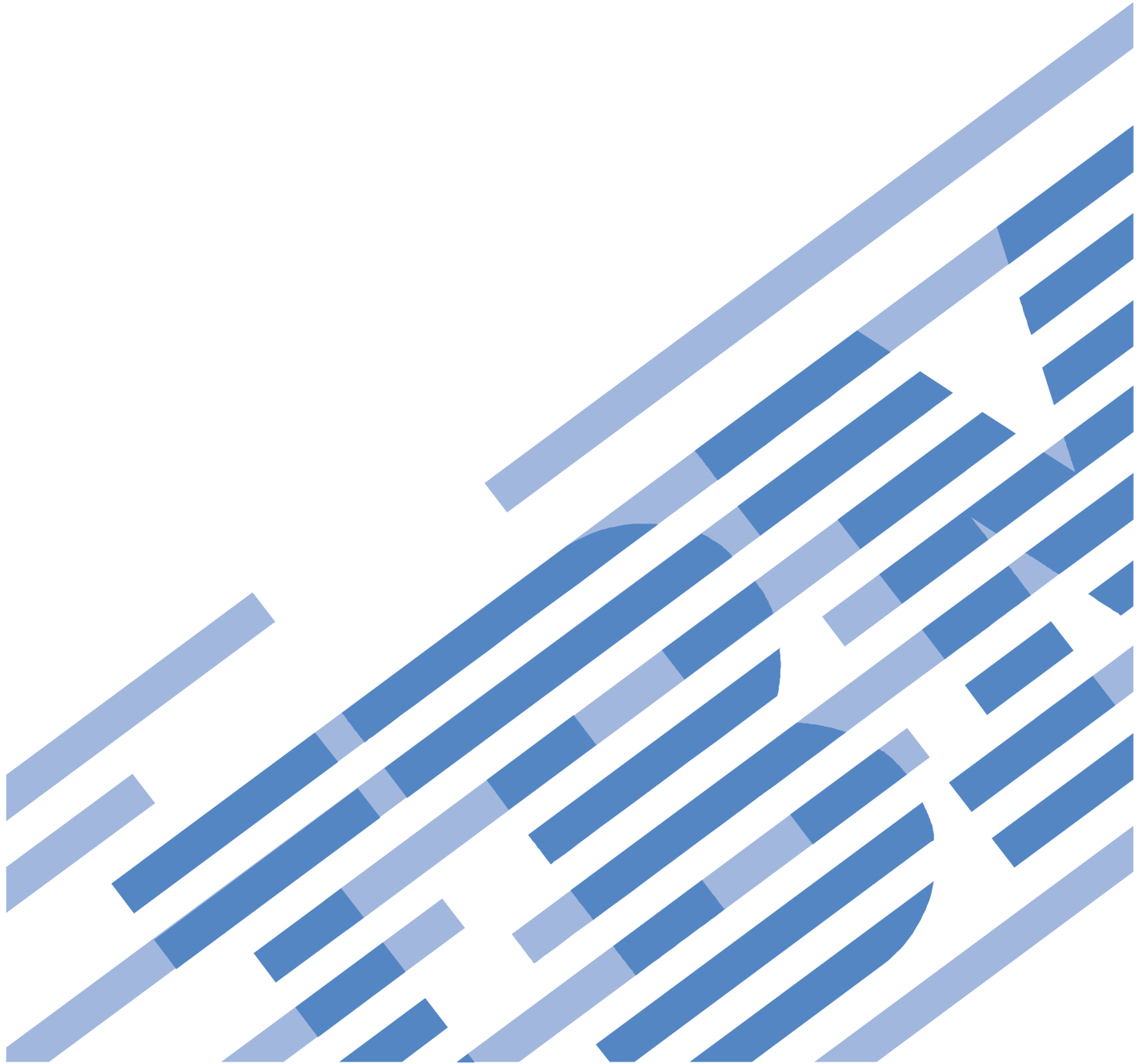

Power775 SAS Cable Service Procedure

CONTENTS

1	GENERAL	4
1.1	RELEASE / REVISION HISTORY	4
1.2	WHERE TO FIND THIS DOCUMENT	4
1.3	REQUIRED DOCUMENTS	4
1.4	RELATED DOCUMENTS	4
1.5	ABBREVIATIONS	5
2	OVERVIEW	6
2.1	SAFETY NOTICES	6
2.2	ATTENTION – FILE SYSTEM RISK STATEMENT	6
2.3	CONFIRM HOW YOU GOT TO THIS POWER 775 DE SAS CABLE SERVICE PROCEDURE	6
2.4	SAS CABLE DESCRIPTION	7
2.4.1	Enclosure VPD label and Location Code	8
2.5	BACKGROUND	8
2.6	CONCURRENCY	8
2.7	SAS CABLE WEIGHT	8
2.8	REQUIRED SSRs AND ROLES	9
2.9	ESTIMATED SERVICE TIME	9
2.10	P7IH HAND TOOL KIT REQUIRED TOOLS	9
2.11	PREREQUISITES FOR THIS PROCEDURE	10
2.12	SERVICE PROCEDURE OVERVIEW	10
3	SERVICE PROCEDURE	11
3.1	LOCATE AND RESEAT CEC END OF SAS CABLE <= SSR TASK	11
3.2	LOCATE AND RESEAT DISK ENCLOSURE END OF SAS CABLE <= SSR TASK	18
3.3	CLEAR GPFS ERRORS AND RETEST THE LINK <= CUSTOMER TASK	21
3.4	REPLACE THE SAS CABLE <= SSR TASK	22
3.5	CLEAR GPFS ERRORS AND RETEST THE LINK <= CUSTOMER TASK	26
3.6	CLEAN UP <= SSR TASK	27
4	END OF POWER775 SAS CABLE SERVICE PROCEDURE	28
5	APPENDIX A: POWER775 BPC FSP COMMAND LINE PROCEDURE	29
5.1	PROCEDURE TO ACCESS THE BPC FSP COMMAND LINE	29
5.2	END OF APPENDIX A: POWER775 BPC FSP COMMAND LINE PROCEDURE	31

Figure List

Figure 1 Cable assembly.....	7
Figure 2 DE Enclosure VPD Label.....	8
Figure 3 Cable push/pull rod kit.....	9
Figure 4 Push/Pull rod sections.....	9
Figure 5 Identify LED Selection.....	11
Figure 6 System Unit, Model F2C Selection.....	12
Figure 7 UNVSA Identify LED Selection.....	13
Figure 8 Frame Photo showing UEPO location.....	14
Figure 9 UEPO assembly showing frame Identify Amber LED.....	15
Figure 10 Door Latch and Door Latch handle shown extended.....	16
Figure 11 CEC Drawer ID – Front.....	16
Figure 12 CEC Drawer ID - Rear.....	16
Figure 13 FRU Serial number location.....	17
Figure 14 Disk Enclosure HEX Cage ID.....	19
Figure 15 The Front DE Enclosure ID LEDs are located on the DCCAs.....	20
Figure 16 Rear Disk Enclosure ID LED is located on the bottom right side of the Disk Enclosure.....	21
Figure 17 Blue SAS cable tabs.....	22
Figure 18 Field tool Push/Pull rod.....	23
Figure 19 Push/Pull rod attached to SAS Cable Assembly.....	24
Figure 20 Cable Labels.....	25

Table List

Table 1 Release / Revision History.....	4
Table 2 Required Documents.....	4
Table 3 Related Documents.....	4
Table 4 Abbreviations.....	5
Table 5 Format for BPC command to blink a DE Port Card ID LED.....	18
Table 6 Format for BPC command to blink a DE Port Card ID LED.....	27

1 GENERAL

1.1 Release / Revision History

Document Name	Date	PDF name	Description
Power775 SAS Cable Service Procedure	11/03/2011	"p775_de_sas_cable.pdf"	Initial Release

Table 1 Release / Revision History

1.2 Where to find this document

The current "Power775 SAS Cable Service Procedure" document is "p775_de_sas_cable.pdf" which is to be downloaded from: InfoCenter Website: <http://publib.boulder.ibm.com/infocenter/powersys/v3r1m5/topic/p7ee2/p7ee2kickoff.htm>
Click "PDF files for the IBM Power 775 (9125-F2C) removing and replacing parts"
Under "Disk Enclosure", click "SAS Cable" to download PDF "p775_de_sas_cable.pdf"

This is the only valid source for the latest Power775 Disk Enclosure SAS Cable Service Procedure.

1.3 Required Documents

Document	PN	Location
Safety Notice http://publib.boulder.ibm.com/infocenter/powersys/v3r1m5/topic/p7hdx/G229-9054.pdf	Doc# G229-9054	InfoCenter *

Table 2 Required Documents

*InfoCenter Website: <http://publib.boulder.ibm.com/infocenter/powersys/v3r1m5/topic/p7ee2/p7ee2kickoff.htm>

1.4 Related Documents

Document	PN	Location
GPFS Native RAID Administration and Programming Reference	Document # SA23-1354	InfoCenter *

Table 3 Related Documents

*InfoCenter Website: <http://publib.boulder.ibm.com/infocenter/powersys/v3r1m5/topic/p7ee2/p7ee2kickoff.htm>

1.5 Abbreviations

Abbreviation	Definition	Details
CEC	Central Electronic Complex	Also referred to as the node.
DCCA	Distributed Conversion and Control Assembly	The power supplies for the CEC and DE are called the CEC DCCA and DE DCCA respectively.
DE	Disk Enclosure	
GPFS	Global Parallel File System	IBM's file system utilizing software RAID
HDD	Hard Disk Drive	This also means hard drive
LED	Light Emitting Diode	
PCB	Printed Circuit Board	
RAID	Redundant Array of Inexpensive Disks	
SAS	Serial Attached SCSI	Protocol used for direct attached storage
SSR	System Service Representative	IBM Service personnel
SSD	Solid State Drive	
UEPO	Unit Emergency Power Off	

Table 4 Abbreviations

2 OVERVIEW

This section is an overview only. Do not start the service procedure until Section 3 which contains the detailed steps.

2.1 Safety Notices

Read “Safety_Notices “ available from InfoCenter – see Section 1.3.
<http://publib.boulder.ibm.com/infocenter/powersys/v3r1m5/topic/p7hdx/G229-9054.pdf>

The following notices apply to all Power775 service procedures:

CAUTION:

Energy hazard present. Shorting might result in system outage and possible physical injury. Remove all metallic jewelry before servicing. (C001)

CAUTION:

The doors and covers to the product are to be closed at all times except for service by trained service personnel. All covers must be replaced and doors locked at the conclusion of the service operation. (C013)

CAUTION:

Servicing of this product or unit is to be performed by trained service personnel only. (C032)

The following notices specifically pertain to this Power775 service procedure.

DANGER:

To prevent a possible shock from touching two surfaces with different protective ground (earth), use one hand, when possible, to connect or disconnect signal cables. (D001)

2.2 Attention – File System Risk Statement

The Global Parallel File System (GPFS) implementation of software RAID stripes data across all the Disk Enclosures in the cluster. **You must carefully check for redundancy before pulling a SAS Cable for replacement. If redundancy is not present, it is possible when pulling a SAS Cable to lose access to enough drives that the file system goes into panic.**

2.3 Confirm how you got to this Power 775 DE SAS Cable Service Procedure

You should be performing this procedure if you have determined a Disk Enclosure SAS Cable has failed and needs service.

You should have downloaded this procedure from:

InfoCenter Website: <http://publib.boulder.ibm.com/infocenter/powersys/v3r1m5/topic/p7ee2/p7ee2kickoff.htm>

This is the only valid source for the latest Power775 DE SAS Cable Service Procedure

2.4 SAS Cable Description

Refer to Figure 1 Cable assembly. SAS cables are built in the 6 discrete lengths listed below:

- 0.6 meters
- 1.2 meters
- 1.5 meters
- 2.5 meters
- 3.25 meters
- 4.0 meters

The longer SAS cables (1.2 m to 4 m) are used to connect the SAS PCIe adapter cards in the Power775 CEC to the Disk Enclosure. The short 0.6 meter cables are used within the Disk Enclosure to daisy chain one group of 48 disks to another.

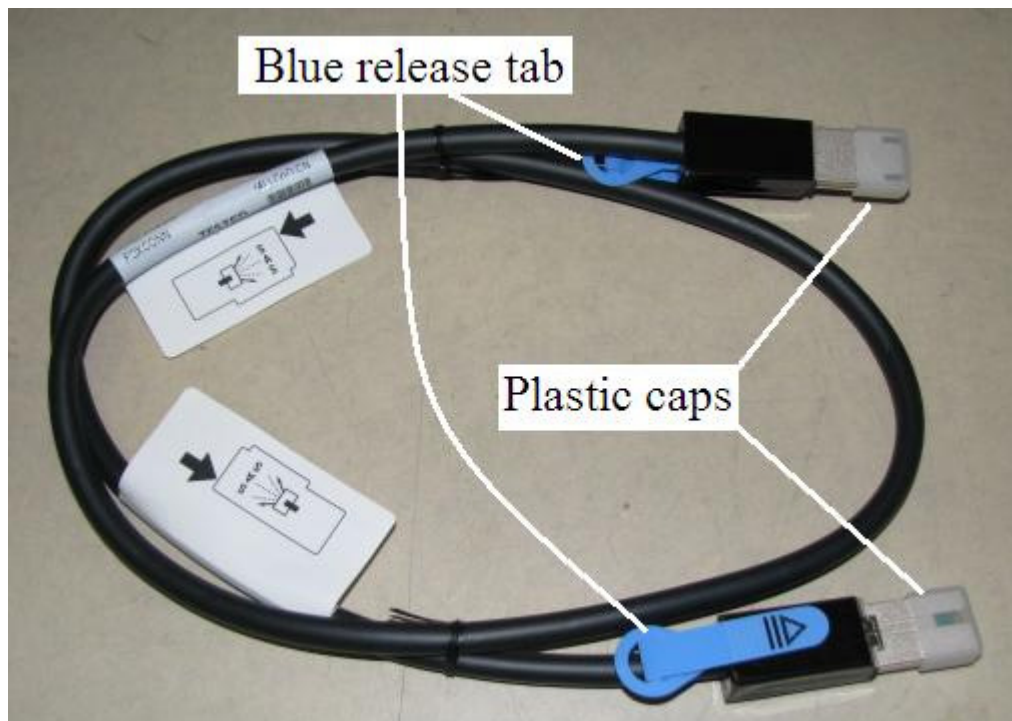

Figure 1 Cable assembly

Power775 SAS Cable Service Procedure

2.4.1 Enclosure VPD label and Location Code

The enclosure VPD label is placed on the rear of a Disk Enclosure just above the enclosure LEDs (see Figure 5 DE Enclosure VPD Label).



Figure 2 DE Enclosure VPD Label

An example of a location code of a SAS Cable in the DE with the label shown in Figure 5 is:

U78AD.001.992001B-P1-C4-T3

This refers to SAS Cable Port T3 on Port Card C4 of the DE.

2.5 Background

This procedure assumes that the two SAS cable location codes have been reported. The PCI Adapter Card Slot ID LED and the Disk Enclosure Port Card Slot ID LED that the SAS Cable connects to will be blinked.

2.6 Concurrency

This cable replacement procedure can be done concurrently.

2.7 SAS cable Weight

The weight of the cable is dependant on cable length. The cable weight will vary between 1 and 2 lbs.

2.8 Required SSRs and Roles

This service procedure requires one SSR.

This service procedure contains steps to be performed by a customer system administrator and an IBM SSR (System Service Representative).

- The customer system administrator performs the STEPs in Sections marked with “<= CUSTOMER TASK”
- The SSR performs the STEPs in Sections marked with “<= SSR TASK”

2.9 Estimated Service Time

The estimated time to replace a SAS cable is about 1 hour.

2.10 P7IH Hand Tool Kit Required Tools

- Service card (shipped in the frame)
- Push/Pull Rod tool (P/N 15R8270) is required only if a cable runs from the front to the back side of the frame. See Figure 3 Cable push/pull rod and Figure 4 Push/Pull rod sections
- Velcro strips (P/N 31L7174) shipped with hand tool kit (P/N 74Y0988).
- Ladder may be required for upper disk enclosure or I/O node locations (shipped in the Power 775 Lift Tool Kit)



Figure 3 Cable push/pull rod kit

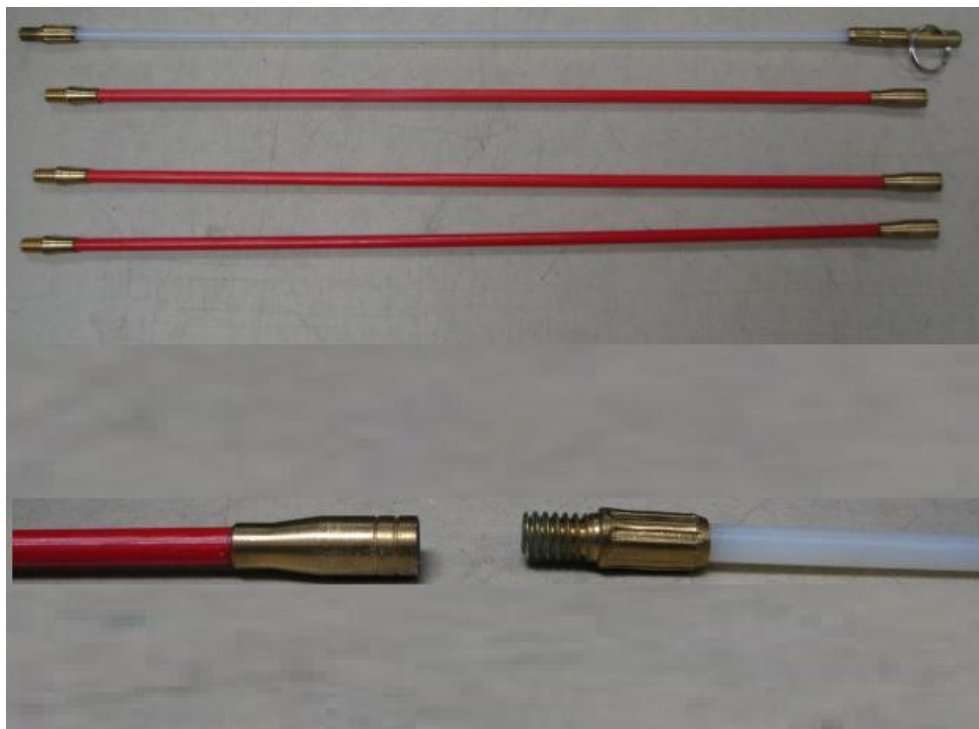

Figure 4 Push/Pull rod sections

2.11 Prerequisites for this Procedure

In order to perform this procedure, you will need the following information:

- 1) The location codes of both ends of the SAS Cable to be serviced
 - 2) The frame number containing the SAS Cable to be serviced
-

2.12 Service Procedure Overview

This is an overview of the tasks to be performed. Read this overview but do not perform any of the tasks yet.

3.1	LOCATE AND RESEAT CEC END OF SAS CABLE <= SSR TASK	11
3.2	LOCATE AND RESEAT DISK ENCLOSURE END OF SAS CABLE <= SSR TASK	18
3.3	CLEAR GPFS ERRORS AND RETEST THE LINK <= CUSTOMER TASK	21
3.4	REPLACE THE SAS CABLE <= SSR TASK	22
3.5	CLEAR GPFS ERRORS AND RETEST THE LINK <= CUSTOMER TASK	26
3.6	CLEAN UP <= SSR TASK	27

3 SERVICE PROCEDURE

STOP – Do not proceed unless you have read “Safety_Notices” which is available from InfoCenter; see Section 1.3.

3.1 Locate and Reseat CEC end of SAS Cable <= SSR TASK

DANGER:

To prevent a possible shock from touching two surfaces with different protective ground (earth), use one hand, when possible, to connect or disconnect signal cables. (D001)

- STEP 1 SAS Cables are used to connect the CEC to the Disk Enclosure (DE). In configurations where chaining is used within the DE, SAS Cables are used to connect Port Cards in the DE to other Port Cards in the same DE.
If the SAS Cable requiring service connects a CEC to a DE, go to STEP 2.
If the SAS Cable requiring service connects two Port Cards in the same DE, go to STEP 11 and perform section 3.2 for both ends of the cable.
- STEP 2 Access the HMC via the keyboard/display that resides in the management rack.
- STEP 3 Place a checkmark in the Select column of the CEC Drawer on which you want to flash Identify LED for the PCI Card Slot with the SAS Adapter card that is connected to the SAS Cable requiring service.
- STEP 4 From the **Tasks** menu *select* **Operations -> LED Status -> Identify LED** (see Figure 5).

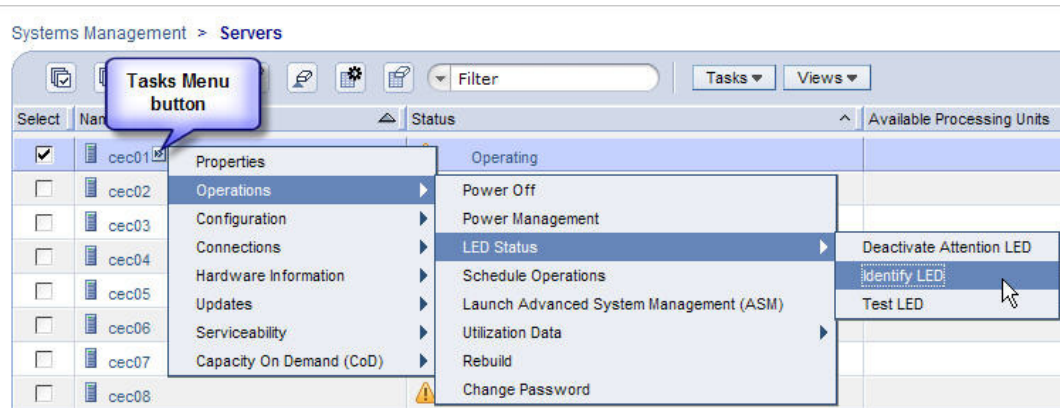

Figure 5 Identify LED Selection

Power775 SAS Cable Service Procedure

- STEP 5 In the window titled **Identify LED, Select Enclosure** *select System Unit, Model F2C* then *click the List FRUs...* button (see Figure 6).

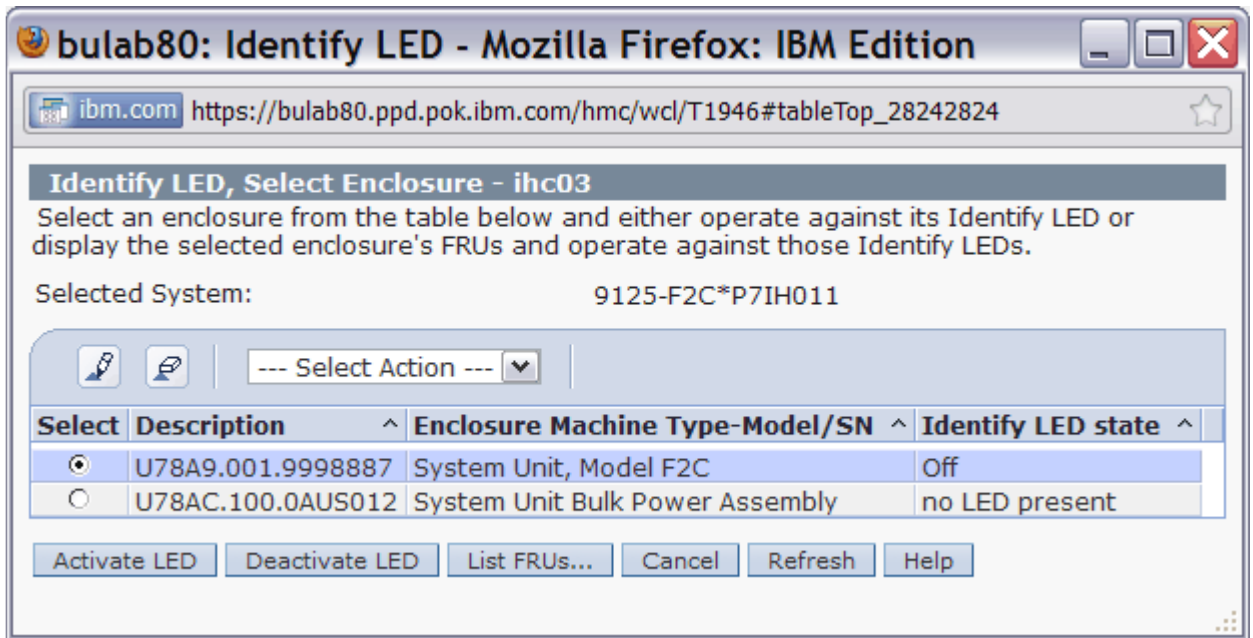

Figure 6 System Unit, Model F2C Selection

Power775 SAS Cable Service Procedure

- STEP 6 In the window **Identify LED, Select Location**, place a checkmark in the Select column for the PCI Adapter Card Location Code with the SAS Adapter connected to the Cable requiring service and then *click* the **Activate LED** button.

Identify LED, Select Location - Server-9125-F2C-SN02B01A5

The current Identify LED states for all the location codes contained in the selected enclosure are displayed below. Select a single location code or multiple location codes to operate against and activate or deactivate the LED(s) by selecting the corresponding button.

Selected System: 9125-F2C*02B01A5
Selected Enclosure: System Unit, Model F2C, 78A9-001/9998887

Select	Location	Description	Identify LED State
<input type="checkbox"/>	U78A9.001.9998887-P1-C148	Distributed Converter and Control Assembly	Off
<input type="checkbox"/>	U78A9.001.9998887-P1-C148-E1	Battery	Off
<input type="checkbox"/>	U78A9.001.9998887-P1-C148-T1	Connector	no LED present
<input type="checkbox"/>	U78A9.001.9998887-P1-C148-T2	HMC1Connector(FSP)	Off
<input type="checkbox"/>	U78A9.001.9998887-P1-C148-T3	HMC2Connector(FSP)	Off
<input type="checkbox"/>	U78A9.001.9998887-P1-C148-T4	Connector	no LED present
<input type="checkbox"/>	U78A9.001.9998887-P1-C15	PCI Adapter Card	Off
<input type="checkbox"/>	U78A9.001.9998887-P1-C16	PCI Adapter Card	Off
<input type="checkbox"/>	U78A9.001.9998887-P1-C17	PCI Adapter Card	Off
<input type="checkbox"/>	U78A9.001.9998887-P1-C18	MemoryDIMM	Off
<input type="checkbox"/>	U78A9.001.9998887-P1-C19	MemoryDIMM	Off
<input checked="" type="checkbox"/>	U78A9.001.9998887-P1-C2	PCI Adapter Card	On
<input type="checkbox"/>	U78A9.001.9998887-P1-C20	MemoryDIMM	Off
<input type="checkbox"/>	U78A9.001.9998887-P1-C21	MemoryDIMM	Off
<input type="checkbox"/>	U78A9.001.9998887-P1-C22	MemoryDIMM	Off
<input type="checkbox"/>	U78A9.001.9998887-P1-C23	MemoryDIMM	Off
<input type="checkbox"/>	U78A9.001.9998887-P1-C24	MemoryDIMM	Off
<input type="checkbox"/>	U78A9.001.9998887-P1-C25	MemoryDIMM	Off
<input type="checkbox"/>	U78A9.001.9998887-P1-C26	MemoryDIMM	Off
<input type="checkbox"/>	U78A9.001.9998887-P1-C27	MemoryDIMM	Off

Activate LED Deactivate LED Refresh Cancel Help

Figure 7 UNVSA Identify LED Selection

Power775 SAS Cable Service Procedure

- STEP 7 Locate the frame. Confirm that it is the correct frame by checking that its UEPO Panel Identify LED is blinking. This LED is located on the UEPO panel and it is marked by the “!” symbol (see Figure 8 and Figure 9).

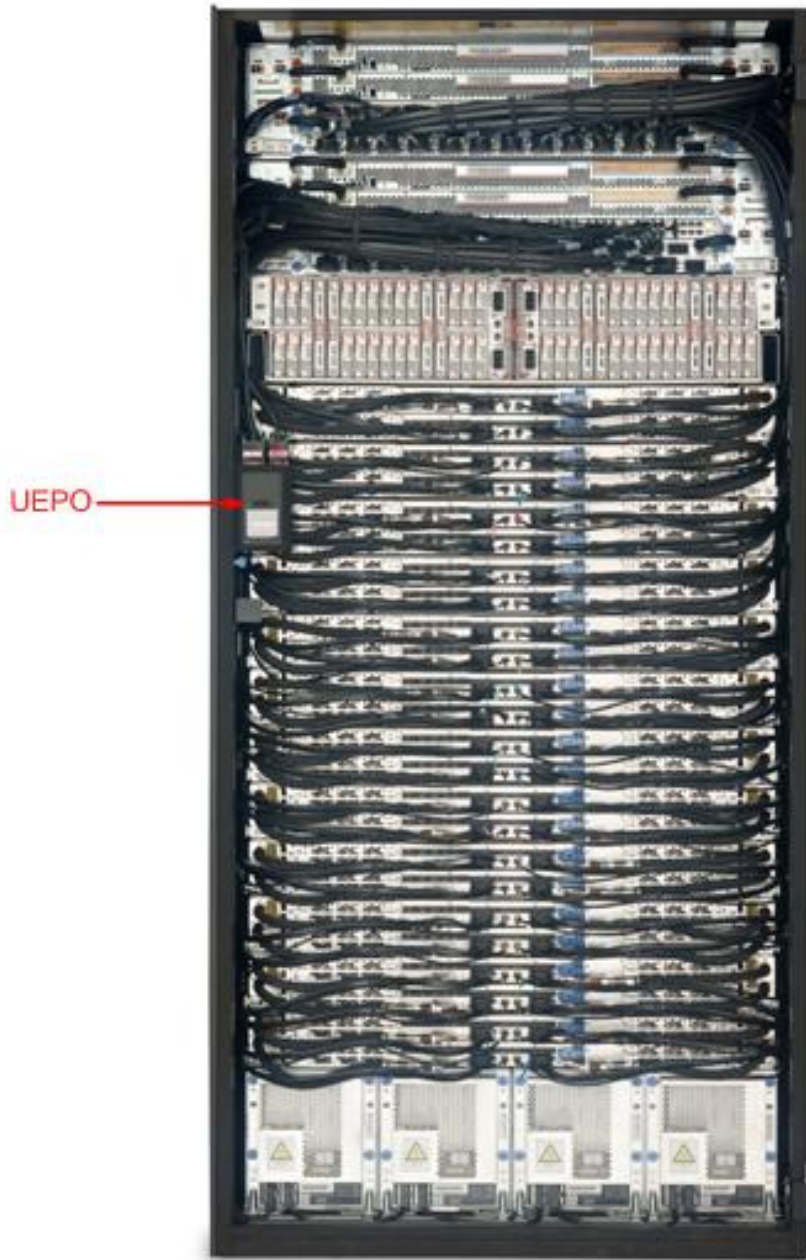

Figure 8 Frame Photo showing UEPO location

Power775 SAS Cable Service Procedure

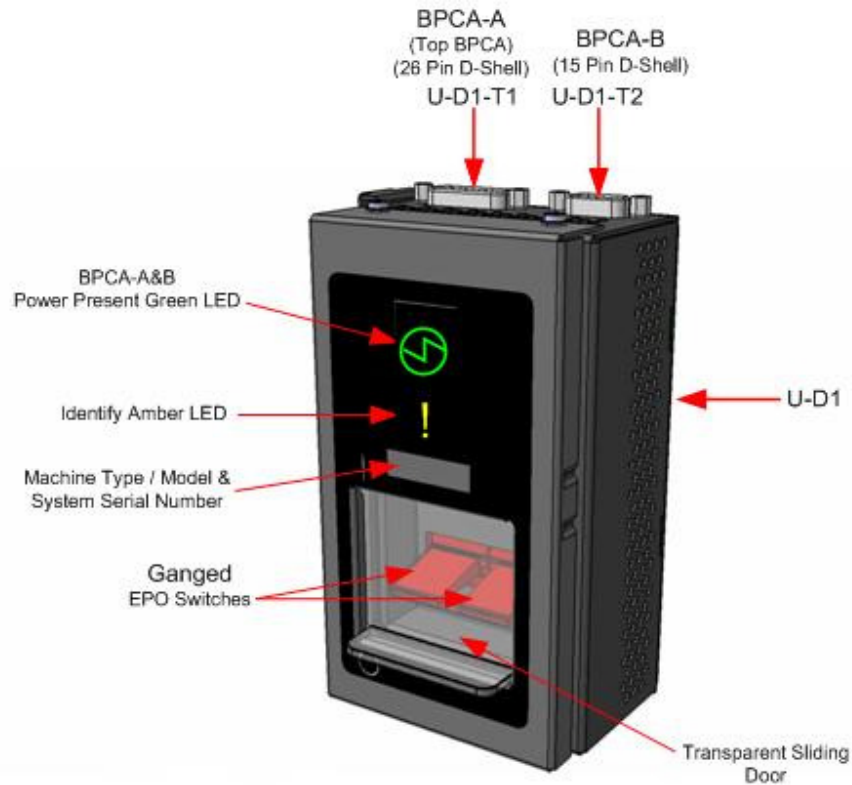

Figure 9 UEPO assembly showing frame Identify Amber LED

- STEP 8** Open the front door of the frame. Locate the latch along the left side of the door; push in on the + button, the latch handle will pop out of the latch pocket. Grasp the latch handle and swing the door to the right (see Figure 10). Check that the CEC Drawer Identify LED (see Figure 11 and Figure 12) is flashing. If the LEDs are not flashing, verify the FRU via MTMS (machine type model serial number). The rack level MTMS is located on the face of the UEPO Panel.

Power775 SAS Cable Service Procedure

- STEP 9 After locating the rack that requires the service, double check the rack serial number and the CEC Enclosure VPD serial number to ensure the correct location. See Figure 13.

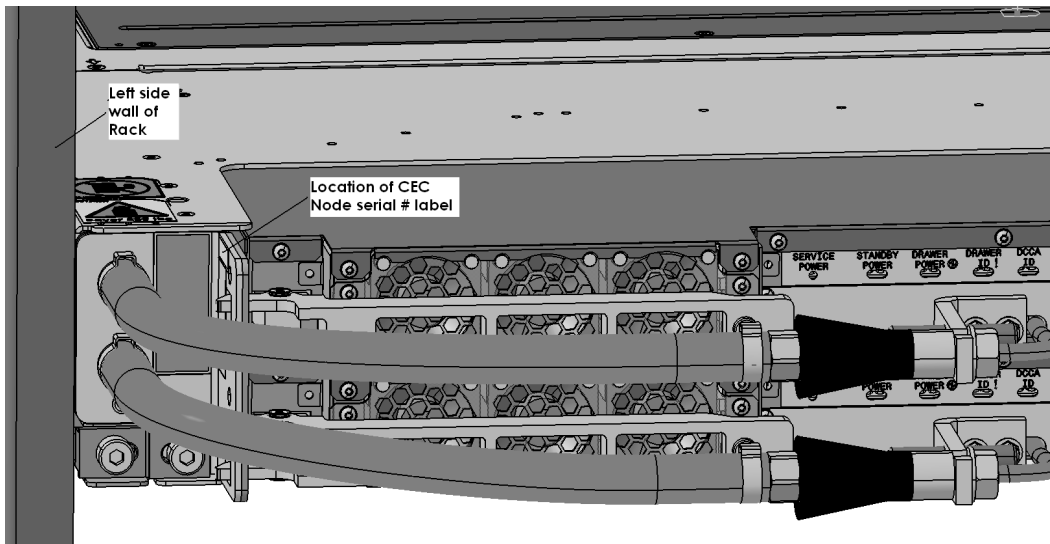

Figure 13 FRU Serial number location

- STEP 10 Open the rear door and verify that the correct PCI Adapter Card (with the SAS Adapter connected to the SAS Cable requiring service) has its slot Identify LED flashing.
- STEP 11 Each cable end should have two labels. The label closest to the connector (between the SN label and the connector) tells you the location to plug that end. The label on the other side of the SN label tells you where the other end of the cable is plugged. The convention for the label is like the location code of the port: <frame location> <card location><connector location>. The labels should match the location codes reported for the SAS Cable requiring service.

Check to see if the SAS Cable requiring service is completely plugged to the SAS Adapter port. Reseat the SAS Cable connector. The cables can be disconnected by pulling on the Blue connector tab (see Figure 17).

The Ladder may be required for upper CEC locations.

3.2 Locate and Reseat Disk Enclosure end of SAS Cable <= SSR TASK

DANGER:

To prevent a possible shock from touching two surfaces with different protective ground (earth), use one hand, when possible, to connect or disconnect signal cables. (D001)

If this is a SAS Cable used for chaining within a DE, reseat both ends of the SAS Cable.

STEP 12 Use the procedure “Appendix A: Power775 BPC FSP Command Line Procedure” (included in Section 5 of this document) to access the BPC FSP command line of the frame containing the Disk Enclosure that the SAS Cable is connected to.

STEP 13 Blink the Disk Enclosure Port Card Slot Identify LED, for the Port Card location that the SAS Cable requiring service is connected to, by using the following command from the BPC Command Line:

This is the command syntax:

```
bpccmd -c 27<blank>0000<cage ID><FRU ID><LED blink state 00=off, 02=blink>
```

<blank> = “11”
 <cage ID> = see Figure 14
 <FRU ID> = see Table 5 for the DE Port Card Identify LED.
 <LED state> = “02” for this step

Type in the following, inserting the correct cage ID DE chassis location:

```
bpccmd -c 27110000xxyy02
```

“xx” is the cage ID of the DE you are replacing. This field will be 05, 07, 09, 0B, 0D, or 0F (see Figure 14).

“yy” is the “<FRU ID>”. Choose this based on the “Port Card position” column in Table 5.

Port Card position	Example command	<FRU ID>	02 = BLINK '00 = OFF
C4	bpccmd -c 27110000xxD002	D0	02
C5	bpccmd -c 27110000xxD102	D1	02
C12	bpccmd -c 27110000xxD202	D2	02
C13	bpccmd -c 27110000xxD302	D3	02
C20	bpccmd -c 27110000xxD402	D4	02
C21	bpccmd -c 27110000xxD502	D5	02
C28	bpccmd -c 27110000xxD602	D6	02
C29	bpccmd -c 27110000xxD702	D7	02
C60	bpccmd -c 27110000xxD802	D8	02
C61	bpccmd -c 27110000xxD902	D9	02
C68	bpccmd -c 27110000xxDA02	DA	02
C69	bpccmd -c 27110000xxDB02	DB	02
C76	bpccmd -c 27110000xxDC02	DC	02
C77	bpccmd -c 27110000xxDD02	DD	02
C84	bpccmd -c 27110000xxDE02	DE	02
C85	bpccmd -c 27110000xxDF02	DF	02

Table 5 Format for BPC command to blink a DE Port Card ID LED.

Power775 SAS Cable Service Procedure

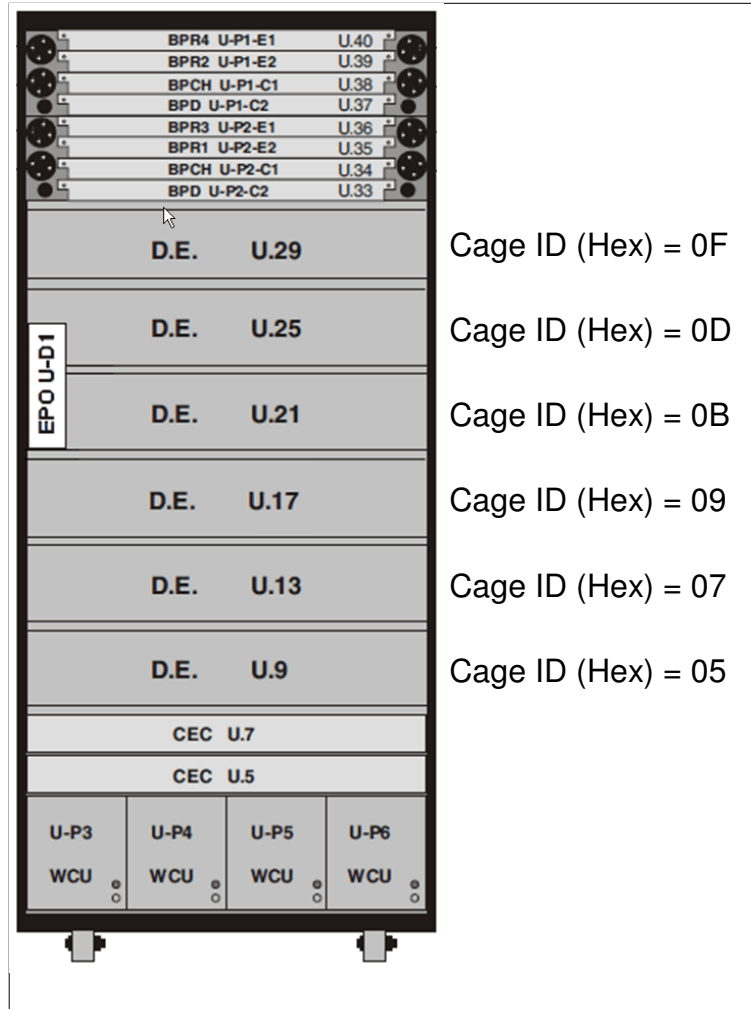

Figure 14 Disk Enclosure HEX Cage ID

Power775 SAS Cable Service Procedure

STEP 14 If the SAS Cable requiring service connects to a CEC, you have already located the frame for the DE since SAS Cables stay within the frame.

If you are servicing a SAS Cable chaining two Port Cards within the same DE, then you need to locate the frame. Confirm that it is the correct frame by checking that its UEPO Panel Identify LED is blinking. This LED is located on the UEPO panel and it is marked by the “!” symbol (see Figure 8 and Figure 9).

STEP 3 Identify the failing Disk Enclosure by looking for the blinking amber Enclosure ID LEDs (see Figure 15 and Figure 16).

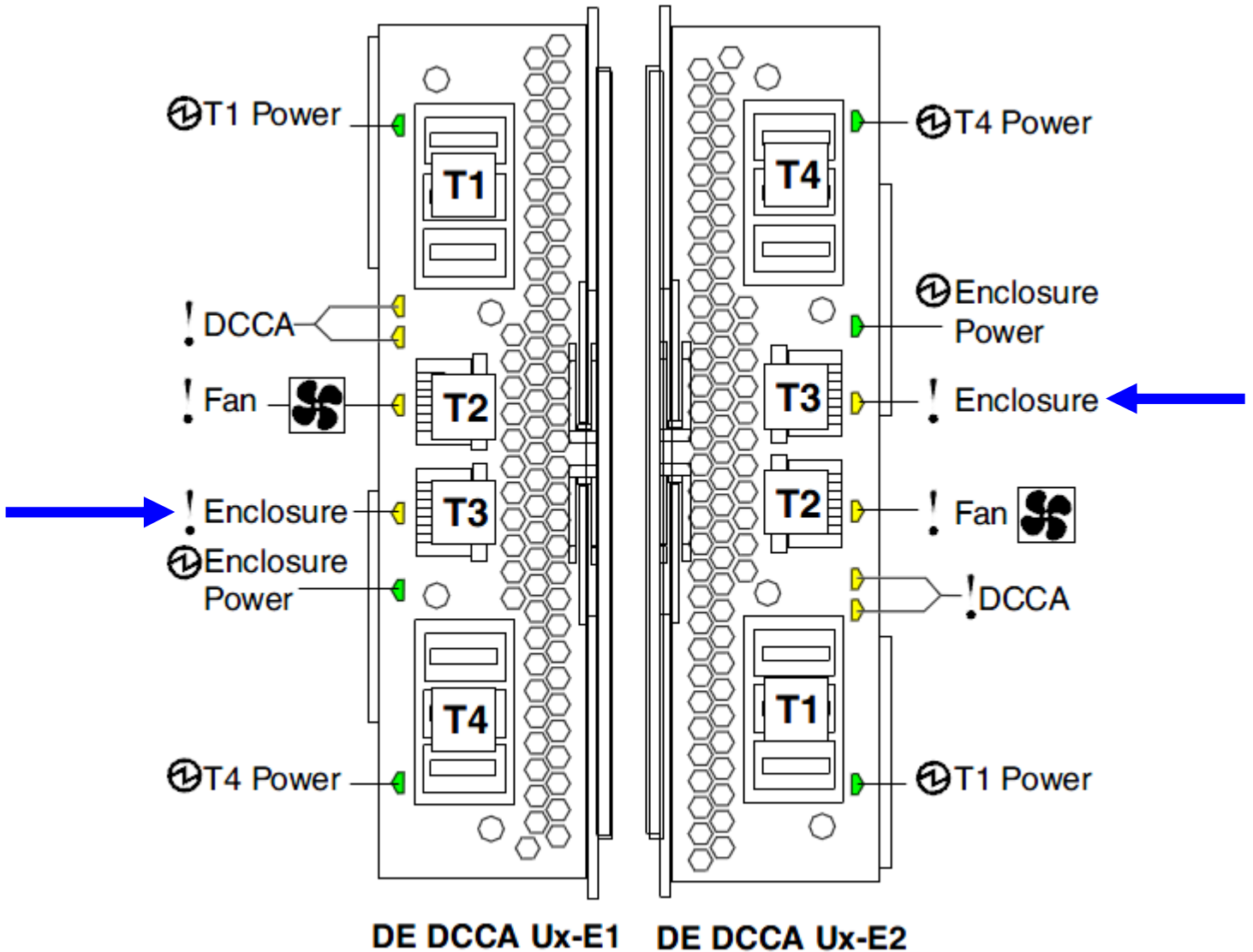

Figure 15 The Front DE Enclosure ID LEDs are located on the DCCAs

Power775 SAS Cable Service Procedure

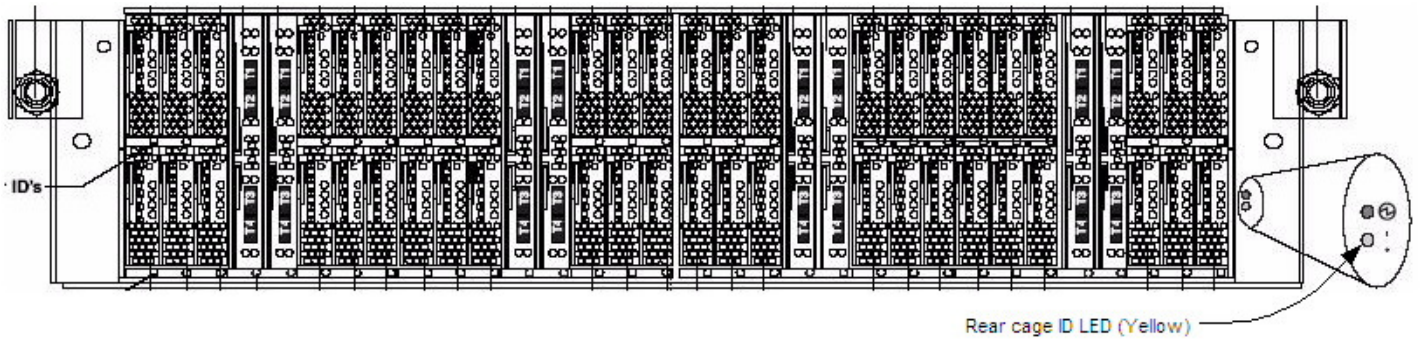

Figure 16 Rear Disk Enclosure ID LED is located on the bottom right side of the Disk Enclosure

STEP 15 Each cable end should have two labels. The label closest to the connector (between the SN label and the connector) tells you the location to plug that end. The label on the other side of the SN label tells you where the other end of the cable is plugged. The convention for the label is like the location code of the port: <frame location> <card location><connector location>. The labels should match the location codes reported for the SAS Cable requiring service.

Check to see if the SAS Cable requiring service is completely plugged to the DE Port Card. Reseat the SAS Cable connector. The cables can be disconnected by pulling on the Blue connector tab (see Figure 17).

The Ladder may be required for upper DE locations.

3.3 Clear GPFS errors and retest the link <= Customer TASK

STEP 16 Clear the GPFS error logs and test the links.

If the link is no longer accumulating errors, reseating the cables has fixed the link, so proceed to STEP 20.

If the link is still accumulating errors, proceed to STEP 17.

3.4 Replace the SAS Cable <= SSR TASK

STEP 17 Remove the SAS Cable:

Remove both ends of the SAS cable from the mating connector by pulling the Blue tabs (see Figure 17). Unwrap any Velcro cable strips and rewrap them on remaining cables as necessary. If the cable is routed from the front of the machine to the back pull the cable thru the cable trough. The Ladder may be required for upper DE or CEC locations.

If the cable runs from the front of the machine to the back, assemble the Push/Pull rod P/N (P/N 15R8270) (see Figure 18). Remove the protective caps and screw the 4 sections together to create a tool long enough to pass the cable from the front to the back of the frame. Using a Velcro strip (P/N 31L7174) shipped with hand tool kit (P/N 74Y0988), attach the new cable to the Push/Pull rod ring (see Figure 19).



Figure 17 Blue SAS cable tabs

Power775 SAS Cable Service Procedure



Figure 18 Field tool Push/Pull rod

Power775 SAS Cable Service Procedure

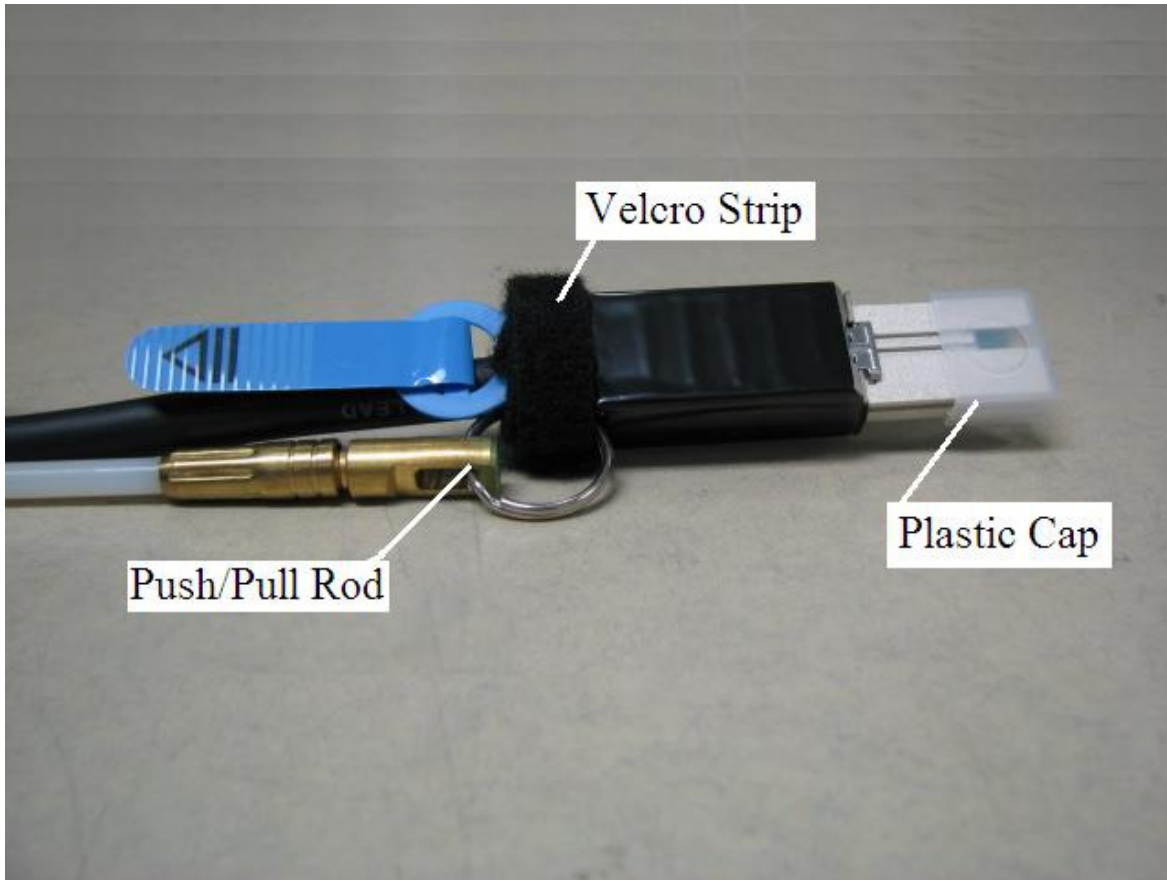

Figure 19 Push/Pull rod attached to SAS Cable Assembly

STEP 18 Install the new SAS Cable:

Using two new labels supplied with the new SAS Cable write the location codes on the labels and attach the labels to the ends of the new cable. (See Figure 20 Cable Labels). As stated before, the convention for the label is like the location code of the port: <frame location> <card location><connector location> and there are 2 labels per cable end; see STEP 15 for details).

Both ends of the cable have the same keying so it does not matter which end goes to the Disk Enclosure and which end goes to the SAS adapter card. For cables running through cable raceway in the Disk Enclosure Rail, use Push/Pull Rod tool (P/N 15R8270) and insert the cable through the cable raceway where the damaged cable was removed. Route the cable in a similar manner as the failed cable using Velcro strips to dress cables. Additional Velcro strips are shipped with hand tool kit (P/N 74Y0988). Remove the plastic caps (see Figure 1 Cable assembly) and plug the new cable into the connectors where the original cable was removed.



Figure 20 Cable Labels

3.5 Clear GPFS errors and retest the link <= Customer TASK

STEP 19 Clear the GPFS error logs and test the links.

If the link is no longer accumulating errors, the link has been repaired.

If the link is still accumulating errors, other FRUs must be considered such as the Drive, DE Port Card, DE Drive Carrier, SAS Adapter Card, and PCI Riser Card.

3.6 CLEAN UP <= SSR TASK

STEP 20 Turn off the Disk Enclosure Port Card Slot Identify LED, for the Port Card location that the SAS Cable requiring service is connected to, by using the following command from the BPC Command Line:

This is the command syntax:

```
bpccmd -c 27<blank>0000<cage ID><FRU ID><LED blink state 00=off, 02=blink>
```

<blank> = "11"
 <cage ID> = see Figure 14
 <FRU ID> = see Table 5 for the DE Port Card Identify LED.
 <LED state> = "00" for this step

Type in the following, inserting the correct cage ID DE chassis location:

```
bpccmd -c 27110000xxxy00
```

"xx" is the cage ID of the DE you are replacing. This field will be 05, 07, 09, 0B, 0D, or 0F (see Figure 14).

"yy" is the "<FRU ID>". Choose this based on the "Port Card position" column in Table 5.

Port Card position	Example command	<FRU ID>	02 = BLINK '00 = OFF
C4	bpccmd -c 27110000xxD000	D0	00
C5	bpccmd -c 27110000xxD100	D1	00
C12	bpccmd -c 27110000xxD200	D2	00
C13	bpccmd -c 27110000xxD300	D3	00
C20	bpccmd -c 27110000xxD400	D4	00
C21	bpccmd -c 27110000xxD500	D5	00
C28	bpccmd -c 27110000xxD600	D6	00
C29	bpccmd -c 27110000xxD700	D7	00
C60	bpccmd -c 27110000xxD800	D8	00
C61	bpccmd -c 27110000xxD900	D9	00
C68	bpccmd -c 27110000xxDA00	DA	00
C69	bpccmd -c 27110000xxDB00	DB	00
C76	bpccmd -c 27110000xxDC00	DC	00
C77	bpccmd -c 27110000xxDD00	DD	00
C84	bpccmd -c 27110000xxDE00	DE	00
C85	bpccmd -c 27110000xxDF00	DF	00

Table 6 Format for BPC command to blink a DE Port Card ID LED.

STEP 21 Log out of ASM.

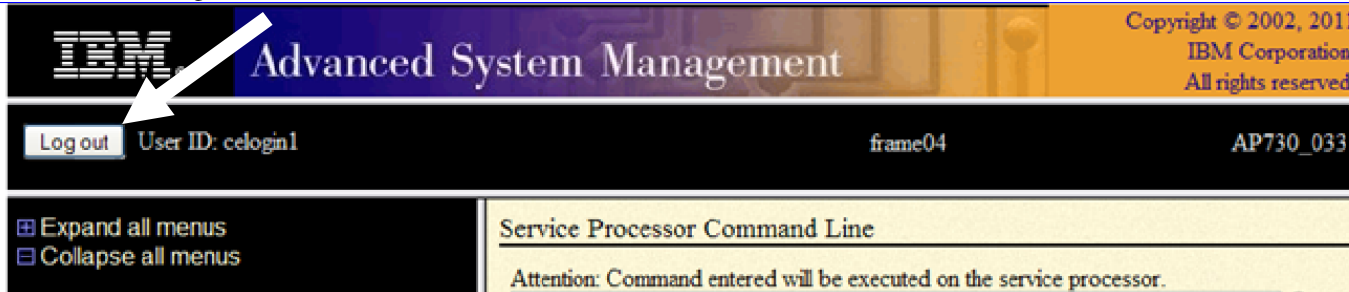

Power775 SAS Cable Service Procedure

- STEP 22 Turn off the PCI Adapter Card slot LED in the CEC by going to the window **Identify LED, Select Location**, and placing a checkmark in the Select column for the PCI Adapter Card Location Code with the SAS Adapter connected to the Cable requiring service and then *click* the **Dectivate LED** button.
- STEP 23 Store tools and return system back into service
If the Push/Pull rod was used, disassemble the four Push/Pull rod sections, install the protective caps and return them to the original container.
- STEP 24 Close the front and rear frame doors

4 END OF POWER775 SAS CABLE SERVICE PROCEDURE

5 APPENDIX A: POWER775 BPC FSP COMMAND LINE PROCEDURE

5.1 Procedure to Access the BPC FSP Command Line

1. The HMC can be accessed via the keyboard/display that resides in the network management rack.
2. Login to the HMC if not done already.
3. In the HMC navigation pane, expand 'Systems Management' + sign and then click 'Frames':

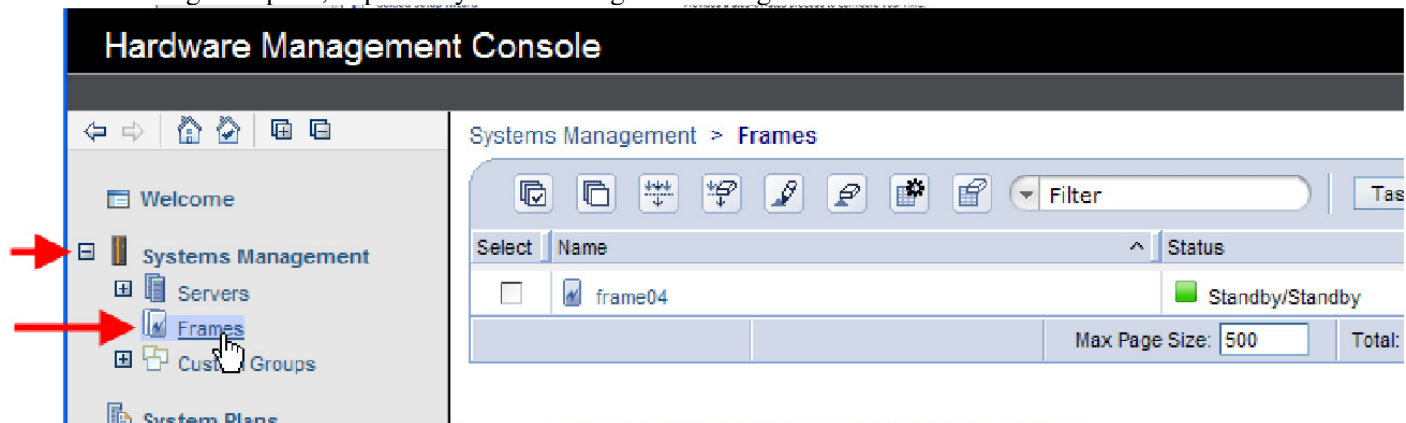

4. From the Tasks Menu right-arrow pull-down menu, click **Operations** → **Launch Frame Advanced Systems Management (ASM)**

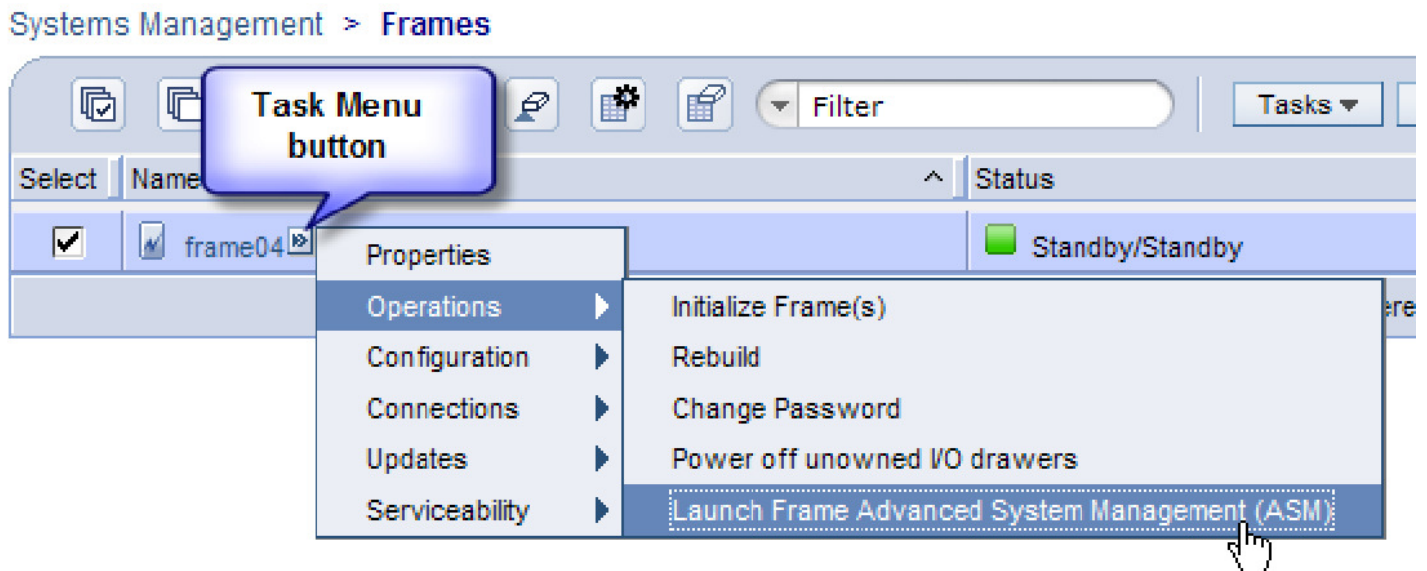

Power775 SAS Cable Service Procedure

- From the Launch ASM Interface window, select **SIDE_A** for the 'Frame IP Address' then click the **OK** button.

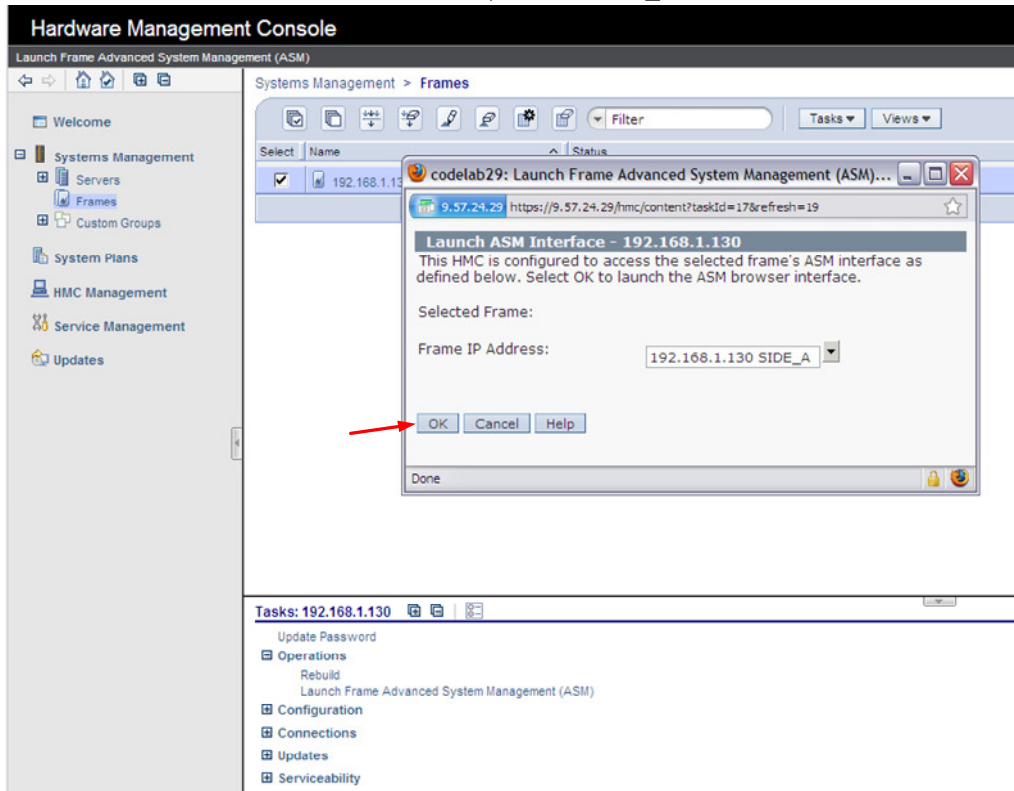

- The ASM login window is presented. Acquire the necessary User ID and Password.

“celogin” requires Daily PW from the IBM Support Center.

“celogin1” might be has enabled by the customer. If so, obtain the password from the customer.

- Enter User ID
- Enter Password
- Click **Log in** button

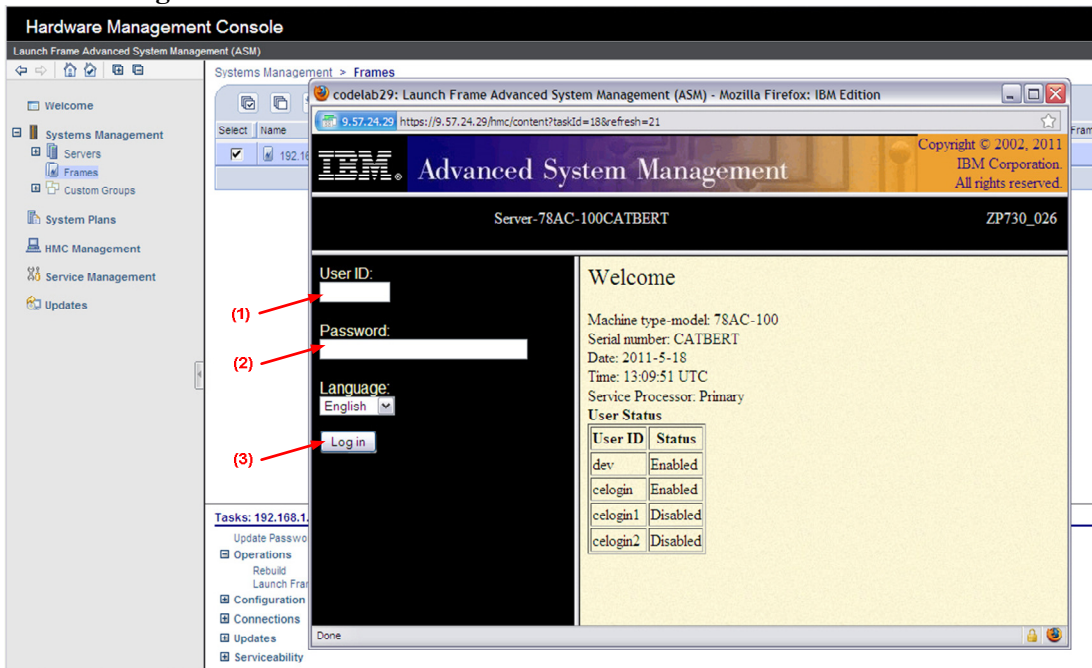

Power775 SAS Cable Service Procedure

- Expand 'System Service Aids' + sign and Select 'Service Processor Command Line'.

IBM Advanced System Management

Copyright © 2002, 2011
IBM Corporation.
All rights reserved.

Log out User ID: celogin1 frame04 AP730_033

Expand all menus
Collapse all menus
System Service Aids
Error/Event Logs
Service Processor Dump
Reset Service Processor
Service Processor Command Line
System Information
System Configuration
Network Services
Login Profile

Service Processor Command Line

Attention: Command entered will be executed on the service processor.

Execute Clear

- The ASM BPC FSP Command line will be presented. Enter the commands defined in the paper service procedures at this command line and press the Enter key (or click the **Execute** button).
- Return to the step of the paper service procedure that directed you to this Appendix.

5.2 End of Appendix A: Power775 BPC FSP Command Line Procedure