



“How System z10 changes the equation for new workloads that can be put on z”

**Mark S. Anzani
Vice President,
System z Client Technical Support**



Agenda

- **System z – market place reaction**
- **Enhanced Attributes of System z10**
- **System z10 family expansion**
- **Workload expansion directions for System z**

Operational issues have IT at a break point

Costs & Service Delivery



Business Resiliency & Security



Energy Efficiency



Changing application models

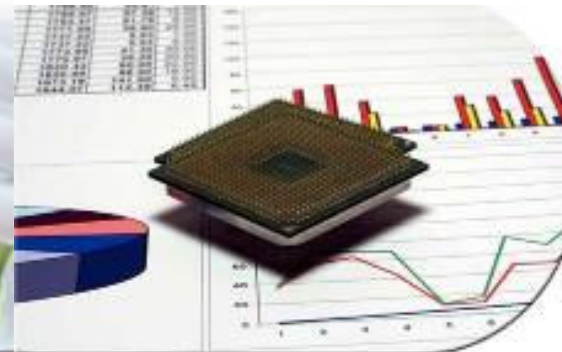

Addressing these issues requires a new strategy for the data center

System z in the New Enterprise Data Center

Dynamic



- Virtualized
- Real time integration of transactions, information & analytics
- Business-driven services
- Service oriented

Data Center

Enterprise “private” clouds

System z is the natural data-hub for enterprise Clouds:

- Centralized control & management
- Consolidation of 100s - 1000s of diverse workloads
- Most efficient cost per compute power
- -Able (scalable, available, reliable)



System z - momentum continues

- **System z is a strategic platform for IBM, with over \$1B invested annually in System z innovation, client success, and solution development**

- **z10 Technology has spurred new growth in System z and its ecosystem**
 - ▶ 30% capacity growth in 1H 08
 - ▶ 32% Revenue growth (Q2)
 - ▶ More than 100 new ISV partners
 - ▶ Linux server revenue grew 28% YTY in 2Q08 (1)

- **IDC reports System z grows to 37% share (> \$250K space) in 2Q08 (2)**
 - ▶ Up 6 share points over 1Q 08

- **System z clients are growing**
 - ▶ Existing clients growing z capacity
 - ▶ New Clients to the platform

(1) Q208 Gartner Linux Share Results (2) IDC 2Q 08 WW Server Tracker

ISV Ecosystem Continues to Grow

- Continued growth on the z platform in 2008
 - ▶ More Partners and applications
- ISV Partner loyalty
 - ▶ application and Operating System currency
- Increased investments
 - ▶ More support, training and program management
- Strengthened relationships and teaming with many ISVs

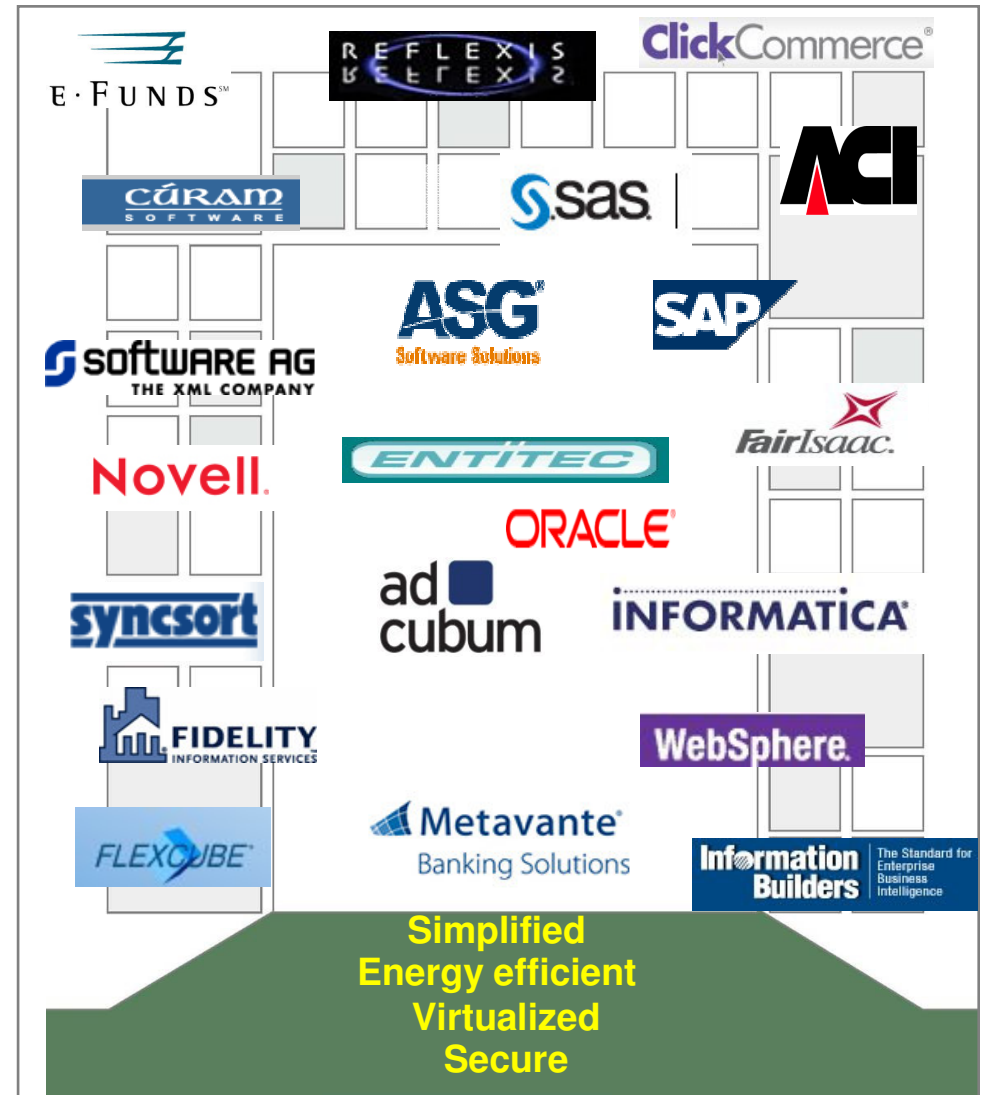

The IBM System z10™ Enterprise Class... a marriage of evolution and revolution

Evolution

- Scalability and virtualization to reduce cost and complexity
- Improved efficiency to further reduce energy consumption
- Improved security and resiliency to reduce risk
- New heights in storage scalability and data protection

Revolution

- 4.4 GHz chip to deliver improved performance for CPU intensive workloads
- ‘Just in time’ deployment of capacity resources
- Vision to expand System z capabilities with appliance technology



Enhanced attributes of System z10

- Java and new application performance focus

- **Processor core**
 - 4.4 Ghz and new pipeline
 - larger on-chip cache (L1.5)
- **L2 Cache**
 - Size increased
 - cache sharing enhanced with “Star” topology interconnect
- **ISA (Instruction Set Architecture) extensions**
 - over 50 new instructions including ...
 - storage immediate, compare and relative instructions
 - compare and branch, compare and trap
 - prefetch or “touch” instructions
 - improved code efficiency for Java and C++ code
- **DFP (Decimal Floating Point) instructions in HW**
 - improved performance and precision for decimal calculations
- **Large Page (1 MB) support**
 - improved TLB effectiveness
- **Exploitation of the above comes in various flavors**
 - JIT automatically uses many of these items beginning with the JVM running Java 6 SR1
 - additional JVM exploitation in Java6 SR2 and later releases
 - C,C++ compile time options targeting z10
 - application development

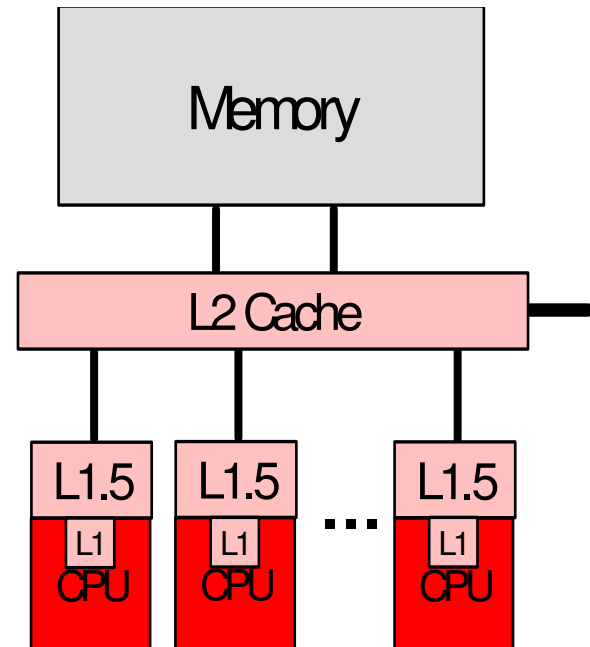

System z10 Java 6 Performance

- **Exploits z10 out of the box**
- **New features**
 - Faster thread performance (~1.5x MIPS)
 - Large page support
 - zOS only provides authorized support in R1.9
 - Extensions to the ISA
 - 20+ new instructions are exploited
 - Decimal Floating Point for BigDecimal objects
- **Average improvement across 8 single threaded benchmark cases shows 2.1X improvement vs z9**
- **Multi-threaded case shows 1.7x improvement vs z9**
- **XML parsing results average 1.9X improvement vs z9**

Customer anecdotal experiences



- Linux enablement
- Websphere
- Mixed workload throughput

IBM Global Financing – Your Technology Lifecycle Partner

Plan

[Sale Leaseback](#) of equipment for cash infusion and better TCO

[Project Financing](#) for consulting, services, hardware and software

Retire

Unsurpassed [asset buyback, recovery and disposal services](#) in compliance with environmental regulations

End of lease options for growth and budget optimization

Acquire

[Competitive low rates](#)¹ and offerings to address any client budget and project requirement

Manage

Mid-lease upgrades to optimize price performance with minimal budget impact*; avoid technology obsolescence

[Technology migration offerings](#)

Rely on IBM Global Financing for both the acquisition, funding and retirement of IT assets, including IBM and non-IBM equipment

¹ Monthly IBM Global Financing rates based on 36 month term with "Best" credit rating and Value Plan lease. Actual financing rates based on client's credit rating, financing terms, offering type, equipment type and options. Other restrictions may apply.

* Actual financing rates based on client's credit rating, financing terms, offering type, equipment type and options. Other restrictions may apply.

Exploiting System z for New Workloads

- Financial analytics - POC

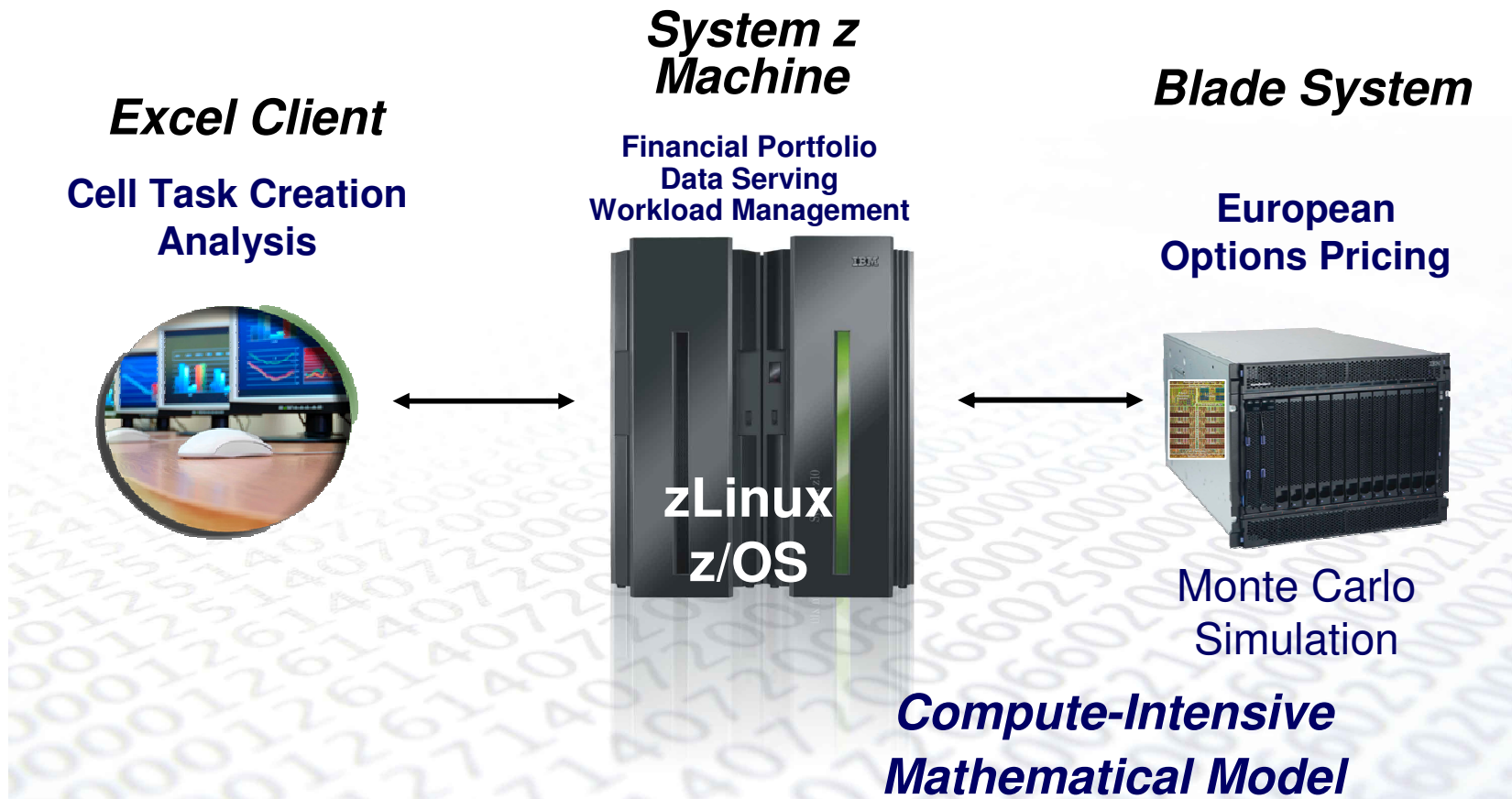

Cognos and System z Smart technology for Smart decisions

- **Better Decisions, Better Service, Best value**
 - ▶ Delivering operational efficiency through timely and accurate information access
 - ▶ Delivering the quality of service required for the growing global business
 - ▶ The best choice for an affordable enterprise wide information service

- **All in one low cost solution for data serving and business analytics**



System z and Cognos

The first great decision of many

ACI Worldwide and System z Zero tolerance to Fraud

- Centralized platform for Running entire transaction base from multiple channels:
 - ▶ Lower cost than multiple platforms
 - ▶ Near real time assessment lowers risk and reduces exposure
 - ▶ Scalability to handle variable and increased transaction volumes
- Extensive data mining capabilities

***ACI BASE24-eps
Optimized for System z***

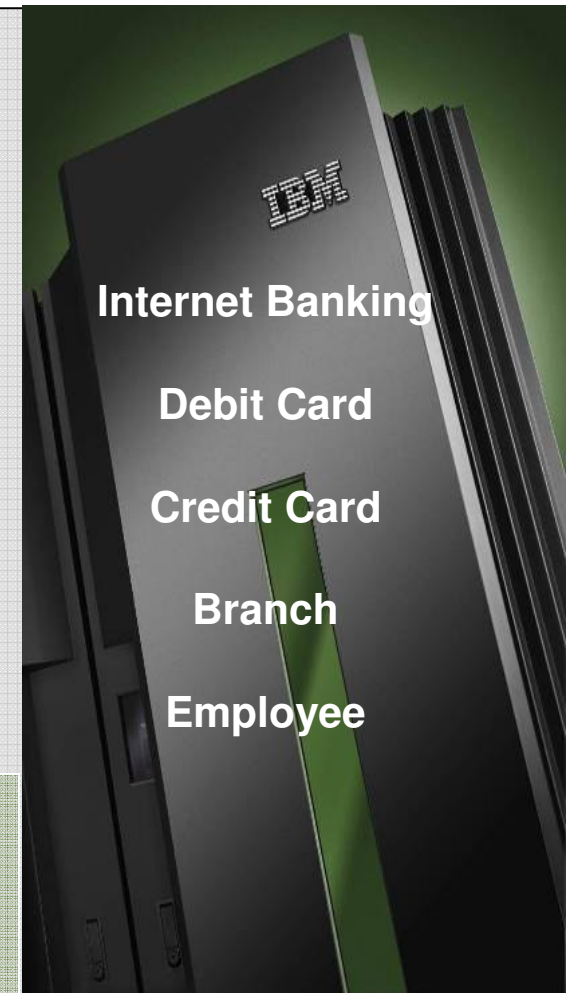

Technology Roadmap to Deliver Client Value

- Flexibility
- Performance
- Lower cost
- New functionality
- Efficiency

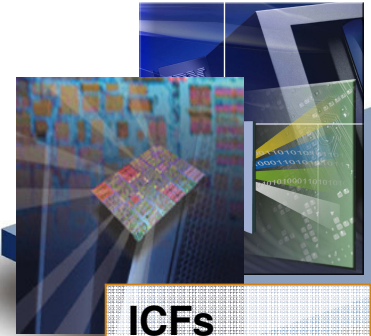
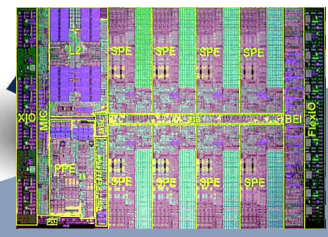

ICFs
IFLs
zAAPs
zIIPs



z10
The worlds most powerful enterprise computing platform
Performance
Capacity
Resilience
Responsiveness
LOW COST OF OWNERSHIP

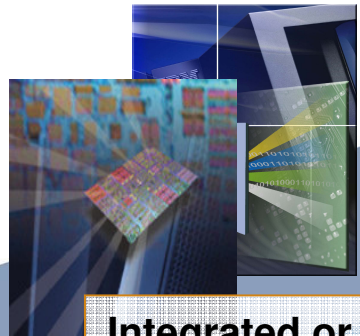

Integrated or network attached Accelerators
Delivering new functionality
Increasing efficiencies
Enabling new solutions

The next evolution of IBM Mainframe computers
Integrating and managing architectures to provide the most efficient and effective delivery of IT capability

System z10 Can Do It All - Smart, Cool, Affordable



- **Leadership capabilities for the new enterprise data center**
- **Smart technology for all enterprises**
- **A modern, energy efficient platform to help you save big through consolidation**
- **New business growth opportunities with an expanded range of affordable solutions**

The Future runs on System z

System z – going forward

- Continue to extend leadership in enterprise computing capabilities
- Expand system z's role in the New Enterprise Data Center
- Enable an expanded set of workloads and new applications
- Strengthen position in cloud computing



The Future Runs on System z



Thank You !!!!!



Trademarks

The following are trademarks of the International Business Machines Corporation in the United States and/or other countries.

| | | |
|--------------|-------------------|----------------|
| DB2* | IBM eServer | System z10 |
| Cool Blue | IBM logo* | Tivoli* |
| DRDA* | OMEGAMON* | WebSphere* |
| DS8000 | Parallel Sysplex* | z9 |
| ESCON* | ResourceLink | z10 |
| FICON* | System p | zArchitecture* |
| FlashCopy* | System Storage | z/OS* |
| GDPS* | System x | z/VM* |
| HiperSockets | System z | z/VSE |
| HyperSwap | System z9* | zSeries* |
| IBM* | | |

* Registered trademarks of IBM Corporation

Adobe, the Adobe logo, PostScript, and the PostScript logo are either registered trademarks or trademarks of Adobe Systems Incorporated in the United States, and/or other countries.

Cell Broadband Engine is a trademark of Sony Computer Entertainment, Inc. in the United States, other countries, or both and is used under license there from.

Java and all Java-based trademarks are trademarks of Sun Microsystems, Inc. in the United States, other countries, or both.

Microsoft, Windows, Windows NT, and the Windows logo are trademarks of Microsoft Corporation in the United States, other countries, or both.

InfiniBand is a trademark and service mark of the InfiniBand Trade Association.

Intel, Intel logo, Intel Inside, Intel Inside logo, Intel Centrino, Intel Centrino logo, Celeron, Intel Xeon, Intel SpeedStep, Itanium, and Pentium are trademarks or registered trademarks of Intel Corporation or its subsidiaries in the United States and other countries.

UNIX is a registered trademark of The Open Group in the United States and other countries.

Linux is a registered trademark of Linus Torvalds in the United States, other countries, or both.

ITIL is a registered trademark, and a registered community trademark of the Office of Government Commerce, and is registered in the U.S. Patent and Trademark Office.

IT Infrastructure Library is a registered trademark of the Central Computer and Telecommunications Agency, which is now part of the Office of Government Commerce.

Notes:

Performance is in Internal Throughput Rate (ITR) ratio based on measurements and projections using standard IBM benchmarks in a controlled environment. The actual throughput that any user will experience will vary depending upon considerations such as the amount of multiprogramming in the user's job stream, the I/O configuration, the storage configuration, and the workload processed. Therefore, no assurance can be given that an individual user will achieve throughput improvements equivalent to the performance ratios stated here.

IBM hardware products are manufactured from new parts, or new and serviceable used parts. Regardless, our warranty terms apply.

All customer examples cited or described in this presentation are presented as illustrations of the manner in which some customers have used IBM products and the results they may have achieved. Actual environmental costs and performance characteristics will vary depending on individual customer configurations and conditions.

This publication was produced in the United States. IBM may not offer the products, services or features discussed in this document in other countries, and the information may be subject to change without notice. Consult your local IBM business contact for information on the product or services available in your area.

All statements regarding IBM's future direction and intent are subject to change or withdrawal without notice, and represent goals and objectives only.

Information about non-IBM products is obtained from the manufacturers of those products or their published announcements. IBM has not tested those products and cannot confirm the performance, compatibility, or any other claims related to non-IBM products. Questions on the capabilities of non-IBM products should be addressed to the suppliers of those products.

Prices subject to change without notice. Contact your IBM representative or Business Partner for the most current pricing in your geography.