



The New Face of Application Development for System z

A. Hayden Lindsey
IBM Distinguished Engineer
Director, Rational Enterprise Tools & Compilers



Agenda

- Key messages – What you need to know
- Today's realities – What you have and what you want
- The IBM SDP – How you get started today
- Version 7 - What was delivered
- The Future - What is coming next



Agenda

- **Key messages – What you need to know**
- Today's realities – What you have and what you want
- The IBM SDP – How you get started today
- Version 7 - What was delivered
- The Future - What is coming next



Key Messages – What you need to know

- ✓ Businesses need to change to stay viable, and IT must enable it

- ✓ To be sufficiently nimble, one must overcome challenges such as
 - Complex, tightly-coupled architectures
 - Large variety of middleware to exploit
 - Many technologies to learn
 - Separate infrastructure for enterprise vs. distributed

- ✓ The IBM Software Delivery Platform provides world-class application development support for System z
 - Development & deployment of SOA solutions is easy and efficient
 - IBM provides the integrated tools, team infrastructure and governance platform to help your existing and future staff productivity create new solutions and also maintain the existing applications that run your business



Agenda

- Key messages – What you need to know
- **Today's realities – What you have and what you want**
- The IBM SDP – How you get started today
- Version 7 - What was delivered
- The Future - What is coming next



Enterprise pressures and opportunities – What you see

commoditization pressures

new/increased competition

global market opportunities

adjacent market opportunities

global volatility & disruption

competing business models

CEOs: Extent of fundamental
change needed over next two years

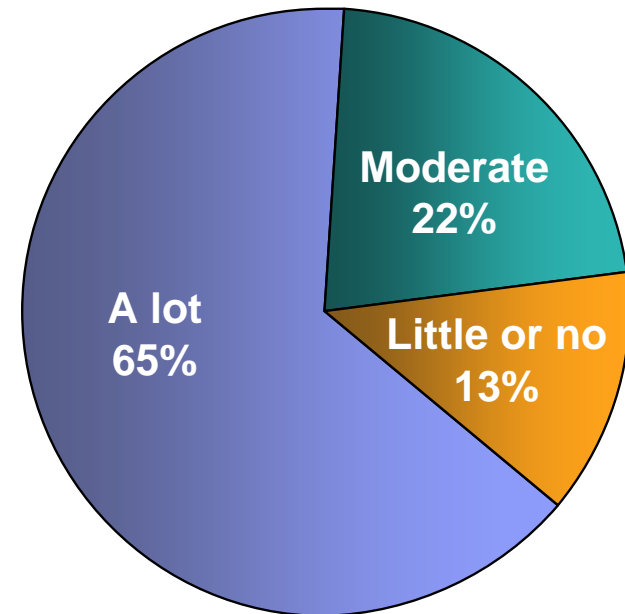

... and 83% think its likely that changes in a competitor's business model will change their industry

Marketplace destabilization – What you see

- ▶ *Technology* systematically reduces interaction costs and extends global reach
- ▶ *Globalization* increases complexity of business requirements and IT agility
- ▶ Constant global policy shifts alter *regulatory* and competitive climates
- ▶ Intense pressure on *business models* drives focus on core competencies

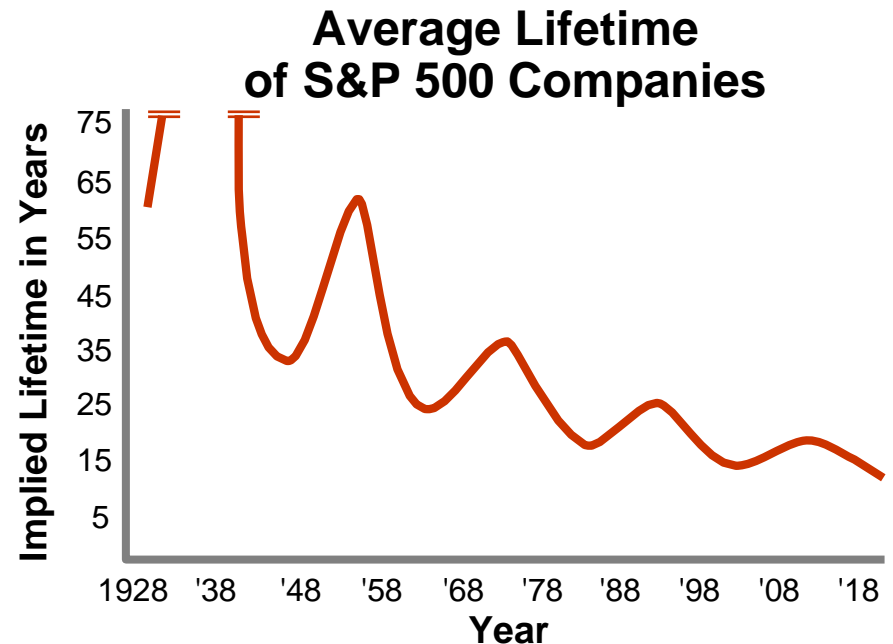

Source: *Creative Destruction*, by Richard Foster

Destabilizing forces converge to significantly intensify global competition

Today's realities – What you have

Complex, tightly coupled architectures

“Today’s IT architectures, arcane as they may be, are the biggest roadblocks most companies face when making strategic moves.”

The *McKinsey Quarterly* Special to CNET News.com,
 “Flexible IT, Better Strategy”, January 24, 2004



- ▶ Lack of flexibility
- ▶ Infrastructure built with no roadmap
- ▶ Inability to manage change and impact
- ▶ Lack of traceability through IT infrastructure

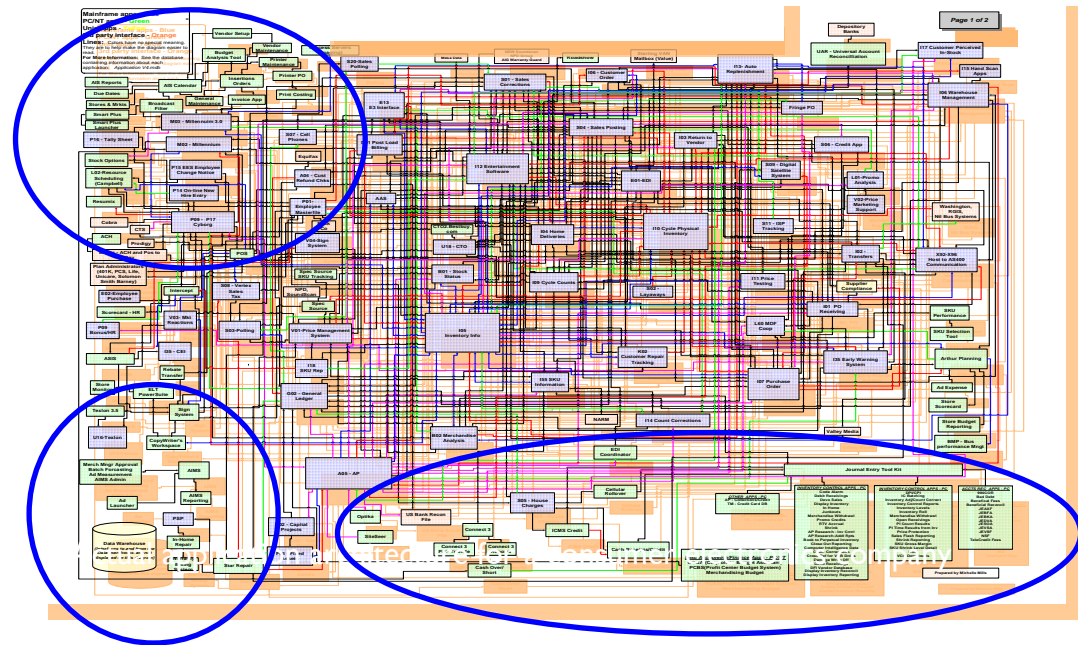

Legend: Blue = System z

Today's realities – What you have

Large variety of middleware

- ▶ In contrast to physical computing
 - Software evolution is constrained by decades of legacy code
 - Agility is constrained by layers
 - Value comes in automation of new business abstractions, rules and models
- ▶ Chaos results from
 - Multiple generations of 'captured intelligence' in the form of code / business rules
 - Mixed with new generations of technology assumptions (mainframe to C/S to peer distributed – and variants)
- ▶ Software archeology or software architecture?

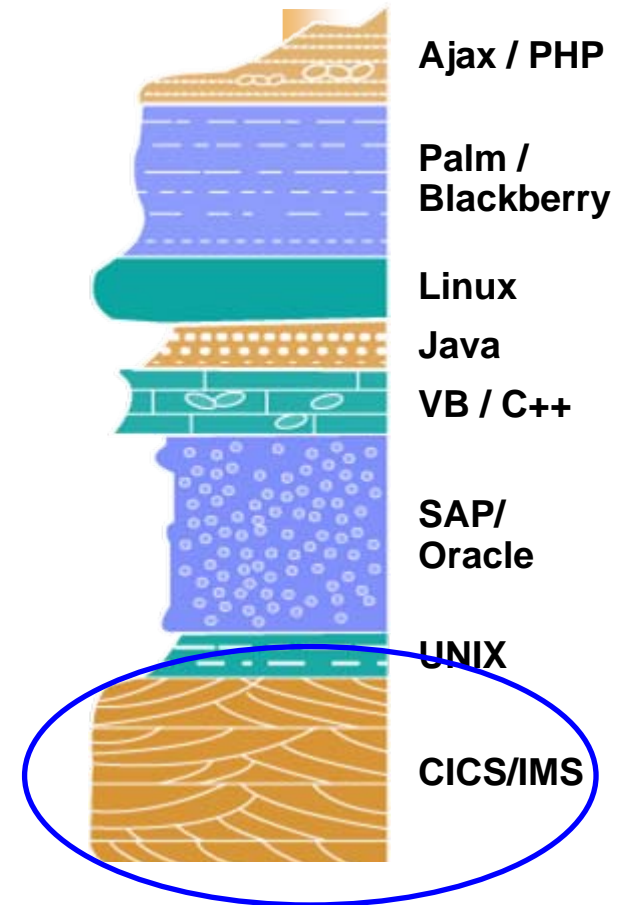

Source: *"The Agile Dance of Architectures"*, by John Hagel, III and John Seely Brown

Today's realities – What you have

Many technologies; who has the skills?

- ▶ Dwindling IT skills to maintain legacy applications
- ▶ Difficulty attracting new development talent
- ▶ System z innovation (e.g. zAAP) cannot be exploited without having to retrain traditional developers to Java
- ▶ Skills islands and team silos not conducive to efficient communication, productivity, and flexible resource allocation

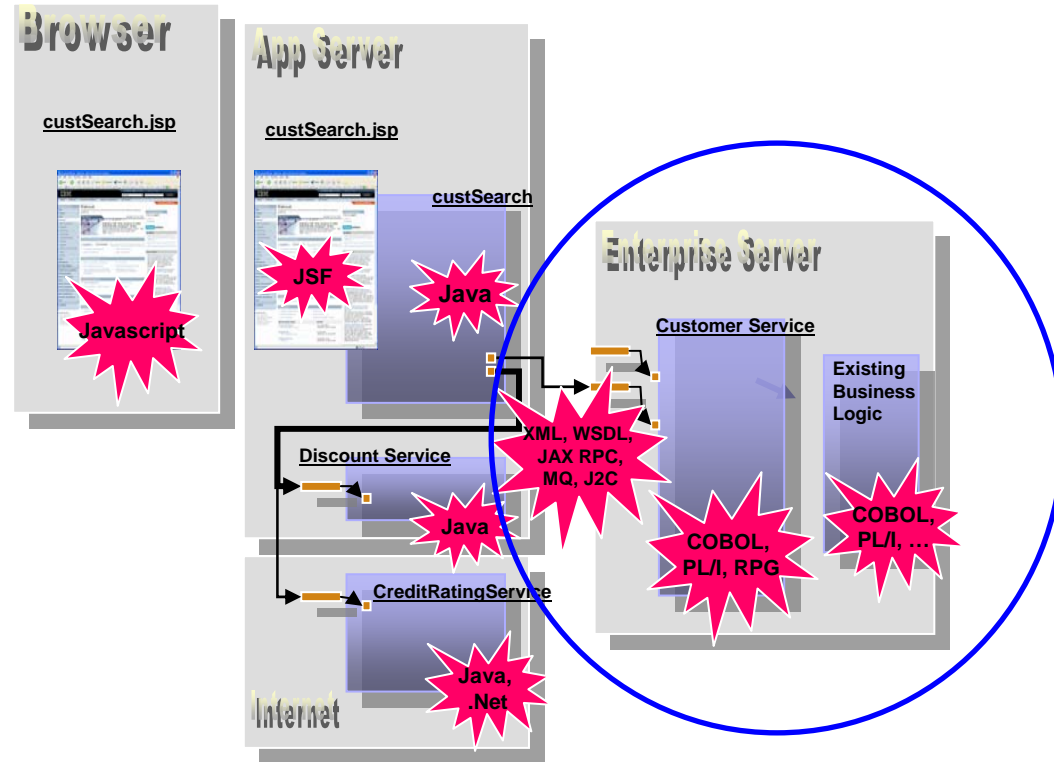

"200 Billion lines of COBOL code in existence" [eWeek](#)

"5 Billion lines of COBOL code added yearly" [Bill Ulrich, TSG Inc.](#)

"2 Million COBOL developers" [Gartner](#)

Today's realities – What you have

Islands of development for enterprise and distributed

- ▶ Unique processes for each island; poor communication between islands
- ▶ Best practices and processes not shared across islands
- ▶ Different tools and infrastructure create skill inflexibility, which inhibits IT flexibility
- ▶ Financial burden to maintain two infrastructures

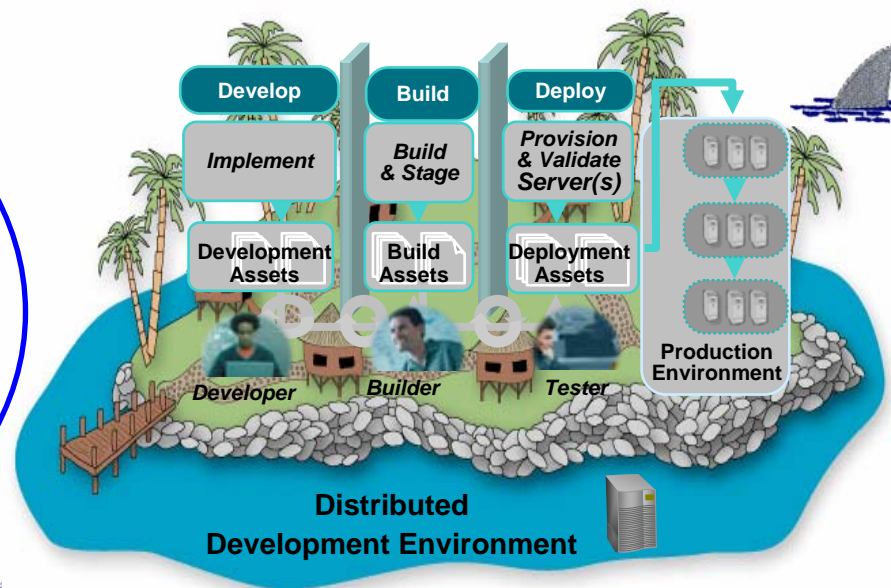
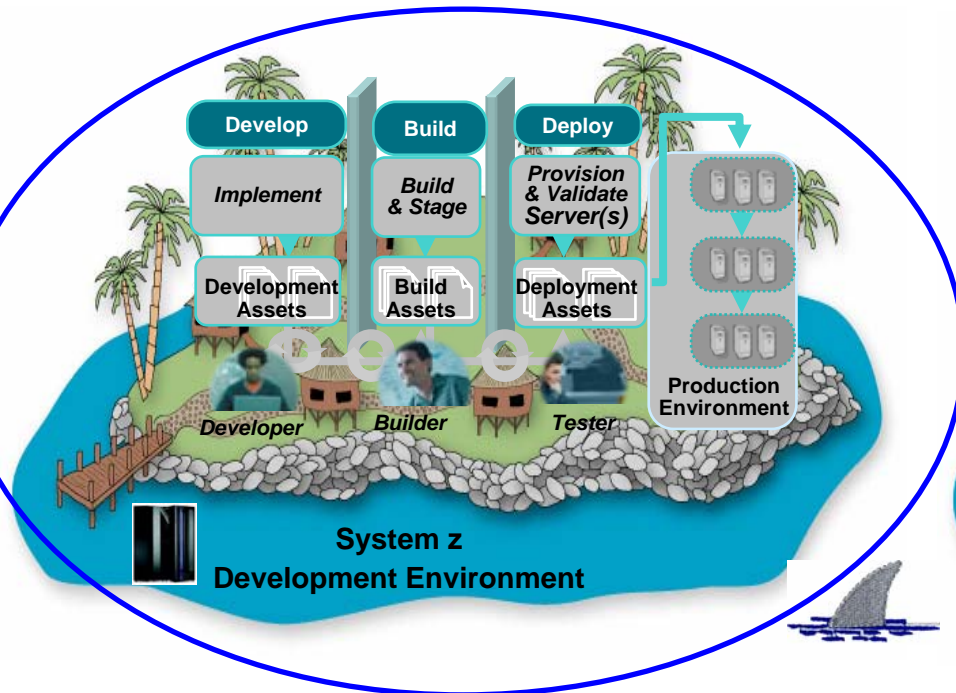

Future State – What you want

Flexible architectures to enable business agility

- ▶ Reuse existing highly stable code that embodies enterprise business logic, data access
- ▶ Service-enable this business logic for wider use and value
- ▶ Separate service flow from service implementation to attain optimal flexibility
 - ▶ For example, to support outsourcing or use of supplier-provided services

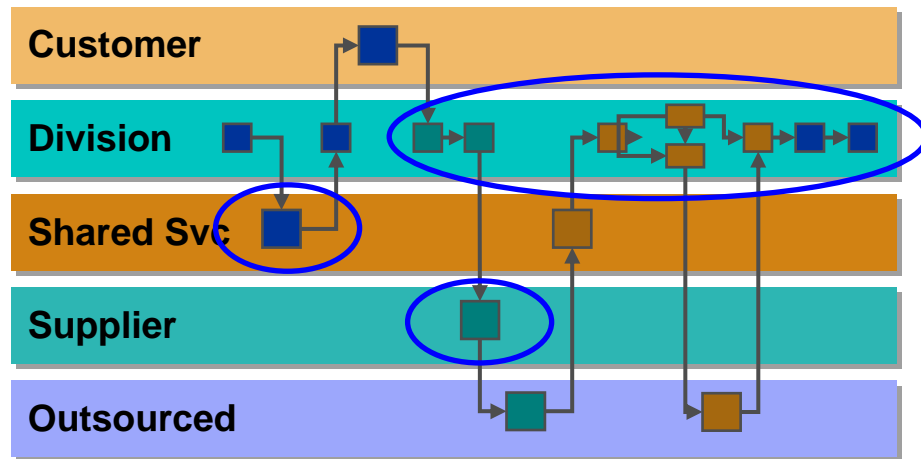
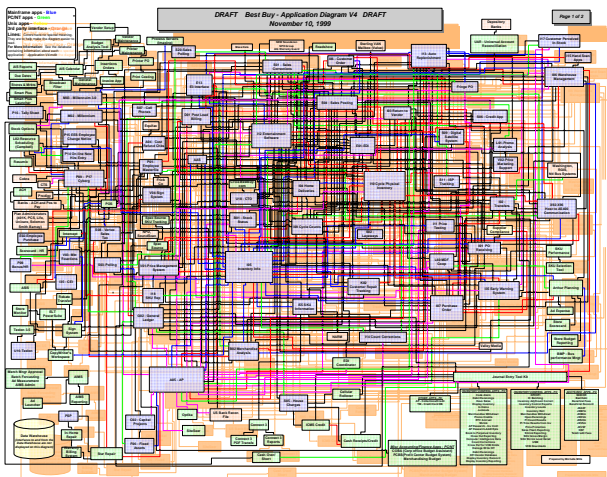

Future State – What you want

Discovery tools to identify, understand, and reuse assets

- ▶ Extract value hidden within existing code via discovery and analysis
- ▶ Understand breadth of usage and criticality to business
- ▶ Gain insight into potential impact of changes once application inventory built

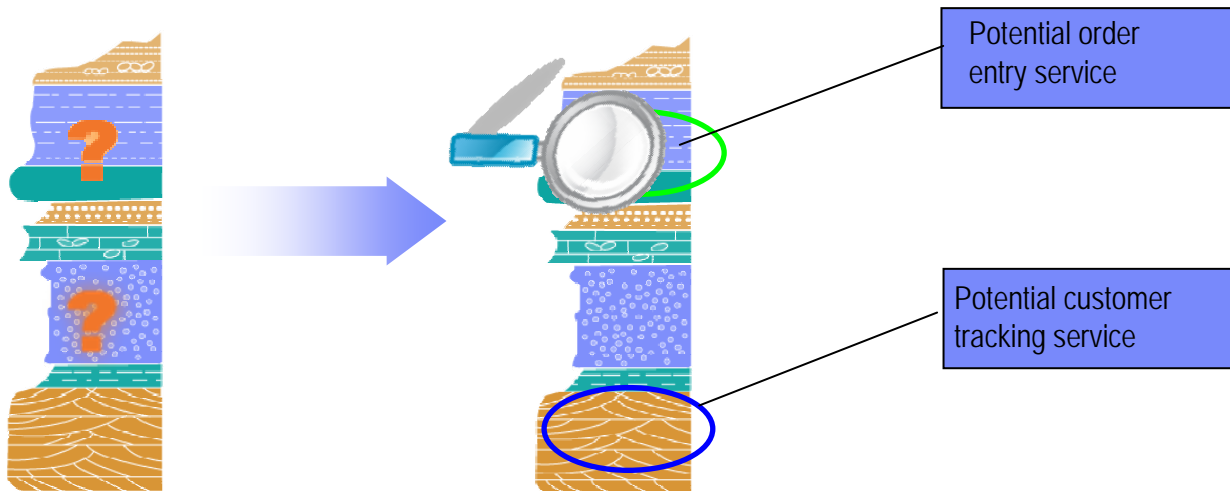

Future State – What you want

Powerful tools and abstractions to harness current employee skills

- ▶ Exploit new technologies without retraining your staff
- ▶ Use high-level abstractions to hide underlying middleware complexity
- ▶ Standardize on common processes and tools to improve productivity and communication
- ▶ Leverage tool advisors and best practices to “do it right” the first time

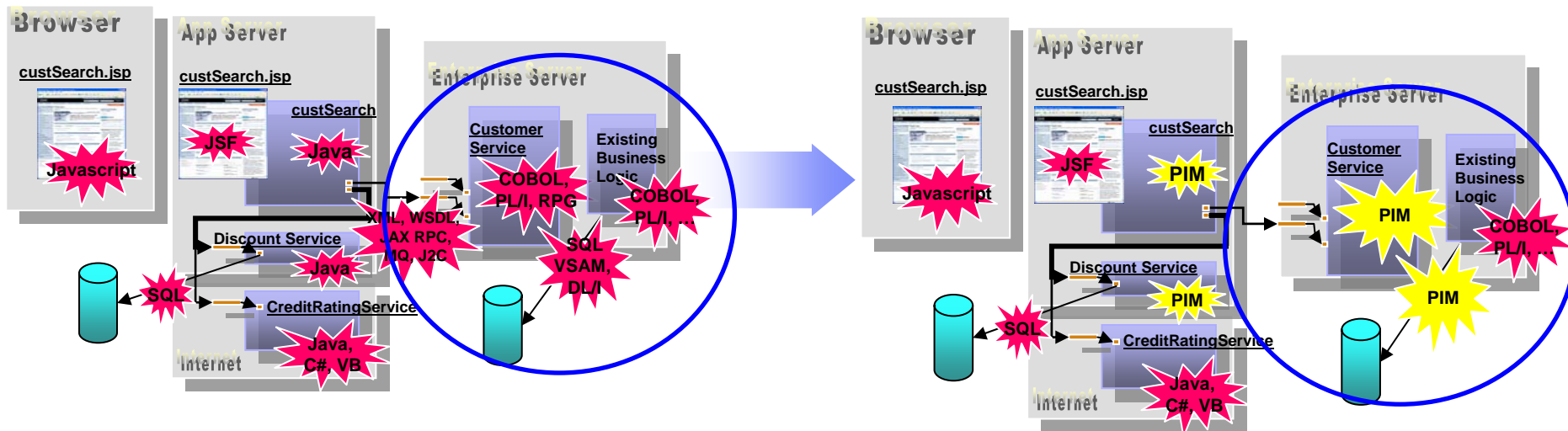

PIM = Platform Independent Model

Future State – What you want

Shared development environments for enterprise and distributed

- ▶ Exploit single infrastructure for enterprise and distributed development environments
- ▶ Benefit from lower costs due to elimination of duplicate tools and processes
- ▶ Realize improved end-to-end communication and traceability
- ▶ Improve IT flexibility because employee skills can be leveraged across organization

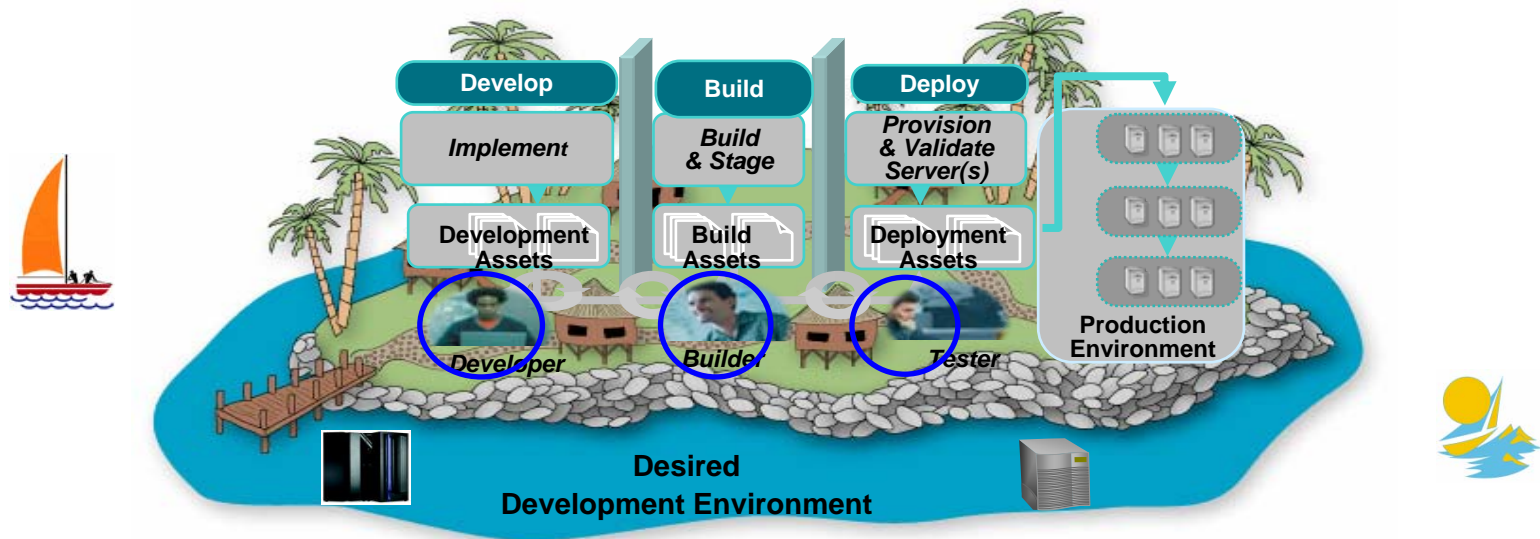

Future State – What you want

Customers are maturing their approach to software delivery

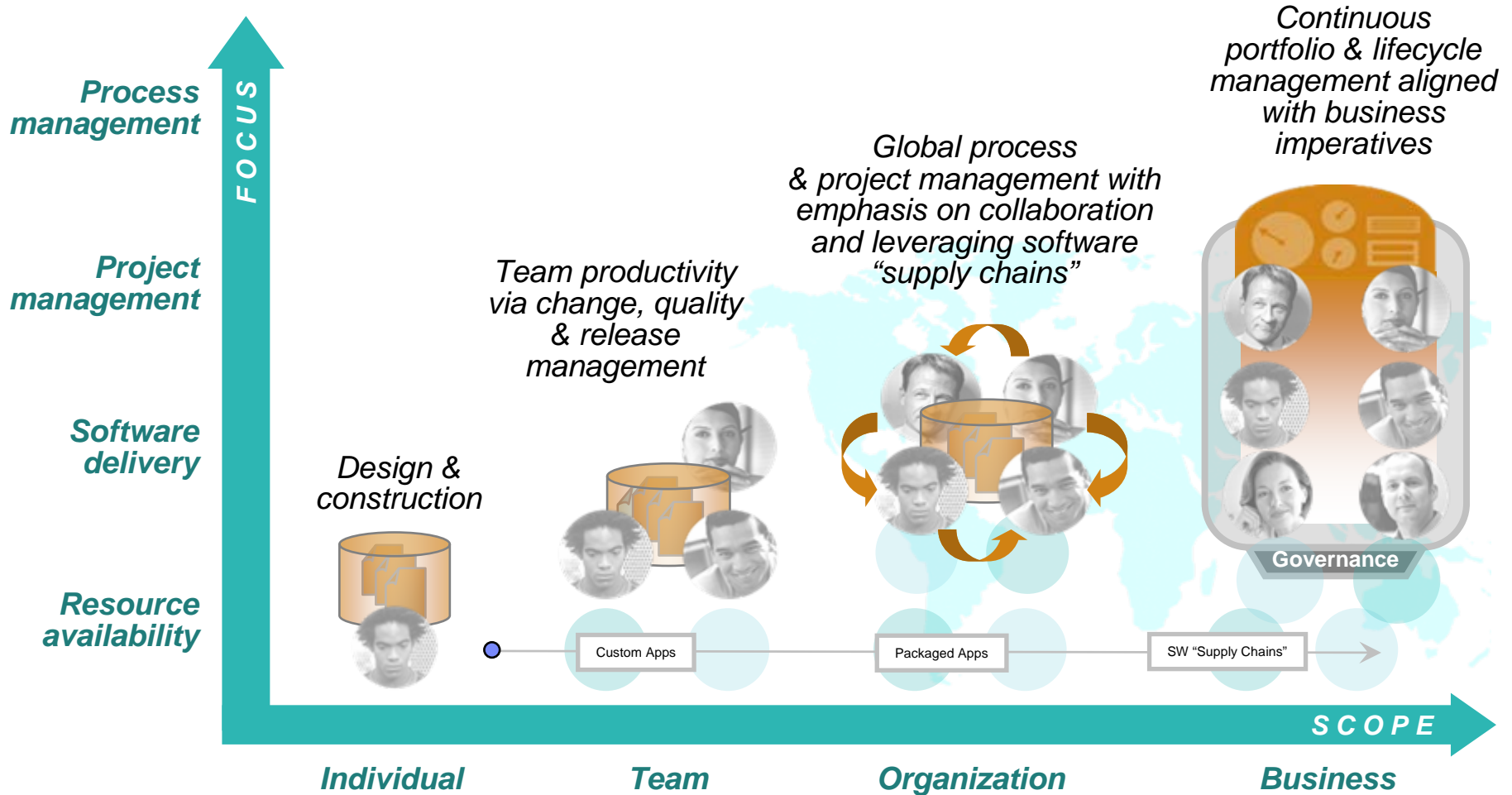

Agenda

- Key messages – What you need to know
- Today's realities – What you have and what you want
- **The IBM SDP – How you get started today**
- Version 7 - What was delivered
- The Future - What is coming next



The IBM Software Delivery Platform – How you get started today

Enable predictable, integrated, cross-platform software delivery

Extending the IBM Software Delivery Platform to System z

▶ Improve developer productivity & reduce costs

- Common processes & tools regardless of deployment platform provide greater team flexibility, productivity
- Fewer tools means lower support & training costs
- New tools support modern architecture and technologies (e.g. SOA, rich web UIs) to create new business value

▶ Enhance quality & flexibility of your solutions

- Tools facilitate application discovery, understanding and re-factoring to extract value from existing code
- Model-driven development & SOA tools exploit latest in productivity, quality and flexible architectures
- Best practices and integrated tool advisors help you “do it right”

▶ Effectively govern enterprise development

- Dashboards for identifying and managing project risk, monitoring and managing runtimes aid decision-making
- Converged source code libraries & change management facilitate end-to-end solution development

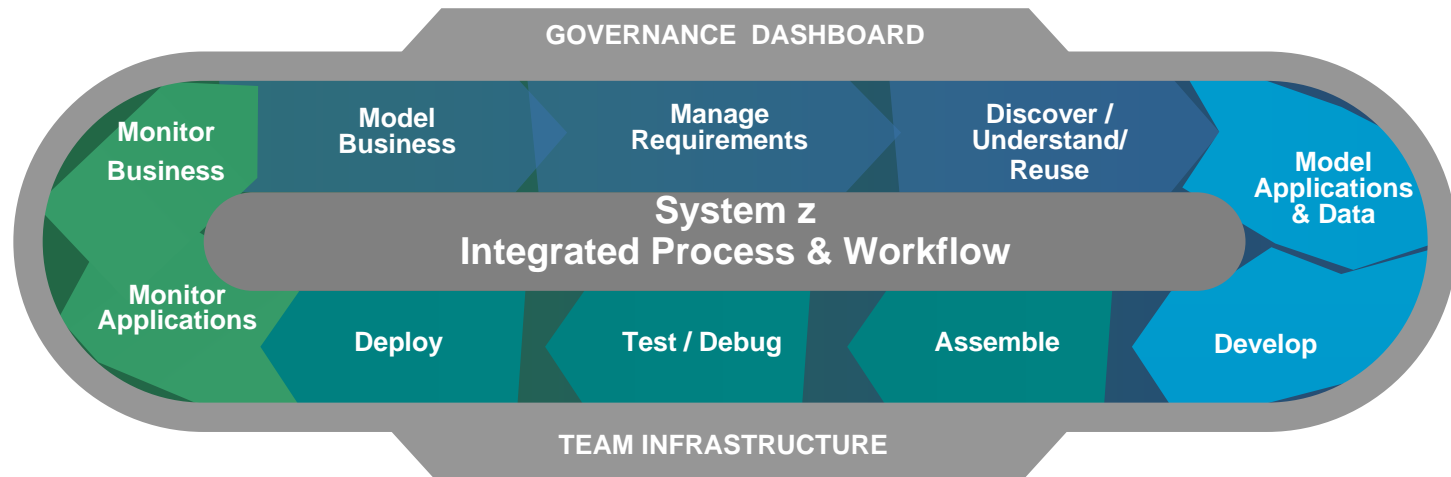

ISPF was good yesterday...the SDP carries you into the future...

SDP Solutions for Systems z – How you get started today

Proven solutions to meet your needs

- ★ **Enterprise Modernization** – help business developers rapidly develop sophisticated, multi-platform, end-to-end applications, user interfaces, and services (SOA) that harness enterprise technology with little knowledge of the underlying middleware
- ★ **Enterprise Application Transformation** – transform legacy applications into EGL in order to modernize, service-enable (SOA), and exploit the full value of the SDP
- ★ **Reuse and Productivity** – identify assets for reuse, develop in a highly productive IDE, and create services, while leveraging existing developer skills and exploiting new technologies
- ★ **IT Governance for System z** – ensure compliance & implement effective governance for cross platform application development by consolidating onto the industry-leading team infrastructure

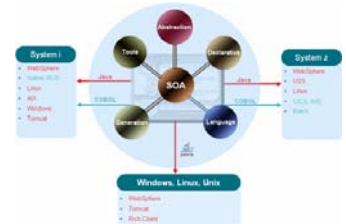

SDP Solutions for System z

Modernize Enterprise Applications and User Interfaces

Scenario:

We need a flexible infrastructure that allows us to build innovative solutions, while achieving high application development productivity, enabling quick transition of business developers to modern technologies (e.g. SOA, J2EE) and facilitating the reuse and extension of valuable existing IT assets without being locked-in to specific computing environments. We face the following challenges

- ▶ New applications requirements continue to grow while the available resources and budgets remain flat
- ▶ Business solutions are usually built according to the know-how of the developer pool, or have to be outsourced when requirements dictate new platforms or middleware choices
- ▶ Modern middleware provides business value but their technical complexities tend to increase training, development and maintenance costs
- ▶ Skills islands and team silos not conducive to efficient communication, productivity, flexible resource allocation

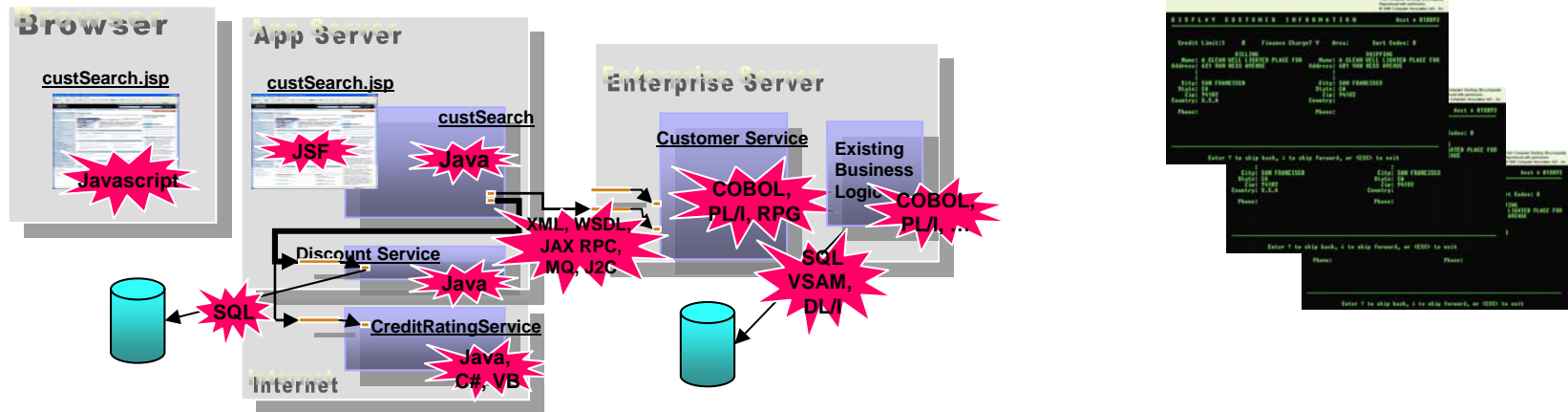

SDP Solutions for System z

Modernize Enterprise Applications and User Interfaces



Solution:



- ▶ **Rational Business Developer extension (RBDe)**, with support for Enterprise Generation Language (EGL) – IBM's modern business language
- ▶ **Host Access Transformation Services (HATS)** – Transform green screen applications to HTML interfaces

Solution Benefits:

- ▶ Deliver functions to the business despite resource constraints, helping business competitiveness and efficiency
- ▶ Respond to business requirements regardless of available skills mix; do not compromise solutions or budget for costly outsourcing when you could use in house resources
- ▶ Contribute to the company's bottom line by reducing developer's training costs and lower development and maintenance costs
- ▶ Transform existing applications and interfaces into modern web solutions

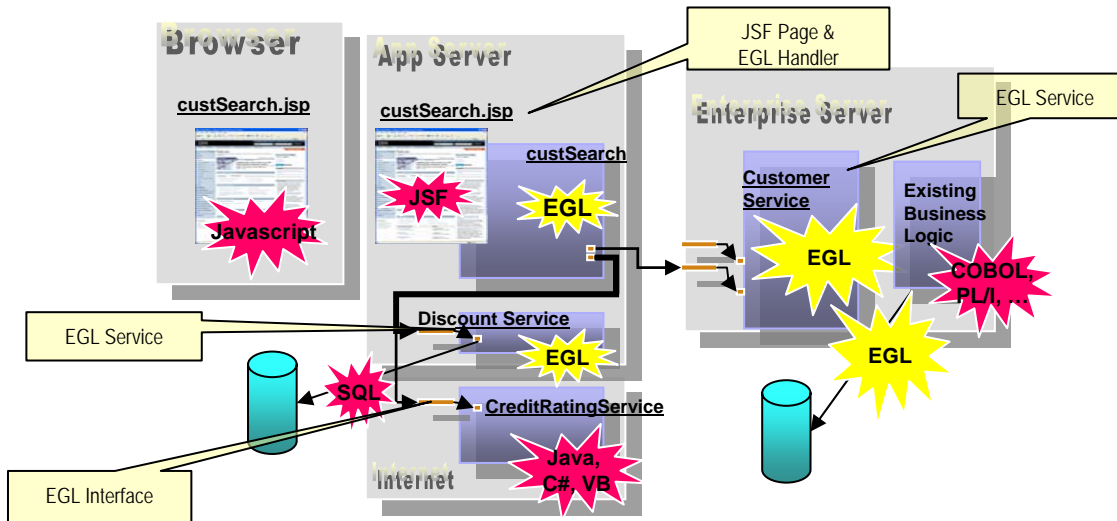

Background:

- ▶ Belgian Bank & Insurance company. 50000 employees, 12 million clients across Central Europe
- ▶ Numerous acquisitions, expect to continue.

- **Solution: EGL** – unify application development across all platforms and transaction managers (e.g. WAS, IMS)

"...we want to avoid the "skill silos", what we really need is a large group of general developers who should not worry about target platforms and focus on developing business components, and only a small number of technology specialists, so that we can swiftly allocate general developers to upcoming business needs....EGL is helping us achieve this goal.."

Lieven.Gouwy IT Architect,
KBC,Redmonk Podcast



The Power of Services

EGL: cross platform language for business oriented services development

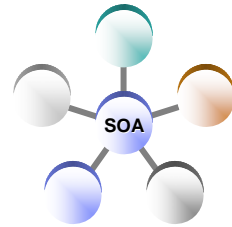

At development time...

- Focus on the business logic
- Implement SOA design elements: services and interfaces
- Leverage existing business developers for new SOA development
- Ignore deployment targets/technology while coding/testing

Leverage external web services...

- EGL Interfaces
 - Represent external web services
 - Are created via import from WSDL
 - Allow the EGL developer to stay within the context of the EGL programming model

Deploy EGL services...

To any platform

- Java to WAS/Tomcat/etc.
- COBOL to CICS, System i (1Q 2007)
- COBOL to IMS (2H 2007)

As...

- A Web service (uses SOAP)
- A private service (uses CICS ECI or TCP)
- Other SOA runtimes when they reach critical mass

Deploy Services as Web Services

EGL SOA for WAS, CICS, System i

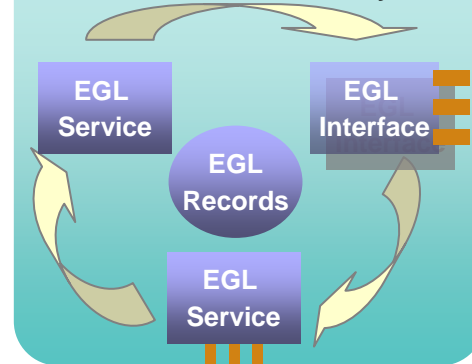

Consume external services

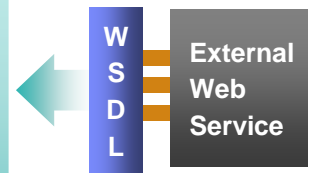

External Applications

SDP Solutions for System z

Enterprise Application Transformation



Scenario:

Customers have large investments in critical legacy software systems and need to transform the applications to provide a platform to adopt modern architectures, such as SOA, while leveraging existing application business logic.

Both groups face the following challenges:

- ▶ High maintenance costs for legacy software applications
- ▶ Inability to adopt new and emerging application architectures (i.e. SOA with existing development tools and application architecture)
- ▶ Dwindling IT skills to maintain legacy applications
- ▶ Difficulty in attracting new development talent

***"There are many benefits to Legacy Modernization tools and they significantly reduce the risk of failure when maintaining or transforming aging legacy systems."
Dale Vecchio, Research Director - Gartner***

System z

- ▶ Natural/ADABAS
- ▶ CA Tools
- ▶ Cool:Gen
 - Cool:Enterprise
 - Ideal
 - Telon
- ▶ HPS AppBuilder
- ▶ Maestro
- ▶ CSP
- ▶ VisualAge Generator
- ▶ VisualAge Pacbase

SDP Solutions for System z

Enterprise Application Transformation



Solution:

- ▶ Automated Enterprise Application Transformation on existing application code targeting the IBM SDP:
 - **Rational Business Developer extension (RBDe)**, with support for Enterprise Generation Language (EGL) – IBM's modern business language

- ▶ **Rational Software Services and IBM Rational Business Partner Services** - for education, knowledge transfer, Proof of Concepts, application implementation, testing and deployment

Solution Benefits:

- ▶ **Reduce costs** – Reduce or eliminate maintenance costs
- ▶ **Business flexibility** – Provide architecture to easily adopt new middleware and modern application architectures
- ▶ **Preserve existing productivity** – Preserve development productivity with similar high-level business language
- ▶ **Exploit employee business domain knowledge** – Eliminate re-staffing and retraining costs
- ▶ **Reduce risk** – Automate conversion of applications to EGL without rewriting code
- ▶ **Increase competitive advantage** – Leverage software as the critical differentiator for providing new services and opening new markets.
- ▶ **Modernize at your pace** – integrate new technology, convert to EGL, refactor and reuse existing code

Background:

- ▶ A Leading International Airline Maintenance, Repair and Overhaul company
- ▶ Rapid growth and expansion of services

Solution:

- ▶ **Enterprise Application Transformation** of existing Natural/ADABAS system to EGL, DB2 and WebSphere.
 - 30M lines of Natural code
 - New UI interface required
 - Complete ADABAS to DB2 migration

SDP Solutions for System z

Reuse and Productivity

Scenario:

- ▶ We are committed to SOA. We need a development lifecycle infrastructure that provides immediate value and grows with us as we mature.
- ▶ We need to move away from rigid technologies that lack flexibility to move forward (e.g. ISPF). We have limited budget to train our enterprise experts in new architectures.
- ▶ We need to improve quality by enhancing our ability to gauge application completeness end-to-end, from requirements to production.
- ▶ We need to create test environments, test, and find and fix problems quickly, while reducing costs.
- ▶ We need to improve our IT throughput by improving our ability to manage, change, and reuse application assets.

"I want to reuse key parts of my mainframe applications in a SOA, but how do I get there from here?"



"I can't afford to rewrite my applications for these new web applications or find it hard to integrate them together."

"Many of my experienced mainframe developers are retiring or leaving."



"We've accumulated 20 to 40 years of changes to our valuable applications, but I don't have reliable documentation of them."

SDP Solutions for System z

Reuse and Productivity



Solutions:

▶ For Discovery, Understanding, and Reuse:

- **WebSphere Studio Asset Analyzer (WSAA)** – perform impact analysis across the enterprise
- **Asset Transformation Workbench (ATW)** – perform pattern identification, extract business rules, assess suitability for reuse in SOA
- **Rational Asset Manager (RAM)** – manage reusable assets during development
- **WebSphere Service Registry & Repository (WSRR)** – store, access, and manage info. about services
- **CICS Interdependency Analyzer (CICS IA)** – capture interdependency information and analyze transaction affinities



▶ To Develop applications:

- **Rational Application Developer (RAD)** – develop J2EE & web applications for WebSphere
- **Rational Business Developer extension (RBDe)** – develop J2EE, web, LUW, System z, and System i solutions
- **WebSphere Developer for System z (WDz)** – RAD and COBOL + PL/1 + CICS + IMS + Batch



Solution Benefits:

- ▶ Modern, highly productive development environment
- ▶ Ability to leverage existing IT assets
- ▶ Support for all languages and platforms needed for end-to-end solution

■ Background:

COMMERZBANK 

- ▶ German Bank providing financial services to private companies and small/medium businesses across Europe
- ▶ Leading provider of online banking services.

- **Challenge:** upgrade teller workstations and ensure they continue to work with existing 3rd-party customer COBOL runtime environment.

■ Solution:

- ▶ New application framework based on **IBM COBOL standard**
- ▶ **WDz** to design new COBOL/other code

“In one tool, we have a single development environment for multiple environments. I don’t have to jump between different tools to do different tasks. The tool is very complete.”

— Armin Schiller, Transaction Banking Payments and Cash Transactions, Commerzbank AG

SDP Solutions for System z

IT Governance

Scenario:

Process and organizational islands separate Enterprise & Distributed IT teams and supporting infrastructure produce the following challenges:

- ▶ Lack of end-to-end traceability for all enterprise application artifacts
- ▶ Unique processes for each island; poor communication between islands
- ▶ Best practices and processes not shared across island
- ▶ Different tools and infrastructure create skill inflexibility, which inhibits IT flexibility
- ▶ Geographic distribution exacerbates situation

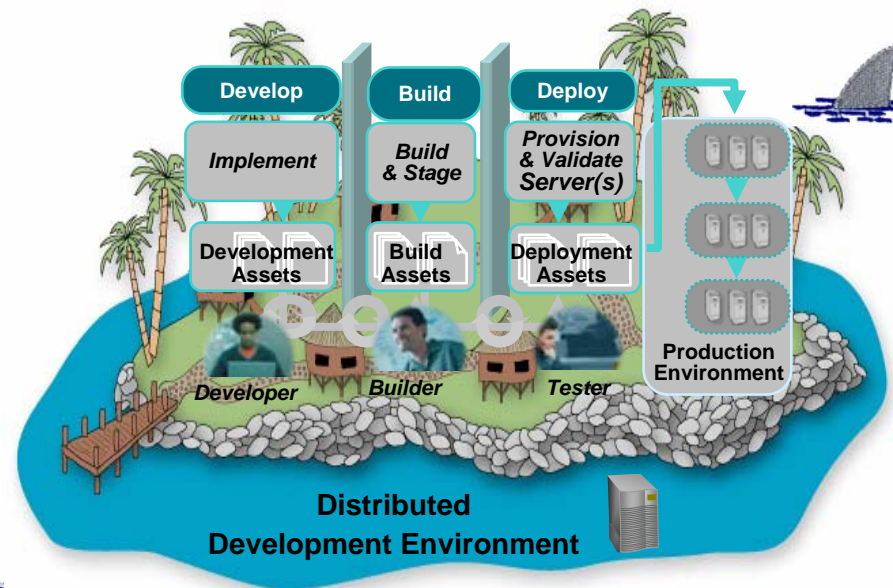
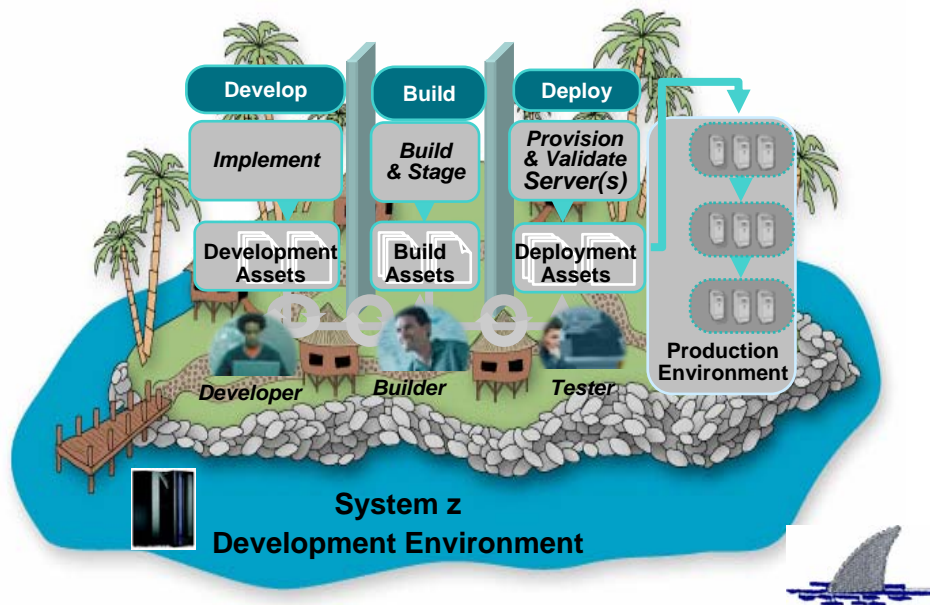

SDP Solutions for System z

IT Governance – Development Processes

Solutions:

- ▶ **Rational Requisite Pro** – requirements management for project teams
- ▶ **Rational Portfolio Manager** – project, portfolio, and resource management with unified dashboard
- ▶ **Rational Method Composer** – leverage expertise in portfolio management, collaborative distributed development, and service oriented architectures
- ▶ **Rational ClearQuest Test Manager** – central console for test activity management, execution, and reporting

Solution Benefits:

- ▶ Increased productivity and lower development costs
- ▶ Higher quality applications
- ▶ Consolidated team infrastructure
- ▶ Address IT governance and compliance requirements

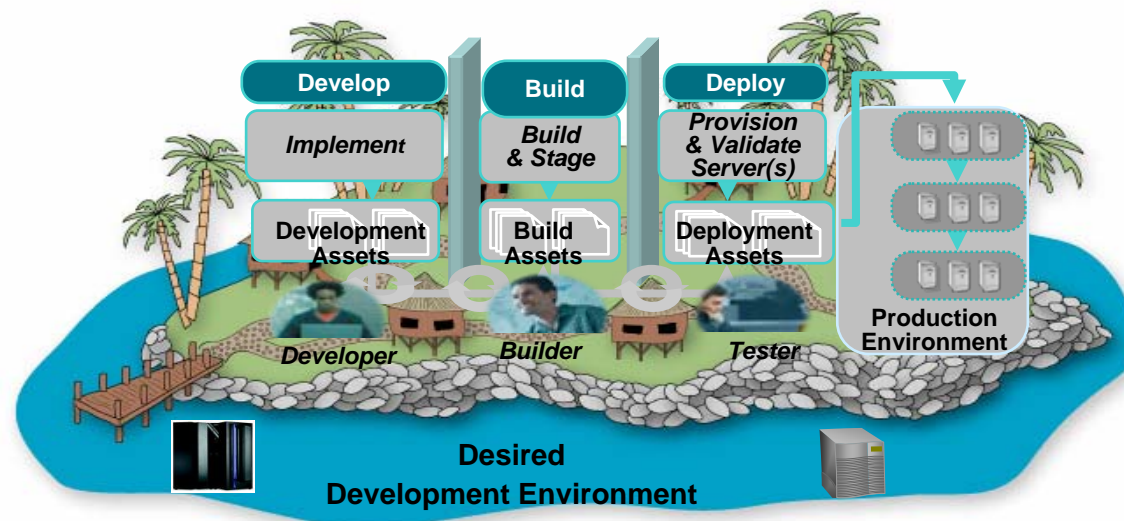

SDP Solutions for System z

IT Governance – Team Processes

Solutions:

- ▶ **Rational ClearQuest** - coordination, traceability and consistency for cross-platform development, testing, and deployment
- ▶ **Rational ClearCase** – version control, parallel development support, build and release management for multiple platforms
- ▶ **Rational Build Forge** – high-performance builds throughout the software lifecycle, including z/OS
- ▶ **SCLM Advanced Edition** – centralized z/OS SCM solution



- ▶ **Background:** Third largest European insurance provider, with worldwide operations and clients.
- ▶ **Challenge:** Minimize the impact of maintenance costs, resource availability, staff turnover, and a lack of documentation standards on the ability to maintain software GGS provides to the Group's companies.
- ▶ **Solution:** Highly automated solution using **ClearCase** to manage and support the software changeover from start to finish.

Solution Benefits:

- ▶ Increased productivity and lower development costs
- ▶ Higher quality applications
- ▶ Consolidated team infrastructure
- ▶ Address IT governance and compliance requirements

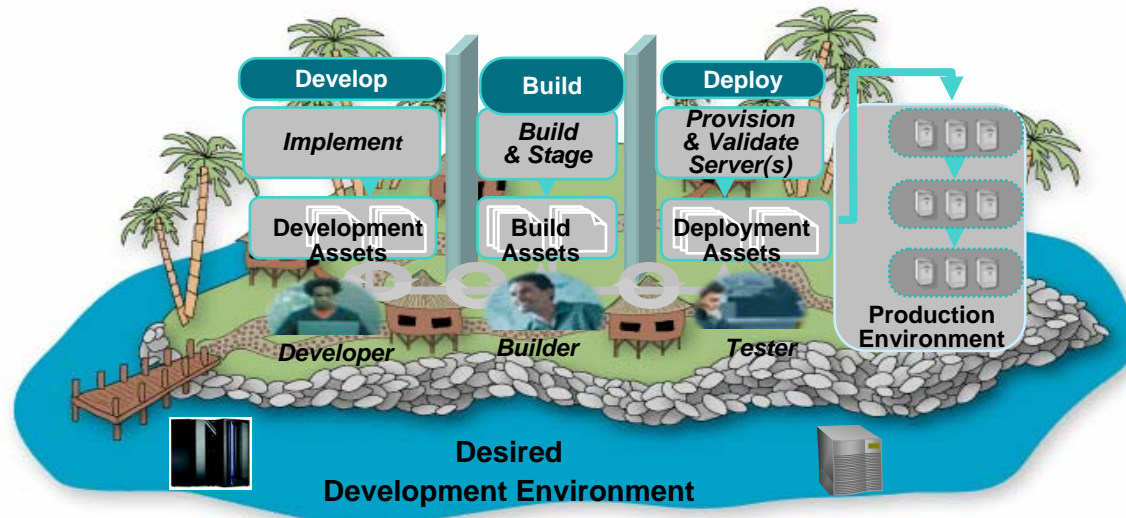

Agenda

- Key messages – What you need to know
- Today's realities – What you have and what you want
- The IBM SDP – How you get started today
- **Version 7 - What was delivered**
- The Future - What is coming next



What's new in Version 7 – Highlights

▶ Rational Portfolio Manager

- ▶ Translation support for globally-distributed development
- ▶ Integration with ClearQuest, allowing RPM to manage work associated with project artifacts

▶ RequisitePro:

- With RSA and RSM, create model elements from requirements
- Better integration with ClearQuest, Rational Software Architect/Modeler, WebSphere Integration Developer, and WebSphere Business Modeler

▶ Rational Software Modeler/Architect:

- Transform models to code and vice versa, for Java, C++, EGL, and COBOL

▶ Rational Application Developer:

- Support for WAS 6.1, WAS for z/OS and WAS for z/Linux (including new Java 5 and Web services tools)
- Support for WebSphere Portal 6.0, Portal for z/OS

▶ WebSphere Developer for System z:

- Support for C and C++
- Generate COBOL from UML
- Improved web services and CICS Service Flow Modeler support

▶ Rational Manual Tester, Rational Functional Tester, Rational Performance Tester:

- Process Advisor to enhance tool experience
- Integration with ITCAM



▶ ClearQuest Test Manager

- Integrated test management provides end-to-end traceability
- Integration with Rational Functional Tester and Rational Performance Tester

▶ ClearCase:

- Improved z/OS usability and security
- Release automation with Tivoli Provisioning Manager

▶ ClearQuest:

- Advanced workflow and activity management
- Build and deployment management and tracking with integration with Build Forge
- Enhanced RequisitePro integration



▶ Build Forge:

- An adaptive build-and-release management framework, helping development teams standardize repetitive tasks, manage compliance mandates, and share information

Many SDP products are platform agnostic so System z and System i users can take advantage of all V7 features

Agenda

- Key messages – What you need to know
- Today's realities – What you have and what you want
- The IBM SDP – How you get started today
- Version 7 - What was delivered
- **The Future - What is coming next**



What is coming next



- ▶ **Rational Business Developer (RBD)** - develop J2EE, web, LUW, System z, and System i solutions



- ▶ **Rational Business Developer Extension (RBDe)** – extension to RAD, RSA, WDz, WDSC/AE to provide RBD functionality for business developers

- ▶ **Rational Portfolio Manager (RPM), RequisitePro, ClearQuest** - support DB2 for z/OS as data store



- ▶ **Rational Unified Process (RUP) for System z** - extension to RUP to describe how to best leverage legacy assets



- ▶ **Rational Asset Manager (RAM)** - manage reusable assets during development



- ▶ **Rational Tester for SOA** – permit functional and performance testing of individual services and business processes

- ▶ **WebSphere Studio Asset Analyzer (WSAA)** – includes improved composite application and web service application support, expanded metrics and application-level information.

Rational. software

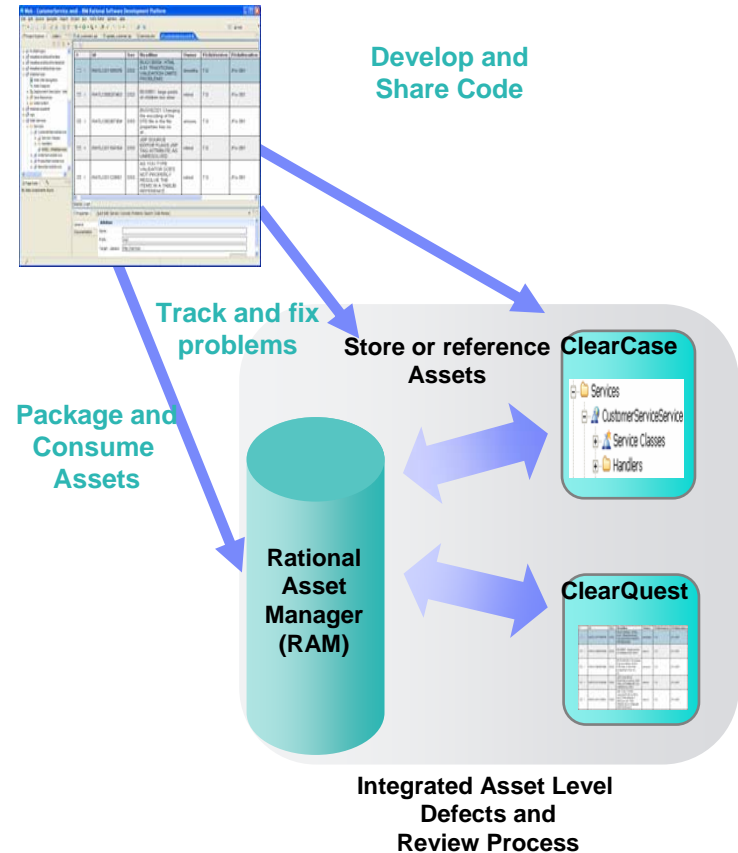

We need your feedback to make the SDP even better

Summary

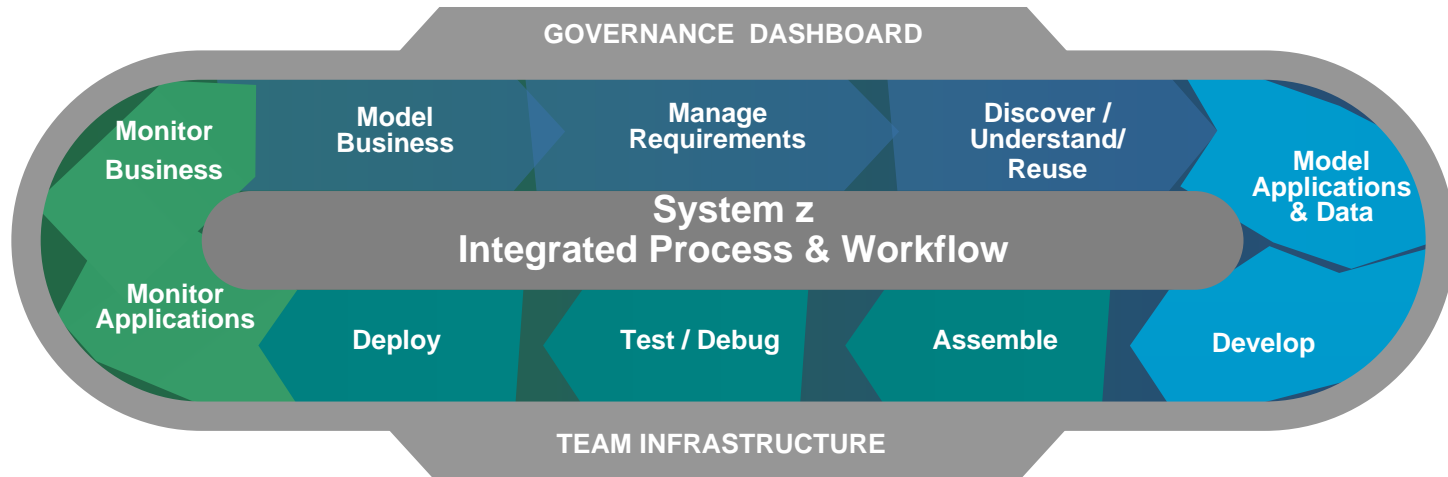

- ▶ The marketplace is undergoing rapid change; IT must adapt by becoming more agile
- ▶ There are many challenges: architectural, middleware and technology complexity; skills gaps
- ▶ The IBM SDP offers leading edge, high productivity solutions to address these challenges
 - for teams as well as for individuals
 - for System z as well as for distributed platforms

You can get started today – We can help!

IBM Rational Software Development Conference



▶ What keeps me **Rational**?



June 10-14 Walt Disney World Swan and Dolphin Orlando, FL

- Over 275 sessions – 12 tracks
- 3 and 5 hour Technical Workshops
- Keynotes with industry leading experts
- Exhibit Hall showcasing complimentary product and services
- Access to IBM engineers and IBM research
- Unlimited network opportunities
- IBM Solution Center
- Interactive Birds-of-a-Feather Sessions
- Luncheon Discussion Tables
- Evening Receptions

Visit:

www.ibm.com/rational/rsdc

for more information

customers and partners

Thank
You