



Simplifying Your IT Infrastructure with the Mainframe and z/OS

Randy Daniel

Director Worldwide System z Marketing



Today's IT Environment

IT environments are increasingly heterogeneous and complex

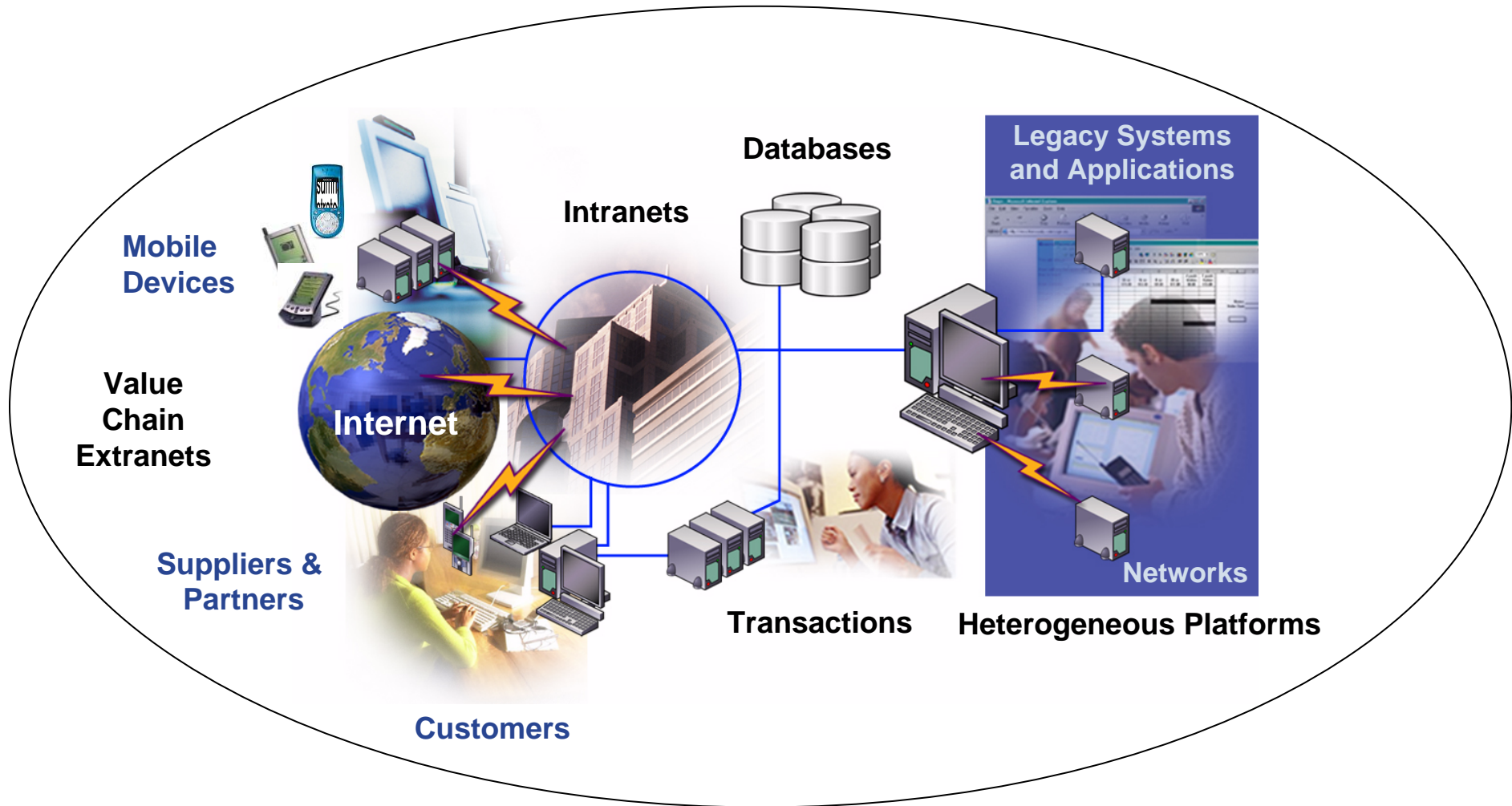

Throughout the past 10 years the cost dynamics of supporting corporate IT infrastructures has changed significantly

We typically see . . .

People expense has tripled as a %
Software expense has doubled as a %
Hardware is less than 1/3 of its original %

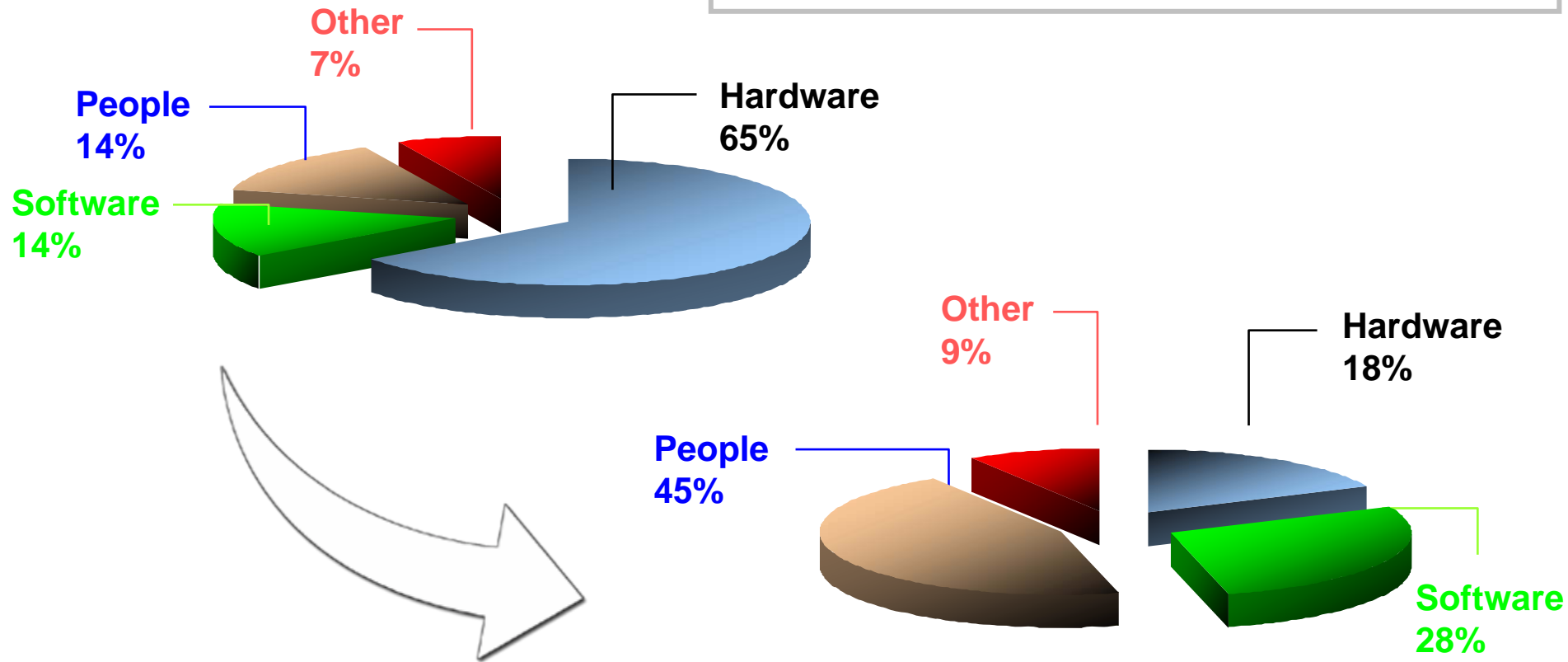

A traditional approach to platform choice for new applications

- Focus on Total Cost of Acquisition (H/W, S/W, Maintenance)
- Focus on short to mid term
- Focus purely on new application IT requirements
- Focus on rollout and growth through adding another server approach
- Platform choice often made with limited input from data center



In today's environment, this approach can further exacerbate the key problems

Key factors affecting platform choice for deployment of new workloads

- Decision cannot be taken in isolation, must take into account existing infrastructure and its current challenges
- Decision should be medium to long term outlook
- Decision should take into account required Quality of Service for all elements of the application
- Decision should take into account all cost elements including implementation, maintenance, ongoing running costs and potential future growth

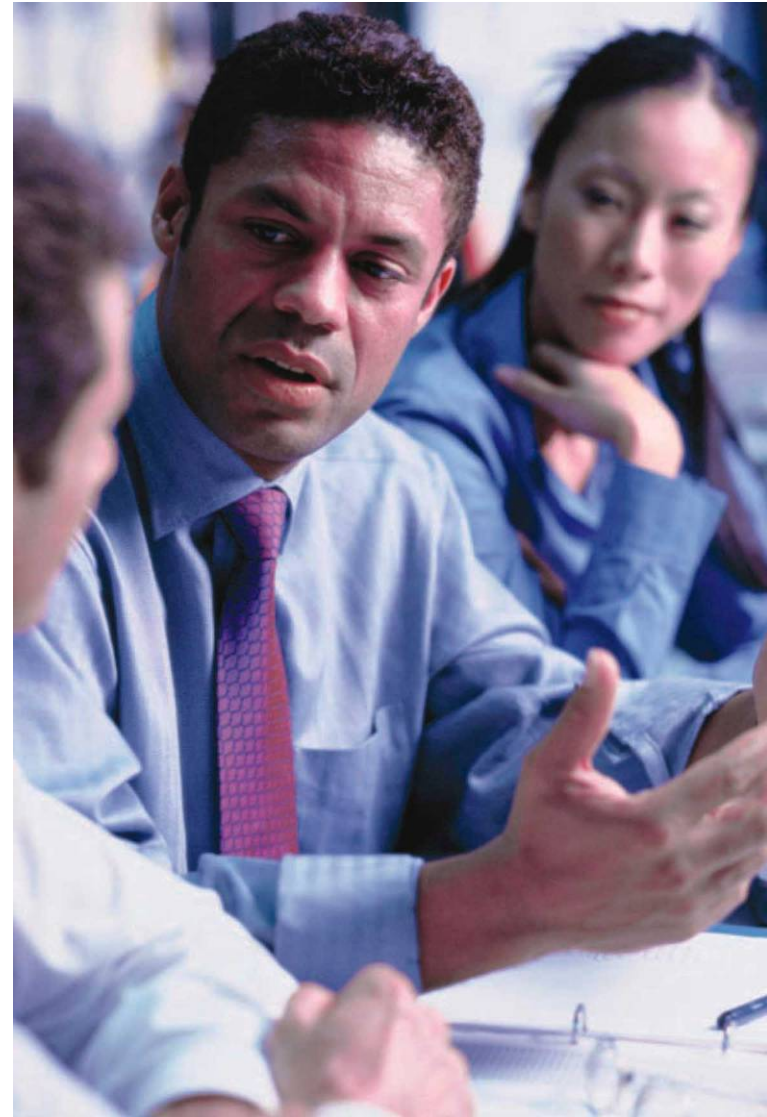

The choice of server platform is important.
All servers are not the same.

- **Wintel and UNIX servers generally designed as Single Application servers:**
 - ▶ Great for processor intensive applications
 - ▶ Great for appliance type applications

- **IBM Mainframe designed to run multiple applications simultaneously:**
 - ▶ Great for I/O intensive workloads (such as data serving)
 - ▶ Great for multiple mission critical workloads



- 40 years of technology innovation
- Continuously evolving with market needs
- Open and secure
- Powerful and energy efficient
- Reliable and scalable

*Designed for today's
On Demand business*

The Classic Strengths

- The mainframe historically had a reputation for specific capabilities:
 - ▶ Security
 - ▶ Availability
 - ▶ Scalability
 - ▶ Data and transaction serving
- The cornerstone for many large enterprises

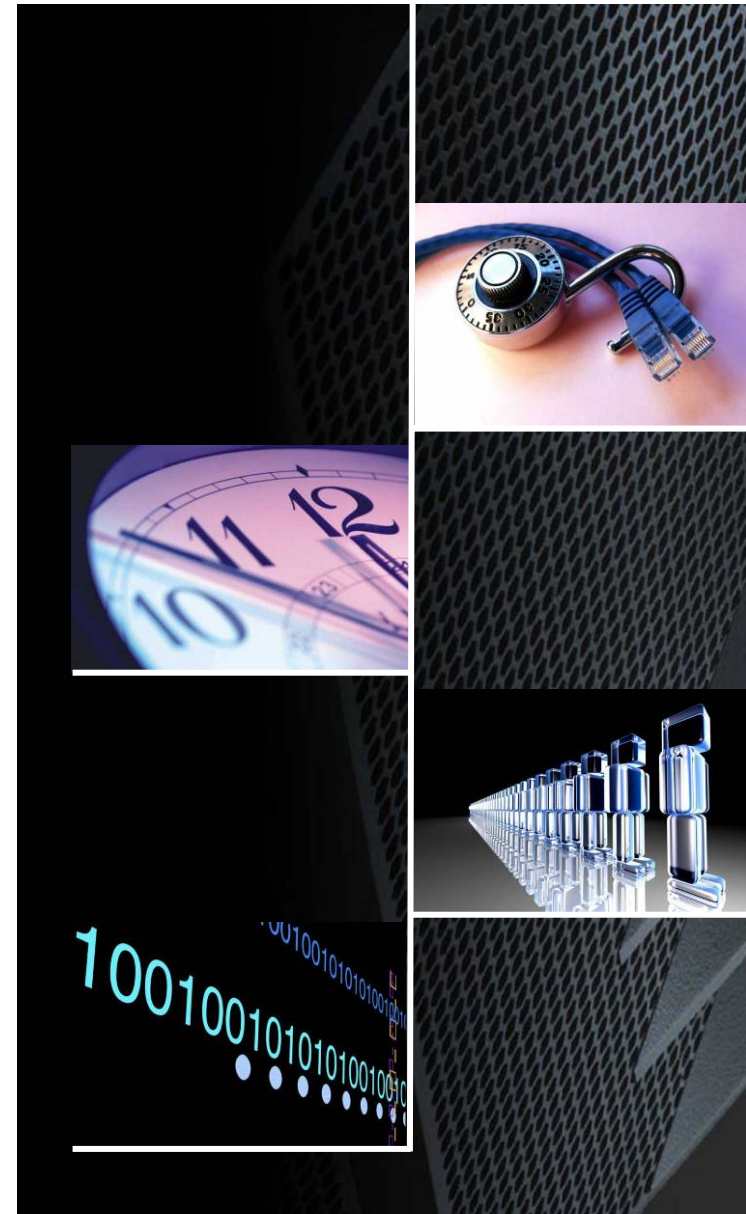

Today's IT requirements for an on demand business

- A resilient and security-rich foundation
- Flexibility and responsiveness
- Simplified infrastructure
- Low total cost of ownership
 - ▶ Acquisition costs
 - ▶ Management costs
 - ▶ Costs of downtime and security breaches
 - ▶ Energy costs

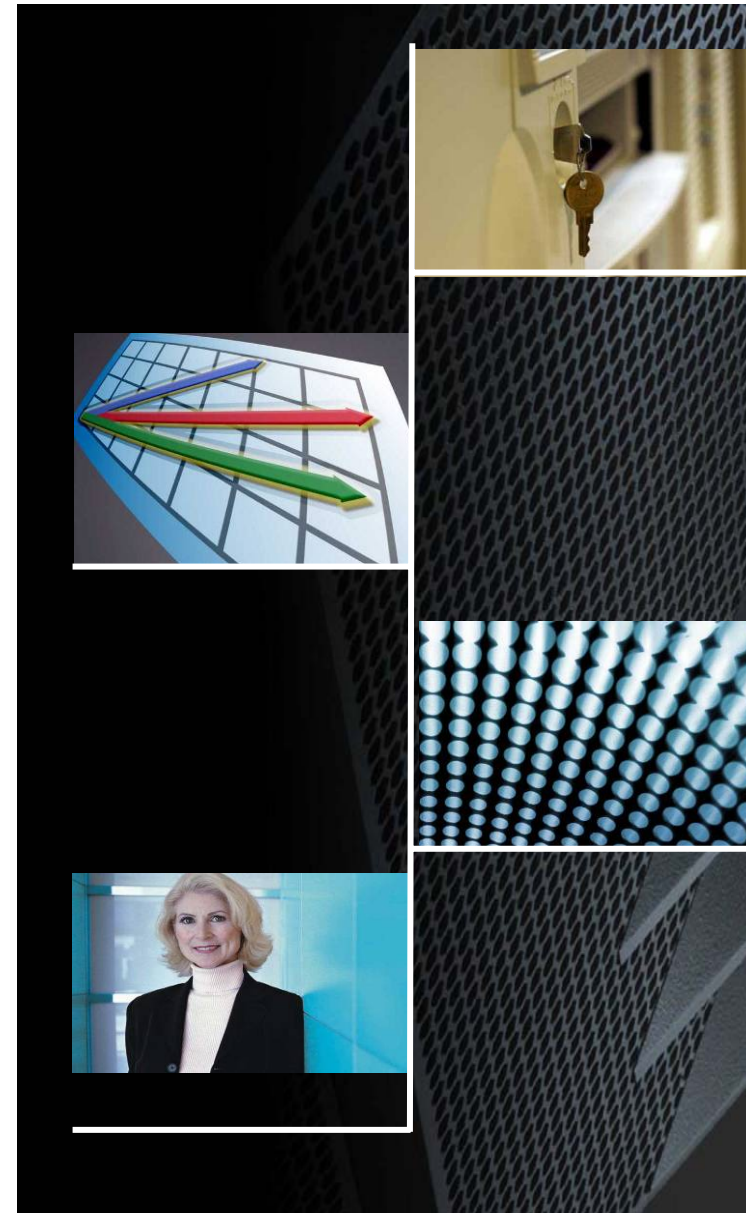

Today's mainframe

The ultimate virtualization resource

- Massive consolidation platform, utilizes share everything design
- Up to 60 logical partitions, 100s to 1000s of virtual servers
- Virtualization is built in, not added on
- HiperSockets for memory-speed communication
- Most sophisticated and comprehensive hypervisor function available
- Intelligent and autonomic management of diverse workloads and system resources based on business policies and workload performance objectives



Virtualizing IT Reduces Complexity

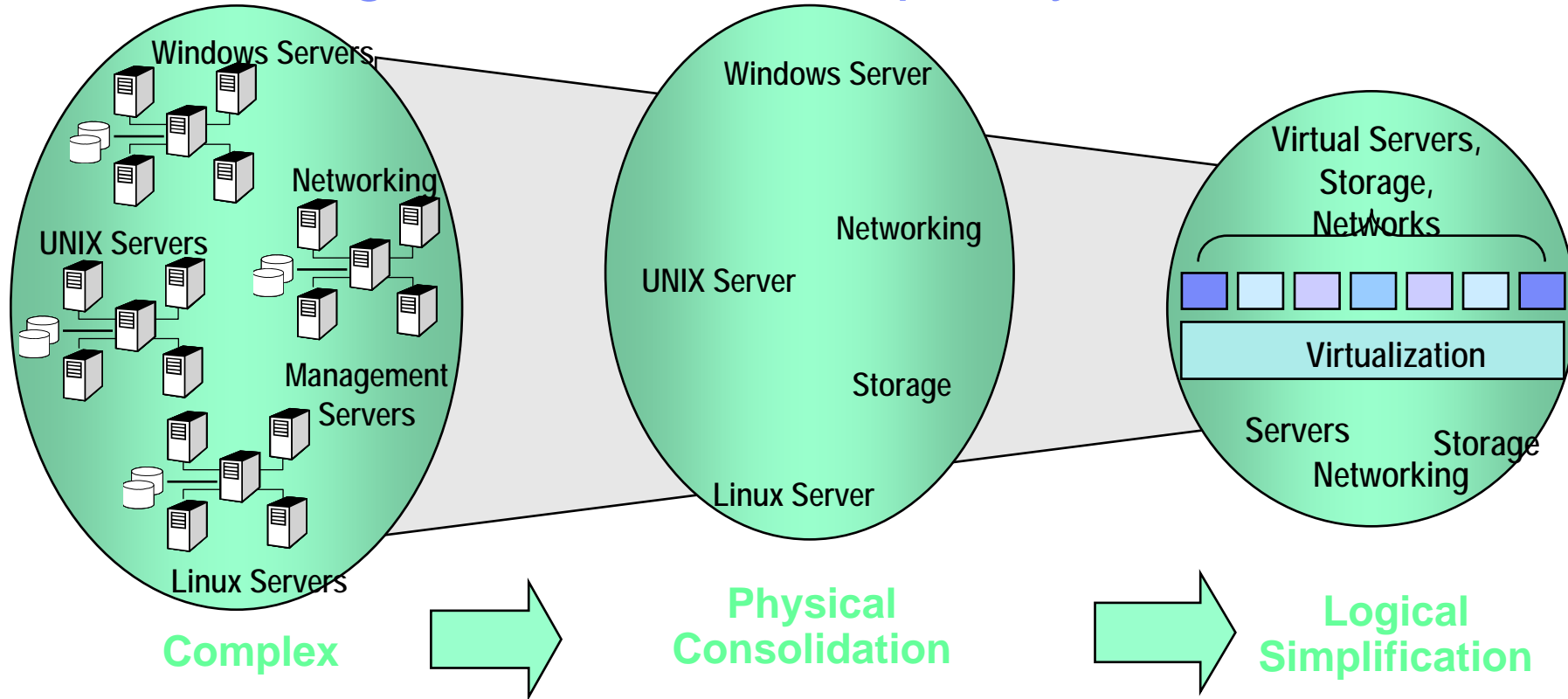

- Islands of computing and data
- Disparate management tools
- Manual provisioning
- Multiple Security exposures

- Fewer devices and licenses
- Disparate management tools
- Labor intense provisioning

- Pool of resources
- Multiple OS's per server
- Rapid provisioning
- Automated management
- Tighter security

Optimizing Workloads on a Mainframe is more effective

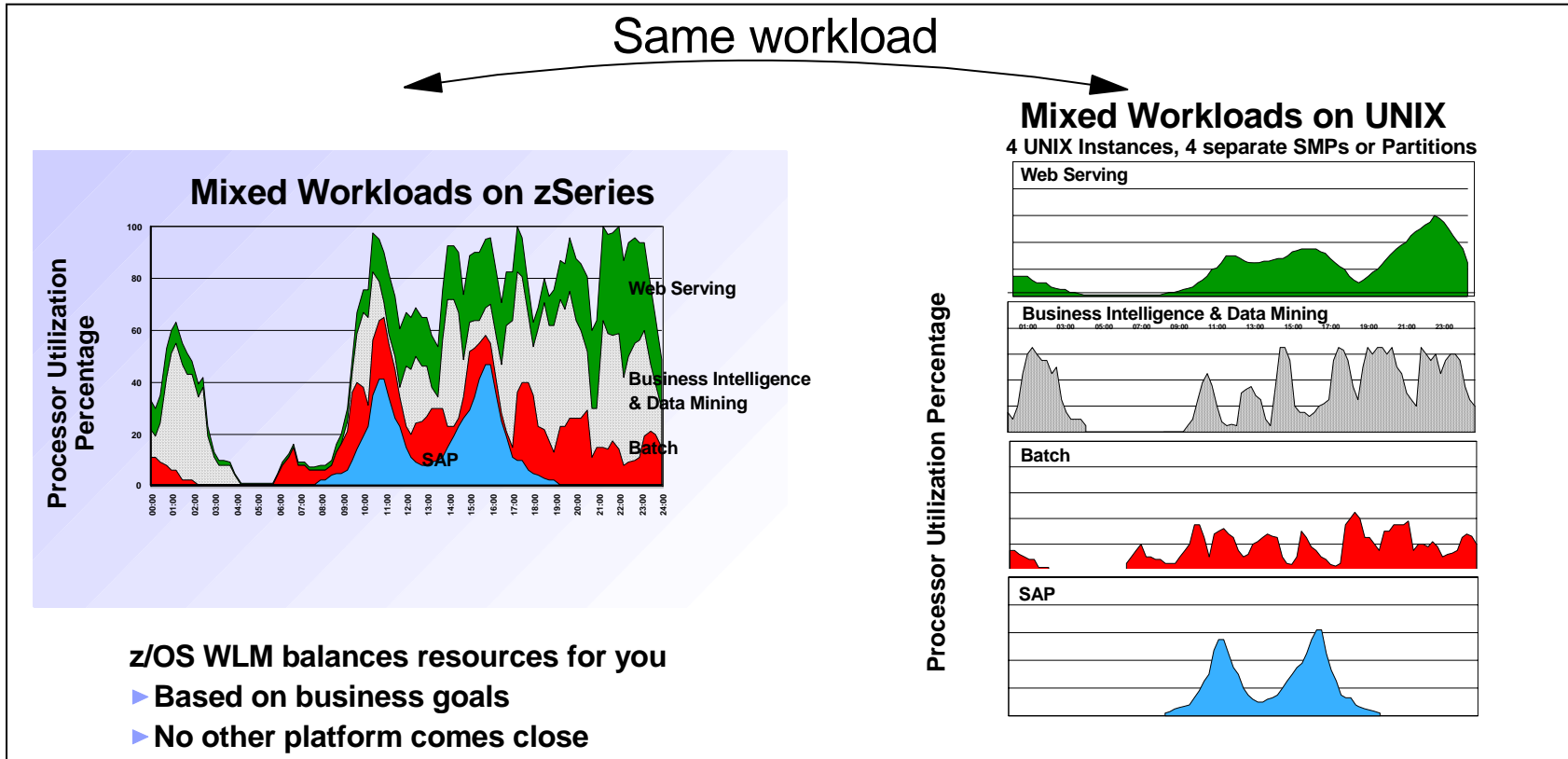

- **IBM Mainframes: Up to 100% Utilization**
 - Highly virtualized and shared resources
 - “hands off”, business priority driven intelligent workload management
 - Fewer servers, less power, cooling & admin
 - Optimized use of SW assets

- **UNIX processors: typically under 25% utilization**
 - More of them and more SW license
 - Static scripted workload management
 - Higher admin and environmental cost
 - Intel worse, typically <10% utilization

Economics of the mainframe

- Focus on price / performance
- Attractive pricing for new workloads
- New pricing models for open applications
- Consolidation versus server sprawl
- Addressing the indirect costs of computing



IT Optimization starts with a data center in a box ... not a server farm

- Central point of management
- Higher resource utilization
- Lower cost of operations
 - ▶ Less servers
 - ▶ Fewer SW licenses
 - ▶ Fewer resources to manage
 - ▶ Less energy, cooling and space
- Fewer intrusion points
 - ▶ Tighter security
- Fewer points of failure
 - ▶ Greater availability

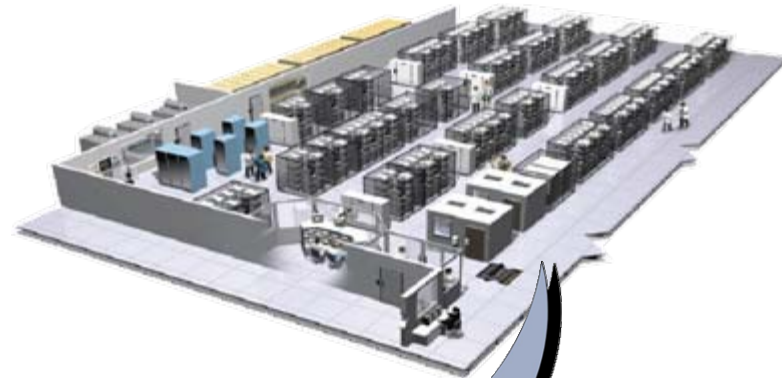

"We needed a solution that could provide high levels of availability around the clock, along with the flexibility to quickly and cost-effectively deploy new services both internally and externally. The mainframe fit the bill perfectly on both counts, enabling us to run multiple Linux virtual machines on a single, ultra-reliable hardware platform."

Infrastructure simplification is REAL

How Hannaford Markets simplified it's infrastructure



Power and Cooling Costs

Spending
(US\$B)

Installed base
(M units)

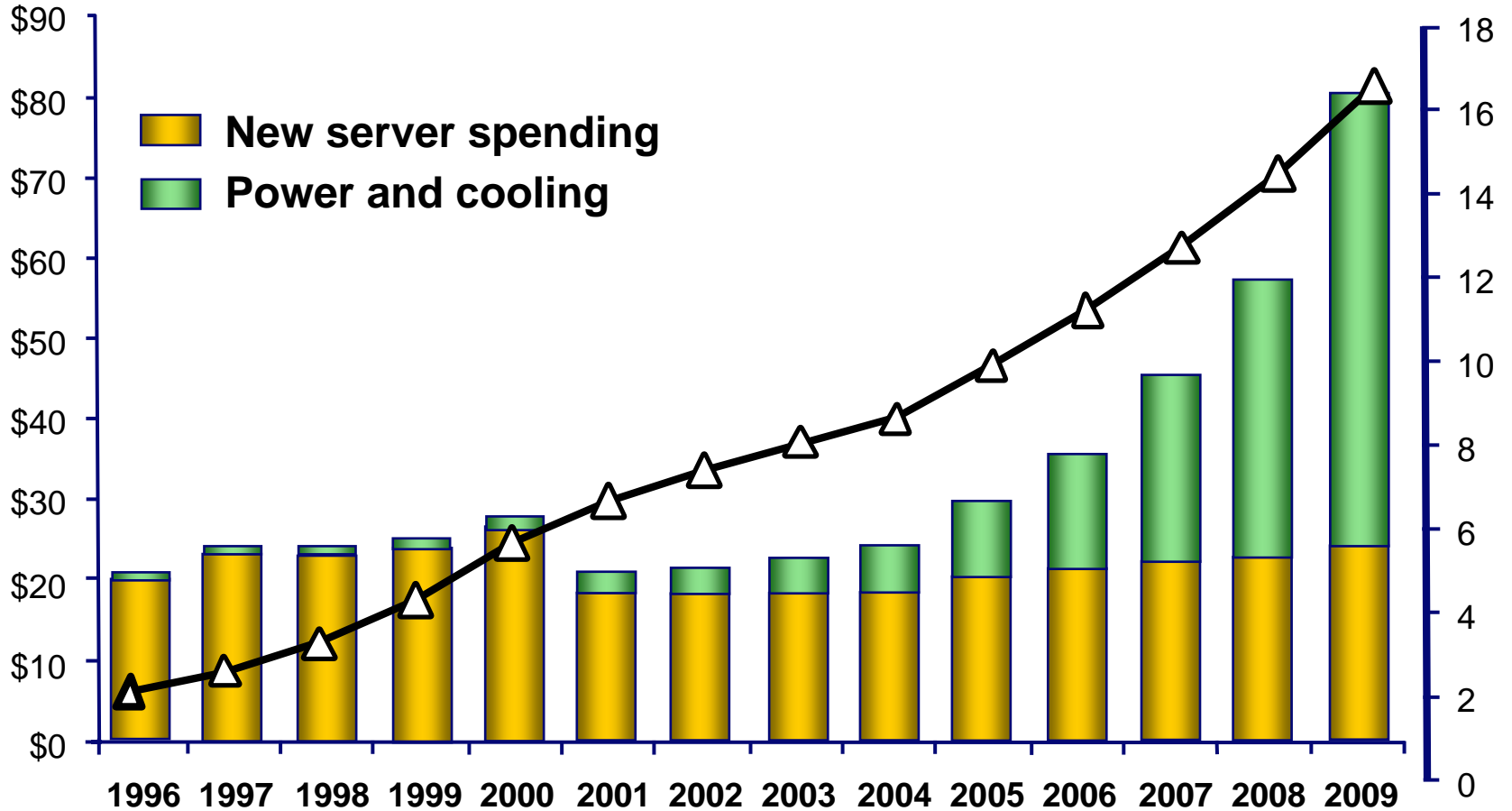

Harness the value of a System z9 Mainframe's high utilization and transform your enterprise's IT costs

*The System z9 EC delivers up to 4 times the same work in the same space!
The System z9 EC delivers up to 12 times the work for the same power consumption!*

Power and Space Consumption

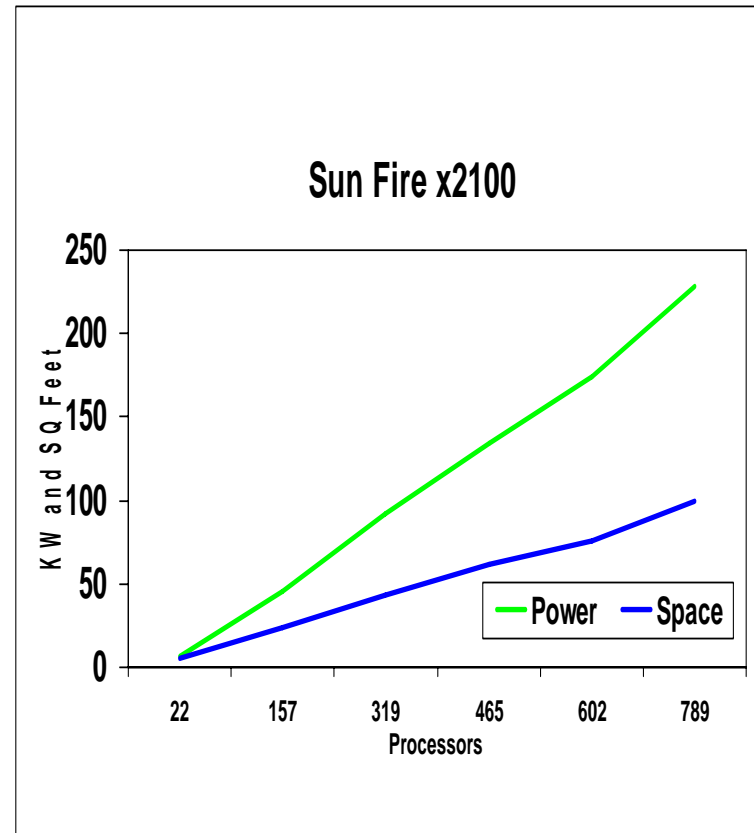
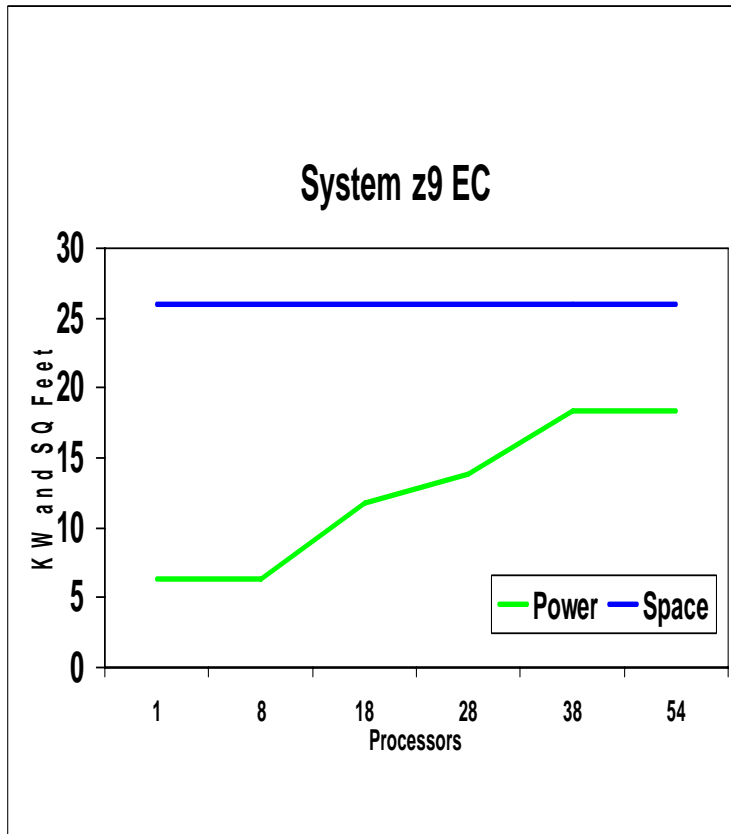

The energy savings are dramatic even at a lower processor capacity - an 8 way IBM System z9 EC (4,000 mips) may only utilize approximately 1/7th the energy needed by a typical distributed environment doing the same work.



Mainframe Innovation: Specialty Engines

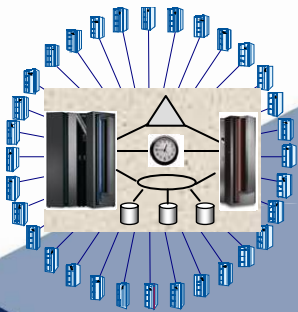

Internal Coupling Facility (ICF) 1997

Centralized data sharing
across mainframes



Integrated Facility for Linux (IFL) 2001

Support for new workloads and open standards



System z Application Assist Processor (zAAP) 2004

Incorporation of Java™ into existing mainframe solutions

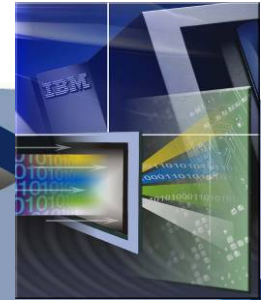

IBM System z9 Integrated Information Processor (IBM zIIP)

Designed to help improve resource optimization for eligible data workloads within the enterprise

IBM has the tools to simplify your infrastructure

- New System z9 Processors
 - ▶ Sized right to fit your business
 - ▶ New lower MSU charges
 - ▶ Specialty engines
 - ▶ Comprehensive multi-dimensional virtualization
 - ▶ On-off capacity on demand
- IBM Software
 - ▶ DB2
 - Fewer copies of data
 - Security rich
 - Easier to manage than replicated data
 - ▶ Tivoli software
 - End to end systems management
 - Resilience
 - Provisioning and control
 - ▶ Rational Software
 - Develop in a standard environment
 - Enable Service Oriented Architecture

The new roles of the mainframe

- Extending management and control capabilities across heterogeneous platforms
 - ▶ Enterprise resiliency / Back up
 - ▶ Enterprise security
 - ▶ Enterprise workload management
 - ▶ Data and SOA

System z Continuous Availability

Single System



Parallel Sysplex

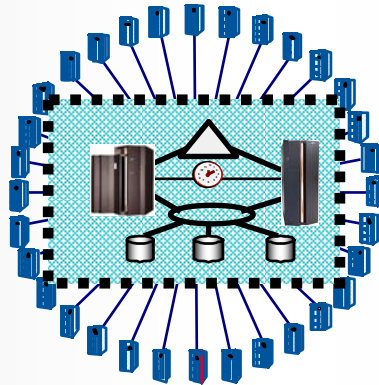

1 to 32 Systems

GDPS

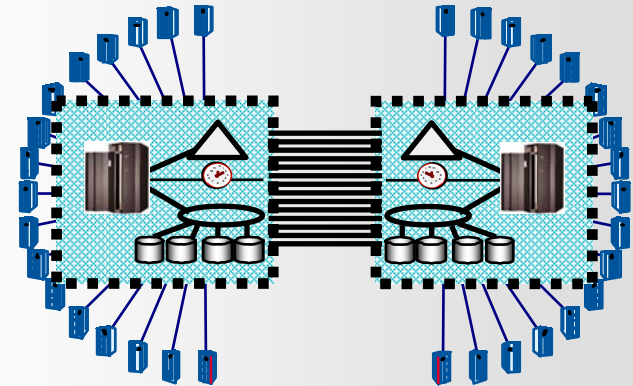

Site 1

Site 2

- Built In Redundancy
- Capacity Upgrade on Demand
- Capacity Backup
- Hot Pluggable I/O
- Concurrent LIC updates

- Addresses Planned/Unplanned HW/SW Outages
- Flexible, Nondisruptive Growth
 - Capacity beyond largest CEC
 - Scales better than SMPs
- Dynamic Workload/Resource Management

- Addresses Site Failure/Maintenance
- Sync/Async Data Mirroring
 - Eliminates Tape/Disk SPOF
 - No/Some Data Loss
- Application Independent

Today's mainframe

The benchmark for IT security

- Security built into all system layers
- Fast secure online transactions
- Security-rich Internet transmission
- Preemptive intrusion detection
- Collaborate with partners for enterprise-wide security
- Cryptographic coprocessors
- Centralized Key Management



System z Security - Architecture value

- System integrity
 - EAL5 certified partitions
- Application integrity
 - z/OS integrity statement
 - Inhibit malicious attacks against computing infrastructure
- Authorization and identification
 - Single point of control with RACF
- Network security
 - Intrusion detection services
 - Virtual networks (HiperSockets)
 - Encryption options across the internet
- Data confidentiality
 - Cryptography built in every engine
 - Secure key in specialized engines
 - Encryption key management
- Certifications

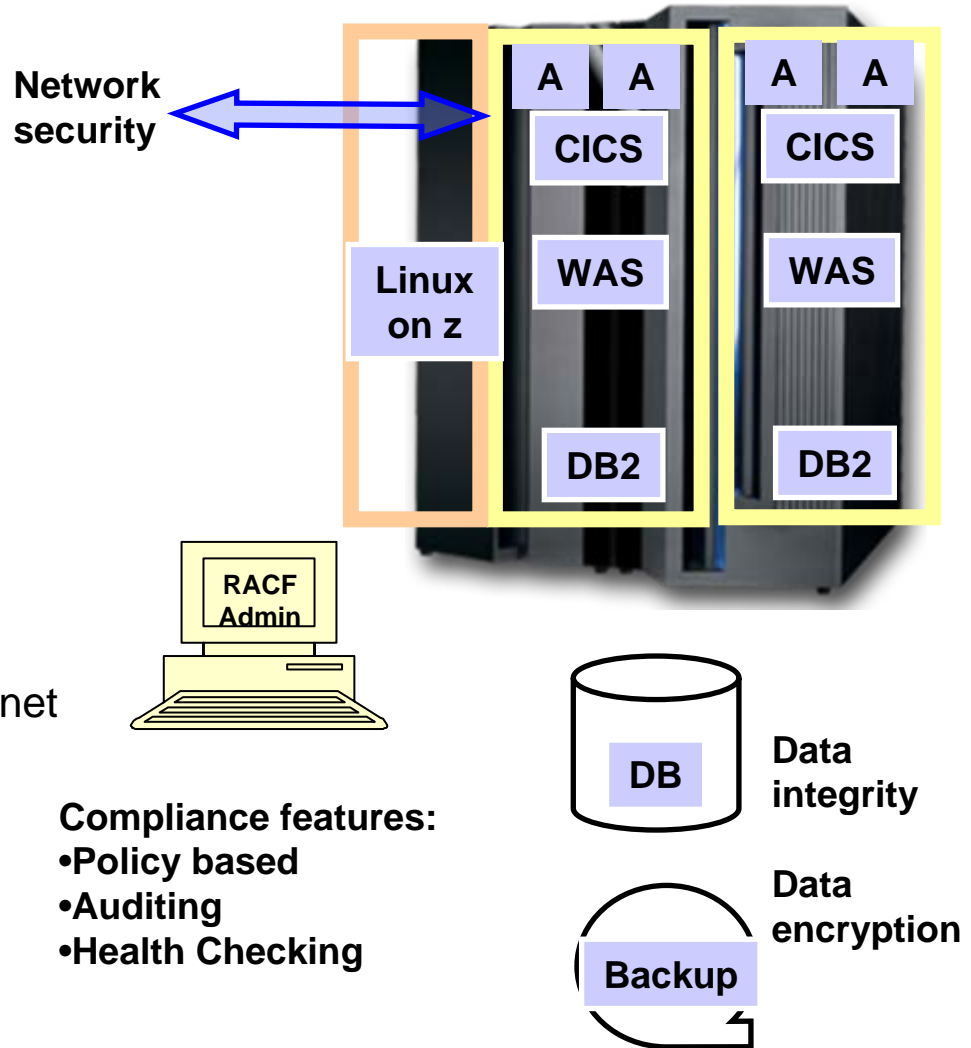

Enterprise Workload Manager

Automated Workload Management for Distributed Heterogeneous Infrastructures

- Manage business process service levels
- Improve utilization of IT resources

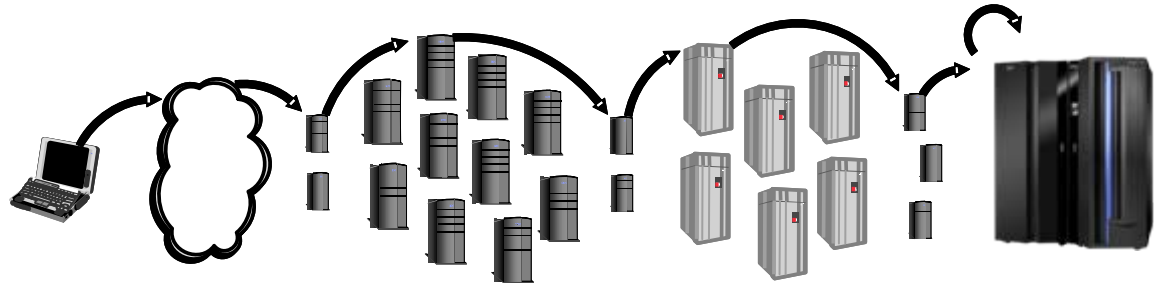

Release 1 Functionality

Influence network routing decisions EWLM Monitoring:

- a service class application topology
- an “end to end” view of response time based on service class definitions and performance goals
- reporting and drill down capability linking resource delay information to response time contributions at the server, logical partition, operating system and subsystem level

EWLM Vision

- Solve real customer pain by providing end to end resource optimization and load balancing of IT resources in a heterogeneous, multi-tier application and server environment

Today's mainframe

Designed for data serving and SOA

- Built upon a strong foundation:
 - ▶ Security-rich, resilient, and virtualized capabilities
 - ▶ 40 years of data serving heritage
- Broad set of open and industry standards
- Designed to deliver:
 - ▶ Great value from mainframe assets
 - ▶ Low marginal cost of growth
 - ▶ New capabilities fast
 - ▶ Great flexibility to meet new business opportunities

If data is the life blood of the business . . .

. . . then your data server is the heart of your SOA



**A hub for data and SOA -
massive scalability
centralized management**



System z delivers many other benefits to the business

- **Extremely High Availability and Overall Reliability**
- **Massive end-to-end Scalability**
- **Capacity on Demand**
- **Utilizes Open and Industry Standards**
- **World-class Integrated Support**
- **Higher Utilization and Balanced System Design**

Today's mainframe delivers the capabilities required by an on demand business

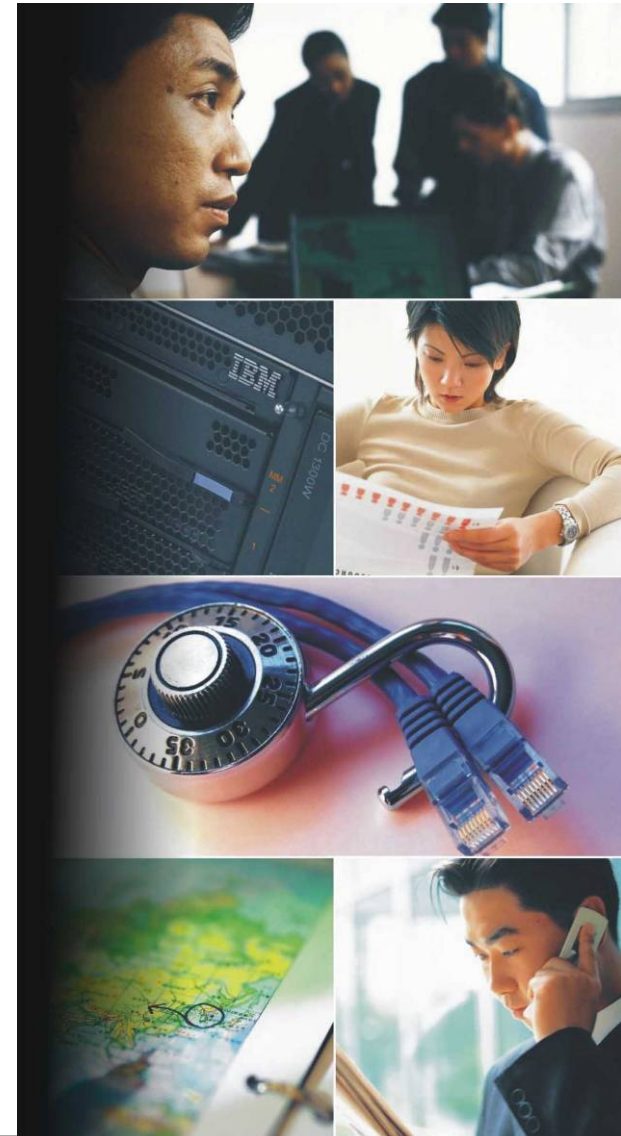

IBM Mainframe – Innovative technology helping you simplify your IT environment

- Integration across heterogeneous servers with advanced middleware
- Ability to run multiple mixed workloads on fewer servers in a highly automated environment
- Comprehensive security
- Low cost of ownership for current workloads and future growth





Randy Daniel
Randyda@US.IBM.COM