



WebSphere MQ for z/OS V7 as the messaging backbone for SOA, Web 2.0 and file transfer



Trademarks

The following are trademarks of the International Business Machines Corporation in the United States, other countries, or both. For a complete list of IBM trademarks please visit www.ibm.com/legal/copytrade.shtml

CICS	IBM Logo	S/390
DB2	IMS	Tivoli
E-business logo	iSeries	VM/ESA
ESCON	MVS	VSE/ESA
eServer	OS/390	WebSphere
FICON	pSeries	z/OS
IBM	Rational	zSeries
Smart SOA	RS/6000	System z

Java and all Java-based trademarks are trademarks of Sun Microsystems, Inc. in the United States, other countries, or both.

Microsoft, Windows, Windows NT, and the Windows logo are trademarks of Microsoft Corporation in the United States, other countries, or both.

Microsoft trademark guidelines

Intel is a registered trademark of Intel Corporation in the United States and other countries.

UNIX is a registered trademark of The Open Group in the United States and other countries.

Linux is a registered trademark of Linus Torvalds in the United States, other countries, or both.

Other company, product, or service names may be trademarks or service marks of others.

Agenda

- **The role of WebSphere MQ in SOA**
- **WebSphere MQ for z/OS highlights**
- **What's new in WebSphere for z/OS MQ V7**
- **WebSphere MQ and the Web**
- **WebSphere MQ and Files**
- **Summary**

Universal Messaging Backbone with WebSphere MQ

- **Extends the reach of your Enterprise to deliver Business data with a range of QoS for processing by CICS**

Support for virtually every commercial IT System

80+ platform configurations

- AIX
- Linux x86, x86-64
- Linux POWER
- Linux for System z
- Windows x86, x64
- Solaris x86 / SPARC
- iSeries i5/OS
- HP-UX Itanium/PA-RISC
- HP NonStopServer
- HP OpenVMS

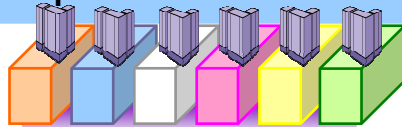

80+ platforms

Exploit System z for messaging powerhouse

- Unique code-base designed natively for tight z/OS integration
- Runs as formal MVS sub-system
- Leverage Parallel Sysplex to provide Shared Queues for continuous availability, scalability and capacity
- Support for event-driven publish-subscribe delivery



z/OS

Enable popular applications and environments

- Built-in bridge for CICS, IMS, Batch/TSO
- JCA support to provide JMS services for JEE App Servers
- Support for Databases DB2, Oracle etc
- Support for External Transaction Coordinators
- Over 950 ISVs with enabled Packaged Applications

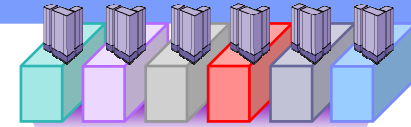

Applications

← UNIVERSAL MESSAGING BACKBONE →

WebSphere MQ in a nutshell

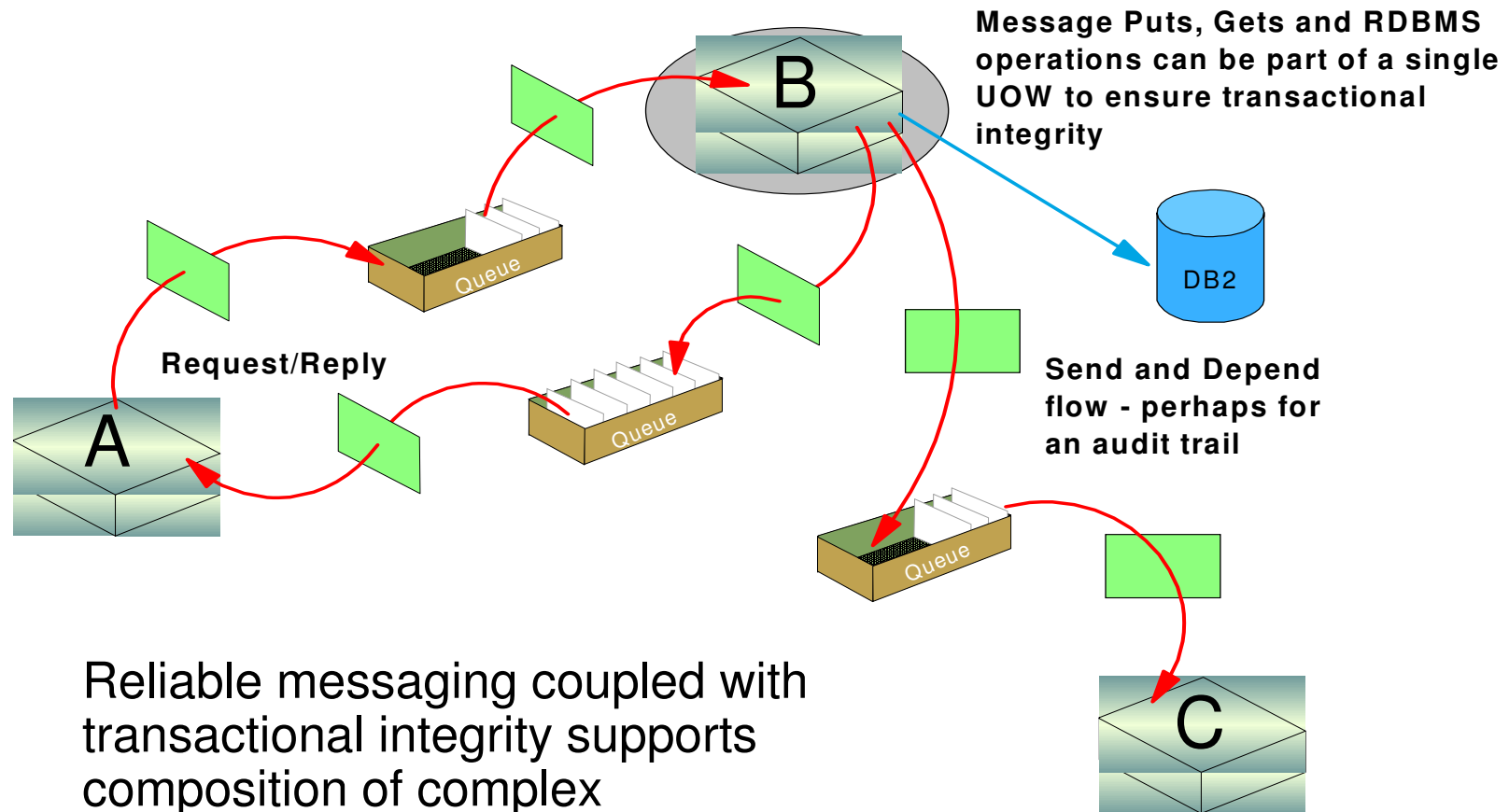

Reliable messaging coupled with transactional integrity supports composition of complex applications to fully support parallel processing.

z/OS access to CICS, IMS, DB2 SPs and Batch/TSO

Explicitly – Using the MQI or JMS API

- Gives CICS and IMS access to messages from other z/OS regions and other non-z/OS platforms
- Allows other applications to access CICS and IMS without using CICS or IMS APIs

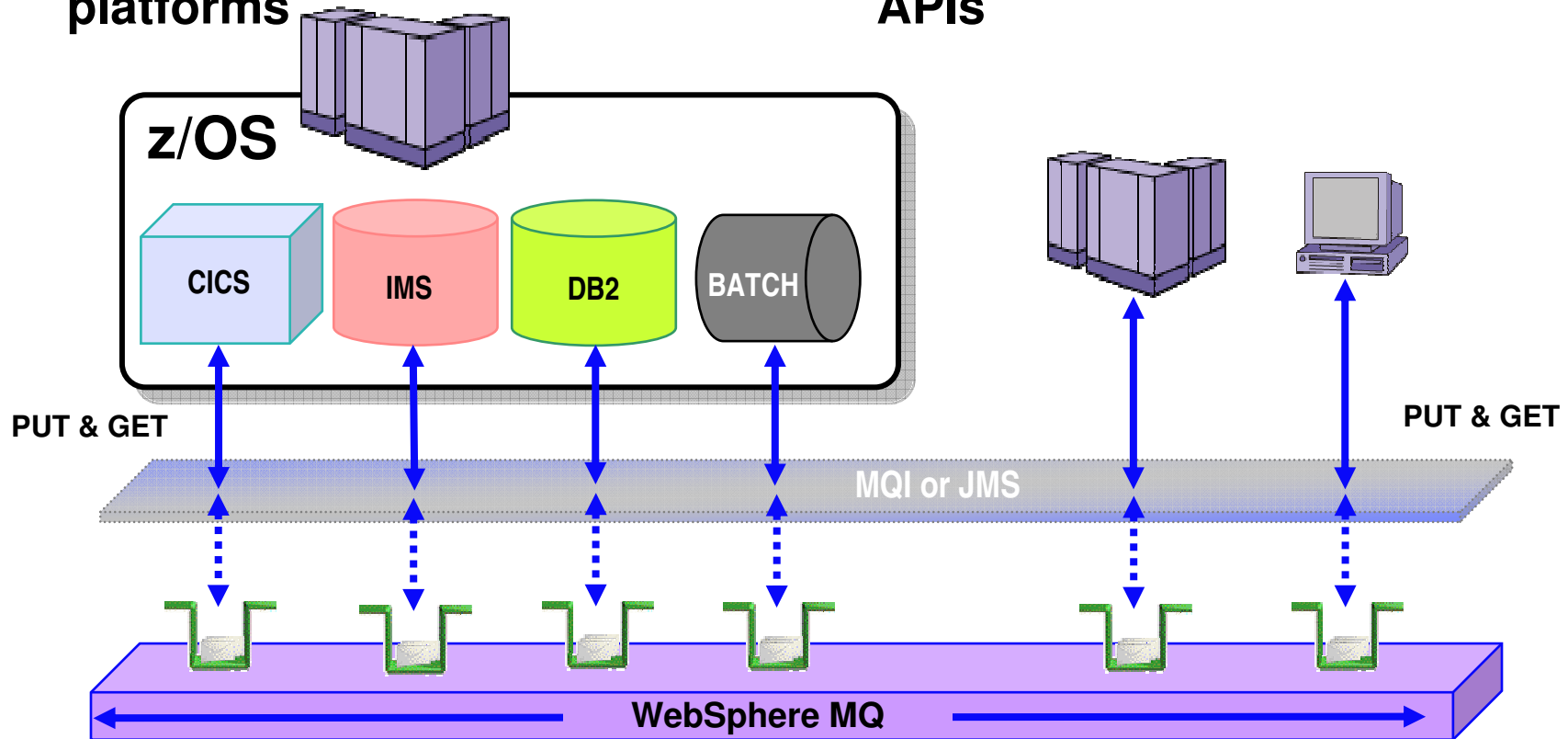

z/OS bridges to CICS and IMS

Implicitly – Using the Bridges supplied for CICS and IMS

- **CICS and IMS applications use the native APIs:**
 - EXEC CICS BMS, GU, ISRT...
- **Allows other applications to access CICS and IMS without using CICS or IMS APIs**

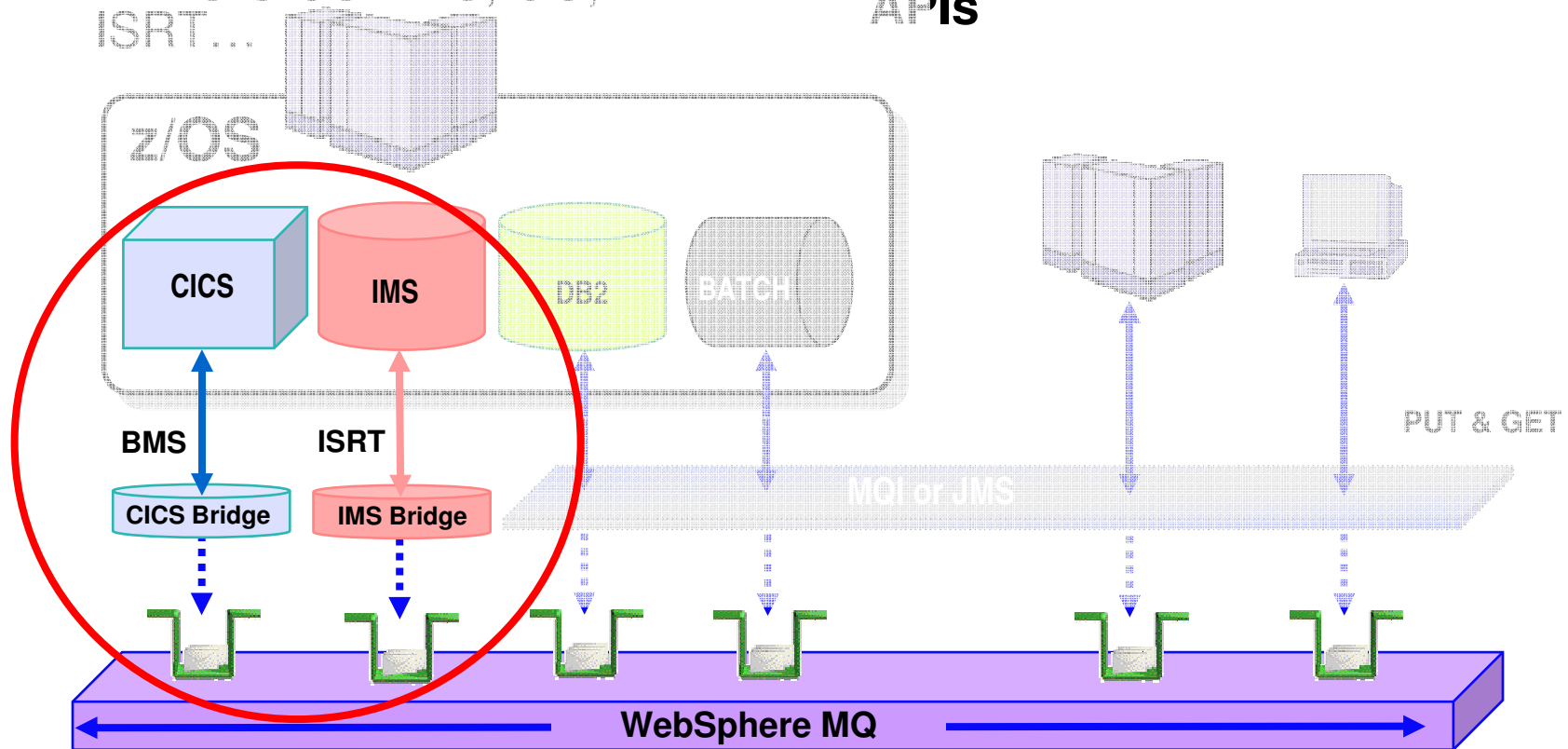

Full support for transactional environments

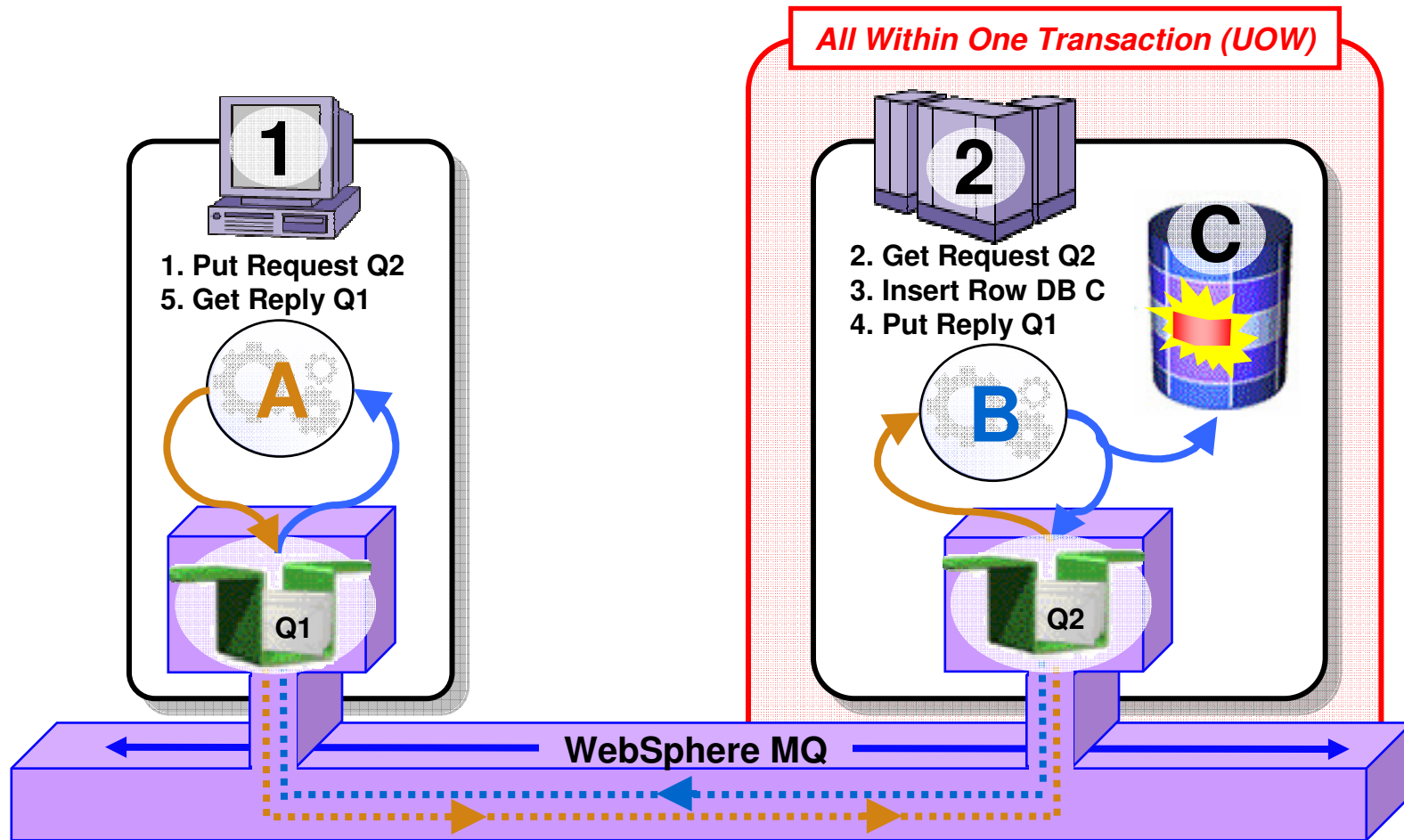

- Full support for CICS, IMS, WAS, DB2 SPs & Batch RSS
- Reliable Two-Phase commit involving other Resource Managers e.g. DB2

Shared queues on z/OS

- Exploits Parallel Sysplex
- Automatic load balancing
- Scalable throughput
- Multiple processors can access the same queue
- Queue sharing groups
- VIPA support

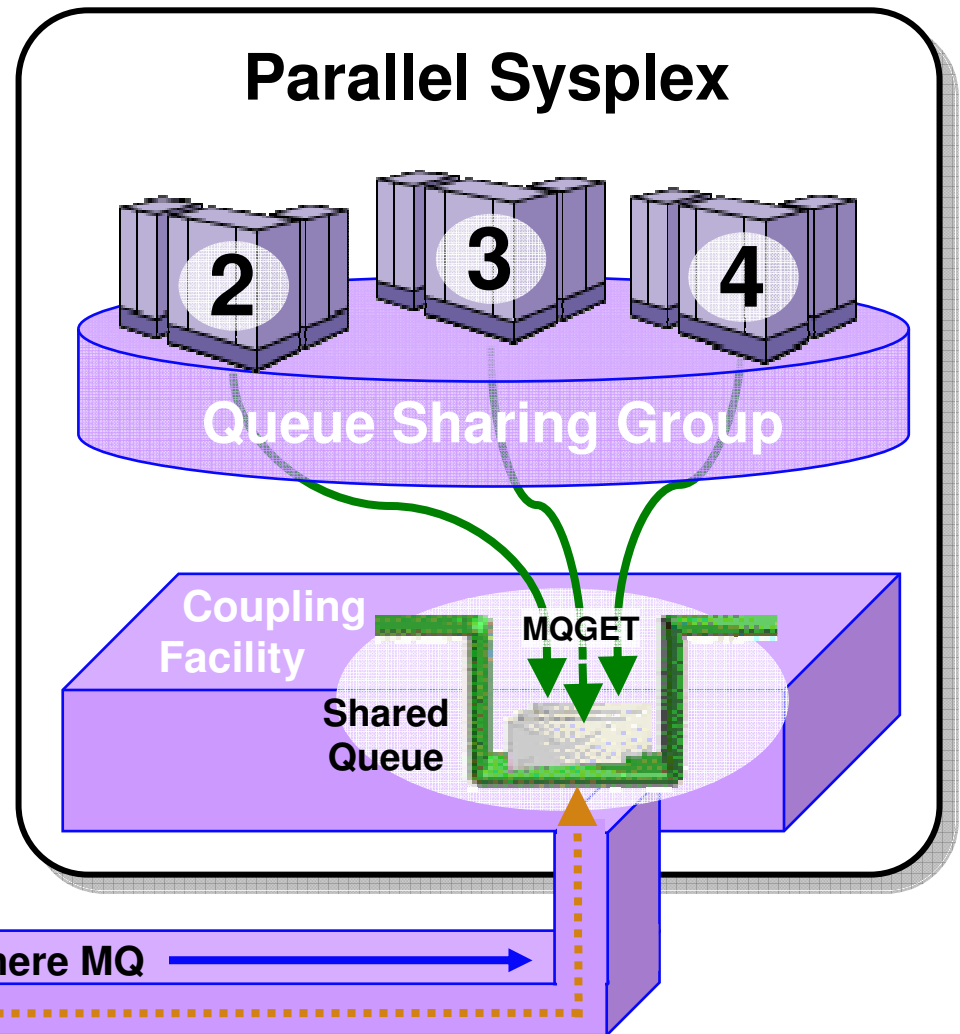
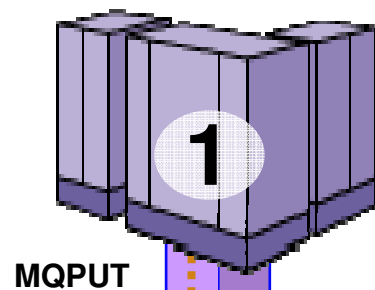

Highly Available with Failover for z/OS

- **Failure isolation**
 - Automatic peer recovery for failing Servers, Applications or Queue Managers
- **In-flight MQPUTs and MQGETs are rolled back**
 - Since messages are not hosted in any Queue Manager there are no marooned messages
- **24 x 7 availability**
- **Leverages ARM (Automatic Restart Manager)**

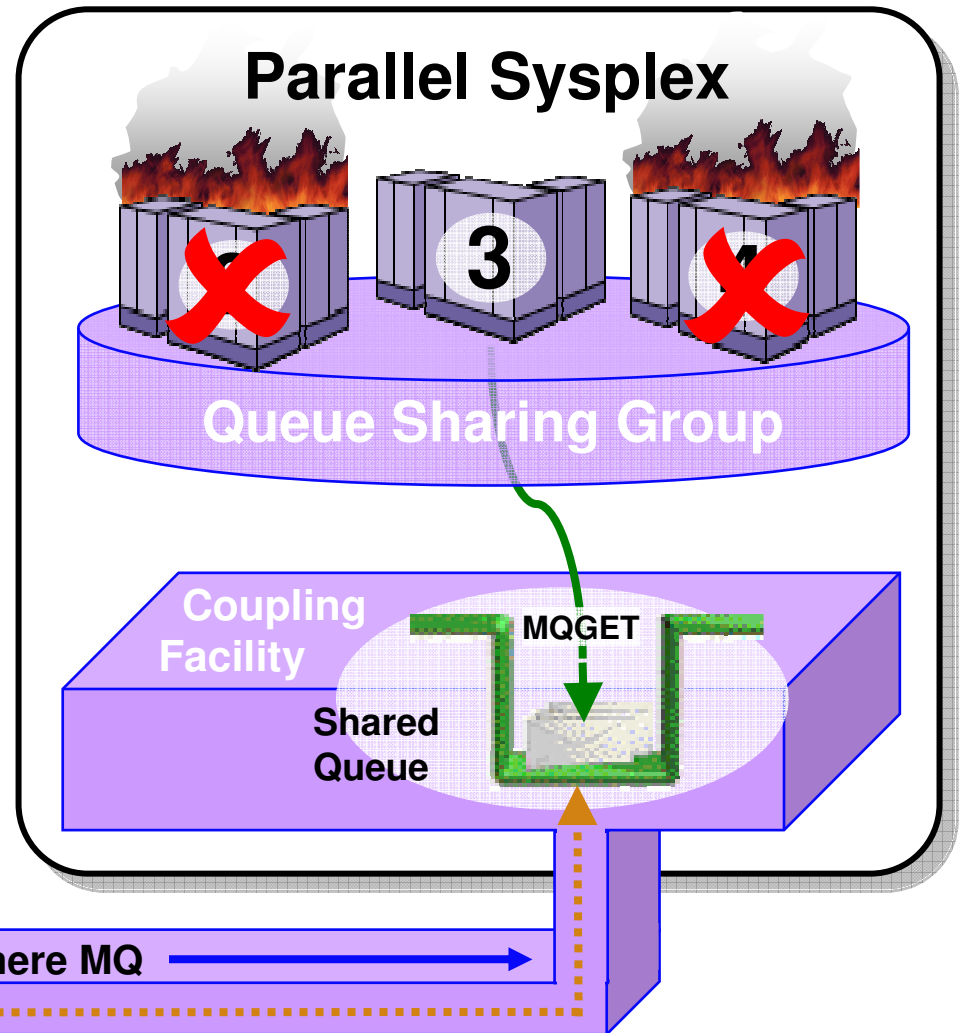
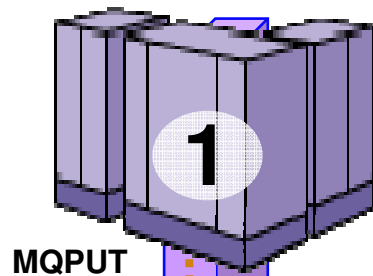

Security

- **Security is #1 concern of CIOs**

- **Secure Sockets Layer (SSL)**
 - Provides channel-level security
 - WebSphere MQ V5.3 introduced SSL support
 - Uses the z/OS Cryptographic Services System SSL function

- **Security Server on z/OS (previously RACF)**
 - WebSphere MQ for z/OS has always provided close integration with RACF and 3rd-party alternatives
 - Security Server (RACF) can protect the resources that WebSphere MQ for z/OS owns and manages from access by unauthorized users

- **WebSphere MQ Extended Security Edition for z/OS**
 - Provides advanced security capabilities leveraging Tivoli security technology

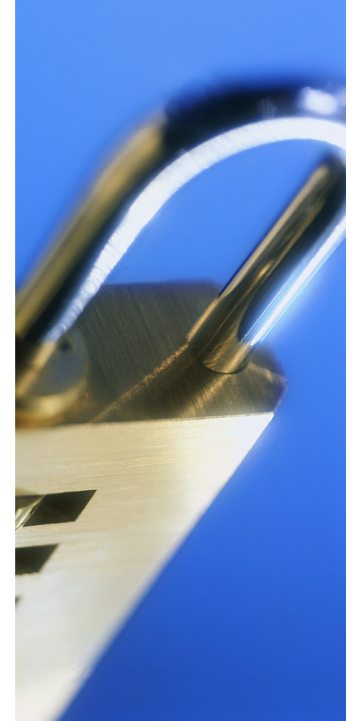

WebSphere MQ Extended Security Edition for z/OS V6 Enhances Security and Compliance

- **Protects message data end-to-end-including when it resides in queues. 3 security levels:**
 - None-authorization only
 - Integrity-attaches digital signatures to messages
 - Privacy-encrypt/decrypt
- **Exploits System z cryptographic processor**
- **Simple upgrade on top of WebSphere MQ**
 - Intercepts application message before it enters/leaves queues
- **Provides key element of solution for Payment Card Industry (PCI) Data Security Standard (DSS)**

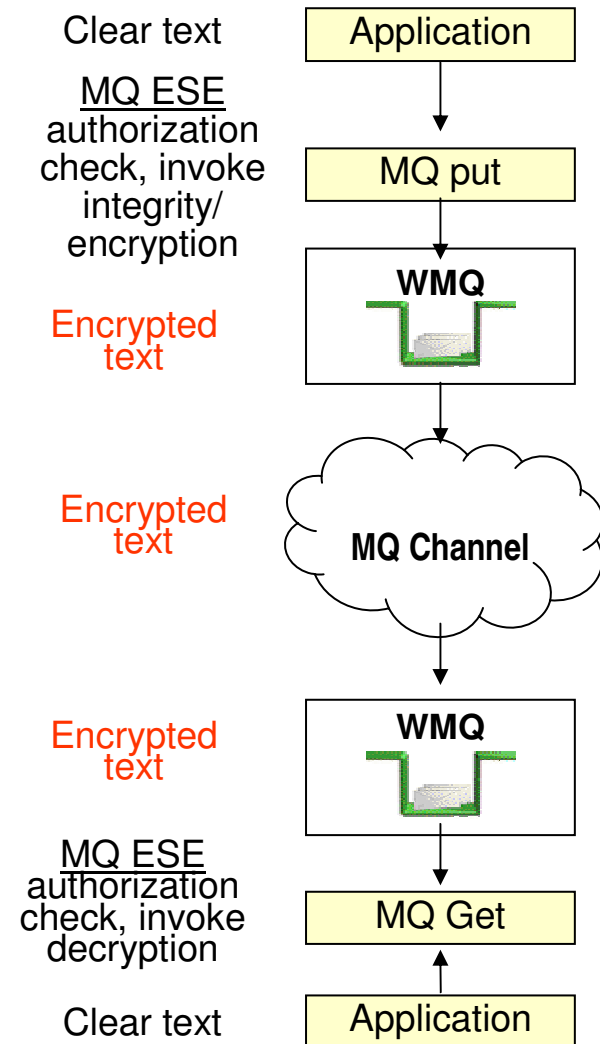

IBM Vision for an ESB Messaging Backbone

- Addressing the full spectrum of transport requirements

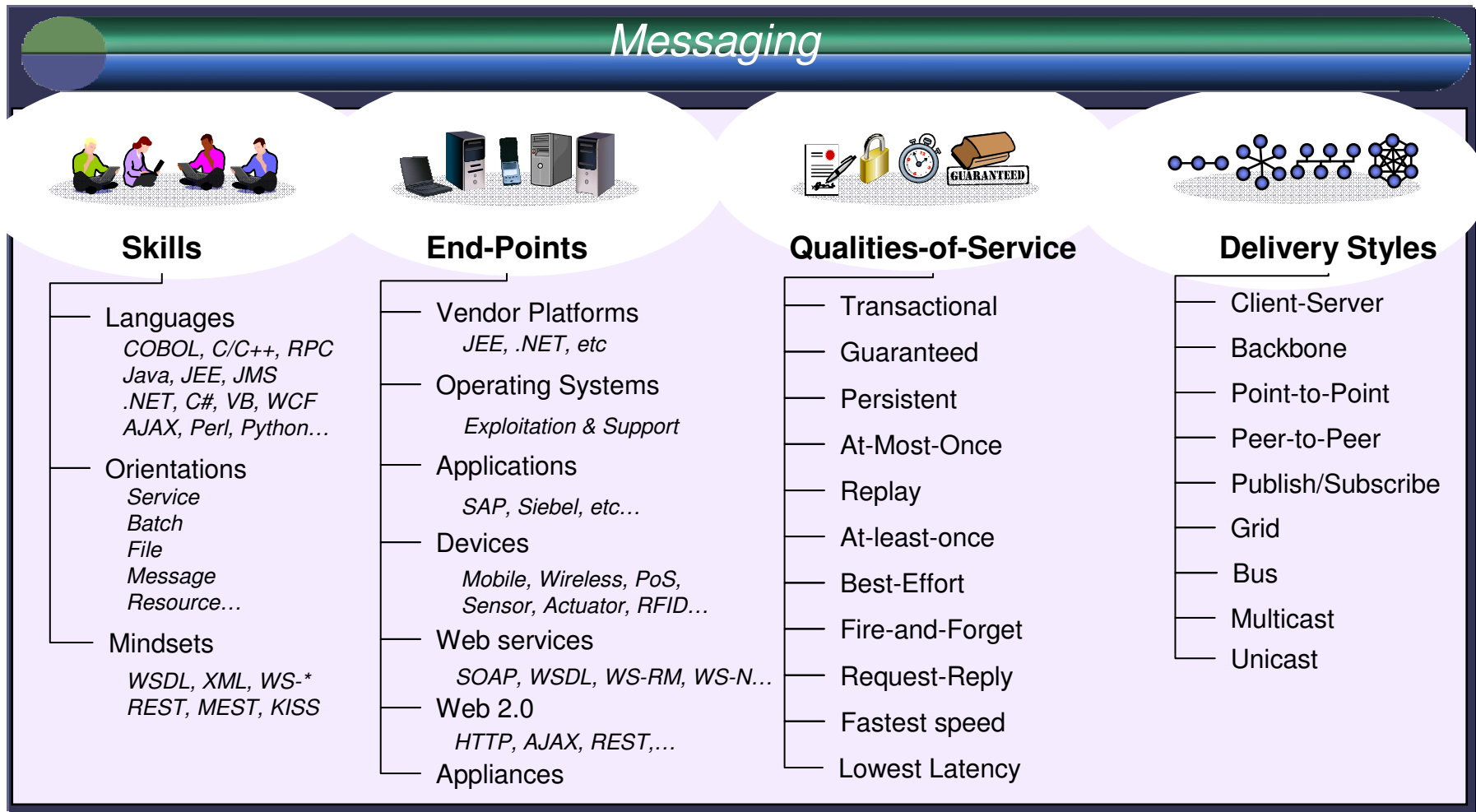

The Latest Evolution of SOA Messaging

Introducing WebSphere MQ V7

- **Highly consumable & easy to use for faster time to market**
- **Turbo-charged performance to do more with less**
- **More dynamic & scalable Pub/Sub features**

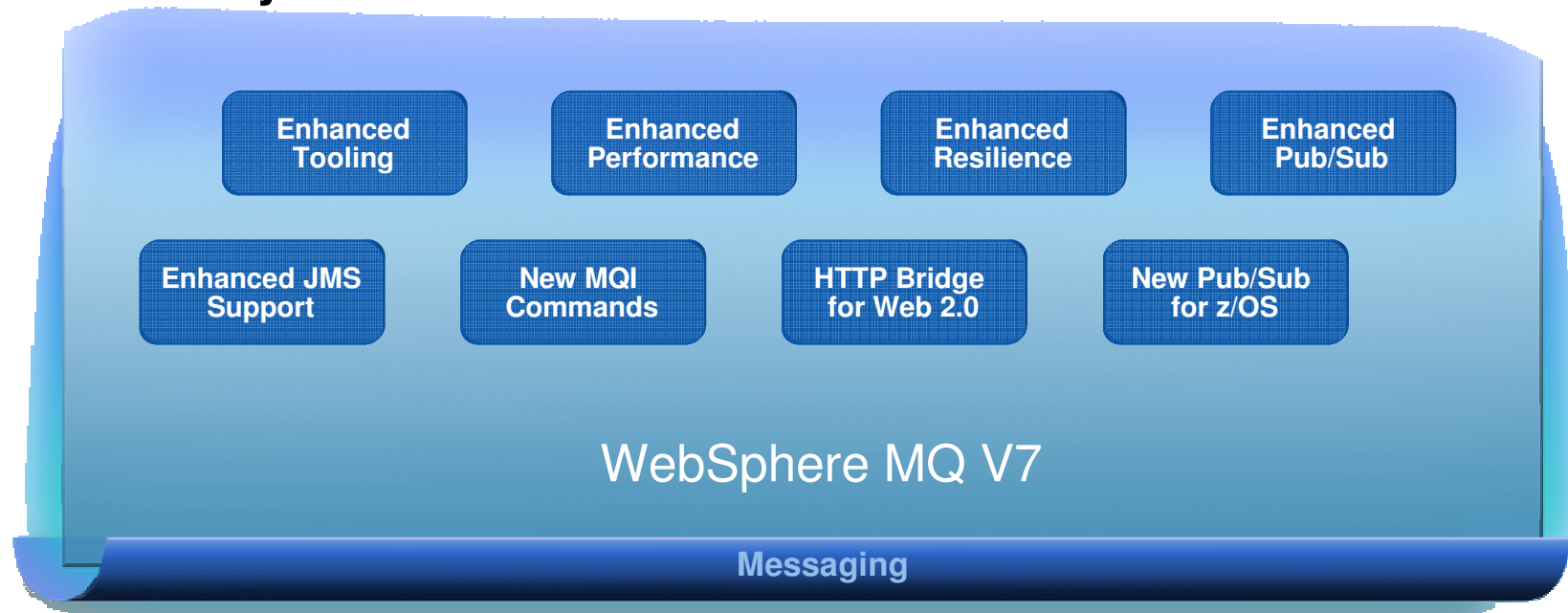

Enhancing Usability of IBM's SOA Messaging Backbone

1. Premier ease-of-use for improved developer productivity

- Graphical configuration of JMS and Publish-and-Subscribe

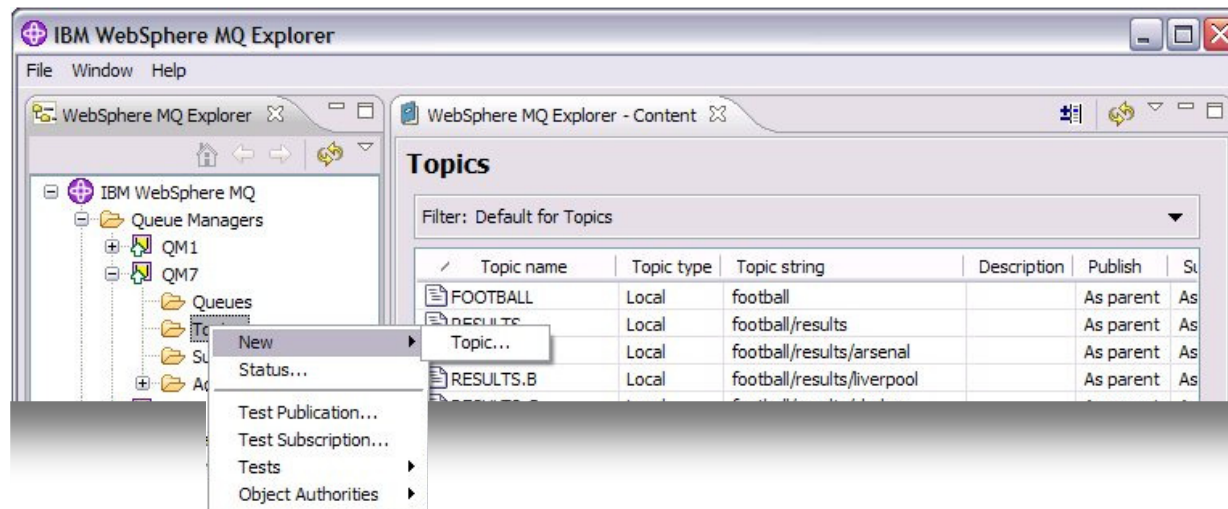

- New MQI verbs providing greater flexibility for
 - Selecting messages for processing
 - Adding custom properties to messages
 - Automatically notifying applications when messages arrive

MQI Enhancements - Message Properties

- **Arbitrary values associated with the message but not part of the body**
 - Like a user-extendable MQMD
 - Already part of JMS
- **New verbs including MQSETMP and MQINQMP**
 - Properties can be integers, strings, boolean, etc.
- **Easier to use than RFH2 folders**
 - Receiving apps do not see them unless they want
 - No need to parse and skip over message headers
- **Configuration options for compatibility**
 - Queue and channel attributes define behaviour
 - Defaults will create RFH2 folders
- **Permits explicit statement of relationships between messages**
 - eg Message X is a **REPLY** to Message Y
 - Messages referred to by handles

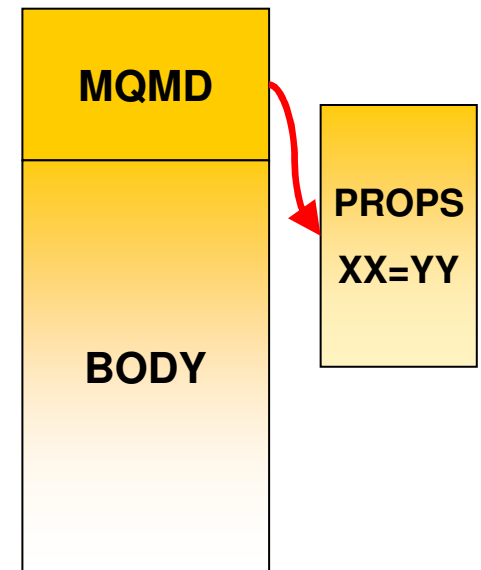

Other MQI Enhancements

- **Asynchronous Message Reception**
 - New verb **MQCB** defines a callback function
 - Automatically Invoked when a message arrives
 - No need for MQGET(WAIT) or MQGET(SIGNAL)
 - A thread can receive messages from multiple queues
 - New verb **MQCTL** to start and stop message delivery to callback
- **Selectors**
 - Use a SQL92 clause to select messages by properties including MQMD fields
 - Can be specified on MQOPEN, MQCB for filtering messages
 - Selection is done inside queue manager
 - Not looking inside message body
 - Message Broker still required for content filtering
- **Cooperative Browsing and Message Tokens**
 - Efficient interface for applications reading from the same queue
 - Example: "master" program browses a queue telling "slaves" which message to work with, based on elements within the message
 - No races – messages locked but available to any cooperating process

WMQ Explorer Enhancements

- **Sets**
 - Queue Managers can be partitioned into sets within the Navigator
 - For example "Test", "Production"
- **Security Configuration**
 - Easy to define channel exits, userid/password configurations
 - Configured for each queue manager or for all queue managers in a set
 - Password manager included
 - Still recommend security exit or service for authentication at the server
- **Tighter JMS integration**
 - Creating an queue/topic can define a JMS destination at the same time
- **Message browser configuration**
 - Number, size of messages
- **Plug-in Migration**
 - Explorer now based on Eclipse 3.3 – compatibility not guaranteed
 - Major change is availability of supported PCF classes
- **Using MQ Explorer with MQ for z/OS**
 - you can use the MQ Explorer, which runs on the Windows and Linux on x86 platforms, to manage the z/OS parts of your WebSphere MQ network without having to buy the Client Attach Feature

Enhancing Usability of IBM's SOA Messaging Backbone

1. Premier ease-of-use for improved developer productivity

- Heart-beat monitoring of client connections
 - To help increase messaging availability
- Pre-emptive delivery of messages for increased throughput
 - A.k.a Message Read-Ahead
- New Quality-of-Service that avoids waiting for confirmation of delivery – enables “receipts” to be received later
 - Can help increase application throughput
 - A.k.a Asynchronous consume

Client Enhancements

- **Client Performance**
 - Traditional WMQ non-persistent messages more reliable than some need
 - "Read Ahead" for Receiving Messages/Publications
 - "Asynchronous Put" for Sending/Publishing Messages
- **Client Connection Management**
 - Shared Client Conversations
 - Implementation also gives us more heartbeat opportunities
 - Faster failure notification for clients
 - Client Connections
 - Automatic workload distribution via CCDT
 - Control number of connected clients at a queue manager
 - Free connections to z/OS for administration programs like WMQ Explorer
 - Limited number of clients permitted by V7 license without CAF

Enhancing Performance of IBM's SOA Messaging Backbone

2. Turbo-charged performance and enhanced resilience

- Enhanced publish-and-subscribe performance
 - Increased throughput by up to 20%* (Distributed)
 - New publish-and-Subscribe support added in this release (z/OS)

- Enhanced JMS performance
 - Increasing JMS selectors by up to 250%* (Distributed)
 - Increasing JMS listener throughput by up to 45%* (Distributed)
 - Increasing JMS listener throughput by up to 220%* (z/OS)

- Enhanced Clients performance
 - Increased throughout of non-persistent messaging by up to 300%* (Distributed)

Preliminary results observed on pre-release level code.
For the latest performance information please click on
Performance Reports at www.ibm.com/webspheremq/support

WMQ Performance

Moving more JMS function into the MQI allows more function to run in compiled code

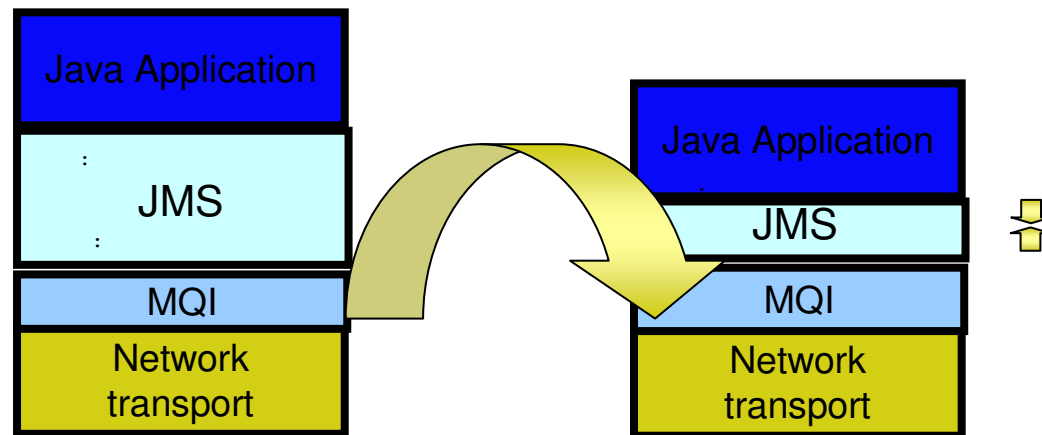

- **Persistent pub/sub throughput increased up to 60%**
- **Non-persistent client throughput increased up to 300%**
- **JMS Selector rates improved up to 250%**
- **Message Listener (MDB) throughput improved up to 45%**
 - Latency also improved
- **Measurements taken from pre-release code ; performance reports will be published as usual on SupportPac site**



Enhancing Web 2.0 Connectivity for IBM's SOA Messaging Backbone

3. WebSphere MQ goes Web 2.0!

- Helps enrich Web 2.0 applications with real business data
 - Distributed and z/OS platforms
- Developer needs no MQ skills
 - Uses Ajax and simple RESTful interface to access data by URIs
- Helps simplify deployment and maintenance of large scale distributed applications
 - Enables simple access to MQ without need to install MQ clients

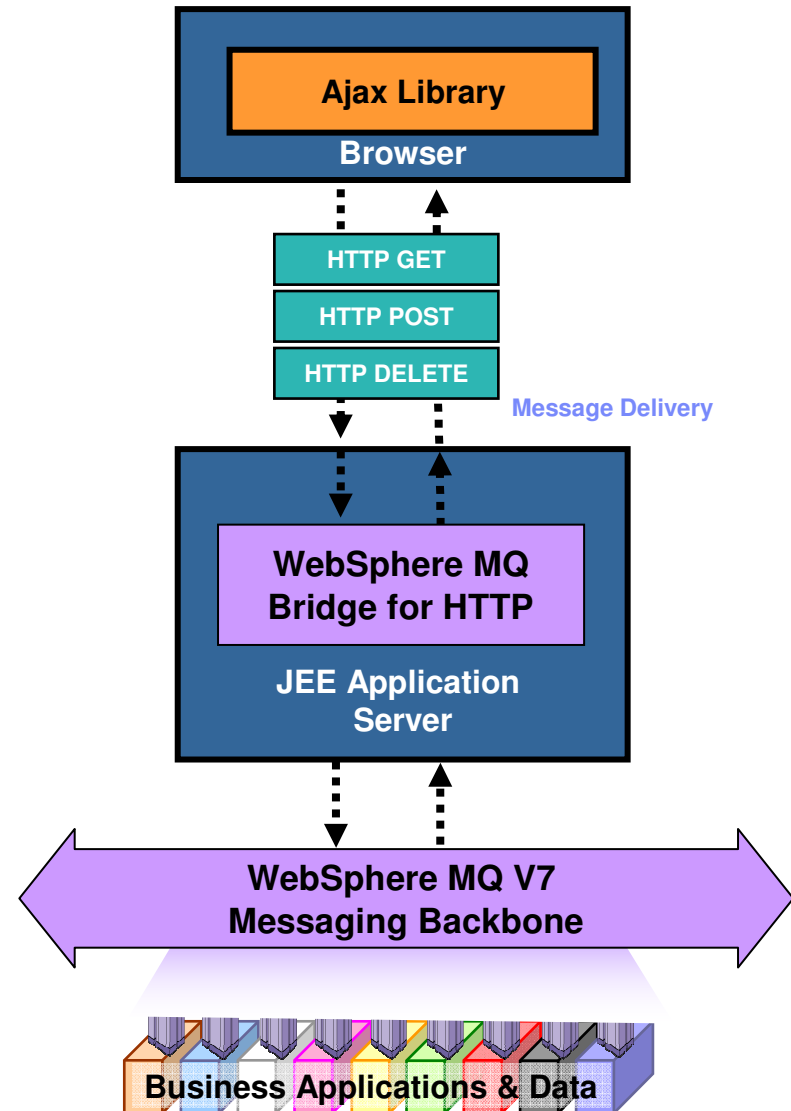

WebSphere MQ Bridge for HTTP - Architectural Overview

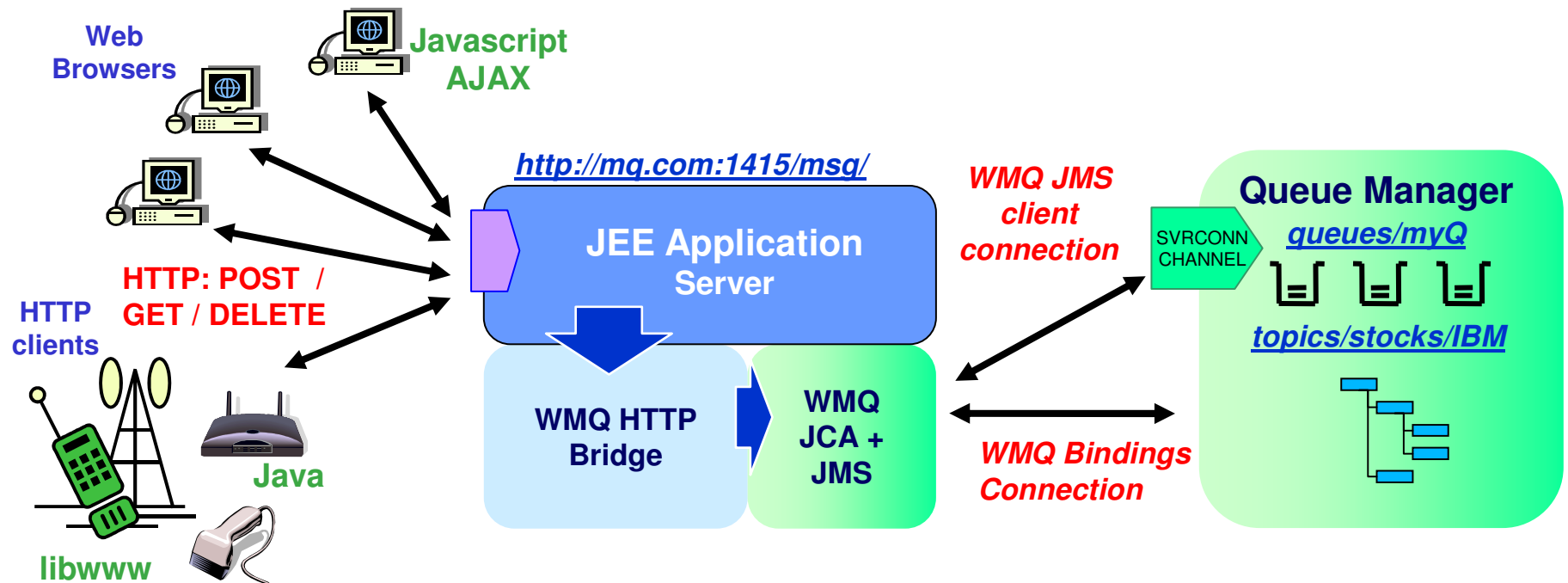

- Key features of the WebSphere MQ Bridge for HTTP -
 - Maps URIs to queues and topics
 - Enables MQPUT and MQGET from
 - Web Browser
 - Lightweight client
- Alternative non-servlet implementation available as MA94

HTTP-MQI Verb / Resource Mapping

- **Define URI to identify queue (or topic)**
- **Modelled on REST principles**
 - Simple translation of HTTP to MQI
- **Message Format:**
 - Header fields (MQMD) conveyed in HTTP headers
 - Body is passed in HTTP entity body
 - Message type is conveyed in HTTP Content-Type
 - “text/plain” or “text/html” equate to WMQ string messages (MQFMT_STRING)
 - All other media types map to WMQ binary messages (MQFMT_NONE)

		HTTP verb mapping			
Resource	Sample URIs	GET	POST	PUT	DELETE
Messages	http://host/msg/queue/qname/ http://host/msg/topic/topic_path/	MQGET w. browse	MQPUT	-	MQGET

Enabling Flexible Delivery on z/OS for IBM's SOA Messaging Backbone

4. Publish-and-Subscribe for z/OS

- Dynamic and flexible way of determining where messages are sent
- Helps reduce the cost, time and skills involved when changes are required
- Helps define new paths of information flow in an ad hoc manner

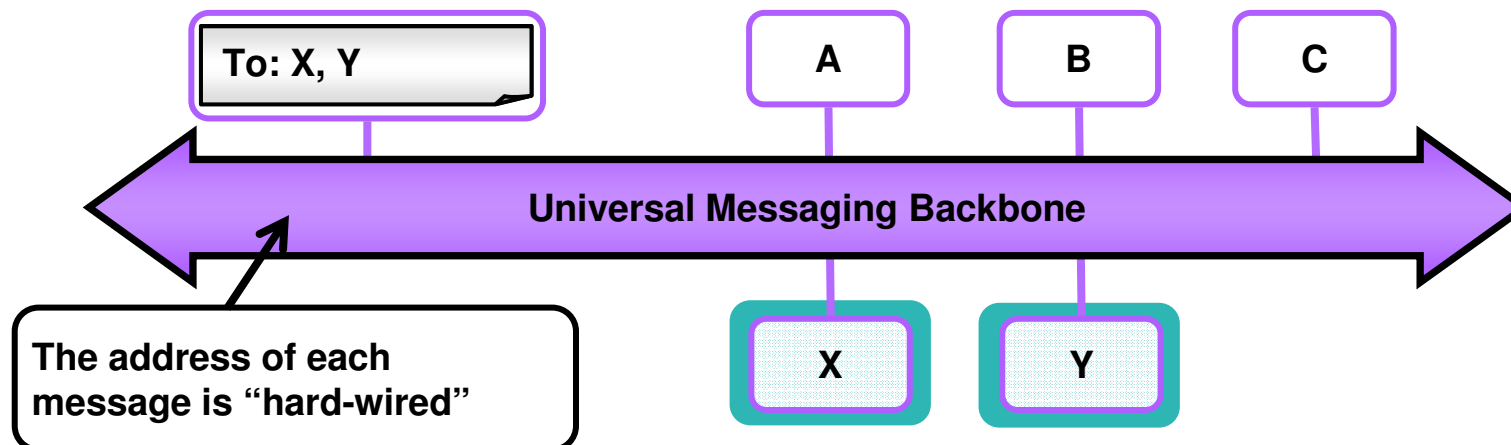

Enabling Flexible Delivery on z/OS for IBM's SOA Messaging Backbone

4. Publish-and-Subscribe for z/OS

- Dynamic and flexible way of determining where messages are sent
- Helps reduce the cost, time and skills involved when changes are required
- Helps define new paths of information flow in an ad hoc manner

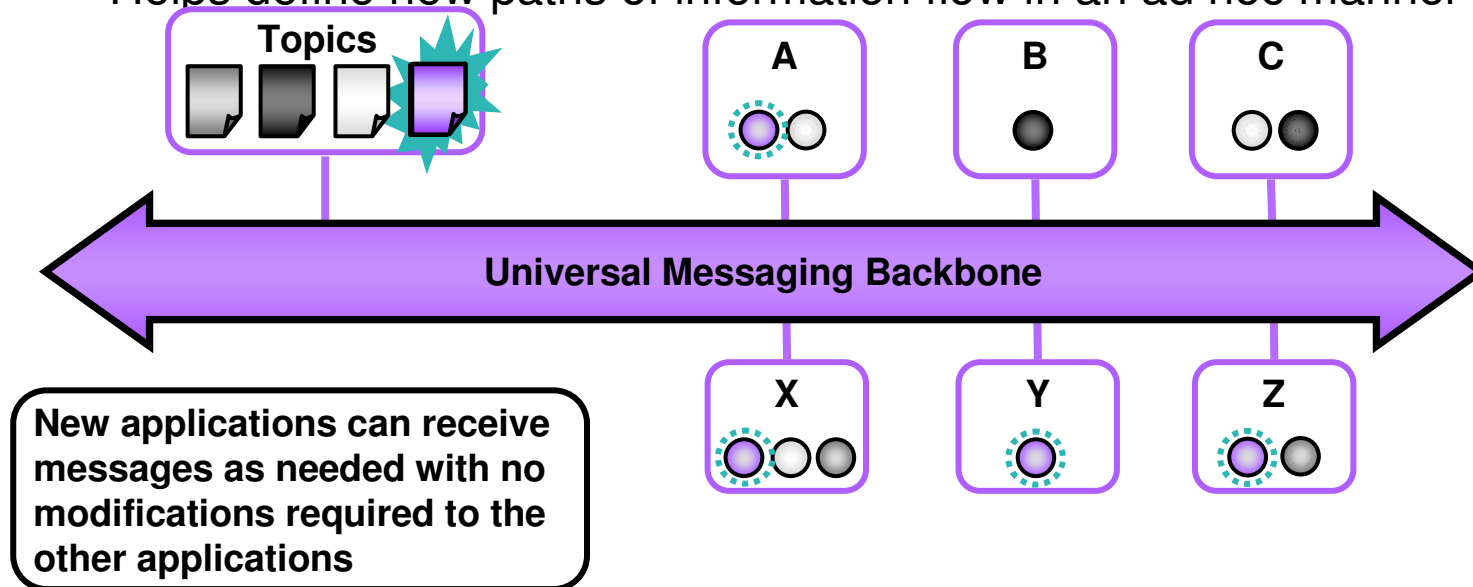

Publish/Subscribe is available for the first time on z/OS

- **A natural part of the JMS API**
 - Combines both Publish/Subscribe and Point-to-Point patterns
 - Now also a natural part of the native MQI
- **Point-to-point asynchronous messaging decouples applications**
 - But still implies a one-one relationship between sender and receiver
- **Publish/subscribe is a further stage of decoupling**
 - Sender has no direct knowledge of how many (if any) apps will see a message
 - Link between applications is a **Topic**, not a **Queue**
- **WMQ V6 (Distributed) included a Publish/Subscribe broker (formerly MA0C)**
 - Compatibility mode available in V7
- **Implementation substantially improved with V7**

Publish/Subscribe in the WMQ Explorer

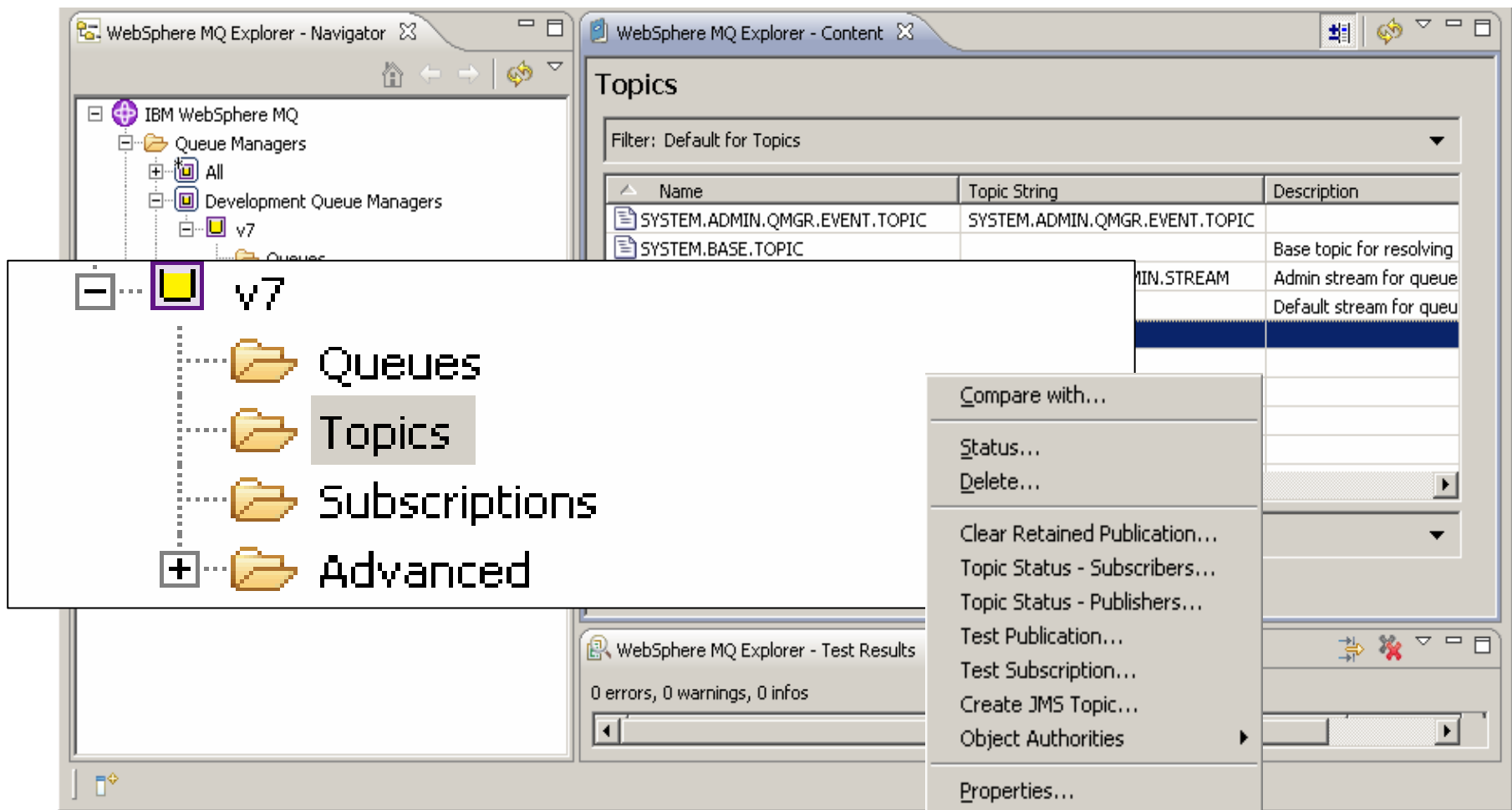

Publish/Subscribe Topologies

- **WMQ V6 publish/subscribe networks based on hierarchies**
 - All brokers linked in parent/child tree
- **WMB publish/subscribe networks based on hierarchies of collectives**
 - All systems in a collective are connected to each other (mesh)
 - Also has "clones"
- **New product built on hierarchies and clusters**
 - With interoperability to other pub/sub systems through hierarchies
- **Clusters are built on existing WMQ cluster technology**
 - Cluster can be defined independently of any existing cluster used for queuing
 - Behaves in a similar way to WMB collective
- **Design gives**
 - Scalability
 - Availability
 - Ease of administration

Publish/Subscribe Application Programming

- **Cannot significantly change the JMS API**
 - But we want some of its facilities more easily available in the MQI
 - To improve MQI programming and improve (make thinner) the JMS layer
 - JMS implementation exploits new MQI functions
- **New verb for subscribing**
 - So you do not need to build RFH or RFH2 headers in the application
 - **MQSUB** registers a subscription
 - Includes information about where messages will be read from
 - Do not need to specify a queue – can be automatically assigned
 - Retained publications delivered immediately after subscribing
- **New options on existing verbs**
 - MQOPEN to get access to a topic
 - MQCLOSE deregisters a subscription
 - MQPUT, MQGET to publish and to receive publications
- **Sample programs included to demonstrate use**

Queue Manager Sets

The screenshot shows the IBM WebSphere MQ Explorer interface. On the left, a tree view displays the hierarchy of Queue Managers. A white callout box highlights the following structure:

- Queue Managers
 - All
 - Development Queue Managers** (highlighted with a blue dashed border)
 - v7
 - Production Queue Managers
 - audi
 - QMA

On the right, the 'Content' pane shows the details for the selected 'Development Queue Managers' set, which is a manual set. A table lists the queue managers included in the set:

Queue manager name	Command level	Queue manager status	Platform	Queue-sharing group
qz	700	Running	Unix	

Benefits of V7 on z/OS Summary

1. Premier ease-of-use for improved developer productivity
 - Graphical configuration of JMS and Publish/Subscribe
 - New MQI verbs providing greater flexibility in retrieving messages, adding custom properties to messages and automatically notifying applications when messages arrive
 - **you can use the MQ Explorer, which runs on the Windows and Linux on x86 platforms, to manage the z/OS parts of your WebSphere MQ network without having to buy the Client Attach Feature**
2. Enhanced performance and usability for JMS and MQI users
 - Increases in JMS and Publish/Subscribe performance - **Increasing JMS listener throughput by up to 220%* on z/OS – spending less MIPS!**
 - Increase throughput and resilience of MQ client connections
3. New Publish-and-subscribe for z/OS users
 - **Enables event driven delivery of messages increasing flexibility of messaging to help reduce time, effort and costs of introducing new applications and making changes to existing**
 - WebSphere MQ V5.3 for z/OS End of Service effective 30 Apr 2008
4. Enhanced connectivity for Web 2.0 developers
 - Enables developers to use Ajax to build Web 2.0 applications that connect to the backend business applications and data
 - Provides Bridge for HTTP enabling simple, REST-style access to WebSphere MQ
 - **Helps simplify deployment and maintenance of large scale distributed applications**
 - **Enables simple access to MQ without need to install MQ clients**



MQ and Web Services



WebSphere MQ makes Reliable Web services possible

- **Many developers today connect Web services using HTTP**
 - May seem “good-enough” to start with but doesn’t address reliability and auditability and locks-up the services whilst they are communicating

WebSphere MQ provides a layer of messaging services to help make SOAP exchanges:

- ✓ *More reliable than those sent over HTTP*
- ✓ *Transactional – allowing service resources to be updated atomically so they retain integrity and failures can be recovered and retried*
- ✓ *Arrive in the same order as they were sent*
- ✓ *Decoupled in time – so that they can handle other requests whilst waiting for responses*
- ✓ *Buffered so that SOAP requests can be throttled for batch-style Web services*
- ✓ *Clustered so that SOAP requests can be processed in parallel by multiple service providers*
- ✓ *Easily integrated with applications that are not enabled for SOA*
- ✓ *More auditable*

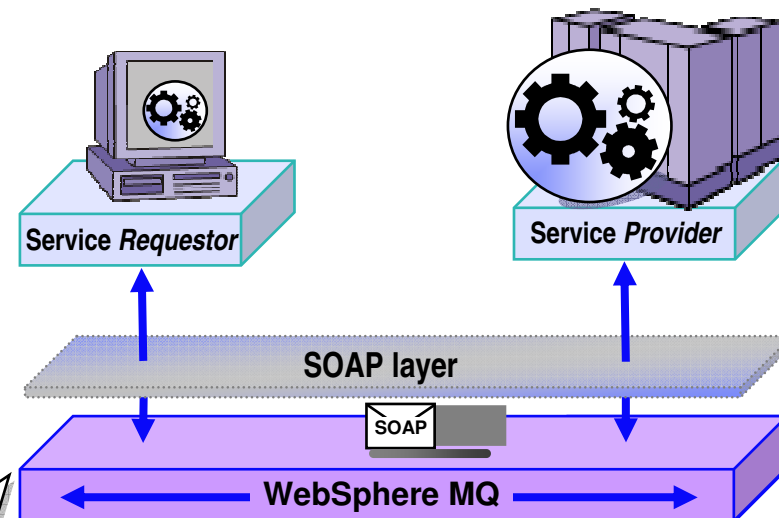

- **Web services that interoperate with HTTP will also work with WebSphere MQ**
- **Sender and listener support for**
 - Axis host Web services environment
 - .NET host Web services environment

Standards - WS-* and SOAP / WMQ-JMS

- **WMQ acts as a SOAP transport for WS-* Web services and this offers a number of advantages compared to HTTP transport -**
 - Improved reliability – invaluable for one-way message exchange patterns – since with HTTP there is no way for the Web service requestor to know if the request has been successful. SOAP/JMS is really capable of fire-and-forget
 - Manageability
 - WMQ / JMS messages are more tangible and traceable than HTTP requests
 - Asynchronous invocation
 - Limited (short term) asynchrony has existed in .NET for some time, and it has been added to Java JAX-WS. This does not offer any guidance on how to persist and correlate requests over a long time. True queued asynchrony adds resilience – (both parties don't need to be running at the same time), and requests can be longer running than typical HTTP request.
- **SupportPac MA0R was incorporated into WMQ v6**
- **Defines how SOAP messages should be carried over WMQ - thus ensuring interoperability between CICS, MQ, and WAS**

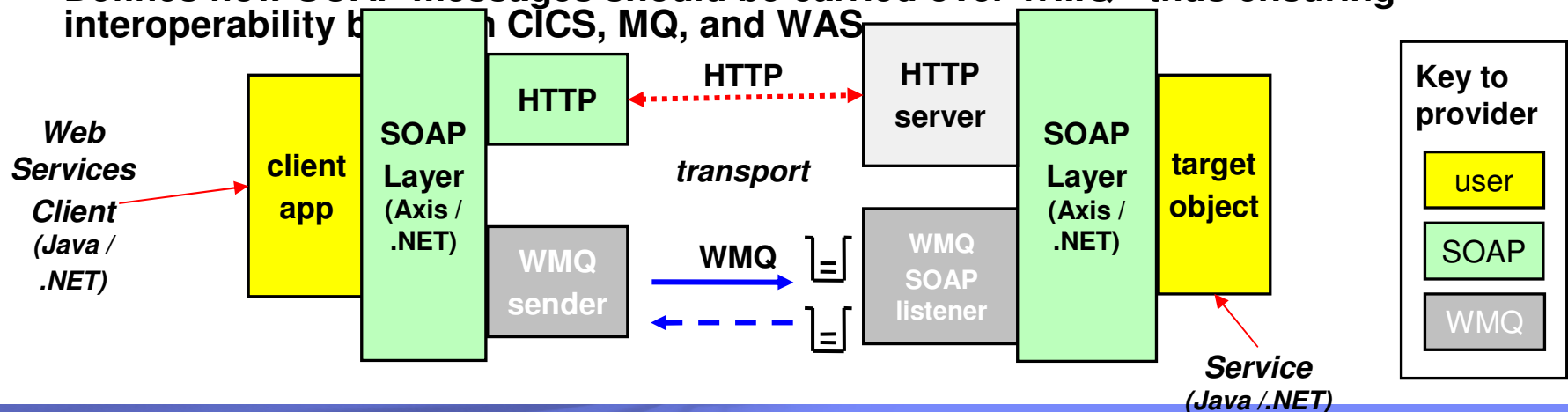

WMQ as an SOA Asset - Service Descriptions

- **A standard way to describe all WMQ apps as SOA assets (services)**
 - To be inventoried, and catalogued in Service Registry
 - To be re-used as services in composite SOA applications
 - To be managed and traced with SOA tools
- **IBM has created the WMQ Service Definition and SOAP binding**
 - IRI for WMQ addresses (“wmq:”)
 - Message destinations - Queues or Topics
 - Other resources - Qmgrs, channels, channel status etc.
 - WSDL bindings to define application properties
 - Also defines the Message Exchange Pattern; Request queue; Response queue; Correlation style; Message format; Message persistence, priority etc.
- **Published as SupportPac MA93**

A single JMS provider for all application servers

- **Other vendors have also implemented SOAP/JMS**
 - Sonic, TIBCO, BEA, Axis
- **Interoperability is required for heterogeneous environments**
 - Vendor solutions can not interoperate on the wire (JMS is a standard API but not a standard wire format)
- ...but *should* be able to interoperate at the API level – e.g. WAS -> WebLogic

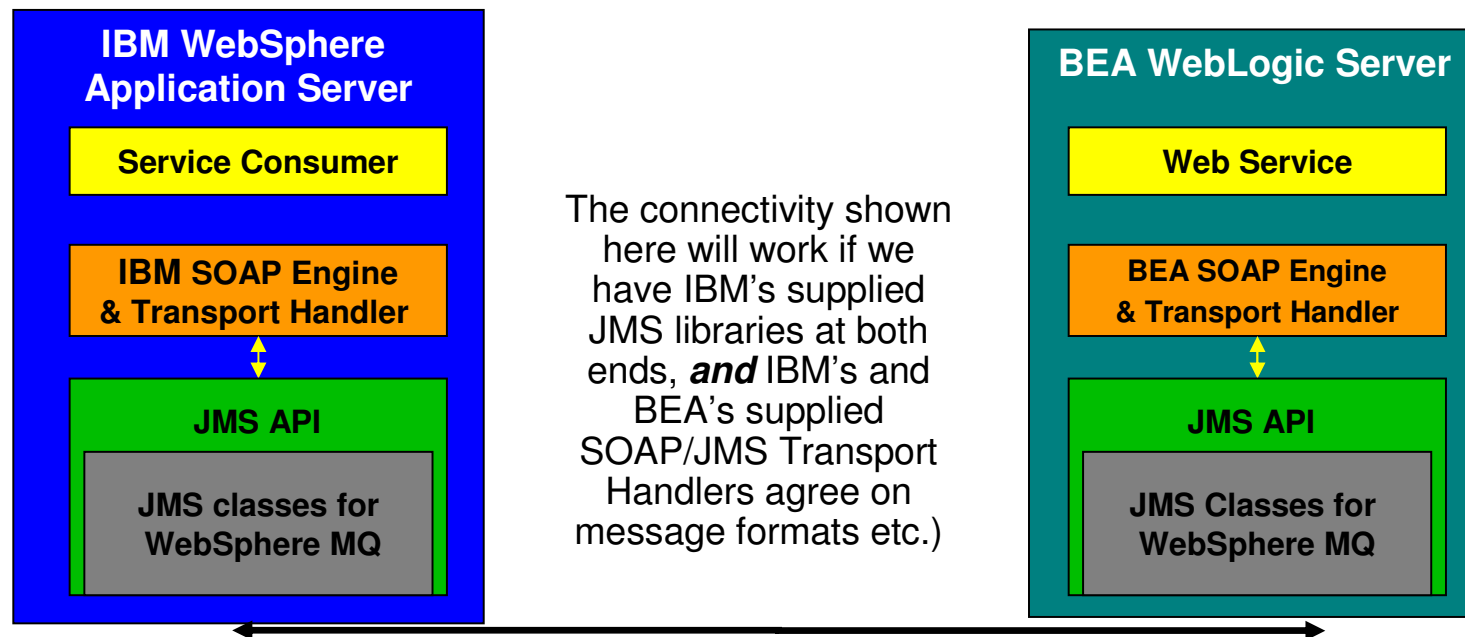
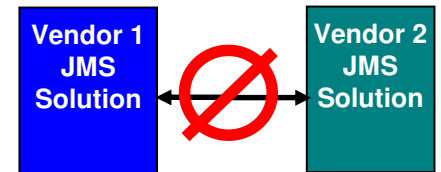

- ★ **Reduced implementation cost: no need to implement bridge between providers**
- ★ **Reduced operational cost: single infrastructure to deploy and manage**



WebSphere MQ and Linux for System z

Why zLinux?

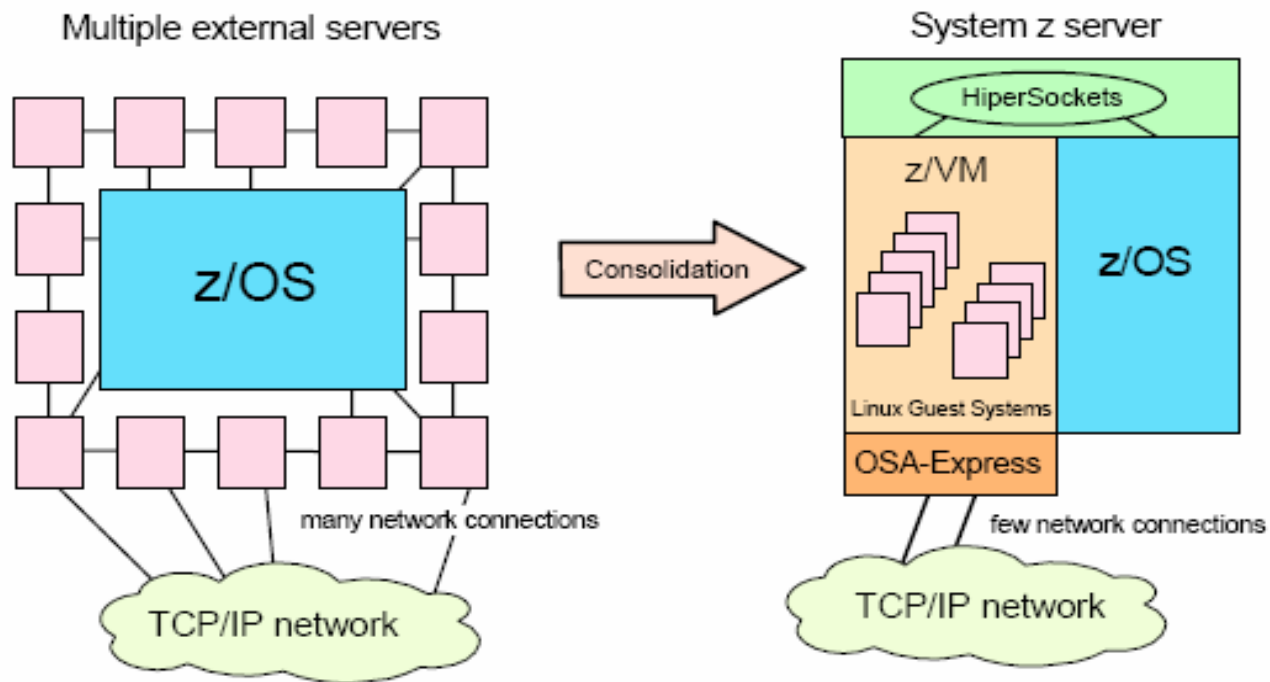

Common Usage Patterns – WMQ

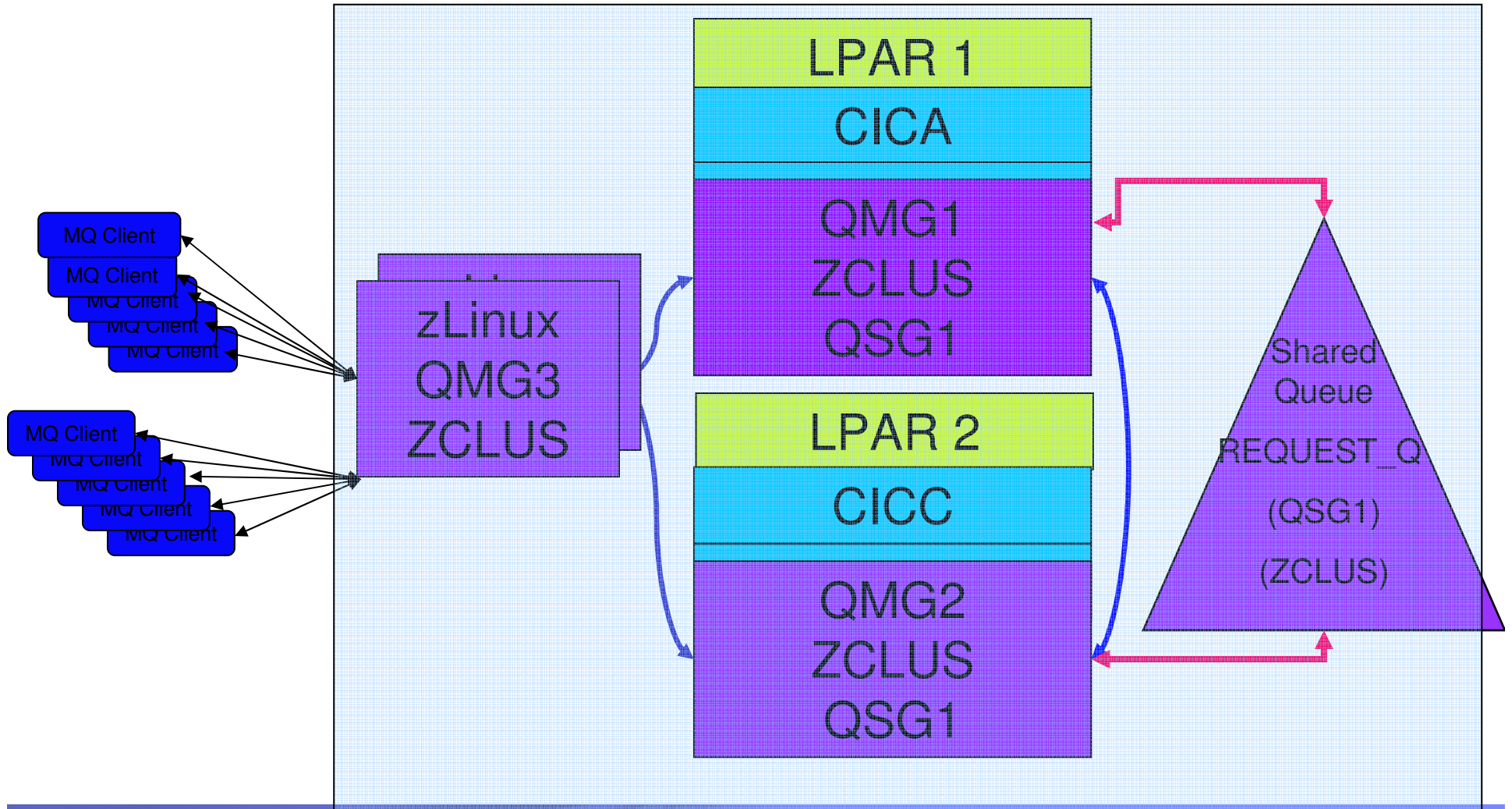

Why WMQ on zLinux?

- **The same code base WMQ on distributed platforms**
- **Queue Manager consolidation:**
 - One customer reported replacing 10 queue managers on distributed servers with 1 queue manager on zLinux with no degradation in throughput
 - Others have reported replacing multiple instances, though not usually as dramatic
 - Best results are for 'client connections', where the back end processing is on z/OS
- **Stability:**
 - Customer reported replacing 8 Windows servers running WMQ and applications with two zLinux instances running the same stack
 - Downtime has been dramatically reduced
 - Added benefit of reducing software licensing



MQ and Files



What is WebSphere MQ File Transfer Edition for z/OS V7?

- **Adds file transfer services on top of WebSphere MQ to enable movement of files – regardless of size – in a managed way (reliable, auditable, secure)**
 - Provides multi-purpose infrastructure – for both files and messages
- **OTC add-on product that pre-reqs WebSphere MQ for z/OS (MLC)**
 - Complemented by distributed product

- ✓ Flexible backbone for transfers – not a single-hop solution like FTP
- ✓ Multi-purpose – use for messages and files
- ✓ Auditable with logging subsystem that tracks transfer at source and at destination for audit purposes
- ✓ Massive files – larger than MQ messages
- ✓ Reliability leveraging the MQ transport
- ✓ Integration with MQ-enabled apps and ESBs
- ✓ No need to program – no need to use APIs
- ✓ Simple graphical tooling enabling remote configuration
- ✓ Automatic file conversion and compression
- ✓ Security - of file payload using SSL
- ✓ Visual transfer status reporting
- ✓ Support for many supported MQ environments

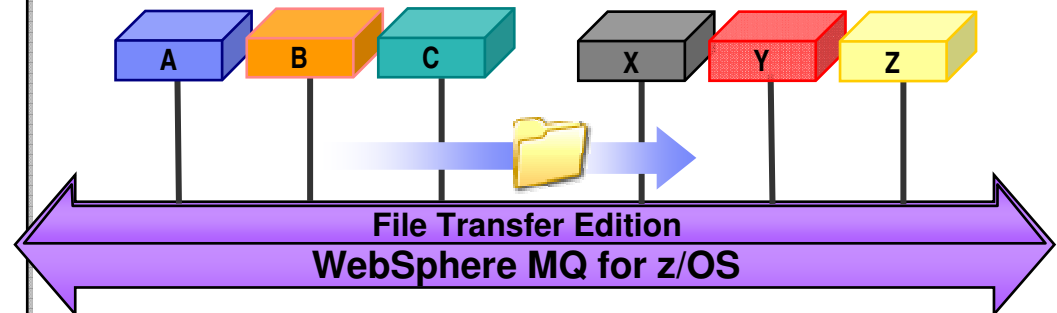

Helps make managed file transfer deployments an integral portion of overall integration projects and strategies, ensuring tight integration with the enterprise nervous system

Architecture

- Enables remote GUI configuration and admin using same tooling as WebSphere MQ
- Tooling publishes transfer requests to Backbone
- “Agents” running alongside Queues managers publish audit trail to Coordination Queue Manager
- “Agents” monitor file directories, load/unload files & perform pre- & post-transfer activities
- Coordination Queue manager publishes transfer status, process and audit trail
- Coordination Queue manager requires WebSphere MQ V7.0
- Multiple Coordination Queue managers could control transfers, capture audit log and publish status

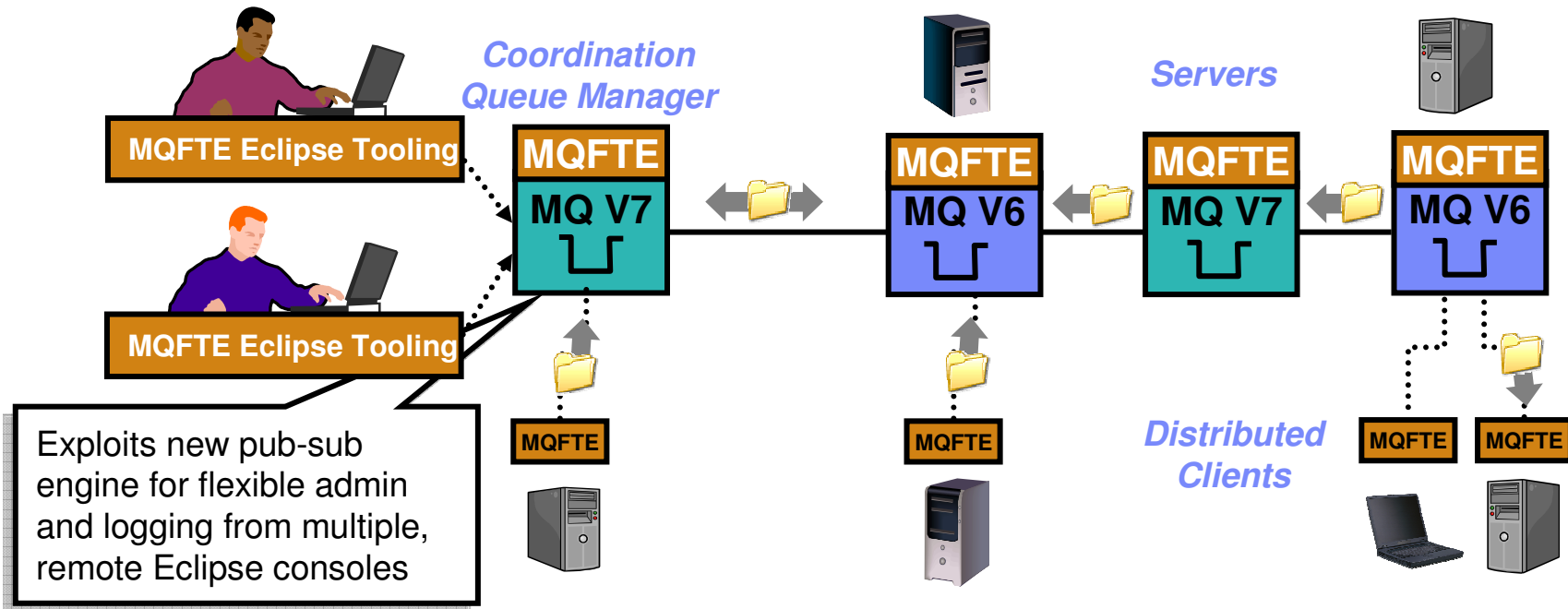

Product roadmap, timeframes and features subject to change and not to be viewed as IBM commitments

The Coordination Queue Manager

- **Collects information about**
 - progress of active transfers (active transfer log)
 - Auditable History of past transfers
- **Holds information about Agents defined in the WebSphere MQ File Transfer Edition network**
- **Has a SYSTEM.FTE queue and topic defined to it as part of the configuration used internally by the product**
- **Must be at MQ V7**
- **All AGENTS in the network must have access to this Queue Manager in order to publish transfer log processing messages**
- **No WebSphere MQ File Transfer Edition code runs on this queue Manager**

The *Command* Queue Manager

- **Used to get commands into the WebSphere MQ File Transfer Edition network**
- **Can be be at MQ V7 or MQ V6**
- **Can have multiple *Command* Queue Managers defined for multiple command injection points**
- **No WebSphere MQ File Transfer Edition code runs on this queue Manager**
- **(could be the same Queue Manager as the Coordination Queue Manager or different)**

The *Agent* Queue Manager

- **The Queue Manager to which an Agent in the WebSphere MQ File Transfer Edition network is attached**
- **Used by an AGENT to send/ receive files across MQ**
- **Can be be at MQ V7 or MQ V6**
- **Can have multiple AGENTS attached to it**
- **Requires capacity planning dependent on load**

Eclipse-based GUI integrated into MQ Explorer

The screenshot displays the IBM WebSphere MQ Explorer interface. The left pane shows a tree view of JMS Administered Objects, with 'Managed File Transfer' and its sub-objects highlighted. The main pane shows the configuration for 'Managed File Transfer' under 'hursMFTE1', including Transfer Templates, Transfer History, Current Transfers, Scheduled Transfers, and Transfer Agents (TxAgent1, TxAgent2, TxAgent3). A summary table at the bottom shows the progress of two transfers.

Managed File Transfer

WebSphere MQ File Transfer Edition is new product in the WebSphere MQ product family offering Managed File Transfer capabilities, including:

- Moving files between IT systems reliably and securely regardless of their size.
- Robustness and resilience to failures
- Logging of file movements for audit purposes
- Automation of all aspects of transfers (Eliminating the need to manually detect transfer problems and restart transfers.)
- Scheduling of transfers

JMS Administered Objects

- Managed File Transfer
 - Transfer Templates
 - Transfer History
 - Current Transfers
 - Scheduled Transfers
 - Transfer Agents
 - TxAgent1
 - TxAgent2
 - TxAgent3

Summary transfer progress

Name	Source	Dest	File number	Current file	Rate	Started (local)
Tx001	agent1 .../sourceDir	agent2 .../destDir	1 / 1	ubuntu-710.iso (320kB / 699 MB)	34kB/s	20080416-23:22.00000
Tx002	agent1 .../sourceDir	agent2 .../destDir	38 / 754	MQ7-license.txt (5B / 13 kB)	28kB/s	20080416-23:40.00000

Product roadmap, timeframes and features subject to change and not to be viewed as IBM commitments

Regulatory Compliance Audits of Transfers

▪ Pain points

- File transfers impossible to audit – exposing risks of non-compliance with regulations e.g. Sarbanes-Oxley, MiFID, HIPAA etc
- Unreliable nature of FTP means transfer failures need to be detected (by writing application code) and re-sent (consuming network bandwidth) increasing the batch-window needed to transfer files
- Inflexible nature of FTP means that development and maintenance costs resulting from application changes are spiraling so that each additional change is more costly, takes longer and carries greater risk of disruption

- Solution provides ability to track movement of files end-to-end as these move around organization

- Improving ability to meet regulatory compliance obligations in demonstrating the integrity of data in motion and of business data used to compile financial reports
- Improving the reliability of file transfers so that applications no longer need to detect transfer failures, corrupted or partially transmitted files and avoiding need to always re-transfer entire batches of files when failures occur
- Increasing flexibility of infrastructure so changes to hardware, O/S, applications and networks do not require re-work of distributed tra

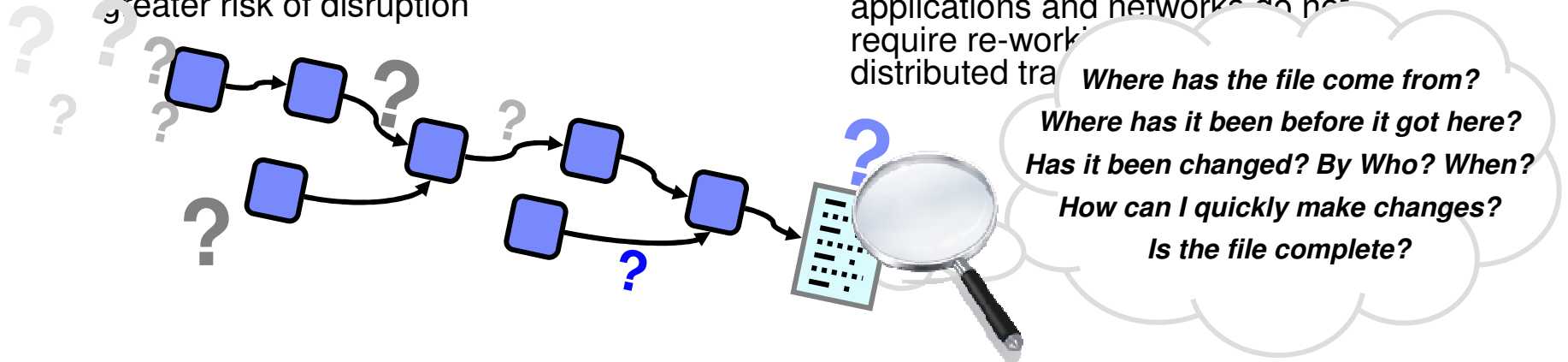

Auditing File Transfers

WebSphere MQ Explorer

Transfer History

Filter: Default for transfer history

Name	Source Agent	Source File	Target Agent	Target File	Started (UTC)	Completion State	State recorded (UTC)	Owner
Tx001	TxAgent1	/home/greg/ recip	RxAgent1	/recipes/greg	20080416-23:22.00000	✓ Completed	20080822-23:59.00000	Bob Builder
Tx002	TxAgent2	/home/greg/ recip	RxAgent2	/recipes/greg	20080416-23:22.00000	✗ Failed	20080822-23:59.00000	Bob Builder
Tx003	TxAgent2	/home/greg/ recip	RxAgent2	recipes/greg	20080416-23:22.00000	▣ Partial - in progress	20080822-23:59.00000	Bob Builder
Tx004	TxAgent3	/home/greg/ recip	RxAgent3	/recipes/greg		⌚ Not yet started	20080822-23:59.00000	Bob Builder

- Captures log at Source and Target
- Can be viewed remotely using MQ Explorer
- Applications can subscribe to audit information (or portions of it)
- Log records can be loaded into other systems e.g. SQL database

Product roadmap, timeframes and features subject to change and not to be viewed as IBM commitments

Redundant Infrastructure consuming IT resources

- Developing and maintaining entire parallel infrastructures
 - One for files – typically built on FTP – and one for application messaging – based on WebSphere MQ or similar
- Pain points
 - Duplicate maintenance burden is sucking time and resources from IT team and inhibiting progress with other initiatives e.g. SOA
 - Operations teams are duplicating administration of both infrastructures with poor traceability for file transfers and for data passing between these infrastructures
- Solution provides the ability to consolidate these duplicate infrastructures into one single universal transport for both messages and files
 - Operational savings and simplification
 - Reduced administration effort
 - Reduced skills requirements and maintenance
 - Improved reliability, auditability and security of File Transfers
 - Infrastructure that can be re-used as basis for SOA as opposed to FTP

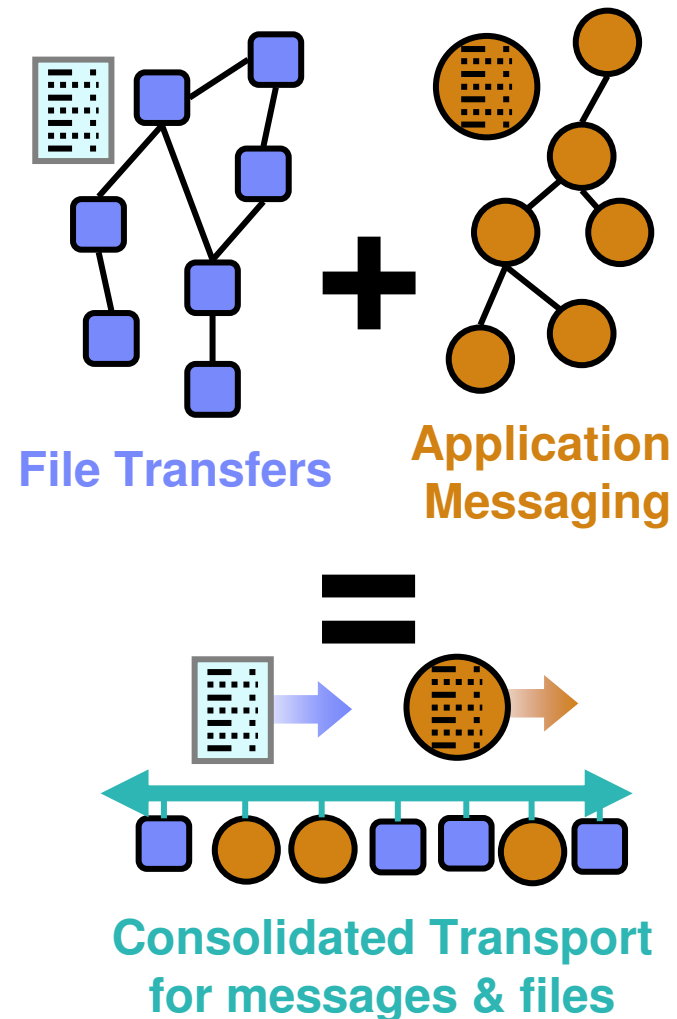

WebSphere MQ Version 7 - Summary

- **Improvements to publish/subscribe**
- **Improvements to JMS layer**
- **Ease-of-use for administrators**
- **Ease-of-use for MQI programmers**
- **Performance**
- **Continues to extend the enterprise messaging foundation in the SOA world**
- **Key Dates:**
 - Distributed V5.3 End of Service in **September 2007**
 - z/OS V5.3.1 End of Service in **April 2008**
 - Fee-based service extensions normally available for an extra 2 years
 - V6 - No End of Service or Withdrawal from Marketing dates set
 - V7 - Announcement 1 April 2008
 - V7 - GA 27 June 08
 - File Transfer edition V7.0 planned availability Dec 2008
 - Look at URL for most recent info
 - <http://www-306.ibm.com/software/info/supportlifecycle/>

Next Steps and more information

- **Talk with your IBM representative and IBM Business Partners to identify ways to help achieve your business goals with WebSphere MQ**

- **More information about WebSphere MQ can be found here**
 - www.ibm.com/webspheremq
 - www.ibm.com/software/integration/wmq/zos/

- **WebSphere MQ File Transfer Edition**
 - <http://www-306.ibm.com/software/integration/wmq/filetransfer/>

- **Additional materials**
 - White paper: The Value of WebSphere MQ for z/OS for the CICS customers
<ftp://ftp.software.ibm.com/software/integration/wmq/WSW11355-USEN-00.pdf>
 - Article: Connecting System z applications with IBM WebSphere MQ on z/OS <http://www-306.ibm.com/software/tivoli/features/ccr2/ccr2-2007-12/connecting.html>
 - Teleconference: WebSphere MQ for z/OS V7 as the messaging backbone for SOA, Web 2.0 and file transfer <http://www-01.ibm.com/software/os/systemz/telecon/jan7/>
 - Teleconference: Introducing reliable, Managed File Transfer for z/OS
<http://www.ibm.com/software/os/systemz/telecon/27aug/index.html>

Thank
YOU





Additional Information



WebSphere MQ V6 Updates

- **XMS (1Q06: SupportPacs)**
- **IBM Support Assistant (1Q06: 6.0.1.1)**
 - Makes it easier to access product information and raise defects
- **New Plug-ins for the WMQ Explorer (Sep/Oct 06: SupportPac & 6.0.2.0)**
 - And continuing Cat2 Plug-in releases
- **JCA for JMS (1Q07: 6.0.2.1)**
 - Makes it easier to use WMQ JMS in any J2EE-compliant application server
- **Support for 64-bit Windows on x86-64 and 64-bit JVM on z/OS (1Q07: 6.0.2.1)**
 - Windows "Toleration": no 64-bit application support
- **HTTP interface (2H07: SupportPacs MA0Y, MA94)**
- **External Security Certifications**
 - CC EAL4, FSTEC



Migrating to WebSphere MQ for z/OS V7

General Guidance and Q&As

July 2008

MQ Version to Version Migration

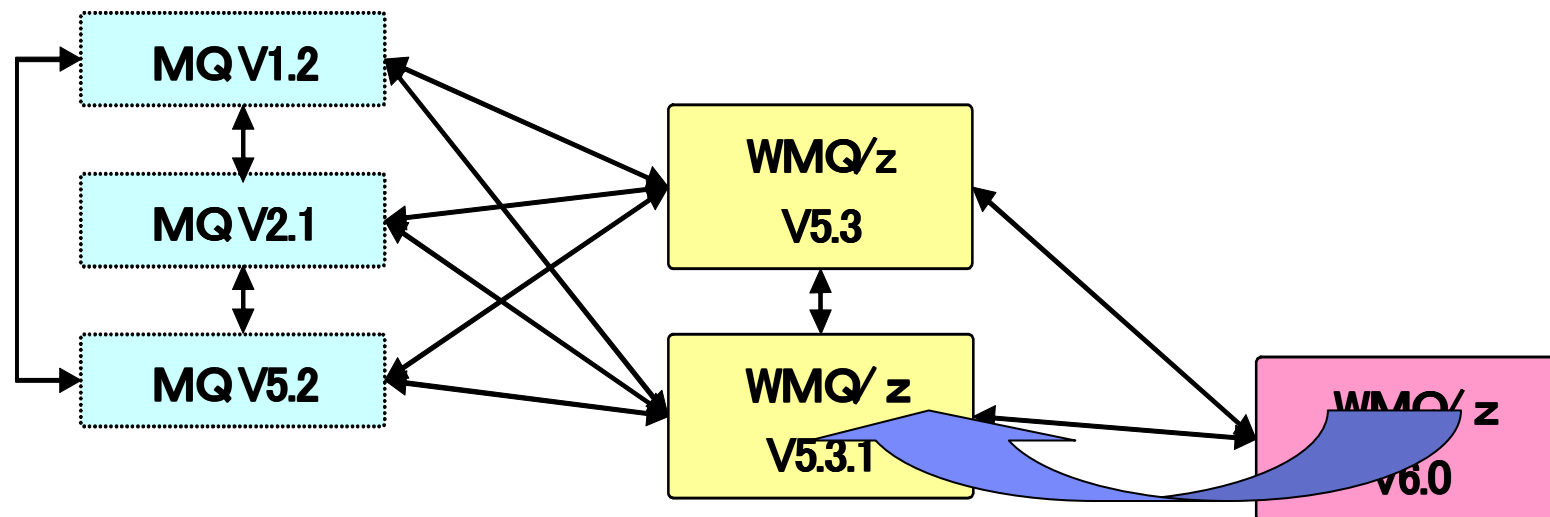

Supported backward
migration path till 30 April 2008

Recommendation: migrate from older versions straight to MQ V6

Prior to MQ V5.3 the Product was called MQSeries

MQ Version migration to MQ V7

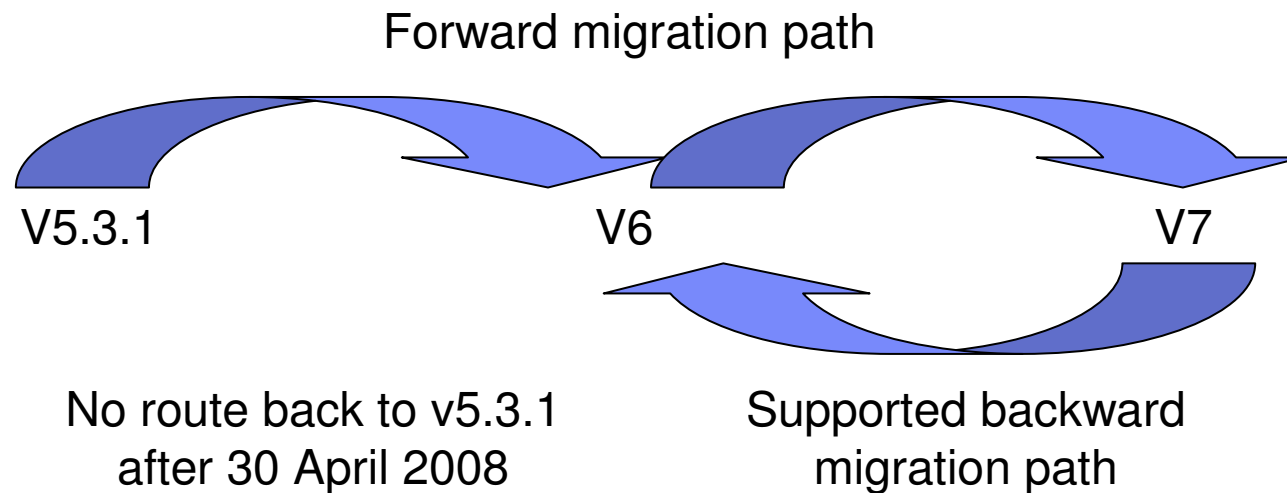

Customers still on MQ V5.3.1 should not wait for MQ V7

Notes:

1. **The following v6 APARs are required if you are using Queue Sharing Groups (QSGs) and/or need rollback capability.**
Target date for delivery: End of September 2008
 - **To enable coexistence of v6 and v7 Qmgrs in a QSG: PK64466**
 - **To enable backward migration from v7 to v6: PK64463**

Alternative Path to MQ V7

Forward migration path

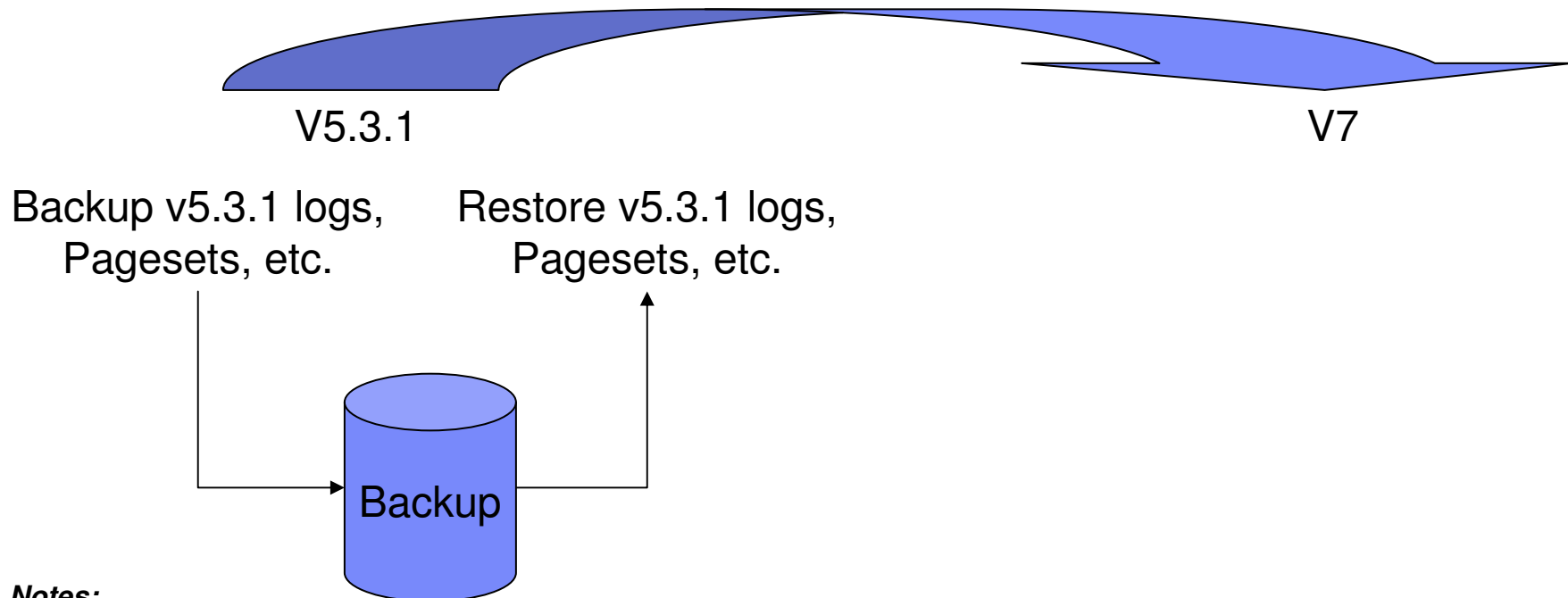

Notes:

1. *If any v5.3.1 queue managers to be migrated are members of a Queue Sharing Group (QSG), then all queue managers in the QSG will have to be upgraded to v7 at the same time.*
2. *If you do choose to go back to v5.3.1, any work done under v7 will effectively be lost.*
3. *Only consider this option if:*
 - *You do not need experience for your production migration.*
 - *You don't use queue sharing groups or you have sufficient knowledge and experience for migrating QSG definitions.*
 - *You know you will never have to fallback.*
 - *You understand the risks of using unsupported v5.3.1 code from its end of service until you choose to install V7.*

Q & A

- Question: **WMQ V7 slides state that it's possible "... to migrate up to v7 from v531 but there will be no support for fall back to v531". What does this mean in detail, particularly to QSG users?**
 - **Answer:** This means that you will be able to stop your qmgr(s) at v531. Perform migration actions, then restart them at v7. However, if things go wrong, there is no path back to v531. You are reliant on having taken backups of your qmgr logs (containing CF structure backups for shared queues), pagesets and DB2 tables prior to performing the migration actions and restoring them should you need to revert to the v531 configuration. Specifically, a v531 qmgr will not startup in a QSG that has been migrated to v7, a v531 qmgr will not startup if its pagesets have been used in a v7 qmgr.

- Question: **There definitely is *no* utility that updates QSG DB2 tables for compatibility between V5 and V7. From this, I conclude that - all members of a QSG have to be switched to V7 at one time (if the "switch" is from V531 Y V7) -- TRUE?**
 - **Answer:** Correct. We provide job CSQ45ATB which adds additional tables and columns to existing tables as required by a V7 qmgr. Running this job is one of the migration actions. As you are avoiding V6 you will have a disruptive migration path to V7 - it is not possible to maintain availability of the QSG during migration.

Q & A (Continued)

- Question: **v531 Shared queue object definitions can only be "migrated" by means of saving them at v531 and restoring them at v7 -TRUE?**
 - **Answer:** Saving the definitions is required to re-activate them at the V7 level, because the DB2 tables have to re-built from scratch (at the V7 layout). In addition, saving definitions prior to migration is a sensible precaution. You will have to restore them if you needed to fallback to the v531 configuration.

- Question: **What about shared queue messages (CF structure contents)? Will a queue manager started at v7 be able to access CF structures and their contents, as they have been left over by the v531 queue manager?**
 - **Answer:** Yes

Q & A (Continued)

- **Question: I understand that the "migration" surely can be done by means of a WMQ cold start at v7, after definitions and (if necessary) queue contents have been saved at the old V5 level- with both logs, BSDSs and PSIDs created new. The question is: will/ should it be possible to keep the PSID contents, thus preserving (non-shared) object definitions and messages and just newly create the logs and the BSDSs, apply the CSQUTIL/RESETPAGE function to the PSIDs, and then restart at v7 (of course, the DB2 stuff would have to be re-created new completely). So, will v7 be able to work with a consistent set of PSIDs produced and closed at v5?**
 - **Answer:** It will be possible to cleanly stop a qmgr at v5.3.1. Perform the migration actions, then restart that qmgr at v7 without loss of persistent messages and other data. This would be our advised approach (rather than the cold starting you mention above - if you cannot afford to go via v6)



Introduction to WebSphere MQ for z/OS concepts



WebSphere MQ connects virtually anything

WebSphere MQ has probably the software industry's **broadest** support for:

- programming languages
- messaging interfaces
- application environments
- OS platforms

Ubiquity of support gives developers the freedom to choose the technologies they prefer and already have skills in and can connect together what they already have...

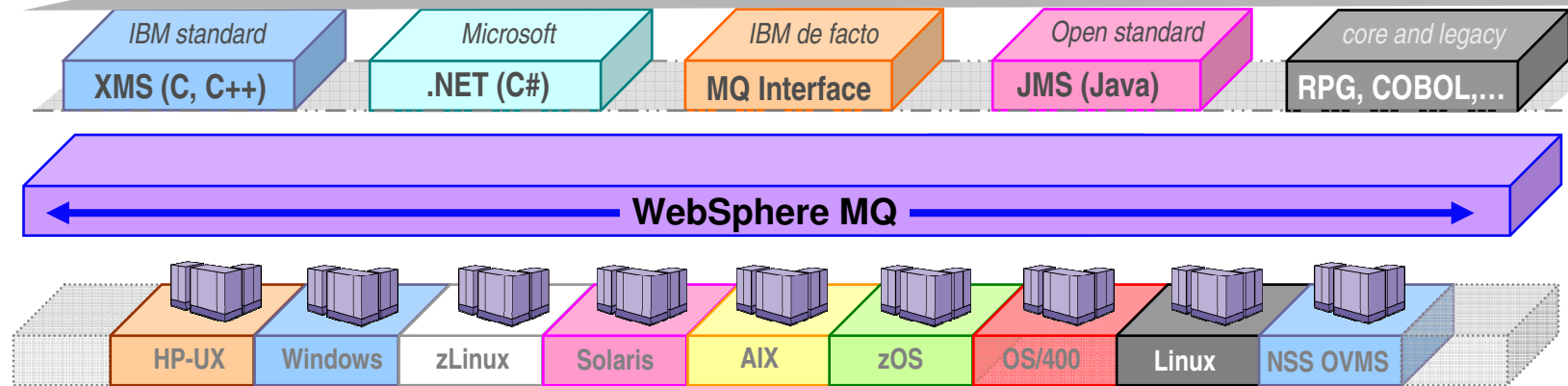

80+ platform configurations

How does WebSphere MQ work?

- **Connects applications using Messages sent via Queues.**
- **Queues are owned by Queue Managers which store and forward messages.**
- **Routing is dynamic and configurable**
- This allows applications to be very loosely coupled...
 - Cuts location dependencies
 - Sender does not need to know where the receiver is running
 - Cuts timing dependencies (asynchronous)
 - Sender does not need to know whether the receiver is running
 - Cuts platform dependencies
 - Sender does not need to know the platform the receiver is running
 - Cuts data dependencies
 - With a Broker they do not even need to agree on the data format

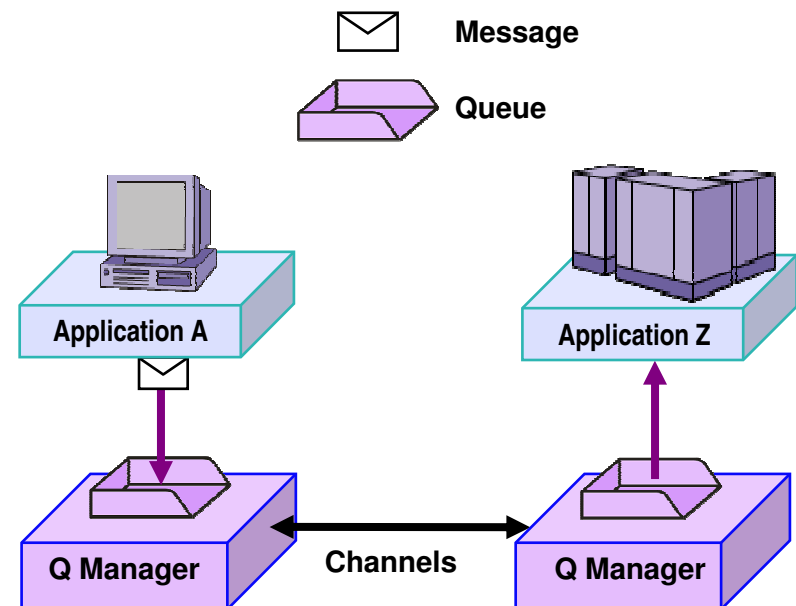

Pseudo-synchronous or asynchronous styles

Customer-facing transaction.
Pseudo-synchronous does NOT mean slow !!

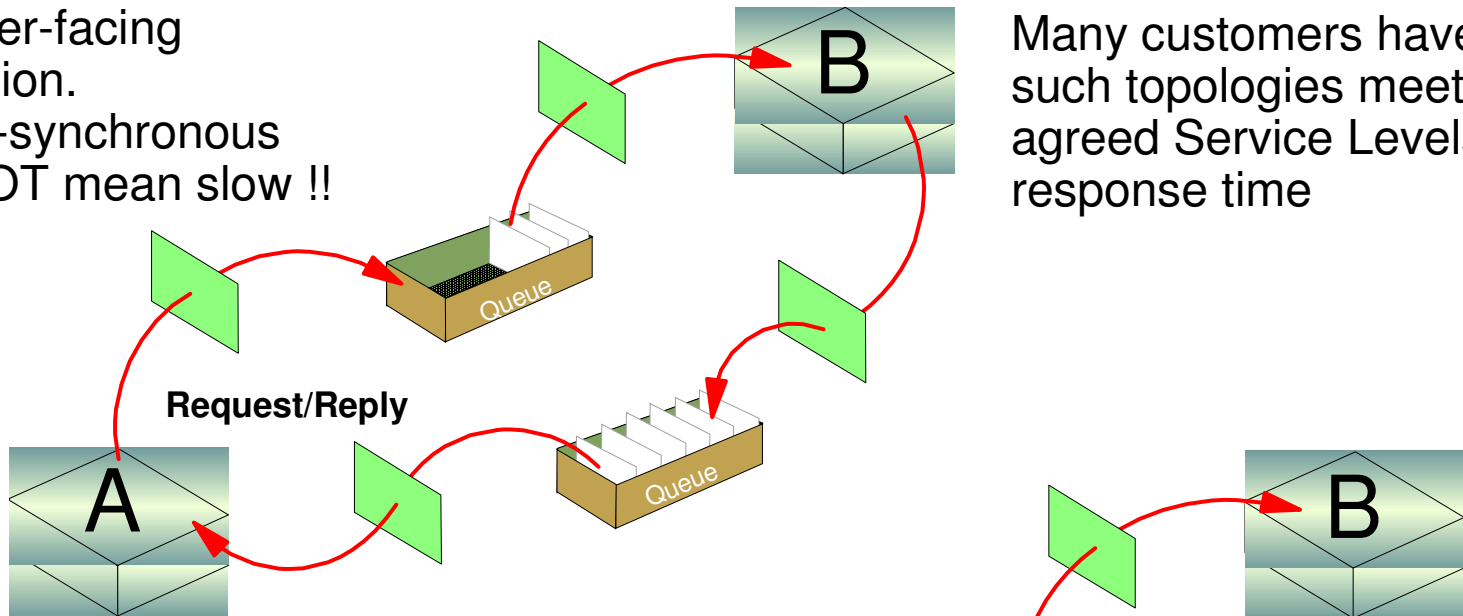

Many customers have such topologies meeting agreed Service Levels of response time

Could also be a Customer-facing transaction but no response is required.

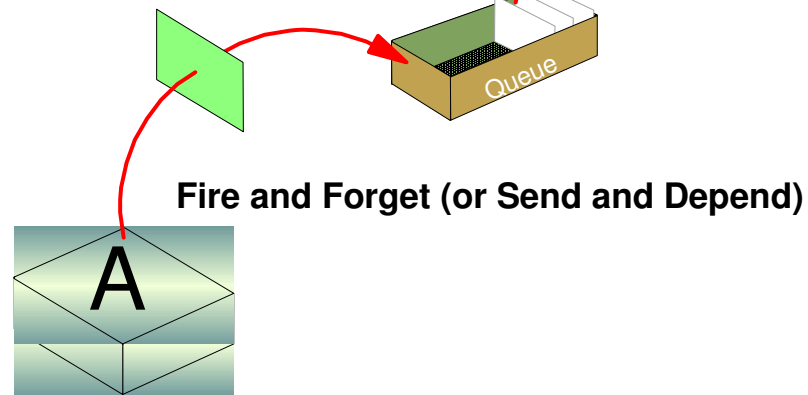

Pseudo-synchronous and asynchronous styles

Enables parallel processing

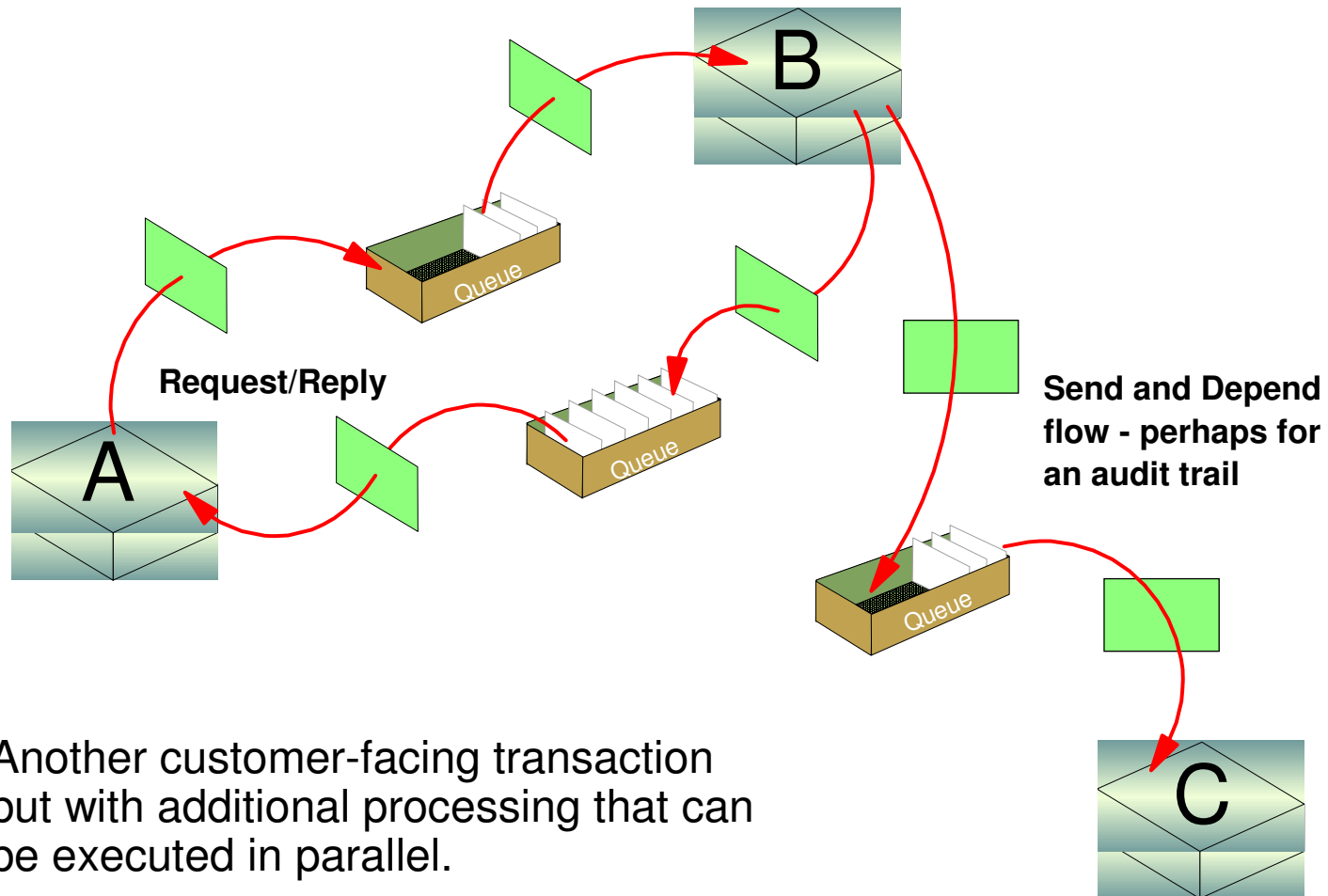

Another customer-facing transaction but with additional processing that can be executed in parallel.

Transactional support ensures all or nothing

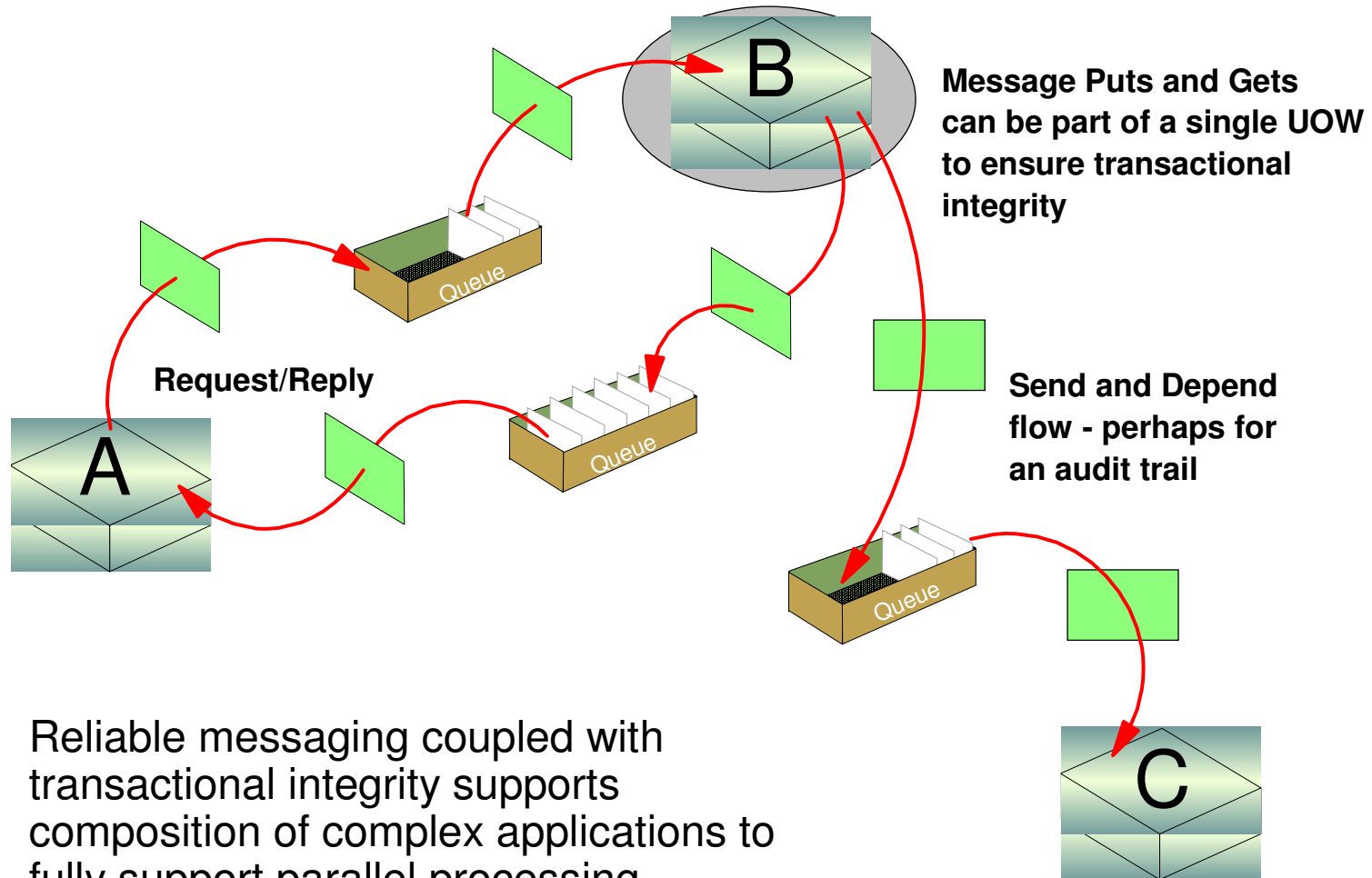

Full support for transactional environments

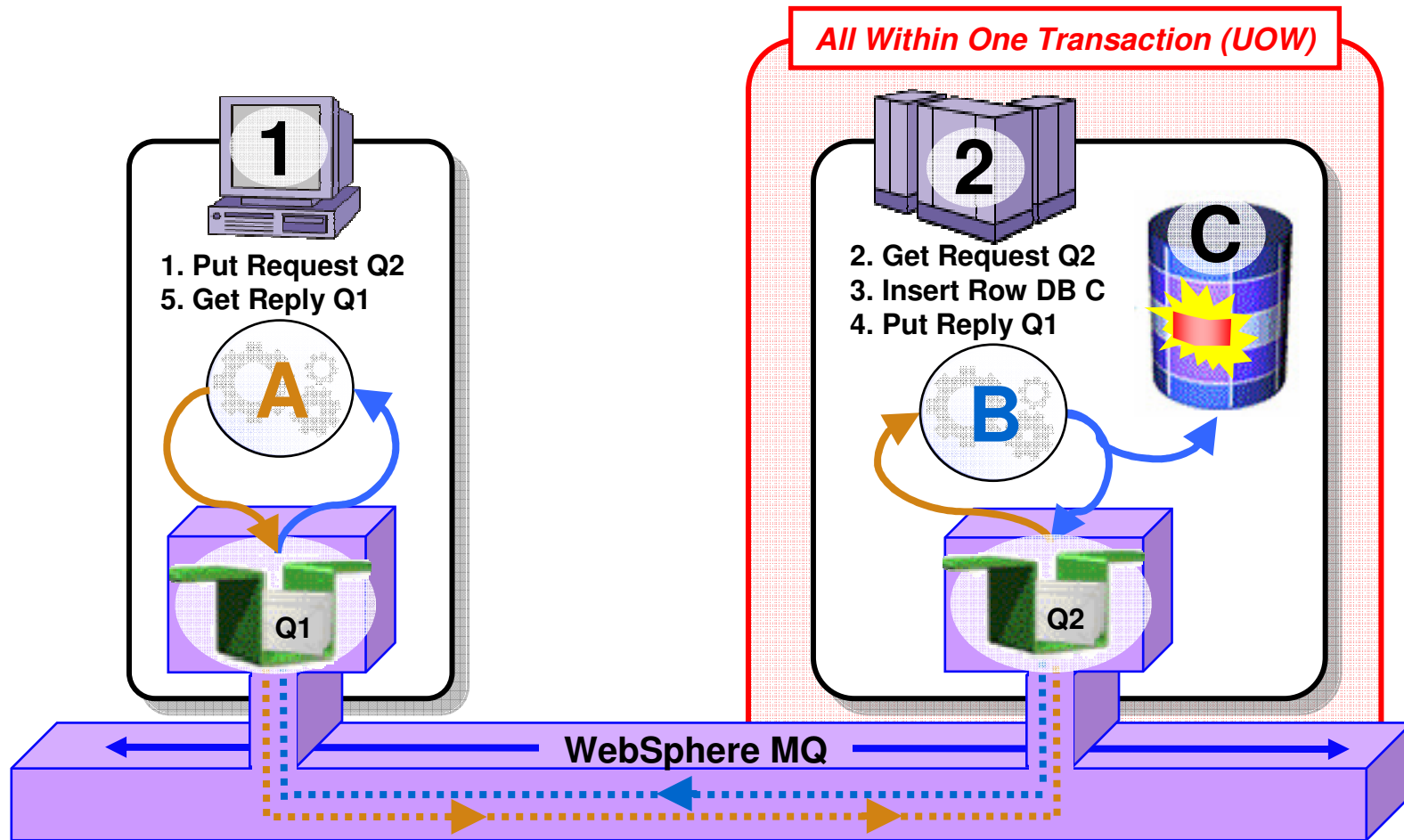

- Full support for CICS, IMS, WAS, DB2 SPs & Batch RSS
- Reliable Two-Phase commit involving other Resource Managers e.g. DB2

Loosely coupled interaction style

Through correct use of ALIAS queue definitions, the application interaction can be augmented at any point in the flow to enable additional processing without application change.

This example shows a classic use of WebSphere Message Broker – Application D here - which in turn provides rich capabilities for augmentation, routing, transformation etc.

All of the above provides flexibility in placement of business logic

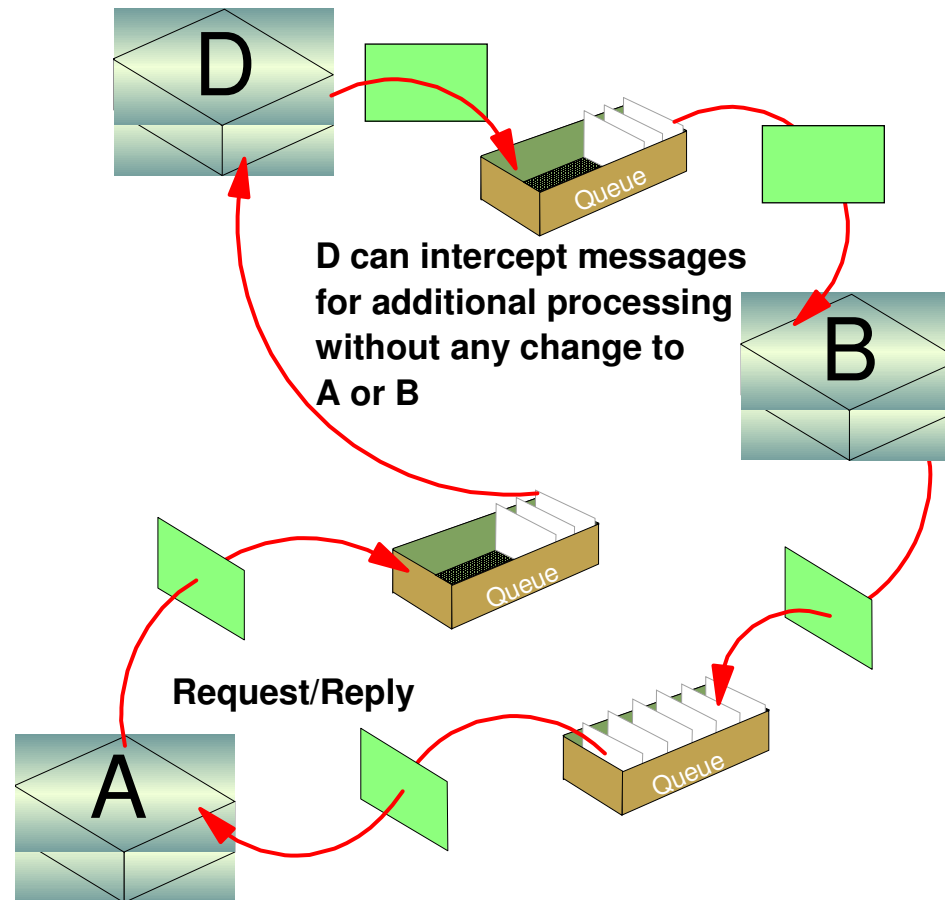

Workload Balancing with Clustering

- “Round Robin” balancing by default
- Custom balancing algorithms can be added as workload exits
- MQ V6 provides additional balancing based on assigned priorities & weightings

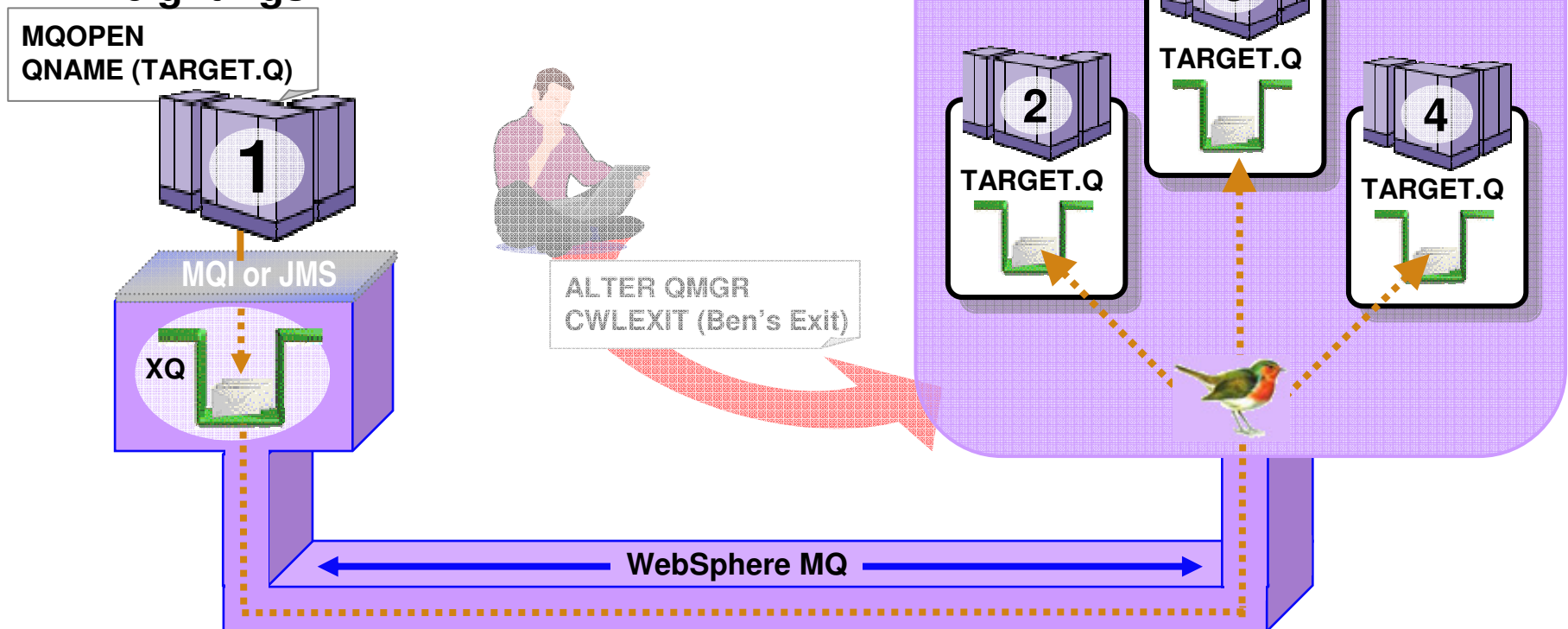

Shared queues on z/OS

- Exploits Parallel Sysplex
- Automatic load balancing
- Scalable throughput
- Multiple processors can access the same queue
- Queue sharing groups
- VIPA support

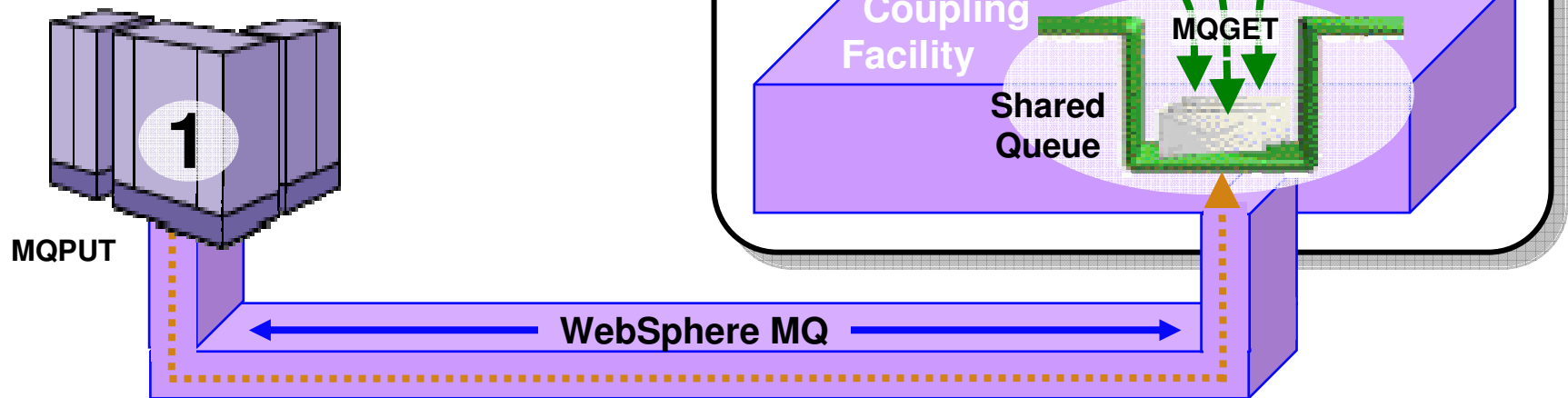

Highly Available with Failover for z/OS

- **Failure isolation**
 - Automatic peer recovery for failing Servers, Applications or Queue Managers
- **In-flight MQPUTs and MQGETs are rolled back**
 - Since messages are not hosted in any Queue Manager there are no marooned messages
- **24 x 7 availability**
- **Leverages ARM (Automatic Restart Manager)**

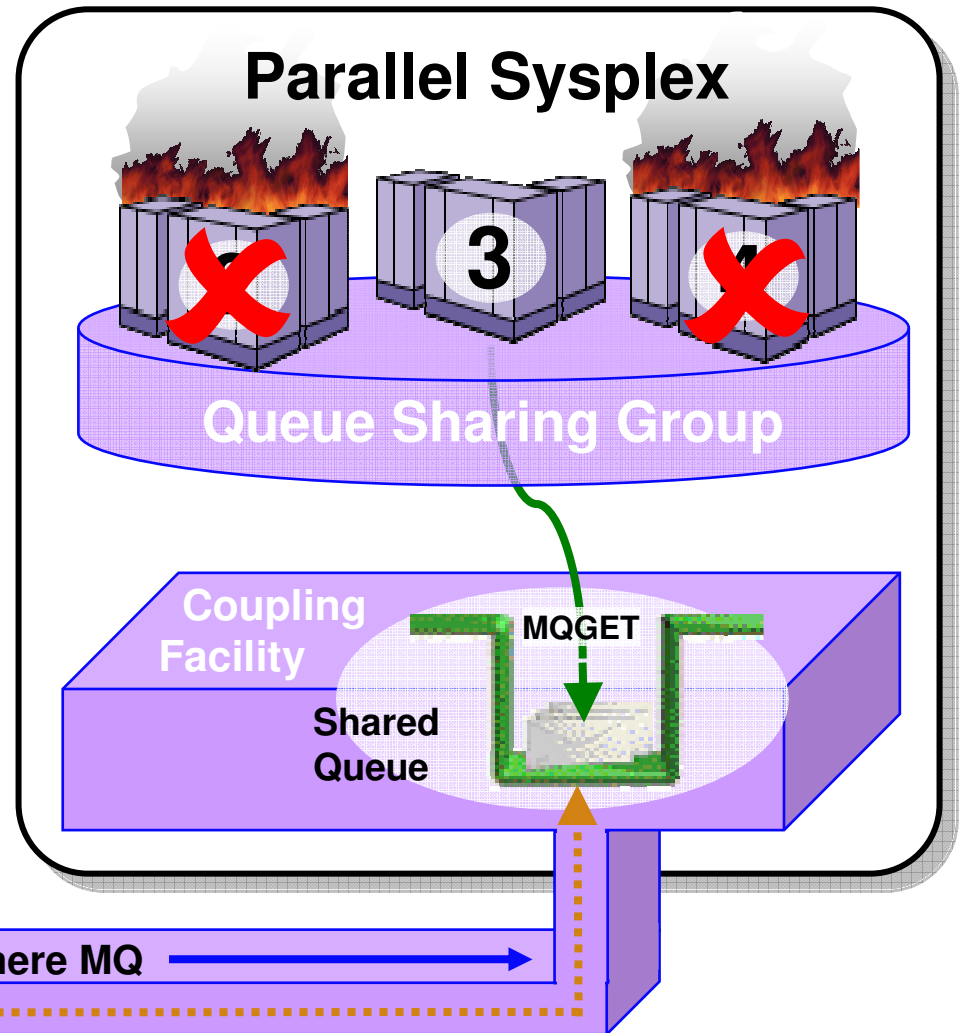
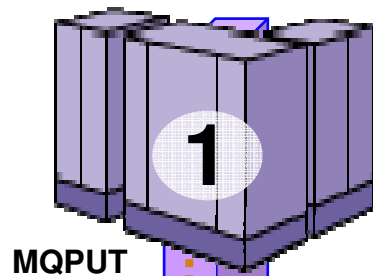

Accessing CICS, IMS, DB2 SPs and Batch/TSO

Explicitly – Using the MQI or JMS API

- Gives CICS and IMS access to messages from other z/OS regions and other non-z/OS platforms
- Allows other applications to access CICS and IMS without using CICS or IMS APIs

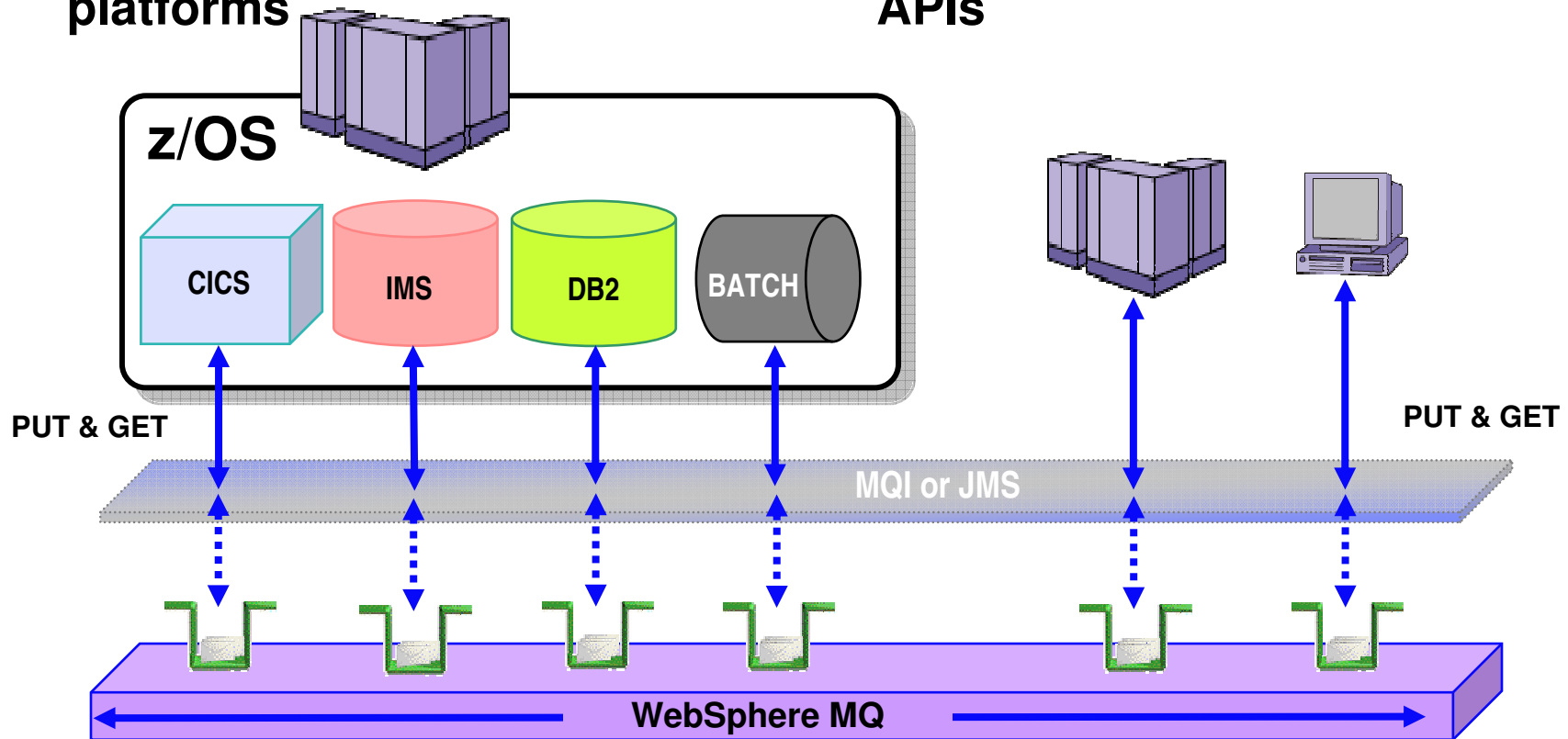

Accessing CICS and IMS

Implicitly – Using the Bridges supplied for CICS and IMS

- **CICS and IMS applications use the native APIs:**
 - EXEC CICS BMS, GU, ISRT...
- **Allows other applications to access CICS and IMS without using CICS or IMS APIs**

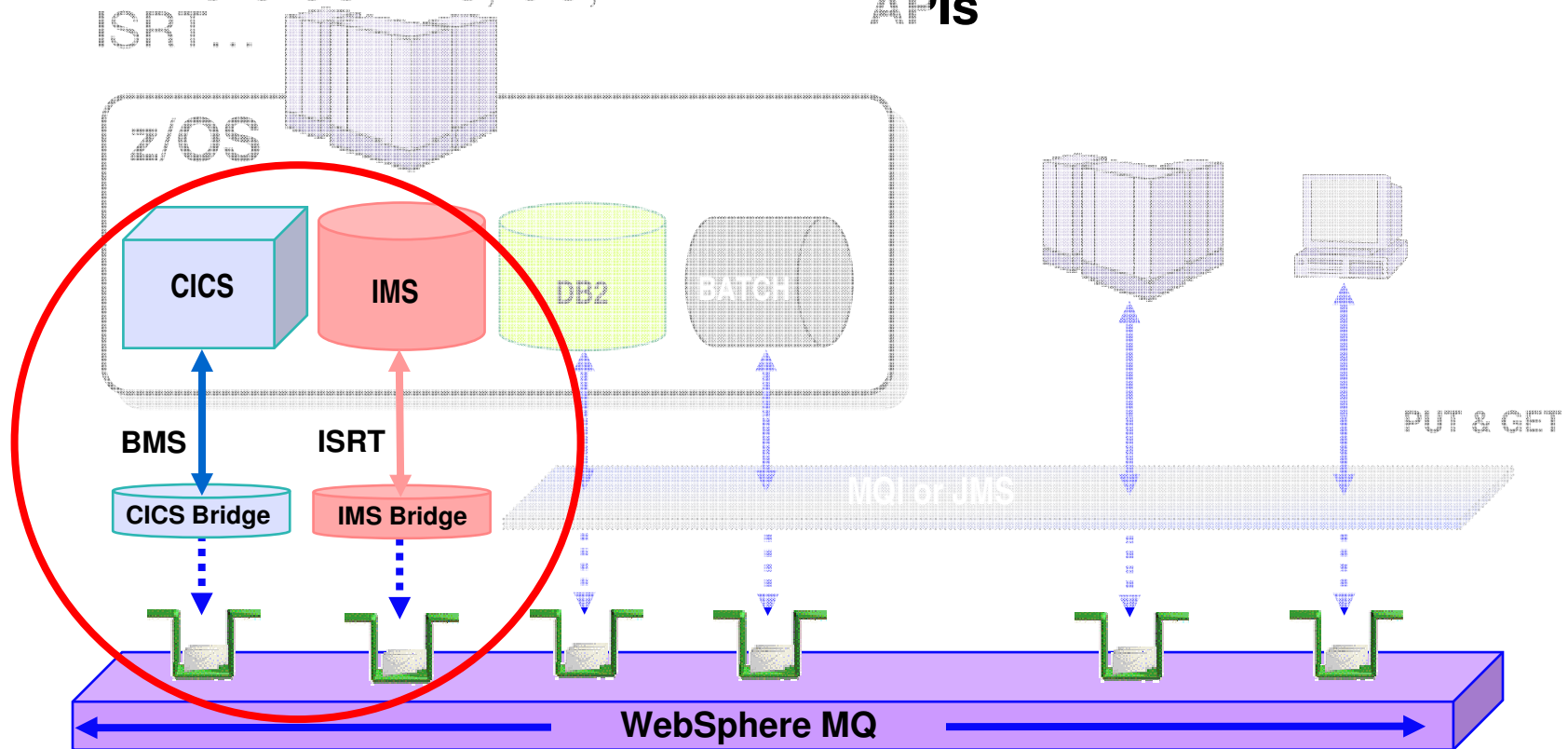

New Cluster Options

- **Weighting & priorities**
- **Include local instance**

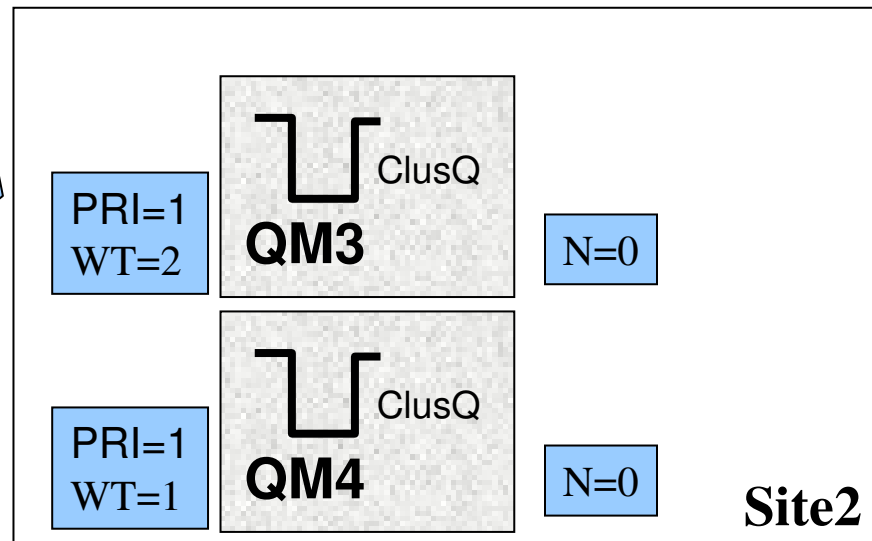
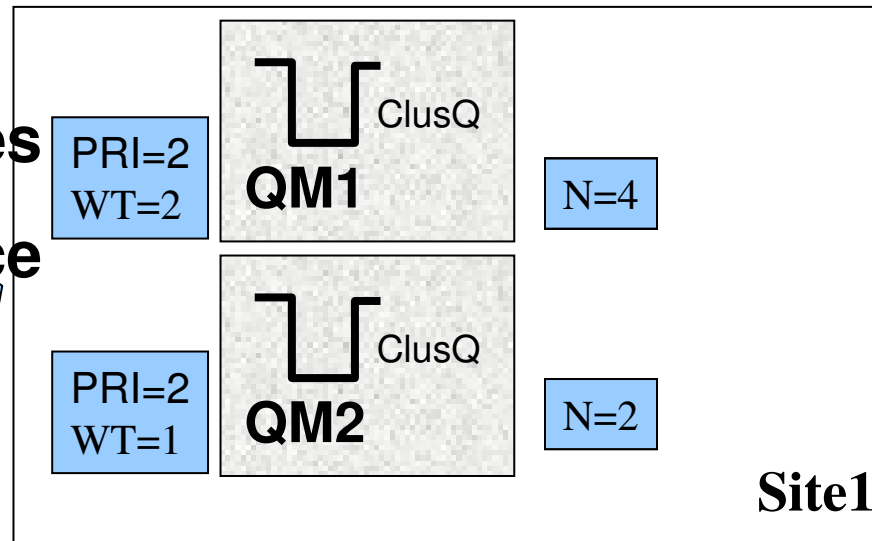
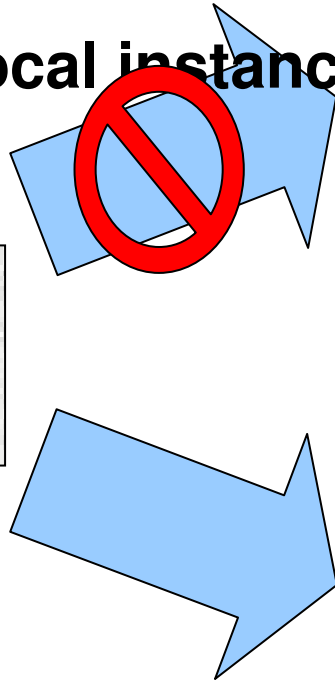
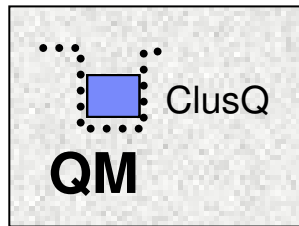

New Cluster Options

- **Weighting & priorities**
- **Include local instance**

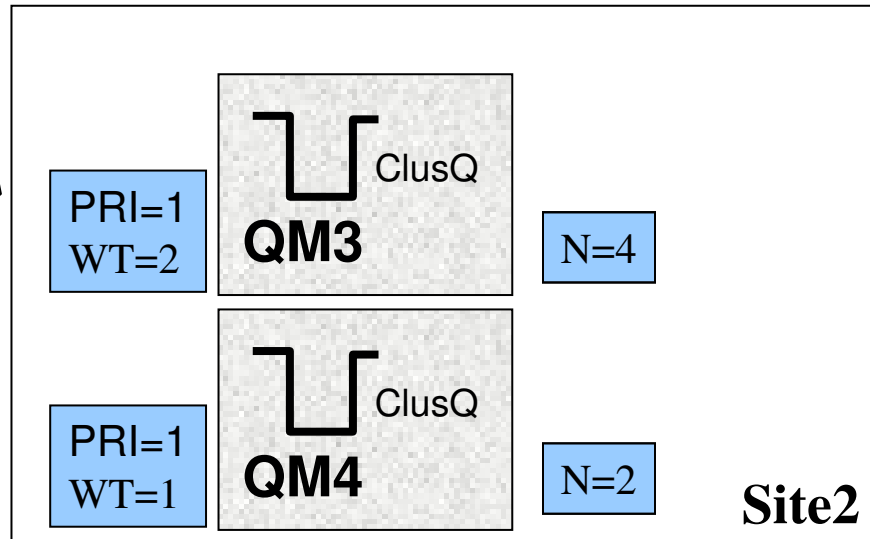
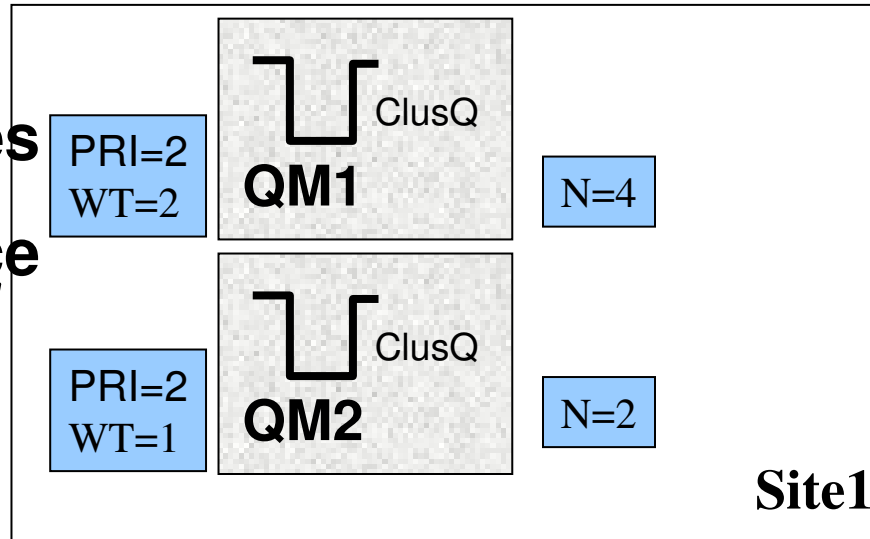
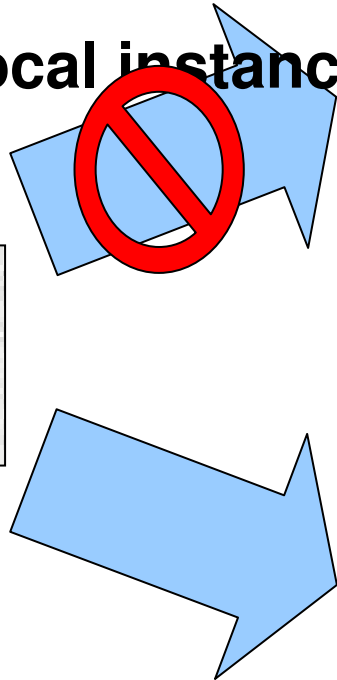
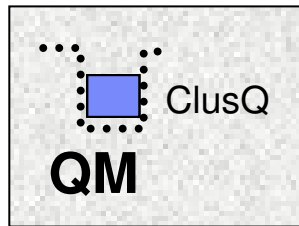

WebSphere MQ for z/OS V6 and recent SupportPac highlights

- **The details of z/OS availability**

z/OS Availability – Large shared queue messages

- **Removes the 63KB limit for shared queues so removing a significant constraint for WMQ application exploitation of shared queues**
 - Maximum shared queue message length now 100MB
 - same as that for non-shared messages
- **Uses DB2 to store large message payloads as BLOBs**
 - Header stored as V5.3 in CF with pointer to BLOB
 - Transparent to applications
 - Small messages stored as in V5.3, without DB2
- **There are performance implications ...**
 - Expect degradation (indications are >4x for large persistent messages)
 - All customer feedback indicates that only a small percentage of applications that use shared queues will have messages > 63KB so the performance cost is believed to be acceptable
- **Administrator control of whether it is permitted**

z/OS Availability – SQ Admin. Structure recovery

- **The Shared Queue Administration structure holds key WMQ control information across the queue-sharing group**
 - Transaction state information to enable peer recovery
 - Serialised application support information
 - Structure interest information
- **But with WMQ V5.3 a loss of this structure will cause each connected Queue Manager to fail resulting in a total loss of the queue-sharing group**
- **In WMQ V6 this limitation is removed**
 - Queue Managers will reconnect to/reallocate the structure
 - This is done automatically - no operator intervention required
 - Structure will be rebuilt from log data
 - Until the rebuild is complete some shared queue functions will not be available
 - no new shared channels can start
 - no Application structure rebuild is possible
 - no Queue Manager peer recovery is possible
 - BUT .. Existing applications will carry on running to completion and the vast majority of new applications can start and also run to completion

z/OS Availability – SQ Admin V5.3.1 v V6

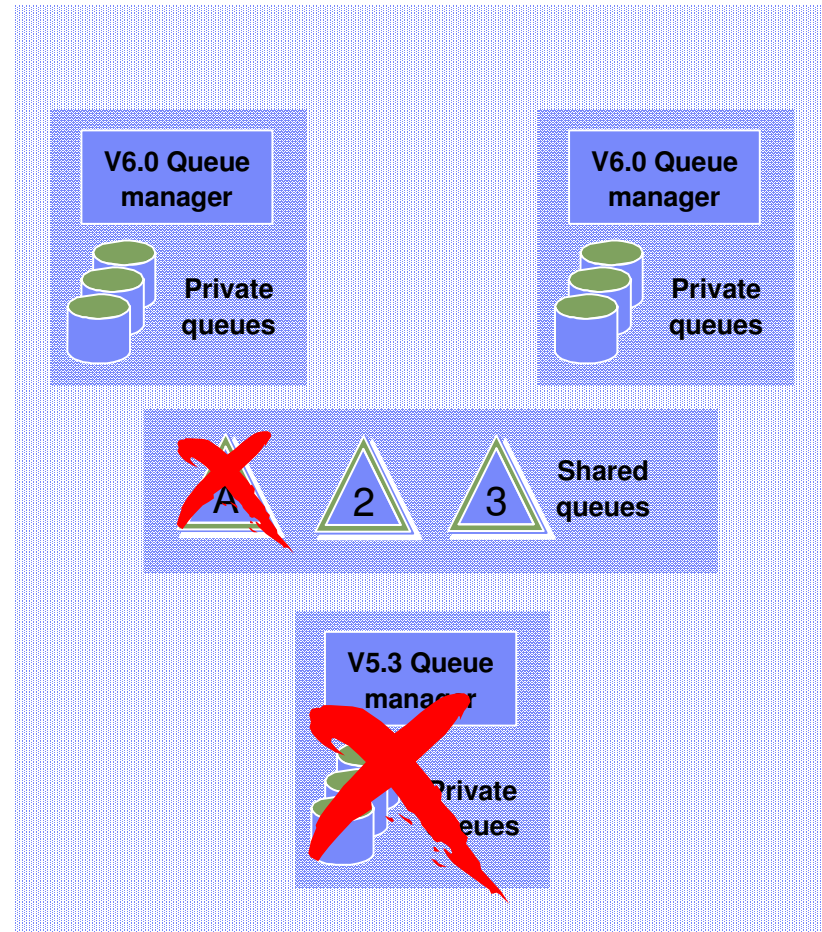
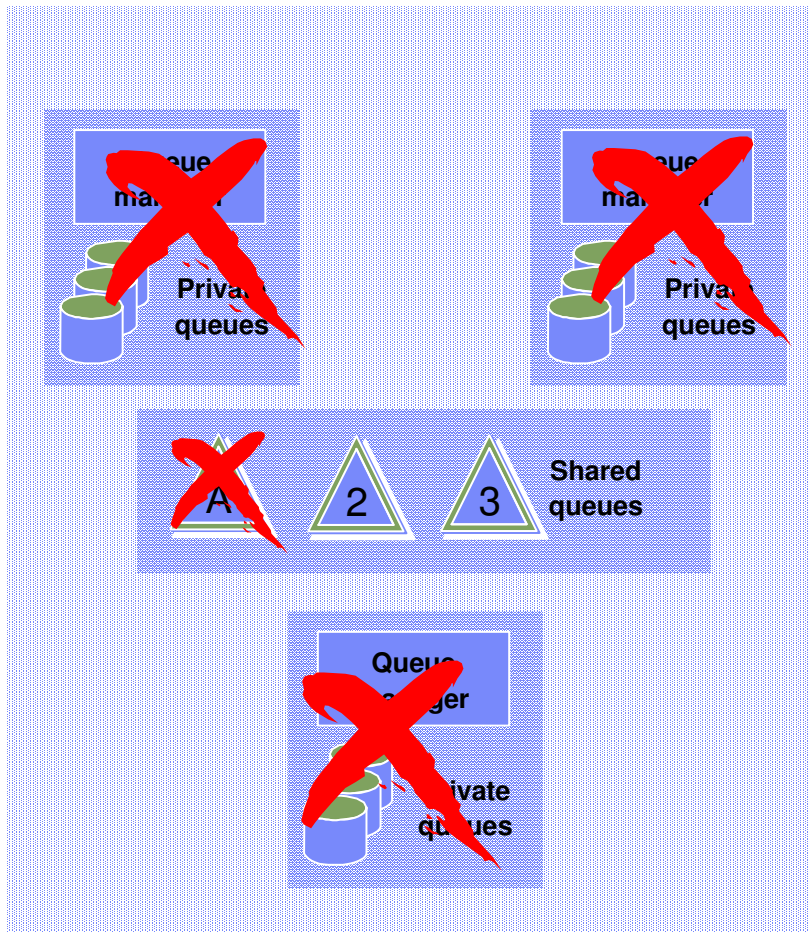

z/OS Availability – 64GB Page sets

- **In order to have page sets that exceed 4GB -**
 - NEW PAGE SETS MUST BE CREATED
- **Page sets MUST be DEFINED with an SMS DATA CLASS that specifies –**
 - "EXTENDED ADDRESSABILITY"
- **Create replacement page sets with the SAME SIZE as the page set that they replace, and REPRO old page sets to the new page sets - these page sets will 'grow' beyond 4GB by page set expansion**
- **Or brand new page sets can be allocated > 4GB and formatted ready for use**
- **Update QMGR JCL to point to new page sets**
- **Note: Existing page sets can continue to be used, but they will continue to have a maximum size of 4GB**

z/OS Availability – Dynamic CHIN parameter setting

- **CSQXPARM parameters are now attributes of the Queue Manager object**
 - Supports common methodology for “Queue Manager” parameter changes between z/OS and Distributed Websphere MQ
- **So with WMQ V6 no need for CHIN recycle**
- **Note: Some specific attributes may still require a recycle, determined on a case by case basis.**
- **Example –**
 - ALTER QMGR ADOPTCHK(ALL)
 ADOPTINT(120)
 ADOPTMCA(NO)
 TCPKEEP(YES)
 RCVTIME(X2)
 RCVTMIN(120)

z/OS Availability – Multiple TCP/IP stack support

- **In some recovery scenarios WMQ may be running on a different LPAR with a different TCP/IP stack**
- **In these scenarios need to be able to specify both a Listener stack and the stack that an Outbound Channel should use**
- **New CHIN parameter TCPSTACK -**
 - TCPSTACK=SINGLE
 - Restricts channels and listeners to the stack named in TCPNAME
 - CHIN will behave the same as with WMQ V5.3
 - TCPSTACK=MULTIPLE
 - Channels and listeners may bind to any available stack
 - TCPNAME stack will be the default
- **Listener IPADDR and channel LOCLADDR used as with WMQ 5.3 to indicate communications address within the stack**

z/OS Availability – V5.3 CICS Bridge Monitor

- **The CICS Bridge provides MQ interface to legacy CICS applications**
- **With WMQ 5.3 it comes in two flavours -**
 - DPL Bridge - Link to program with data in Commarea
 - 3270 Bridge - Transaction with BMS map
 - Uses CICS Attach bridge facility
- **Bridge monitor browses queue, performs authority checks and starts a transaction to process the message.**
- **BUT .. Significant restrictions**
 - Only one bridge monitor per bridge queue
 - 3270 transactions cannot be routed to AORs
 - Reduces reliability and scalability because tied to single region
- **Some enhancements introduced in MQ 5.3.1**
 - Reply expiration, null truncation, sync on return

z/OS Availability – CICS Bridge with WMQ V5.3

CICSA

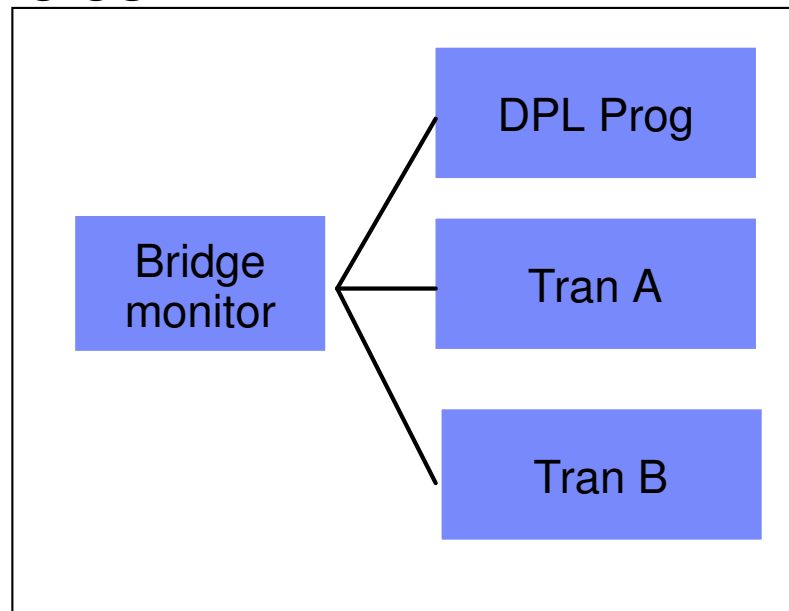

Each instance of the Bridge must have exclusive access to the Bridge Queue.

Also the form of the EXEC CICS START does NOT allow transaction routing so TRAN A and TRAN B can only run in the CICSA region.

z/OS Availability – V6 CICS Bridge Monitor enhancements

- **Multiple bridge monitors for single queue**
- **Transaction Routing**
- **Tolerate & return additional headers (e.g. RFH2)**
- **Honour Backout threshold and requeue queue name**
- **Error messages to CICS joblog option**
- **Optional reply to queue**
- **Enhanced passticket support**
- **Honour MQRO_DISCARD_MSG and MQRO_PASS_DISCARD_AND_EXPIRY**