



# New mainframe monitoring capability: **OMEGAMON V5.1 family**

Rich Edwards, OMEGAMON Product Manager  
Joe Winterton, OMEGAMON Release Manager  
IBM Cloud and Smarter Infrastructure

August 29, 2013



## IBM System z Service Management development continues enhancing OMEGAMON portfolio



- **OMEGAMON XE V5** portfolio continues delivering significant new business value and support
  - OMEGAMON XE for z/OS V5.1.1
  - OMEGAMON XE for Mainframe Networks V5.1.1
  - OMEGAMON XE for Storage V5.2
  - OMEGAMON XE for z/VM and Linux V4.3
- IBM enhanced OMEGAMON portfolio focused on hardware and **Mobile, Big Data and Cloud** support
- OMEGAMON **Cross-Product** integration simplify operations ability to achieve optimal availability

## Increased Business Agility with improved IT visibility now available with redesigned OMEGAMON family

Modernize and strengthen OMEGAMON product line with  
reduced resource usage and increased information  
available for higher quality service management

- Enhanced 3270 User Interface for SMEs
- Built-in Problem Solving Scenarios
- Faster Configuration/Maintenance
- Usage of zIIP specialty servers
- zEnterprise monitoring across zEC12/BC12 and zBX





## Increased analytics and mobile visibility and productivity

### *IBM OMEGAMON XE for z/OS V5.1.1*

- **Enhanced zEnterprise analytics visibility** – Support zAware for monitoring and management
- **Increased Productivity** – Enhanced OMEGAMON family Install/Config PARMGEN capability .

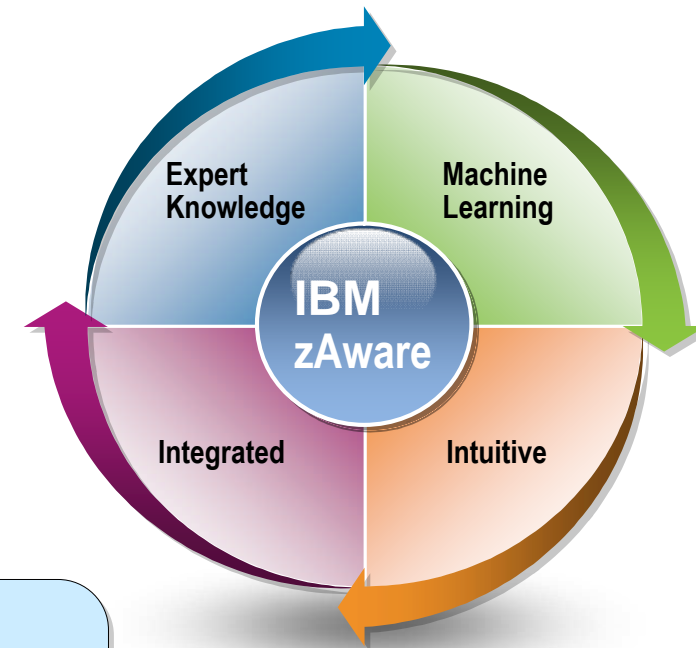

#### **Benefits:**

- Save up to 75% of time needed to find problems
- Up to 73% of CICS SLA processing off-loaded
- Reduce fix times from 90 minutes to 2 minutes

# IBM zAware, Event Management and Traditional Performance Monitoring

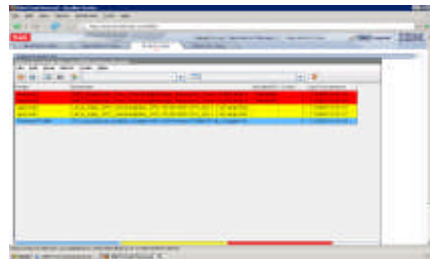

View event in Active Event List  
Generate trouble ticket



Operator, SME

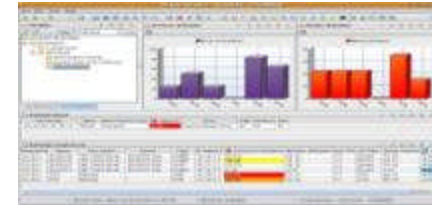

Perform PD for anomaly using association with traditional monitoring KPIs

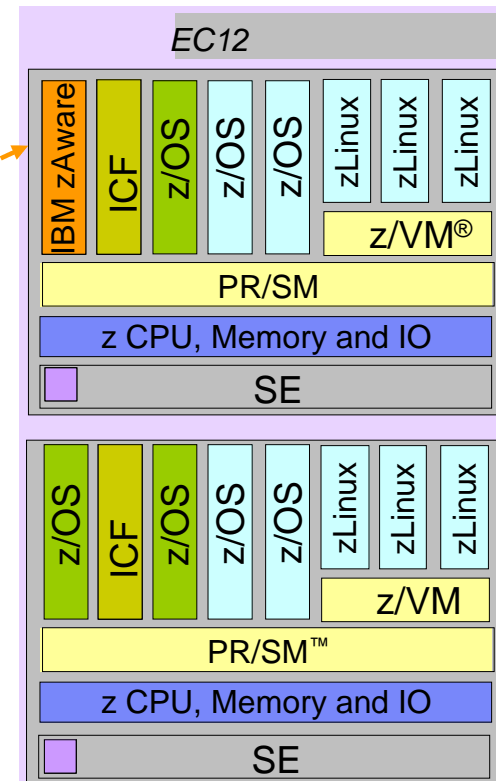

## Processing ...

- Query IBM zAware (10 minute interval)
- If anomaly detected
  - Trigger situation to Generate Event when anomaly is surfaced
  - Include IBM zAware insights in performance monitoring views

# Use OMEGAMON to monitor zAware and find events before they become outages



## Find events with OMEGAMON TEP view

Situation Event Console

(Active) Total Events: 4 Item Filter: Enterprise

Severity	Status	Owner	Name	Display Item	Source	Impact	Global Timestamp	Age	Local Timestamp
Warning	Open		KM5_zAware_Analysis_Warn		LPAR400J:SYS:MVSSYS	Km5:KM5_ZAW1_1039	07/29/13 14:52:54	3 Minutes	07/29/13 14:52:54
Warning	Open		KM5_zAware_Client_Status		LPAR400J:SP12:MVSSYS	Km5:KM5_ZAW1_1039	07/29/13 11:02:02	3 Hours, 54 Minutes	07/29/13 11:02:02
Warning	Open		KM5_zAware_Server_Status		LPAR400J:SP12:MVSSYS	Km5:KM5_ZAW1_1039	07/29/13 11:02:02	3 Hours, 54 Minutes	07/29/13 11:02:02
Warning	Open		KM5_Mg_Supply_DASP_Filter_Warn		LPAR400J:SYS:SP12:EV	Shared DASP Group Data For Supply	07/29/13 15:07:55	23 Hours, 29 Minutes	07/29/13 15:07:55

### Interval View for System SYSG

### zAware details on what triggered event

The Messages table provides detailed analysis information for each message that occurred during the indicated time interval. To view message details for other intervals use the date and time interval selectors. Click the **Return to Analysis** to the Analysis view.

Date: July 29, 2013

Analysis Source: LPAR400J.SYSG

Time interval (UTC): 18:40 -- 18:50

Interval anomaly score: 100.0

#### Messages

Anomaly Score	Interval Contribution Score	Message Context	Rules Status	Appearance Count	Time Line	Message ID	Message Example	Rarity Score	Component	Cluster ID
1	15.928	new	None	20		KLVVT251	SESSION SETUP ERROR: POOL(\$DEDICAT) APPLID(DBEMV25)	101	KLVVT	-1
1	7.089	new	None	2		DFS092I	IMS LOG TERMINATED IB1K	101	DFS	-1
1	7.089	new	None	2		DFS1958I	IMS CONNECTION TO APPC/MVS COMPLETE, LUNAME=USCAC001.IMSLUB1K	101	DFS	-1



# Monitoring zAware Server with OMEGAMON

- The Tivoli zEnterprise Monitoring Agent already monitors logical partitions in CEC as shown in 'Logical Partitions Summary' table in zEnterprise Ensemble Summary workspace.

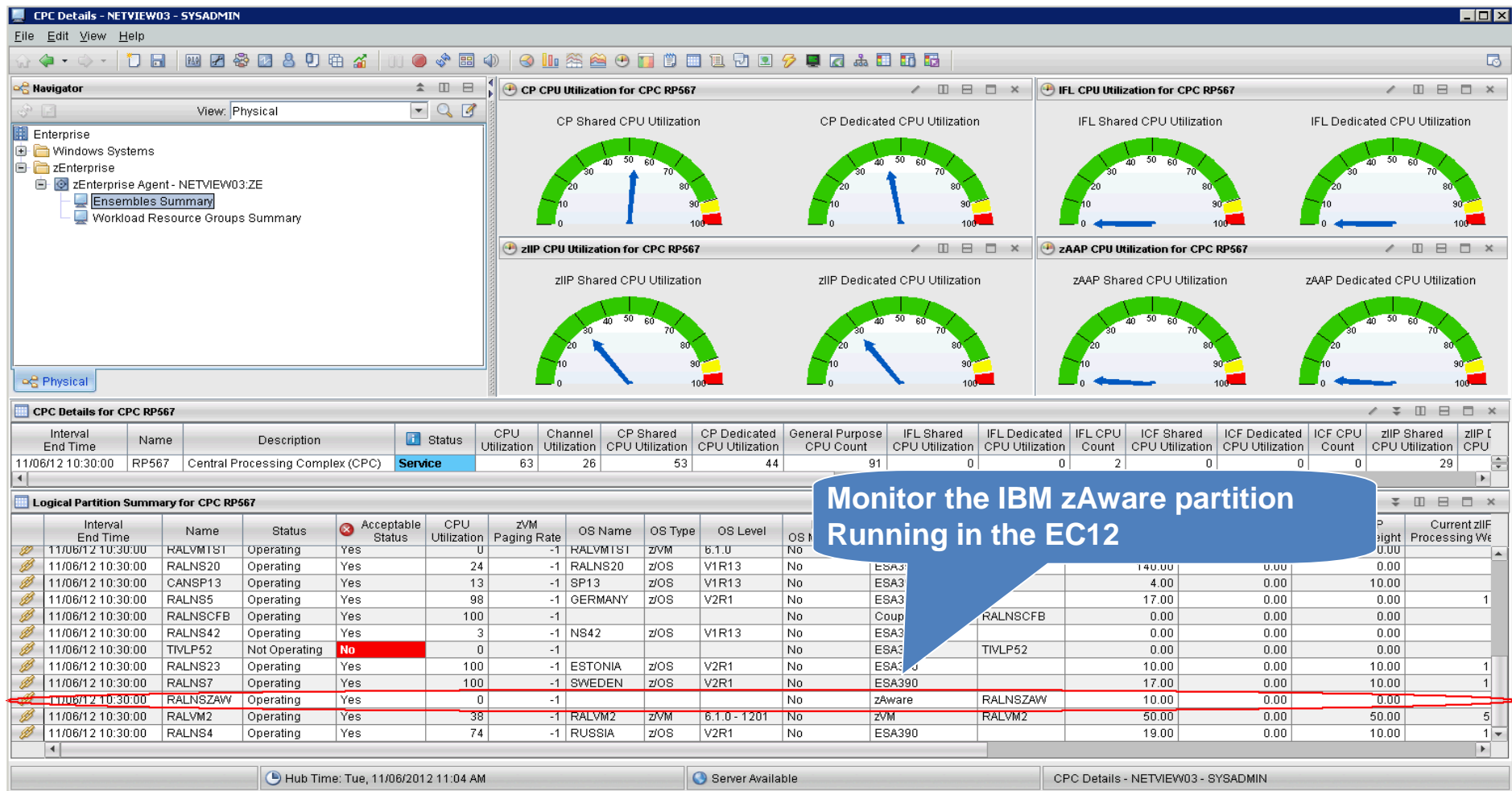

**CPC CPU Utilization for CPC RP567**

CP Shared CPU Utilization: ~50%  
 CP Dedicated CPU Utilization: ~45%

**IFL CPU Utilization for CPC RP567**

IFL Shared CPU Utilization: ~10%  
 IFL Dedicated CPU Utilization: ~10%

**zIIP CPU Utilization for CPC RP567**

zIIP Shared CPU Utilization: ~30%  
 zIIP Dedicated CPU Utilization: ~30%

**zAAP CPU Utilization for CPC RP567**

zAAP Shared CPU Utilization: ~10%  
 zAAP Dedicated CPU Utilization: ~10%

Interval End Time	Name	Description	Status	CPU Utilization	Channel Utilization	CP Shared CPU Utilization	CP Dedicated CPU Utilization	General Purpose CPU Count	IFL Shared CPU Utilization	IFL Dedicated CPU Utilization	IFL CPU Count	ICF Shared CPU Utilization	ICF Dedicated CPU Utilization	ICF CPU Count	zIIP Shared CPU Utilization	zIIP Dedicated CPU Utilization
11/06/12 10:30:00	RP567	Central Processing Complex (CPC)	Service	63	26	53	44	91	0	0	2	0	0	0	29	0

Interval End Time	Name	Status	Acceptable Status	CPU Utilization	ZVM Paging Rate	OS Name	OS Type	OS Level	OS M...	...	...	...	...	...	...	...	...
11/06/12 10:30:00	RALVMTST	Operating	Yes	0	-1	RALVMTST	ZVM	6.1.0	No								
11/06/12 10:30:00	RALNS20	Operating	Yes	24	-1	RALNS20	z/OS	V1R13	No	ESA3		140.00	0.00	0.00	0.00		
11/06/12 10:30:00	CANSP13	Operating	Yes	13	-1	SP13	z/OS	V1R13	No	ESA3		4.00	0.00	0.00	10.00		
11/06/12 10:30:00	RALNS5	Operating	Yes	98	-1	GERMANY	z/OS	V2R1	No	ESA3		17.00	0.00	0.00	0.00		1
11/06/12 10:30:00	RALNSCFB	Operating	Yes	100	-1		Coupl		No		RALNSCFB	0.00	0.00	0.00	0.00		
11/06/12 10:30:00	RALNS42	Operating	Yes	3	-1	NS42	z/OS	V1R13	No	ESA3		0.00	0.00	0.00	0.00		
11/06/12 10:30:00	TIVLP52	Not Operating	No	0	-1				No	ESA3	TIVLP52	0.00	0.00	0.00	0.00		
11/06/12 10:30:00	RALNS23	Operating	Yes	100	-1	ESTONIA	z/OS	V2R1	No	ESA3		10.00	0.00	0.00	10.00		1
11/06/12 10:30:00	RALNS7	Operating	Yes	100	-1	SWEDEN	z/OS	V2R1	No	ESA390		17.00	0.00	0.00	10.00		1
11/06/12 10:30:00	RALNSZAW	Operating	Yes	0	-1		ZAware		No		RALNSZAW	10.00	0.00	0.00	0.00		
11/06/12 10:30:00	RALVM2	Operating	Yes	38	-1	RALVM2	ZVM	6.1.0 - 1201	No			50.00	0.00	0.00	50.00		5
11/06/12 10:30:00	RALNS4	Operating	Yes	74	-1	RUSSIA	z/OS	V2R1	No	ESA390		19.00	0.00	0.00	10.00		1

Hub Time: Tue, 11/06/2012 11:04 AM | Server Available | CPC Details - NETVIEW03 - SYSADMIN

Monitor the IBM zAware partition Running in the EC12



# Continuing to enhance PARMGEN to make installation and configuration easier

## New Capability

## Customer Value

Added two global parameters for quicker out-of-the box configuration.	First-time installers now have 490 fewer parameters to customize to get to proof-of-concept.
Automatically refresh PARMGEN profiles whenever configuration changes are made after initial RTE deploy.	75% reduction in steps for this refresh activity.
Automatically incorporate local variables (if defined) into the PARSE job.	50% reduction in the number of jobs needed to incorporate local overrides to system variables.
Provide a job to compare test and production libraries.	Enables quick visualize differences before moving test into production.
Enhance the System Variable report job to include user-defined variables and their current values.	Full range of variables PARMGEN supports and their current values (for debugging purposes).





# Enterprise View - Sysplex, CICSplex and DB2plex



File Edit View Tools Options Help 06/30/2012 10:56:46  
 Auto Update : Off  
 Command ==> KOBSTART Enterprise Summary  
 Plex ID :  
 Sys ID :

**All Active Sysplexes**

Columns 2 to 6 of 9	Rows 1 to 1			
◇Sysplex Name	ΔAverage ∇CPU Percent	Highest LPAR Name	ΔHighest ∇LPAR CPU%	ΔPercent L ∇MSU Capac
ESYSPLEX	14	ESYSMVS	26	26.5 N/A

**All Active CICSplexes**

Columns 2 to 6 of 19	Rows 1 to 1			
ΔCICSplex ∇Name	ΔNumber of ∇Regions	ΔTransaction ∇Rate	ΔCPU ∇Utilization	Any S ∇Region
CICSACB9	1	0/m	0.0%	No n/a
CICSDAX1	6	0/m	0.0%	No n/a
CICSPLX1	9	0/m	0.0%	No n/a
CICWKS38	1	0/m	0.0%	No n/a
OMEGPLEX	8	6/m	0.0%	No n/a

**All Active DB2 Subsystems**

Columns 3 to 7 of 29	Rows 1 to 7 of 7					
ΔDB2 ID ∇	ΔMVS ∇System ID	Lock Conflict	Lock Escalation	Lock Escalation	Lock Escalation	+DDF
DSNT	MVSE	0	0	0	0	
DSNC	MVSE	0	0	0	0	
DSNB	MVSE	0	165	0	0	
DSNA	MVSE	0	0	0	0	
DB1S	MVSE	0	50	0	0	0.21
DB1I	MVSE	0	0	0	0	0.00
DB1D	MVSE	0	0	0	0	0.00

z/OS-wide sysplex view

CICSplex details views

DB2plex details views



## Increased analytics and mobile visibility and productivity

### *IBM OMEGAMON XE for Mainframe Networks V5.1.1*

- **Increase Mobile Network availability** – Improved visibility into networks and enhanced problem determination and resolution
  - FTP and Hybrid Networks
- **Enterprise Wide Views and Find dialogs** - Extended TEP capabilities to enable SMEs to improve MTTR (Mean Time To Repair) for network related problems



*Continued Enhancement of OMEGAMON family to support Mobile, Cloud and Analytics*

# OMEGAMON XE for Mainframe Networks Key Indicators to monitor and manage

Applications and Connections  
**FTP sessions and transfers**  
 Network interfaces, OSA, and HiperSockets

**Business partner links**  
 TCP/IP stack performance and memory  
 TN3270 sessions

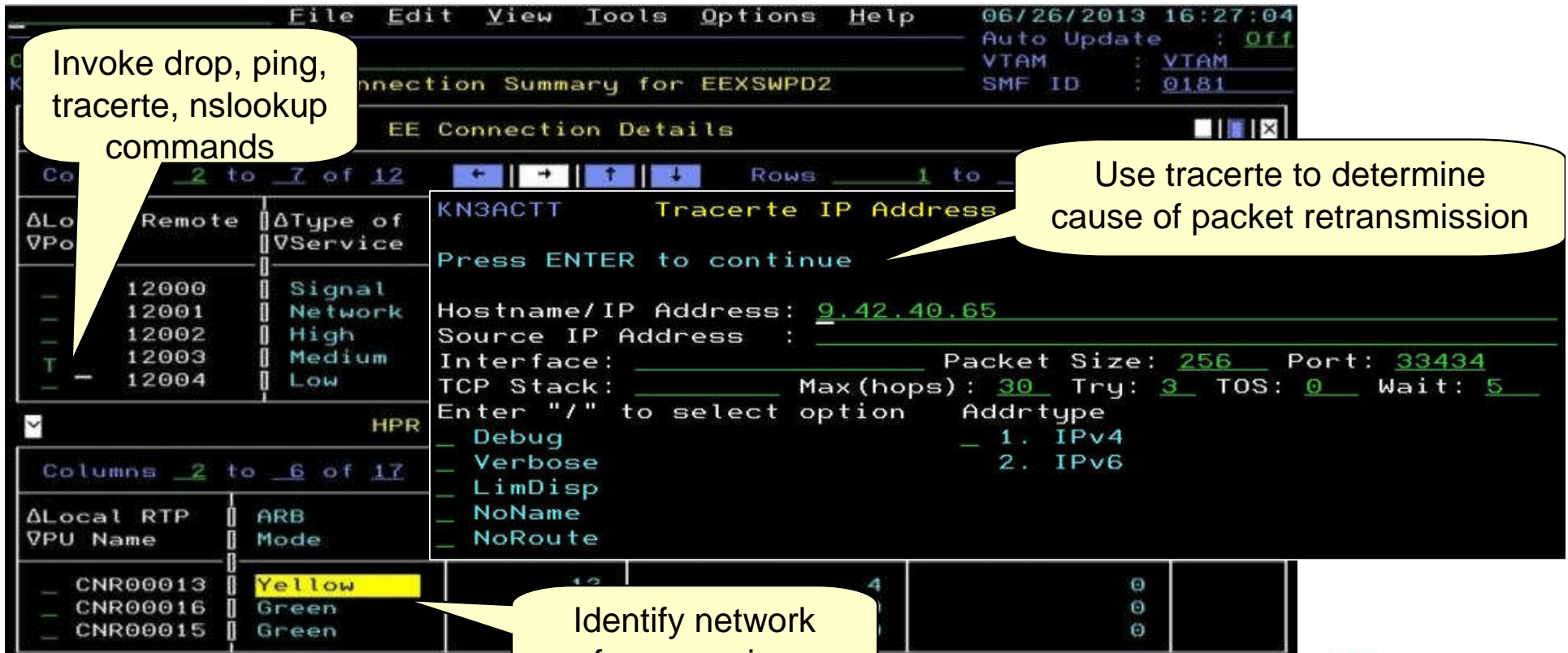

The screenshot shows the OMEGAMON XE interface with the following components:

- Top Panel:** Menu (File, Edit, View, Tools, Options, Help), Date/Time (06/26/2013 16:27:04), and system status (Auto Update: Off, VTAM: VTAM, SMF ID: 0181).
- Connection Summary:** EE Connection Summary for EEXSWPD2.
- EE Connection Details:**
  - Columns: Co, Remote, ΔType of Service.
  - Rows: 12000 (Signal), 12001 (Network), 12002 (High), 12003 (Medium), 12004 (Low).
- Traceroute Command:** KN3ACTT Tracerte IP Address. The command is being executed with Hostname/IP Address: 9.42.40.65. Options include Packet Size: 256, Port: 33434, Max(hops): 30, Try: 3, TOS: 0, Wait: 5.
- HPR (HiperSocket Performance Report) Table:**

ΔLocal RTP	ARB	Mode
CNR00013	Yellow	
CNR00016	Green	
CNR00015	Green	

**Callouts:**

- Invoke drop, ping, traceroute, nslookup commands:** Points to the command input area.
- Use traceroute to determine cause of packet retransmission:** Points to the traceroute command options.
- Identify network performance issues:** Points to the HPR table, specifically the 'Yellow' status for CNR00013.

# OMEGAMON XE for Mainframe Networks provides visibility to resources across an Enterprise



**Enterprise Connections Find - NCD48219 - SYSADMIN**

**Enterprise Networks Navigation**

- Enterprise Connections Find
- Enterprise Connections Health
- Enterprise EE Connections Overview
- Enterprise FTP Sessions Find
- Enterprise FTP Sessions Overview
- Enterprise FTP Transfers Find
- Enterprise HPR Connections Overview
- Enterprise HiperSockets Interfaces Overview
- Enterprise Interfaces Overview
- Enterprise OMEGAMON for Mainframe Networks Health
- Enterprise OSA Interfaces Overview
- Enterprise OSA Express Channels Overview

**Applications Summary**

System	TCPIP	Backlog Connections Rejected	Transmit Byte Rate	Receive Byte Rate	Percent Segments Retransmitted	Total Segments Retransmitted
SP22	TCPIP	0	122,619	39,404	6	0
SP22	TCPIP	0	433,586	84,668	0	0
SP22	TCPIP	0	25,808	51,152	0	0
SP22	TCPIP22	\$22DSST	1.18	32	8	9
SP22	TCPIP22	BCD1DSST	0.00	29	9	9
SP22	TCPIP22	BCD1C5	0.02	25	4	4

**Enterprise Connections Find**

At least one field must be specified as something other than \*\*

System ID \*

TCPIP STC Name \*

Remote IP Address \*

Local IP Address \*

Local Port \*

Application Name \*

Connection State \*

OK Cancel Help

**Find TCP connections for a user's problem**

**Identify potential network problems**

**Quickly jump to enterprise network views**

**Top 5 Applications - Total Backlog Connections Rejected**

**Top 5 Applications - Total Segments Retransmitted**

**Top 5 Applications - Total Out of Order Segments**

Hub Time: Mon, 07/22/2013 06:05

Enterprise Connections Find - NCD48219 - SYSADMIN



## Enhanced System z Storage Management supporting quickly growing Big Data management requirements



IBM Tivoli:

- **OMEGAMON XE for Storage on z/OS v5.2.0**
- Adv Storage Management Suite for z/OS v1.2
- Advanced Allocation Management for z/OS v3.3
- Advanced Catalog Management for z/OS v2.5
- Advanced Audit for DFSMSHsm v2.5
- Output Manager for z/OS V3.1

- Reduced resource usage
- New storage hardware support
- Easier Installation and Configuration
- Enhanced support for catalog attributes
- improved recovery processing and reduced recovery time
- Predictive search improves responsiveness and accuracy

*IBM Tivoli Storage management portfolio works together to provide simplified management*



# Enhanced visibility and management for z/VM and Linux Cloud and Mobile applications



OMEGAMON for z/VM and Linux V4.3 and SmartCloud Monitoring  
Single Source of all z/VM Performance Metrics

## Mobile & Cloud Monitoring



### Increased Performance & Availability

- z/VM Live Guest Relocation & Single System Image
  - Monitors all hypervisor guest relocations both in realtime, and using historical data

### Cloud Health Visibility and Optimization

- Performance and Availability metrics/analytics
  - z/VM Monitor Service and Linux Application Monitor
  - Integrated, consistent metric reporting across all z/VM

### Optimize Cloud workload resources

- Business Expansion based on capacity planning
  - Grow without adding hardware

# Enhanced Configuration and Maintenance capability with Self-Describing Agents



Faster, easier, less error-prone for improved reliability and productivity

- Eliminate monitoring outages caused by ITM Server recycles
  - Product upgrades/maintenance requires agent or RTEMS recycles only
- Eliminate maintenance upgrade errors:
  - Applies to new installs, staged upgrades, and maintenance
  - Crosschecks and validates version with installed data and framework
  - Avoids inconsistent application data in ITM framework layers
- Self-describing framework extensible to new capabilities
- Eliminates application data DVDs and CDs:
  - No extra distributed installs or upgrades for mainframe-centric customers



- Moving from 40 hours a week to 4 hours a week maintenance
- 80% improvement in time for installation and maintenance
- 30% improvement in time to configure post installation

# zEnterprise visibility support to allow for discovery and monitoring across all components

Workload Resource Groups can include information across z196/z114 and zBX

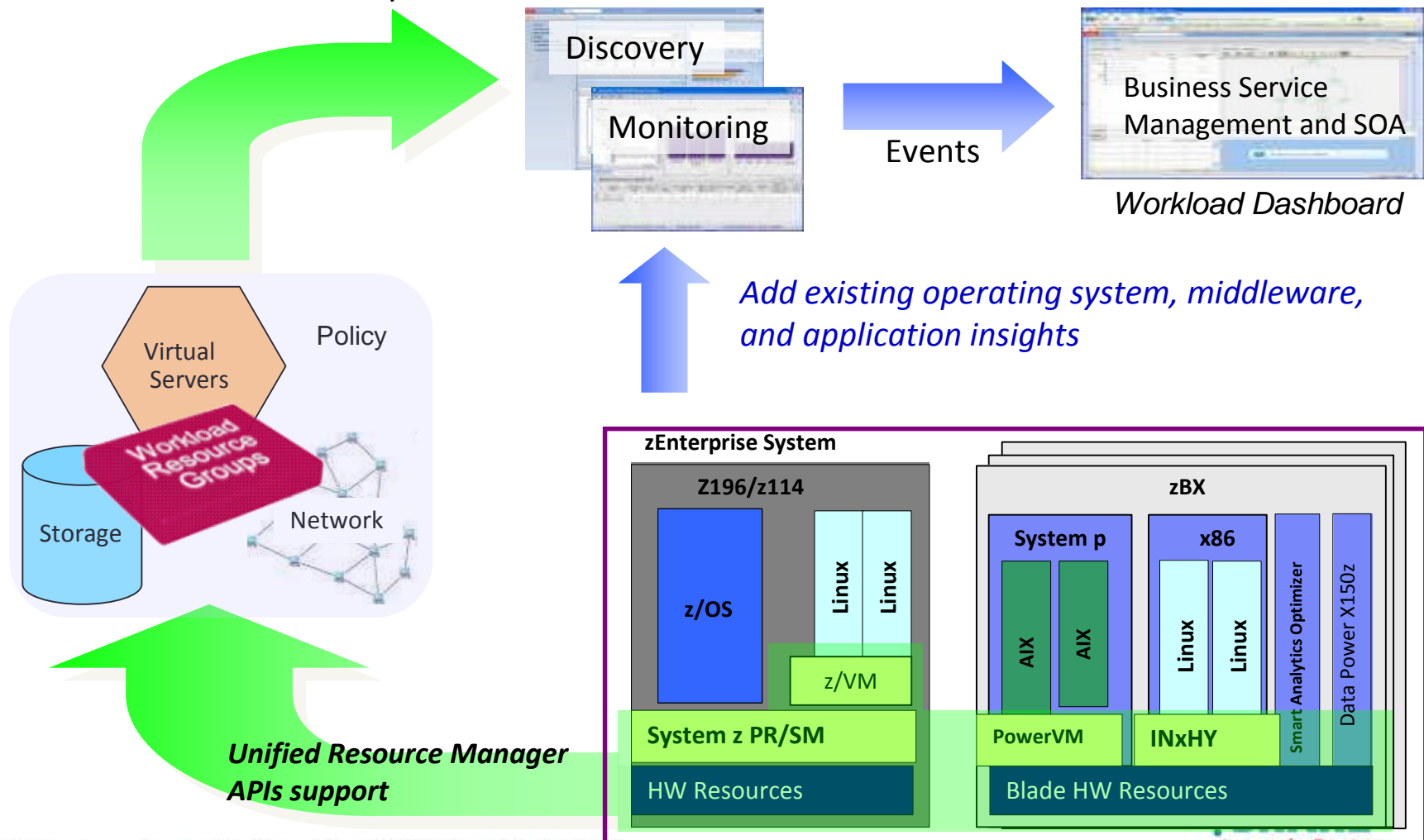



# Transaction Tracking designed to increase operations productivity and improve application availability

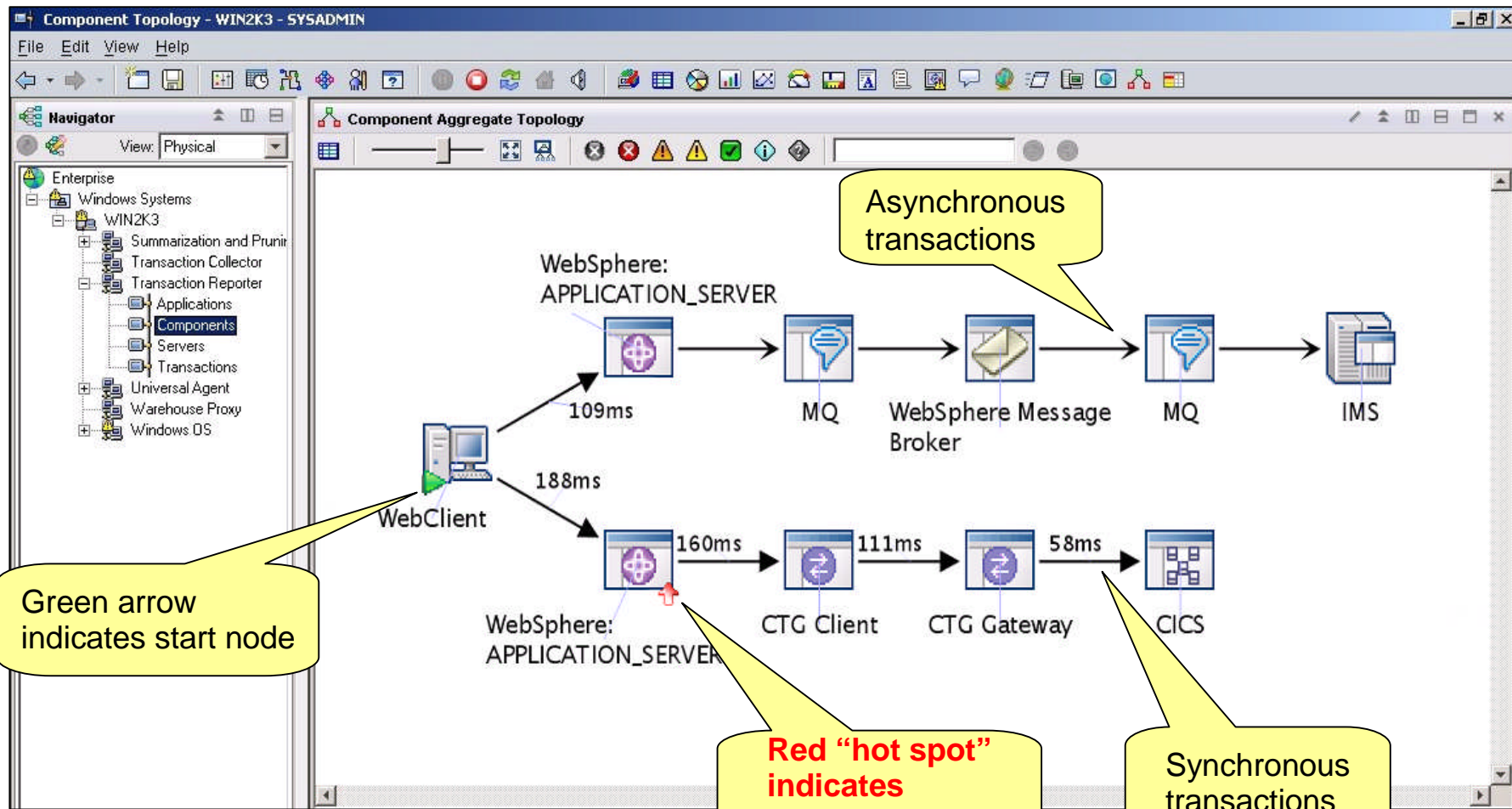

# Moving to simplified architecture driving decreased resource utilization with increased capability

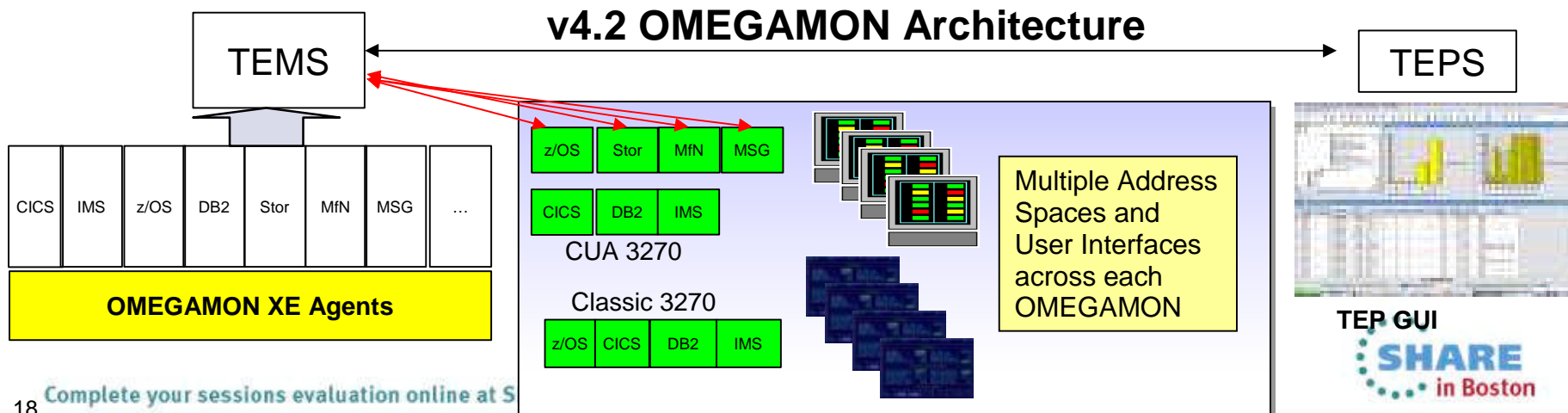
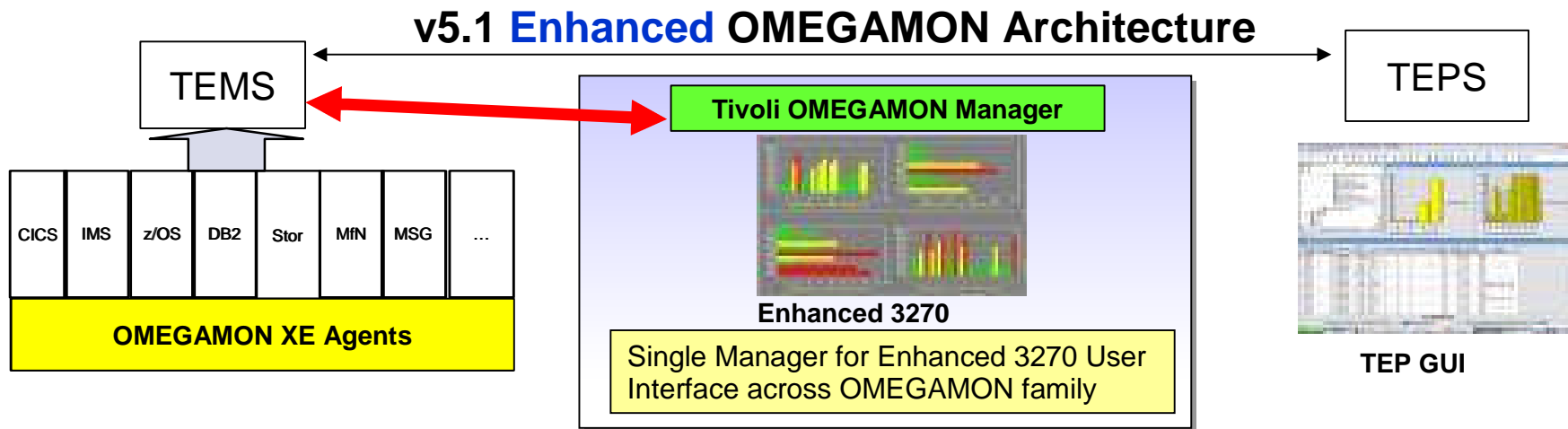

# OMEGAMON integrates within total Enterprise-wide Application Performance Management capability

Performance and availability visibility for System z events and data

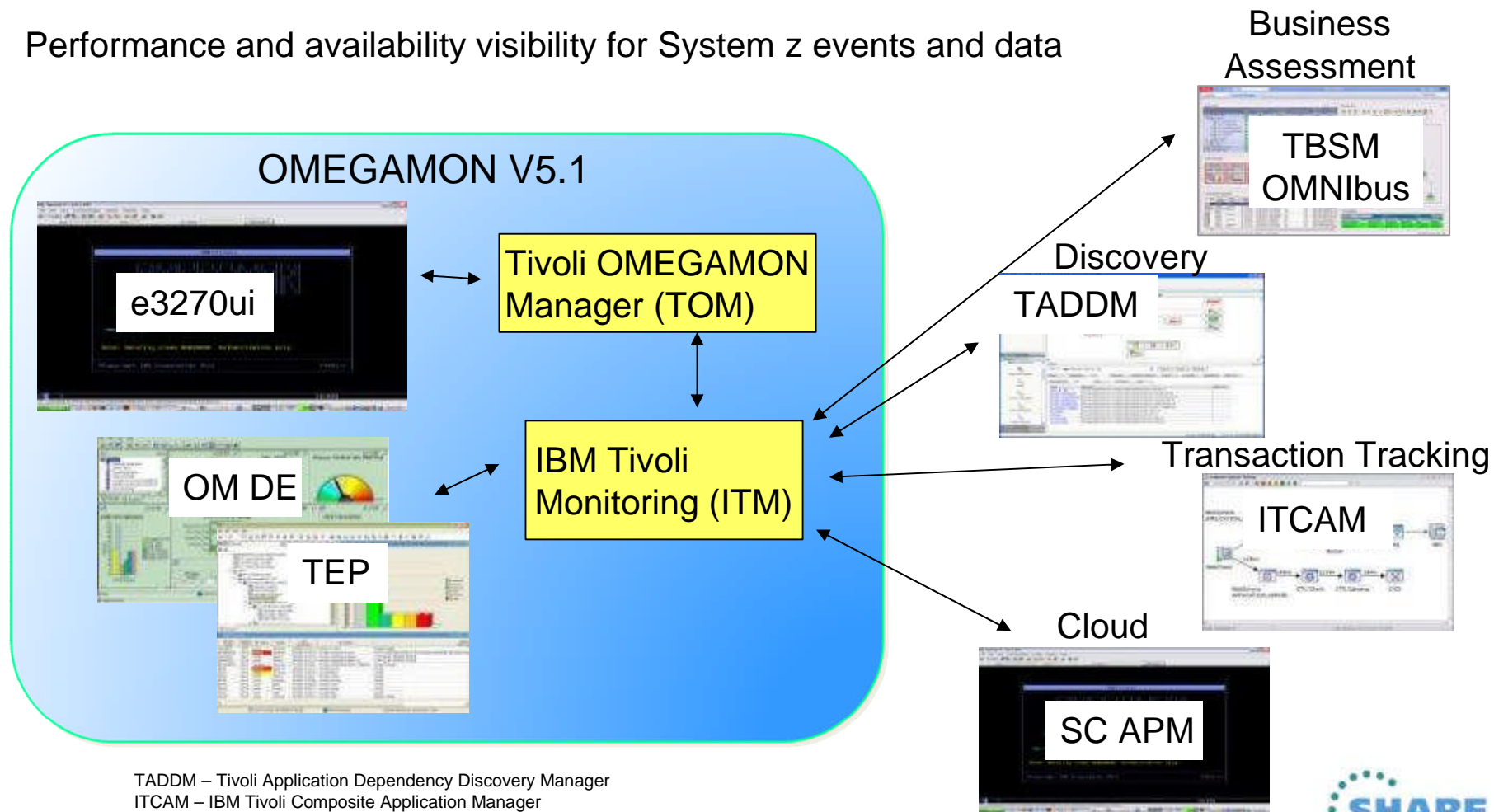

TADDM – Tivoli Application Dependency Discovery Manager  
 ITCAM – IBM Tivoli Composite Application Manager  
 TBSM – Tivoli Business Service Manager

# OMEGAMON and System Automation work together to improve availability and simplify operations

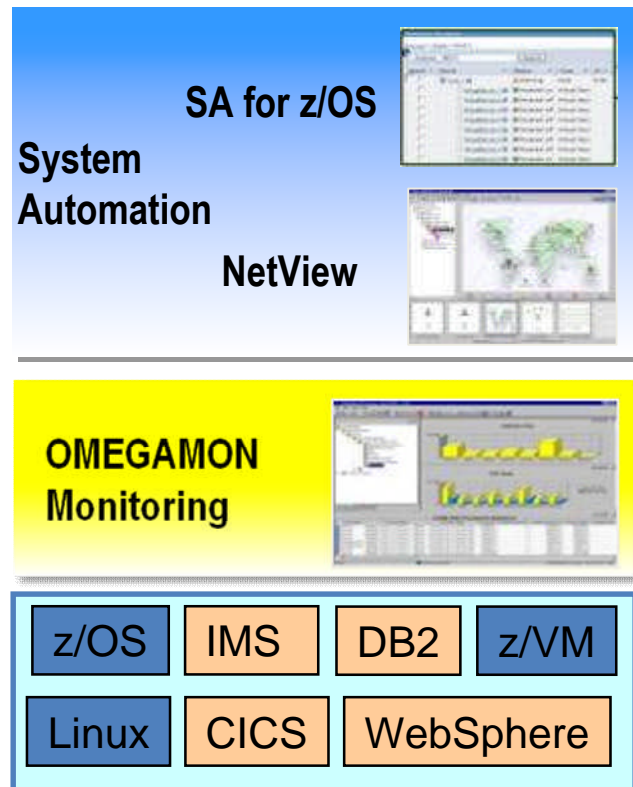

- Active or passive performance monitoring
  - Managed by automation
  - Integrated with monitor products
- Determine health state or exceeded thresholds
- Send a notification to event receiver or owner
- Start/stop/move resources (work around)
- Expert level: Cure performance problem
  - Using performance monitor, system or affected subsystem

## Learn more and join conversation on monitoring requirements going forward

Find documentation and latest advise on OMEGAMON V5.1

**Google:** OMEGAMON Common Information

### Join the Conversation:

- System z Service Management

**Google:** Developerworks System z Management

Includes:

- e3270ui workspace navigation (cheat sheets)
- Parmgen upgrade guidance reference material



## IBM continues to enhance Mainframe monitoring to address new technology, like Mobile, Big Data and Cloud



- **OMEGAMON XE V5** delivers significant new customer value based on high priority customer requirements
- Extended performance tuning methodology to **end-to-end Application Performance Management**
- Enhanced **Cross-Product** capabilities to simplify operations ability to achieve optimal services

## Learn more about the IBM's Mainframe support for Visibility, Control and Automation

Mainframe Service Management	<a href="http://www-01.ibm.com/software/os/systemz/itsm/">http://www-01.ibm.com/software/os/systemz/itsm/</a>
Workload and System Automation	<a href="http://www-01.ibm.com/software/tivoli/solutions/system-workload-automation/">http://www-01.ibm.com/software/tivoli/solutions/system-workload-automation/</a>
Tivoli Workload Scheduler	<a href="http://www-01.ibm.com/software/tivoli/products/scheduler/">http://www-01.ibm.com/software/tivoli/products/scheduler/</a>
IBM Tivoli Monitoring	<a href="http://www-01.ibm.com/software/tivoli/products/monitor/">http://www-01.ibm.com/software/tivoli/products/monitor/</a>
OMEGAMON XE Family	<a href="http://www-01.ibm.com/software/tivoli/products/omegamonxeproductline/">http://www-01.ibm.com/software/tivoli/products/omegamonxeproductline/</a>
Tivoli System Automation for z/OS	<a href="http://www-01.ibm.com/software/tivoli/products/system-automation-zos/">http://www-01.ibm.com/software/tivoli/products/system-automation-zos/</a>
IBM Tivoli NetView for z/OS	<a href="http://www-01.ibm.com/software/tivoli/products/netview-zos/">http://www-01.ibm.com/software/tivoli/products/netview-zos/</a>
IBM Geographically Dispersed Parallel Sysplex	<a href="http://www-03.ibm.com/systems/z/advantages/gdps/index.html">http://www-03.ibm.com/systems/z/advantages/gdps/index.html</a>

Thank  
You