



IBM Rational Software Conference 2009
As Real as It Gets!



IBM Rational Software Conference 2009

Enterprise Modernization

*Lowering the cost of multi-platform
application development and delivery*

Wendy Toh

Director of Development

Rational Enterprise Modernization & Compilers

wendytoh@us.ibm.com

Rational. software

Change is the new norm



There are **1 billion** camera phones in use today



IBM Sequoia Super Computer...
It would take the **entire population of the earth**, about six billion, each of us working a handheld calculator at the rate of one second per calculation, **more than 320 years to do what Sequoia can do in one day.**

**“8 of 10 CEOs see significant change ahead”
- 2008 IBM CEO Survey**

The **internet of people** is over one billion strong. The **internet of things** is almost one trillion.



By 2010, there will be **30 billion RFID tags** in circulation

Soon there will be over **2 billion people** on the web



China sends more text messages in a **week** than the U.S. does in 1 year



Change can be ~~very disruptive~~ an opportunity

IT skills shortage reaches highest level in 10 years

All software systems crashed due to software bug when F-22 flew over international dateline



50% of outsourced projects are expected to under perform

“The gap between expected change and the ability to manage it has almost tripled since 2006.”
 – 2008 IBM CEO study

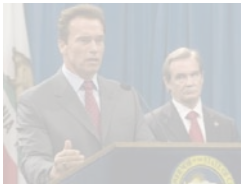

COBOL thwarts California's “Governator”

North Carolina Jobless Claims Crash State's Web Site



Ohio election web site shut down after being hacked



View fashion shows and collections on your iPhone



Malta is building a smart grid to link the power and water systems



Mobile phone provider “3” launches new handset to allow users to make free calls via Skype

Is your IT infrastructure flexible enough?



“The message for IT is clear; business needs and expects greater agility from IT. A new approach to IT delivery models and sourcing options is required that allows IT organizations to be more responsive to the needs of the business.”

– Gartner, October 14, 2008, “Changing the Cost Structure of IT Will Become a Business Imperative for Most CIOs”

Continual modernization for your applications, people, and your teams is required to build a flexible and dynamic IT organization

Key modernization challenges for IT organizations



"We don't understand the effort, risk and impact of modernizing our legacy software portfolio"



"Our skills gap just seems to keep growing. How do we stay current with all the language and technology changes?"



"Our architecture has evolved to be too complex and convoluted— we need to be flexible and agile."

"Our development teams working on different platforms are struggling to communicate. How do we collaborate in the context of our work?"



Application Challenges

- Lost application knowledge
- Architectural complexity
- Poor quality and performance
- Regulatory and compliance risks
- Higher costs

People Challenges

- Skills lock-in
- Plethora of new technologies
- Unattractive, low productivity tools
- Steep learning curve due to platform/language-unique tools

Team Challenges

- Poor communication
- Incompatible tools & processes across platforms
- Weak project oversight
- Lack of traceability across lifecycle

Enterprise Modernization solutions

A smarter way to maximize the value of your applications, people and teams

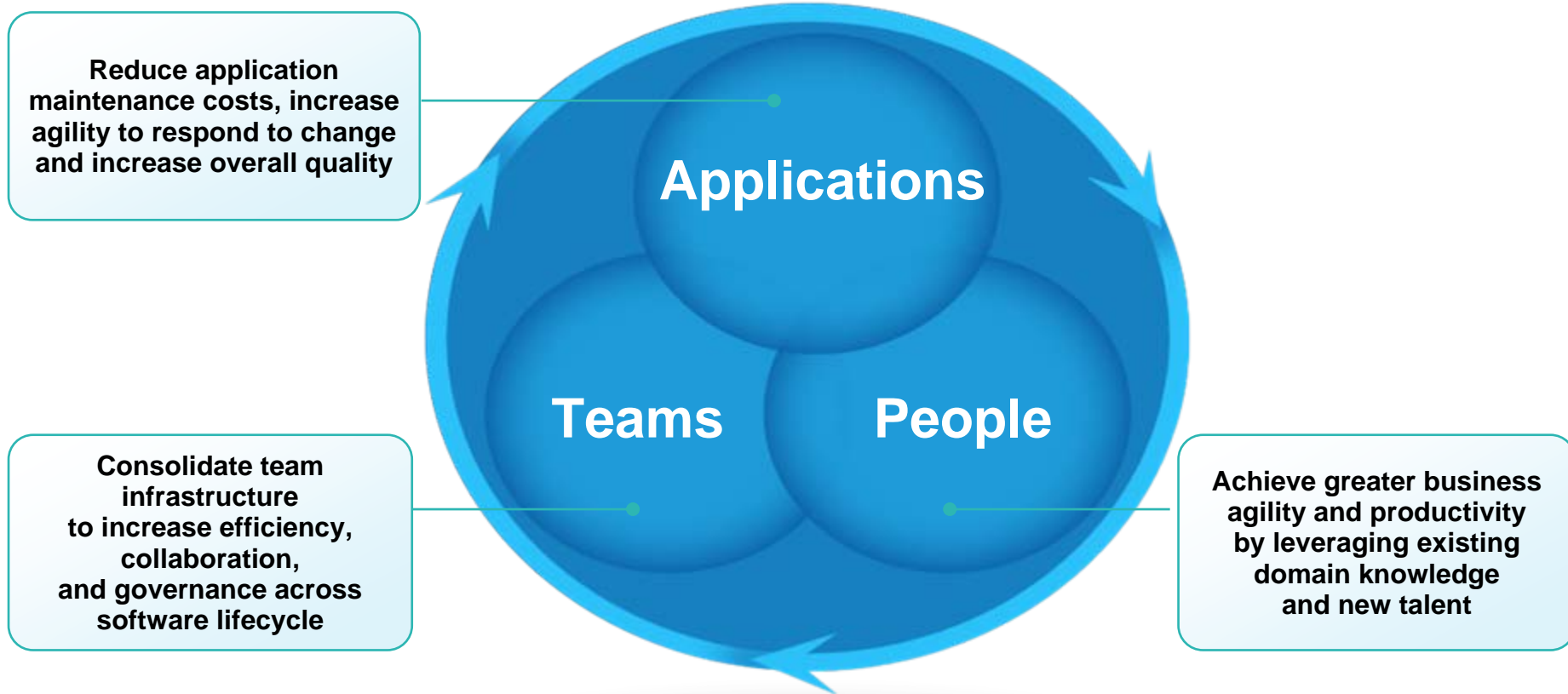

For more information, visit:
www.ibm.com/rational/modernization

Enterprise Modernization solutions

A smarter way to maximize the value of your applications, people and teams

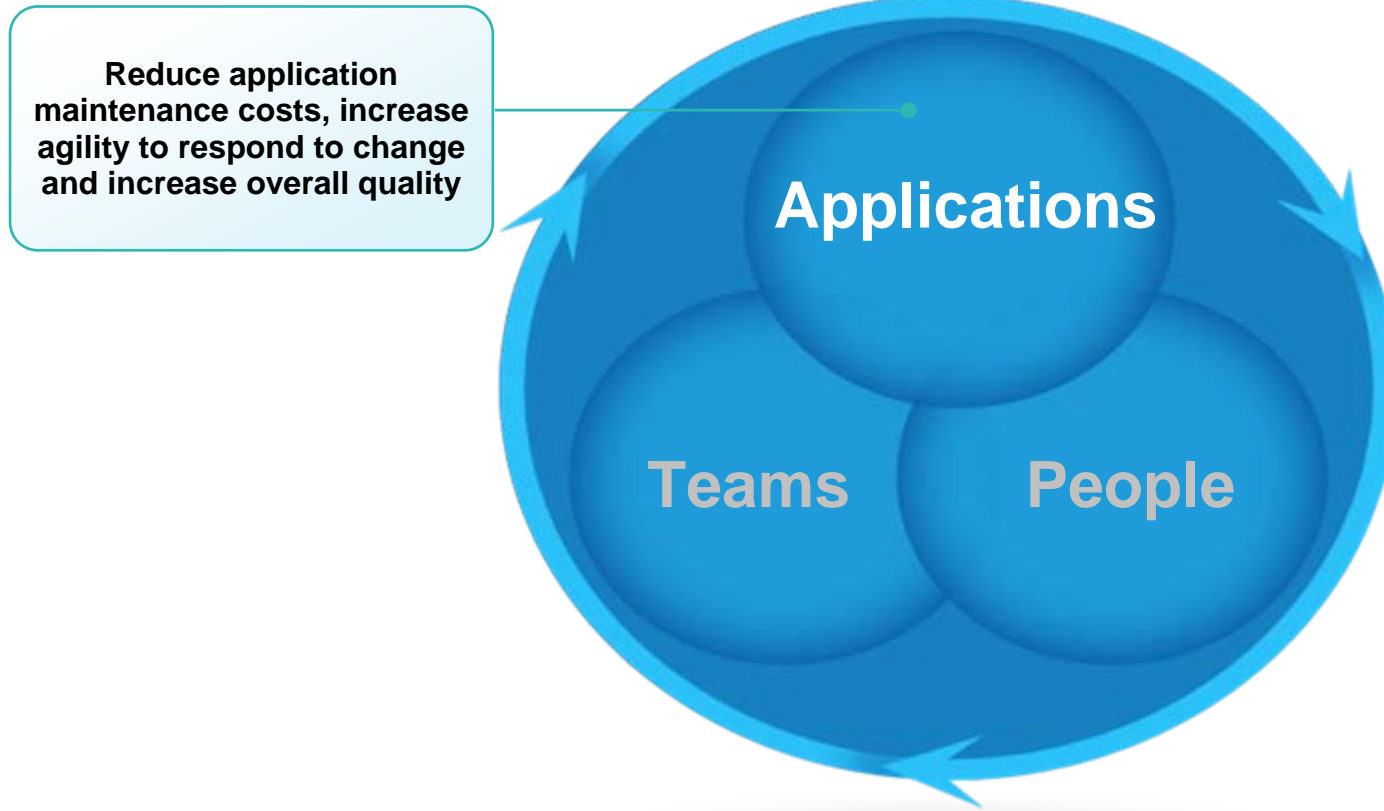

For more information, visit:
www.ibm.com/rational/modernization



Enterprises want to

Understand the impact and cost of change to their IT systems

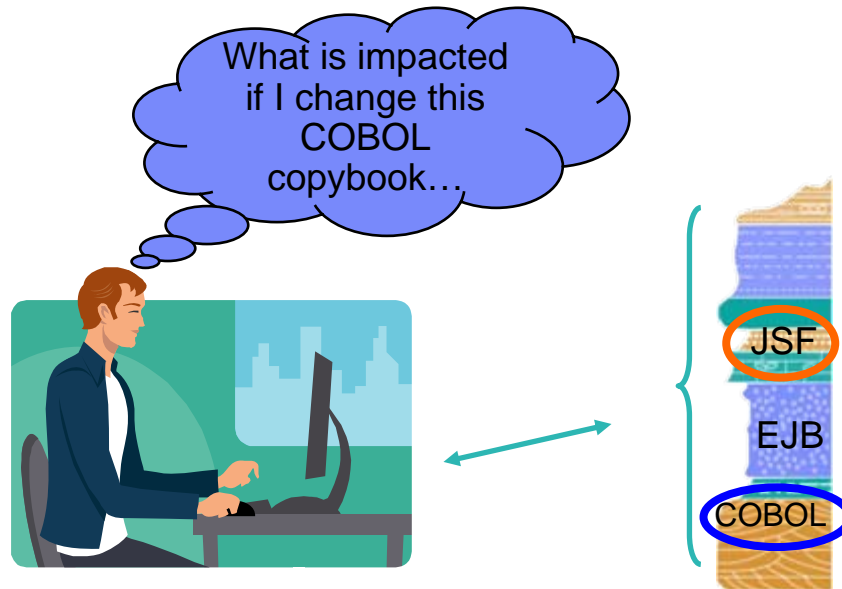

But

They have no business intelligence inventory of their application assets, relying instead on manual and error-prone processes and incomplete knowledge. They must compensate with more extensive planning and extra testing.



Solution: Business intelligence for applications

Restore lost application knowledge via technical analysis

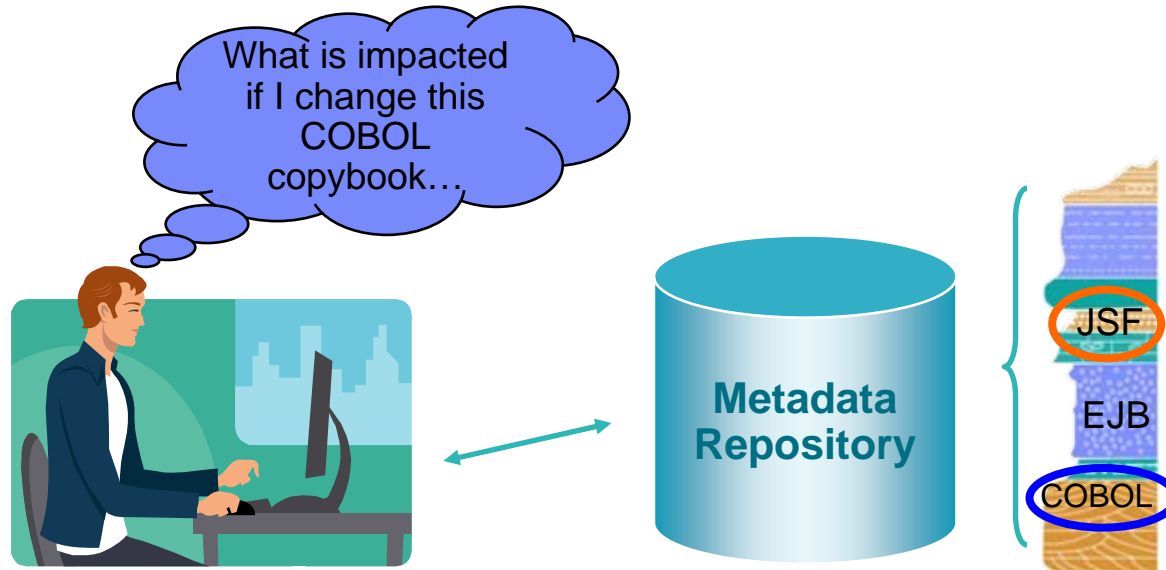

Rational Asset Analyzer
WebSphere Studio Asset Analyzer

Delivering

Reduced risk by quickly determining the full impact of proposed changes and lowered costs via dead code elimination, optimal planning, focused testing and faster development



Enterprises want to

Have a nimble IT organization that leverages SOA to respond more quickly to the needs of the business

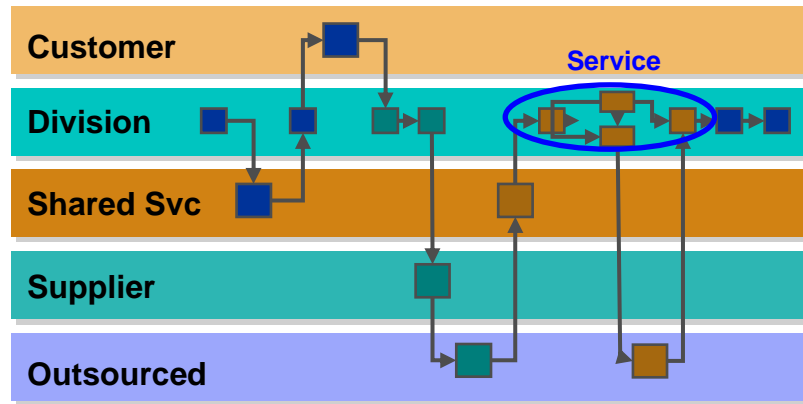
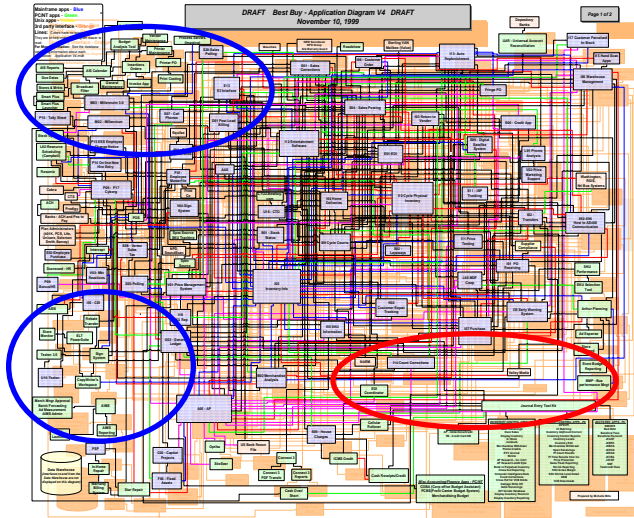

But

They have application architectures that were built incrementally over the last 20-30 years and are no longer flexible or agile



Solution: SOA tools for all platforms, languages

Use powerful tools to quickly begin SOA evolution by leveraging the proven assets that have been running the enterprise for years, and then accelerate with visual specifications and platform-independent services

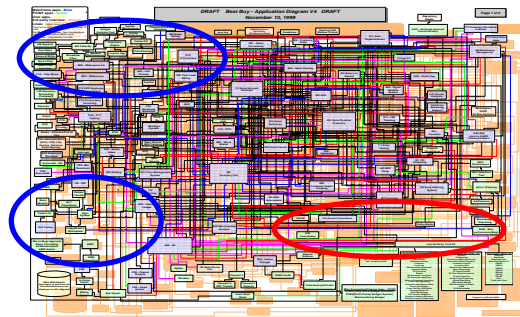

*EGL, C/C++, COBOL, PL/I, RPG,
Java applications, stored procedures, SQL*

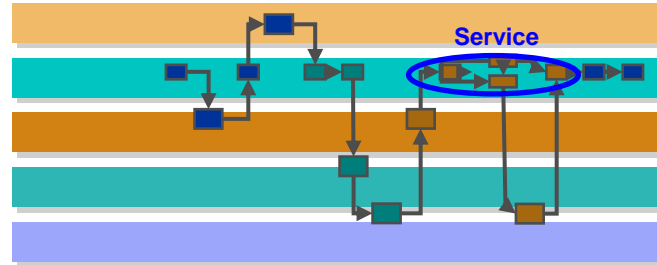

*Rational Application Developer
Rational Developer for System z
Rational Developer for i for SOA Construction
Rational Business Developer
Host Access Transformation Services*

Delivering

5x lower costs through reuse of existing assets, higher productivity and platform portability of new services

Developer's SOA Roadmap for System z and IBM i

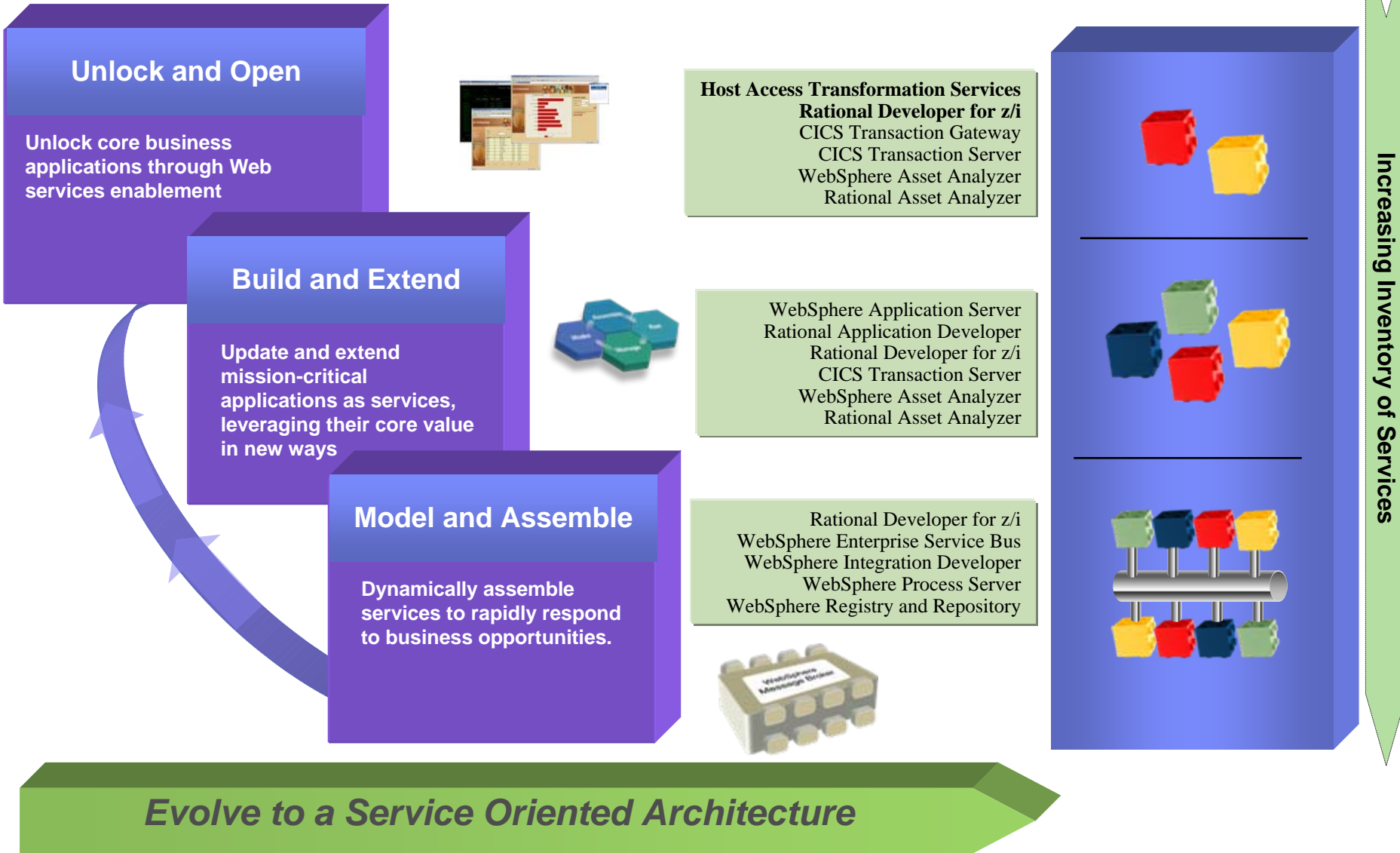



Enterprises want to

Provide a range of appealing, more intuitive user interfaces to increase employee productivity and boost customer satisfaction



But

The cost of replacing or re-writing these applications is prohibitive, and they may not have the necessary web and UI technology skills



Solution: UI modernization

Deploy the ideal UI for your application, from quickly creating a modern web UI from an existing green screen application to customizing a highly interactive, graphical web 2.0 UI

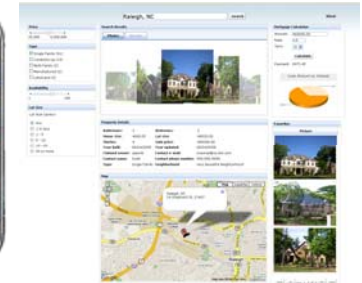

*Host Access Transformation Services
Rational Application Developer
Rational Developer for System z
Rational Business Developer*

Delivering

Greater customer satisfaction, lower employee training costs, and fewer errors from more modern and compelling UIs



Host Access Transformation Services (HATS)

■ What can you do with HATS?

- ▶ Quickly and easily create Web, portal or rich client applications
 - Provide easy-to-use GUI for your green-screen applications
 - Low skills requirement
 - Highly customizable
 - Iterative development process
 - Transformation “on the fly”
- ▶ Extend terminal application tasks as Web services



■ Benefits

- ▶ Extend host application to new users
- ▶ Improve the navigation of your host application
- ▶ Reuse your existing assets in a Service Oriented Architecture
- ▶ Avoid rewriting applications (no impact to code)

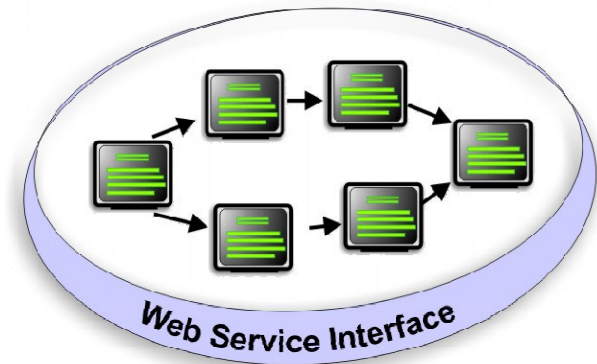

Enterprise Modernization solutions

A smarter way to maximize the value of your applications, people and teams

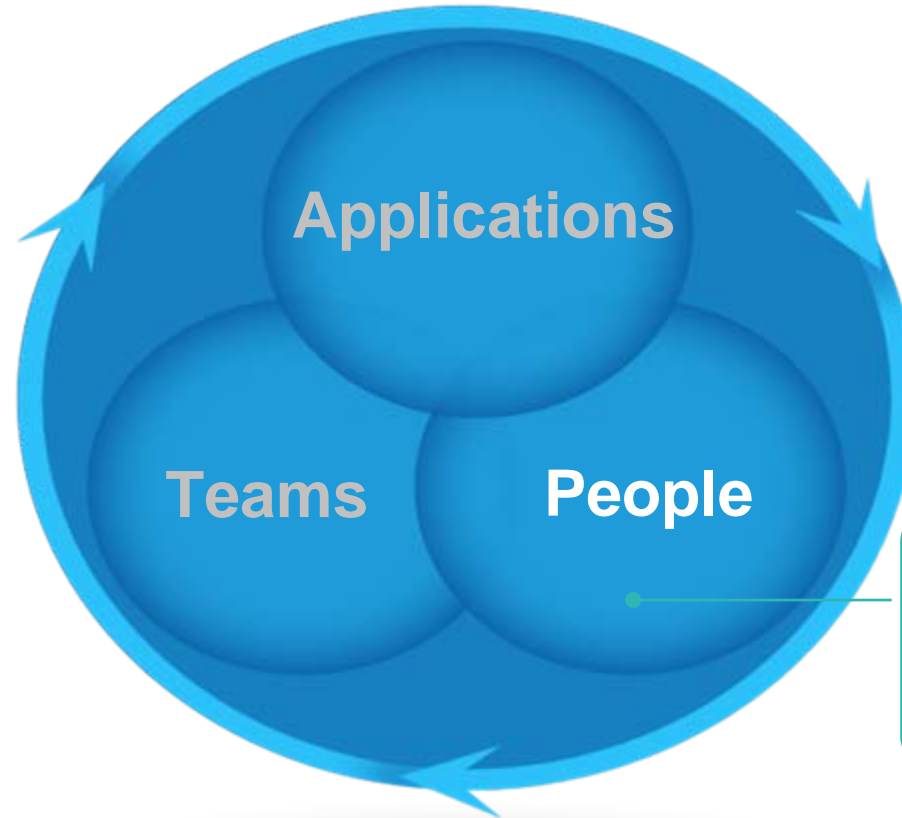

Achieve greater business agility and productivity by leveraging existing domain knowledge and new talent

For more information, visit:
www.ibm.com/rational/modernization



Enterprises want to

Increase productivity of their “backend” development staff, as well as attract new employees to this work

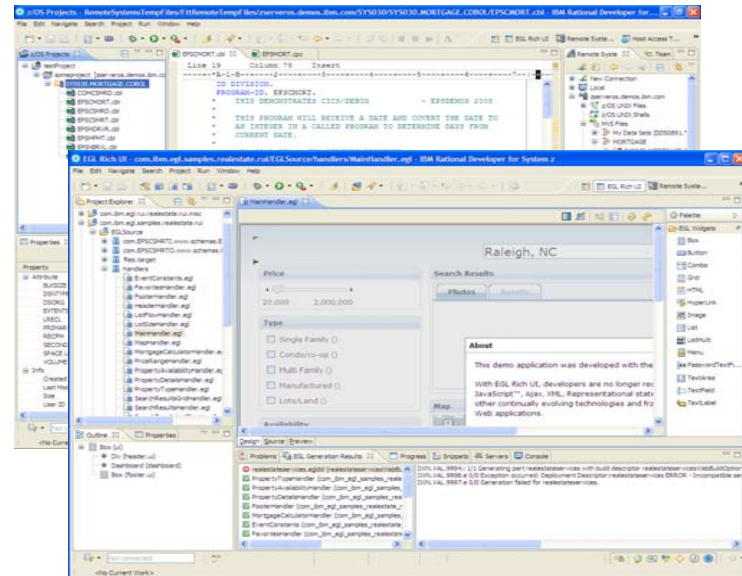

But

They have antiquated development tools which deliver low productivity and are unattractive to younger staff





Solution: Modern IDEs for all platforms and languages

Upgrade to modern Eclipse-based tools to develop and maintain enterprise applications spanning multiple platforms and languages

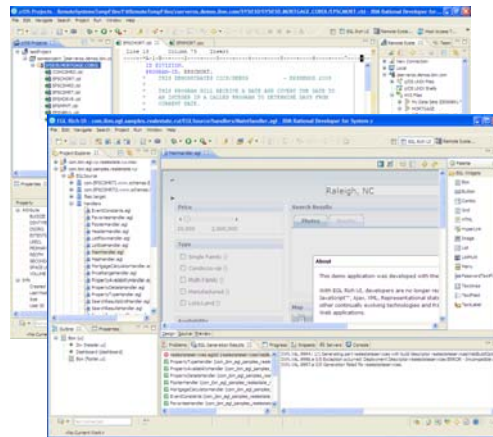

*Rational Developer for System z
Rational Developer for IBM i
Rational Business Developer*

Delivering

50%-80%¹ reduction in host CPU usage with workstation syntax checking, ~15% improvement in developer productivity¹, and tools with which to attract new talent

¹ Aggregation of results from a productivity study conducted by IBM System z customers.





Enterprises want to

Build modern, multi-platform applications with existing and new staff

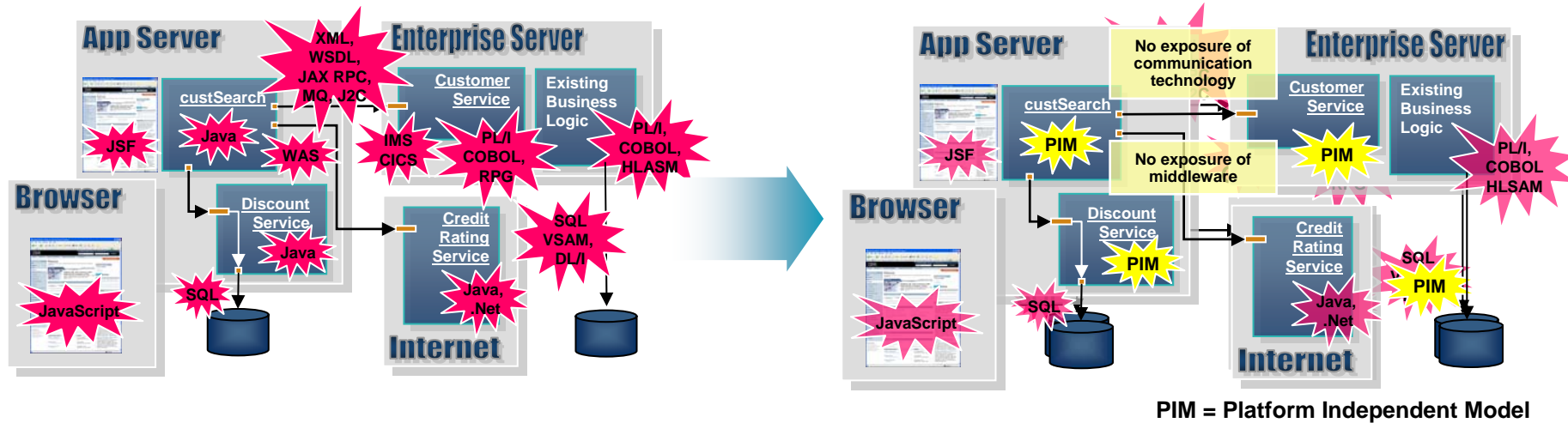

But

They have different teams of developers for each platform, and re-training them to all the new technologies would be costly, time consuming, and often impractical



Solution: EGL – next gen business language

Build new or extend existing multi-platform enterprise applications leveraging EGL with its middleware abstractions and high productivity language and development environment

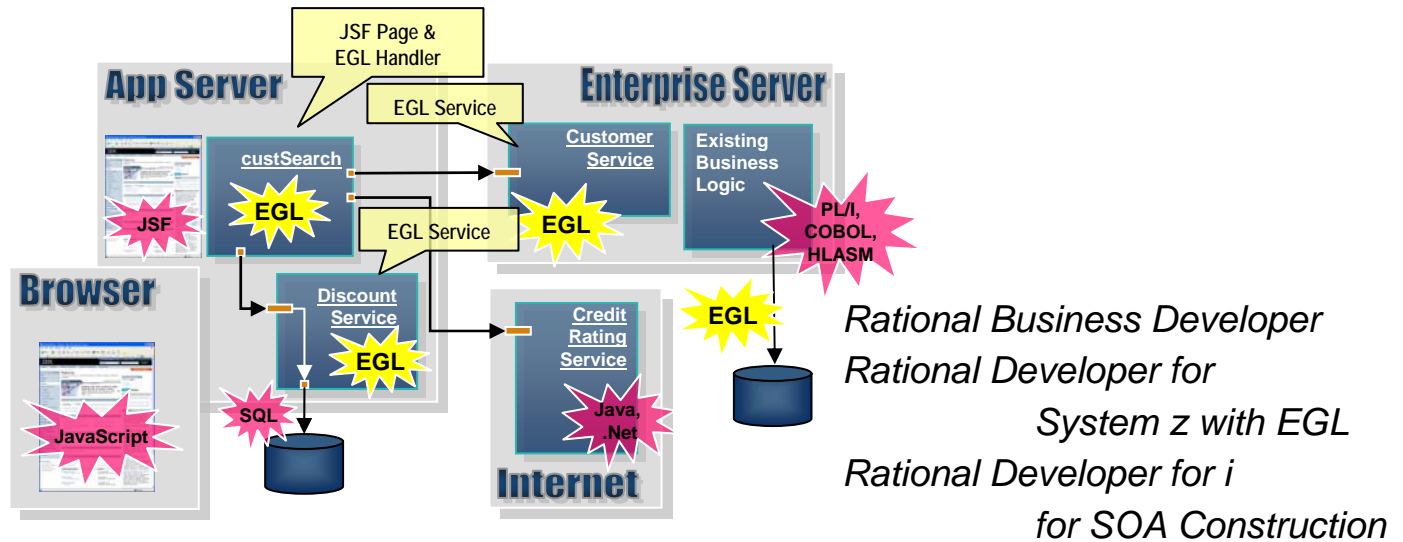

Delivering

Skills flexibility, high productivity and platform portability for existing and new developers when building all types of modern enterprise applications





Enterprises want to

Reduce tool support costs and move to modern platforms, languages, and tools for their multi-platform application development



But

They are stuck on poorly supported, expensive, legacy development platforms



Solution: Application transformation tools and services

Migrate from old, stagnant languages to modern development platforms, languages and tools

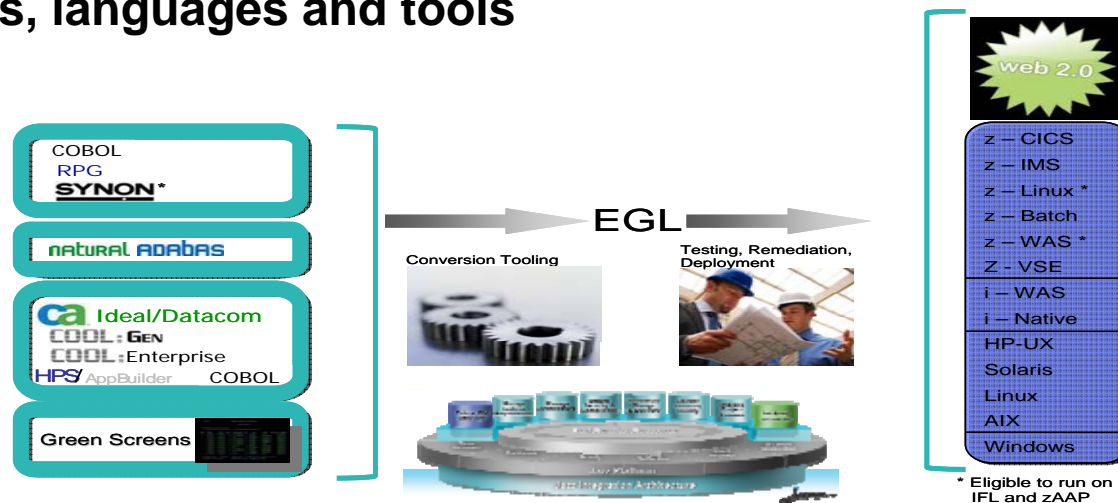

*Rational Migration Extension for Natural
Rational Migration Extension for IBM i*

Delivering

Greatly reduced development platform support costs, and more flexible, integrated SDLC environment for making future application enhancements (eg. SOA and web 2.0)

Enterprise Modernization solutions

A smarter way to maximize the value of your applications, people and teams

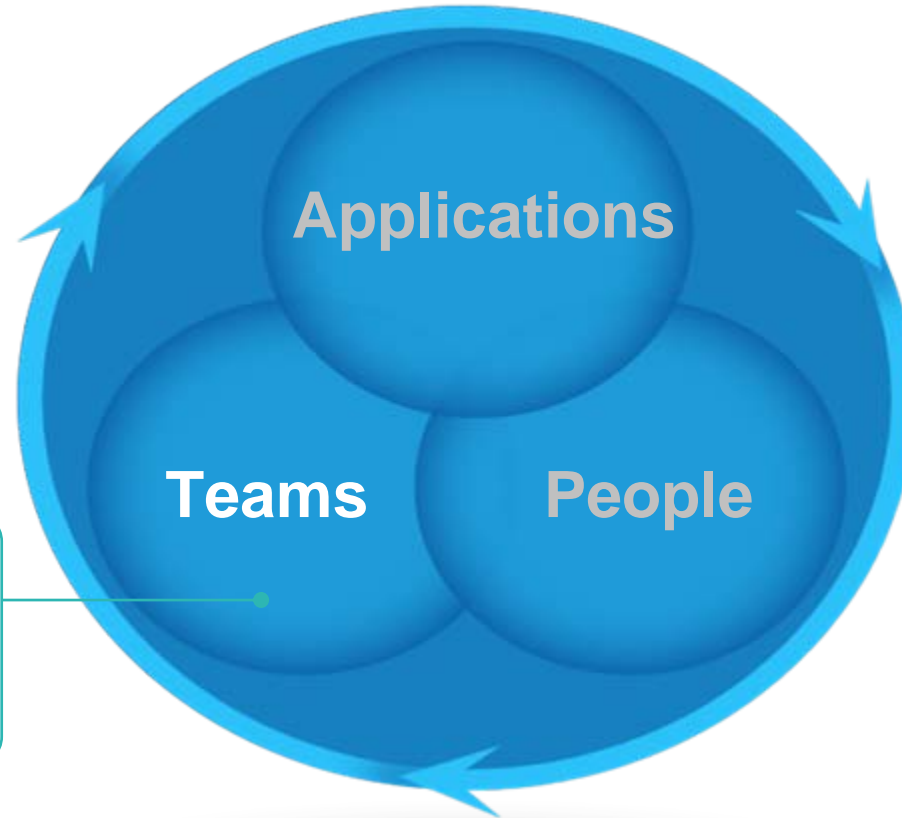

Consolidate team infrastructure to increase efficiency, collaboration, and governance across software lifecycle

For more information, visit:
www.ibm.com/rational/modernization



Enterprises want to

Enable agile, multi-platform and cross-geo collaboration and governance

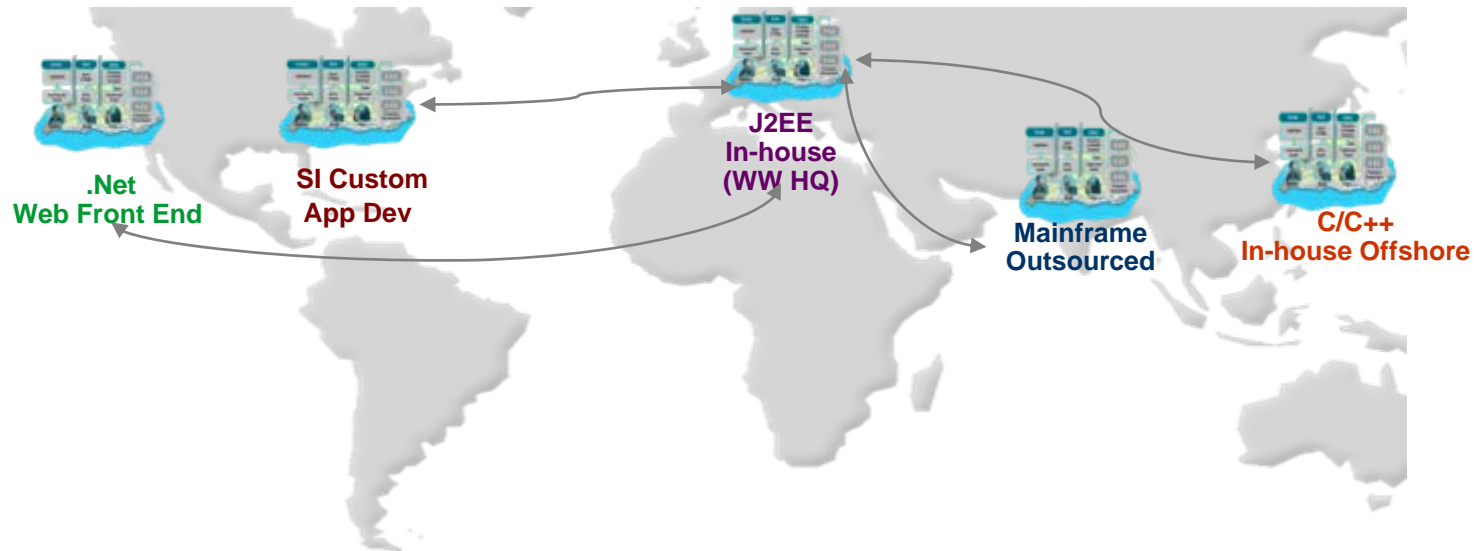

But

They have “islands” of development, each with different tools, processes and team infrastructure, and they do not support real-time collaboration or integrated, comprehensive oversight



Solution: Modern team infrastructure

Deploy new team infrastructure that supports collaboration in context across all platforms and geographies, real-time, automated monitoring of project health, and built-in development workflows

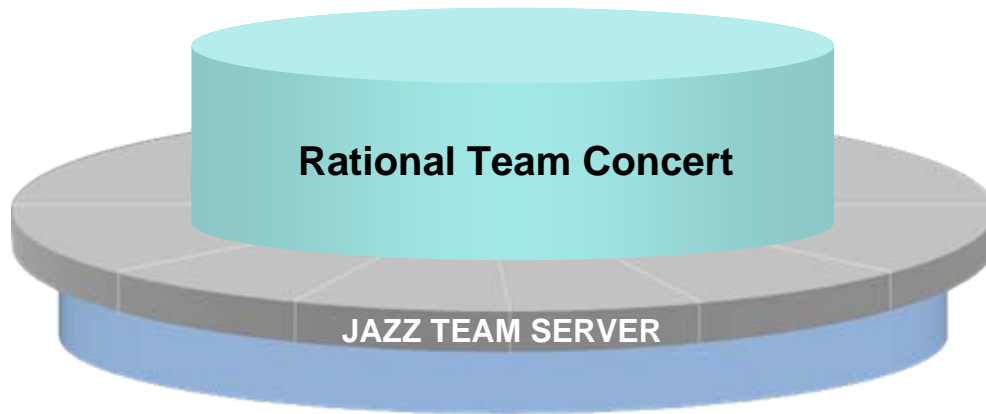

*Rational Team Concert for System z
Rational Team Concert for i
Rational Team Concert*

Delivering

Improved communication, higher quality, informed decision-making, and more automated, transparent and predictable software development



A platform for the business process of software delivery

Aligning with evolving business priorities and stakeholder constituencies

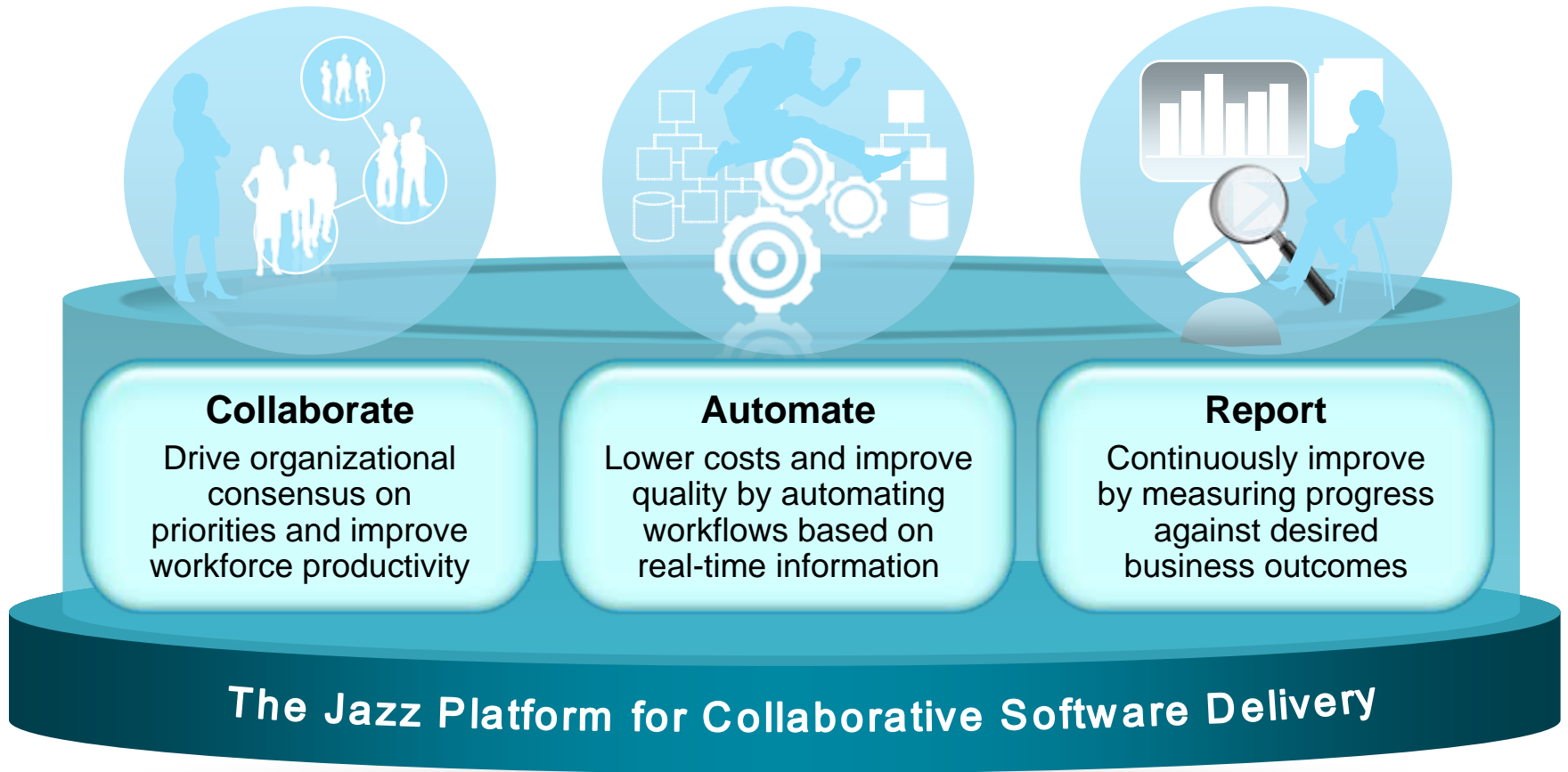

Rational Team Concert Features

Iteration Planning

- Integrated iteration planning and execution
- Task estimation linked to key milestones
- Out of the box agile process templates

Project Transparency

- Customizable web based dashboards
- Real time metrics and reports
- Project milestone tracking and status

SCM

- Integrated stream management with flow relationships
- Component level baselines
- Server-based sandboxes
- Identifies component in streams and available baselines
- ClearCase connector

Work Items

- Defects, enhancements and conversations
- Query results view and share queries with team or member
- Support for approvals and discussions
- ClearQuest connector
- Query editor interface

Build

- Work item and change set traceability
- Local or remote build servers
- Supports ant and command line tools
- Integration with build forge
- Build definitions for team and private builds

Jazz Team Server

- Single structure for project related artifacts
- World-class team on-boarding / off boarding including team membership, sub-teams and project inheritance
- Role-based operational control for flexible definition of process and capabilities
- Team advisor for defining / refining “rules” and enabling continuous improvement
- Process enactment and enforcement
- In-context collaboration shows team members and status of their work



RTC for System z and IBM i



- ▶ **Consolidate distributed, z/OS, and IBM i development** teams on a common software platform to improve collaboration, project efficiencies, and to reduce overall development costs for cross-platform projects
- ▶ Provide **project planning and process governance supporting Agile** development for Java, distributed, IBM i, or z/OS development projects
- ▶ Improve **quality of service** and **server uptime** by leveraging System z hardware and middleware
- ▶ Integrate with existing System z or IBM i **disaster recovery** solutions
- ▶ Support **server consolidation** onto Linux on System z

Example: Agile transformation

- Challenge
 - Build skills to maintain and enhance growing code base
 - Need to increase flexibility and responsiveness to new requirements
- Team adopted RTC for IBM i and implemented agile processes and practices

	Components/Person	Lines of code/Person	Supported Products	Releases/Year
2007	1	18k	2	1
2008	4 (400% improvement)	70k (390% improvement)	7 (350% improvement)	2 (200% improvement)

- Improved team efficiency
 - 400% improvement in the amount of code supported per person
 - Reduced team doubled the number of releases per year
 - 3.5 times as many releases supported today
 - Reduced cycle time
- No one owns a component, everyone owns the solution
 - Improves understanding of customer needs
- Transparency via 2wks iterations (for management and team)
 - Improved morale, total team in sync with goals
- Reduce waste

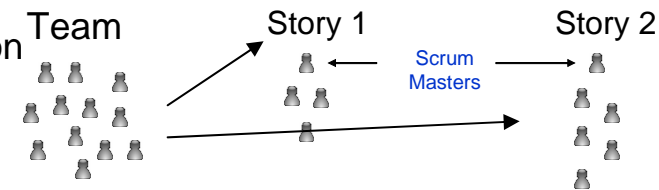

Rational Enterprise Modernization Solutions

Lowering the cost of multi-platform application development and delivery

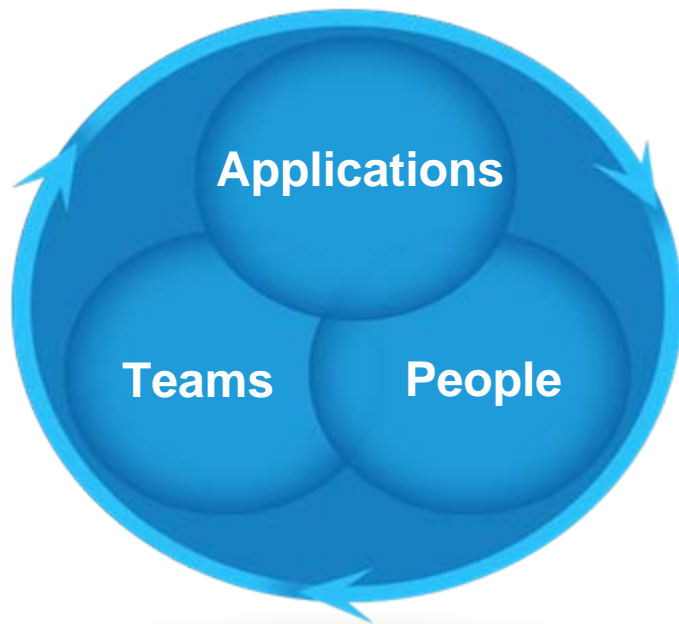

- ✓ Difficult times present opportunities to companies that can adapt quickly
- ✓ IT frequently inhibits flexibility due to fragile and poorly understood applications, limited staff productivity, poor collaboration and traceability across teams
- ✓ Rational Enterprise Modernization solutions deliver flexibility by:
 - ▶ Improving how you build, maintain, and manage your applications
 - ▶ Helping your people be more productive
 - ▶ Consolidating and connecting teams across locations, roles, and platforms

Leverage IBM Services to get started today

- **Executive Services**
 - ▶ Schedule an *Enterprise Modernization Executive Planning Session* to define modernization strategies

- **Application Modernization Services**
 - ▶ Application Assessments to:
 - ▶ Develop Modernization roadmaps to resolve specific business issues
 - ▶ Improve Application Quality & Performance
 - ▶ Identify opportunities for business software delivery improvements

- **People and Team Modernization Services**
 - ▶ Provide Implementation Services for Rational Enterprise Modernization tools
 - ▶ Provide SCM migration assistance
 - ▶ SDLC Assessments to:
 - ▶ Improve Software Delivery performance
 - ▶ Implement Software Delivery Metrics to more effectively manage the software development environment

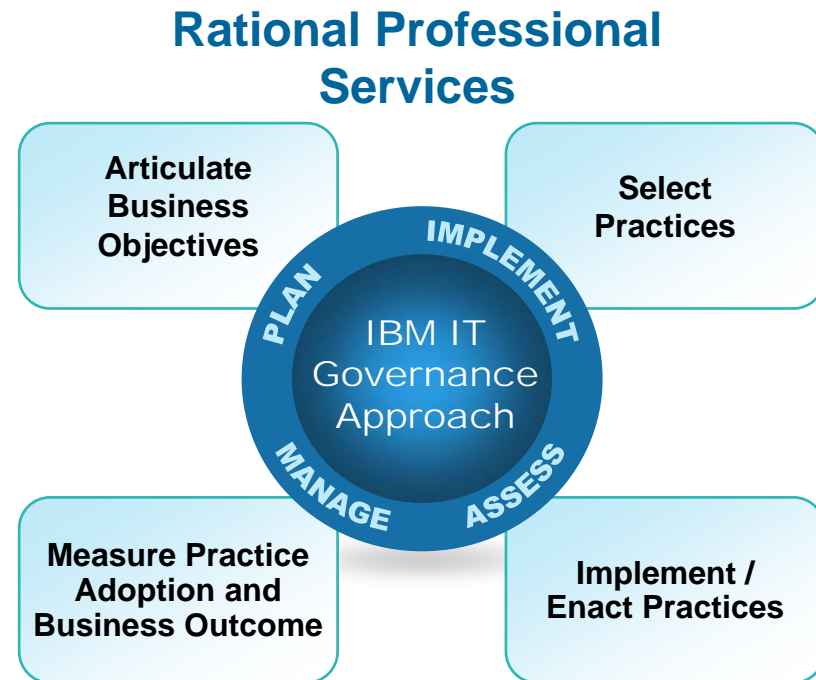

More ways to get started

System z and IBM i Sandboxes

Example assets and best practices providing low-risk, practical, hands-on path to leveraging IBM solutions

- ▶ Full version software trials
- ▶ 'Try online' hosted System z and IBM i environments
- ▶ Hands-on-exercises

Community Cafés

Harness a growing community of business partners, customers, and IBM employees

- ▶ C/C++ Café
- ▶ EGL Café
- ▶ RPG Café
- ▶ COBOL Café – coming soon

*Jump-start
your
modernization
projects!*

Education Series

Modern Application Architecture for COBOL Developers

Learn how to design and integrate composite applications across CICS and WebSphere – leveraging existing COBOL processes

EGL Distance Learning

Eight days of training free electronically - lectures, labs, and electronic support



Learn more at:
www.ibm.com/rational/modernization





- **RDz V.Next**

- ▶ Support reuse of CICS v4.1 applications as services (tech preview)

<https://www14.software.ibm.com/iwm/web/cc/earlyprograms/ibm/cicsts41open/>

- ▶ Integration with CA Endevor® SCM (tech preview)

[http://www-](http://www-01.ibm.com/support/docview.wss?rs=3365&context=SSQ2R2&context=SS9KR6&context=SS2JX4&context=SS2QJ2&context=SSSTY3&context=SSDV2W&dc=D400&uid=swg24022860&loc=en_US&cs=utf-8&lang=en)

[01.ibm.com/support/docview.wss?rs=3365&context=SSQ2R2&context=SS9KR6&context=SS2JX4&context=SS2QJ2&context=SSSTY3&context=SSDV2W&dc=D400&uid=swg24022860&loc=en_US&cs=utf-8&lang=en](http://www-01.ibm.com/support/docview.wss?rs=3365&context=SSQ2R2&context=SS9KR6&context=SS2JX4&context=SS2QJ2&context=SSSTY3&context=SSDV2W&dc=D400&uid=swg24022860&loc=en_US&cs=utf-8&lang=en)

- ▶ RTCz - extend the z/OS platform to support multiplatform software development and delivery on z/OS, Windows, and Linux, integration with RDz (tech preview)

<https://jazz.net/downloads/rational-team-concert/>

- Tech preview for new **C/C++ and COBOL IDEs for POWER** on alphaWorks

<http://alphaworks.ibm.com/tech/cremoteide>

- **RTCz open beta** – try out the latest features for z/OS development

<https://www-304.ibm.com/software/earlyprograms/surveys/cust/nomination.wss?id=875>

- Improve your skills - preview version of **online course to learn COBOL** with RDz, at the COBOL Café

<http://www-949.ibm.com/software/rational/cafe/docs/DOC-3129>

- **Free version of EGL**, with Java & Web 2.0 support, available soon on the EGL Café

<http://www-949.ibm.com/software/rational/cafe/community/egl>

Thank You

© Copyright IBM Corporation 2009. All rights reserved. The information contained in these materials is provided for informational purposes only, and is provided AS IS without warranty of any kind, express or implied. IBM shall not be responsible for any damages arising out of the use of, or otherwise related to, these materials. Nothing contained in these materials is intended to, nor shall have the effect of, creating any warranties or representations from IBM or its suppliers or licensors, or altering the terms and conditions of the applicable license agreement governing the use of IBM software. References in these materials to IBM products, programs, or services do not imply that they will be available in all countries in which IBM operates. Product release dates and/or capabilities referenced in these materials may change at any time at IBM's sole discretion based on market opportunities or other factors, and are not intended to be a commitment to future product or feature availability in any way. IBM, the IBM logo, Rational, the Rational logo, Telelogic, the Telelogic logo, and other IBM products and services are trademarks of the International Business Machines Corporation, in the United States, other countries or both. Other company, product, or service names may be trademarks or service marks of others.