

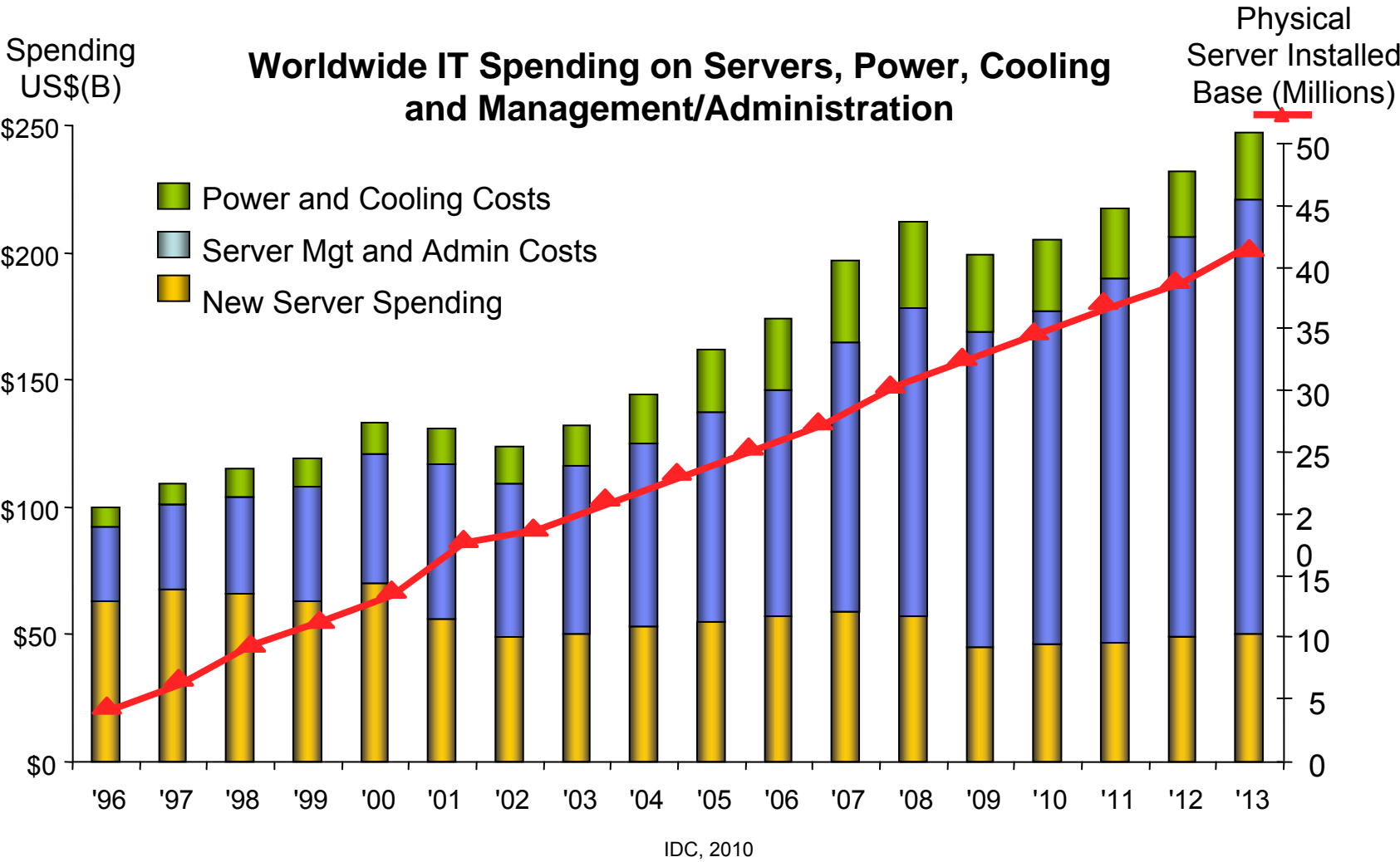

zEnterprise – The Ideal Platform For Smarter Computing

Improving Service Delivery With
Private Cloud Computing

IT Labor Costs Continue To Increase



Deliver Services Via Cloud To Reduce Labor Costs

- Self-service requests
 - ▶ User request services via a web portal
- Fast provisioning
 - ▶ Automated provisioning/de-provisioning of resources as needed
- Elastic capability
 - ▶ Resource can be elastically provisioned to quickly scale out and rapidly released to quickly scale in
- Low cost pay as you go
 - ▶ Users pay for what they use

Businesses Have Concerns About Public Clouds

■ Lack of Reliability

▶ Examples of public cloud outages

- April 2011, Amazon, 2 days,
- April 2011, Azure, 6 hours
- Jan 2011, Salesforce, 1 hour
- May 2010, Amazon, 4 outages in 1 week
- April 2010, Azure, 40 mins
- June 2009, Amazon, 5 hours
- March 2009, Azure, 22 hours
- July 2008, Amazon, 5 hours 45 mins
- April 2008, Amazon, 3 hours
- Feb 2008, Amazon 2 hours; Salesforce.com, 1 day

Amazon's Trouble Raises Cloud Computing Doubts

April 22,2011 Computerworld

As technical problems interrupted computer services provided by [Amazon](#) for a second day on Friday, industry analysts said the troubles would prompt many companies to reconsider relying on remote computers beyond their control.

■ Lack of Security/Compliance

- ▶ Isolation of applications and data, data encryption/segregation
- ▶ Compliance with laws and regulations

■ Limited Archiving

- ▶ Network performance and amount of data involved are limiting factors

Transform And Improve Service Delivery With A Private Cloud Instead

- **“Private”** because it is only used by enterprise employees
- Offers same capabilities as a public cloud
 - ▶ Virtualization platform with elastic scalability
 - ▶ Support for instant provisioning of service
 - ▶ Self-service portal to request service
 - ▶ Metering and billing capability to support pay as you go model
- But with advantages over a public cloud
 - ▶ Multiple architectures
 - ▶ Control of security, data protection, availability, and workload management policies
 - ▶ Lower cost!

What Technology is Needed for a Private Cloud?

Improve Service Delivery With A Private Cloud On zEnterprise And Reduce Costs

Virtualization Platform

Enterprise Linux Server Solution Edition for Enterprise Linux

BladeCenter Extension (zBX)

Unified Resource Manager (zManager)

Multi-architecture virtual environment

Elasticity

Entry Cloud

zEnterprise Cloud Starter Edition

Automated provisioning
Resource monitoring

Advanced Cloud

System z Solution Edition for Cloud Computing

Self-service
Automated provisioning
Resource monitoring
Metering and billing

zEnterprise Provides An Optimized Virtualized Platform

- Multi-architecture virtual environments enable a broad range of workloads
- Elastic Scalability
 - ▶ Add processors to z114 / z196 while running
 - ▶ zManager provides consistent structured management for all virtual environments
 - Add and configure a blade quickly
 - Create virtual machines and networks quickly

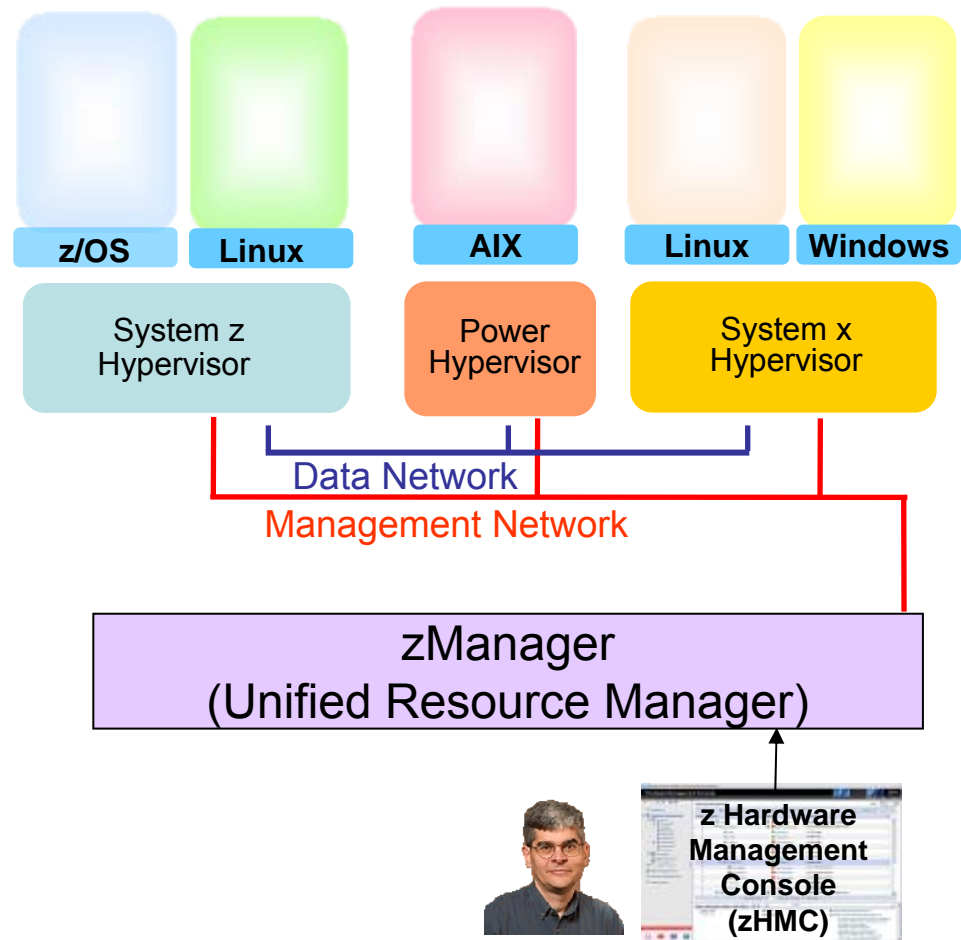

zManager Minimizes Time And Labor For Hypervisor And Network Setup

- Read the entitlements for blades
- Auto-discover and inventory for all elements
 - ▶ No need to install and configure libraries or sensors
- Automatic setup and configuration of the hypervisor
- Two internal networks all physically setup out-of-the-box in zBX
 - ▶ Pre-configured private and physically isolated internal management network
 - ▶ Private and secure data network

Manage zBX Blade Entitlement - P00ETM02

Set up your zBX Blade Entitlements using the table below.

zBX Blades

Select	Location	MTMS	New Entitlement	Current Entitlement	Valid Entitlements
<input type="checkbox"/>	B01BBS04	7870-PEL/YK105000B504	Not entitled	Not entitled	ISAO
<input type="checkbox"/>	B01BBS03	7870-PEL/YK105000B503	Not entitled	Not entitled	ISAO
<input type="checkbox"/>	B01BBS02	7778-23X/YK105003B502	Not entitled	Not entitled	PASB
<input type="checkbox"/>	B01BBS01	7778-23X/YK105003B501	Not entitled	Not entitled	PASB
<input type="checkbox"/>	B10BBS04	7778-23X/YK105003B504	PASB	Not entitled	PASB
<input type="checkbox"/>	B10BBS03	7778-23X/YK105003B503	Not entitled	Not entitled	PASB
<input type="checkbox"/>	B10BBS02	7872-ACI/YK105002B502	Not entitled	Not entitled	XASB
<input type="checkbox"/>	B10BBS01	7872-ACI/YK105002B501	Not entitled	Not entitled	XASB
<input type="checkbox"/>	C01BBS04	7778-23X/YK105003B504	Not entitled	Not entitled	PASB
<input type="checkbox"/>	C01BBS03	7778-23X/YK105003B503	Not entitled	Not entitled	PASB
<input type="checkbox"/>	C01BBS02	7778-23X/YK105003B502	Not entitled	Not entitled	PASB

Total: 16 Filtered: 16 Selected: 0

zBX Blade entitlement counts

Entitlement Type	Current	Maximum	Spares
ISAO	0	10	6
WDPX150B	0	10	0
PASB	0	10	8
XASB	0	10	2

OK Cancel Help

Command Window - P00ETM02 - 11/23/2010

Hypervisor Setup And Configuration Lab Test – Do-It-Yourself vs. zManager

DIY Tasks (per Blade)	Elapsed Time	Labor Time
Initial communication setup & education	6 min 26 sec	6 min 26 sec
Boot VIOS disc & install (creates LPAR for VIOS automatically)	37 min 59 sec	36 min
Configure VIOS networking	2 min 49 sec	2 min 49 sec
Create new storage pool for LPARs	35 sec	35 sec
Install VIOS service fixpacks	61 min 5 sec	20 sec
TOTAL TIME	1 hr 48 min 52 sec	46 min 10 sec

zManager Tasks (per Blade)	Elapsed Time	Labor Time
Add entitlement for a blade	90 min	92 sec
TOTAL TIME	1 hr 30 min	1 min 32 sec

97% reduction
in labor time

Network Setup And Configuration Lab Test – Do-It-Yourself vs. zManager

Do-It-Yourself Tasks (for two BladeCenters)	Elapsed/Labor Time
Planning (includes time to go over docs, etc)	5 hrs
Cabling	2 hrs
AMM Configuration	2 hrs
Logical Configuration (L2)	8 hrs
Blades network configuration	4 hrs
Testing	2 hrs
Documenting the configuration	3 hrs
TOTAL TIME	26 hrs

zManager Tasks (for two BladeCenters)	Elapsed/Labor Time
Planning	3 hrs
Cabling (pre-cabled in zBX)	0 hrs
AMM Configuration (done in zBX)	0 hrs
Logical configuration (L2)	30 mins
Blades network configuration	1 hr 30 mins
Testing (pre-tested)	0 hrs
Documenting the configuration (all part of zManager)	0 hrs
TOTAL TIME	5 hrs

81% reduction
in labor time

Automated Hypervisor Setup And Pre-configured Network Enable Fast Platform Scale Up

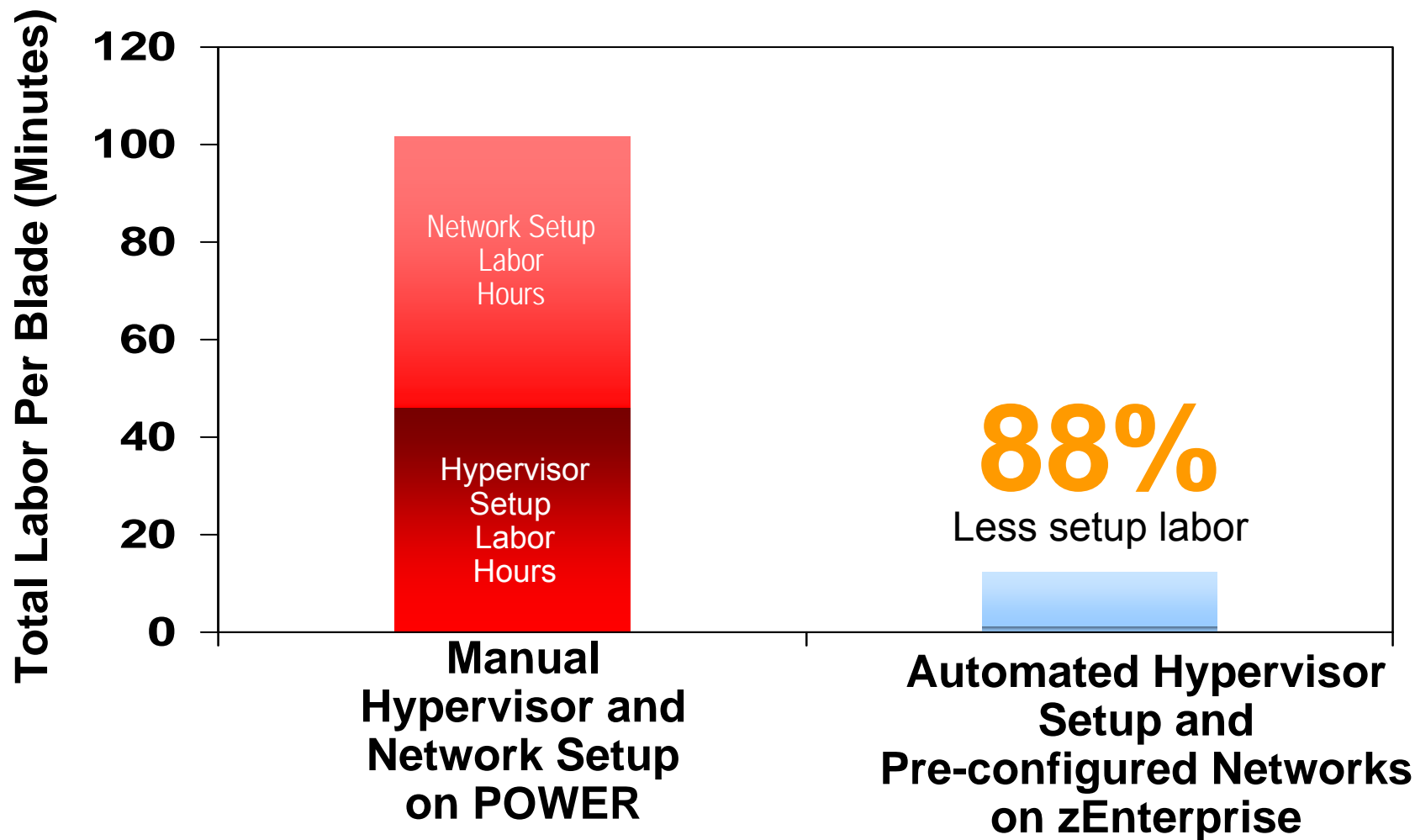

Manage Virtual Servers With zManager

- From one console, create virtual machines in z/VM and in zBX hypervisors
- Start / stop / delete virtual machines under zManager control
- Create virtual networks
- Monitor resource usage
 - ▶ CPU, Memory, Power consumption

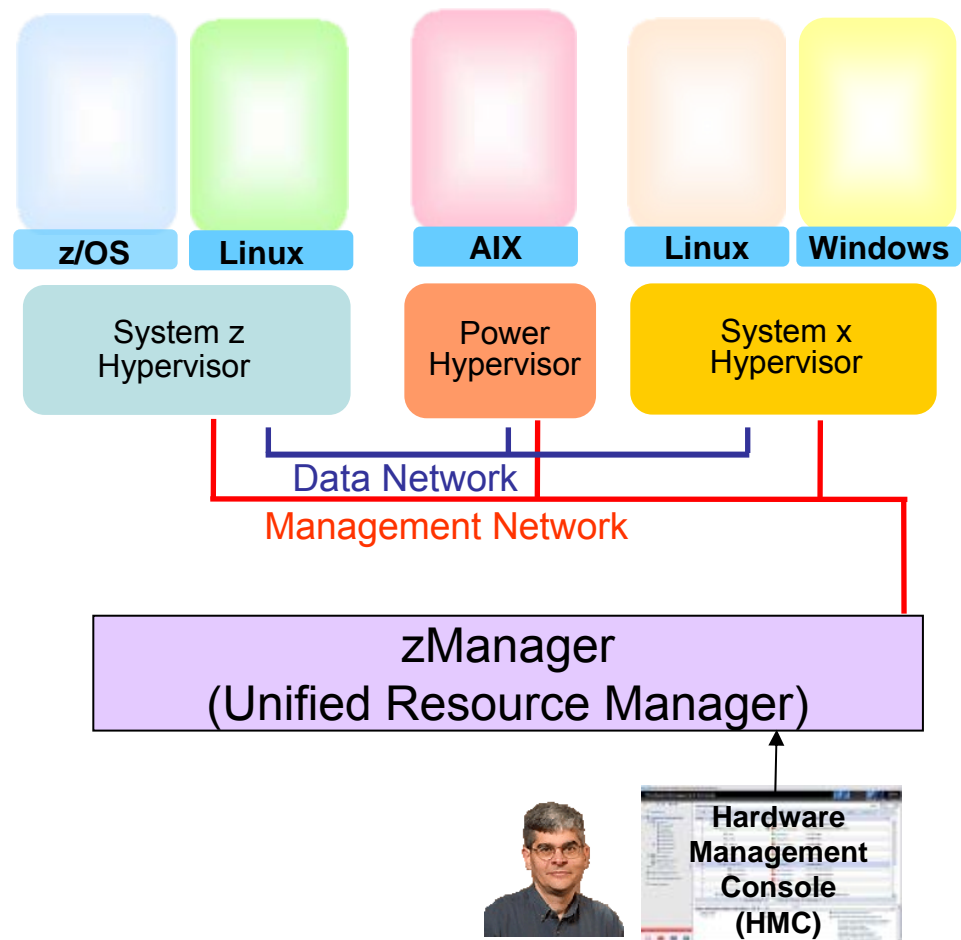

DEMO: Create Virtual Server With zManager

Create virtual server on a Power blade

- ▶ Enter name for virtual server
- ▶ Assign number of virtual processors
- ▶ Specify memory
- ▶ Add network device
- ▶ Add storage device
- ▶ Specify boot option
- ▶ Select workload

The screenshot shows a web browser window with the URL `https://9.12.16.205/hmc/content?taskId=281&refresh=726`. The page title is "New Virtual Server - B.1.07". The main content area is titled "Enter Name" and contains the following fields:

- Hypervisor name: B.1.07
- Hypervisor type: POWER Blade
- Name:
- Description:

At the bottom of the form, there are five buttons: "< Back", "Next >", "Finish", "Cancel", and "Help". The "Next >" button is highlighted in blue. The browser's status bar at the bottom shows "Done".

zEnterprise Cloud Starter Edition

Adds package of software and services for automated provisioning and monitoring

- IBM Tivoli software (runs on Linux on System z)
 - ▶ Automated provisioning
 - Tivoli Provisioning Manager (TPM)
 - ▶ Monitoring
 - Tivoli OMEGAMON XE on z/VM and Linux
- IBM Lab Services
 - ▶ Planning, installation, configuring, testing services

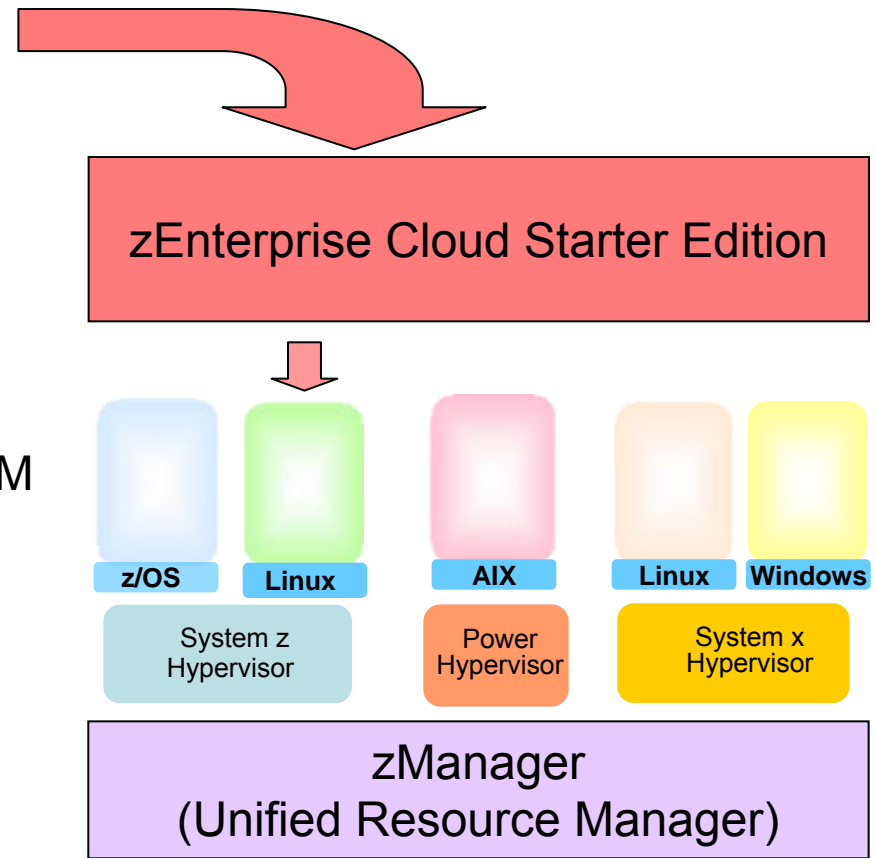

Automated Provisioning With Tivoli Provisioning Manager (TPM)

- Automates provisioning of virtual servers via cloning from images or installing and configuring software
- Tasks automated through automation workflows
 - ▶ Pre-built workflows describe provisioning steps
 - ▶ Automatic workflow execution with verification at each step
 - ▶ Automation Package Developer allows customization for data center best practices and procedures
- Virtual image repository allows customers to centralize and standardize on provisioning materials
 - ▶ Images, application packages, configuration properties

IBM System z Solution Edition For Cloud Computing

Adds package of software and services for self-service provisioning, metering, billing and monitoring

- IBM Tivoli software (runs on Linux on System z)
 - ▶ Self-service provisioning
 - Tivoli Service Automation Manager (TSAM)
 - TSAM integrates with IBM Workload Deployer appliance to automate provisioning of WebSphere environment
 - ▶ Metering and billing
 - Tivoli Usage and Accounting Manager (TUAM)
 - ▶ Monitoring
 - Tivoli OMEGAMON XE on z/VM and Linux
- IBM Lab Services
 - ▶ Planning, installation, configuring, testing services
 - ▶ Significant package discounts

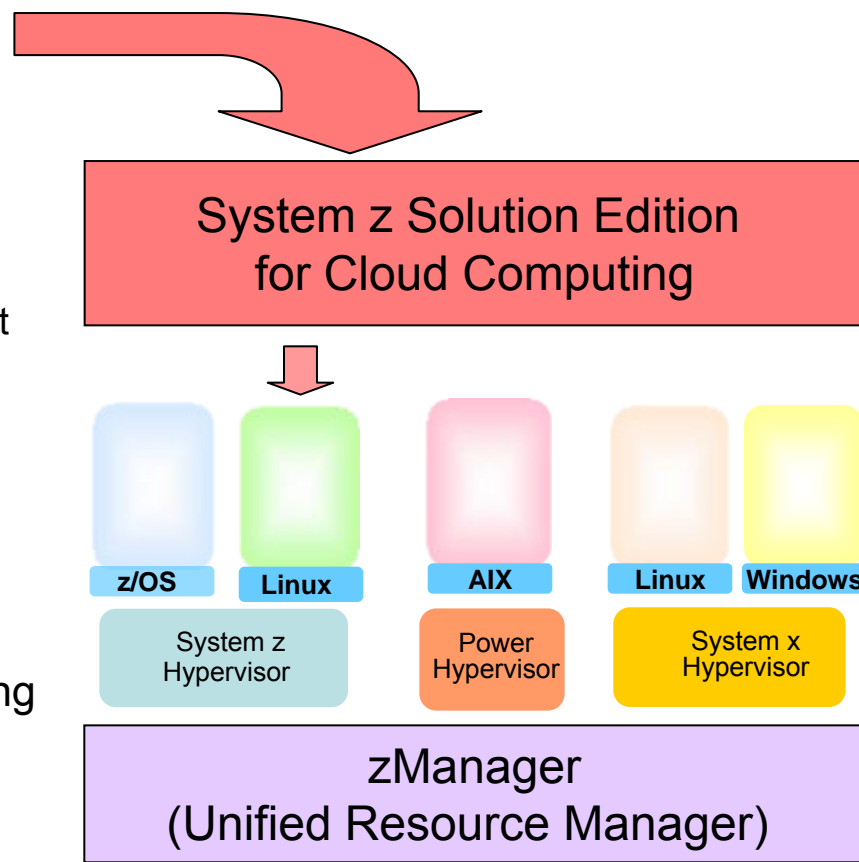

Self-Service Provisioning With Tivoli Service Automation Manager (TSAM)



User browses service catalog

Adds service to shopping cart

Submits request

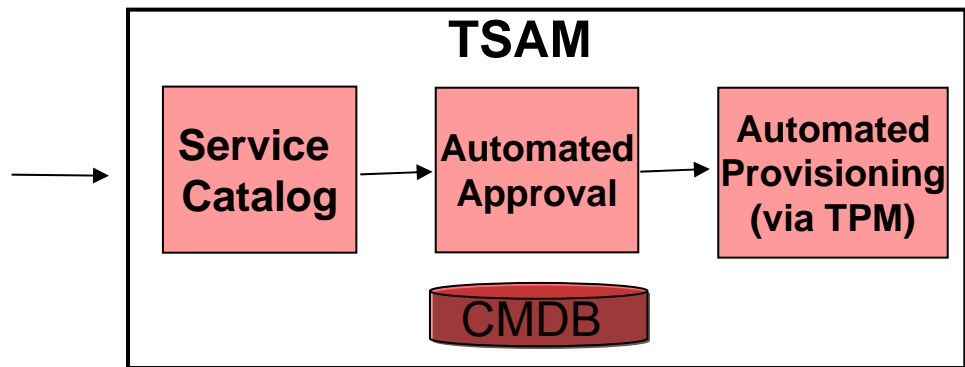

TSAM starts the deployment process via **IBM Tivoli Provisioning Manager (TPM)** workflow

- Self-service portal for users
- Enables standardization via a catalog of service offerings
- Automates request processing with pre-defined workflows
- Fast provisioning of virtual servers

DEMO: Self-Service Provisioning With IBM Tivoli Service Automation Manager (TSAM)

- Submit a request to add a new virtual machine (VM) under z/VM to an existing project
- VM created with a complete software stack (zLinux, WebSphere, customer application and Tivoli Monitoring agent) installed
- Requester is notified via email when the request is completed

Create Project with z/VM Linux Servers

Provision one or more z/VM Linux virtual servers containing a software image.

General

*Project Name: [Text Field] *Team to Grant Access: [Dropdown]

Project Description: [Text Field]

*Start Date: 4/15/2010 *End Date: Until this date [Dropdown] 4/29/2010

Requested Image

Resource Group Used to Reserve Resources: System z pool Monitoring Agent to be Installed

*Image to be Deployed: [Dropdown]

Select	Name	Hypervisor	CPUs	Memory	Storage
<input checked="" type="radio"/>	SLES 10 with WAS 6	zVM	1	2 GB	7 GB
<input type="radio"/>	RHEL 5 with DB2 9	zVM	1	1 GB	1 GB
<input type="radio"/>	SLES 10 with DB2 9	zVM	1	1 GB	1 GB
<input type="radio"/>	RHEL 5 with WAS 7	zVM	1	1 GB	1 GB
<input type="radio"/>	SLES 10 with WAS 7 and D	zVM	1	1 GB	1 GB

Resources

To adjust the settings of the requested resources, press the setting button. After making the necessary adjustment, press the setting button to save the configuration.

Servers

*Number of Servers to be Provisioned: 1
7 available at above configuration and schedule

CPU

Virtual 1
Physical 1.0

Memory

Main 2.000 GB
Swap 0.000 GB

Disk

Local 7 GB

OK Cancel

Self-Service Provisioning For zEnterprise

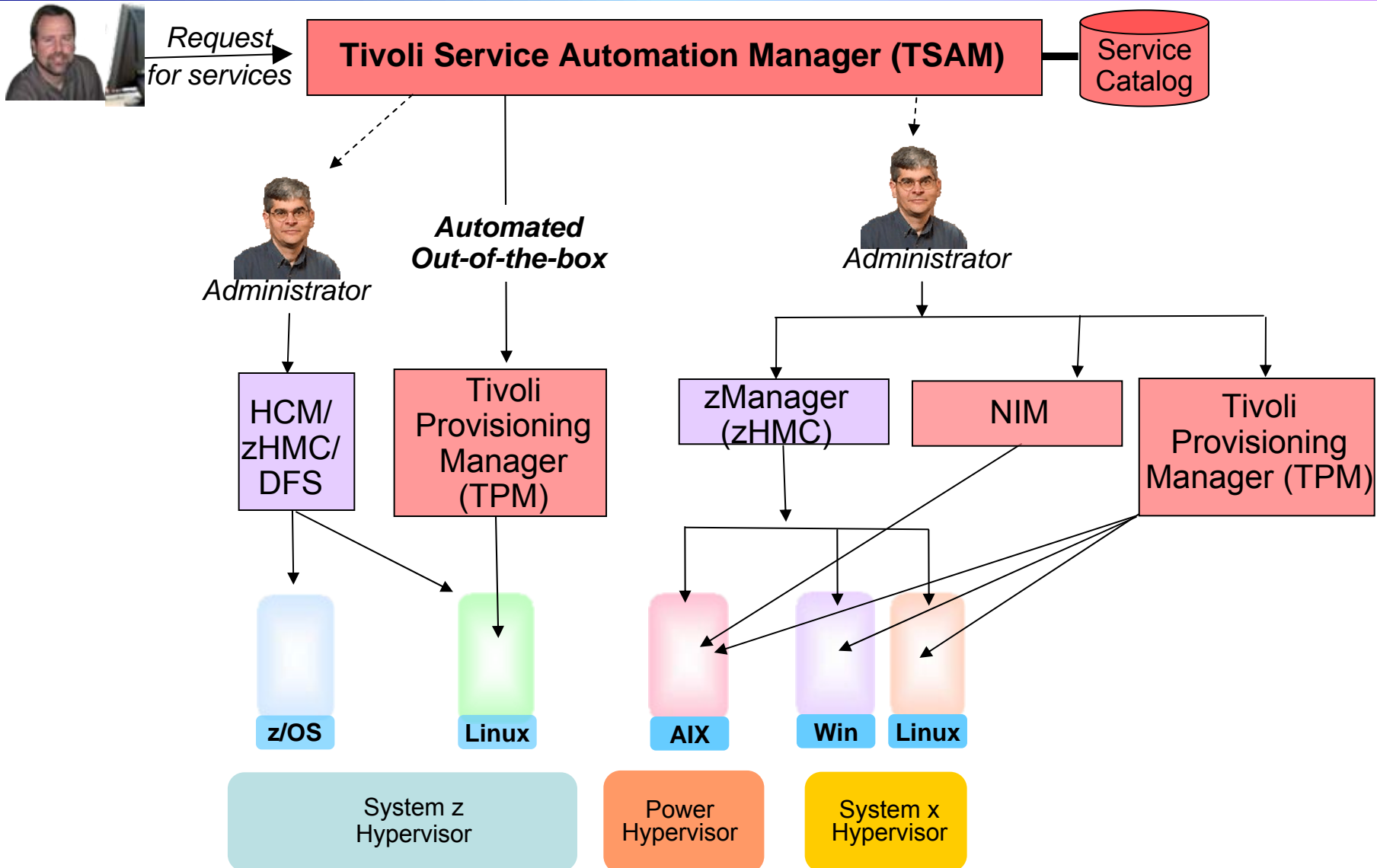

TSAM Automated Provisioning Is Fast

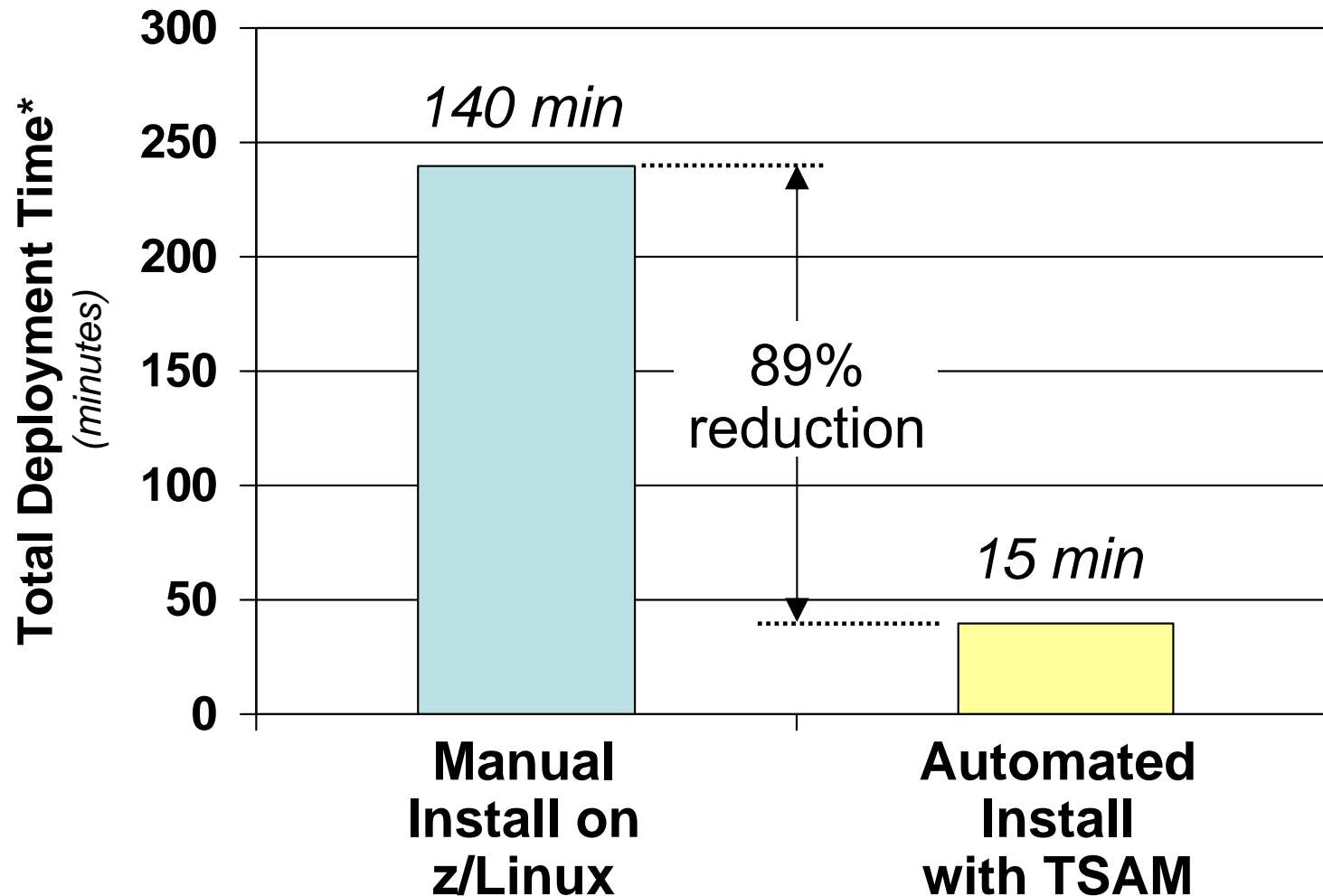

* Excluding network transmission time

Tivoli Service Automation Manager Integrates With IBM Workload Deployer



Request
for services

Tivoli Service Automation Manager (TSAM)

General purpose
provisioning

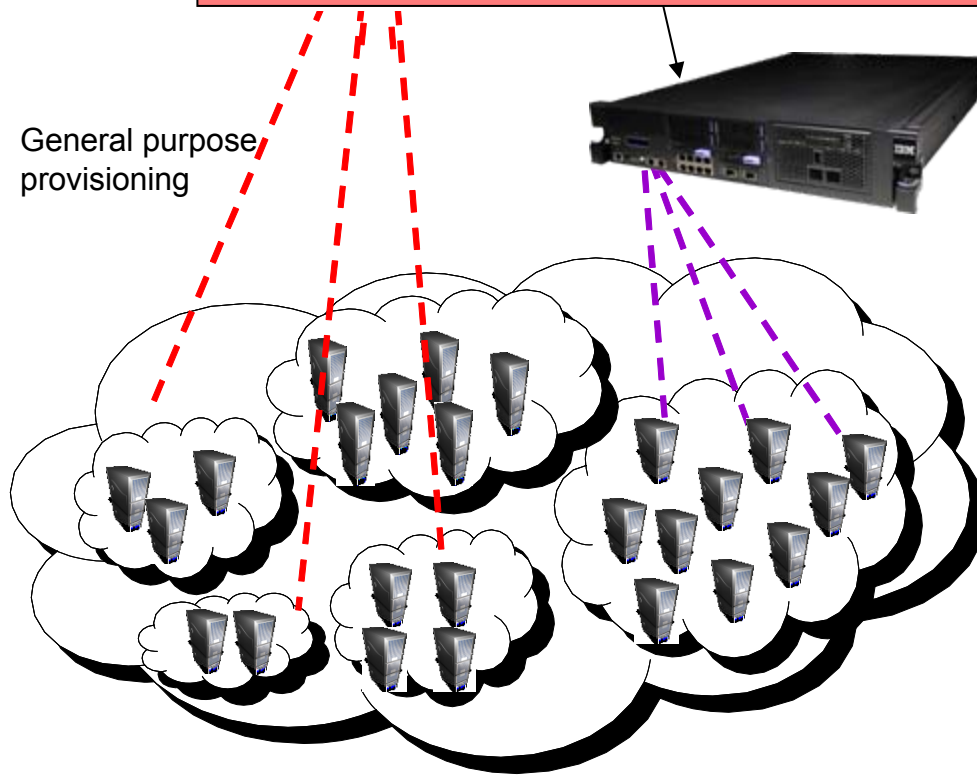

IBM Workload Deployer*

- Appliance pre-loaded with standardized WebSphere Application Server Hypervisor Edition and patterns
- Self-service automated provisioning of WebSphere environment onto z/VM on z196

*Can be used for deploying under z/VM on z196

Example Of How It Works - Use Standardized Image For Automated Deployment

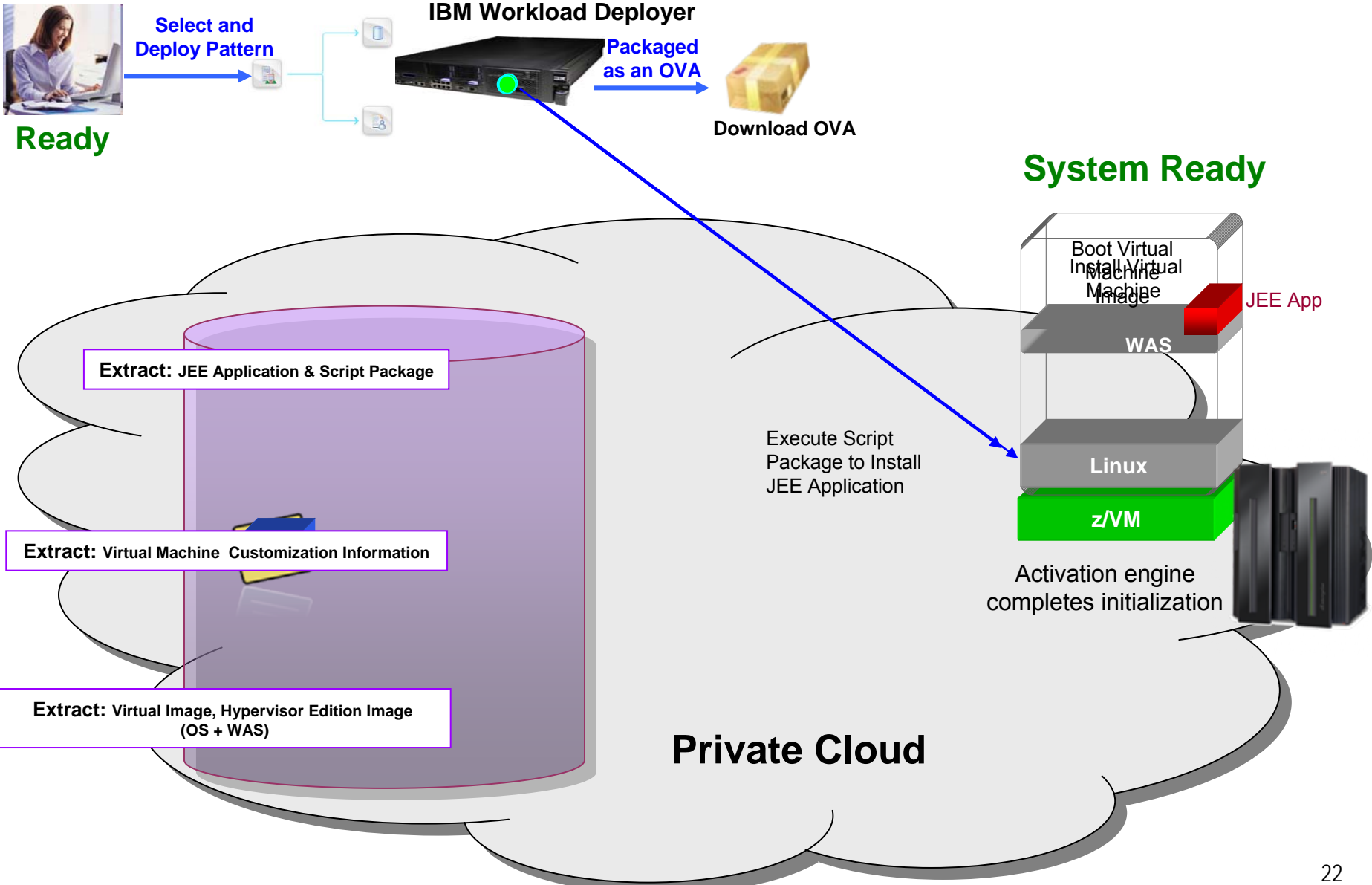

IBM Workload Deployer Deploys Preloaded Virtual System Patterns

A Virtual System Pattern is one or more virtual images and script packages to satisfy a certain deployment topology

Single Server

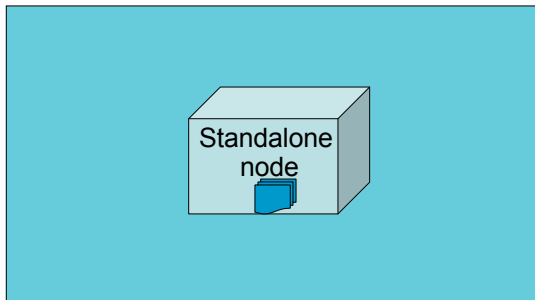

WebSphere cluster

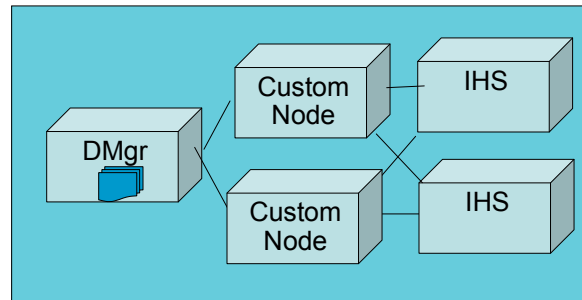

WebSphere Advanced Cluster

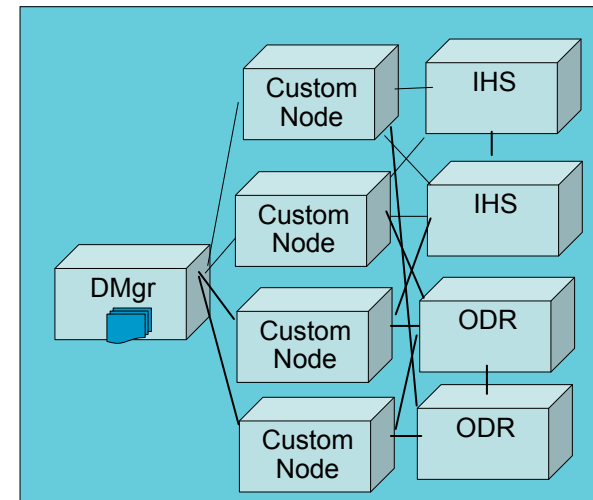

WebSphere cluster (dev)

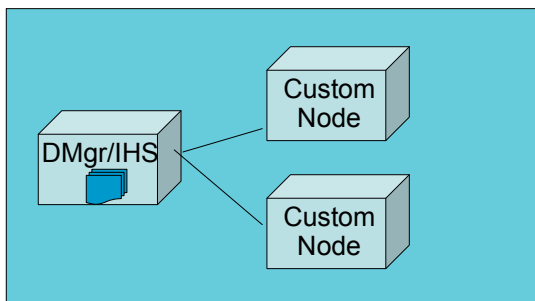

WebSphere Process Server (Scalable)

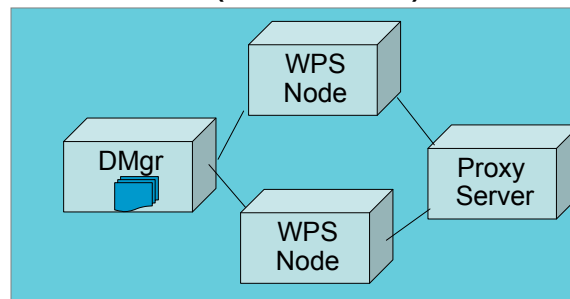

Advanced Options for messaging, session persistence, and global security available

DMgr = Deployment Manager

IHS = IBM http Server

Manual Deployment Steps For WAS Clustered Environment

1. Create 3 virtual servers and install software
 - ▶ 1 WebSphere deployment manager/IBM HTTP Server
 - ▶ 2 WebSphere Nodes
2. Use the WAS Update Installer to install the required iFixs
3. Configure the HTTP Server
4. Create WebSphere Cluster with 2 members
5. Configure Session replication on servers to support Failover
6. Deploy the Application to the WebSphere Cluster

WebSphere cluster

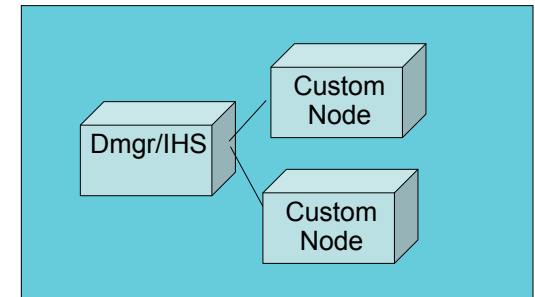

All of these steps are done automatically with IBM Workload Deployer

Console Steps To Deploy WAS Cluster Pattern

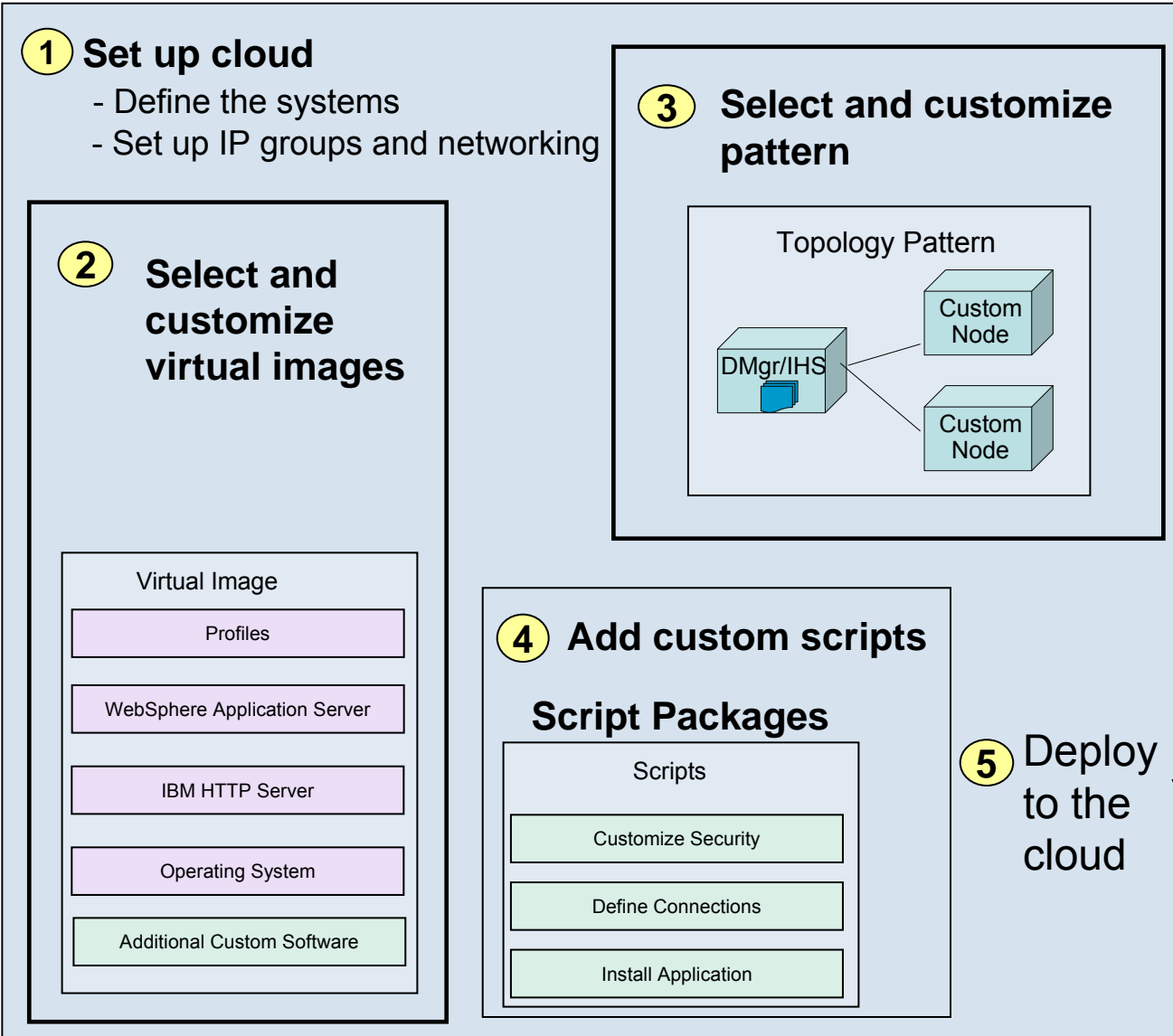

- Focus on the topology – client selects the topology pattern
- Application and configuration scripts are added to the pattern

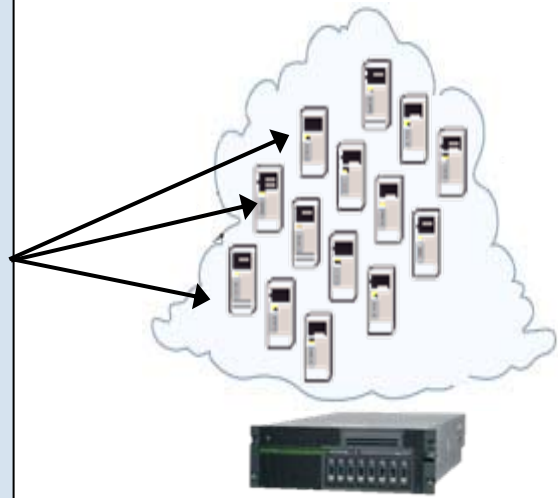

Pay-As-You-Go Chargeback With Tivoli Usage And Accounting Manager (TUAM)

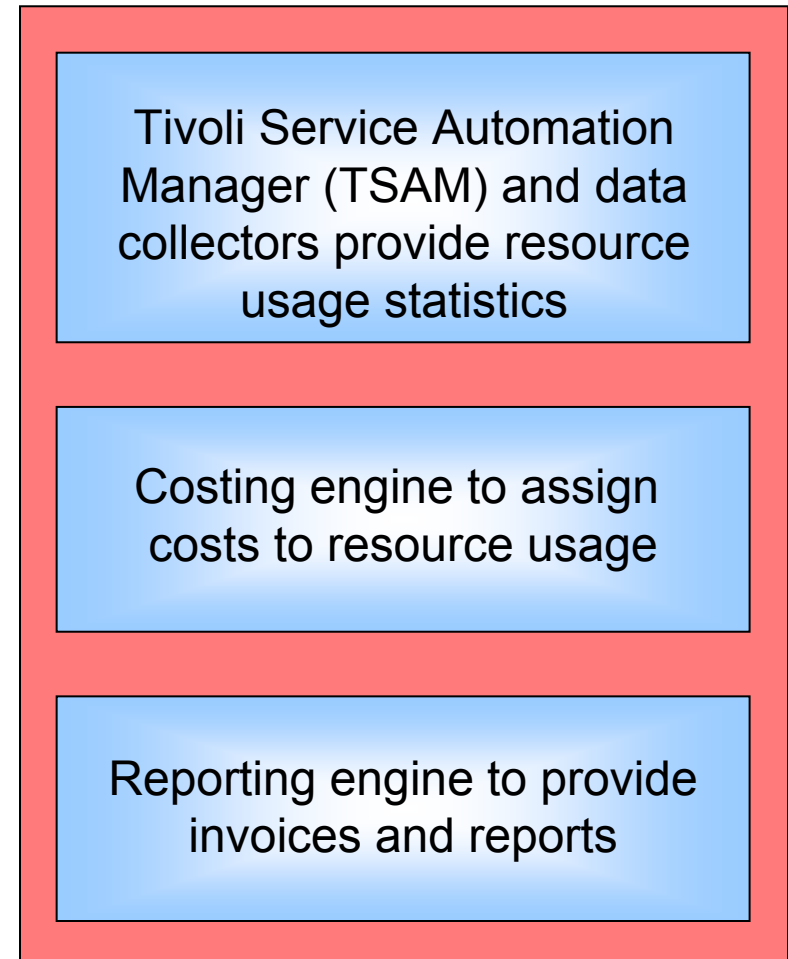
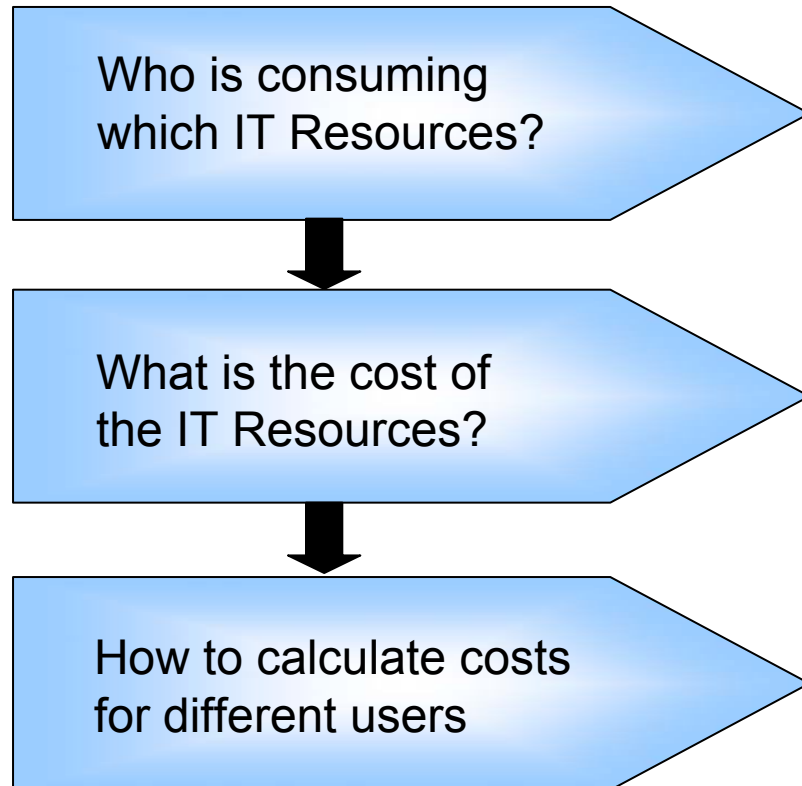

Provided by Tivoli Usage and Accounting Manager*

Public vs. Private Cloud: Which Option Costs Less For Delivering Mixed Workloads?

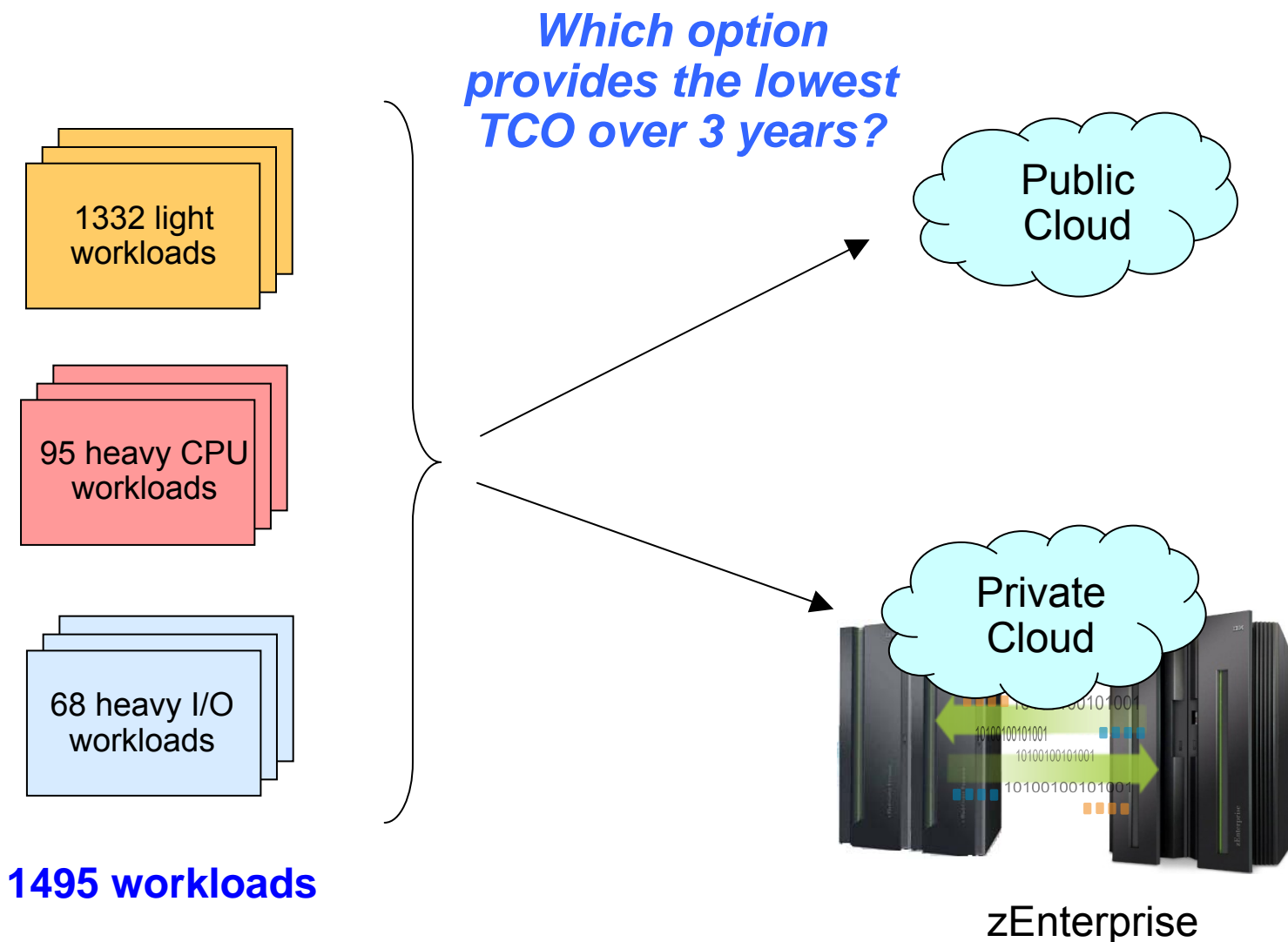

A High-Level View of the Labor Model – Best Fit to Field Data

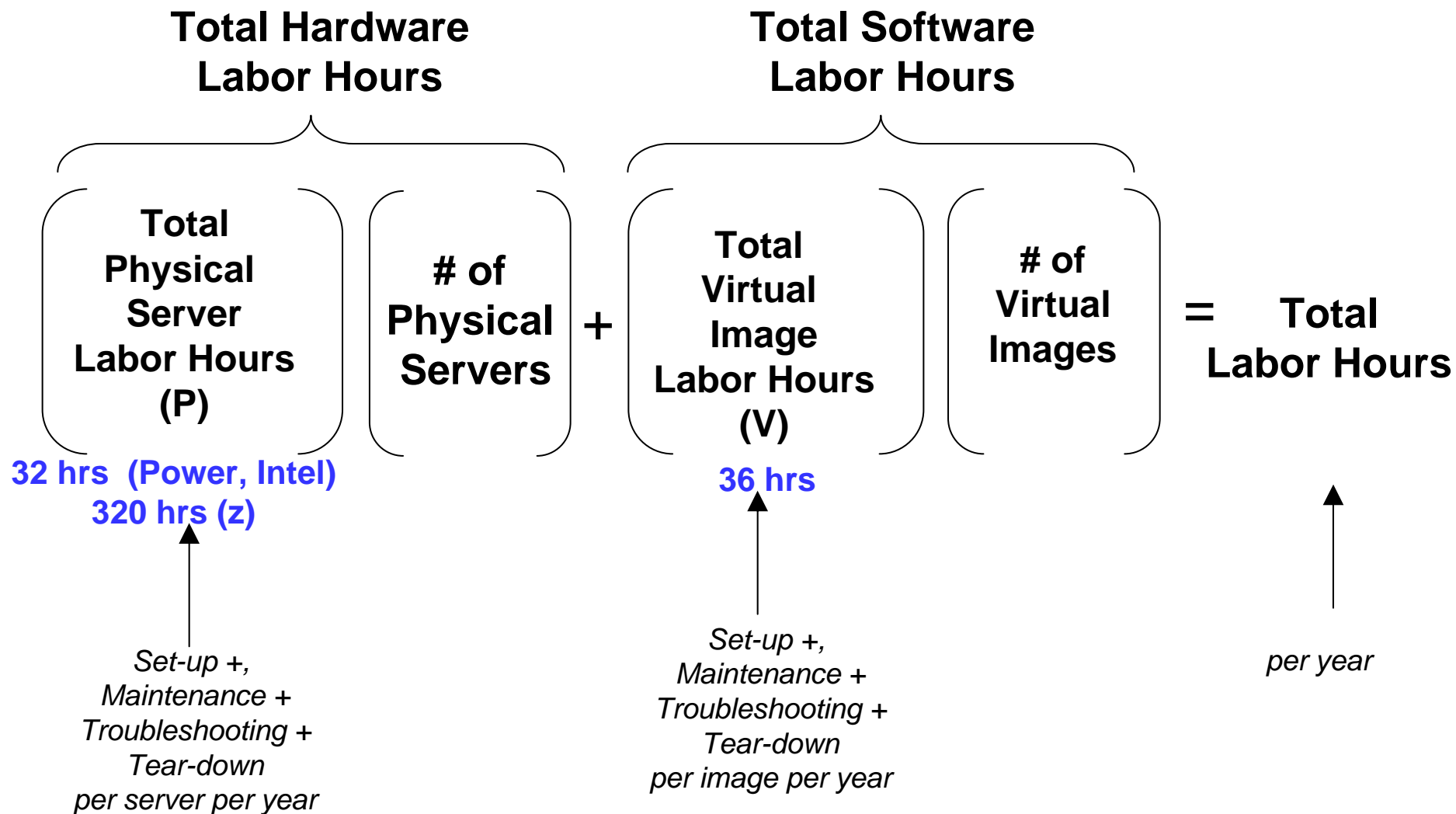

Values best fit to collected field data

Variability In Image Usage Allows For Reduction In The Number Of Servers Required

- Consolidation ratios based on benchmark data assume “always on” operation
- On average, not all workloads are active all the time
- Amazon EC2 public cloud recognizes this by running with an “oversold” factor of 1.7
 - ▶ Assumes each server can support 1.7 times the indicated capacity of virtual machines
- This means we don't need as many servers as the benchmarks indicate

Deploying Light Workloads

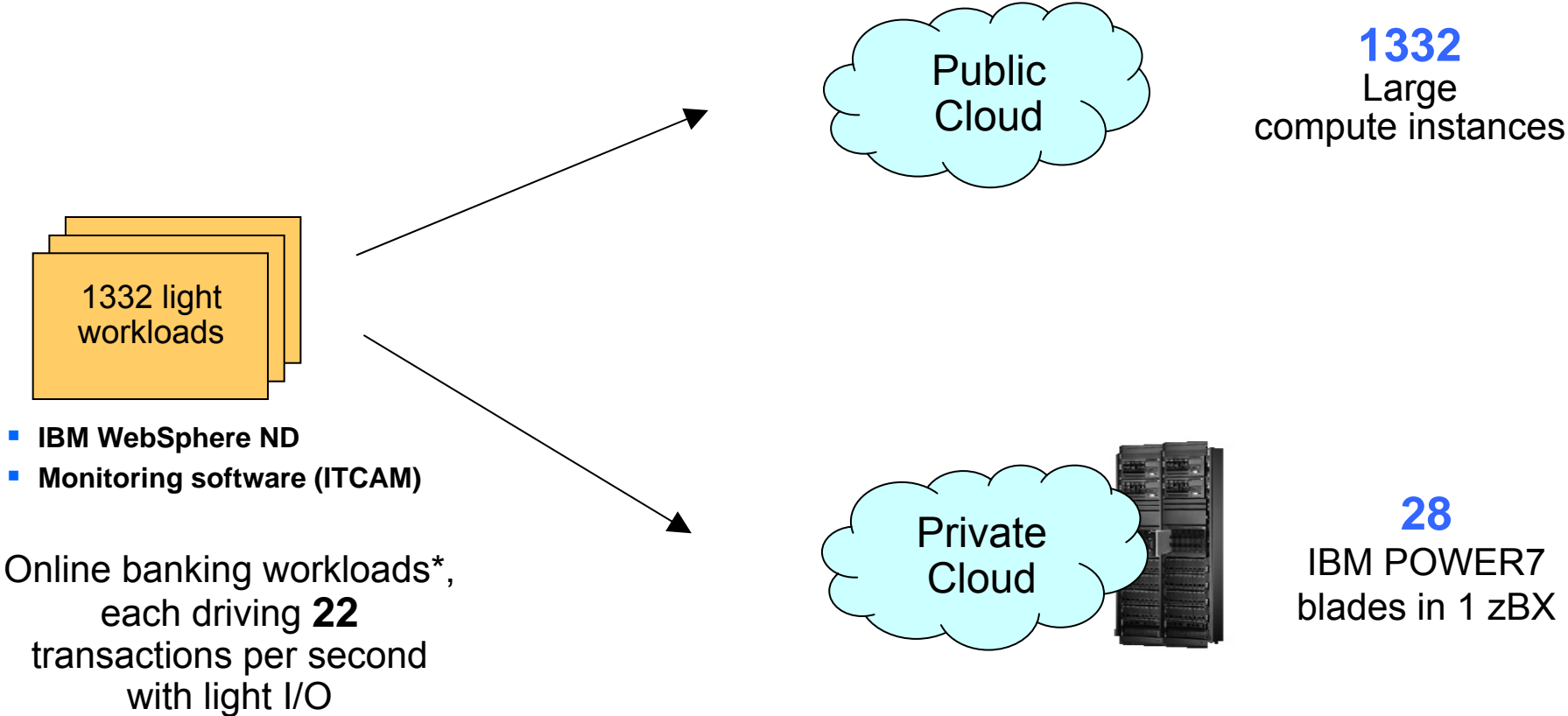

* CPO on-line banking benchmark

Deploying Heavy CPU Workloads With Light I/O

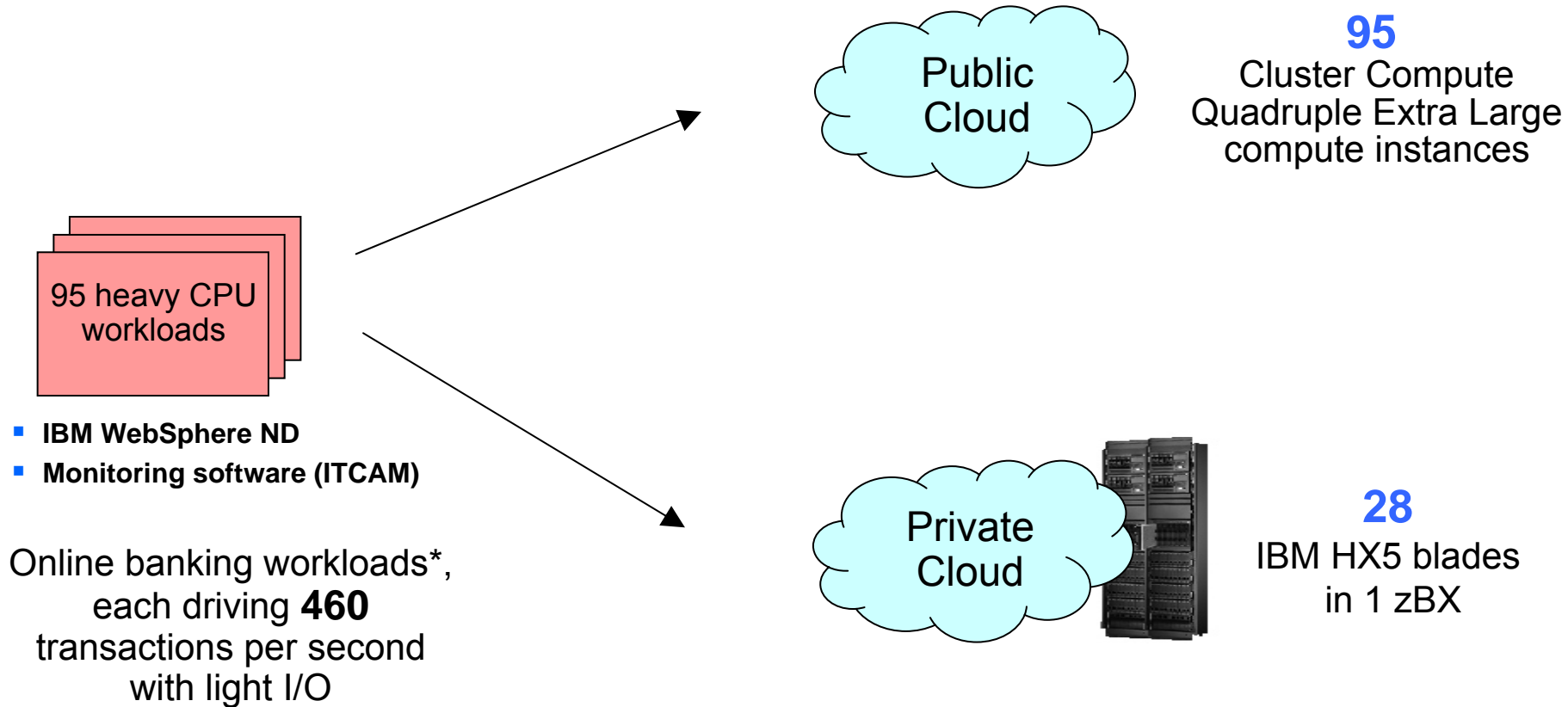

* CPO on-line banking benchmark

Deploying Light Workloads With Heavy I/O

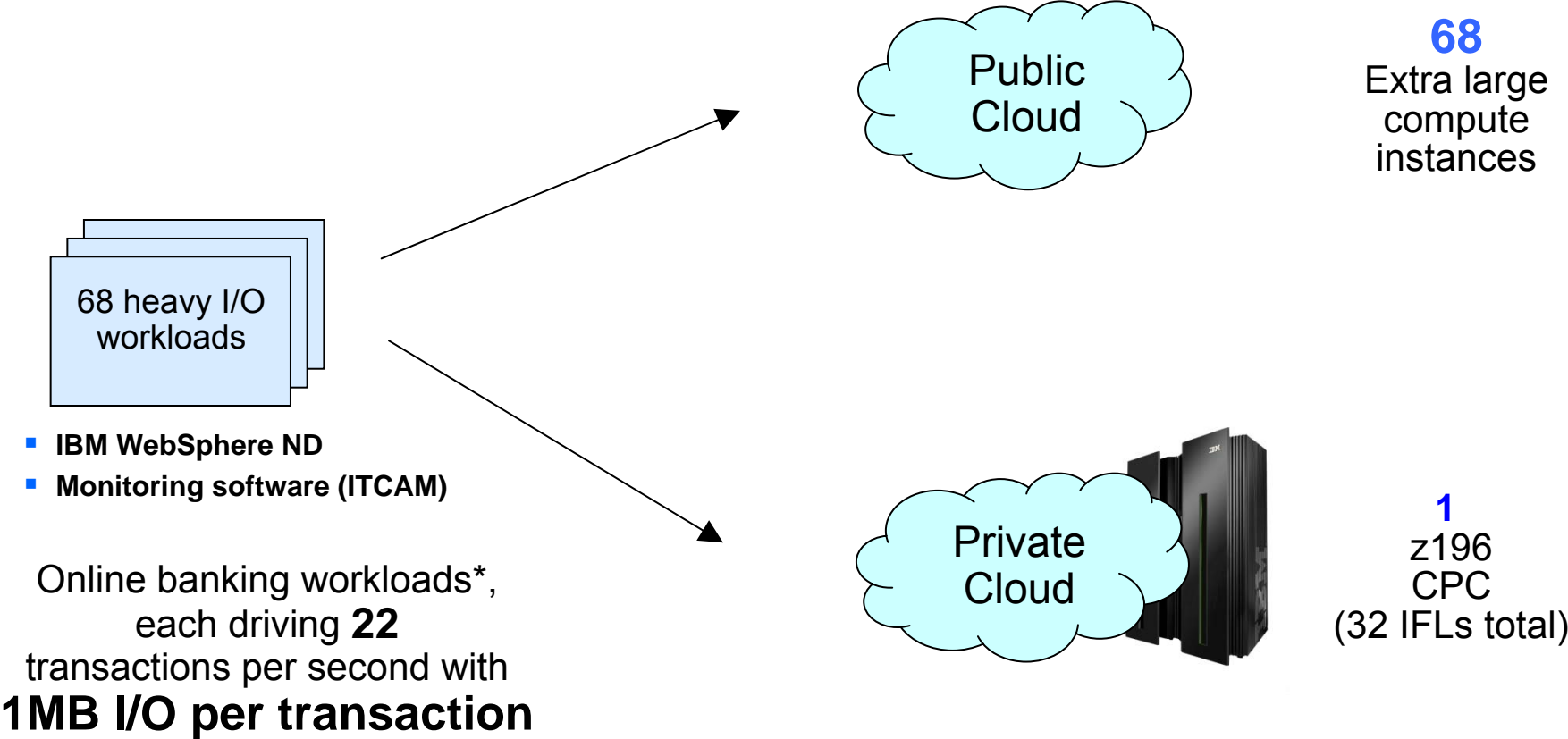

* CPO on-line banking benchmark

Compare Cost Of Acquisition For 3 Years

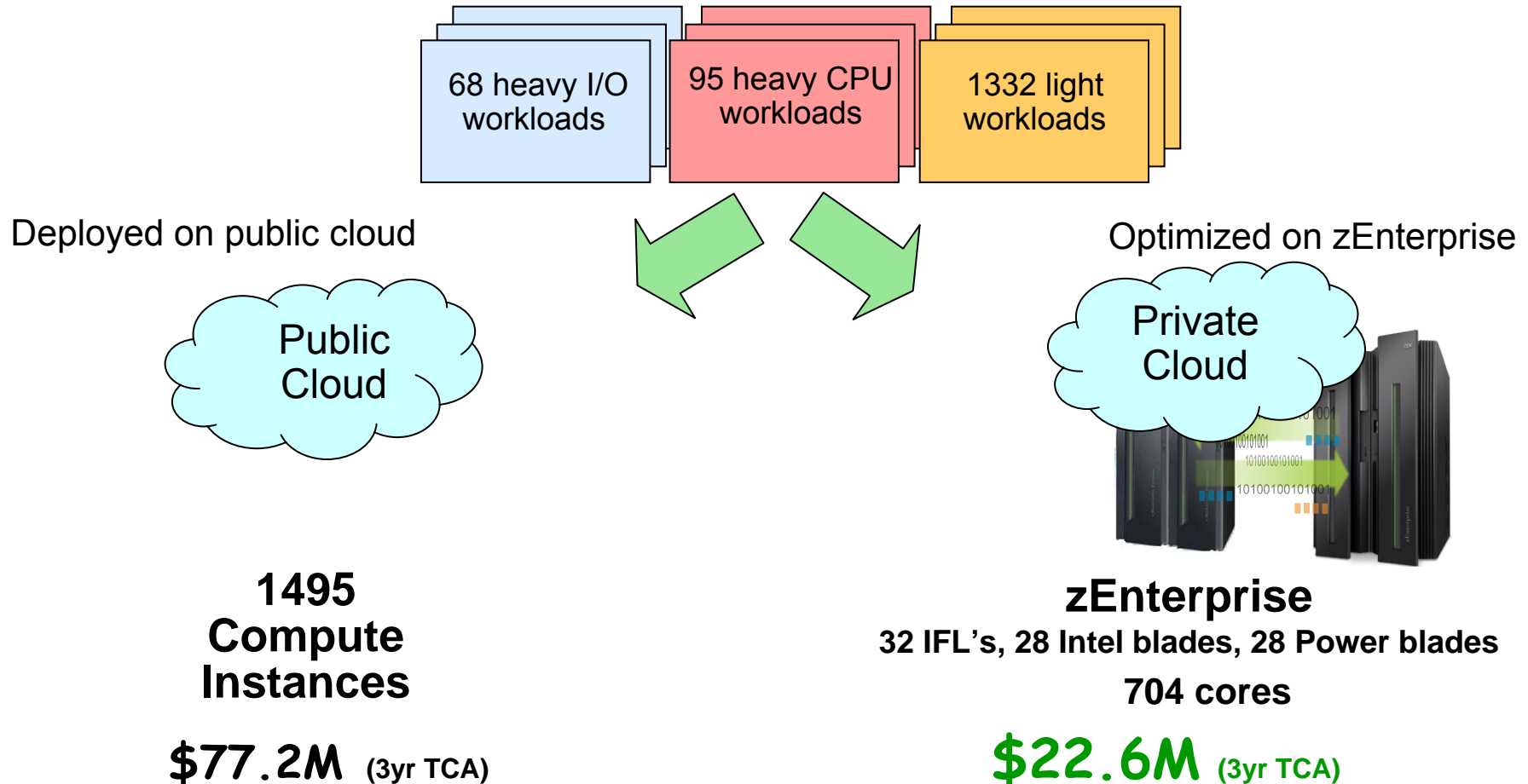

Server configurations are based on consolidation ratios derived from IBM internal studies. Prices are in US currency and will vary by country

Compare Labor Costs For 3 Years

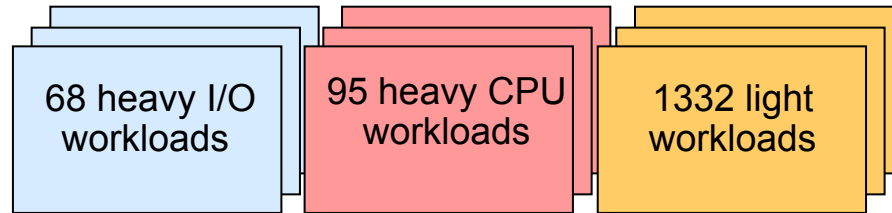

Deployed on public cloud

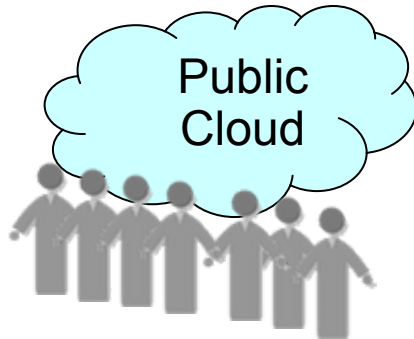

42,086 labor hours/yr
20.23 administrators

\$9.7M

3 years @ \$159,600/yr

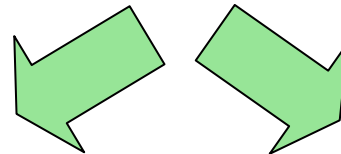

Optimized on zEnterprise



31,146 labor hours/yr
14.97 administrators

\$7.2M

3 years @ \$159,600/yr

26% less

Server configurations are based on consolidation ratios derived from IBM internal studies. Prices are in US currency and will vary by country

Private Cloud On zEnterprise Dramatically Reduces Costs

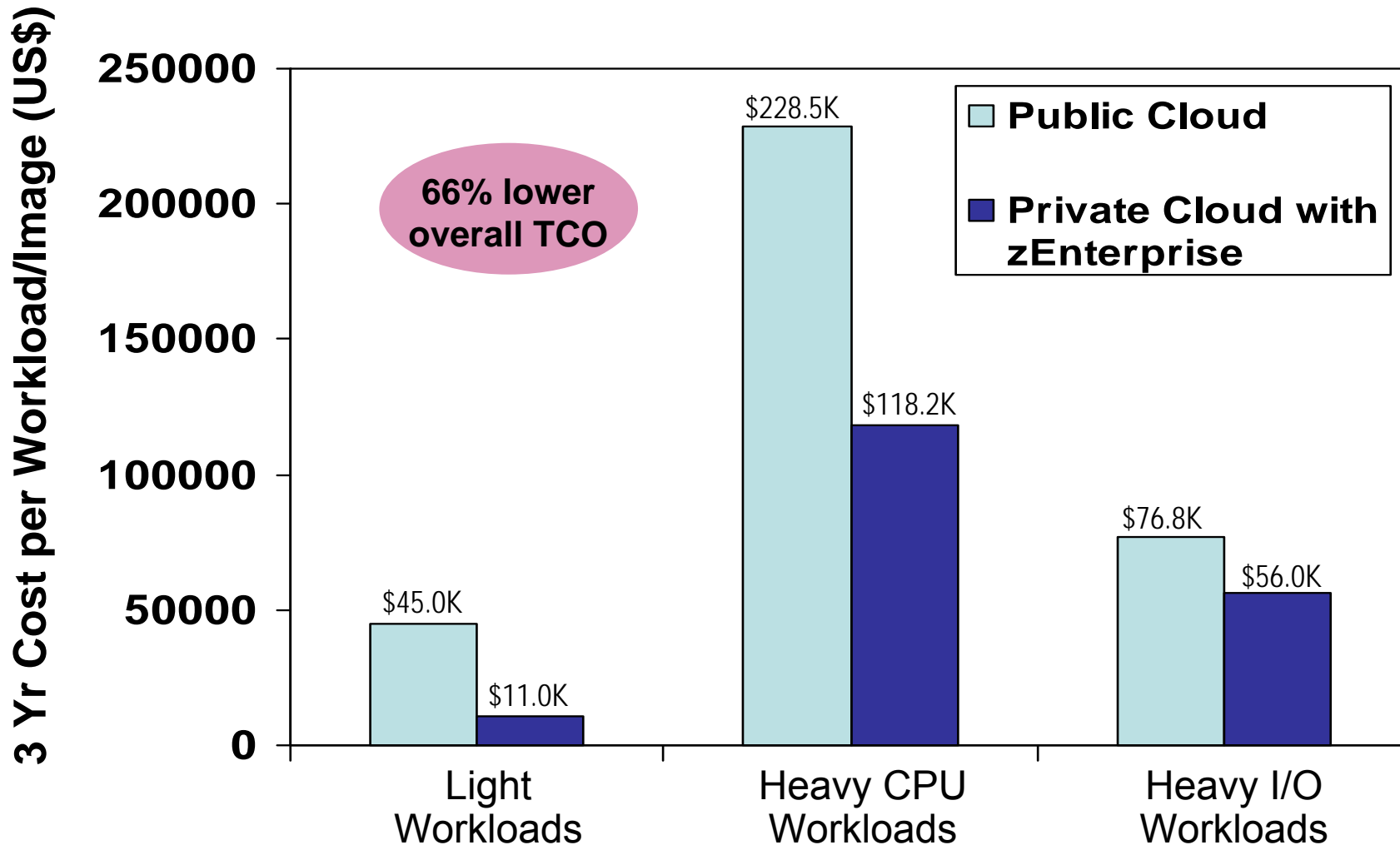

Source: IBM internal study. zEnterprise configurations needed to support the three workload types were derived from IBM benchmarks. Public cloud sizing needed to support the three workload types was calculated based on compute capacity of public cloud services. 3 yr TCO for public cloud based on pricing info available by the service provider. 3 yr TCO for zEnterprise includes hardware acquisition, maintenance, software acquisition, S&S and labor. US pricing and will vary by country.

What Users Get With zEnterprise Private Cloud

- Self-service requests
 - ▶ User request services via a web portal
- Fast provisioning
 - ▶ Automated provisioning/de-provisioning of resources as needed
- Elastic capability
 - ▶ Resource can be elastically provisioned to quickly scale out and rapidly released to quickly scale in
- Low cost pay as you go
 - ▶ Users pay for what they use
 - ▶ Business saves a lot of money