



zEnterprise – The Ideal Platform For Smarter Computing

A Closer Look At The Value Of zEnterprise

zEnterprise Value

- zEnterprise is STILL best for handling **core business workloads**
- zEnterprise is more than a mainframe – it's a **complete multi-architecture platform**
- zEnterprise continues a tradition of **unmatched reliability** and **superior qualities of service**



zEnterprise 114

*zEnterprise
BladeCenter
Extension (zBX)*



zEnterprise 196

*zEnterprise
BladeCenter
Extension (zBX)*

**IBM
zEnterprise
System**

zEnterprise Value

- zEnterprise is STILL best for handling **core business workloads**
- zEnterprise is more than a mainframe – it's a complete multi-architecture platform
- zEnterprise continues a tradition of unmatched reliability and superior qualities of service



zEnterprise 114

*zEnterprise
BladeCenter
Extension (zBX)*



zEnterprise 196

*zEnterprise
BladeCenter
Extension (zBX)*

**IBM
zEnterprise
System**

System z Is Uniquely Architected To Support Very Large Scalability Rates

- More processors, memory and cache than other enterprise servers
- I/O offloaded to dedicated processors for extreme efficiency
- Up to 32 can be clustered in a parallel sysplex
- Result:
 - ▶ Potential sysplex scale to over 1,300 BIPS
 - ▶ Near-linear
 - ▶ Optimized for heavy I/O workloads

Example of near-linear scalability:

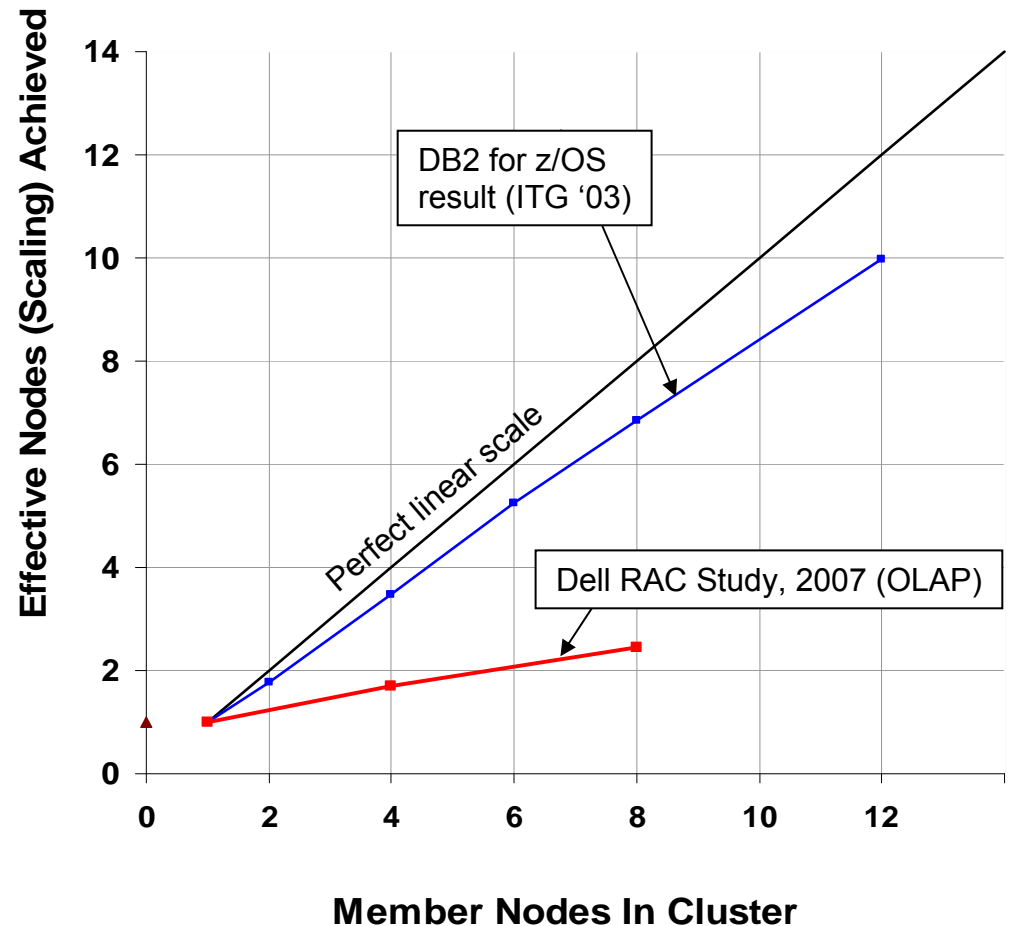

System z Is Ideal For High Transaction Workloads And Databases

■ Kookmin Bank

- ▶ IBM System z and DB2
- ▶ TCS BaNCS
- ▶ 15,353 Transactions/second
- ▶ 50 Million Accounts
- ▶ IBM benchmark for customer
- ▶ DB2 V9, CICS 3.1, z/OS V1.8

■ Bank of China¹

- ▶ IBM System z and DB2
- ▶ TCS BaNCS
- ▶ 9,445² Transactions/second
- ▶ 380 Million Accounts
- ▶ IBM benchmark for customer

System z and BaNCS Online Banking Benchmarks

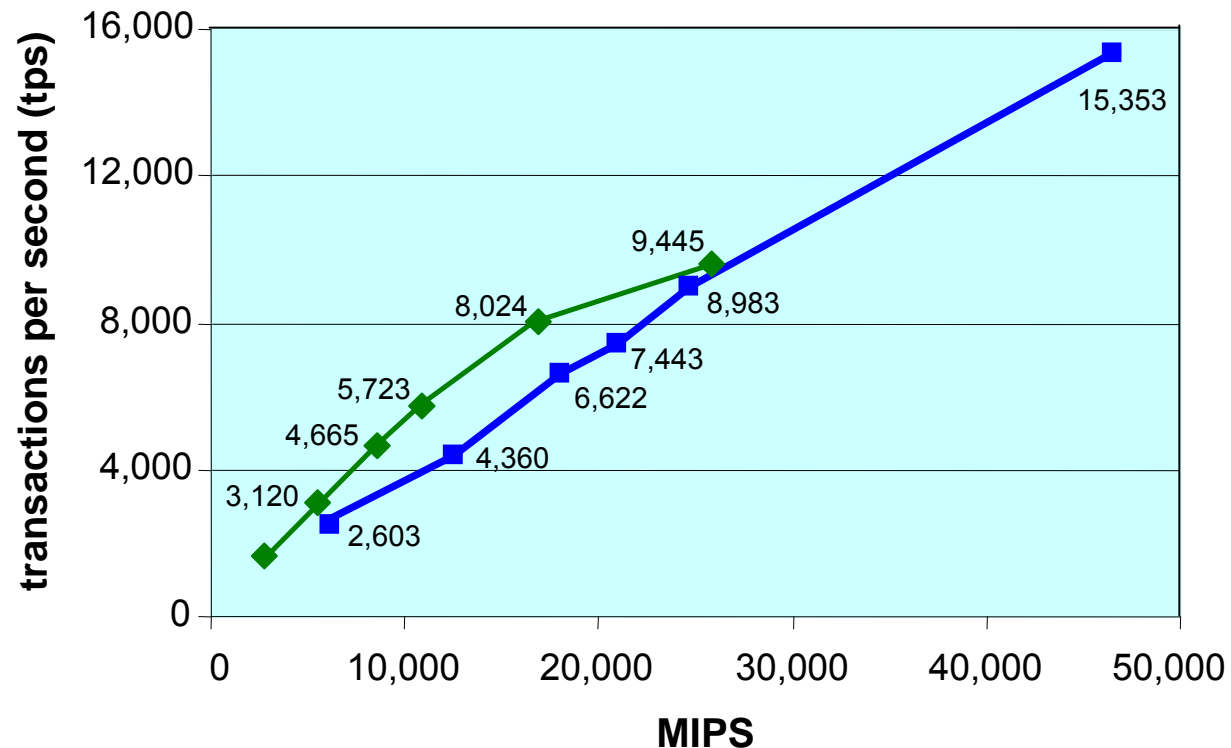

¹ Source: <http://www.enterprisenetworksandservers.com/monthly/art.php?2976> and *InfoSizing FNS BaNCS Scalability on IBM System z – Report Date: September 20, 2006*

Batch And OLTP Are Prime Workloads For System z

Incidence of workload on the Mainframe vs. allocation on the Mainframe

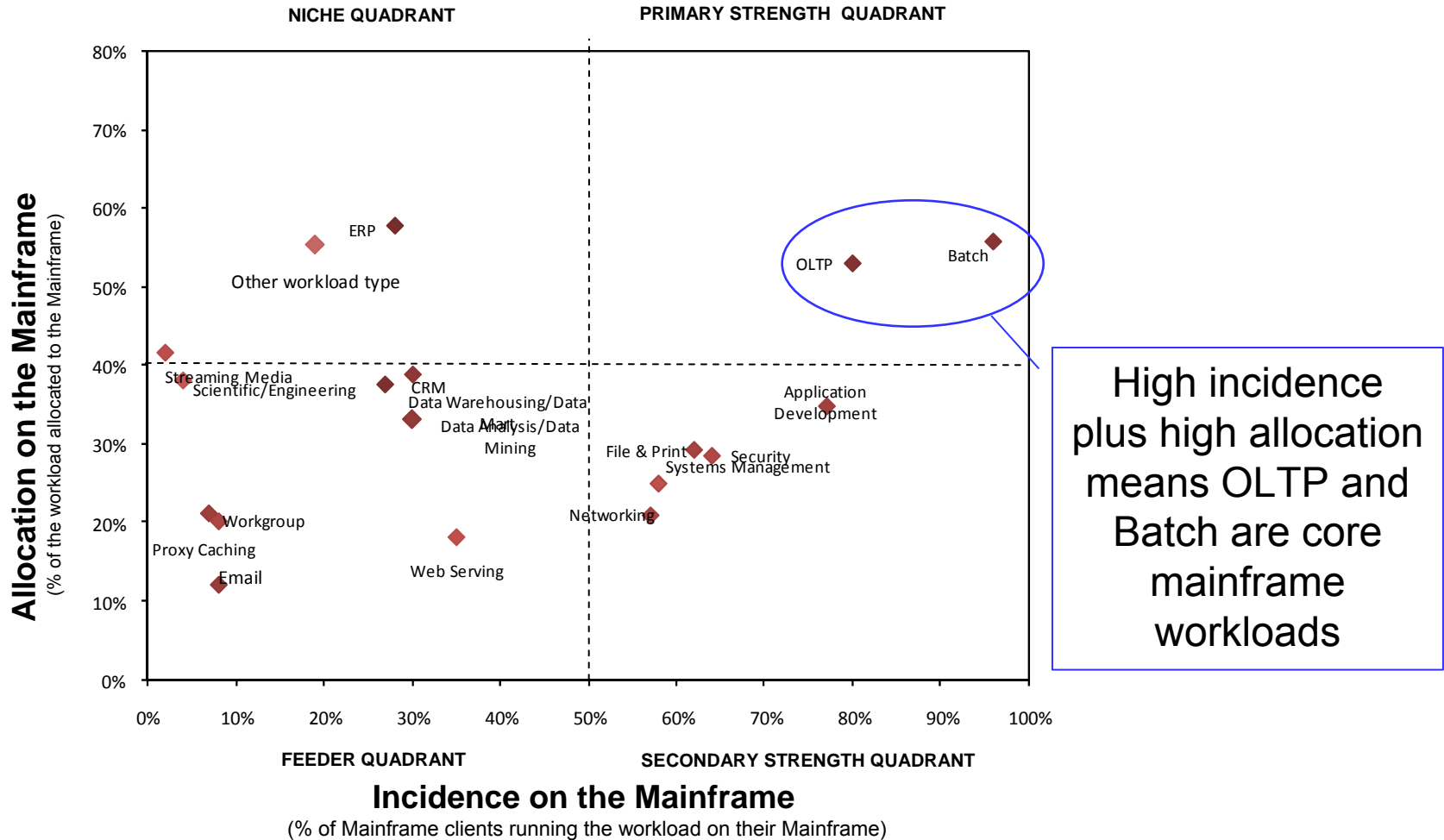

System z Is Optimized For Batch Processing And Heavy I/O Workloads

Power PS701 + DS8300

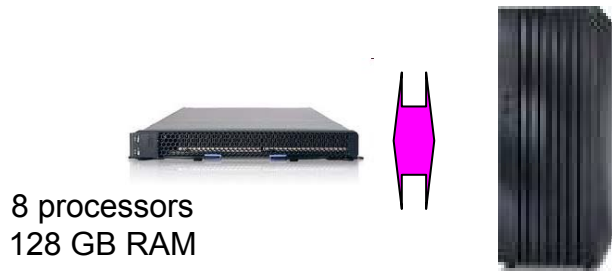

zEnterprise + DS8300



SORT Job: Sort a 3 GB transaction file – Repetitions: 300

Sorting Total Elapsed 6,900 secs
 Concurrency 20
 Bytes Per Sec **280 MB**

Sorting Total Elapsed 860 secs
 Concurrency 45
 Bytes Per Sec **2.25 GB**

MERGE Job: Merge 30 sorted files into a 90 GB master file – Repetitions: 10

Merging Total Elapsed 7,920 secs
 Concurrency 10
 Bytes Per Sec **244 MB**

Merging Total Elapsed 1,218 secs
 Concurrency 10
 Bytes Per Sec **1.58 GB**

**Batch window reduced
by 89% on zEnterprise**

System z Platform Easily Handles Workload Peaks

Example: Core banking workloads running simultaneously with high utilization

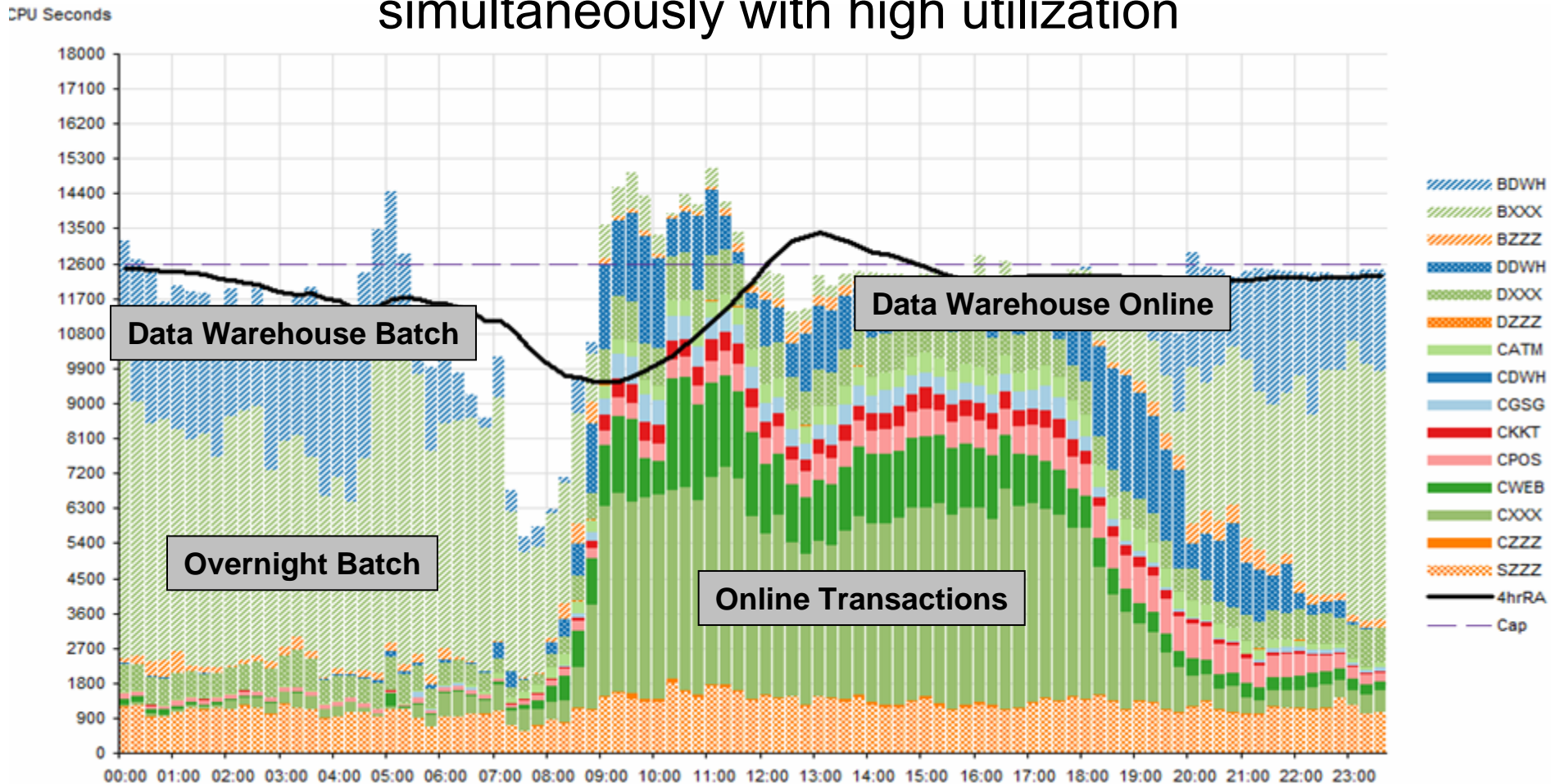

System z Capacity On Demand Provides Elasticity To Handle Unexpected Peaks

- On/Off Capacity on Demand (On/Off CoD)
 - ▶ Flexible, easy, non-disruptive temporary additional capacity
 - ▶ Self-managed
 - ▶ Total flexibility within number of books installed

- Can be automated

One z196 Book with 6 Processing Units

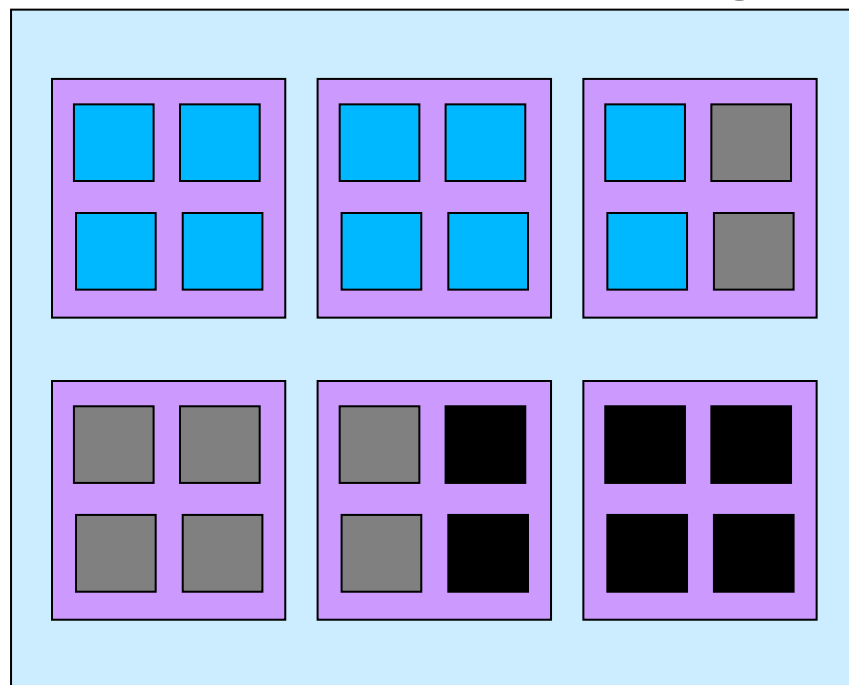

- Active processors – pay full price
- Inactive processors (On/Off CoD) – pay only 2% of full price
- Dark processors (unused) – no charge

Customer Data Shows Most Mainframe Workloads Are Already Best Fit

- IBM Eagle Team performs total cost of ownership (TCO) studies for customers
- With over 200 customers evaluated, Eagle Team has shown **System z offers better TCO** than a distributed alternative... with very few exceptions
- Contact Craig Bender (csbender@us.ibm.com)



Data Shows Mainframe-Biased Businesses Have Reduced Costs

IT cost of goods per industry:

Industry	Measure	Avg IT Cost of			%Improve
		Goods	MF Biased	Server Biased	
Airlines	Per Passenger Mile	\$ 0.007	\$ 0.0061	\$ 0.0076	-20%
Automotive	Per Vehicle	\$ 333	\$ 275	\$ 370	-26%
Chemicals	Per Patent	\$ 57,717	\$ 55,800	\$ 59,552	-6%
Consulting	Per Consultant	\$ 53,060	\$ 48,900	\$ 62,344	-22%
Hospitals	Per Bed per Day	\$ 64.30	\$ 54.4000	\$ 71.7000	-24%
Railroads	Per Ton Mile	\$ 0.0014	\$ 0.0012	\$ 0.0018	-29%
Retail	Per Store (Door)	\$ 494,818	\$ 421,346	\$ 560,300	-25%
Web Sites	Per Search	\$ 0.042	\$ 0.046	\$ 0.041	12%
Trucking	Per Road Mile	\$ 0.177	\$ 0.1550	\$ 0.1940	-20%
Armed Service	Per Person	\$ 8,036.00	\$ 6,871.00	\$ 9,839	-30%
Utilities	Per MegaWatt Hour	\$ 2.63	\$ 2.21	\$ 2.94	-25%
Oil & Gas	Per Barrel of Oil	\$ 2.10	\$ 1.78	\$ 2.32	-23%

From Rubin Worldwide analysis of Gartner Research customer data and costs

Compared to average platform costs for all industries, mainframe-biased businesses spent 14% less, and distributed-biased businesses spent 33% more

Now With zEnterprise, System z Is Better Than Ever

**zEnterprise 196
continues a tradition of
mainframe innovation**



z10 Enterprise Class



zEnterprise 196 (z196)

<i>Clock speed</i>	4.4 GHz	➤	5.2 GHz
<i>Processors per MCM</i>	5	➤	6
<i>Total processors</i>	77 (64 configurable)	➤	96 (80 configurable)
<i>Total Memory</i>	1.5 TB	➤	3TB
<i>Performance**</i>	920 MIPS	➤	1,202 MIPS
<i>Total Capacity*</i>	30,657 MIPS	➤	52,286 MIPS
<i>Power</i>	1800 W per MCM	➤	1800 W per MCM

• Based on LSPR ratings for fully configured system

** Single process performance

MCM = Multi-chip module

Introducing zEnterprise 114

zEnterprise 114 is uniquely designed for mid-range customers



z10 Business Class



zEnterprise 114 (z114)

Clock speed

3.5 GHz



3.8 GHz

Processors

10 (0 spare)



**M05: 5 (0 spare)
M10:10 (2 spare)**

Total Memory

256 GB



**M05: 128 GB
M10: 256 GB**

*Performance***

673 MIPS



782 MIPS

*Total Capacity**

2,760 MIPS



3,139 MIPS

• Based on LSPR ratings for fully configured system

** Single process performance

z196 Also Has Almost 8x More On-Chip Cache As z10 EC

One z10 EC MCM

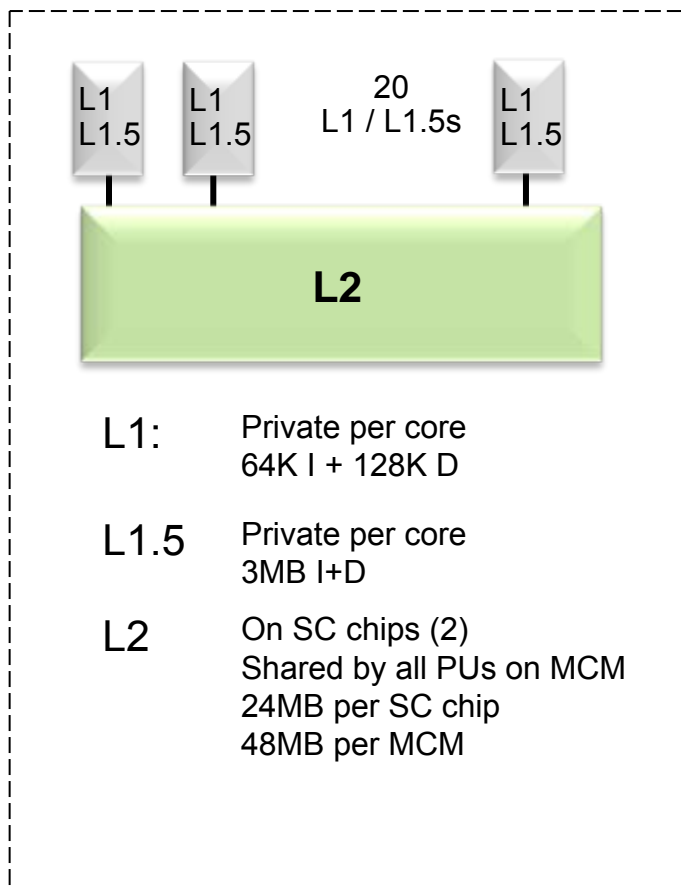

One z196 MCM

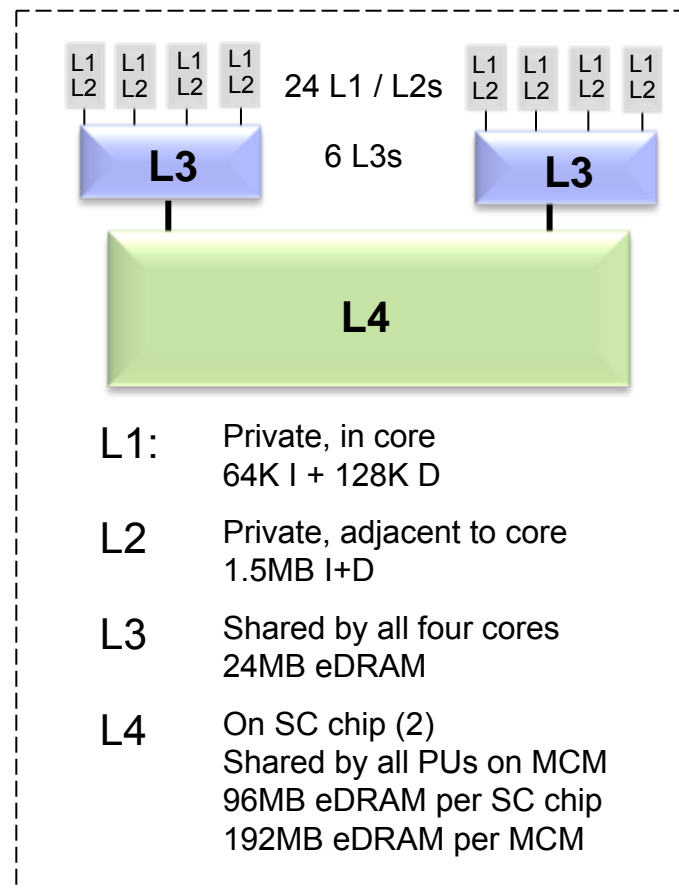

More cache leads to reduced latency times

z114 And z196 Add Out-Of-Order Processing

- Superscalar architecture enhancements:
 - ▶ Decodes up to 3 instructions per cycle (up from 2 on z10)
 - ▶ Executes up to 5 instructions per cycle (up from 2 on z10)
- >100 new instructions added
 - ▶ In particular, Instruction Cracking and Register Renaming which enable Out-of-Order (OOO) instruction execution
- Reduces instruction wait times, and benefits compute-intensive apps

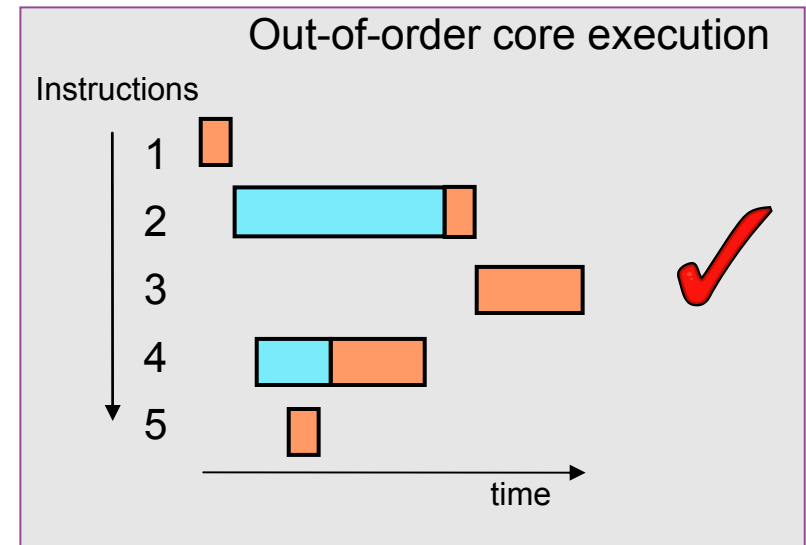
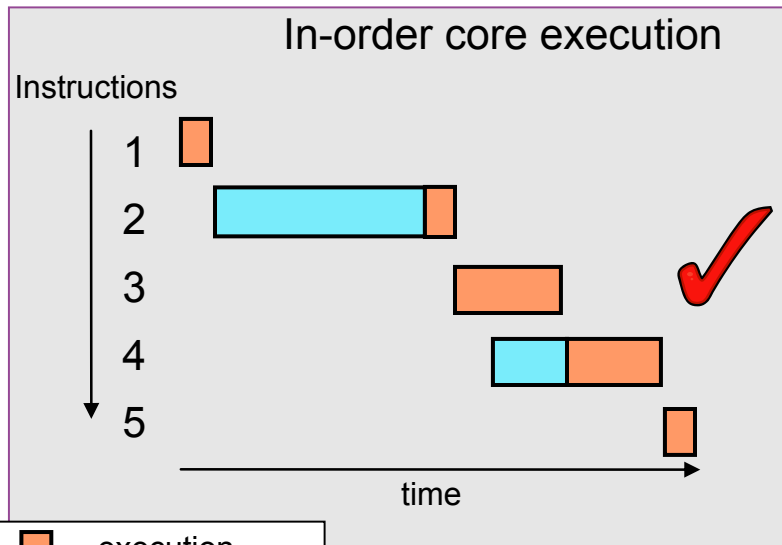

How Does This Add Up?

z196 Significantly Outperforms z10 EC

	Performance Ratio (z196 : z10 EC)
LSPR with z/OS V1R11	
z196 708 and z10 708*	1.37
z196 780 and z10 764**	1.64
CPO Banking Benchmark	
CICS – 3270 version	1.37
WAS on z/OS	1.32
WAS on Linux on System z	1.47
CPO COBOL Benchmark	
z/OS V1R11 Enterprise COBOL 4.1	1.41

* Customer average for z10 EC CEC is 9 GP processors

** Each as fully-configured systems

CICS/DB2 Optimizations For z/OS – From Then To Now

Continued investment to optimize key software for z/OS environment

- Upgrade CICS/DB2 stack produces 1.49 times performance improvement on same z10 hardware
- Move to z196 hardware produces 1.35 times performance improvement
- From then to now – **2.01** times performance improvement

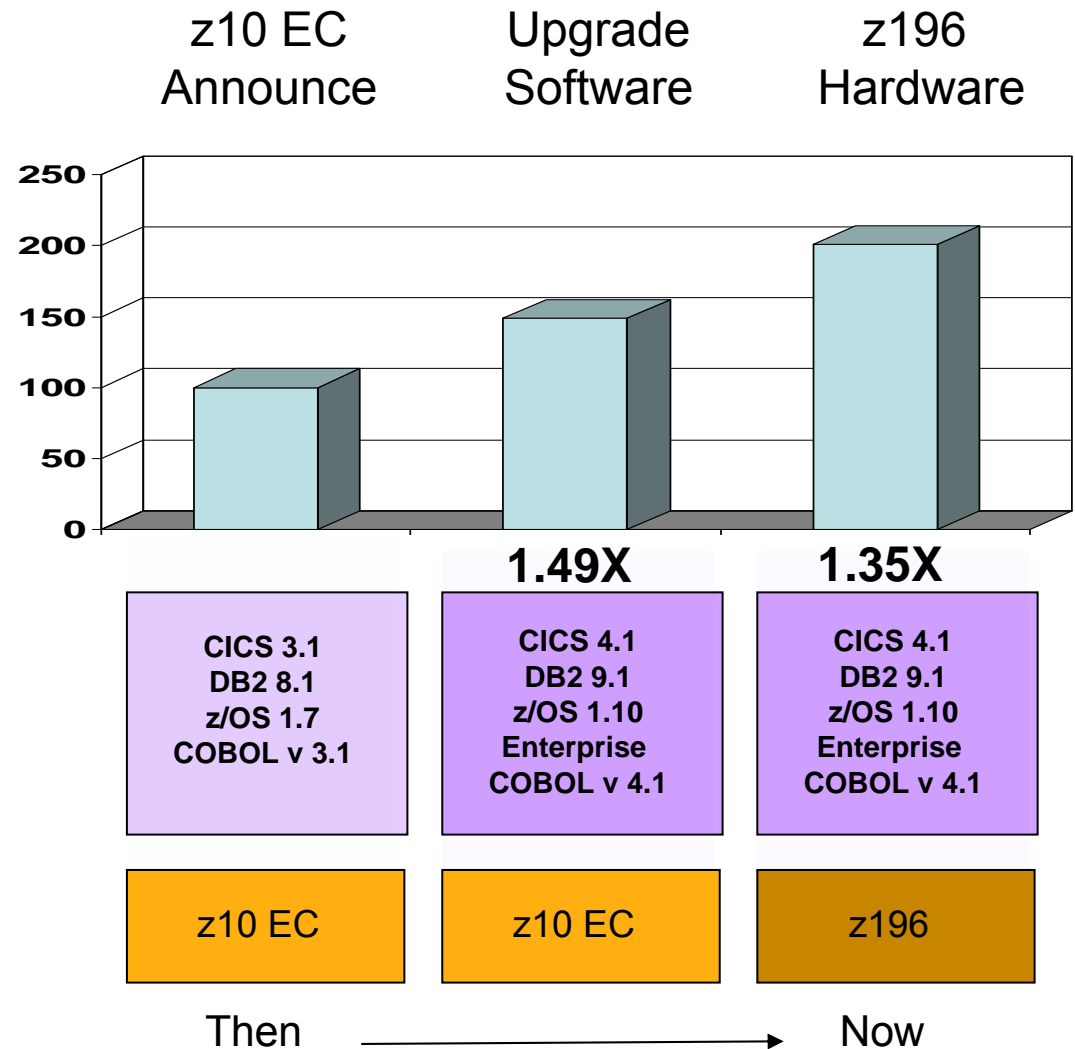

WebSphere Optimizations For Linux

Similar results are achieved for WebSphere software in a Linux for System z environment

- 1.32 times performance improvement for JPA 2.0 applications that exploit the OpenJPA Caching facilities available in the WebSphere Version 7 JPA Feature Pack.
- Move to z196 hardware produces 1.37 times performance improvement
- Combined hardware and software - **1.81** times performance improvement

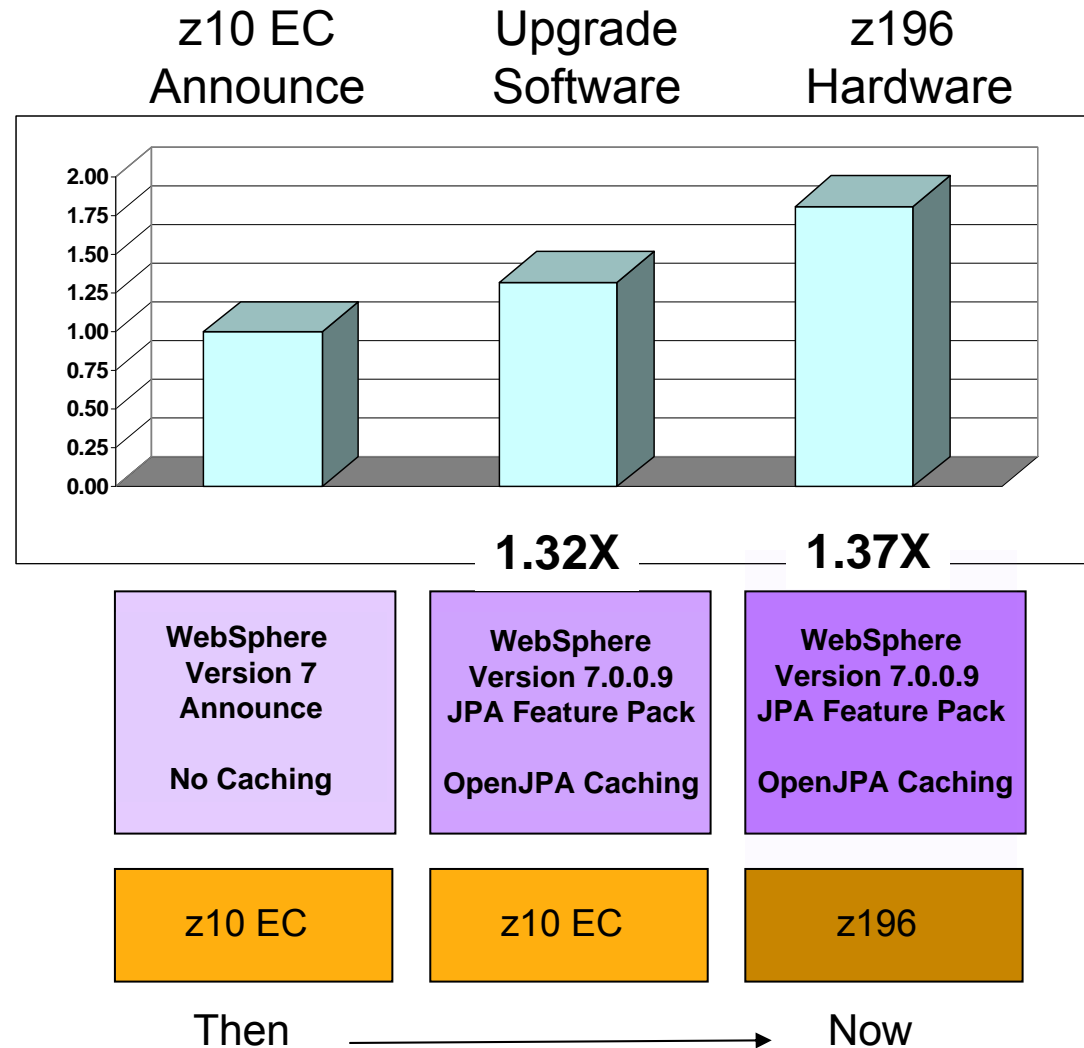

Continual HW And SW Innovations Yield Continuous Performance Improvements

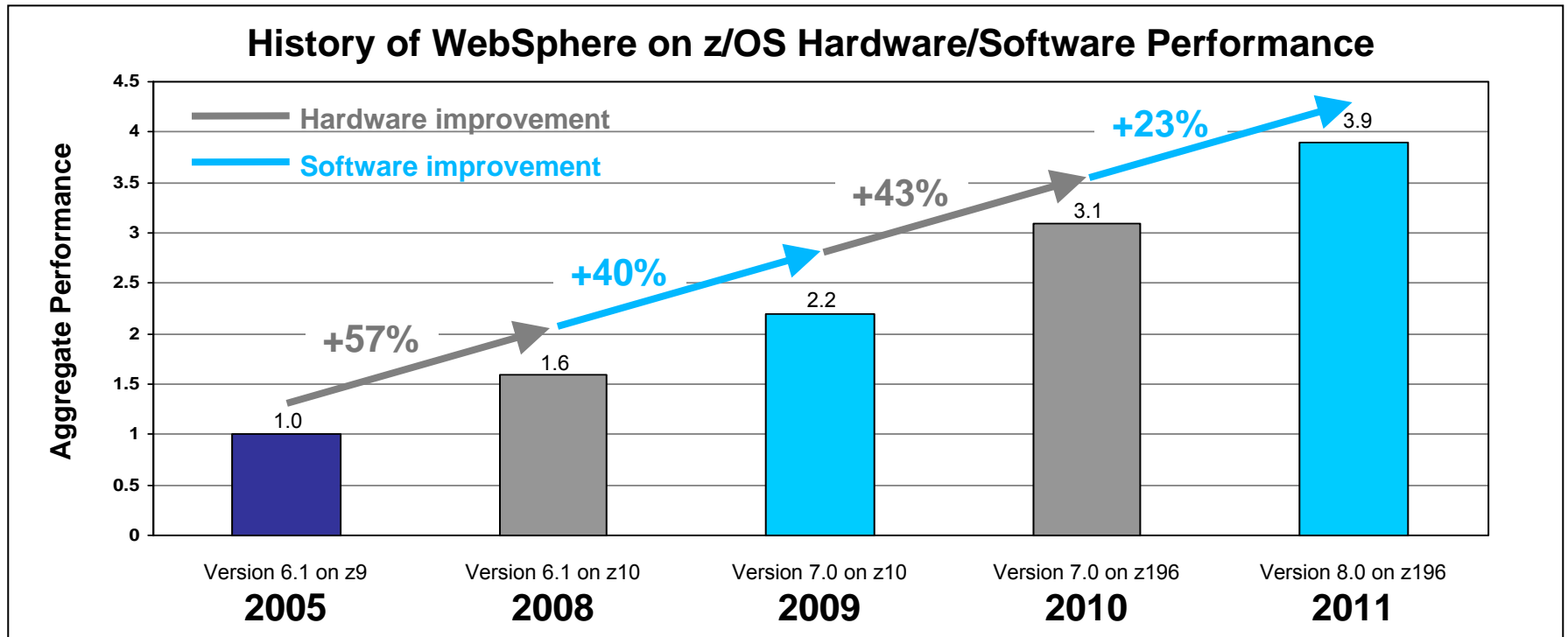

- Hardware component increase of about 2.25x (1.57 x 1.43)
- Software component increase of about 1.72x (1.40 x 1.23)
- Aggregate performance improvement of almost 4x from WAS V6.1 on a z9 to WAS V8.0 on a z196
- Similar improvements have been measured for CICS, DB2, and IMS

zEnterprise Value

- zEnterprise is STILL best for handling **core business workloads**
- zEnterprise is more than a mainframe – it's a **complete multi-architecture platform**
- zEnterprise continues a tradition of unmatched reliability and superior qualities of service



zEnterprise 114

zEnterprise BladeCenter Extension (zBX)



zEnterprise 196

zEnterprise BladeCenter Extension (zBX)

**IBM
zEnterprise
System**

zEnterprise Has Different Environments For Different Workload Requirements

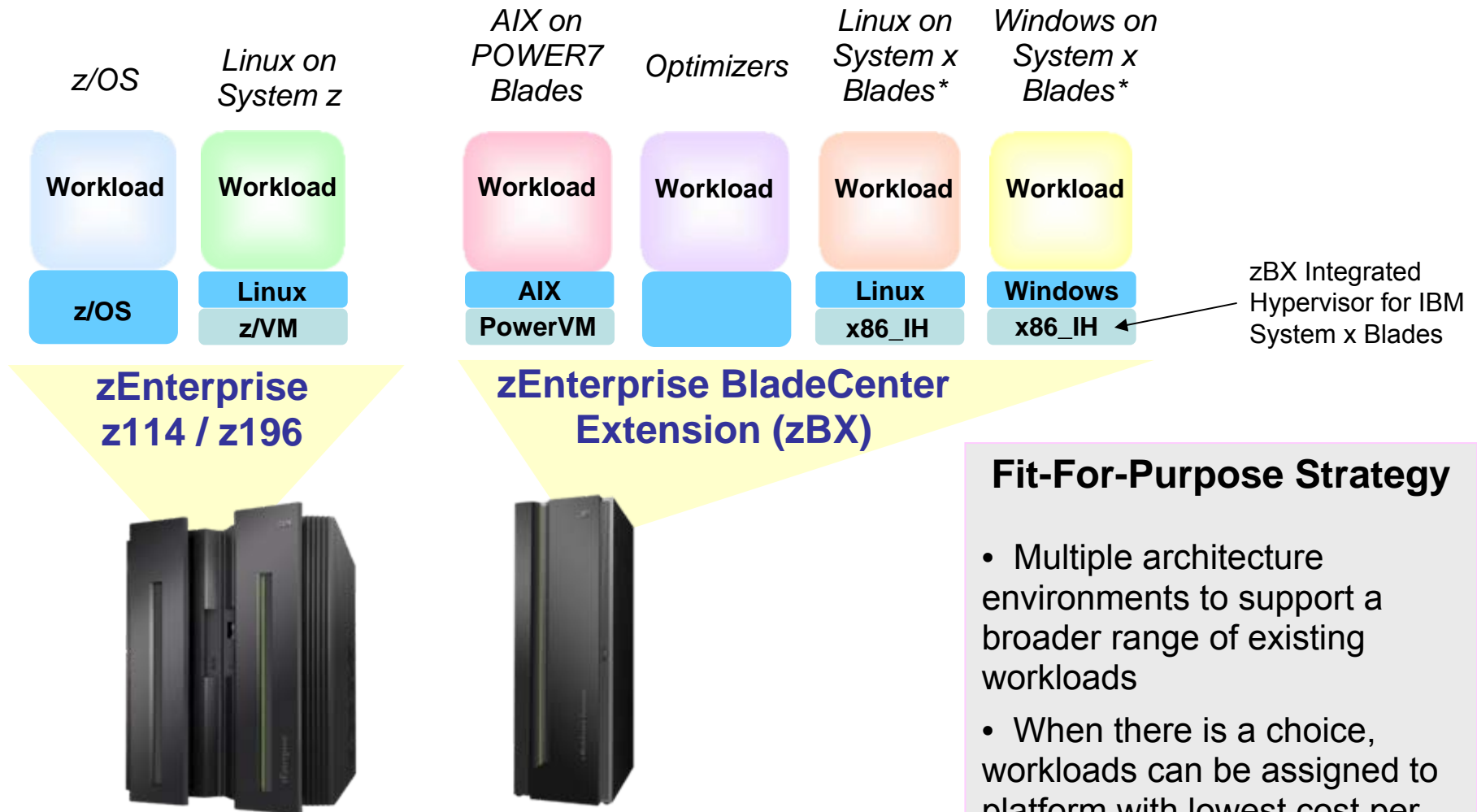

Fit-For-Purpose Strategy

- Multiple architecture environments to support a broader range of existing workloads
- When there is a choice, workloads can be assigned to platform with lowest cost per workload

*All statements regarding IBM future direction and intent are subject to change or withdrawal without notice, and represents goals and objectives only.

zEnterprise BladeCenter Extension (zBX) Adds New Platforms To System z

- zBX ordered and installed as one fully built and tested System z “part”
 - ▶ Includes all necessary components – switches, chassis, power, and cabling
 - ▶ Blades and optimizers purchased separately
- Built from standard IBM Certified Components
- Full redundancy insures highest reliability
- System z product support for problem reporting, hardware and firmware updates



One zBX rack:

- Up to 14 blades per chassis
- Up to 2 chassis per rack

One fully loaded zBX is:

- 4 racks
- 112 blades

Selected IBM blades supported:

- IBM POWER7 blades
- IBM System x blades*
- Specialty Optimizers
- Most can be mixed

* All statements regarding IBM future direction and intent are subject to change or withdrawal without notice, and represents goals and objectives only.

Blades Run Distributed Software Available Through Passport Advantage

IBM Information Management software

Cognos BI
Content Manager
DB2 UDB
Document Manager
Filenet
Informix
Information Integration
Information Server
InfoSphere
MDM
OmniFind
OpenPages
Optim
SPSS
...

Lotus software

Connections
Domino
Forms
ActiveInsight
Quickr
Web Content Manager
Workflow
Mashup Center
Sametime
...

- No MIPS or MSU rating for zBX software

WebSphere software

Application Workload Modeler
Communications Server
Decision Server
MQSeries
Process Integration Server
Application Server
BI Server
Business Integration
Commerce
ESB
Lombardi
Portal
Portlet Factory
Translation Server
Voice Server
...

Rational software

Team Concert
Requirements Composer
Asset Manager
BuildForge
ClearCase
AppScan
Quality Manager
Functional Test
Performance Test
...

Other

Unica
Systems Director
Sterling
...

Tivoli software

Directory Server
Maximo
Performance Analyzer
Composite Application Manager
Identity and Access Assurance
Access manager
Asset Manager
Change and Configuration Manager
Compliance Insight Manager
Directory Integrator
Federated Identity Manager
Identity and Access Manager
License Compliance Manager
Monitoring
Netcool
OMEGAMON
Provisioning
Security Compliance Manager
Service Automation Manager
Systems Automation
Workload Scheduler
...

zBX Optimizers Are Built-For-Purpose

- Delivered as Blades for use in zBX
- Fully-integrated, fully-contained – each targeted for specific workload functions
 - ▶ Pre-packaged, self-contained units including hardware, software, memory, etc.
- Designed for integration with and management by zEnterprise
- Two zBX optimizers available today:
 - ▶ **IBM Smart Analytics Optimizer**
 - ▶ **IBM WebSphere DataPower XI50 for zEnterprise**

Optimizers



But what is so unique about putting a BladeCenter next to a mainframe?



CIO

There's more to this than meets the eye!

The Unified Resource Manager – also called zManager – is the “secret sauce”.

It provides extensive management of resources and workloads across all zEnterprise platforms!



IBM

zManager Provides Platform And Resource Management Across zEnterprise Environments

Process	Typical Distributed Management Practices	zManager
Asset Management	<ul style="list-style-type: none"> Discover assets with ad hoc methods Manual entitlement management 	<ul style="list-style-type: none"> Automated discovery and management of entitlement assets
Deployment Management	<ul style="list-style-type: none"> Manually configure hypervisor and build networks 	<ul style="list-style-type: none"> Automated deployment of hypervisor and attachment to integrated networks
Security Management	<ul style="list-style-type: none"> Different ways to manage administrator access 	<ul style="list-style-type: none"> Centralized, fine-grained administrator access management
Change Management	<ul style="list-style-type: none"> No visibility into impact of changes 	<ul style="list-style-type: none"> Track dependencies for change impact
Capacity and Performance Management	<ul style="list-style-type: none"> No end-to-end transaction monitoring Manually adjust CPU resources to meet changing workload demands 	<ul style="list-style-type: none"> End-to-end transaction monitoring to isolate issues Automatic CPU resource adjustments to meet changing workload demands

z114 / z196 And zBX Are Connected Via Two Internal Networks

- Isolated and dedicated Management Network
- Secure Data Network for virtual machine communication
- Full redundancy for reliability
 - ▶ OSA adapters
 - ▶ Top of rack switches
 - ▶ Bulk power hubs
 - ▶ Support Elements and HMC

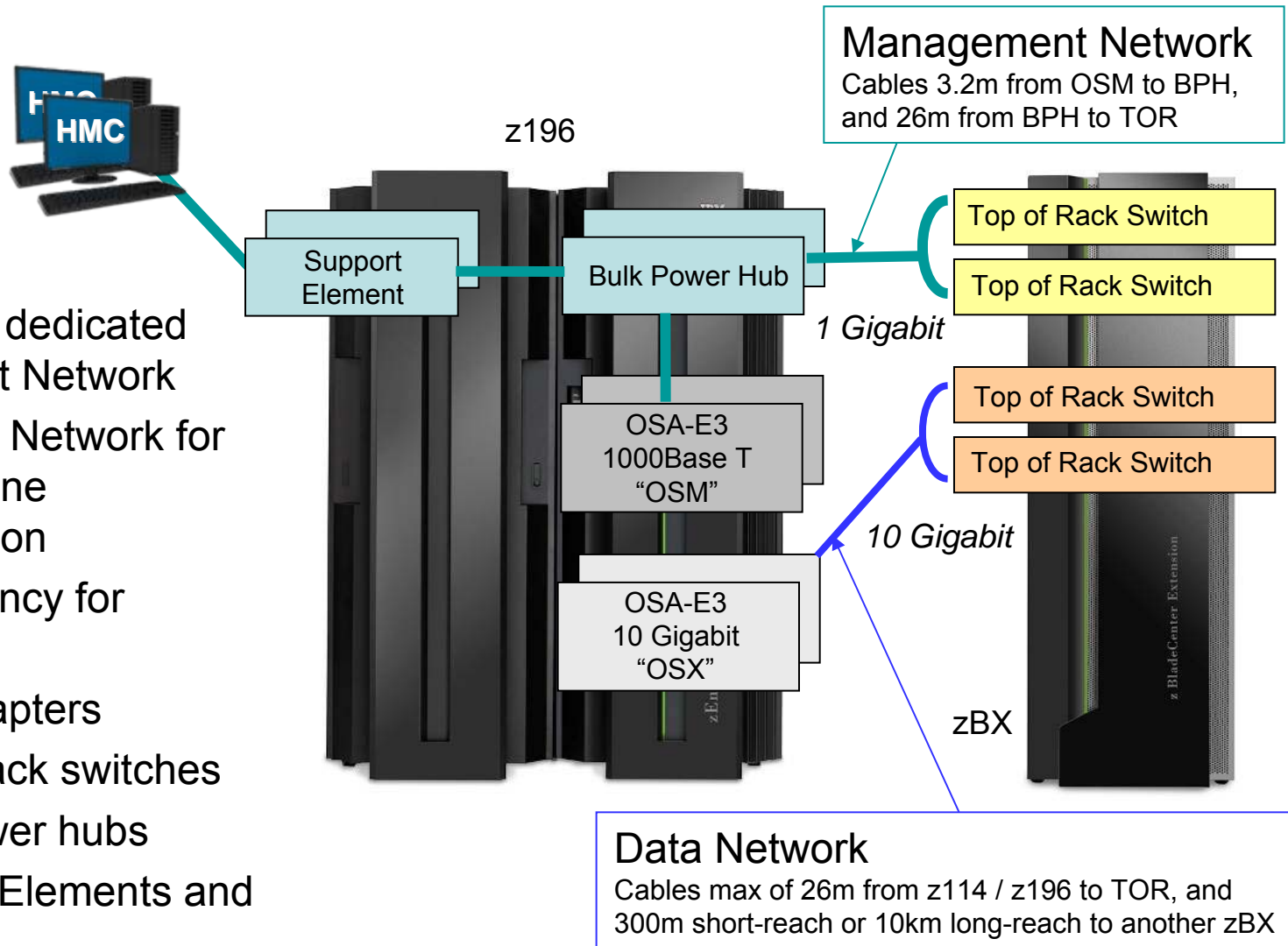

zEnterprise Network Simplification And Security

- “Network in a box” limits vulnerability to security breaches
 - ▶ Fully integrated concealed networks
 - No external switches or routers necessary – IBM-only equipment
 - Fully tested, pre-installed and pre-configured
 - ▶ Can reduce latency and the number of “hops”

- Security
 - ▶ Management Network:
 - Tightly restricted to zManager use only
 - ▶ Data Network:
 - Accessible only by authorized virtual machines
 - ▶ Logical security via virtualization
 - ▶ zManager includes strict “role-based” access control
 - ▶ No need for additional encryption or firewall



zManager Owns The Private Management Network For Hypervisor Communications

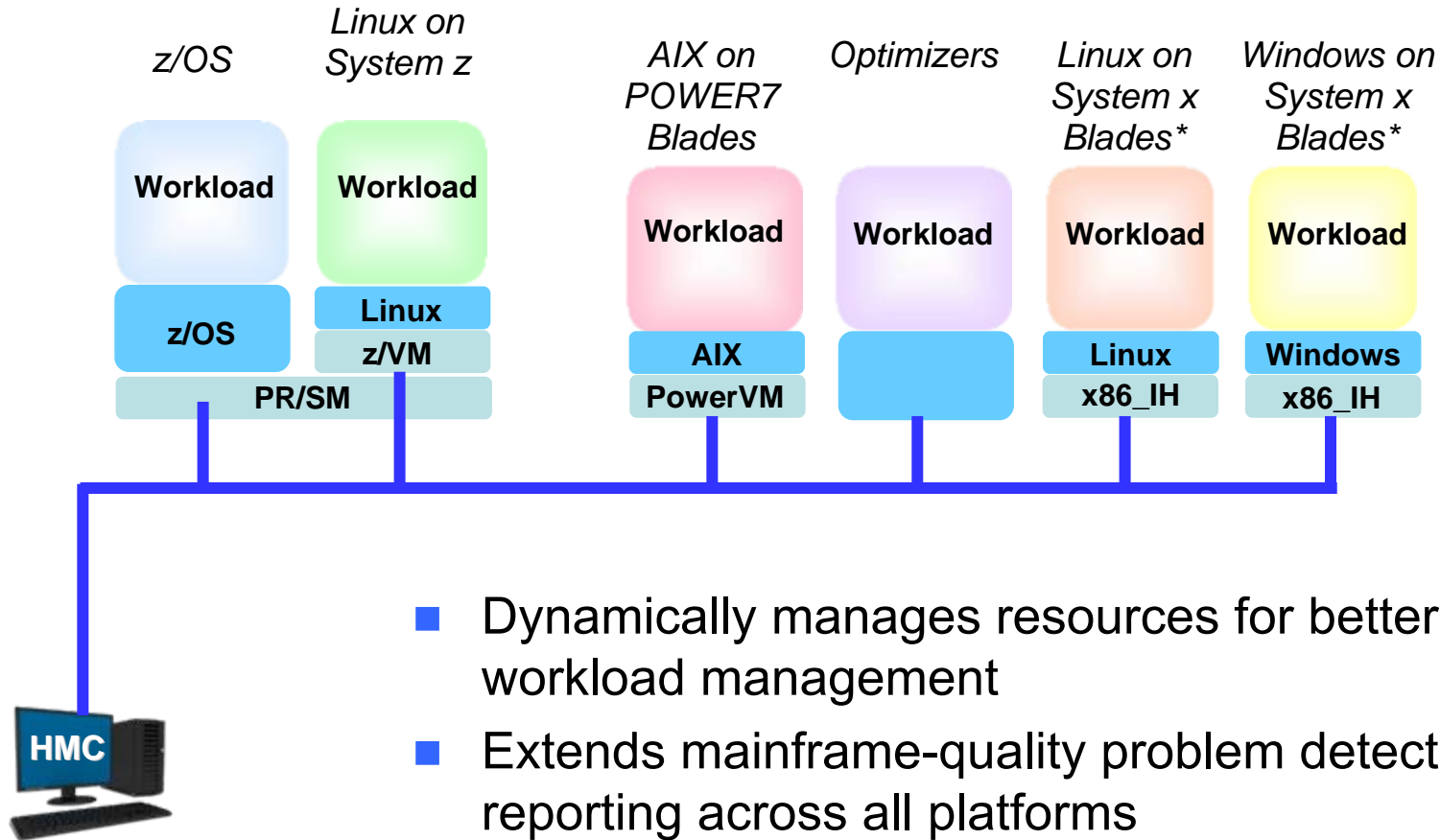

- Dynamically manages resources for better workload management
- Extends mainframe-quality problem detection and reporting across all platforms
- Monitors system-wide energy efficiency

DEMO: Manage Resources And Workloads Using zManager

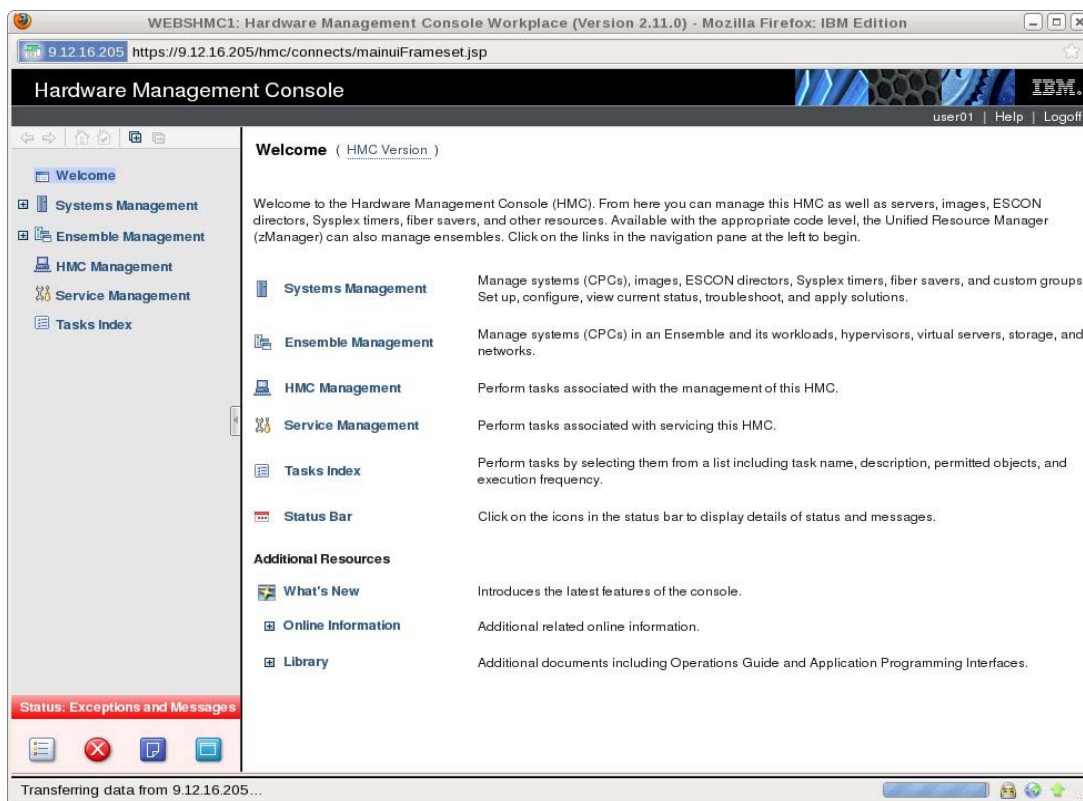

- zManager uses familiar HMC interface
- View and manage all zEnterprise platforms

zManager Can Drive Down Labor Costs

IT Process	zManager	Costs Reduced By*
Asset Management	<ul style="list-style-type: none"> Automated discovery and management of entitlement 	9%
Deployment Management	<ul style="list-style-type: none"> Automated deployment of hypervisors and virtual networks 	33%
Capacity and Performance Management	<ul style="list-style-type: none"> Automatic resource adjustments to meet changing workload demands 	52%
Security Management	<ul style="list-style-type: none"> Centralized, fine-grained administrator access 	20%
Change Management	<ul style="list-style-type: none"> Dependency tracking across platform for change impact 	41%

*Source: IBM Internal study of 92 hybrid workloads

zEnterprise Value

- zEnterprise is STILL best for handling **core business workloads**
- zEnterprise is more than a mainframe – it's a **complete multi-architecture platform**
- zEnterprise continues a tradition of **unmatched reliability** and **superior qualities of service**



zEnterprise 114

*zEnterprise
BladeCenter
Extension (zBX)*



zEnterprise 196

*zEnterprise
BladeCenter
Extension (zBX)*

**IBM
zEnterprise
System**

A Complex, Distributed-based Scale Out Strategy Has Its Risks

North America	Europe	Asia Pacific		Apr 26	Apr 25	Apr 24	Apr 23	Apr 22	Apr 21	Apr 20
Amazon CloudFront				✓	✓	✓	✓	✓	✓	✓
Amazon CloudWatch (N. California)				✓	✓	✓	✓	✓	✓	✓
Amazon CloudWatch (N. Virginia)				✓	✓	✓	✓	✓	✓	✓
Amazon EC2 (N. California)				✓	✓	✓	✓	✓	✓	✓
Amazon EC2 (N. Virginia)				✓	✓	⚠	✖	✖	✖	✓
Amazon EMR (N. California)				✓	✓	✓	✓	✓	✓	✓
Amazon EMR (N. Virginia)				✓	✓	✓	✓	✓	✓	✓
Amazon Flexible Payments Service				✓	✓	✓	✓	✓	✓	✓
Amazon Mechanical Turk (Requester)				✓	✓	✓	✓	✓	✓	✓
Amazon Mechanical Turk (Worker)				✓	✓	✓	✓	✓	✓	✓
Amazon RDS (N. California)				✓	✓	✓	✓	✓	✓	✓
Amazon RDS (N. Virginia)				✓	✓	⚠	✖	✖	✖	✓
Amazon Route 53				✓	✓	✓	✓	✓	✓	✓
Amazon Simple Email Service (N. Virginia)				✓	✓	✓	✓	✓	✓	✓
Amazon SNS (N. California)				✓	✓	✓	✓	✓	✓	✓
Amazon SNS (N. Virginia)				✓	✓	✓	✓	✓	✓	✓
Amazon SQS (N. California)				✓	✓	✓	✓	✓	✓	✓
Amazon SQS (N. Virginia)				✓	✓	✓	✓	✓	✓	✓
Amazon S3 (N. California)				✓	✓	✓	✓	✓	✓	✓
Amazon S3 (US Standard)				✓	✓	✓	✓	✓	✓	✓
Amazon SimpleDB (N. California)				✓	✓	✓	✓	✓	✓	✓
Amazon SimpleDB (N. Virginia)				✓	✓	✓	✓	✓	✓	✓
Amazon VPC (N. Virginia)				✓	✓	✓	✓	✓	✓	✓

Amazon public cloud platform suffered a 3+ day outage in April, 2011

- Distributed architecture designed “for durability and availability”
- Yet a complex *single point of failure* negated the advantage of rapid replacement of failed resources
- Numerous customers suffered significant and unrecoverable data loss

reddit is down.



System z Has A History Of Continuous Improvements To Reliability And Serviceability

Example of fault-tolerant design:

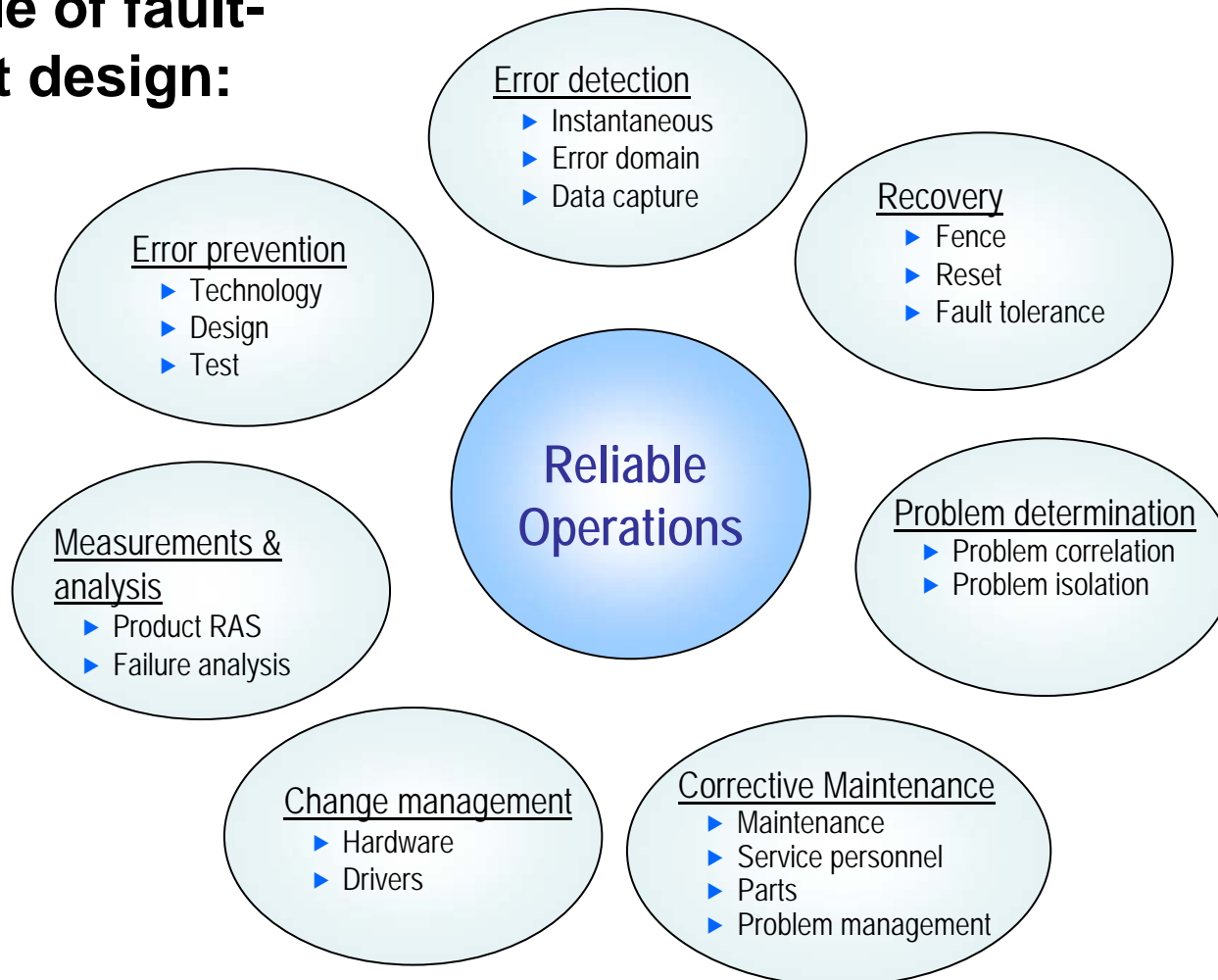

z/OS Can Support Unprecedented Levels Of Availability

- Parallel Sysplex architecture designed for **99.999%** availability
 - ▶ Full redundancy yielding no single points of failure
 - All systems can have concurrent access to all critical applications and data
 - Automatic restart and recovery capabilities
 - ▶ Dynamic workload routing via z/OS Workload Manager and Sysplex Distributor
 - Work flow designed for best response times



Result: z/OS Delivers The Highest Availability And The Lowest Downtime Cost

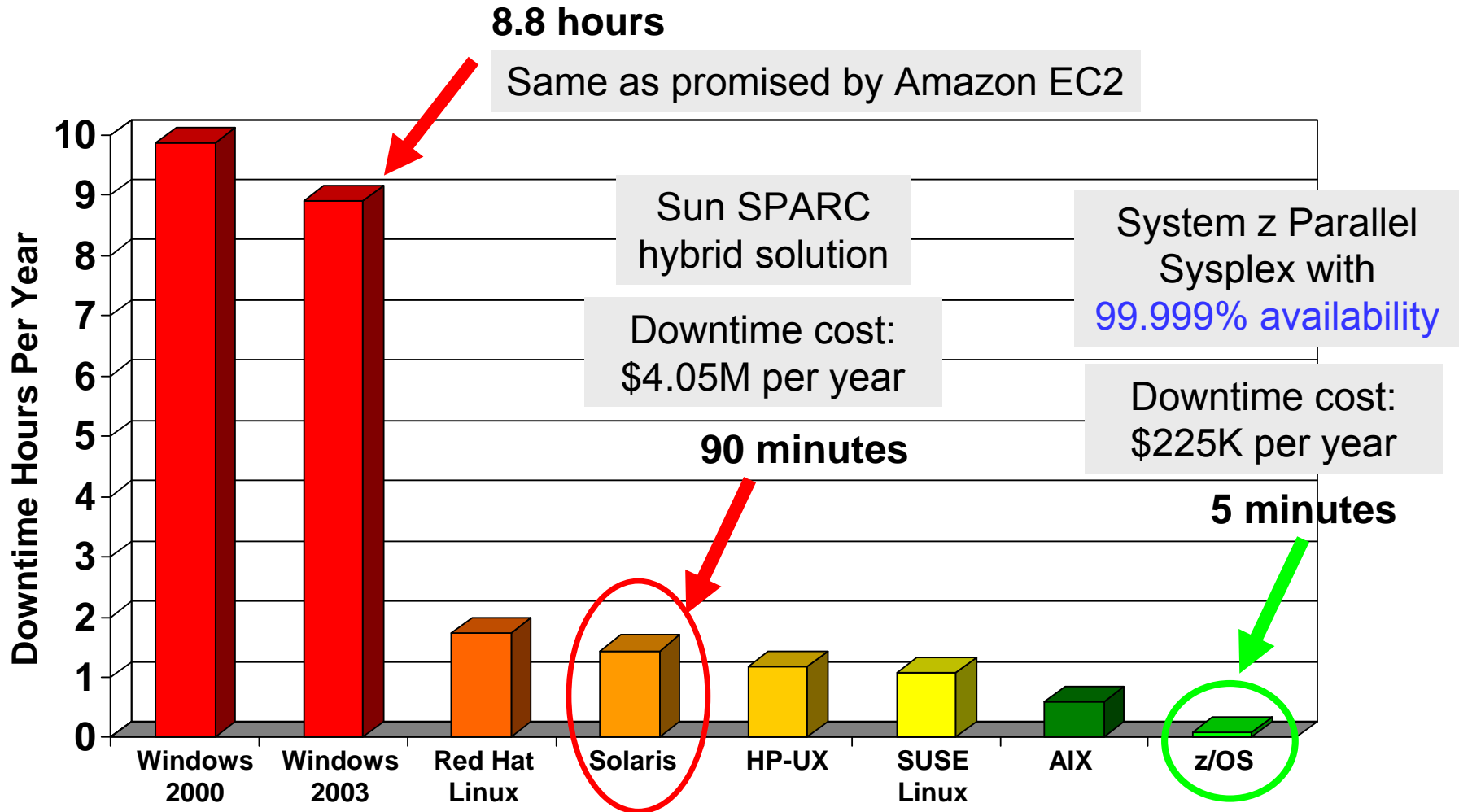

Source: 2007-2008 Global Server Operating Systems Reliability Survey, Yankee Group, March 2008.

Source: IBM Internal Study

Source: Robert Frances Group, 2006 - Cost based on \$2.7M average revenue lost per hour of downtime

zEnterprise Continues The Strategy Of Constant Improvements In Availability

■ RAIM Memory

- ▶ Provides more redundancy to protect against additional failure modes

- Protects DIMM level components such as ASIC, power regulators, clock, and board

- Protects memory channel failures such as signal lines, control lines, and drivers/receivers on the MCM

- More robust than ECC, and more cost effective than 100% memory mirroring

- No performance penalty

■ Hot pluggable I/O drawer technology reduces planned down time

- ▶ Perform maintenance while the system keeps running

zEnterprise Value Is Unsurpassed!

- zEnterprise is STILL best for handling **core business workloads**
- zEnterprise is more than a mainframe – it's a **complete multi-architecture platform**
- zEnterprise continues a tradition of **unmatched reliability** and **superior qualities of service**



zEnterprise 114

*zEnterprise
BladeCenter
Extension (zBX)*



zEnterprise 196

*zEnterprise
BladeCenter
Extension (zBX)*

**IBM
zEnterprise
System**