



Powering business agility through platform exploitation





IBM Vision at a Glance...

Smarter Planet



- instrumented
- interconnected
- intelligent
- people
- companies, institutions, industries
- man-made systems
- nature's systems



Today's Imperatives Are...

Cost Optimization

to slash operational and maintenance expense and maximize efficiency necessary for all economic climates

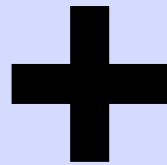

Agility

to take advantage of new revenue opportunities and address competitive threats

To Survive... To Succeed!



Where are you spending your IT Budgets?

“76% of I.T budgets are spent on MAINTENANCE, leaving only 24% for NEW INVESTMENTS.”

--- Forrester Research

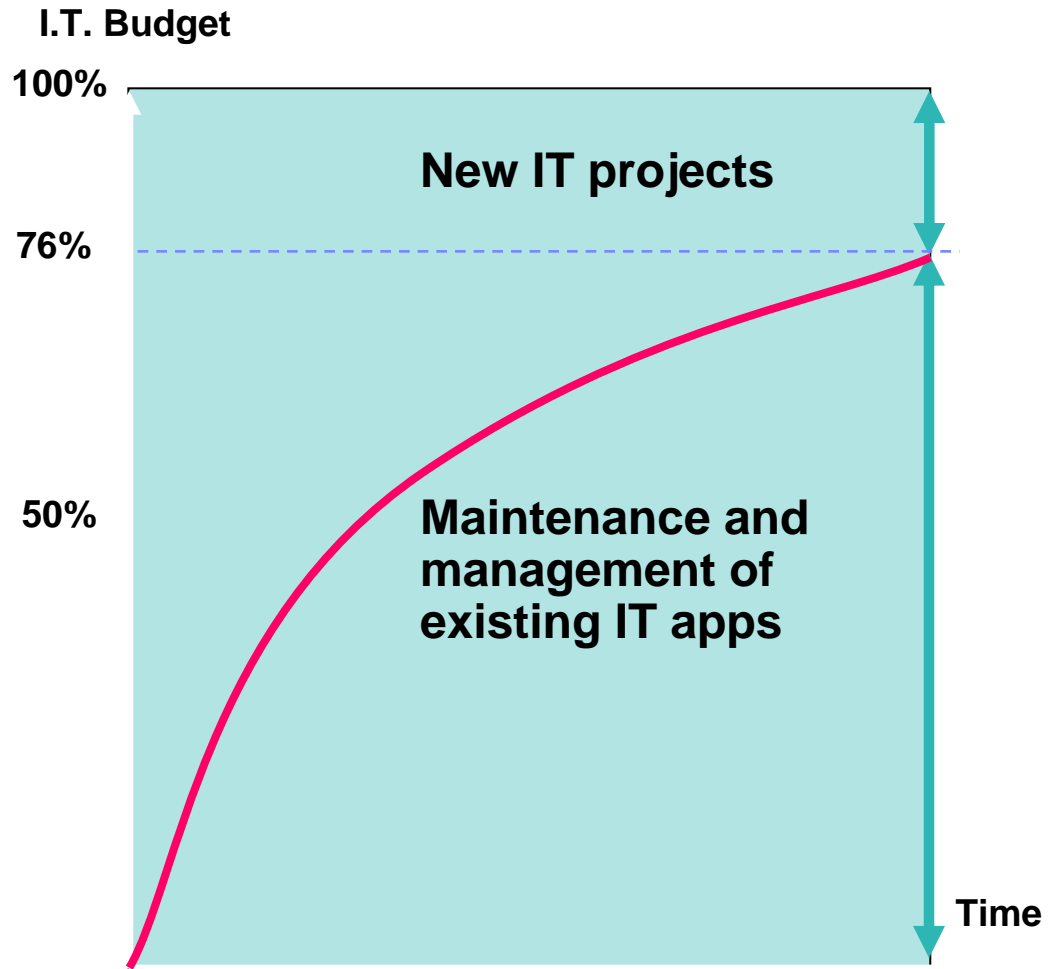



IBM's Smart SOA

Powers Smarter Business Outcomes Across a Continuum

Business

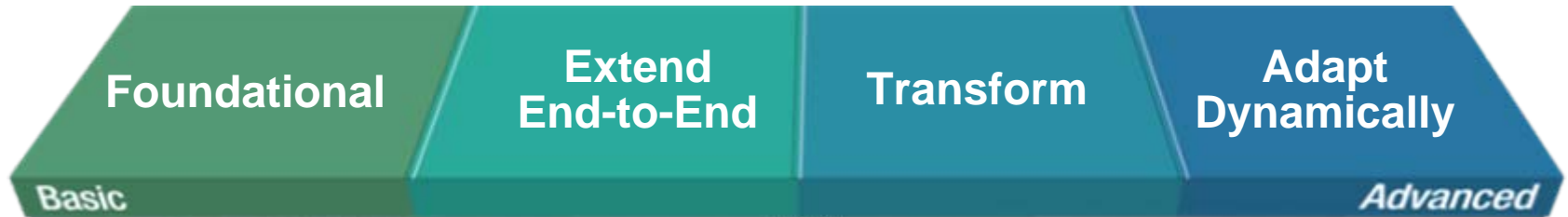

IT

SOA Application Infrastructure delivers the foundation for building, deploying and managing all types of applications, ensuring they deliver on business objectives regardless of the situation



The Power of a Smart SOA Application Foundation

Modernize applications



Expand client offerings using existing business data with Web 2.0

Execute high volume transactions



Reduce business risks with highly available, secure applications

Capitalize on dynamic situations



Timely insight with low cost situational applications

Manage worldwide operations



Rapidly introduce new capabilities throughout the business with centralized administration



Address your critical business needs with Smart SOA Application Foundation

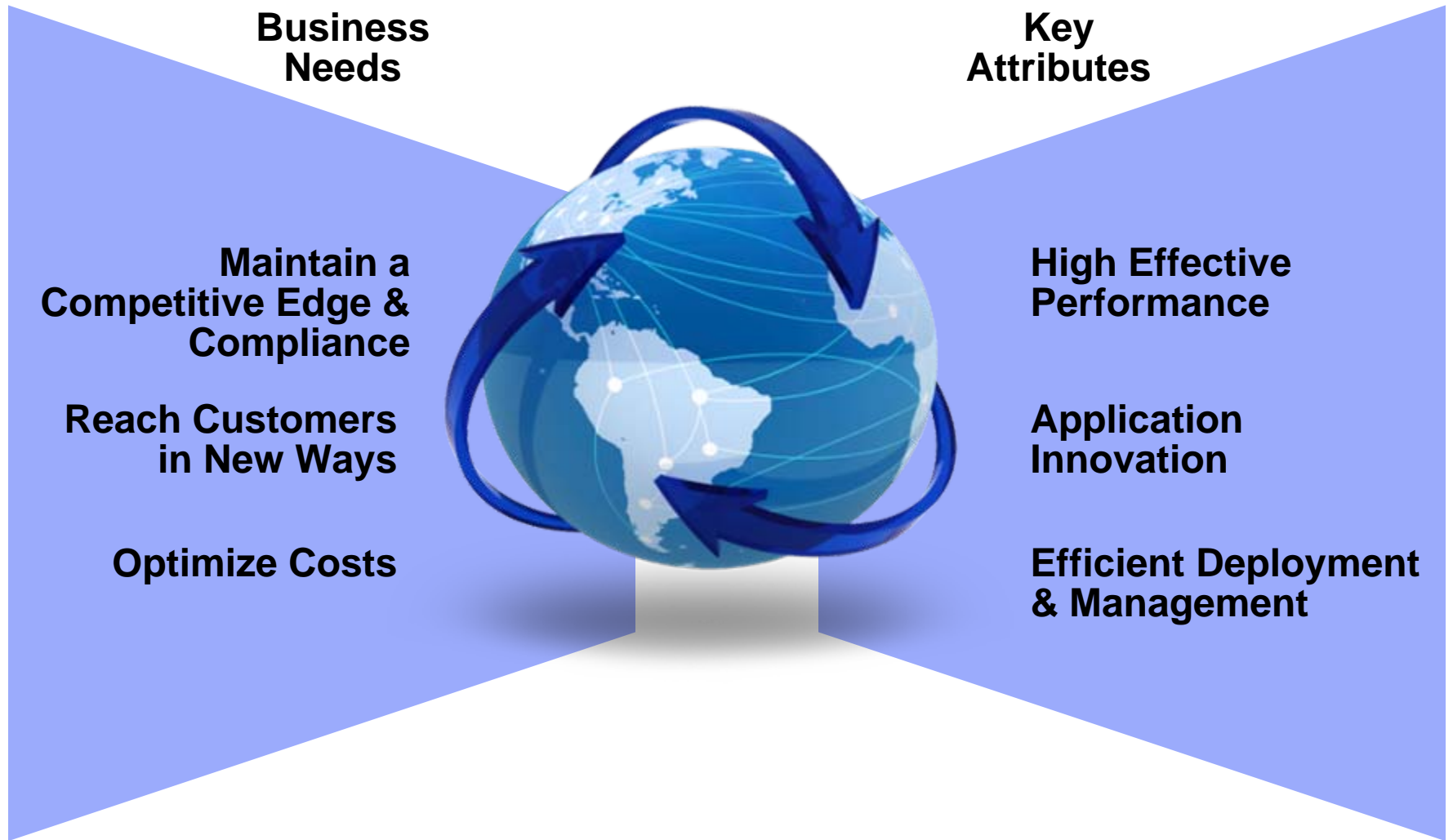



Two Questions We'll Answer Today ...

ibm.com WebSphere page ...

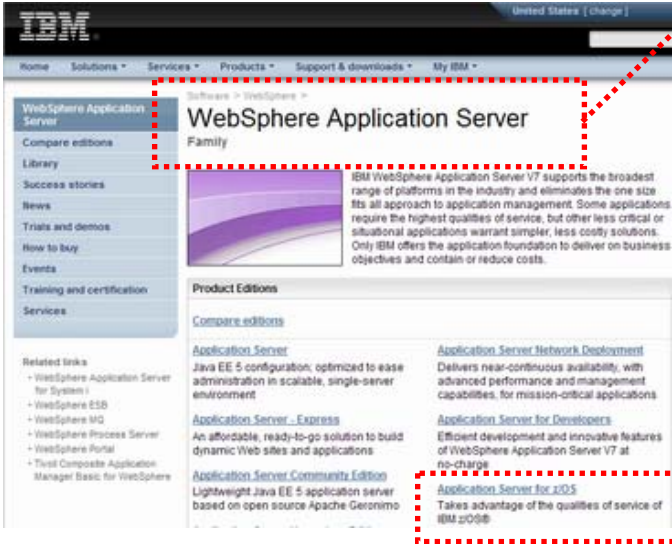

WebSphere Application Server Family

WebSphere. software

How does WebSphere Application Server address your business imperatives?

Application Server for z/OS
Takes advantage of the qualities of service of IBM z/OS®

What is meant by "Takes advantage of the qualities of service of IBM z/OS?"



The WebSphere Application Server Family

An industry-leading open standard application server platform, with powerful business functionality

Manage Cost

- Common standards across all platforms
- Common tooling across all platforms
- Many of the same skills across all platforms

Enhance Agility

- Rapid development and deployment model
- Many dynamic runtime elements

Common business applications runtime across the enterprise ... development, test, production



Common Standards Across Family of Platforms



Common specification support above the line

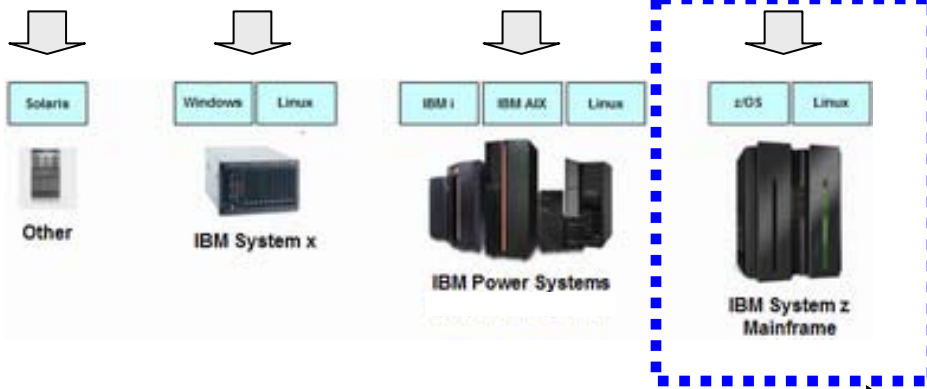

Platform exploitation takes place below the specification line

It's all about the System z and z/OS platform and the way WAS z/OS exploits the platform



Passive and Active Exploitation

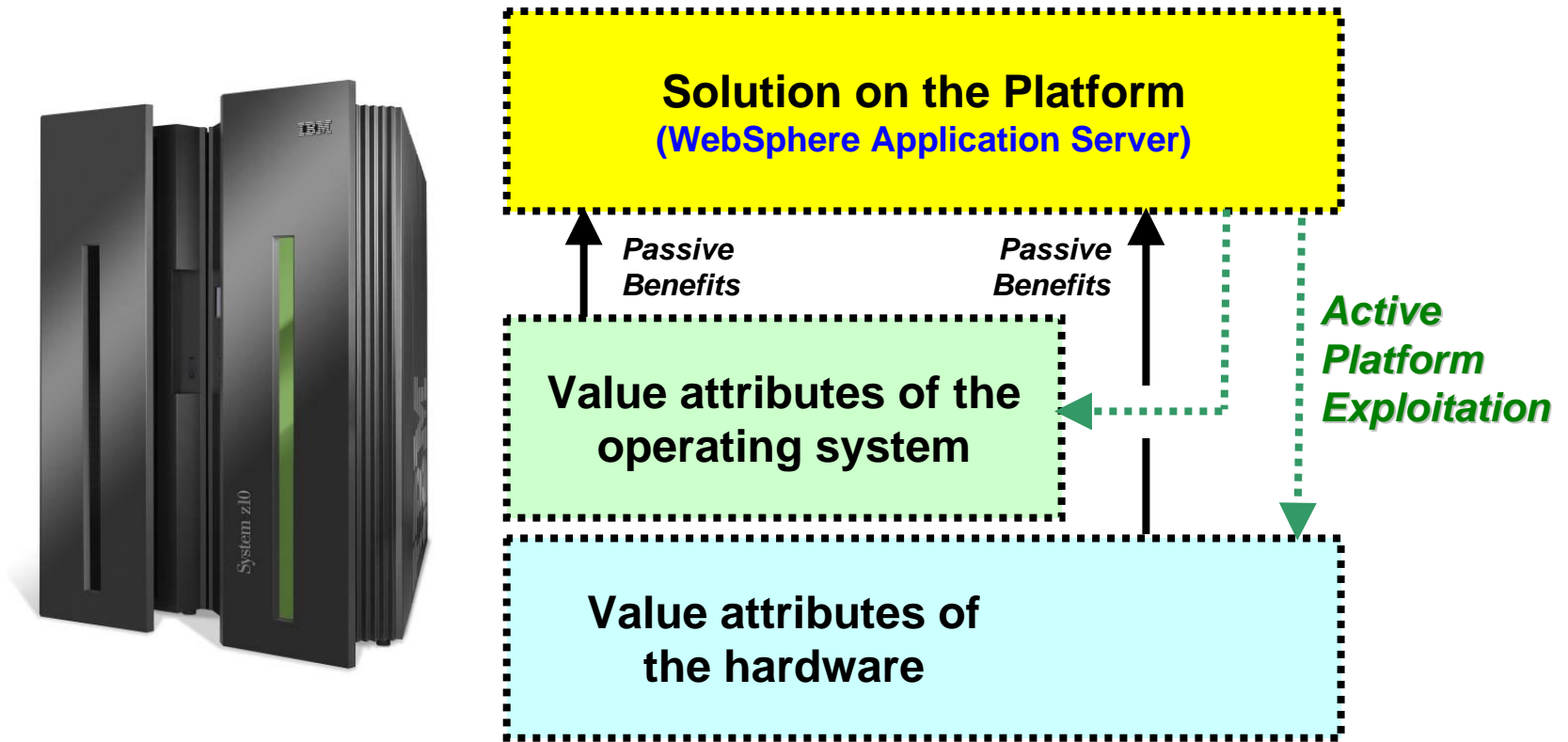

WebSphere Application Server z/OS benefits from both



Industry-Leading Virtualization Technology

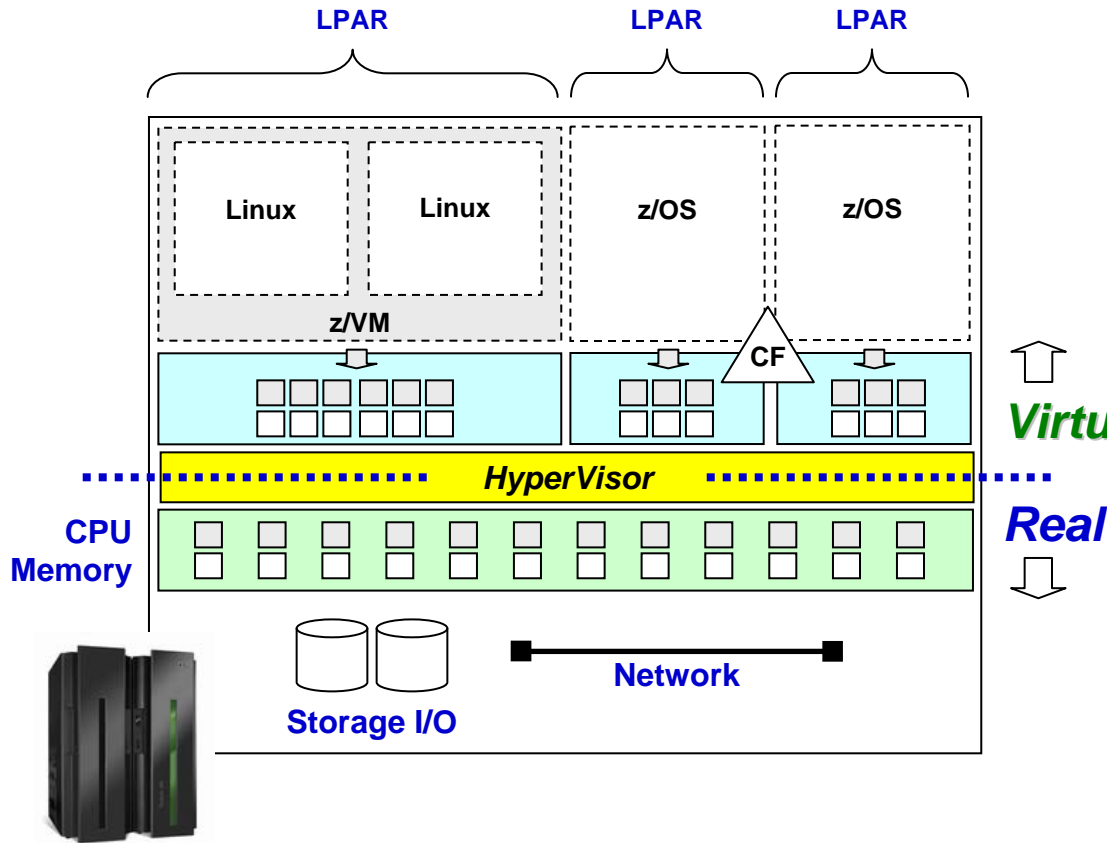

**Not merely “like”
the mainframe
It *is* the mainframe**

Virtualized

Real

**Proven enterprise
quality virtualization
technology**

Not all virtualization technologies are the same



Dynamic Resource Re-Allocation Between LPARs

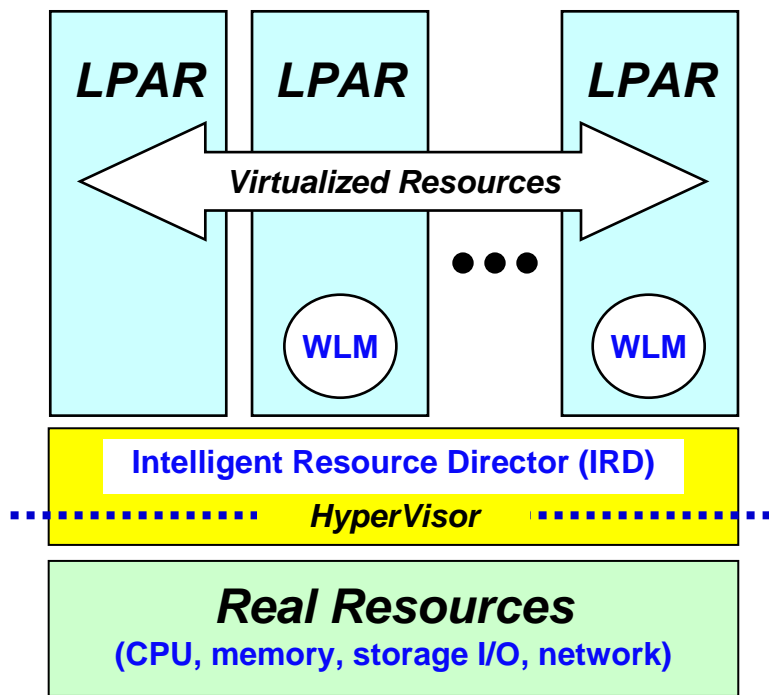

Add CPU non-disruptively

Re-allocate CPU non-disruptively

IRD intelligently balances

Vary I/O capacity dynamically

WLM advise IRD

Virtualization technology that evolved in the enterprise

Solid, stable and proven



True Data Sharing From Multiple Resource Instances

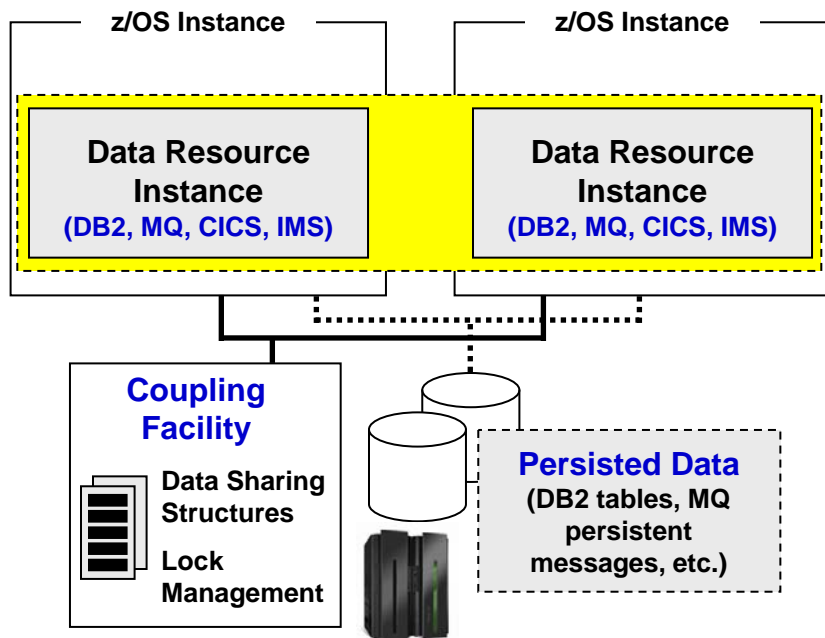

- **Parallel Sysplex provides clustered z/OS instances**
- **Shared data, lock management, coordinated time management, high-speed data transfer**
- **Mature, stable, reliable**
- **Unbeatable availability**

Provides scalability and availability ... to levels used throughout the world for critical activity



Intelligent TCP/IP

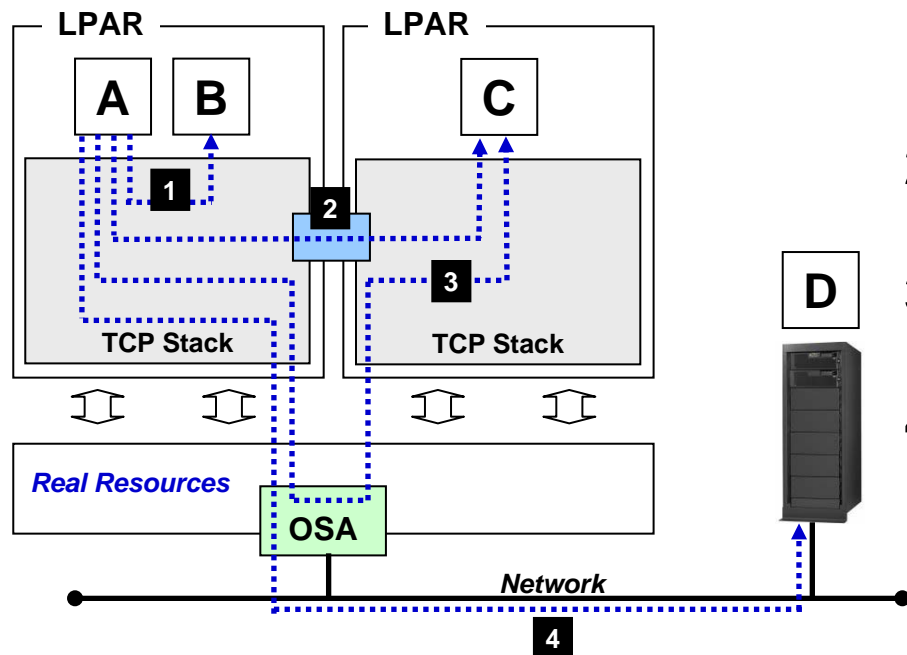

- 1. Same LPAR**
No network ... cross memory ... *ultra fast*
- 2. Different LPAR, HiperSockets**
No network ... cross memory ... *very fast*
- 3. Different LPAR, *not* HiperSockets**
No wire ... just adapter card ... *fast*
- 4. Off System z**
Traditional networking here

When throughput and scalability is important, network delays can add up

TCP/IP on z/OS is very aware and optimizes its path to reduce overhead and benefit your business



Key Areas of **Active** Platform Exploitation by WAS z/OS

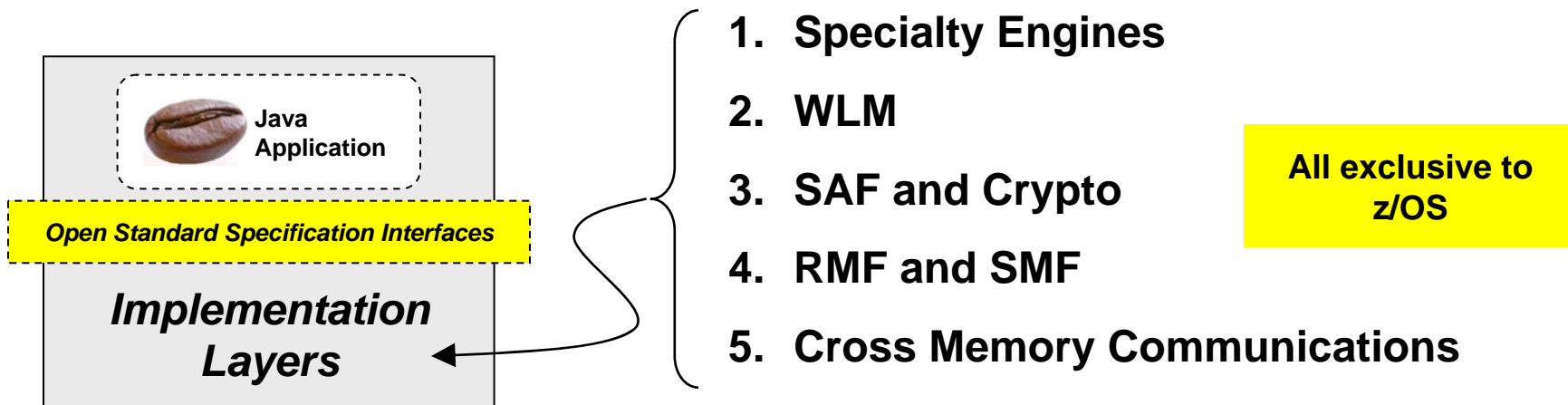

WebSphere Application Server is “platform aware” on all platforms

WebSphere Application Server for z/OS knows about key z/OS value attributes

It reaches out and exploits them to your advantage

Let's see what that means to you ...



Specialty Engine Exploitation

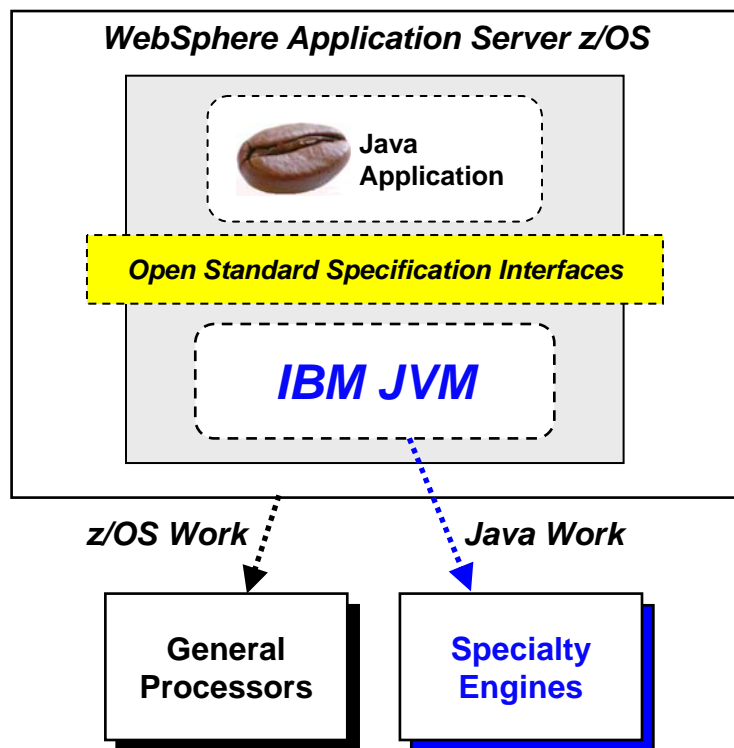

- **Offload Java work to financially attractive specialty engines**
- **Completely transparent process to applications**
- **Greater general processor capacity for non-Java work**
- **Lower software licensing costs, and/or the avoidance of additional costs**

Works for Java offload, Linux on System z offload and certain DB2 processing offload

A feature enthusiastically embraced by many System z and z/OS customers!



Workload Manager (WLM) Exploitation

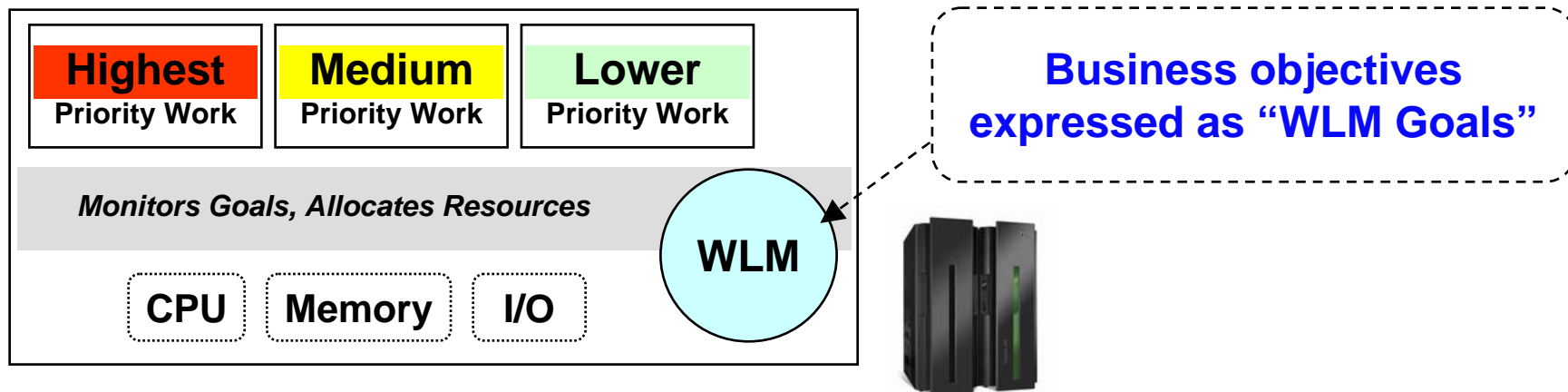

Benefits to you and your business:

- Intelligent control of resources towards meeting *your* goals
- Very efficient resource sharing can be accomplished
- Critical work gets the resources, less critical held off temporarily
- Intelligent routing of work based on WLM monitoring of system

Manage costs -- very efficient utilization of asset investment

Provide agility -- intelligent and dynamic allocation to meet goals



SAF and Crypto Hardware

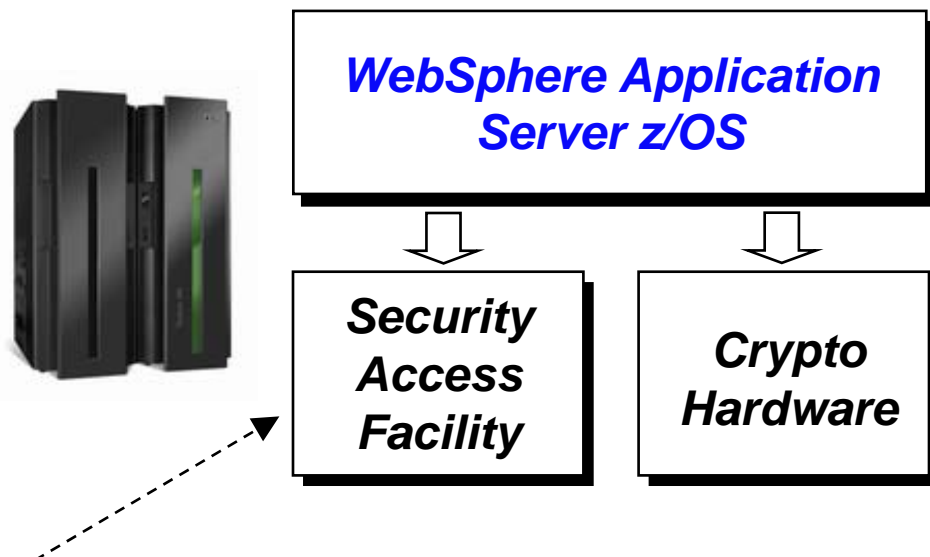

- System interface for security products (IBM = RACF)
- Single, integrated security facility for tighter process control
- Define many classes of security profiles, including digital certificates

- Highest level of security for storage of private keys
- Very fast encryption and decryption
- Enhances security

Security breaches are very disruptive and very expensive

Protecting secure data is a business imperative

SAF has proven itself to be secure and trusted



SMF and RMF -- Measuring and Reporting on Activity

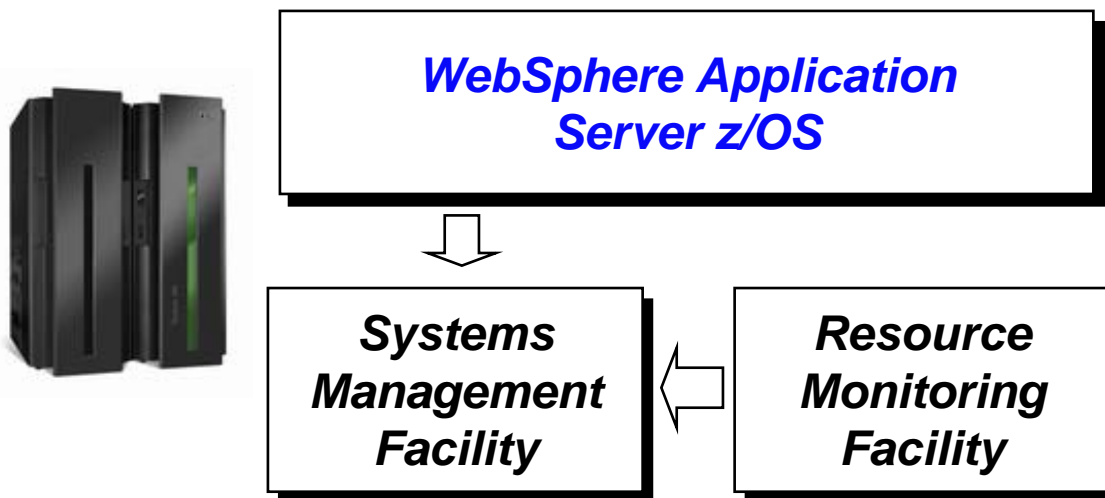

- Achieve very accurate and customized reporting of system activity
- Perform very precise capacity measurement and planning
- Capture who is using what resources and when
- Allows finer-grained accounting and chargeback
- Many tools on the shelf to do analysis and reporting

Have a clear view of your resource investment and utilize it as fully as you can with the information you can gather



Collocation Benefits

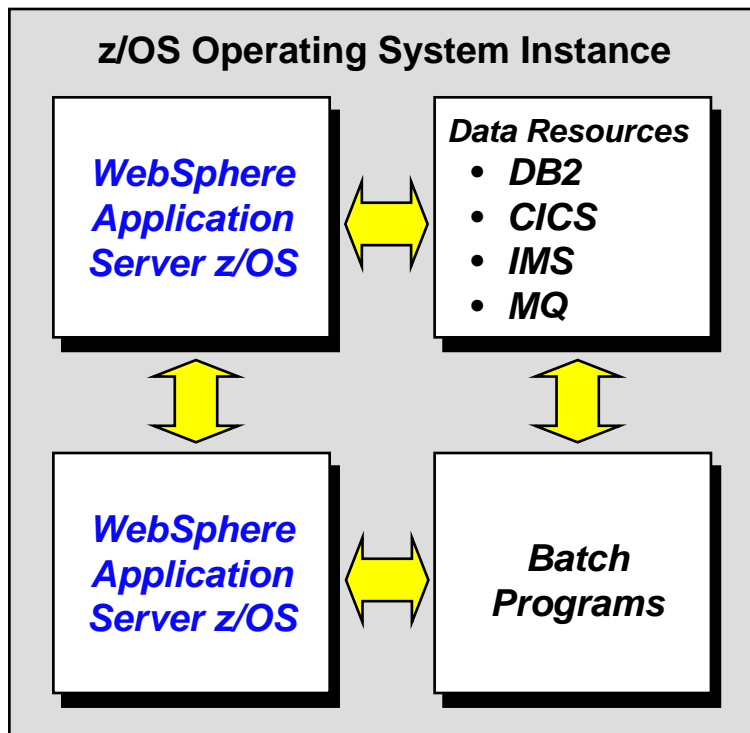

- ***Extremely* fast data transfer**
- **Tightly controlled by z/OS authorization processes**
- **Eliminate need to serialize and deserialize data and objects**
- **Eliminate need for encryption overhead**
- **Propagate several forms of user identity**

Efficient -- very low overhead so scalability can be addressed

Secure -- no network, can't be sniffed or hacked

Fast -- for very high volume workloads



Example: Leveraging Vendor EJB Solutions from Batch

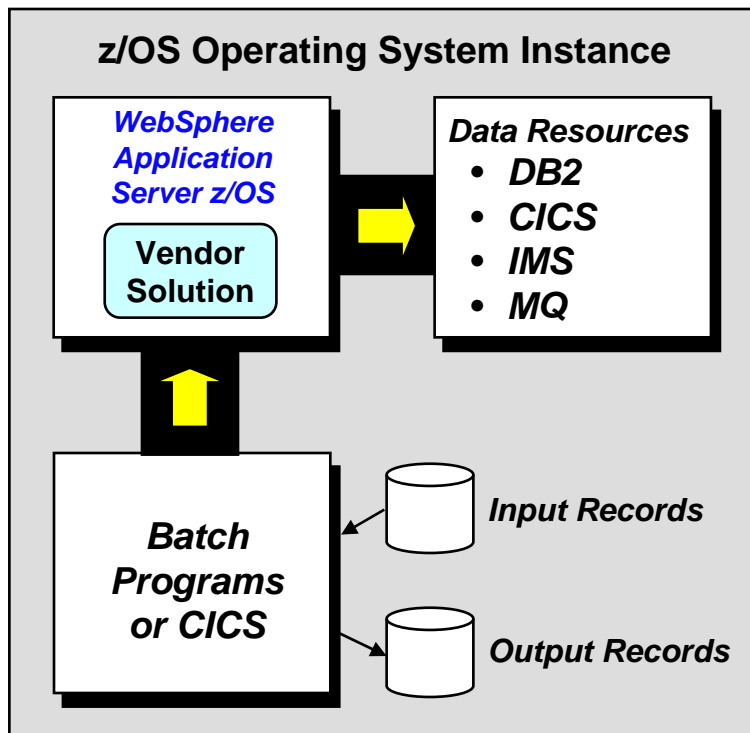

- Increasingly we see ISVs creating solutions using Java EE EJBs
- Challenge becomes how best to drive *into* WebSphere Application Server to take advantage of vendor solutions
- **WebSphere Optimized Local Adapter (WOLA) -- z/OS exclusive -- an extremely efficient bi-directional cross-memory mechanism**

Advantages:

- Very low overhead
- Very high throughput
- Exploit data assets in DB2, CICS, IMS or across MQ using their local connectors
- Maintain transaction integrity with RRS

Leveraging the platform's capabilities to address your business needs



Collocation, Scalability and High Availability

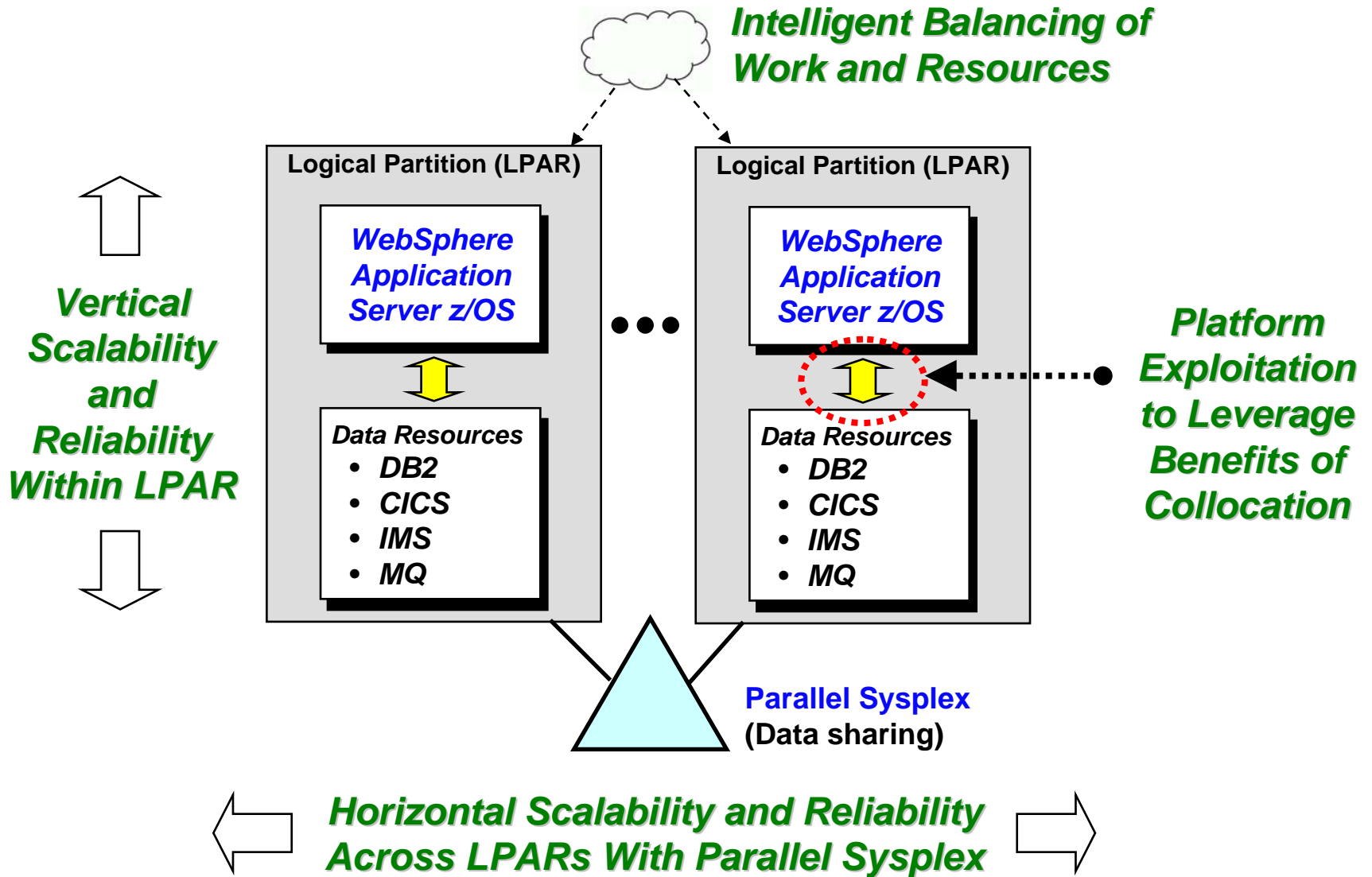



Building Up Solutions -- Leveraging the AppServer

We call these “stack products” -- solutions that use the power of WebSphere Application Server as its base. Example: “Compute Grid”

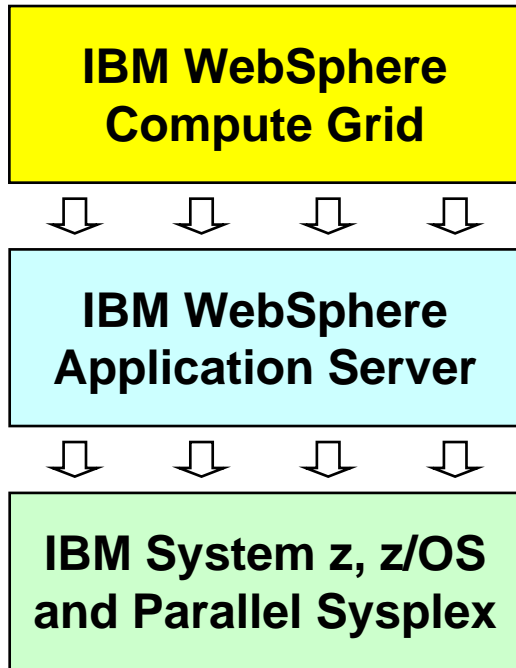

Challenge:

Perform business critical batch processing using Java and enterprise data located on the mainframe

What we've seen:

The challenges of enterprise batch quickly overwhelm simple Java batch solutions:

- Checkpointing and restarts
- Job suspend and restart
- Clustering and dividing work across servers
- Development tooling to support all this

Solution:

IBM WebSphere Compute Grid

- Enterprise-strength Java batch environment
- Supported with batch development tooling
- Makes full use of WebSphere Application Server z/OS features

The challenges of Java batch addressed with IBM solution that exploits WebSphere Application Server, which as we've seen exploits System z and z/OS



Mainframe Software is Expensive?

We did a benchmark¹ comparing three different BPM solution use-case scenarios -- distributed, different LPAR, collocated same LPAR:

3-Year Total Software Cost Comparison Summary

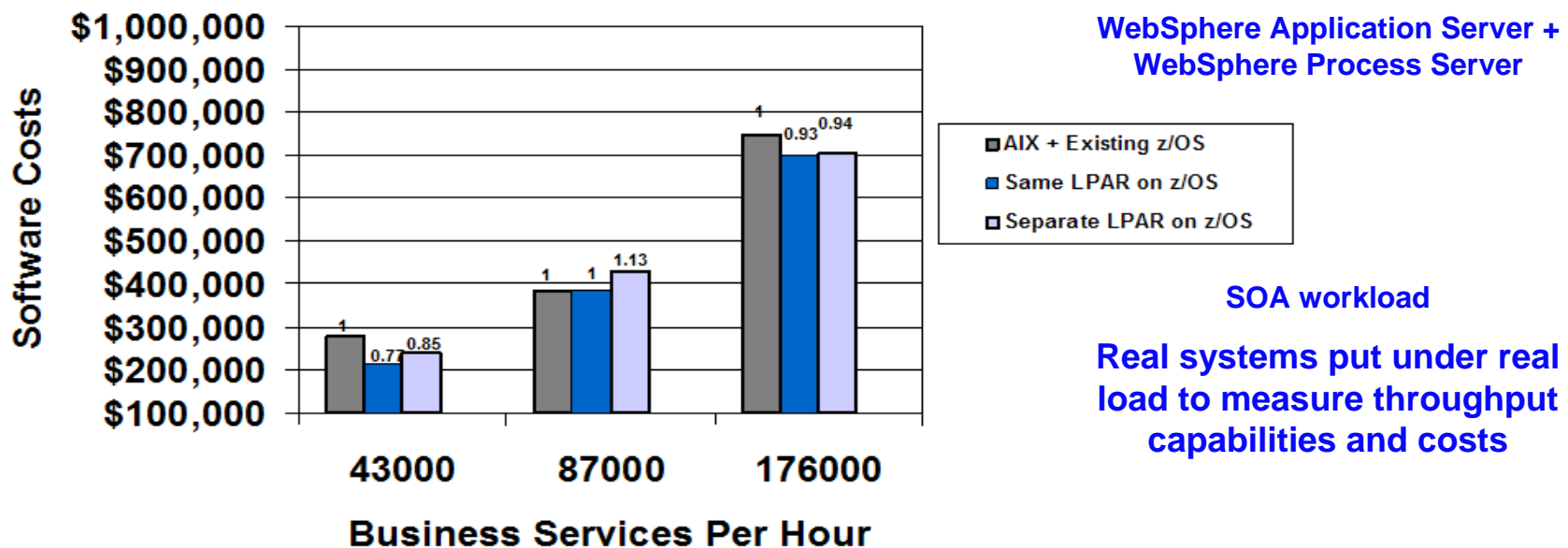

To achieve the same level of business services per hour, the total software cost is less when the solution is collocated with data on System z and z/OS

¹ <http://www.ibm.com/software/tivoli/systemz-advisor/2009-11/websphere-for-zOS.html>



Not *Just* About Technology



That's not how IBM approaches things

The B in IBM stands for "Business," and that means a focus on *results* ... not just technology

Technology is merely a tool; meeting your business goals is the true objective of this



Summary -- Integrated System, Active Exploitation

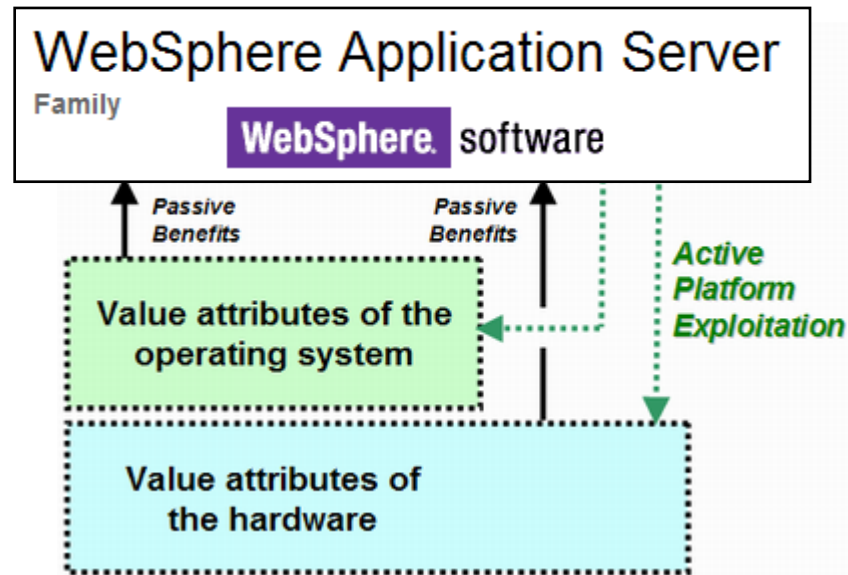

Hardware designed to be reliable and scalable

z/OS operating system tightly integrated with hardware

WebSphere Application Server for z/OS designed to exploit the platform

Efficient use of assets, optimized costs, flexible and agile because of open standards and common tooling across platforms

System z + z/OS + WebSphere Application Server

Impact 2010 Highlights

Impact 2010 - The Premier Conference for Business and IT Leaders

Discover new innovative ways to work smarter and achieve business agility now. Impact 2010 provides a unique setting to bring company executives and technologists together at a single event providing a unique opportunity for them to discover how to align business objectives with IT, interact with technology and business leaders and experts from around the world and ultimately optimize their business performance and results.

A new Business Program that will focus on:

- **optimizing business processes**
- **improving decision management**
- **empowering the changing workforce, and globalization**

An enhanced Smart SOA and BPM Technology Program:

- **Dedicated with tailored workshops and hands on labs**

A bigger focus on your industry!

- **300+ industry leading experts on site**

A new Interactive Symposium

- **Bringing LOB and IT together in consultative sessions**

A new Product Technology Center offering:

- **Open labs, tech zones, and product demos**

A new and improved Track structure with:

- **200+ client speakers, 50 Birds of a Feather sessions, & free certification testing**

A state-of-the art Solution Showcase Center!



Join us in Las Vegas
The Venetian Hotel
May 2 to 7, 2010

www.ibm.com/impact



Let's Build a Smarter Planet on System z

