



IBM Software Group

What is Asset Analyzer?

Overview of WSAA, RAA and Next Generation Tooling

Rational. software

[→ Go to IBM](#)

Rational Asset Analyzer V5.5

Architectural View

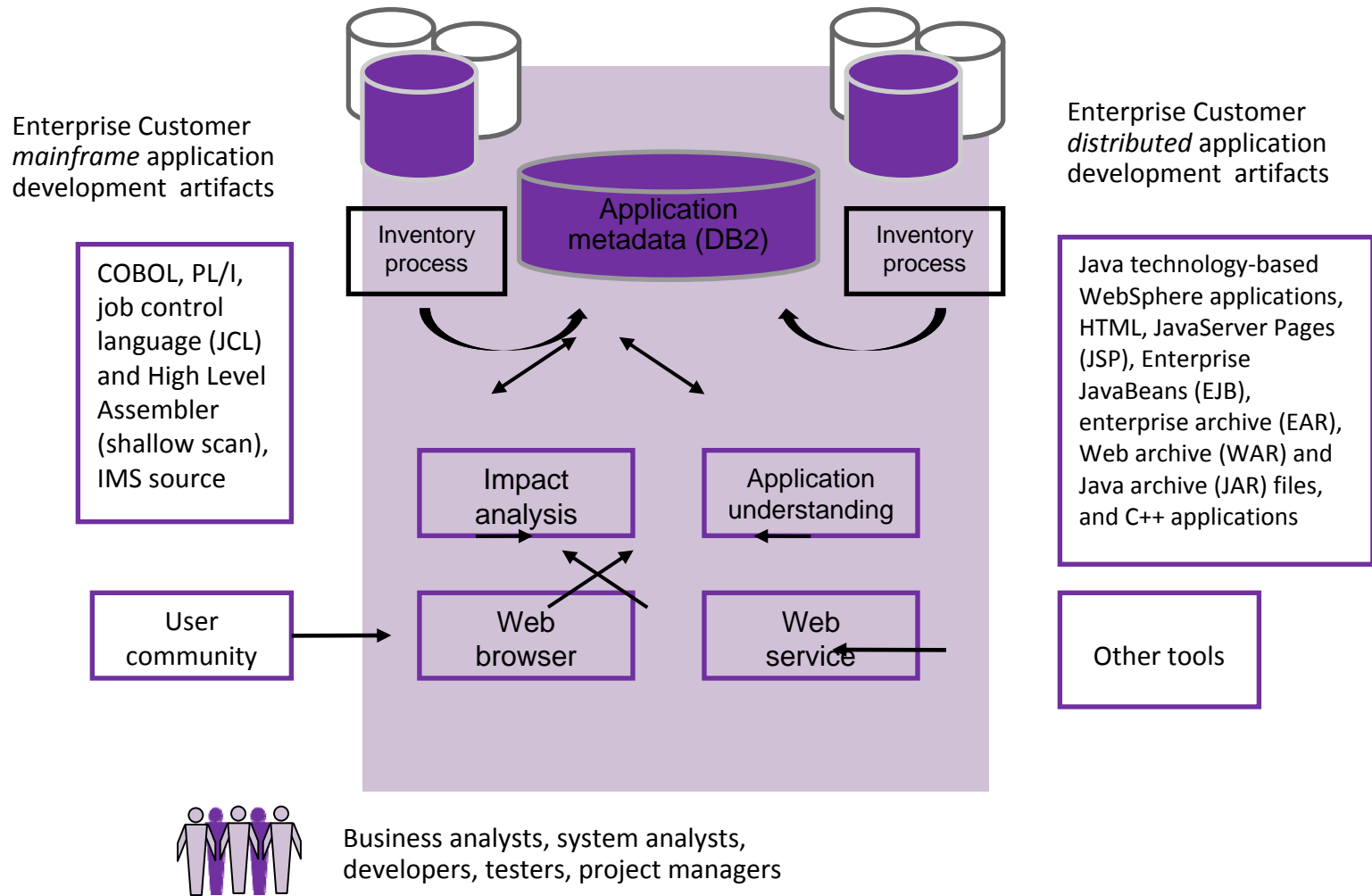

Asset Analyzer is useful to:

- Managers: Application governance,
- Analysts: Change analysis, project estimation
- Developers: program understanding, data flow analysis
- Testers: Test planning
- Everyone: Application understanding, component relationships

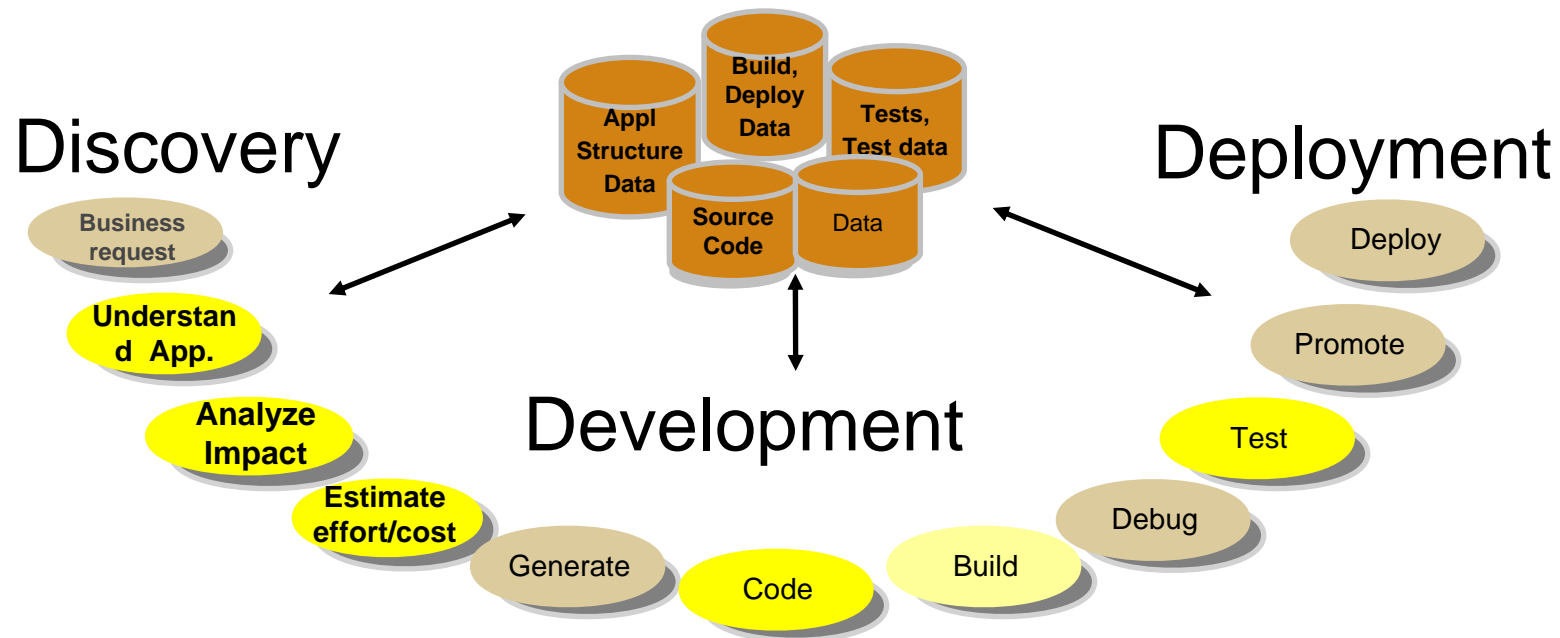

Why Rational Asset Analyzer?

- **Accelerate project delivery in response to business drivers**
 - Reduce risk
 - Increase productivity
 - Improve quality of application changes
- Gain **intellectual control** of applications
- Gain **transparency** into outsourced development
- **Customize** RAA to organizational processes and IT environments



Counts & Metrics

Gain control of your assets & know what you have

- Identify the **breadth of technologies** currently used in the enterprise – using a dashboard or report view
- Understand the **quality and complexity** of your assets
- Use the Errors view to **identify missing resources**
- Error rate is an indication of **validity of data**; also includes tools to help reduce the error rate

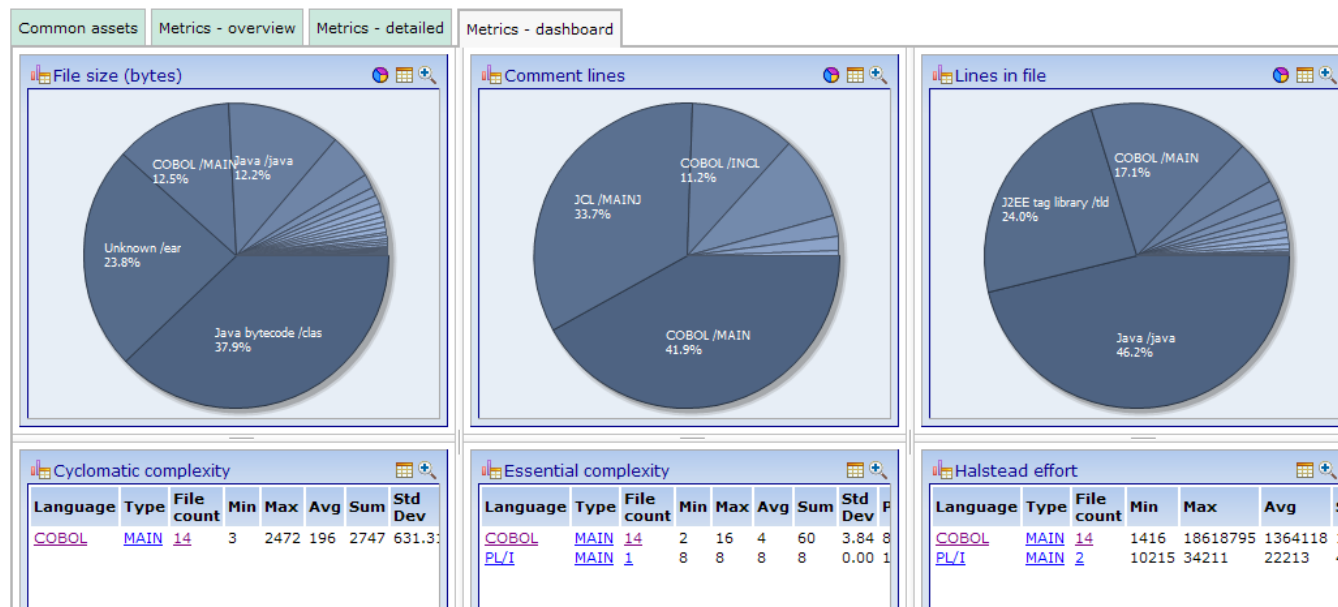

End to End Impact Analysis

Reduce time to market & risk of downtime by understanding change impact upfront

- Reduce time to determine **scope of change** whether for new enhancements, or even maintenance efforts
- View the metrics for impacted artifacts to determine the **risk of change** i.e. cyclomatic complexity, lines in file, etc.
- Traverse user-defined relationships to determine **impacts across platforms** i.e. follow dependencies from mainframe to J2EE and back.
- Create a “**bill of materials**” of impacted artifacts by evaluating the details page

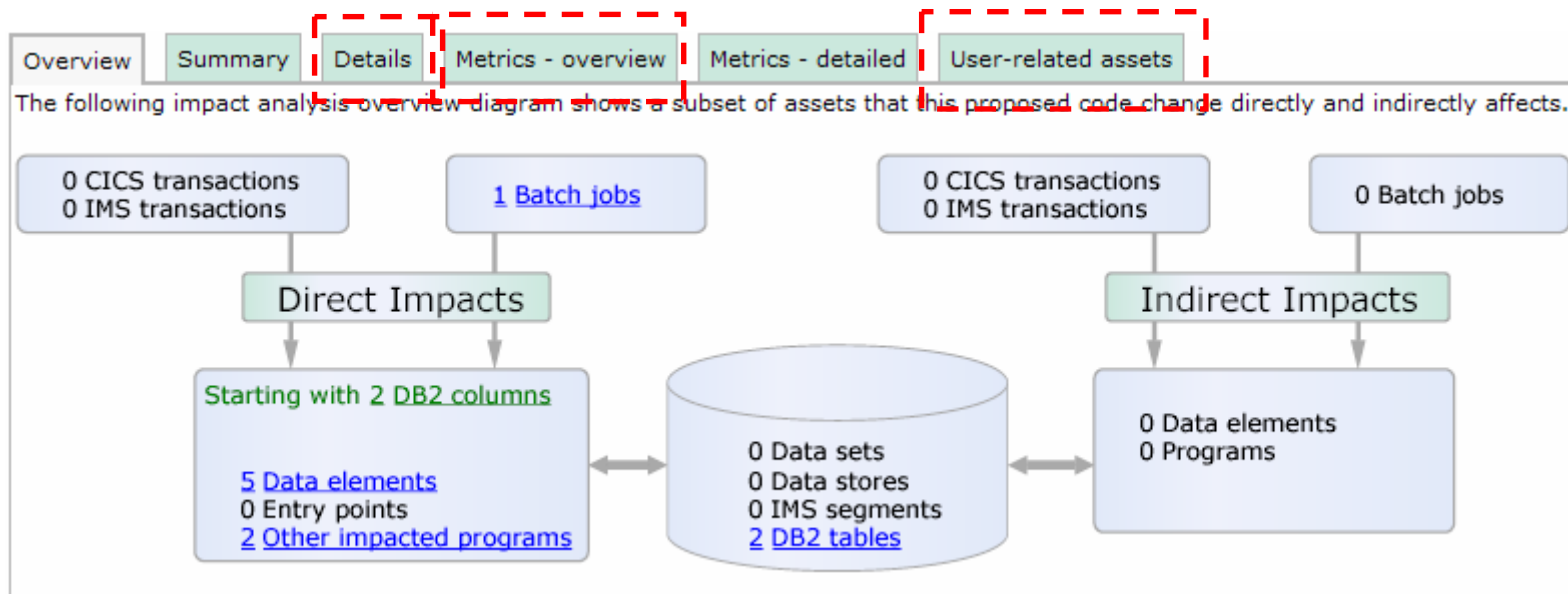

Application Understanding

Quickly understand code with little or no documentation, and relationships across the enterprise

- Group artifacts into **user-defined groups** called Applications to limit scope to area of interest
- Use **various types of diagrams** for understanding how the application “hangs together”
- Use **annotations** to capture knowledge from SMEs e.g. Business function, description, etc.
- Create **user-defined relationships** for situations where relationships cannot be determined through static analysis
- Perform **enterprise-level keyword searches**

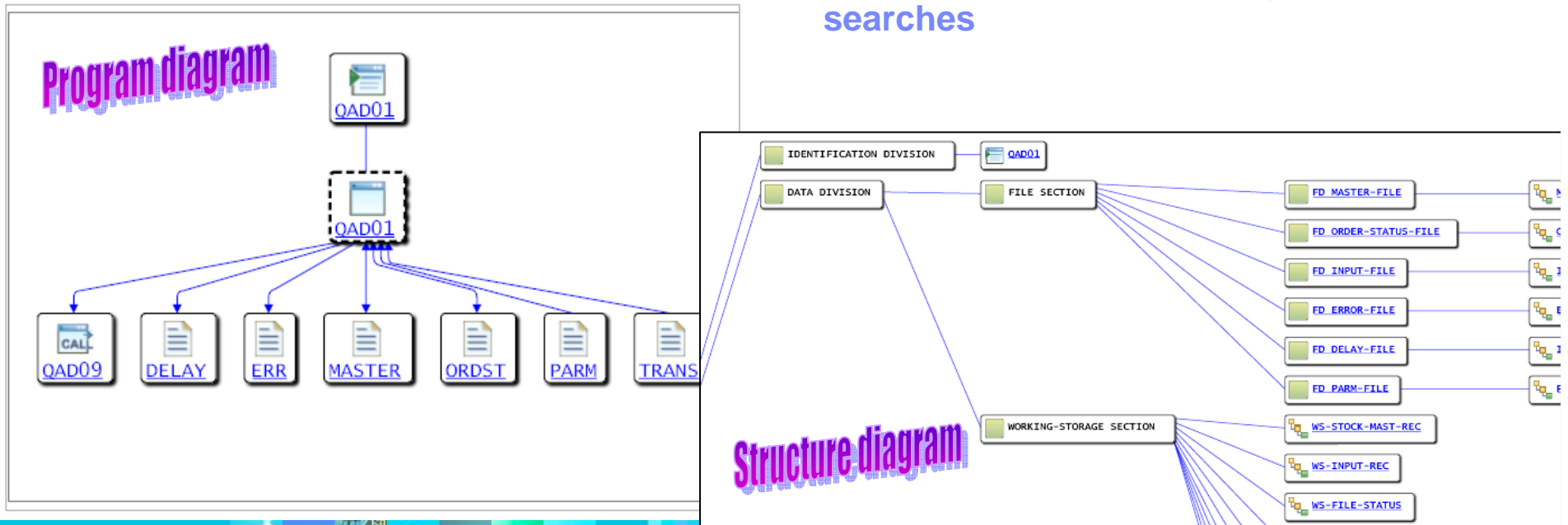

Extensible Framework

Tailor RAA to your organization's needs

- Access RAA's wealth of information using standard **web services**
- Easily add the support for languages not currently supported using RAA's documented **import file** format
- Extend RAA with **user-defined metrics & counts**
- Create **custom queries**, and optionally include them as actions on pages
- Combine RAA information to your pages using RAA's **REST interface** in support of Web 2.0

Database Tables, by name

The DB2 tables created by **Published Database Schema** in alphabetical order. Not all of the tables are displayed at this time. These tables are for reference only and are subject to change. They do not constitute a programming interface.

Table name	Type	Model	Submodel
DMH_ACTIVITY_LOG	Table	System	Activity log
DMH_ACTUAL_PARM	Table	Logical assets (MVS)	Compile unit parameter
DMH_ANALYSIS_QUEUE	Table	System	Analysis queue
DMH_APPLICATION	Table	System	Application
DMH_APPL_CLOSURE	Table	System	Application
DMH_APPL_CMPNT	Table	System	Application
DMH_ARCHIVE	Table	Logical assets (Distributed)	Archive

Import file description

The input file, which must reside on the server machine, is a text file with fixed format records. Each record contains an identifying record type followed by one or more attribute fields (separated by at least one space).

For the import process to work correctly, the order of the text file records is important. The following lists outline the appropriate order for these records:

Record type: identifies

- **FMT**: the import file's format
- **TOOL**: the import file's origin
- **SITE**: the site (or server) name to associated with any subsequent import records
- **APP**: the Application owner for components that follow
- **LIBR**: a container
- **MEMB**: a file
 - **ATTC**: a character attribute
 - **ATTN**: a numeric attribute
 - **incl** (format 1): identifies an included source file
 - **msg**: identifies the text of a message



RAA enhances value of other tools

- **Rational Developer for System z (RDz)**
 - *Combine productivity gains of RDz with the enterprise-level insight in RAA to minimize time-to-market and minimize risk due to lack of visibility into impacted artifacts*
- **Rational Asset Manager (RAM)**
 - *Use RAA to identify artifacts/assets of interest, then use RAM to publish those assets for reuse, and manage/govern the development process around changes to those assets. That is, jumpstart RAM deployments for a quicker ROI.*
 - *Use RAA to perform deeper level analysis for change requests coming in to RAM.*



Scalability

The ability to start small and scale up to enterprise-wide usage

- RAA is built on the **highly scalable** Websphere Application Server and DB2 products
- WSAA (the sister product) has a **proven track record** as it has been deployed across many enterprises
- Since RAA is browser-based, **administration costs are minimized**
 - *Client machines do not need to be managed*
 - *Scaling up is as simple as giving additional users access*



Example of one WSAA deployment:

300+ internal projects are changing code and data formats

140K batch jobs and 200K programs, 126K DB2 columns, 81M data elements, 177M LOC



z/OS inventory collection overview

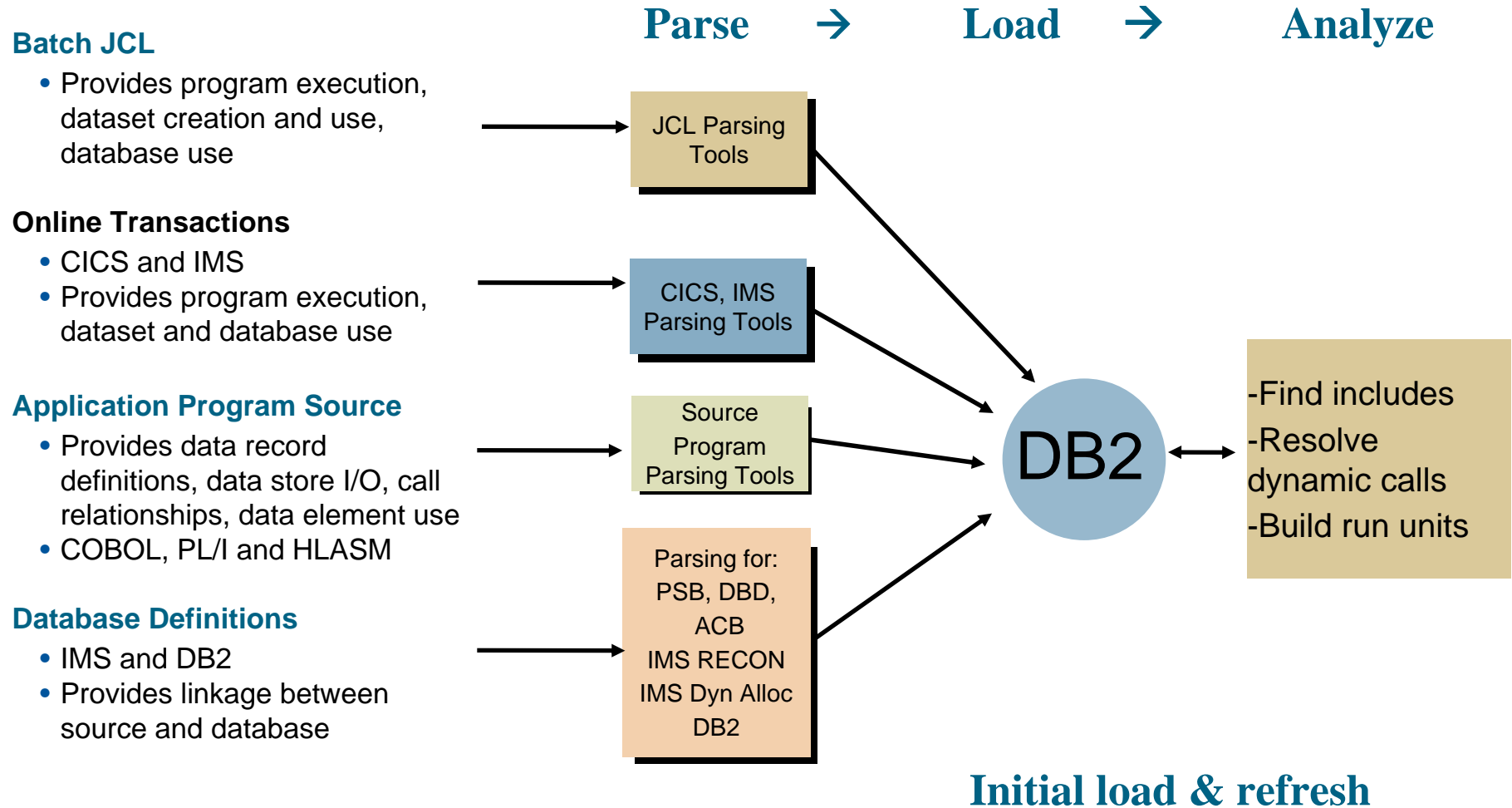

Inventory collection for distributed assets

- Rational Asset Analyzer scans the distributed assets you specify, storing asset information in a DB2 database.
- Inventory information is collected for:
 - ▶ Java assets
 - ▶ Web assets
 - ▶ J2EE assets
 - ▶ WebSphere Application Server topology
- Assets can be scanned from:
 - ▶ Hierarchical file systems (both local and remote)
 - ▶ WebSphere Application Server V5 and V6 installations running on Windows or AIX
 - ▶ ClearCase, CMVC, CVS, and PVCS



Distributed inventory scanning overview

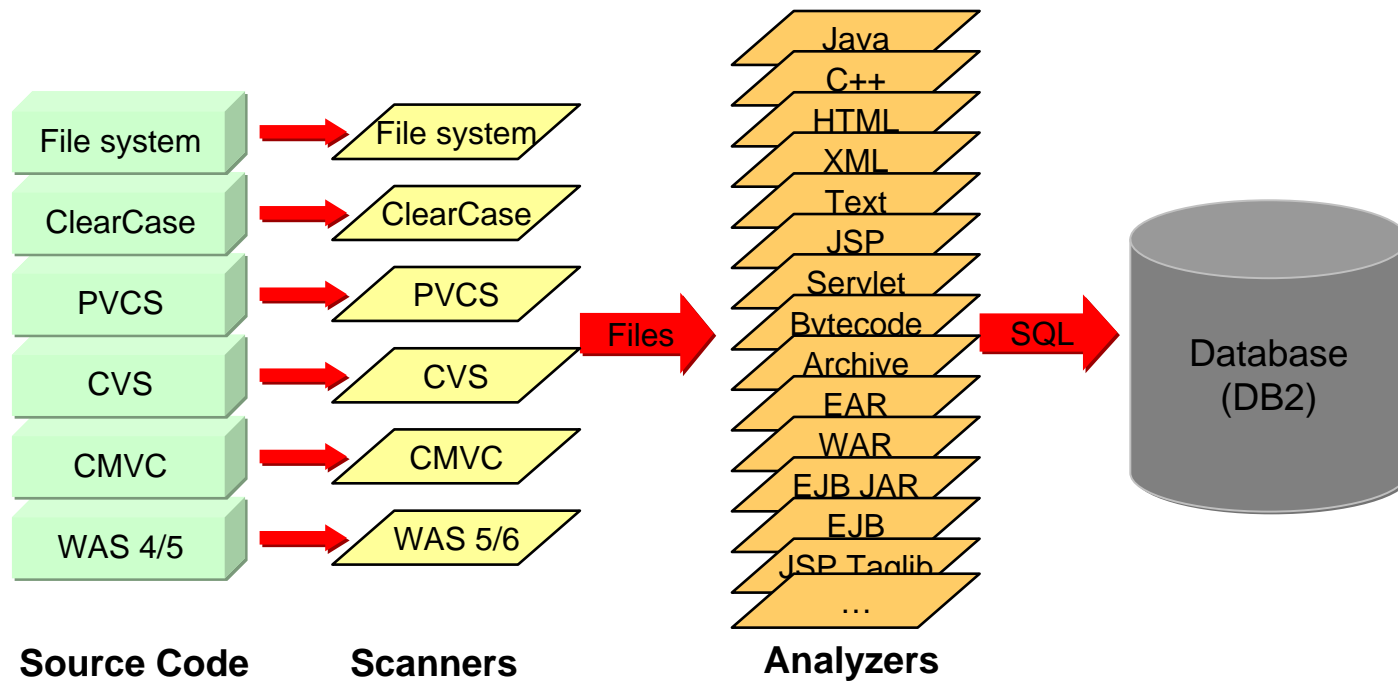

Explore

Use the Explore function to view application components and their relationships

- Search for components by:
 - ▶ Name and name patterns
 - ▶ Attributes
 - Type, length, etc.
 - Application, site,
- View counts, lists, and detail pages
- Follow links to navigate through an application, answering questions such as:
 - ▶ What program is invoked by a batch job or CICS transaction?
 - ▶ What subroutines are called?
 - ▶ What files are used?
 - ▶ Which EJBs are used by a WebSphere Application Server application?



Tools

- **Bookmarks**
 - ▶ Bookmark and name any page in the user interface for later access
 - ▶ View your own bookmarks or access those created by others if you are a WSAA administrator

- **Custom Queries**
 - ▶ Develop custom queries to access and report on any metadata gathered by Rational Asset Analyzer
 - ▶ Name and associate queries with specific users
 - ▶ View your own custom queries as well as those created by others if you are a WSAA administrator
 - ▶ Results of running custom queries are presented in a Details page



Back up charts



“Editions” of Asset Analyzer

WSAA – WebSphere Studio Asset Analyzer

- System z-centric , pre-reqs DB2 on System z, WAS on System z, Windows, AIX
- WSAA V5.1 latest supported release (GA March 2007)

RAA – Rational Asset Analyzer

- Windows only, simple install, packaged pre-reqs
- RAA V5.5 GA July 31, 2008

Ultimately, Asset Analyzer technology aims to provide application intelligence metadata for Rational’s APM solution → Rational Application Intelligence



WebSphere Studio Asset Analyzer

Architectural View

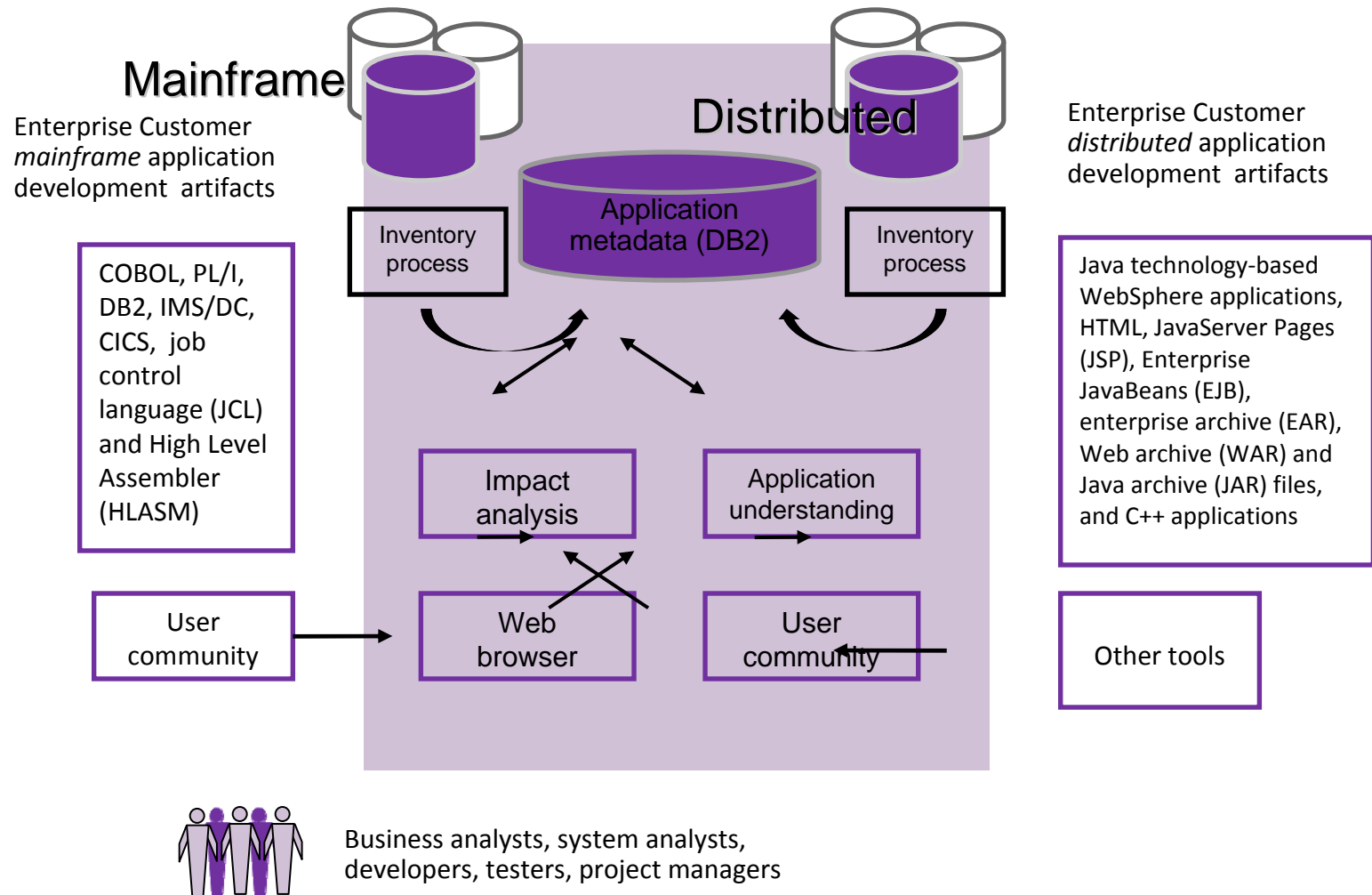

Business analysts, system analysts, developers, testers, project managers



What is RAA?

- A sister product of WSAA
 - Based on proven WSAA technology
 - Support for the same languages/subsystems as WSAA
- Features similar to WSAA:
 - Windows-only solution
 - Ideal for small teams, quick ramp-up time
 - Supports System z and distributed source
 - Scans on the workstation
 - Client-server architecture, shared repository
- Additional Features:
 - Dashboards for counts & metrics
 - Ability to control depth of inventory scanning
 - Very fast directory scans to gather counts & metrics quickly
 - Eliminates need for DB2 on System z
 - RESTful API (documented in External Interface Guide)



What is WSAA?

- Browser-based tool to accelerate the discovery and analysis phase in any new projects or maintenance efforts
- Support for System z, enterprise wide software applications
- Scans source “where it lives”
- Proven technology running on System z, Windows and AIX
- Assists in the development and test phases to identify impacts across the enterprise and identifying areas to test, thereby reducing risk and improving test coverage
- Identifies relationships among the artifacts
- Gathers metrics, counts related to the IT artifacts in the enterprise
- Provides a browser-based interface to search, explore and report on the gathered information



RAA Future – Rational Application Intelligence

- RAI = RAA 5.5 + WSAA 5.1 + services on Jazz Platform
- Brings full capabilities for enterprise application understanding and analysis
- Offers multiple configurations: System z, Windows [AIX, Linux]
- New features include:
 - ▶ Business Rules Management Framework
 - ▶ Application Dependencies and Relationships
 - ▶ Support for additional languages: .NET, ABAP, Natural, EGL under consideration
 - ▶ Open framework for third-party scanners via import file
 - ▶ Integration with RDz
 - ▶ Integration with RTC
 - ▶ Customizable/configurable dashboard framework for metrics
 - ▶ Ability to define user roles for customized views of information

