



System z Is Optimized For Critical Data Workloads

**The New zEnterprise –
A Cost-Busting Platform**

Business Depends On Critical Data

Run the business

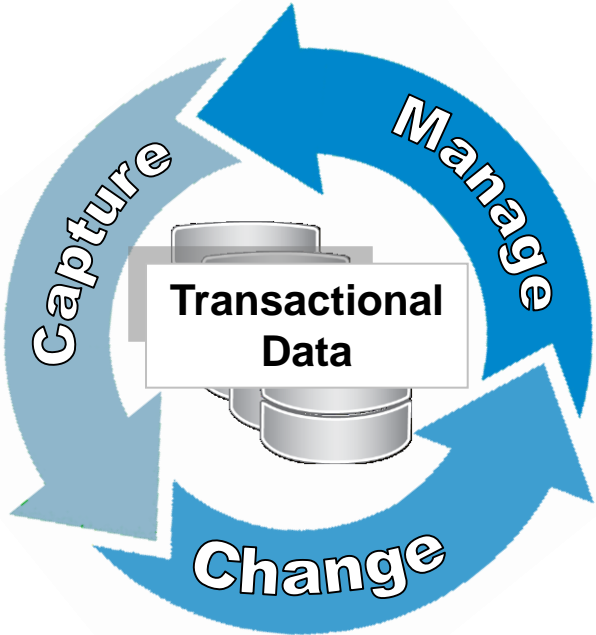

Accounts
Orders
Inventory
Reservations

Grow the business

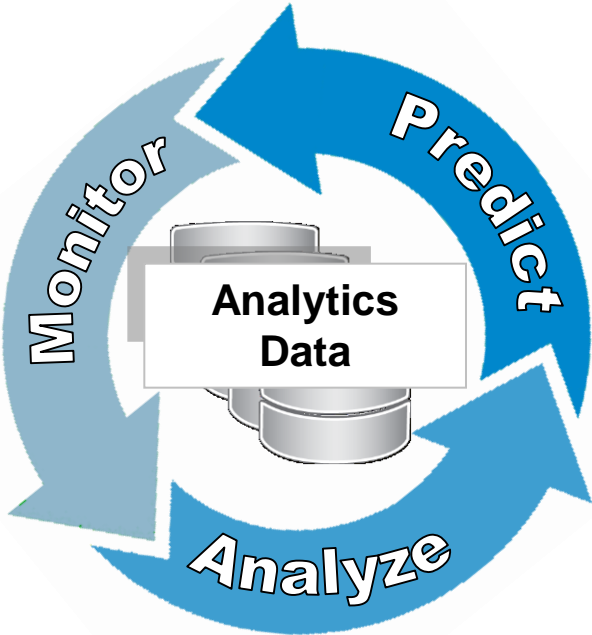

Sales
Order history
Inventory changes
Historical metrics

What Workloads Should Be Run On System z?

- Global Scale Transaction Processing
- Critical Data Workloads
- Large Scale Batch Processing
- Co-located Business Analytics

IBM zEnterprise System Is Optimized For Critical Data

Run the business

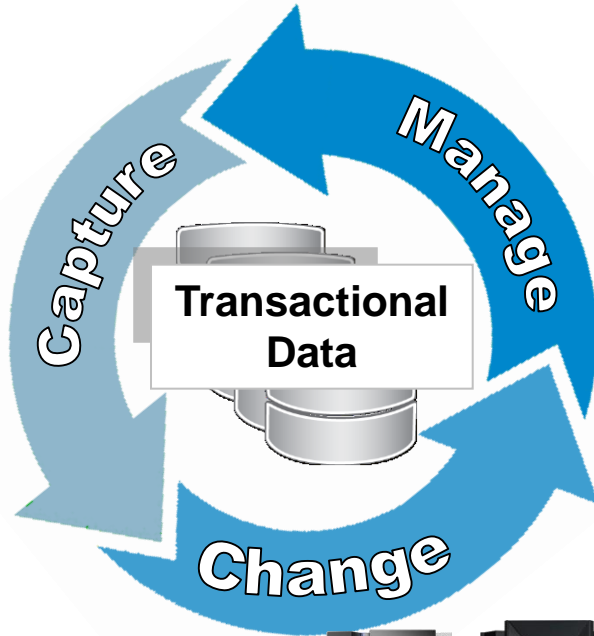

Grow the business

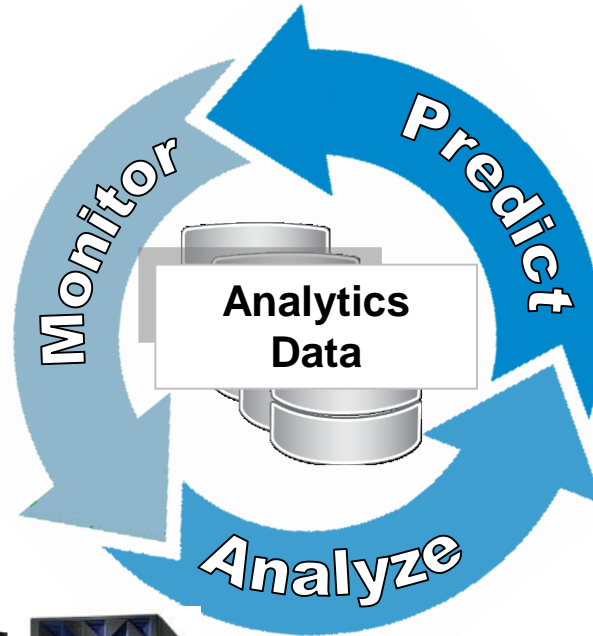

Data integrity
Efficiency at scale
Ultimate security



Operational analytics
Co-located workloads
Workload management

IBM zEnterprise EC12 Is Optimized For Transactional Data

Run the business

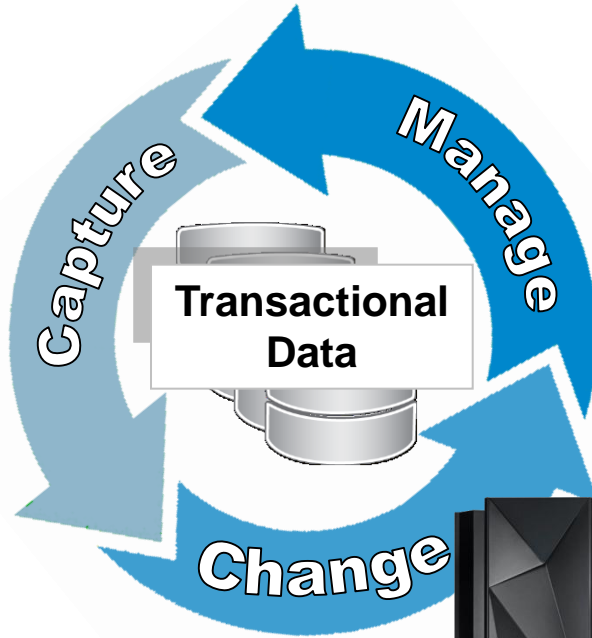

IBM zEnterprise EC12



- Transactional integrity with rock solid CICS, IMS, and DB2
- Unique design for efficiency at scale for both processing and data
- Trusted security and availability

Global Business Requires Transactional Efficiency At Scale

Trusted by the world's top businesses

2/3 of all business transactions for US retail banks run directly on mainframes

DB2 on z/OS runs on

all 65 of the world's top banks,

24 of the top 25 US retailers, and

9 of the top 10 global insurance providers

“Millions of users unknowingly activate CICS every day, and if it were to disappear the world economy would grind to a halt.”

Phil Manchester, Personal Computer Magazine

Transaction Processing Requires A Balance Of Capabilities

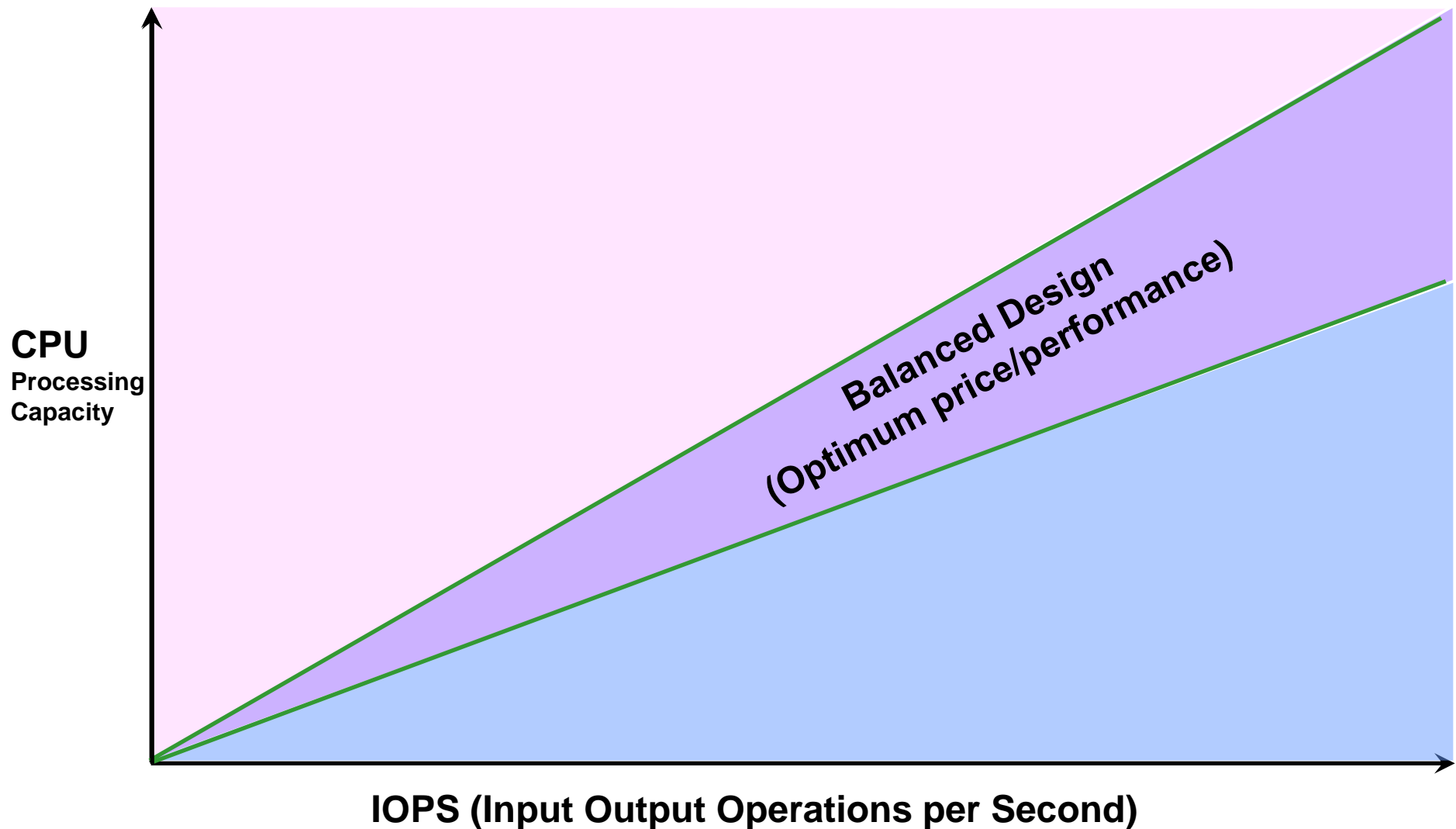

zEnterprise EC12 Design Is Unique And Optimized For Transaction Efficiency At Scale

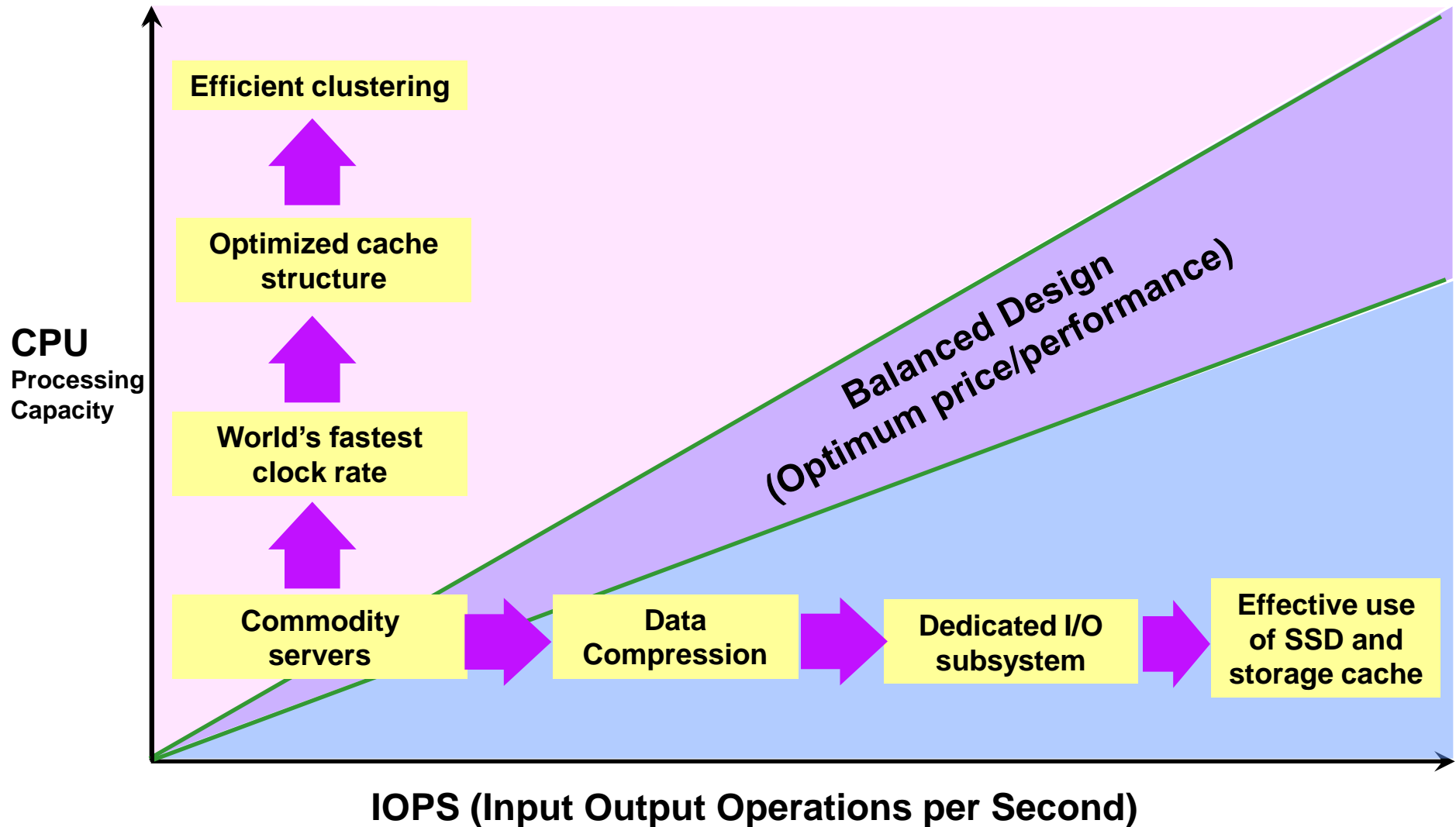

Air-cooled zEC12 Under The Covers

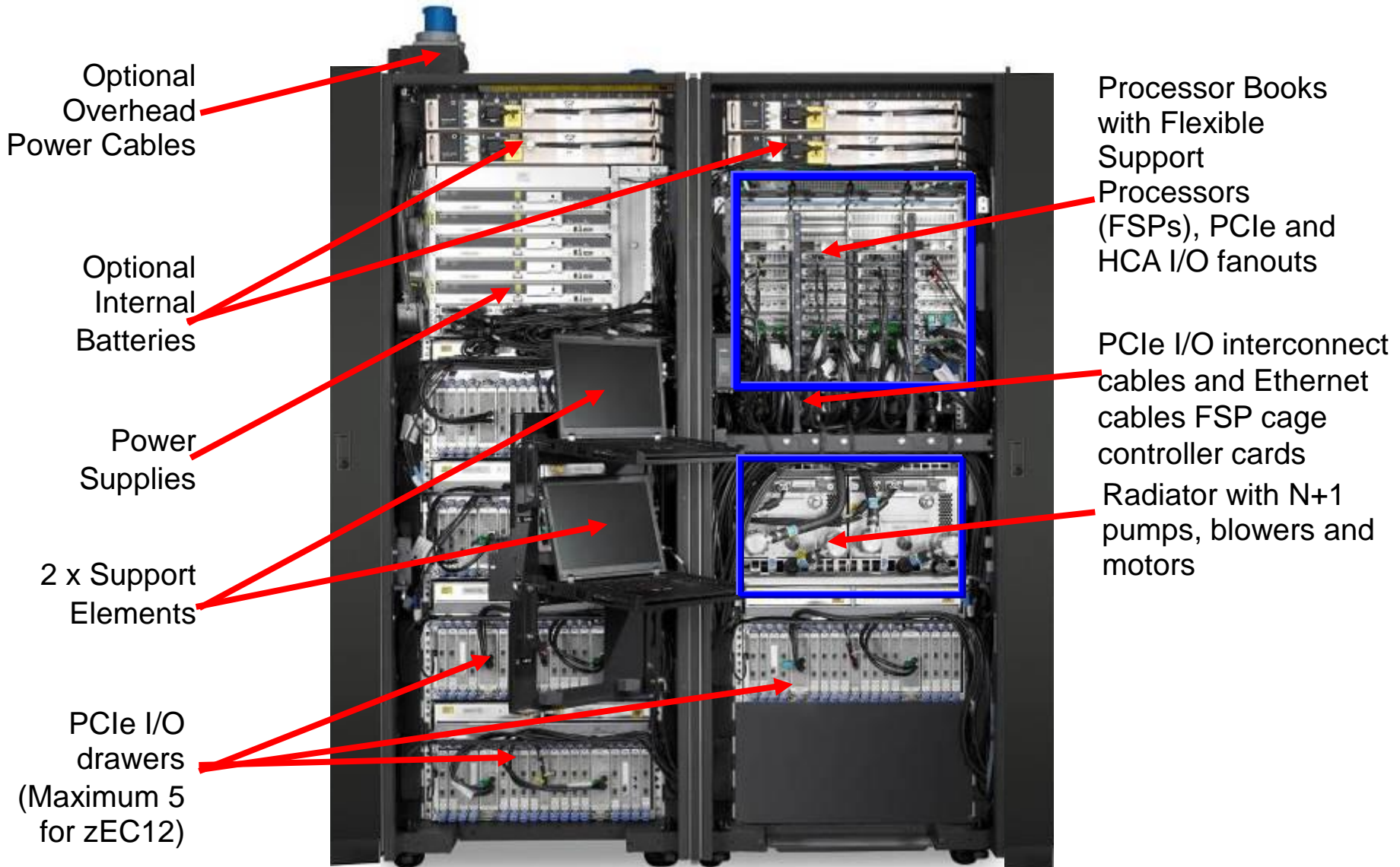

The New zEnterprise EC12 Delivers Unmatched Processing Capacity

- **World's fastest processor**
 - ▶ 5.5 Ghz clock rate
 - ▶ 120 total processors (101 configurable)
 - ▶ 6 cores per chip
 - ▶ Hardware Transactional Memory
- **More cache**
 - ▶ **8MB** on-chip cache/core*
 - ▶ Separate optimizations for instructions and data in L1 and L2 processor cache
 - ▶ On-chip L3 shared cache doubled to 48MB
 - ▶ Total book-shared L4 cache doubled to 1.5GB
- **Large SMP system image**
 - ▶ Over 78,000 MIPS capacity

*6MB previously

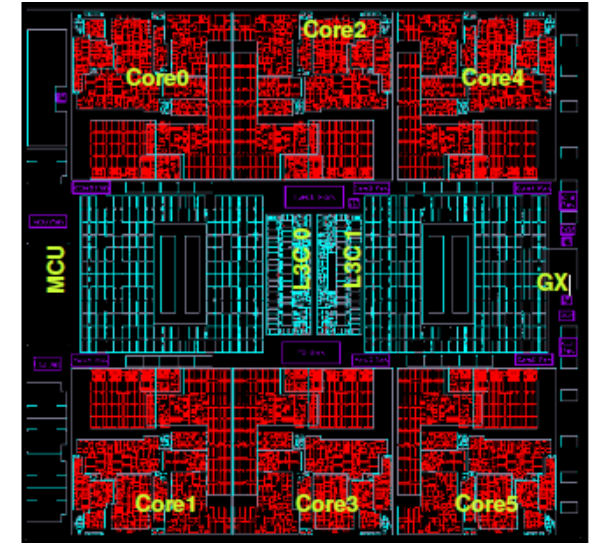

6
cores
per
chip



Continuous Processing Improvements For Transactional Workloads

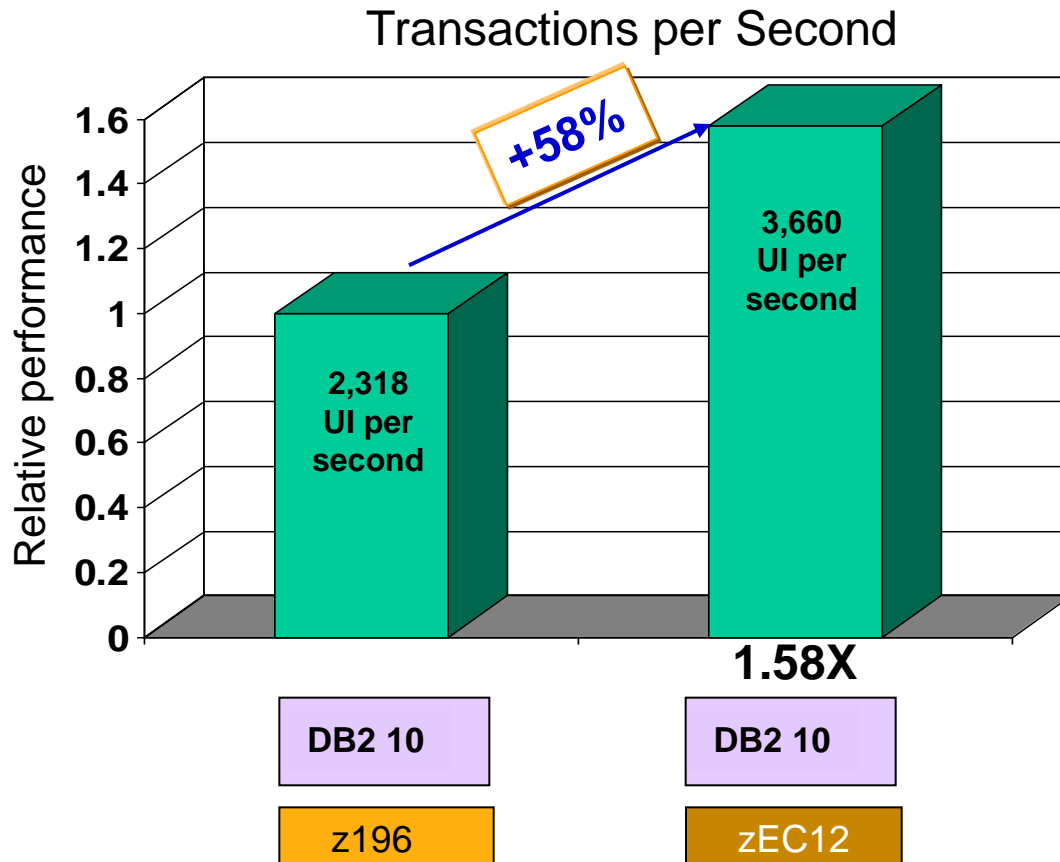

- Faster processors
- More I/O bandwidth due to:
 - ▶ 8GBps PCIe interface
 - ▶ Upgrade to FICON Express8S
- Both using SSDs

Database I/O Intensive Performance Study

Performance measured in User Interactions per second.
z196 results run on GA1. Results may vary.

Continuous Processing Improvements For Transactional Workloads

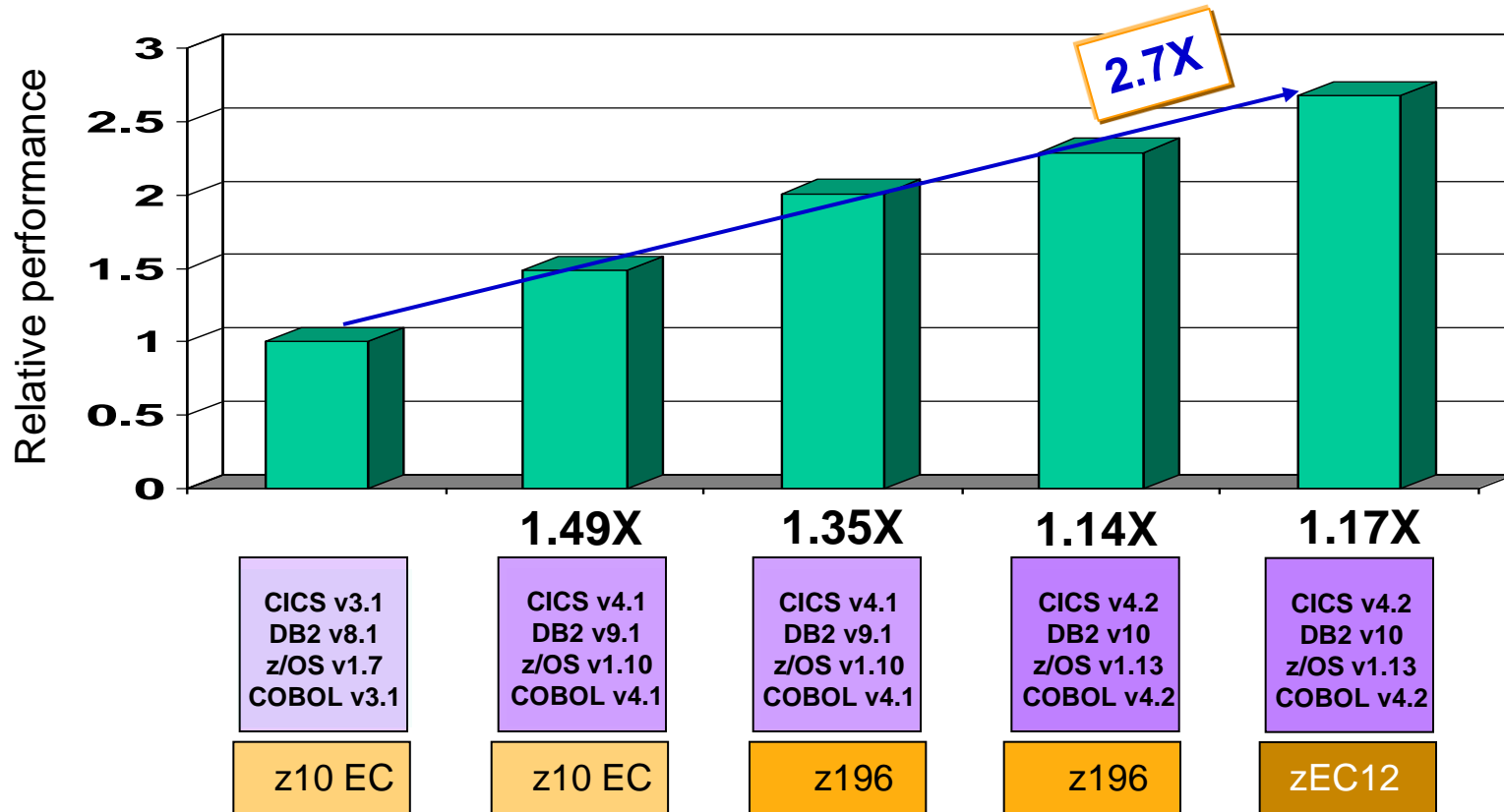

**IBM internal core banking transactional workload
(Friendly Bank)**

Performance measured in User Interactions per second.
z196 results run on GA1. Results may vary.

Continuous Processing Improvements For Transactional Workloads

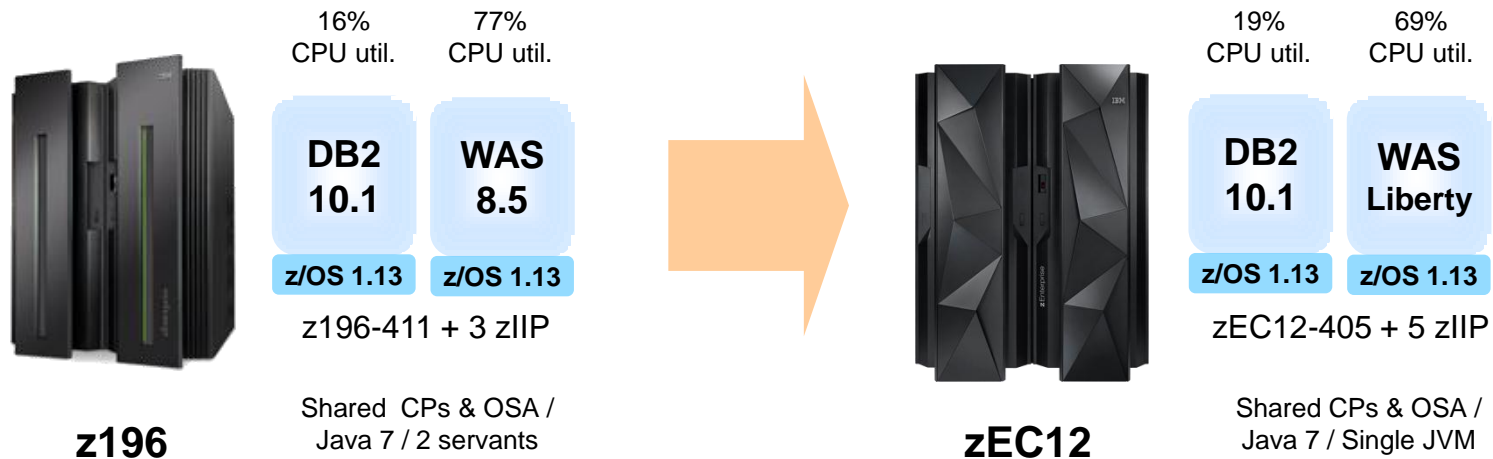

2,240 user interactions per second (UI per sec)

\$2,449 / UI per sec

3,920 user interactions per second (UI per sec)

\$933 / UI per sec

WAS Liberty also exhibited faster startup, smaller memory footprint and reduced response time.

zAAP offload increases from 62% to 97%.

75% more throughput at 62% lower cost

zEC12 Parallel Sysplex Clusters Provide Even More Processing Power

- Specialized hardware - Coupling Facility
 - ▶ Dedicated processor with specialized microcode to coordinate shared resources
 - ▶ High speed inter-connect to clustered systems
 - ▶ Hardware invalidation of local cache copies
 - ▶ Special machine instructions
- Exploited by IMS, CICS, DB2, MQ, and other middleware on z/OS to achieve near-linear transaction processing scale
- **Delivers efficiency at scale**

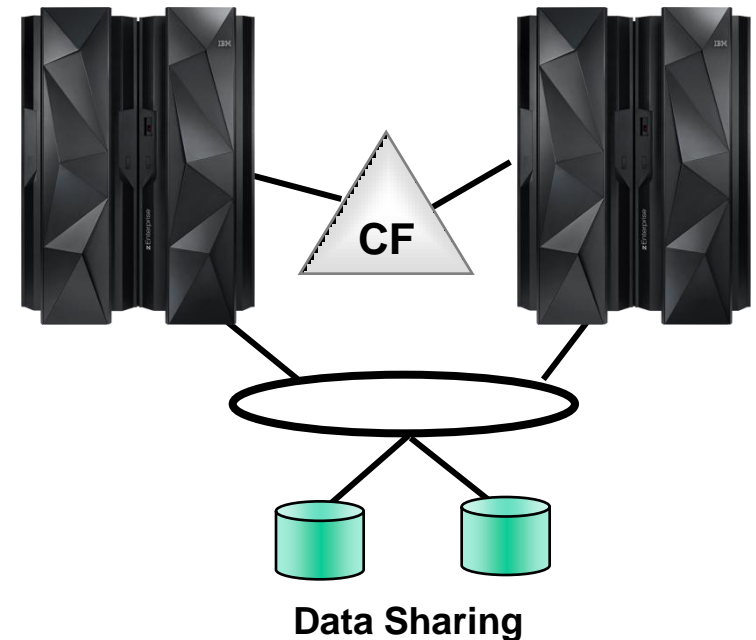

**Cluster up to 32 nodes
for a total of 3,232
configurable cores**

zEnterprise EC12 Delivers Unmatched I/O Processing Capabilities

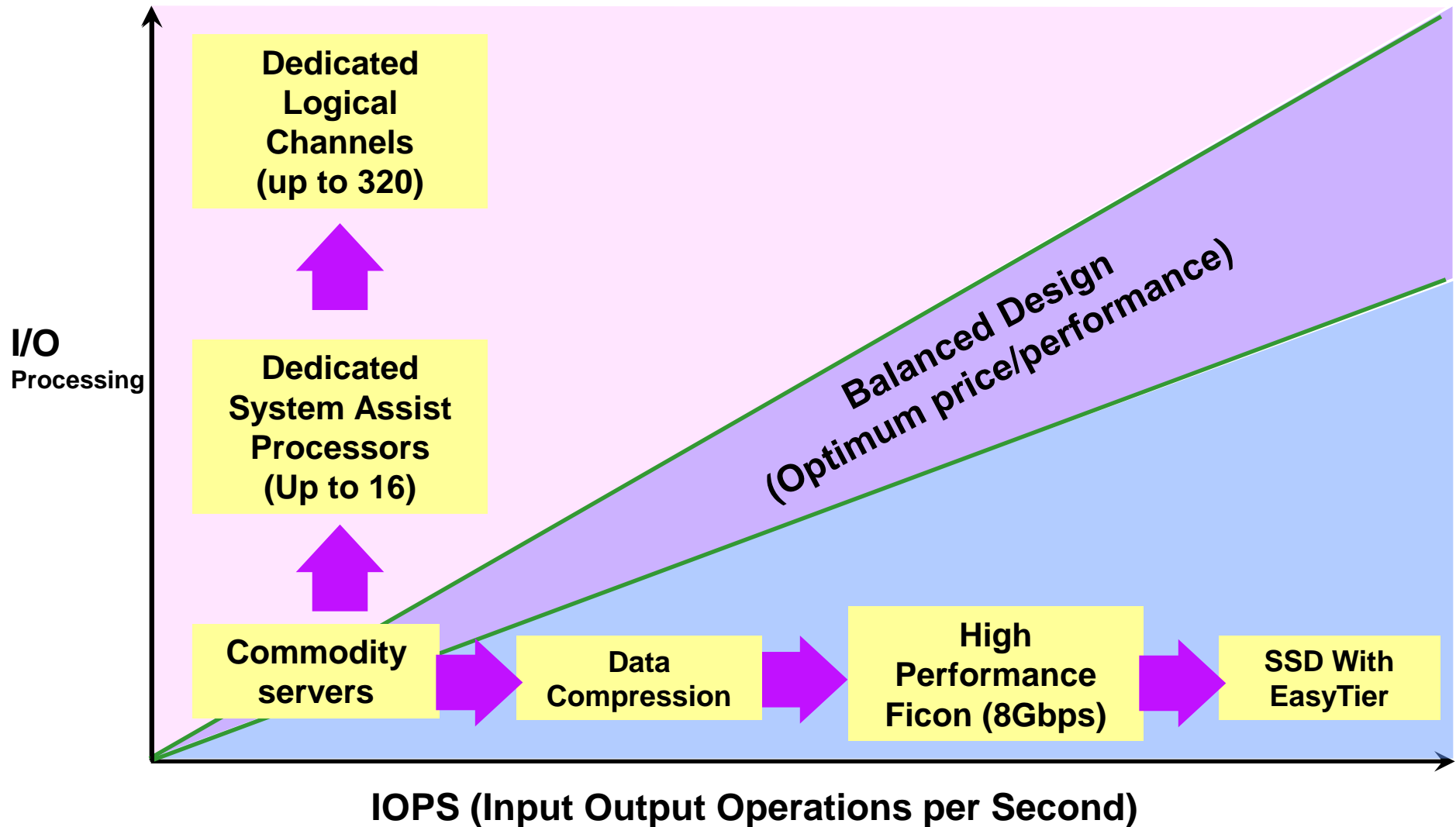

zEC12 Has A Dedicated I/O Subsystem Which Can Deliver 1.7M I/O Operations Per Second

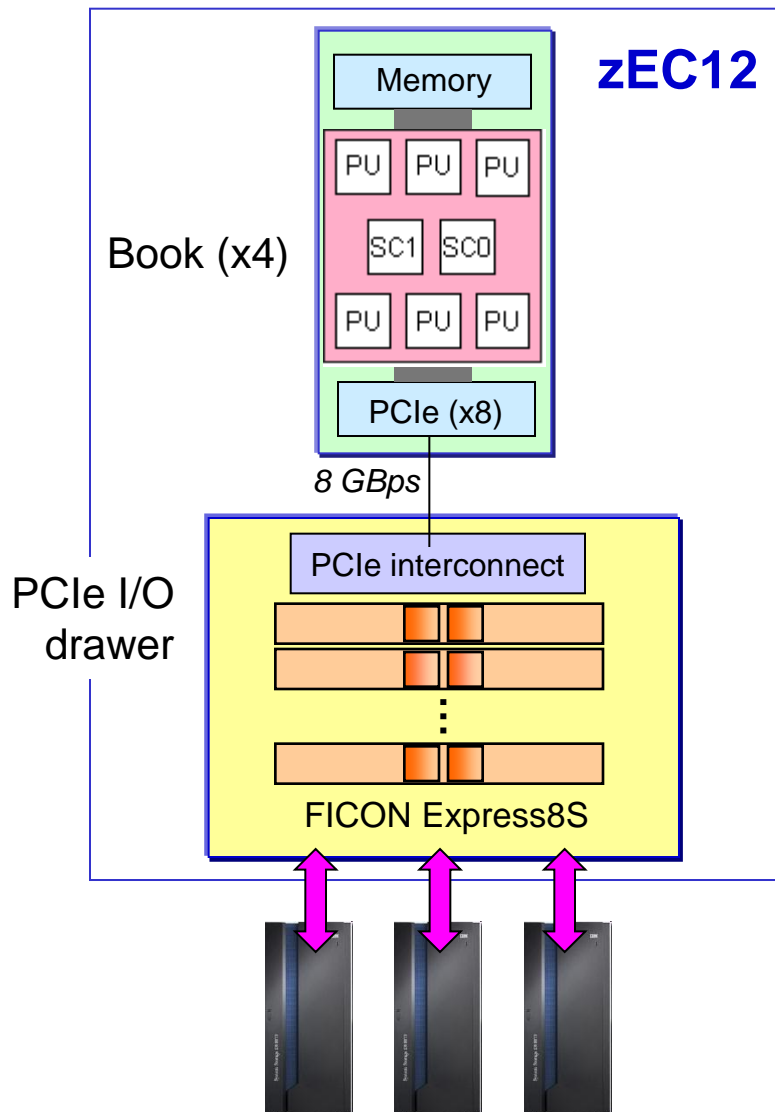

- **Up to 16 dedicated System Assist Processors (SAPs)**
 - ▶ All I/O requests are offloaded to SAPs
 - ▶ Each SAP can sustain up to 2.4M IOPS*
 - ▶ I/O subsystem bus speed of 8 GBps
 - ▶ Number of SAPs increases from 2 to 16 according to system size
- **Up to 160 physical FICON cards for I/O transfers**
 - ▶ Up to 320 RISC processors (2 per card)
 - ▶ Up to 320 FICON channels (2 per card)
 - ▶ 8 Gbps per link, 288 GB/Sec I/O aggregate per zEC12
- **IBM DS8800 Storage System**
 - ▶ Up to 440K IOPS capability
- **Delivers I/O efficiency at scale**

* Recommend 70% max utilization – 1.7M IOPS
Numbers represent High Performance FICON traffic

IBM DS8000 Smarter Storage Is Self-Optimizing To Improve Performance And Productivity

- Easy Tier migrates most frequently accessed data to faster storage
 - ▶ Less frequently accessed data moved to high capacity storage
- Migration based on actual usage
 - ▶ No administrator intervention
 - ▶ No missed hot spots
 - ▶ No application changes needed
- Performance gains up to 11.5x on I/O intensive workloads*



* Note: Based on IBM internal study of Brokerage database workload run on Easy Tier with 95% migration to SSD vs. well tuned baseline running on all HDDs. Performance measurements were specific to the configuration used. Your results may vary. Contact IBM to see what we can do for you.

Transaction Workloads See Up To 9x Throughput Benefit Using SSDs, Automatically

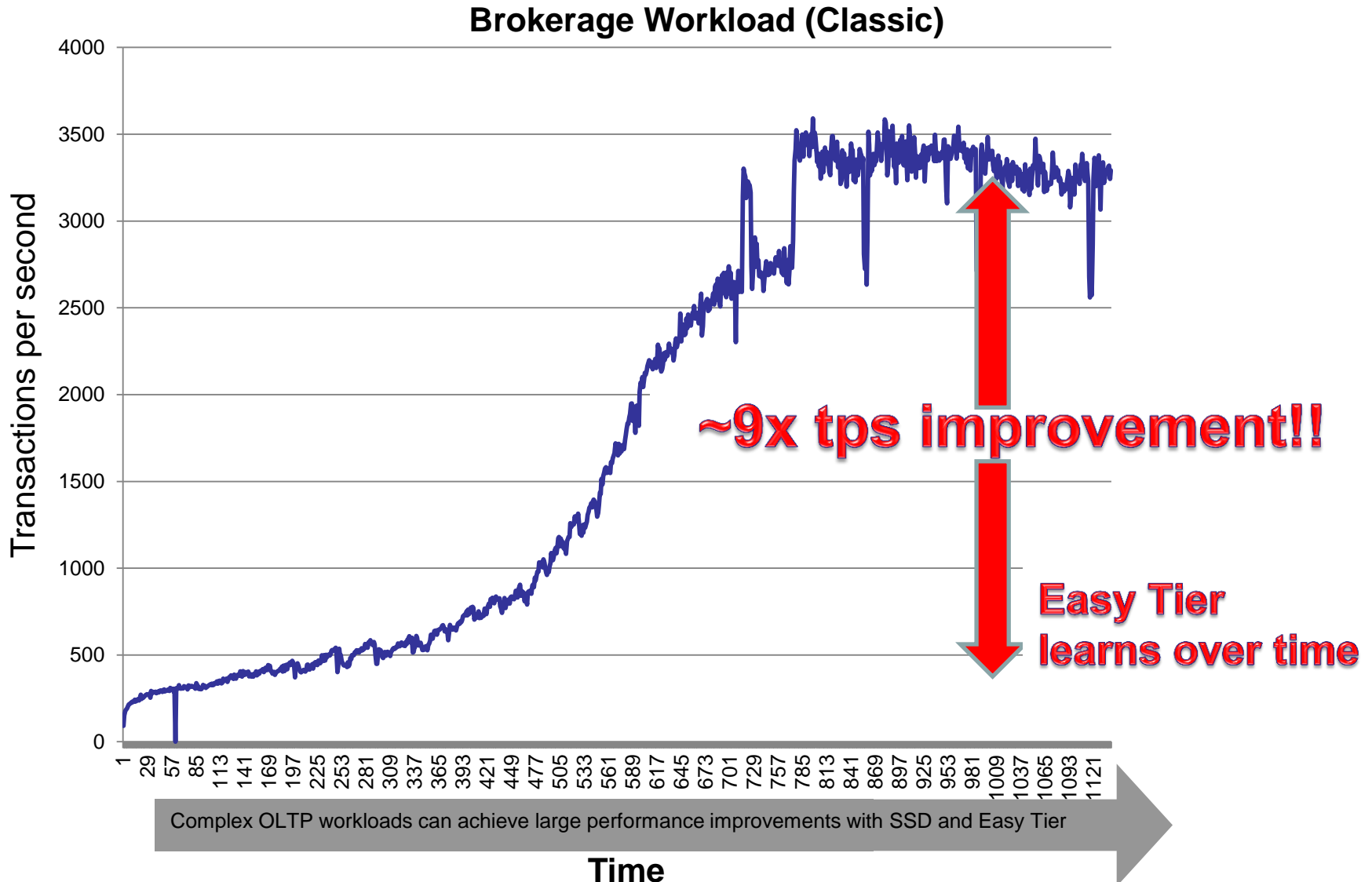

zEnterprise EC12 Efficiency At Scale – Multi-tenant Database Workloads

Which platform can achieve the lowest cost per workload?

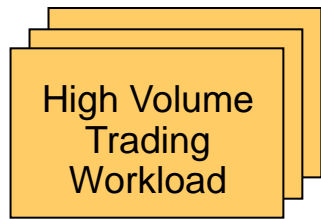

Database I/O Intensive Workloads each driving a minimum* of **243** transactions per second on 200GB database

1 workload on **16-core** quarter unit



Pre-integrated Competitor Multi-Tenant Private Cloud

\$2.27M/workload

5 multi-tenant workloads on zEC12 **4-cores**



DB2 10 for z/OS on zEC12

\$1.73M/workload

20x DB density
25% lower cost

* Maximum TPS was measured at 270 based on 70 ms injection interval for customer threads. SLA requires no more than 10% degradation in throughput, yielding a minimum TPS of 243

Efficiency At Scale – Consolidated Oracle DB Workloads Benefit From Linux On System z's I/O Bandwidth

Which platform provides the lowest TCA over 3 years?

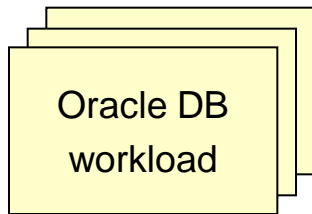

Customer Database Workloads
each supporting 18K tps

Oracle Enterprise Edition
Oracle Real Application Cluster



3 Oracle RAC clusters
4 server nodes per cluster

12 total HP DL580 servers
(192 cores)

\$13.2M (3 yr. TCA)



3 Oracle RAC clusters
4 nodes per cluster
Each node is a Linux guest
zEC12 with 27 IFLs

\$5.7M (3 yr. TCA)

Half the cost

TCA includes hardware, software, maintenance, support and subscription.
Workload Equivalence derived from a proof-of-concept study conducted at a large Cooperative Bank.

State-Of-The-Art Global Scale Transaction Processing

- 1B CICS trans/day
- 4,000 IMS trans/sec
- 14M ACH transactions in 2.5 hours
 - ▶ 30ms response
- Primary site – 216 CPUs
 - ▶ 200K MIPS
 - ▶ 6-way sysplex
 - ▶ 6 mainframes, 2 LPARS per box
 - ▶ 2 controlling LPARs for GDPS/PPRC
 - ▶ Approx 100 mainframe applications, 25 running on Linux
 - 15% Linux, growing at 30% annually
 - Linux is Active-Active in the two data centers, with zero downtime
- Zero outages, zero customer impact
- *“Crazy about security overall, and the z system has a fortress around it”*

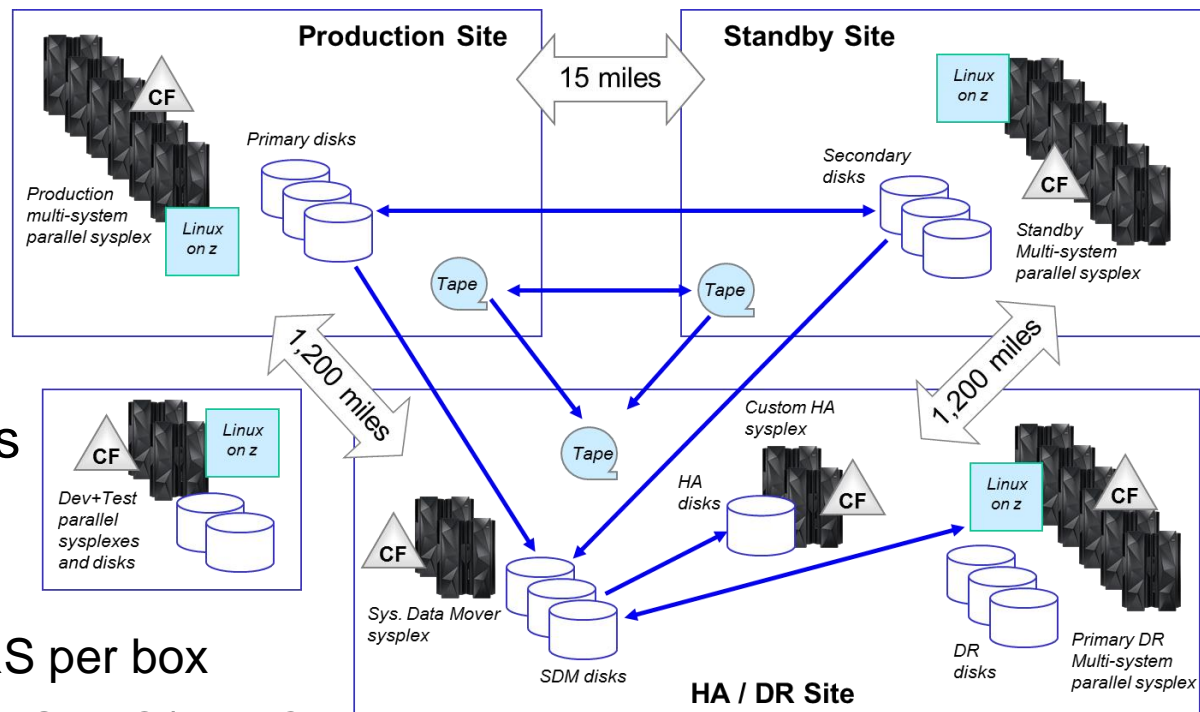

Trusted Resiliency – Protect Critical Data End To End

SECURITY dark READING

10 Top Government Data Breaches Of 2012

SQL injection, post-phishing privilege escalation, and poorly secured back-up information all played their part in exposing sensitive government data stores this year

Nov 29, 2012 | 04:26 AM | [1 Comment](#)

Privacy Rights Clearinghouse noted **230** security breaches during 2012, involving 9 million sensitive records ...

Zaxby's Computers Possibly Compromised, Diners Alerted

Posted on: 1:52 pm, January 16, 2013, by Carter Watkins

[Recommend](#) 3 [Facebook](#) 3 [Pinterest](#) 0 [Share](#) 3 [Twitter](#) 0 [Email](#)

FLORENCE, Ala. (WHNT) – A data security breach at a well-known chicken restaurant may have led to your credit and debit card being compromised.



Zaxby's restaurants across the south-east made this announcement after malicious software was found on their computer servers.

System z
security breaches: **0**

Source: <http://www.privacyrights.org/data-breach/new>
<http://www.darkreading.com/database-security/167901020/security/news/240142846/10-top-government-data-breaches-of-2012.html>
<http://whnt.com/2013/01/16/zaxbys-computers-possibly-compromised-diners-alerted/>

DB2 Top To Bottom Data Security

- DB2 supports encryption at every level
 - ▶ In memory, buffers, disk, and archival media
 - ▶ Table, index, logs, and backup copies
- DB2 provides multiple options for table encryption
 - ▶ Row and column level encryption
- DB2 supports Multi-Level Security (MLS)
 - ▶ Allows users with different access authority to safely access the same database image
- DB2 uses either CPACF or Crypto Express4S for encryption

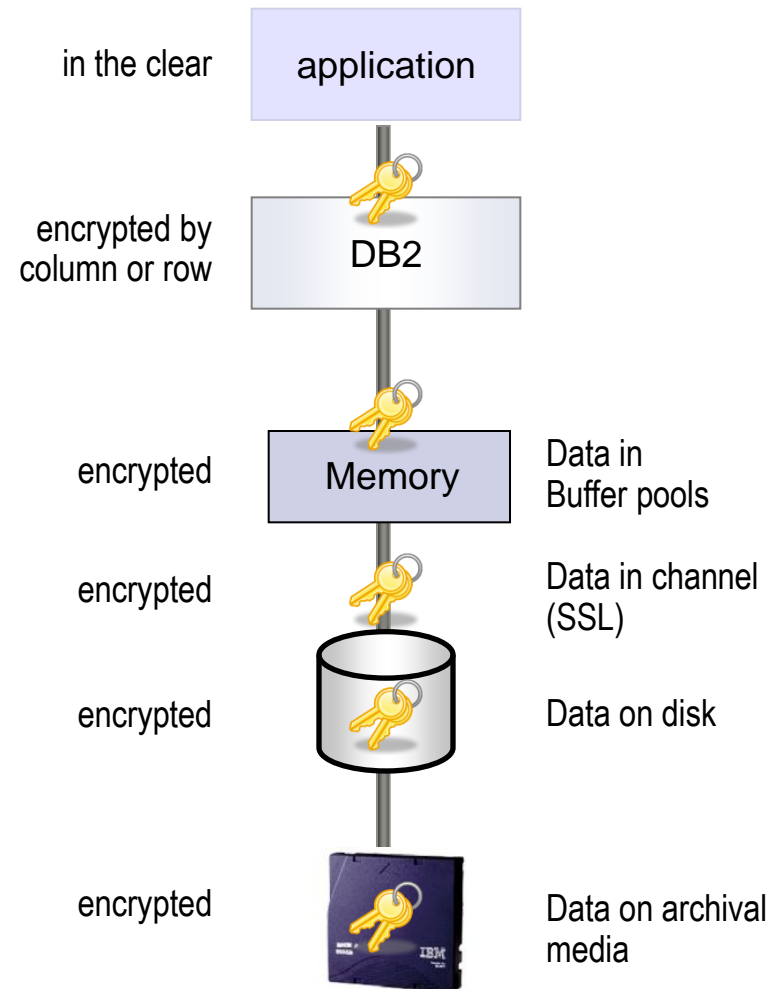

zEnterprise EC12 Hardware Accelerators For Encryption

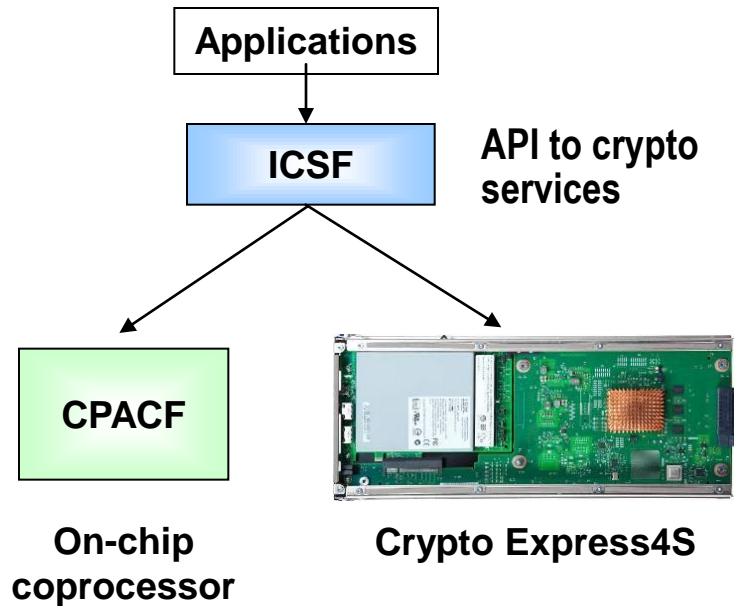

Transparently use whichever
accelerator is available

- **Central Processor Assist for Cryptographic Function (CPACF)**
 - ▶ Included free of charge, one coprocessor per core
 - ▶ 290-960 MB/sec bulk encryption rate
 - ▶ Support DES, SHA-1/2, AES
- **Crypto Express4S Card**
 - ▶ For SSL acceleration, clear key RSA operations
 - ▶ FIPS 140-2 Level 4
 - ▶ Dynamically configurable
 - Accelerator
 - Or Coprocessor (CCA, EP11)

DB2 Maturity Delivers A Proven Track Record For Data Security

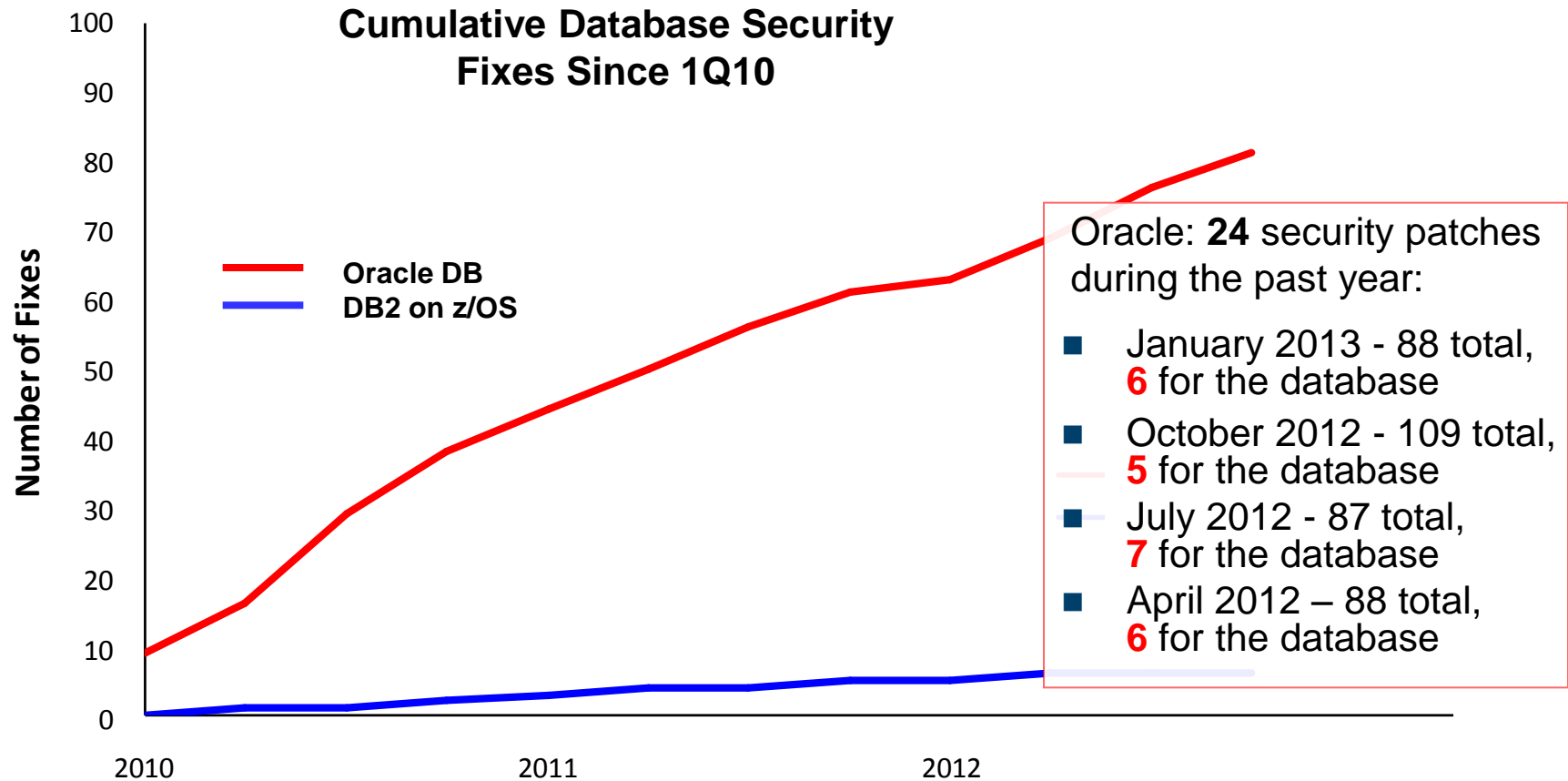

Source: <http://www.oracle.com/technetwork/topics/security>

Communications Server End-To-End Data Security

- z/OS Communications Server Encrypts Network Data End-to-End
- Multiple styles of encryption for network traffic
 - ▶ Application layer encryption, Network layer encryption, Virtual Private Networks with IPSec
- Application Transparent Transport Level Security (AT-TLS) transparently encrypts application data
 - ▶ Used by DB2, FTP, CICS Sockets, etc.
- TCP/IP SSL processed by crypto processor

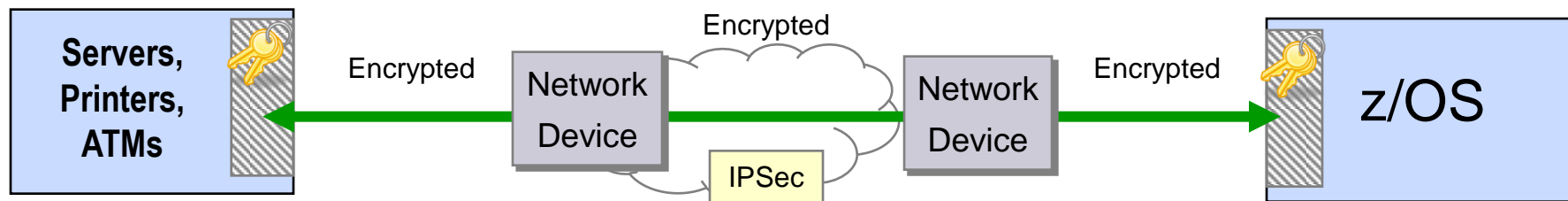

zEC12 – End-to-end network encryption

Defense Against Network Attacks

- **z/OS Communications Server detects network traffic attacks**
- Automatic application of defensive mechanisms
 - ▶ Evaluates inbound encrypted data for suspect activity
 - ▶ Policy controls connection limits, packet discard
 - ▶ Detects anomalies in *real-time*
 - ▶ *Avoids overhead* of per packet evaluation against known attacks
- Scan detection and reporting
 - ▶ Can map the target of an attempted attack
- Integrates with Tivoli Security Operations Manager

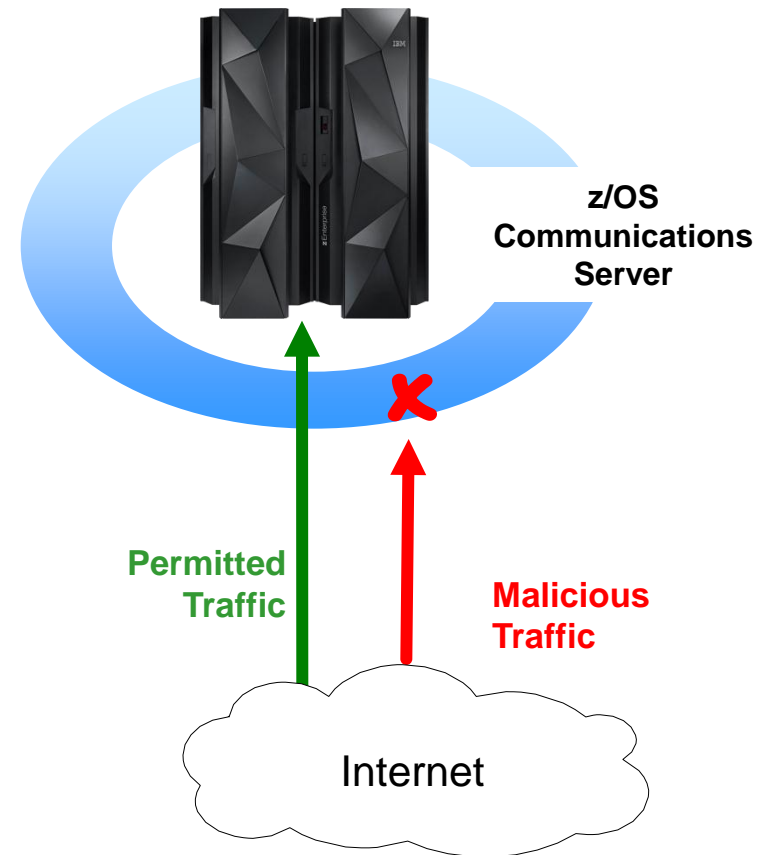

Trusted Reliability – Comprehensive Protection To Ensure Availability Of Critical Data

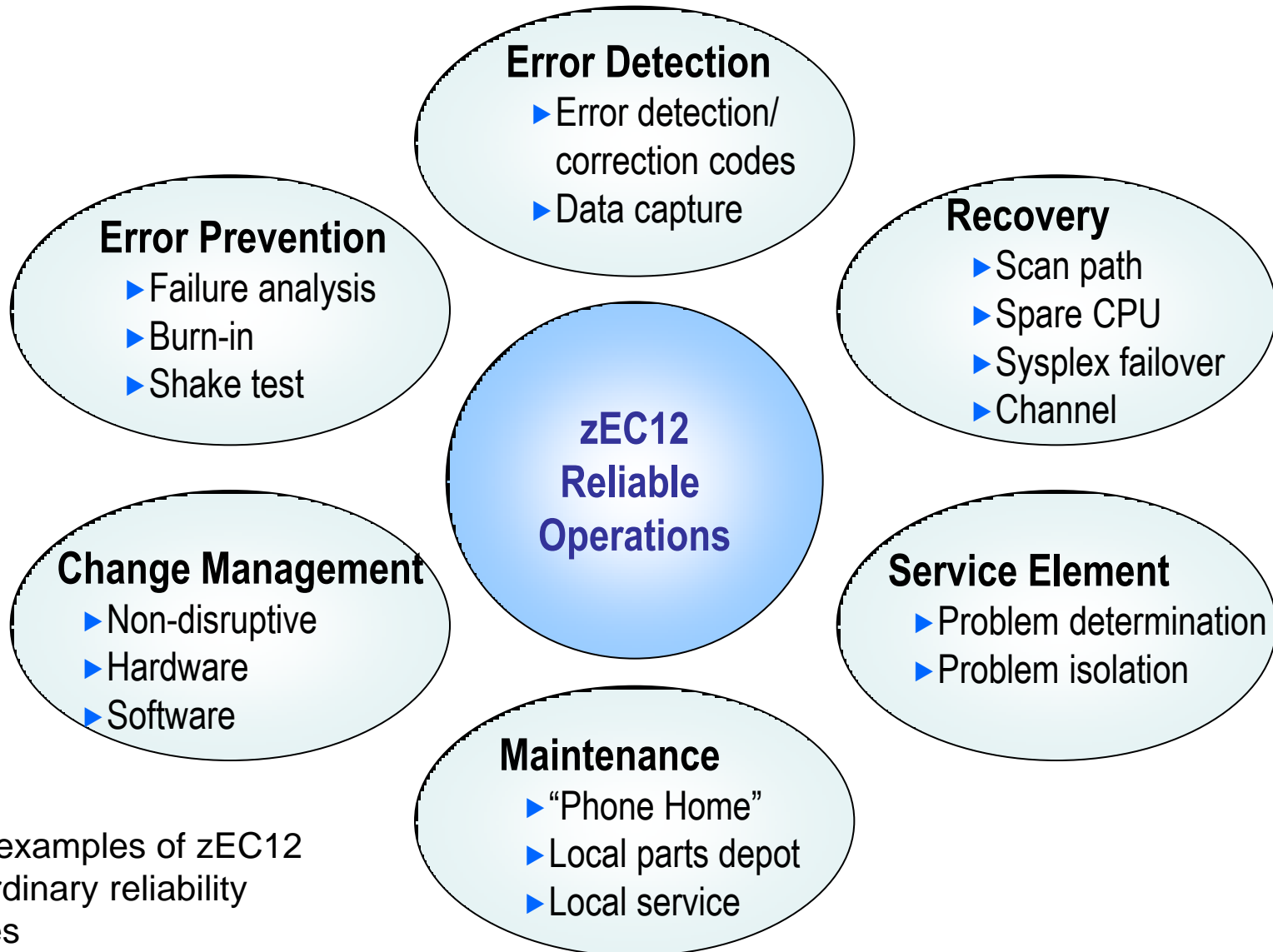

Some examples of zEC12 extraordinary reliability features

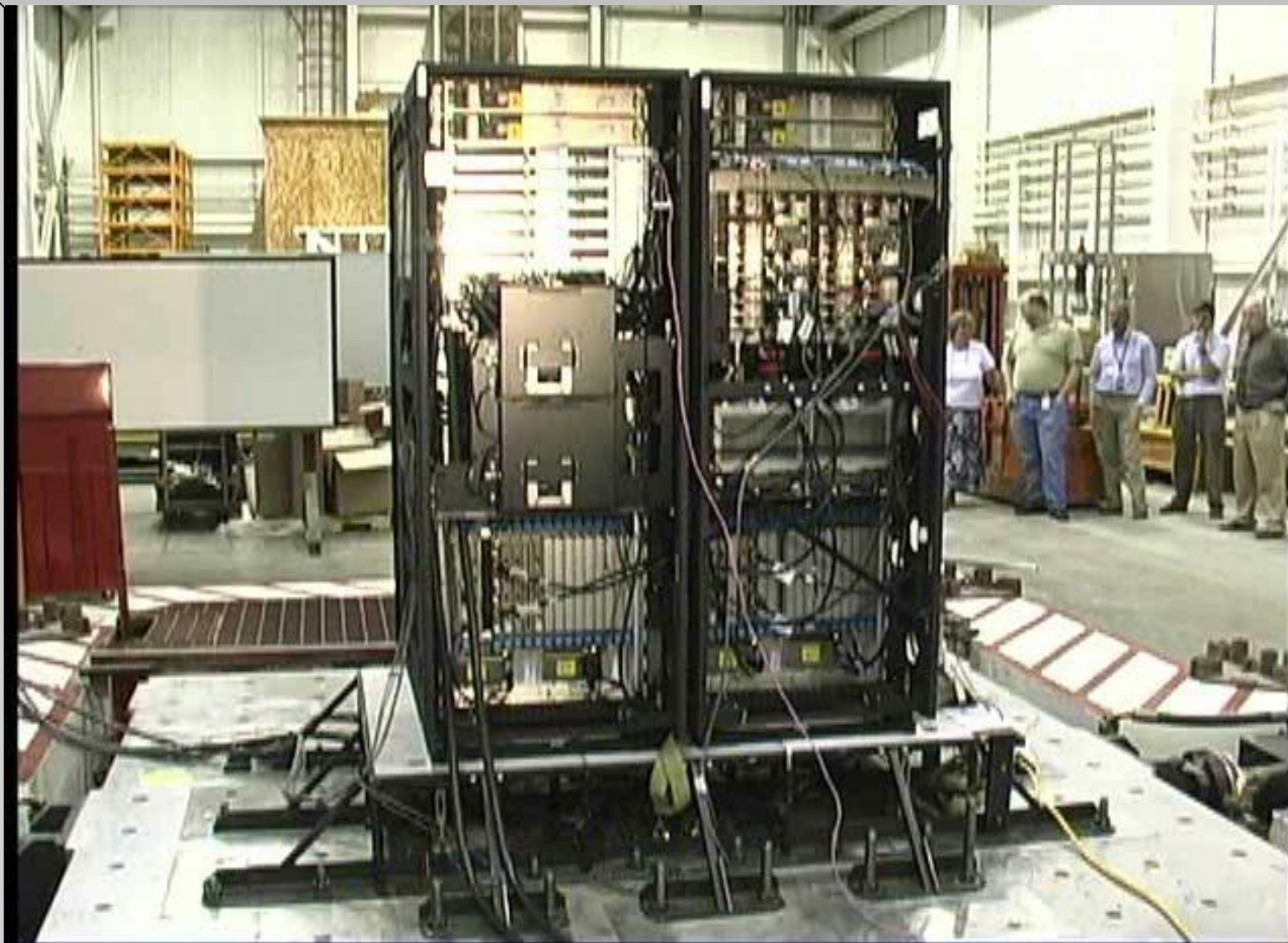

System z Leads The Pack

Downtime Survey (400 participants in 20 countries)

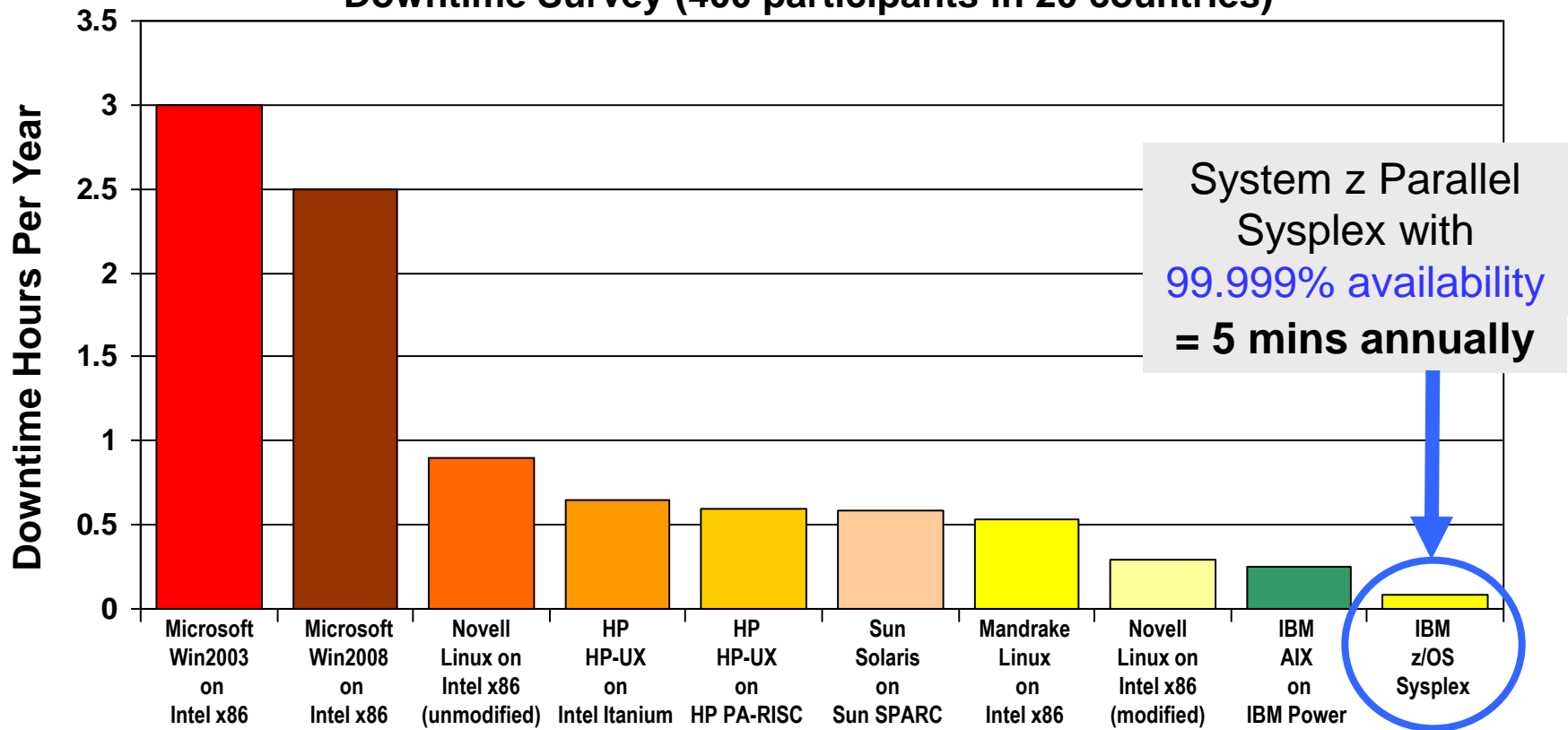

Source: ITIC: ITIC 2009 Global Server Hardware & Server OS Reliability Survey; July 2009; <http://itic-corp.com/blog/2009/07/itic-2009-global-server-hardware-server-os-reliability-survey-results/>; Results are measured in minutes per year. *Note: All operating systems included in the survey are not included in this chart. Fifteen operating systems on various processor architectures were included in the survey. The chart will be updated when the full report is available.

Cost Of Downtime For SAP On DB2 z/OS Trumps That Of SAP On Oracle RAC

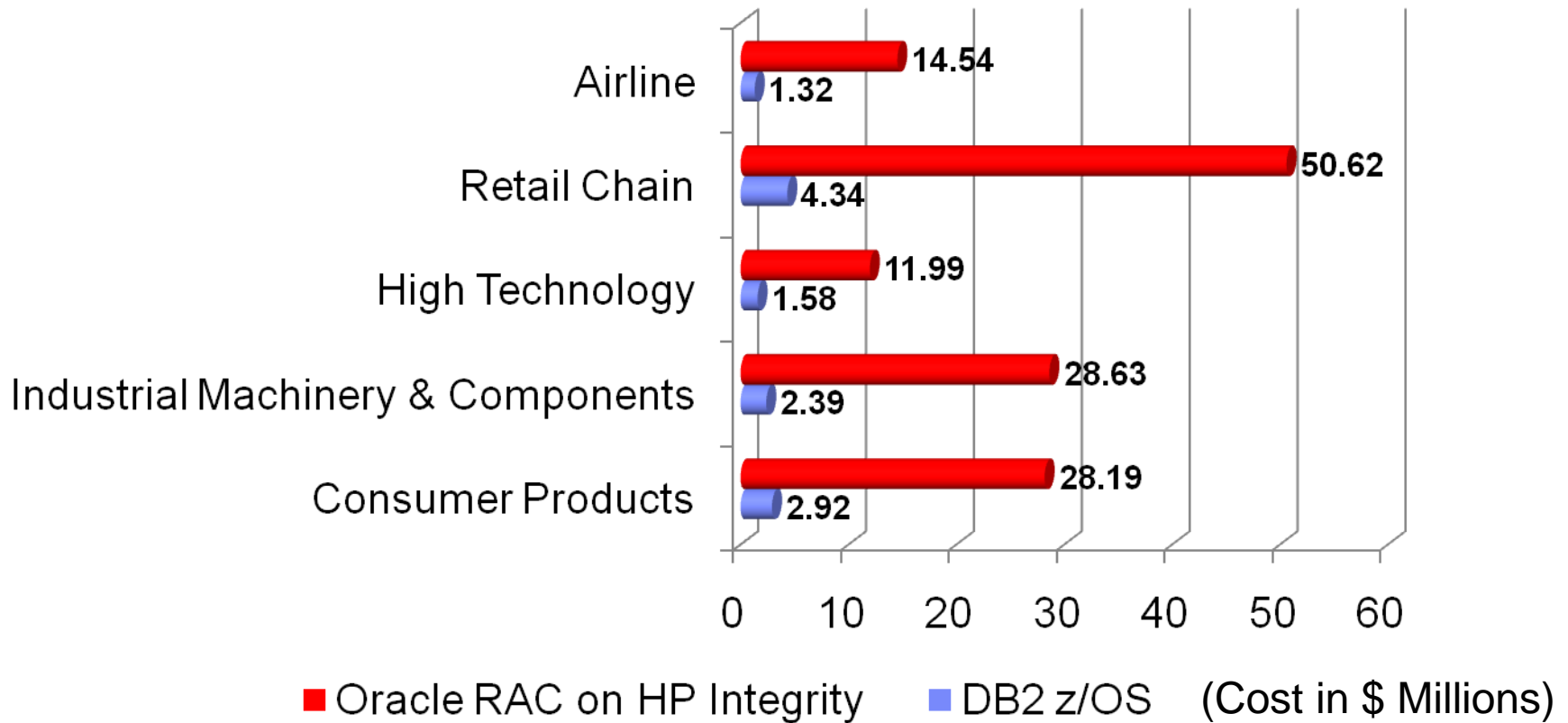

Source: ITG 1005: Business Case for IBM System z – Bottom Line Impact of Availability and Recovery For SAP Enterprise Systems

Leading The World For Critical Data Workloads

IBM zEC12



zEC12

- Efficiency at scale
- Ultimate security
- Ultimate availability

Smarter Planet, Smarter Cities Need A Smarter Infrastructure For Critical Data

- Critical data workloads are found in other applications than just banks, insurance, logistics, travel companies...
- Smarter Cities have critical data workload requirements
 - ▶ Global Scale Transaction Processing
 - ▶ Large Scale Batch Processing
 - ▶ Co-located Business Analytics

For example,

IBM's Smarter Cities Intelligent Operations Center

DEMO: Smarter Cities – Common Alerting Protocol – Example of how it works



1 Fire Hydrant is struck by a car
Maintenance crew fill out a order which
Will take 4 days



2 Fire breaks out on same block

Bring water Truck



Extra Long Hose



5 Fire Truck gets better information
On equipment choice



3 Fire is reported

4 Alerts are sent to IOC along side the current city systems
IOC see same time / same place correlation and updates fire house

DEMO: Architecture

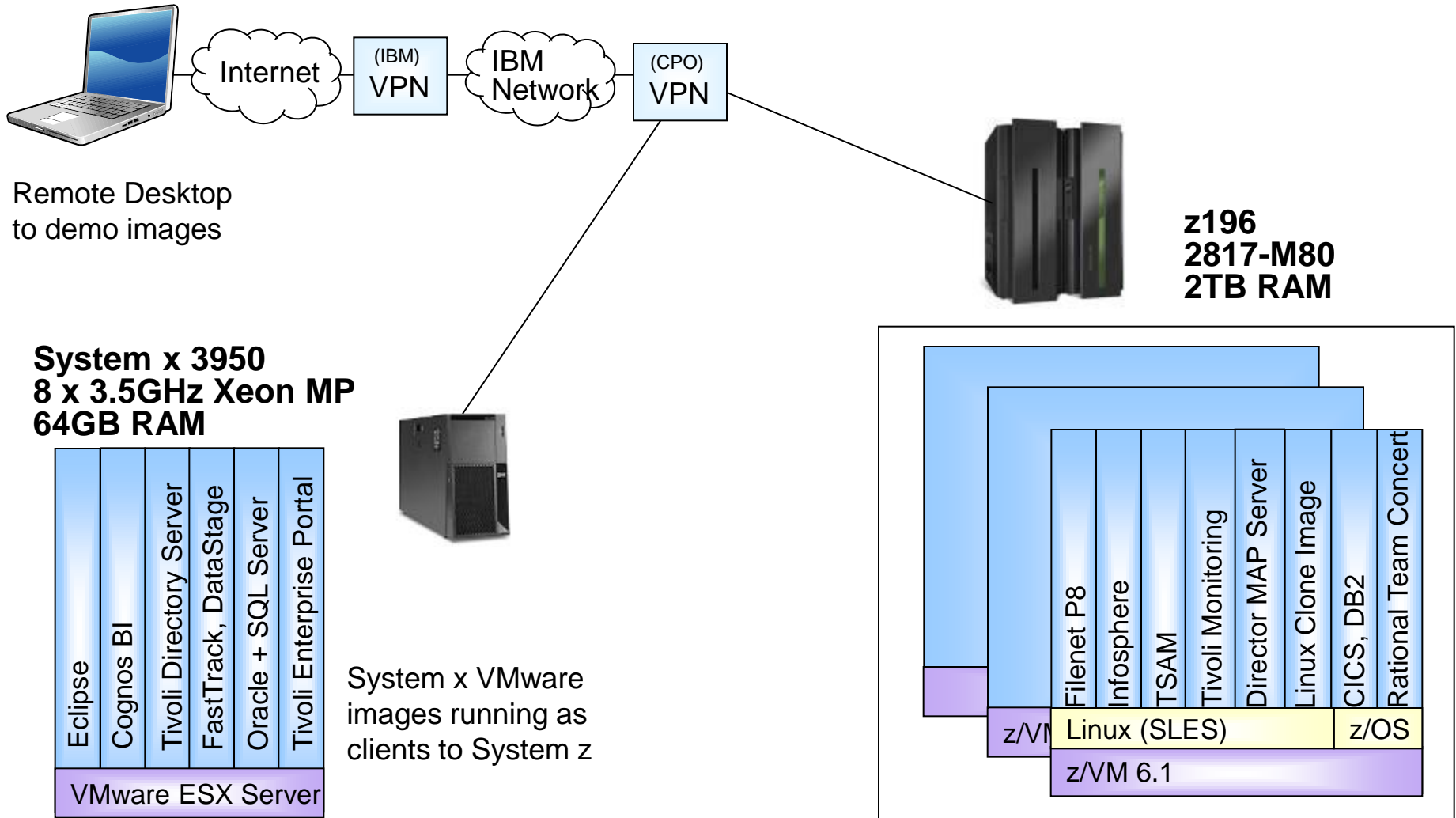

Agenda

60 minutes	System z Is Optimized For Critical Data Workloads
10 minutes	<i>Break</i>
60 minutes	World's Fastest Analytics
10 minutes	<i>Break</i>
60 minutes	Simplify Your Solution Delivery Challenges/Academic Initiative
45 minutes	<i>Lunch</i>
60 minutes	Surround Critical Data Workloads With A Private Cloud
10 minutes	<i>Break</i>
60 minutes	What System z Can Do That Intel Can't
10 minutes	<i>Break</i>
60 minutes	TCO Lessons From Customer Engagements
	<i>Close</i>

Notice Regarding Specialty Engines (e.g., zIIPs, zAAPs and IFLs):

Any information contained in this document regarding Specialty Engines ("SEs") and SE eligible workloads provides only general descriptions of the types and portions of workloads that are eligible for execution on Specialty Engines (e.g., zIIPs, zAAPs, and IFLs). IBM authorizes customers to use IBM SE only to execute the processing of Eligible Workloads of specific Programs expressly authorized by IBM as specified in the "Authorized Use Table for IBM Machines" provided at www.ibm.com/systems/support/machine_warranties/machine_code/aut.html ("AUT").

No other workload processing is authorized for execution on an SE.

IBM offers SEs at a lower price than General Processors/Central Processors because customers are authorized to use SEs only to process certain types and/or amounts of workloads as specified by IBM in the AUT.

