

Building a Better Infrastructure With IBM Middleware on IBM Power Systems

Reduce Database Complexity and
Improve Performance with IBM DB2

The Best Distributed Database Solution Is DB2 on Power Systems

We have a lot of complicated
database systems in our
infrastructure.



**Service Oriented Finance
CIO**

The best distributed data
management solution you can
buy is DB2 on Power Systems.
And you can save money by
scaling up. Here's how...



IBM

DB2 9.5 Server Editions

- Same code base
- Runs on Power Systems

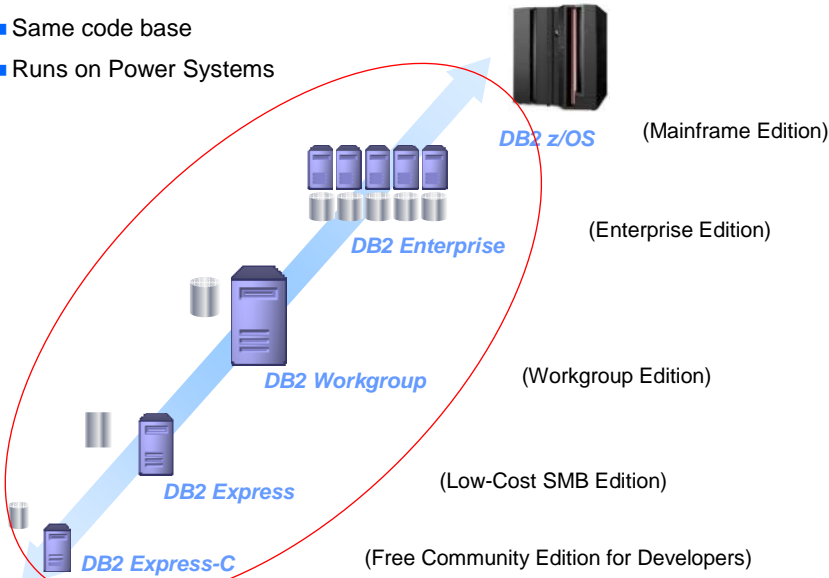

03 - Reduce Database Complexity and Improve Perf with DB2 2008 v3.0

3

DB2 Development Reference Platform

- IBM DB2 development uses DB2 + Power Systems as the primary reference platform for development and testing
- DB2 is a key part of regression testing for all AIX maintenance roll-ups and vice versa
- A strong roadmap for joint AIX/DB2/Power Systems exploitation in future releases

IBM does the integration testing so you don't have to!

03 - Reduce Database Complexity and Improve Perf with DB2 2008 v3.0

4

DB2 Gains Performance Benefits from Integration with Power Systems and AIX

- Exploits Power Systems compilers and advanced optimization features
- Deep integration between AIX Workload Management (WLM) and DB2 WLM
 - ▶ Helps meet service levels and maintain predictable performance via work priority settings and finer levels of monitoring
- Exploits AIX Concurrent I/O and Direct I/O interfaces
- Uses AIX multi-page support that includes 64KB, 16MB and 16GB page sizes
- Optimized DB2 resource object alignment with Power Systems architecture
- Exploits Simultaneous Multi-Threading (SMT)
- Judicious use of POWER processor cache line pre-fetching instructions to minimize memory access latencies

DB2 Benefits from AIX Management Features

- Storage Protection Keys
 - ▶ DB2 takes advantage of AIX storage protection keys
- Support for AIX Workload Partitions
- Dynamic Reconfiguration
 - ▶ Allows administrators to add and remove processors, memory and I/O adapters to and from LPARs, without disturbing business operations or applications
- Recovery Integration
 - ▶ DB2 recovery process with Power Systems autonomic computing technologies
- First Failure Data Capture (FFDC)
 - ▶ Provides failure analysis and automated recovery capabilities
- Service Update Management Assistant (SUMA) tool
 - ▶ Allows administrators to automate downloads of operating system fixes and maintenance levels from the IBM Fix Central Web site

DB2 Performance Benefits from Integration with IBM TotalStorage Devices

- I/O Priority
 - ▶ I/O Priority allows IBM TotalStorage DS8000 to favor AIX/DB2 workloads and reduce interference from lower priority activities

- Cooperative Caching
 - ▶ Enables more efficient use of memory resources in host and storage systems
 - ▶ Information is exchanged between DB2, AIX, and IBM DS8000 to increase the overall efficiency of memory across DB2 buffer pools and the storage system's cache

Oracle Cannot Match DB2 on Power Systems

- Integration of DB2, AIX, and Power Systems gives IBM an advantage in optimization
- Oracle is designed to run on a variety of commodity servers
- Oracle is designed to run on a variety of operating systems
- Oracle cannot match the specialized integration of DB2 with AIX and Power Systems servers

Reduce Data Center Complexity by Scaling Up

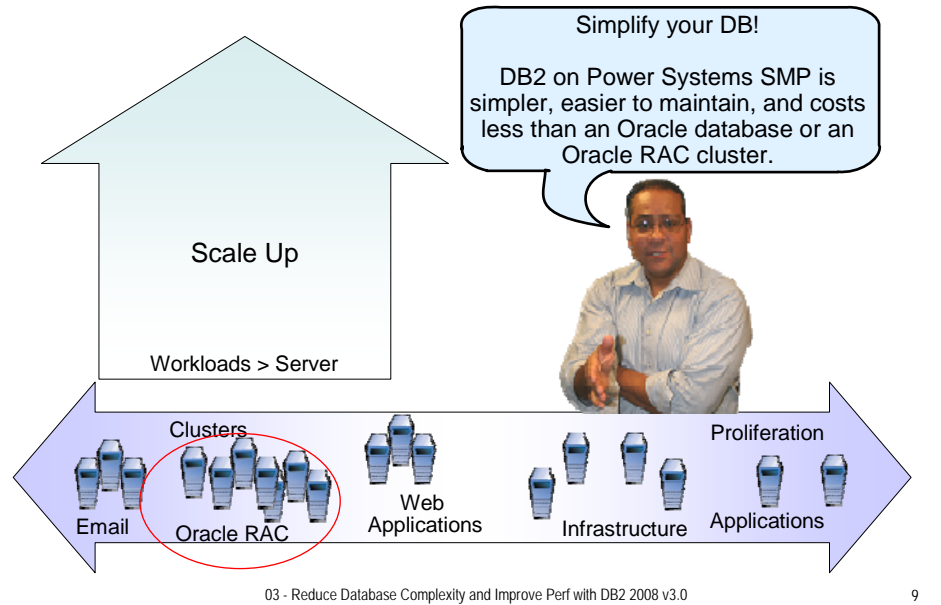

DB2 and Power Systems Deliver Superior Scalability

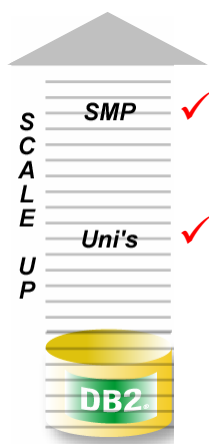

- DB2 scales up to 64 SMP processor cores on a single Power Systems server
 - ▶ Near linear scalability up to 64-core SMP systems
- Support more users on a single server

DB2 Scales Near Linearly in Power Systems Logical Partitions

DB2 on 1 LPAR of a p5-570

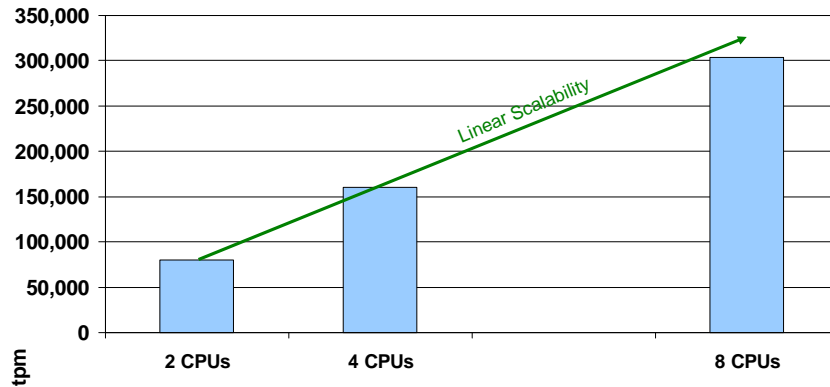

Benchmark Tests Performed by IBM Toronto Labs and Systems and Technology Group Using TPC-C-Like Workload, 2.2 GHz POWER5+, 2006

TPC Benchmarks Demonstrate DB2 Near Linear Scalability on Power Systems

4x Cores, 3.93x Throughput

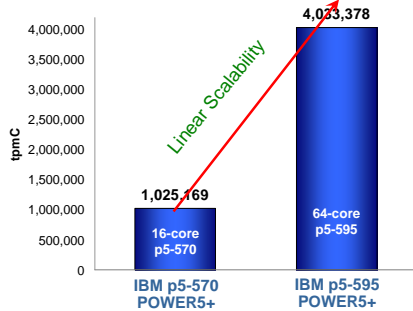

DB2 Benchmarks on Power Systems POWER5+

2x Cores, 2.00x Throughput

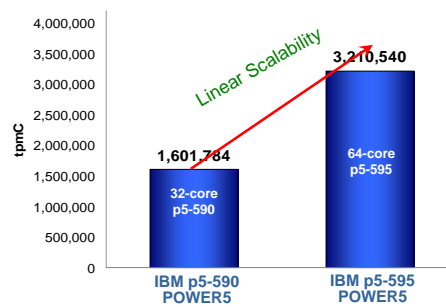

DB2 Benchmarks on Power Systems POWER5

Oracle RAC Adds Capacity and Scales by Clustering Commodity Servers (Nodes)

- Incoming requests are dispersed (sprayed) among the nodes
- Requires two separate networks
 - ▶ A private network for internal traffic between the nodes and the database
 - ▶ A public network for external communication and incoming requests
- Requires a single copy of the database in storage

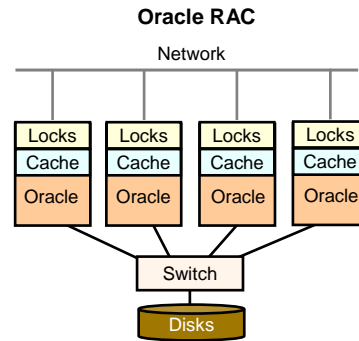

03 - Reduce Database Complexity and Improve Perf with DB2 2008 v3.0

13

Oracle RAC Scale-Out Is Not Linear

- Two-Node RAC scalability test performed by Performance Insight
 - ▶ SQL> CREATE TABLE TEST01 (C1 NUMBER ,C2 VARCHAR2(100));
 - ▶ SQL> CREATE INDEX IDX_TEST01 ON TEST01(C1);
- Simple insert/update/delete transactions
 - ▶ One node registered 723 transactions per second
 - ▶ Two nodes registered 489 transactions per second
- After considerable tuning with index redesign and adding query hints
 - ▶ Scalability rose to 1.47x on 2 nodes
- After rewriting the application to route transactions
 - ▶ Scalability rose to 1.9x
- **“Scalability does not improve without application tuning”**

Adding One Node to Oracle RAC

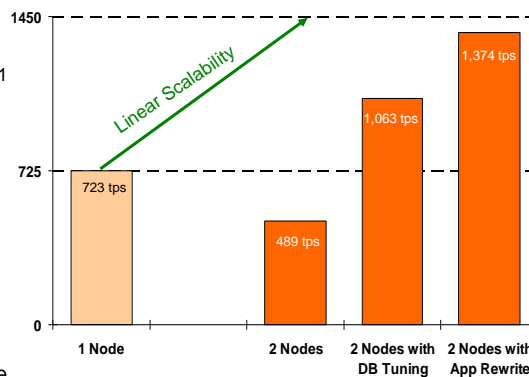

Source: Insight Technology Inc.:
<http://www.insight-tec.com/en/mailmagazine/vol136.html>

03 - Reduce Database Complexity and Improve Perf with DB2 2008 v3.0

14

Why Is Oracle RAC Scalability Limited?

RAC Inefficiencies Increase as a Cluster Grows

- RAC nodes must constantly communicate to process requests to maintain distributed cache and lock data.
- Adding additional nodes to the cluster results in increased inter-node communication which requires additional local processor and network time.
- RAC distributed lock management overhead increases faster than the added capacity of more nodes.

Let's look at some examples...

Oracle RAC: Lock Management Overhead

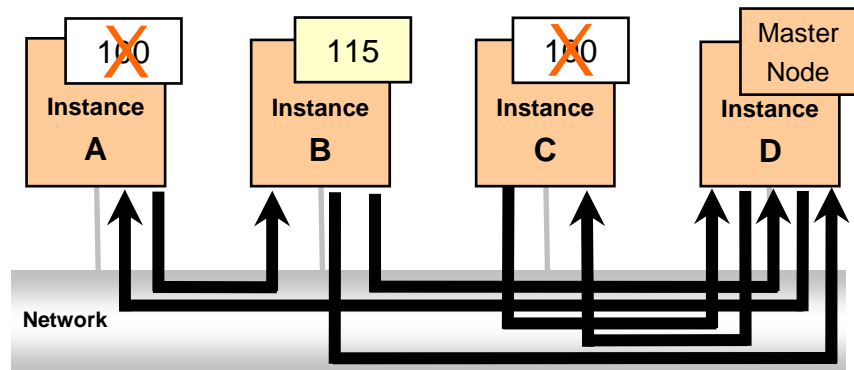

Lock Assume

7. B Updates local copy

Inter-node connections: 6

In a cluster with 4 nodes, an update operation may need 6 network connections and two in-memory calls (not shown).

Example based on Oracle's US Patent 7,107,319 B2.

Oracle Scale-Out Glass Ceiling

- DB2 provides near-linear scalability on Power Systems
- With Oracle RAC, overhead increases rapidly as additional nodes are added, and performance degrades significantly after only 4 to 6 nodes

Sources: "Scale-up versus scale-out using Oracle 10g with HP StorageWorks", Hewlett-Packard, 2005;
 "Enterprise Data Base Clustering Solutions" ITG, October 2003;
 Benchmark tests, IBM Toronto Labs and Systems and Technology Group, using TPC-C-like workload, 2.2 GHz POWER5+, 2006 Power Systems TPC Benchmarks

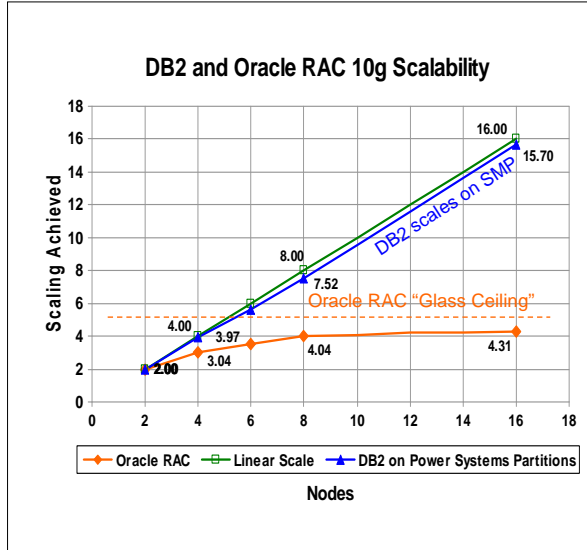

Oracle RAC Overhead Wastes Processing Power in Each Node

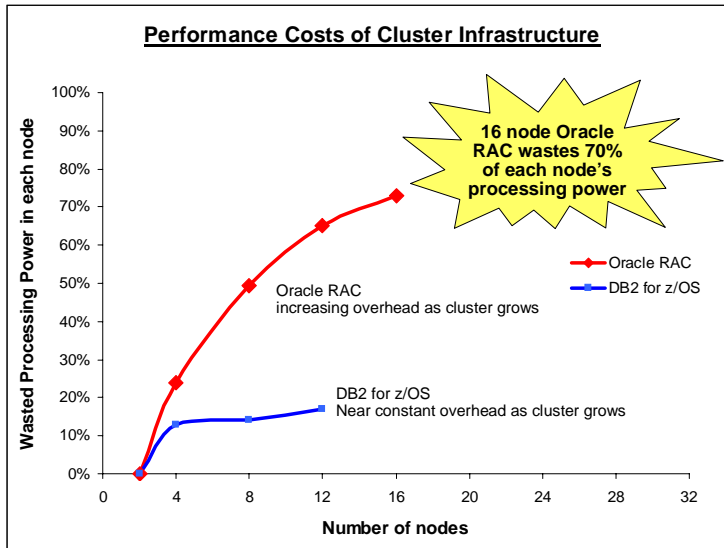

Oracle RAC source: "Scale-up versus scale-out using Oracle 10g with HP StorageWorks", Hewlett-Packard, 2005

DB2 High Availability and Disaster Recovery (HADR) Is Better Than Oracle RAC's

- DB2 HADR provides high availability and fast failover
 - **Failover in less than 15 seconds**
 - **Real SAP workload failover for 600 SAP users performed in 11 seconds**
 - Storage mirror survives disaster
 - Buffer pool primed on standby server with recent updates
 - 100% performance after server failure
 - Uses ordinary network and storage devices
- RAC failover is delayed due to remastering of distributed locks
 - Only one copy of storage
 - Degraded performance after server failure
 - Pay for Oracle RAC for every node
 - Specialized network and storage raises cost of ownership, erodes any savings from commodity servers

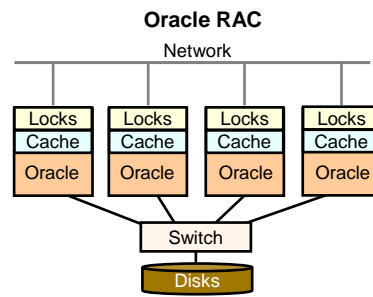
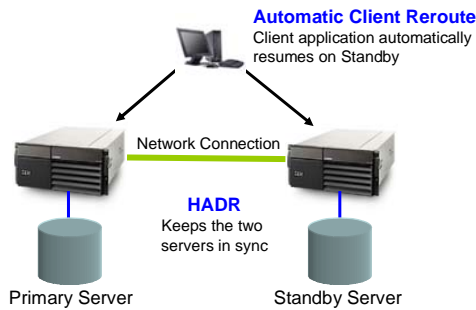

03 - Reduce Database Complexity and Improve Perf with DB2 2008 v3.0

19

DB2 Features Reduce Planned Outages

- Database changes can be made while the database is running
 - ▶ Table or column changes, type and length
 - ▶ Dynamic adding and rotating partitions
- Housekeeping operations can be performed without taking down the database
 - ▶ Image copy, backups can be performed with the database running
- Performance adjustment changes can be made while running
 - ▶ Reorganization of the database
 - ▶ Secondary index partitioning
 - ▶ Partition without an index; cluster on any index
 - ▶ Online database parameter changes

03 - Reduce Database Complexity and Improve Perf with DB2 2008 v3.0

20

Oracle Security Flaws and Patches

- **ComputerWorld - 10/17/2006**
"Oracle releases 101 patches in quarterly update" including **63** for database
- **C/NET - 1/17/2007**
"Oracle plugs 51 security flaws" including **26** for database
- **eWeek.com – 7/17/2007**
45 security patches, including **17** for database
- **ComputerWorld - 9/3/2007**
"Expert finds 'stupid' vulnerabilities in Oracle 11g"
- **eWeek.com – 10/16/2007**
51 security patches, including **27** for database
- **eWeek.com – 1/15/2008**
26 security patches, including **9** for database
- **500+ Patches for Oracle 10g in 12 Months**
From January 18, 2007, to January 18, 2007, there were more than 500 recommended patches posted for the most stable version (10.2.0.3) of the Oracle 10g database – patches can be downloaded from metalink.oracle.com



03 - Reduce Database Complexity and Improve Perf with DB2 2008 v3.0

21

DB2 Data Compression Beats Oracle

- Head-to-head compression test on standard database
 - ▶ TPC-H is a well-known data warehouse benchmark
 - ▶ Each vendor uses the same tables and data
 - ▶ Oracle published their compression rates for TPC-H tables at the VLDB conference in 2003
 - ▶ IBM ran the same tests on the same tables

Test Results – DB2 Reduces Cost by Requiring Less Storage

Table	Reduction in Storage Required	
	Oracle	DB2
LINEITEM	38%	58% (1.5x better)
ORDERS	18%	60% (3x better)
Entire Database	29%	59% (2x better)

03 - Reduce Database Complexity and Improve Perf with DB2 2008 v3.0

22

AutoZone Cuts Costs with DB2 Data Compression

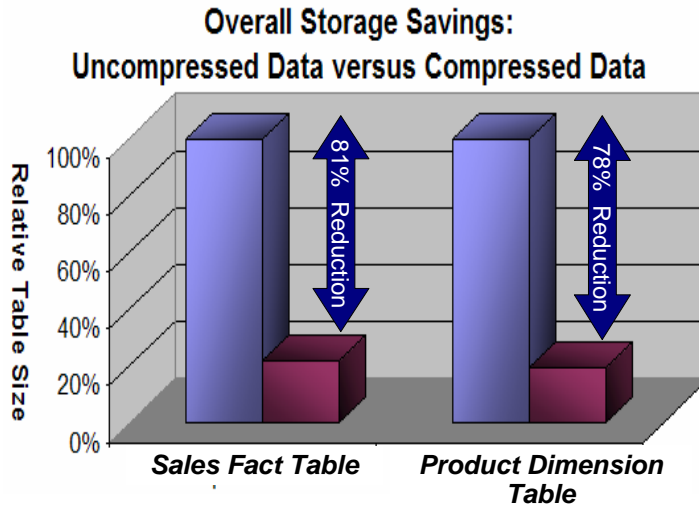

03 - Reduce Database Complexity and Improve Perf with DB2 2008 v3.0



23

Tellabs Reduces SAP Database by 83%

REAL WORLD BENEFITS

Tests showed a 43% and 83% reduction of SAP tables. Benefits include reduced storage space and increased performance. Also freed up valuable floor space and reduced costs for heating and cooling.

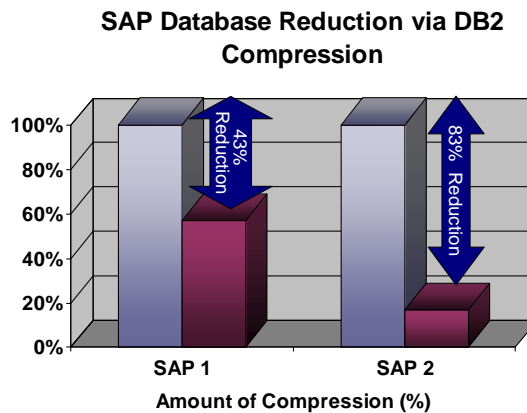

“We needed a database that represented the future, and DB2 9 is the future. DB2 9 compression capabilities are key in helping reduce the size of our databases—in one case by up to 83 percent. This ultimately helps us minimize storage costs and increase performance.” — Jean Holley, CIO, Tellabs, Inc.

03 - Reduce Database Complexity and Improve Perf with DB2 2008 v3.0

24

DB2 Simplified Maintenance

Everyday tasks are simply automatic!

- Statistics collection
- Backup
- Table reorganization

Status as of:	4/14/04 7:34 AM	Refresh
DBM State:	Started	Stop
Last Backup:	4/13/04 9:00 AM	Backup Database
Size:	19 MB	Manage Storage
Capacity:	5316 MB	<input type="text" value="1%"/>
Health:	Normal	Monitor DB Health
Maintenance:	Fully automated	Maintenance

**No need to wonder
when it's time to run
these utilities.**

It's automatic!

Online maintenance window

Online automatic maintenance can occur during the following window

Time	00:00 - 05:00 (5 hours)
Days of the week	All
Days of the month	All
Activities using this window	Backup database (BACKUP), Optimize data access (RUNSTATS)

[Change...](#)

DB2 Adaptive Self-Tuning Memory

Increases Business Value, Decreases DBA Tuning Tasks

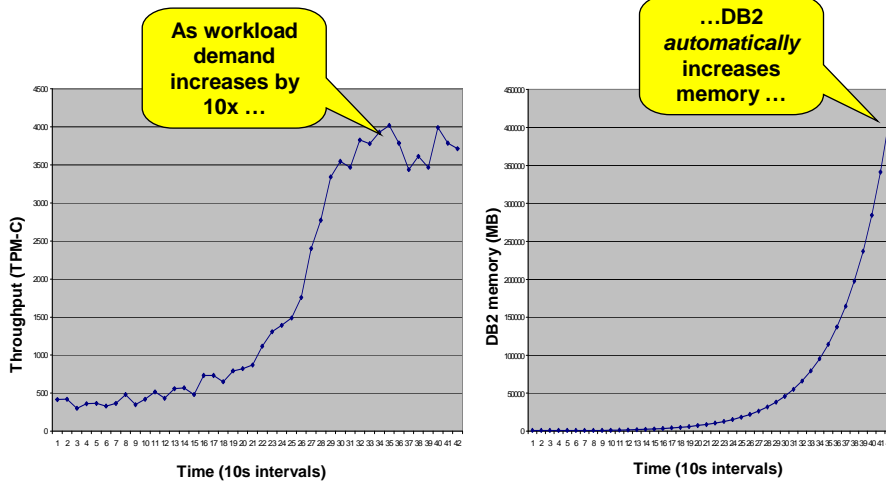

Customers See DB2 Administration Benefits

“There’s far less administration involved with DB2 than with Oracle.” **BOC runs “50-100 SAP systems,” supported by 12 people**
“That is really quite extraordinary.” - Sheila Moran at BOC in UK

“DB2 requires significantly less database administration than Oracle. **We can now deploy our IT staff for more productive and business-critical needs**” - Zdenek Vosahlo, Head of IT at Precheza

- **Oracle RAC is difficult to deploy and maintain**
 - ▶ Oracle encourages customers to use Oracle Consulting or a certified implementation partner
 - ▶ Rigid certification for support—hardware and software must be certified by Oracle
 - ▶ Administrators must bring cluster down to install quarterly patches
 - ▶ Two days to install a 2-node RAC cluster (vs 4-hour unattended install for DB2)*

* Source: IBM Competitive Technology Lab

DEMO: Administration Made Easy

DB2 Autonomics in Action

1. Health Center - Simplify Administration
 - ▶ Show how the health center can determine the status of database systems
 - ▶ Show Alarm and Warning alerts and Recommendation Advisor
 - ▶ Show how you customize settings for alerts
 - ▶ Show how alerts are set to go to e-mail
2. Control Center
 - ▶ Self Tuning - Show options for automatic memory and space management

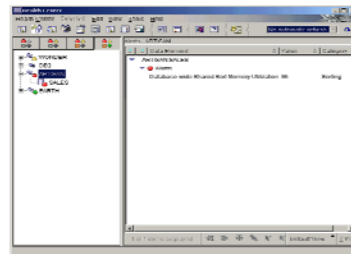

Ease of Administration – Big Part of TCO

Solitaire Interglobal Study - Staffing
Real world study of 250 sites

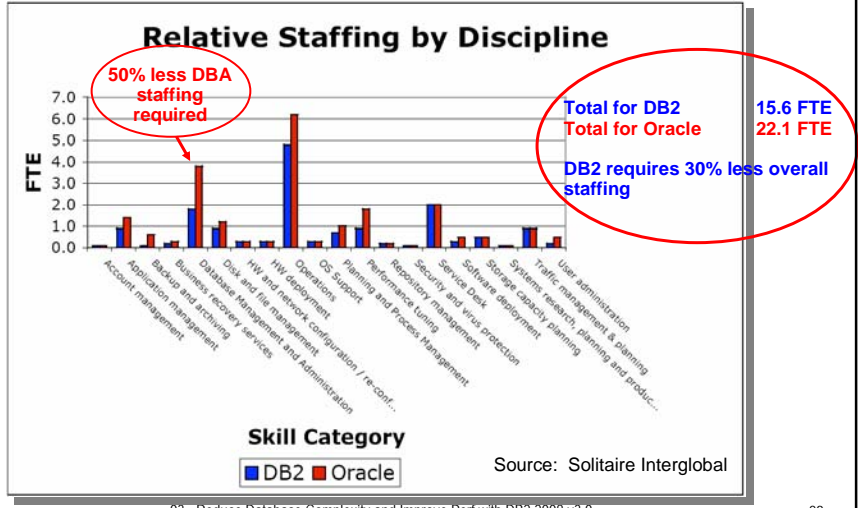

03 - Reduce Database Complexity and Improve Perf with DB2 2008 v3.0

29

Remove Database Clutter by Scaling Up Large Database Workloads on Power Systems

By scaling up on Power Systems you can reduce your Oracle RAC database clutter...and save money while gaining performance.



IBM

That's music to my ears...



Service Oriented Finance
CIO

03 - Reduce Database Complexity and Improve Perf with DB2 2008 v3.0

30

Migrate Oracle RAC to DB2 on Power Systems

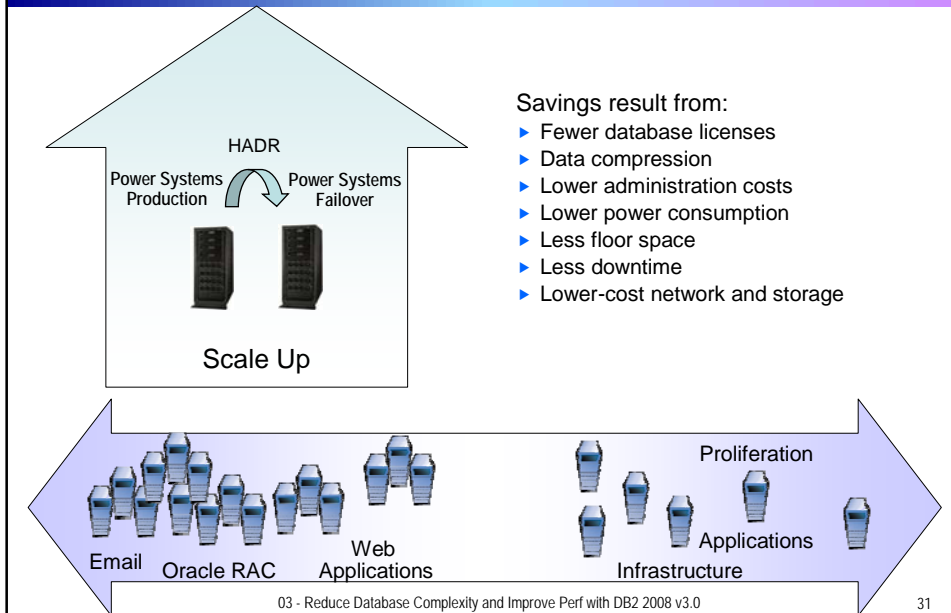

Cost Comparison: Replace Oracle RAC on Sun with DB2 on Power Systems with HADR

3-Year TCO	Oracle 11g RAC running on 4 SunFire E2900's**	DB2 HADR running on 2 Power 570's*
Cores	24 per server (96 total)	16 per server, 2 active cores on backup server
Relative Performance Estimate (RPE)	8,830 RPEs per server X 4 X 0.7 (RAC scalability) = 24,724 RPEs	25,020 per active server 25,020 per backup server
Server Hardware + 3 Years Maintenance	\$2,040,364	\$849,152 for active server \$392,444 for backup server
Software + 3 Years Support	\$9,083,520	\$1,059,374 for active server \$68,790 for backup server
Storage + 3 Years Maintenance (2TB before compression)	\$77,095	\$58,240 for active server \$58,240 for backup server
Total Cost	\$11,200,979	\$2,486,240

* Two mirrored 16-core Power 570's w/ 4.70 GHz POWER6 CPUs running AIX.
 ** Oracle 11g + RAC running on a cluster of 4 SunFire 24-core E2900s w/ 1.95 GHz CPUs running Solaris, with a scaling efficiency of 0.75.

Price Sources—Power 570 and maintenance, Power Systems storage (IBM DS4700 RAID device) and maintenance: IBM Technical Sales; DB2 UDB 9 and support: IBM.com Passport Advantage Express; Software Catalog, SunFire E2900: <http://shop.sun.com>; Oracle 10g + RAC, Oracle.com, Oracle Technology Global Price List, September 4, 2007; SunFire storage (Sun StorageTek 6140 Array) and maintenance: <http://shop.sun.com>.

Cash Flow: Replace Oracle RAC on Sun with DB2 on Power Systems with HADR

DB2 on Power Systems One-Time Charge

Server Acquisition	\$1,091,620
Disk Acquisition	\$116,480
Software Licenses	\$790,660
Migration Cost	\$67,400
Total OTC (Cost of migration)	\$2,066,160

Price Sources—DB2 on Power Systems: server acquisition, annual server maintenance, disk acquisition, and annual disk storage maintenance: IBM technical Sales; software licenses: IBM.com Passport Advantage Express Software Catalog; power: IBM study, Project Green. Oracle RAC on Sun: annual server maintenance: Ideas International; annual disk storage maintenance: http://shop.sun.com; annual software support: Oracle.com, Oracle Technology Global Price List, September 4, 2007. (All others: ECM)

DB2 on Power Systems Annual Cost

	Year 1	Years 2+
Power and Cooling	\$7,688	\$7,688
Annual Server Maint.	\$49,992	\$49,992
Annual Disk Storage Maintenance	\$9,600	\$9,600
Annual SW Support	\$15,030	\$168,752
Annual System Administration	\$28,503	\$28,503
Total Annual Cost	\$110,813	\$264,535

Oracle RAC on Sun Annual Cost

	Year 1	Years 2+
Power and Cooling	\$15,148	\$15,148
Annual Server Maint.	\$40,128	\$40,128
Annual Disk Storage Maintenance	\$11,113	\$11,113
Annual SW Support	\$1,203,840	\$1,203,840
Annual System Administration	\$81,436	\$81,436
Total Annual Cost	\$1,351,664	\$1,351,664

Lower annual operational costs yield breakeven in less than 2 years

03 - Reduce Database Complexity and Improve Perf with DB2 2008 v3.0

33

Breakeven in Less Than 2 Years

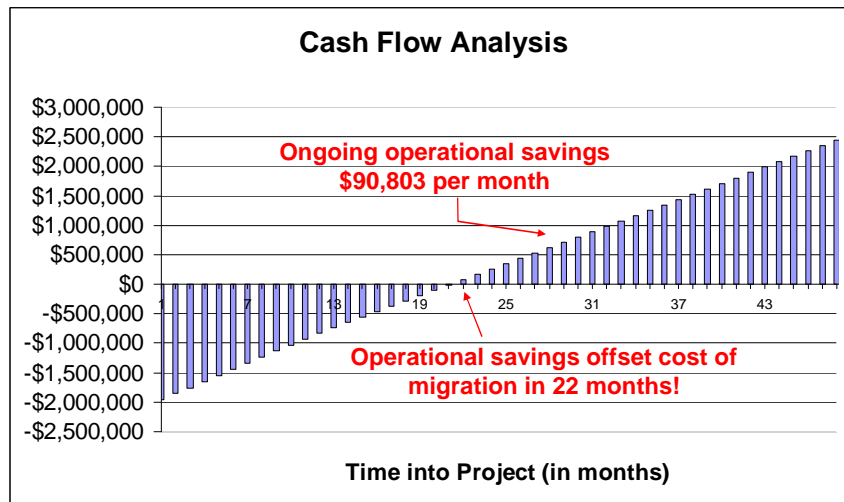

03 - Reduce Database Complexity and Improve Perf with DB2 2008 v3.0

34

Oracle to DB2 Migration Made Easy by IBM

- Migration Toolkit (MTK) - inspects Oracle database and migrates DML components, which are the tables, views, and indexes, then uses SQL Select to retrieve and load the data into the DB2 database
- Third-party tools help perform Oracle PLSQL code migration - Quintessence, Ciphersoft
- Some projects are done with the help of IBM services

DEMO: Migrate an Oracle Database to DB2

1. IBM Migration Toolkit

- ▶ Using the wizard, introspect an Oracle database to create a mirror image for DB2 of tables, views and indexes
- ▶ Deploy the database to DB2

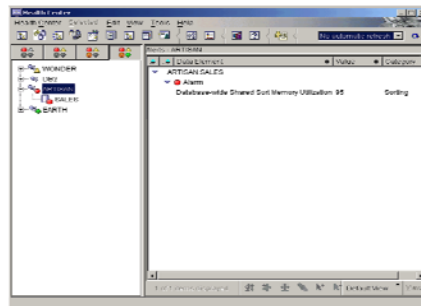

Migrate from Oracle Survey

“In a survey of IT professionals using Oracle, 48% of respondents said they are considering alternatives to Oracle more seriously than they were just one year ago. Why? **73% of them pointed to the high cost of running Oracle.**”

Source: SearchOracle.com Member Survey Results, May 31, 2007
http://searchoracle.techtarget.com/originalContent/0,289142,sid41_gci1257550,00.html

And now we have some special offers!



IBM

IBM Software and Power Systems Special Offers

Rebates When You Buy IBM Middleware on POWER5 Models

- POWER5 models p5-520/p5-550/p5-560/p5-570/p5-575/p5-590/p5-595
 - ▶ Rebates up to \$300,000
- DB2 Workgroup, Enterprise, and Data Warehouse Editions, Informix IDS, and WebSphere Application Server
 - ▶ Rebates up to \$148,000
- POWER5 models p5-590 and p5-595 w/ minimum 6 processors
 - ▶ Free 1-year warranty extension - from 1 year to 2 years
- http://www.ibm.com/products/specialoffers/us/en/pseries_servers.html

03 - Reduce Database Complexity and Improve Perf with DB2 2008 v3.0

39

IBM Balanced Warehouse

- Ready-to-go, pre-tested, integrated solution components of DB2 Warehouse, servers, and storage
- Three versions are available for enterprise-class customers
 - ▶ p5-575
 - ▶ Power 570
- Pre-tested with guaranteed performance
- These models were formerly called IBM Balanced Configuration Unit for AIX

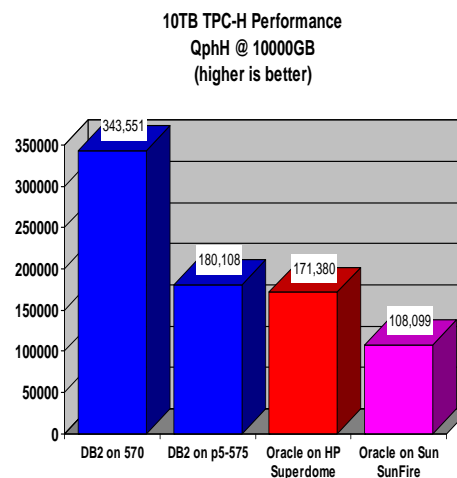

To learn more about the IBM Balanced Warehouse, visit ibm.com/software/bi

03 - Reduce Database Complexity and Improve Perf with DB2 2008 v3.0

40

