

Building a Better Infrastructure With IBM Middleware on System p

Reduce Database Complexity and
Improve Performance with IBM DB2

The Best Distributed Database Solution Is DB2 on System p

We have a lot of complicated
database systems in our
infrastructure.



**Service Oriented Finance
CIO**

The best distributed data
management solution you
can buy is DB2 on System p.
And you can save money by
scaling up. Here's how...



IBM

DB2 9.5 Server Editions

- Same code base
- Runs on System p

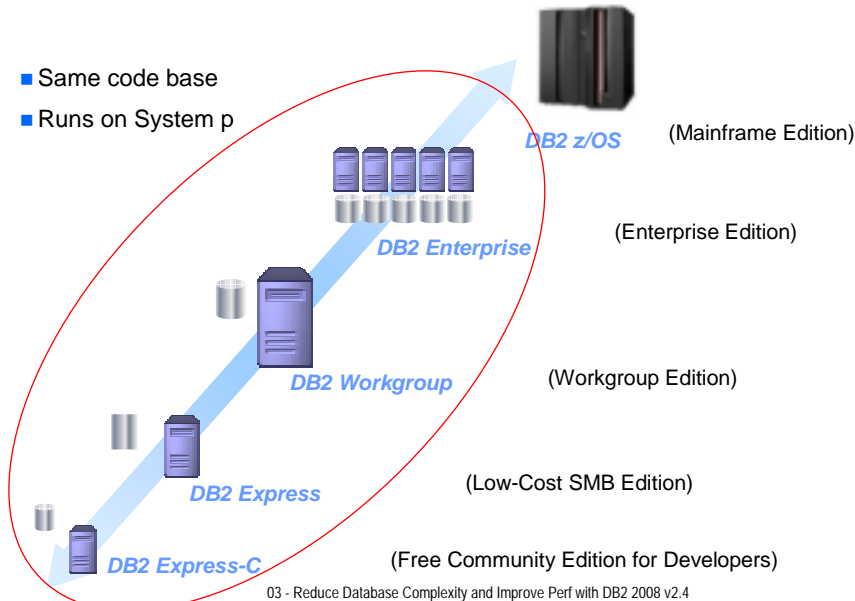

03 - Reduce Database Complexity and Improve Perf with DB2 2008 v2.4

3

DB2 Development Reference Platform

- IBM DB2 development uses DB2 + System p as the primary reference platform for development and testing
- DB2 is a key part of regression testing for all AIX maintenance roll-ups and vice versa
- A strong roadmap for joint AIX/DB2/System p exploitation in future releases

IBM Does the Integration Testing So You Don't Have To

03 - Reduce Database Complexity and Improve Perf with DB2 2008 v2.4

4

DB2 Gains Performance Benefits from Integration with System p and AIX

- Exploits IBM System p compilers and advanced optimization features
- Deep integration between AIX Workload Management (WLM) and DB2 WLM
 - ▶ Helps meet service levels and maintain predictable performance via work priority settings and finer levels of monitoring
- Exploits AIX Concurrent I/O and Direct I/O interfaces
- Uses AIX multi-page support that includes 64KB, 16MB and 16GB page sizes
- Optimized DB2 resource object alignment with System p architecture
- Exploits Simultaneous Multi-Threading (SMT)
- Judicious use of POWER processor cache line pre-fetching instructions to minimize memory access latencies

DB2 Benefits from AIX Management Features

- Storage Protection Keys
 - ▶ DB2 takes advantage of AIX storage protection keys
- Support for AIX Workload Partitions
- Dynamic Reconfiguration
 - ▶ Allows administrators to add and remove processors, memory and I/O adapters to and from LPARs, without disturbing business operations or applications
- Recovery Integration
 - ▶ DB2 recovery process with System p autonomic computing technologies
- First Failure Data Capture (FFDC) to capture failure data
 - ▶ Provides failure analysis and automated recovery capabilities
- Service Update Management Assistant (SUMA) tool
 - ▶ Allows administrators to automate downloads of operating system fixes and maintenance levels from the IBM eServer Support Fix Central Web site

DB2 Performance Benefits from Integration with IBM TotalStorage Devices

- I/O Priority
 - ▶ I/O Priority allows IBM TotalStorage DS8000 to favor AIX/DB2 workloads and reduce interference from lower priority activities

- Cooperative Caching
 - ▶ Enables more efficient use of memory resources in host and storage systems
 - ▶ Information is exchanged between DB2, AIX, and IBM DS8000 to increase the overall efficiency of memory across DB2 buffer pools and the storage system's cache

Oracle Cannot Match DB2 on System p

- Integration of DB2, AIX, and System p gives IBM an advantage in optimization
- Oracle is designed to run on a variety of commodity servers
- Oracle is designed to run on a variety of operating systems
- Oracle cannot match the specialized integration of DB2 with AIX and IBM System p servers

Reduce Data Center Complexity by Scaling Up

Scale Up
Workloads > Server

Simplify your DB!
DB2 on a System p SMP is simpler, easier to maintain, and costs less than an Oracle database or an Oracle RAC cluster.

Clusters: Email, Oracle RAC, Web Applications

Proliferation: Infrastructure, Applications

03 - Reduce Database Complexity and Improve Perf with DB2 2008 v2.4 9

DB2 and System p Deliver Superior Scalability

SCALE UP

SMP ✓

Uni's ✓

DB2

- DB2 Scales Up to 64 SMP processor cores on a single System p server
 - ▶ Near linear scalability up to 64-way SMP systems
- Support More Users on a Single Server

03 - Reduce Database Complexity and Improve Perf with DB2 2008 v2.4 10

DB2 Scales Near Linearly in System p Partitions

DB2 on 1 LPAR of System p 570

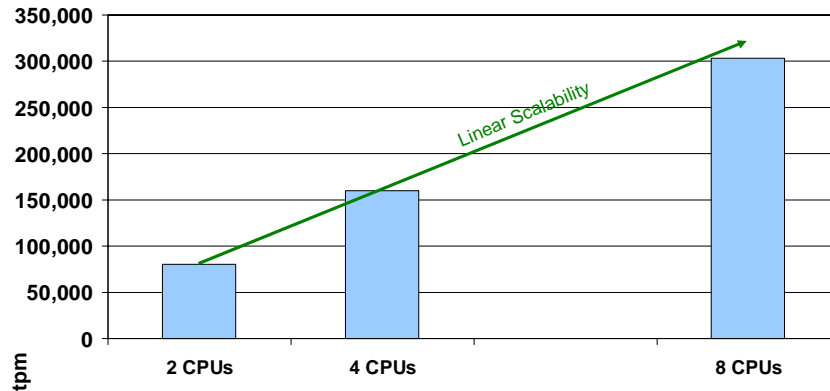

Benchmark Tests Performed by IBM Toronto Labs and Systems and Technology Group Using TPC-C-Like Workload, 2.2 GHz p5+, 2006

TPC Benchmarks Demonstrate DB2 Near Linear Scalability on System p

4x Cores, 3.93x Throughput

2x Cores, 2.00x Throughput

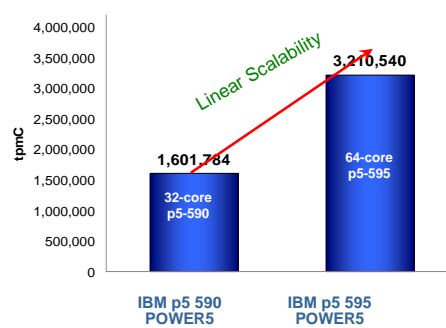
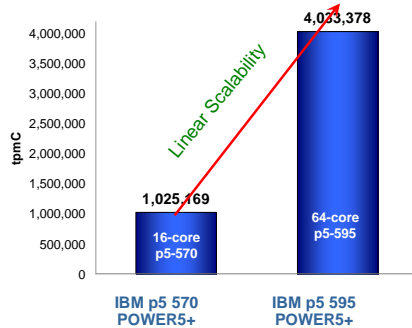

DB2 Benchmarks on System p POWER5+ DB2 Benchmarks on System p POWER5

Oracle RAC Adds Capacity and Scales by Clustering Commodity Servers (Nodes)

- Incoming requests are dispersed (sprayed) among the nodes
- Requires two separate networks
 - ▶ A private network for internal traffic between the nodes and the database
 - ▶ A public network for external communication and incoming requests
- Requires a single copy of the database in storage

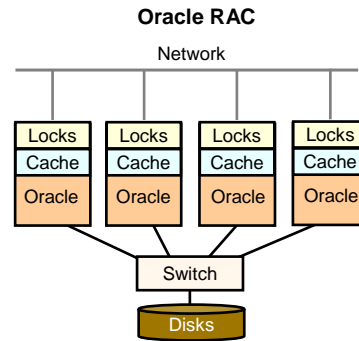

Oracle RAC Scale-Out Is Not Linear

- Two-Node RAC Scalability Test Performed by Performance Insight
 - ▶ SQL> CREATE TABLE TEST01 (C1 NUMBER ,C2 VARCHAR2(100));
 - ▶ SQL> CREATE INDEX IDX_TEST01 ON TEST01(C1);
- Simple insert/update/delete transactions
 - ▶ One node registered 723 transactions per second
 - ▶ Two nodes registered 489 transactions per second
- After Considerable Tuning with Index Redesign and Adding Query Hints
 - ▶ Scalability rose to 1.47x on 2 nodes
- After Rewriting the Application to Route Transactions
 - ▶ Scalability rose to 1.9x
- **“Scalability does not improve without application tuning”**

Adding One Node to Oracle RAC

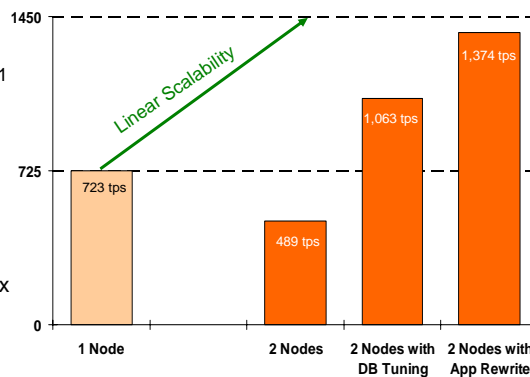

Source: Insight Technology Inc.:
<http://www.insight-tec.com/en/mailmagazine/vol136.html>

Why Is Oracle RAC Scalability Limited?

RAC Inefficiencies Increase as a Cluster Grows

- RAC nodes must constantly communicate to process requests to maintain distributed cache and lock data.
- Adding additional nodes to the cluster results in increased inter-node communication which requires additional local processor and network time.
- RAC distributed lock management overhead increases faster than the added capacity of more nodes.

Let's look at some examples...

Oracle RAC: Lock Management Overhead

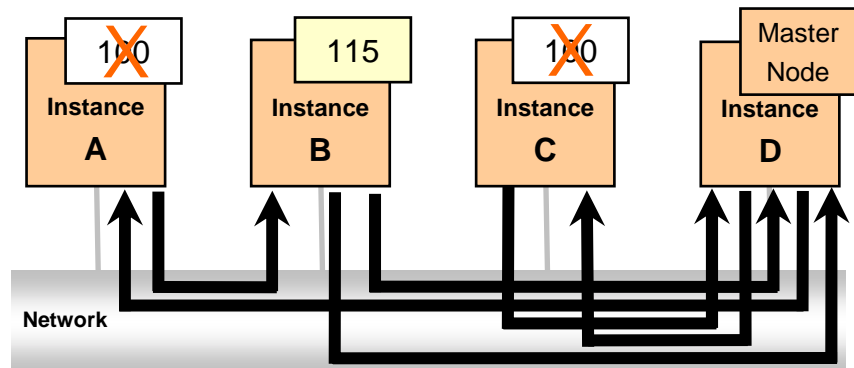

Lock Assume

7. B Updates local copy

Inter-node connections: 6

In a cluster with 4 nodes, an update operation may need 6 network connections and two in-memory calls (not shown).

Example based on Oracle's US Patent 7,107,319 B2.

Oracle Scale-Out Glass Ceiling

- DB2 provides near-linear SMP scalability on System p
- With Oracle RAC, overhead increases rapidly as additional nodes are added, and performance degrades significantly after only 4 to 6 nodes

Sources: "Scale-up versus scale-out using Oracle 10g with HP StorageWorks", Hewlett-Packard, 2005;
 "Enterprise Data Base Clustering Solutions" ITG, October 2003;
 Benchmark tests, IBM Toronto Labs and Systems and Technology Group, using TPC-C-like workload, 2.2 GHz p5+, 2006
 System p TPC Benchmarks

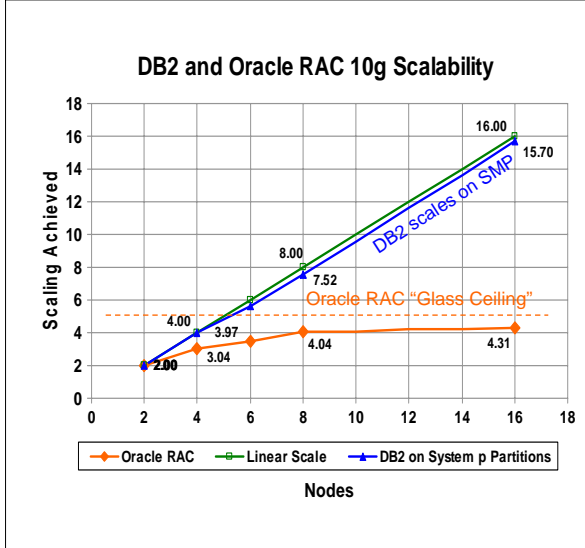

Oracle RAC Overhead Wastes Processing Power in Each Node

Oracle RAC source: "Scale-up versus scale-out using Oracle 10g with HP StorageWorks", Hewlett-Packard, 2005

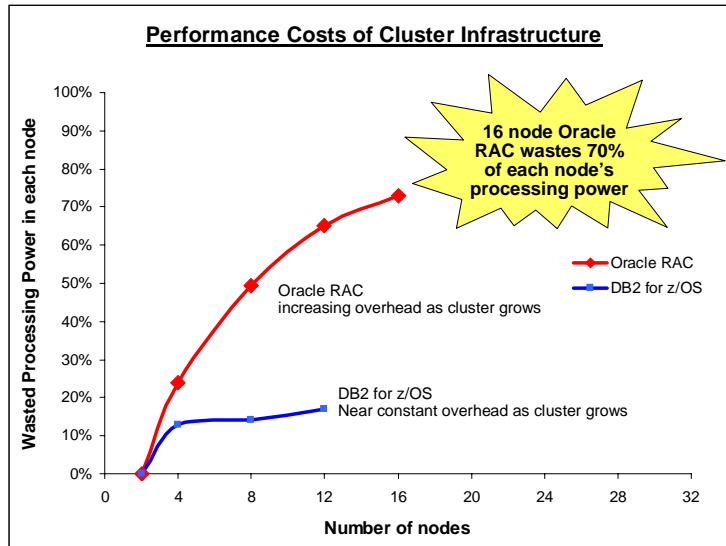

DB2 High Availability and Disaster Recovery (HADR) Is Better Than Oracle RAC's

- DB2 HADR provides high availability and fast failover
 - **Failover in less than 15 seconds**
 - **Real SAP workload failover for 600 SAP users performed in 11 seconds**
 - Storage mirror survives disaster
 - Buffer pool primed on Standby with recent updates
 - 100% performance after server failure
 - Uses ordinary network and storage devices
- RAC failover is delayed due to remastering of distributed locks
 - Only one copy of storage
 - Degraded performance after server failure
 - Pay for Oracle RAC for every node
 - Specialized network storage raises cost of ownership, erodes any savings from commodity servers

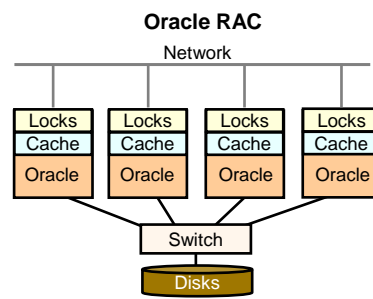
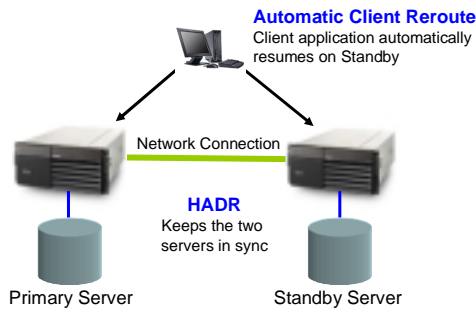

03 - Reduce Database Complexity and Improve Perf with DB2 2008 v2.4

19

DB2 Features Reduce Planned Outages

- Database changes can be made while the database is running
 - ▶ Table or column changes, type and length
 - ▶ Dynamic adding and rotating partitions
- Housekeeping operations can be performed without taking down the database
 - ▶ Image copy, backups can be performed with the database running
- Performance adjustment changes can be made while running
 - ▶ Reorganization of the database
 - ▶ Secondary index partitioning
 - ▶ Partition without an index; cluster on any index
 - ▶ Online database parameter changes

03 - Reduce Database Complexity and Improve Perf with DB2 2008 v2.4

20

Oracle Security Flaws and Patches

- **ComputerWorld - 10/17/2006**
"Oracle releases 101 patches in quarterly update" including **63** for database
- **C/NET - 1/17/2007**
"Oracle plugs 51 security flaws" including **26** for database
- **eWeek.com – 7/17/2007**
45 security patches, including **17** for database
- **ComputerWorld - 9/3/2007**
"Expert finds 'stupid' vulnerabilities in Oracle 11g"
- **eWeek.com – 10/16/2007**
51 security patches, including **27** for database
- **eWeek.com – 1/15/2008**
26 security patches, including **9** for database
- **500+ Patches for Oracle 10g in 12 Months**
From January 18, 2007, to January 18, 2007, there were more than 500 recommended patches posted for the most stable version (10.2.0.3) of the Oracle 10g database – patches can be downloaded from metalink.oracle.com



03 - Reduce Database Complexity and Improve Perf with DB2 2008 v2.4

21

DB2 Data Compression Beats Oracle

- Head-to-Head Compression Test on Standard Database
 - ▶ TPC-H is a well-known data warehouse benchmark
 - ▶ Each vendor uses the same tables and data
 - ▶ Oracle published their compression rates for TPC-H tables at the VLDB conference in 2003
 - ▶ IBM ran the same tests on the same tables

Test Results – DB2 Reduces Cost by Requiring Less Storage

| Table | Reduction in Storage Required | |
|-----------------|-------------------------------|-------------------|
| | Oracle | DB2 |
| LINEITEM | 38% | 58% (1.5x better) |
| ORDERS | 18% | 60% (3x better) |
| Entire Database | 29% | 59% (2x better) |

03 - Reduce Database Complexity and Improve Perf with DB2 2008 v2.4

22

AutoZone Cuts Costs with DB2 Data Compression

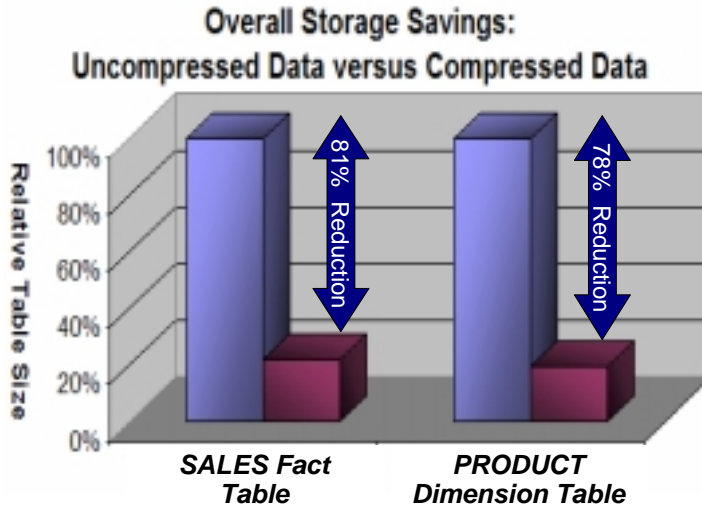

03 - Reduce Database Complexity and Improve Perf with DB2 2008 v2.4



23

Tellabs Reduces SAP Database by 83%

REAL WORLD BENEFITS

Tests showed a 43% and 83% reduction of SAP tables. Benefits include reduced storage space and increased performance. Also freed up valuable floor space and reduced costs for heating and cooling.

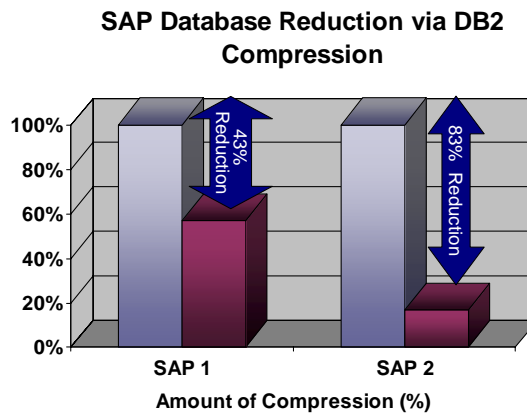

"We needed a database that represented the future, and DB2 9 is the future. DB2 9 compression capabilities are key in helping reduce the size of our databases—in one case by up to 83 percent. This ultimately helps us minimize storage costs and increase performance." — Jean Holley, CIO, Tellabs, Inc.

03 - Reduce Database Complexity and Improve Perf with DB2 2008 v2.4

24

DB2 Simplified Maintenance

Everyday Tasks Are Simply Automatic!

- Statistics Collection
- Backup
- Table Reorganization

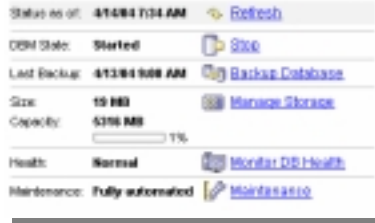

**No need to wonder
when it's time to run
these utilities.**

It's Automatic!

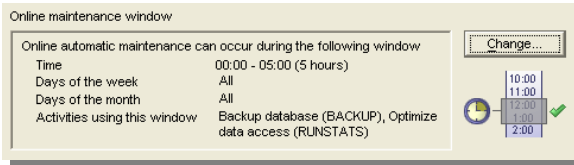

DB2 Adaptive Self-Tuning Memory

Increases Business Value, Decreases DBA Tuning Tasks

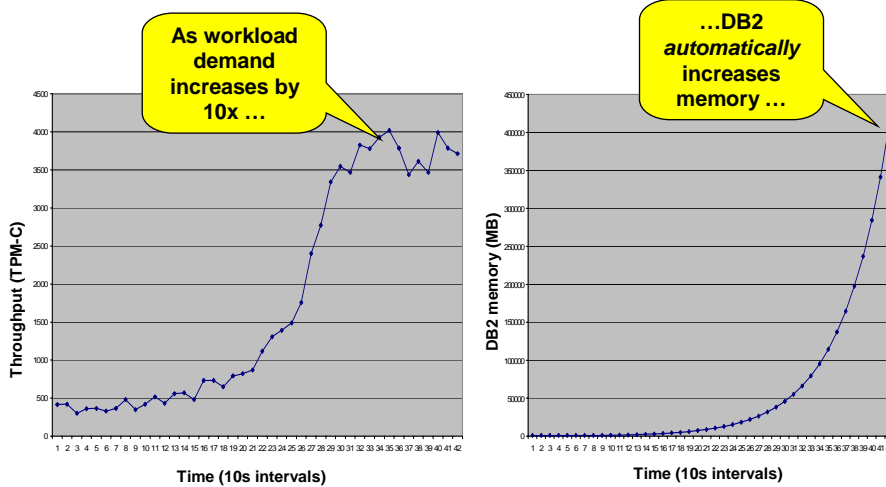

Customers See DB2 Administration Benefits

“There’s far less administration involved with DB2 than with Oracle.” **BOC runs “50-100 SAP systems,” supported by 12 people**
“That is really quite extraordinary.” - Sheila Moran at BOC in UK

“DB2 requires significantly less database administration than Oracle. **We can now deploy our IT staff for more productive and business-critical needs**” - Zdenek Vosahlo, Head of IT at Precheza

■ Oracle RAC is difficult to deploy and maintain

- ▶ Oracle encourages customers to use Oracle Consulting or a certified implementation partner
- ▶ Rigid certification for support—hardware and software must be certified by Oracle
- ▶ Administrators must bring cluster down to install quarterly patches
- ▶ Two days to install a 2-node RAC cluster (vs 4-hour unattended install for DB2)*

* Source: IBM Competitive Technology Lab

DEMO: Administration Made Easy

DB2 9 Autonomics in Action

1. Health Center - Simplify Administration
 - ▶ Show how the health center can determine the status of database systems
 - ▶ Show Alarm and Warning alerts and Recommendation Advisor
 - ▶ Show how you customize settings for alerts
 - ▶ Show how alerts are set to go to e-mail
2. Control Center
 - ▶ Self Tuning - Show options for Automatic Memory and Space Management

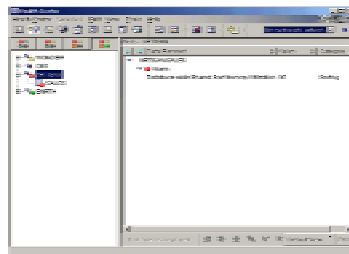

Ease of Administration – Big Part of TCO

Solitaire Interglobal Study - Staffing
Real world study of 250 sites

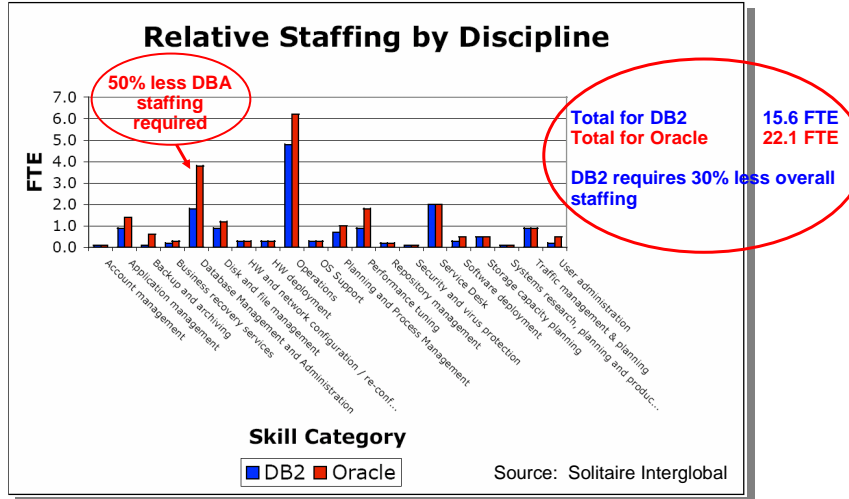

Remove Database Clutter by Scaling Up Large Database Workloads on System p

By scaling up on System p you can reduce your Oracle RAC database clutter...and save money while gaining performance.

That's music to my ears....



IBM



Service Oriented Finance
CIO

Migrate Oracle RAC to DB2 on System p

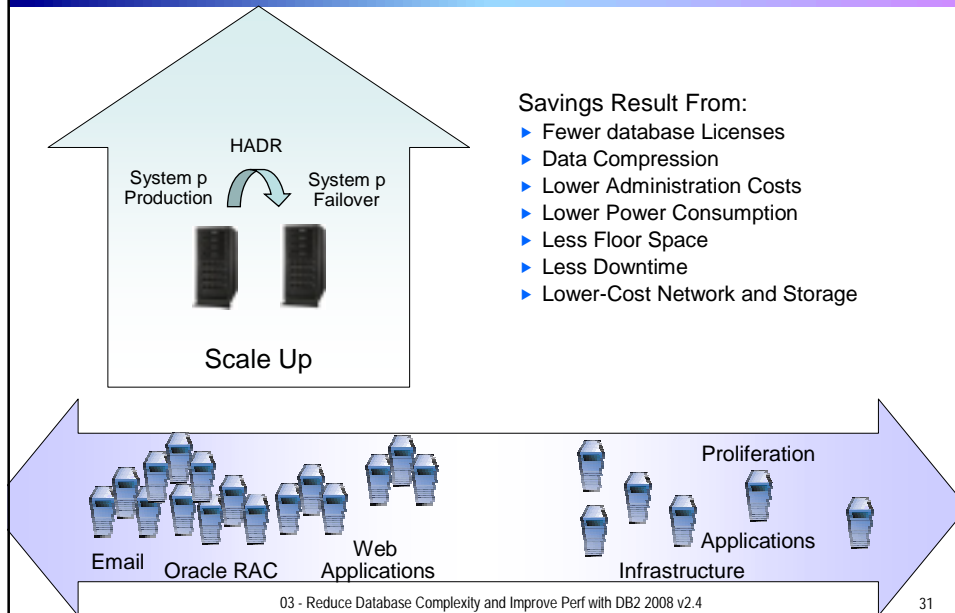

Cost Comparison: Replace Oracle RAC on Sun with DB2 on System p with HADR

| 3-Year TCO | Oracle 11g RAC running on 4 SunFire E2900's** | DB2 HADR running on 2 System p 570's* |
|--------------------------------------------------------|-----------------------------------------------------------------|-------------------------------------------------------------|
| Cores | 24 per server (96 total) | 16 per server, 2 active cores on backup server |
| Relative Performance Estimate (RPE) | 8,830 RPEs per server X 4 X 0.7 (RAC scalability) = 24,724 RPEs | 25,020 per active server 25,020 per backup server |
| Server Hardware + 3 Years Maintenance | \$2,040,364 | \$849,152 for active server \$392,444 for backup server |
| Software + 3 Years Support | \$9,083,520 | \$1,059,374 for active server \$68,790 for backup server |
| Storage + 3 Years Maintenance (2TB before compression) | \$77,095 | \$58,240 for active server \$58,240 for backup server |
| Total Cost | \$11,200,979 | \$2,486,240 |

* Two mirrored 16-core System p6 570s w/ 4.70 GHz POWER 6 CPUs running AIX.
** Oracle 11g + RAC running on a cluster of 4 SunFire 24-core E2900s w/ 1.95 GHz CPUs running Solaris, with a scaling efficiency of 0.75.

Price Sources—System p 570 and maintenance, System p storage (IBM DS4700 RAID device) and maintenance: IBM Technical Sales; DB2 UDB 9 and support: IBM.com Passport Advantage Express Software Catalog, SunFire E2900: <http://shop.sun.com>; Oracle 10g + RAC: Oracle.com, Oracle Technology Global Price List, September 4, 2007; SunFire storage (Sun StorageTek 6140 Array) and maintenance: <http://shop.sun.com>.

Cash Flow: Replace Oracle RAC on Sun with DB2 on System p with HADR

DB2 on System p One-Time Charge

| | |
|--------------------------------------|--------------------|
| Server Acquisition | \$1,091,620 |
| Disk Acquisition | \$116,480 |
| Software Licenses | \$790,660 |
| Migration Cost | \$67,400 |
| Total OTC (Cost of migration) | \$2,066,160 |

Price Sources—DB2 on System p: server acquisition, annual server maintenance, disk acquisition, and annual disk storage: IBM.com Passport Advantage Express Software Catalog; power: IBM study, Project Green. Oracle RAC on Sun: annual server maintenance: Ideas International; annual disk storage maintenance: http://shop.sun.com; annual software support: Oracle.com, Oracle Technology Global Price List, September 4, 2007. (All others: ECM)

DB2 on System p Annual Cost

| | Year 1 | Years 2+ |
|---------------------------------|------------------|------------------|
| Power and Cooling | \$7,688 | \$7,688 |
| Annual Server Maint. | \$49,992 | \$49,992 |
| Annual Disk Storage Maintenance | \$9,600 | \$9,600 |
| Annual SW Support | \$15,030 | \$168,752 |
| Annual System Administration | \$28,503 | \$28,503 |
| Total Annual Cost | \$110,813 | \$264,535 |

Oracle RAC on Sun Annual Cost

| | Year 1 | Years 2+ |
|---------------------------------|--------------------|--------------------|
| Power and Cooling | \$15,148 | \$15,148 |
| Annual Server Maint. | \$40,128 | \$40,128 |
| Annual Disk Storage Maintenance | \$11,113 | \$11,113 |
| Annual SW Support | \$1,203,840 | \$1,203,840 |
| Annual System Administration | \$81,436 | \$81,436 |
| Total Annual Cost | \$1,351,664 | \$1,351,664 |

Lower annual operational costs yield breakeven in less than 2 years

03 - Reduce Database Complexity and Improve Perf with DB2 2008 v2.4

33

Breakeven in Less Than 2 Years

Cash Flow Analysis

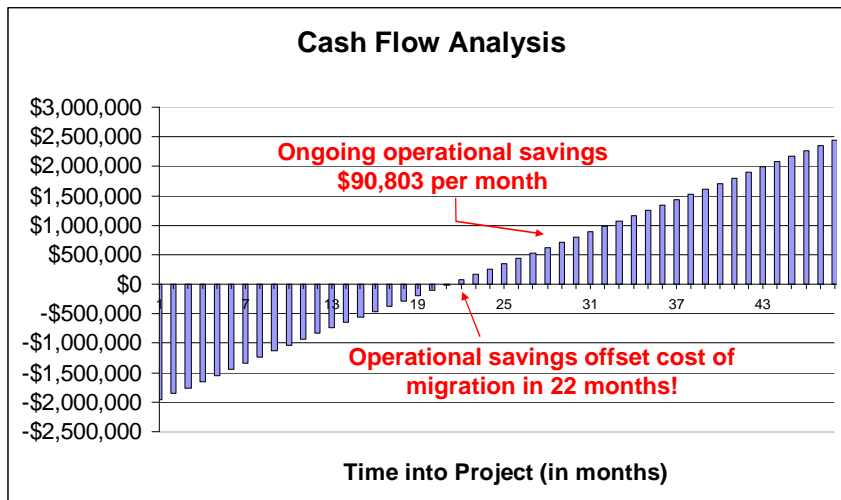

03 - Reduce Database Complexity and Improve Perf with DB2 2008 v2.4

34

Oracle to DB2 Migration Made Easy by IBM

- Migration Toolkit (MTK) - inspects Oracle database and migrates DML components, which are the tables, views, and indexes, then uses SQL Select to retrieve and load the data into the DB2 database
- 3rd-Party Tools help perform Oracle PLSQL code migration - Quintessence, Ciphersoft
- Some projects are done with the help of IBM services

DEMO: Migrate an Oracle Database to DB2

1. IBM Migration Toolkit

- ▶ Using the Wizard, introspect an Oracle database to create a mirror image for DB2 of tables, views and indexes
- ▶ Deploy the database to DB2

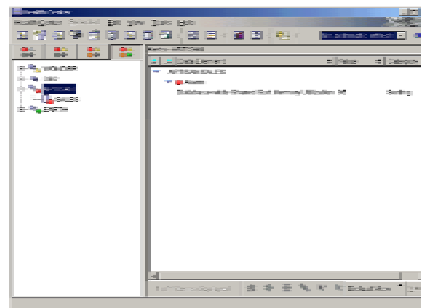

Migrate from Oracle Survey

“In a survey of IT professionals using Oracle, 48% of respondents said they are considering alternatives to Oracle more seriously than they were just one year ago. Why? **73% of them pointed to the high cost of running Oracle.**”

Source: SearchOracle.com Member Survey Results, May 31, 2007
http://searchoracle.techtarget.com/originalContent/0,289142,sid41_gci1257550,00.html

And now we have some special offers!



IBM

IBM Software and System p Special Offers

Rebates When You Buy IBM Middleware on System p5 Models

- System p5 models 520, 550, 560, 570, 575, 590, 595
 - ▶ Rebates up to \$300,000
- DB2 Workgroup, Enterprise, and Data Warehouse Editions, Informix IDS, and WebSphere Application Server
 - ▶ Rebates up to \$148,000
- System p5-590 and 595 w/ minimum 6 processors
 - ▶ Free 1-year warranty extension - from 1 year to 2 years
- http://www.ibm.com/products/specialoffers/us/en/pseries_servers.html

03 - Reduce Database Complexity and Improve Perf with DB2 2008 v2.4

39

IBM Balanced Warehouse

- Ready-to-go, pre-tested, integrated solution components of DB2 Warehouse, Servers, and Storage
- Three versions are available for Enterprise class customers
 - ▶ System p5-575
 - ▶ System p 570
- Pre-tested with guaranteed performance
- These models were formerly called IBM Balanced Configuration Unit for AIX

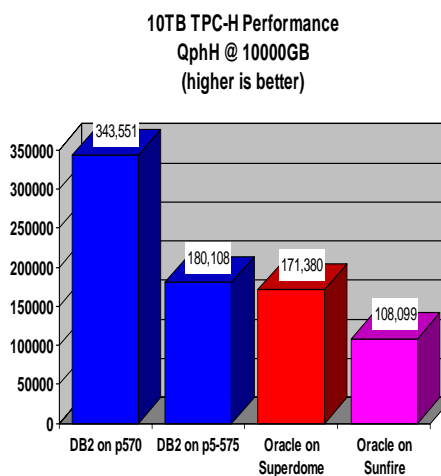

To learn more about the IBM Balanced Warehouse, visit ibm.com/software/bi

03 - Reduce Database Complexity and Improve Perf with DB2 2008 v2.4

40

