





Building a Better Infrastructure With IBM Middleware on IBM Power Systems

POWER Hardware Improves Utilization
and Reduces Costs

At the Heart of IBM Power Systems is the POWER™ Processor

2001 POWER4™	2003 POWER4+™	2004 POWER5™	2006 POWER5+™	2007 POWER6™	Future* POWER7™	<i>General Purpose Processors</i>
						

PowerPC 405	PowerPC 440	Cell/B.E	Cell/B.E	Cell/B.E. +*	<i>Specialty Engines</i>
					



Game Systems **Blades** **Entry Level to High-end Servers** **High Performance Computers**

*All statements regarding IBM's future direction and intent are subject to change or withdrawal without notice, and represent goals and objectives only.

The POWER Processor Is Everywhere

The POWER processor is used in everything from game systems to special purpose high performance computers.

- ▶ Largest UNIX systems market share
- ▶ 47% of world's fastest computers (Top500)
- ▶ 50% of automobiles worldwide
- ▶ All of the top three game consoles
 - Playstation 3, Xbox 360, Wii
- ▶ Power.org consortium

Quiz: What Does the Acronym **POWER**, Represent?

- A. **P**ackets **O**f **W**ebSphere **E**ngineered **R**equests
- B. **P**erformance **O**ptimized **W**orkloads **E**ngineered **R**esilient
- C. **P**rocessor **O**ptimized **W**ith **E**nergy **R**eduction
- D. **P**erformance **O**ptimized **W**ith **E**nhanced **R**ISC
- E. **P**rogrammatic **O**ctal **W**avelengths **E**lectromagnetically **R**efined

POWER Architectural Concepts – Multi-core

- Why multi-core?
 - ▶ Laws of physics catching up with single processor chips, it is no longer a matter of simply increasing speed to increase performance
 - ▶ Chip manufacturing density enables more than one central processing unit (CPU) to be placed on a single processor chip or socket
- Each central processing unit is referred to as a “core”*
- Each core presents itself as an independent central processing unit

Dual-core POWER6 processor chip

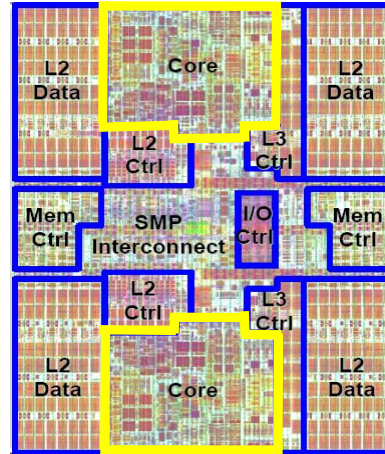

* CPU = core

02 - POWER Hardware 2008 v3.0

5

Processor Concepts - Single Thread Execution

Four instruction threads in memory, waiting to be executed

The processor fetches instructions from a single thread and continues to execute instructions from that thread until a decision is made to execute another thread

Popular design, but branches and data fetches cause idle CPU cycles

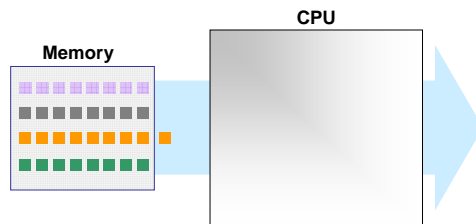

02 - POWER Hardware 2008 v3.0

6

Processor Concepts – Symmetric Multi-processing (SMP)

Four instruction threads in memory, waiting to be executed

Each processor fetches instructions from a single thread

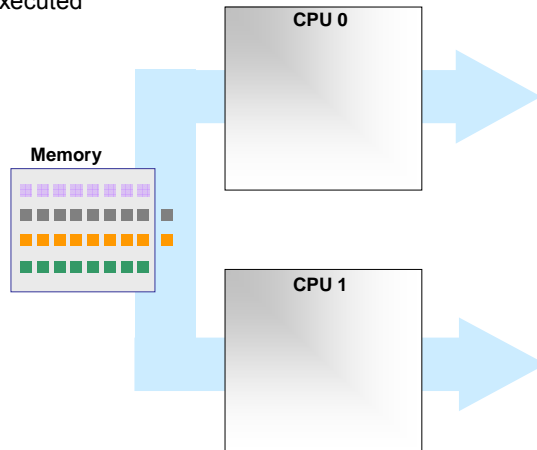

- Achieves higher overall throughput by utilizing all available CPUs
 - ▶ Operating system assigns threads to CPUs
 - ▶ Still single thread execution with idle cycles within each CPU
- Power Systems are architecturally engineered to exploit full SMP function up to the largest number of processors
 - ▶ Hardware
 - ▶ Virtualization

POWER Architectural Concepts – Simultaneous Multi-threading (SMT)

Four instruction threads in memory, waiting to be executed

Each processor presents itself as two virtual processors to the operating system and fetches instructions from two threads.

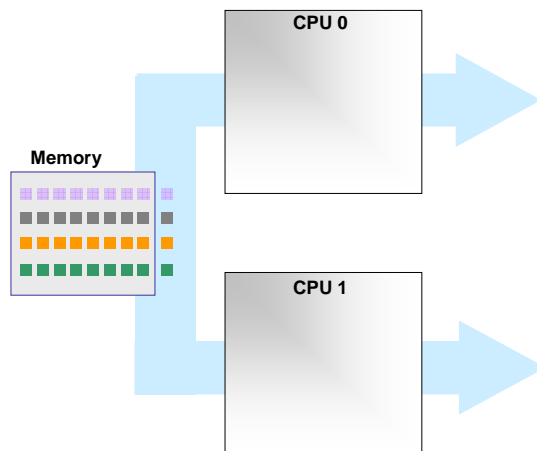

- Instructions from both threads are executed in each processor concurrently
- Utilizes unused CPU cycles

Simultaneous Multi-threading (SMT) Delivers More Processing Power

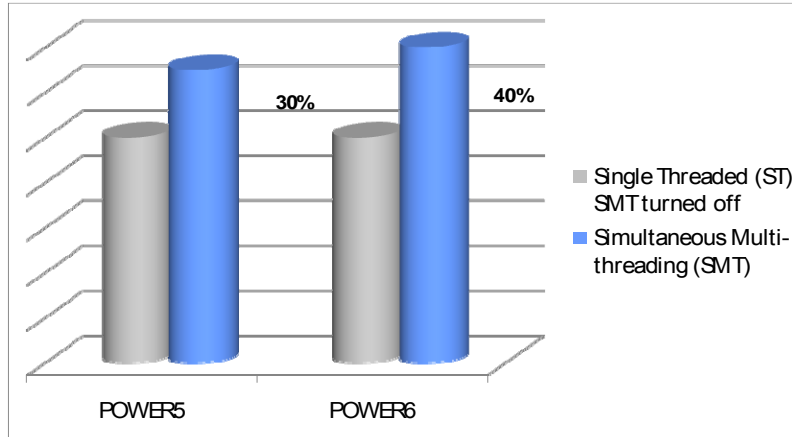

- Net result
 - ▶ Better performance and processor utilization increases throughput and response time, depending on workload

02 - POWER Hardware 2008 v3.0

9

Power Systems Architectural Concepts – Server Virtualization

- Run multiple operating system images on a single platform
 - ▶ Like having several separate servers running simultaneously
- Each image runs in a logical partition
- The POWER Hypervisor™ shares the underlying physical resources dynamically among the partitions

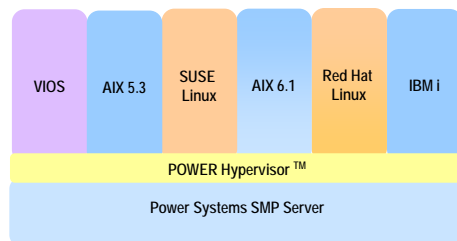

**Dynamically shared physical
resources in a single platform**

**We will discuss virtualization
and consolidation in more
detail later today.**



IBM

02 - POWER Hardware 2008 v3.0

10

IBM Power Systems Has a Complete Line of Servers for Your Data Center*

BladeCenter® JS22 Express
4 cores

BladeCenter® JS12 Express
2 cores

Power 520 Express
1 to 4 cores

Power 550 Express
2 to 8 cores

Power 570
1 to 4
2-core or 4-core nodes

Power 575
1 to 14
32-core nodes

Power 595
1 to 8
8-core nodes

2007 Nikkei Superior Products and Service Award

DATAMATION
PRODUCT OF THE YEAR

* This illustration does not include all Power Systems models.

02 - POWER Hardware 2008 v3.0

11

Quiz: What Is a Grand Slam?

- A. In tennis, a singles player or doubles team that wins all four Grand Slam event titles in the same year.
- B. In baseball, a Grand Slam is a home run with all of the bases occupied.
- C. In computing, a Grand Slam is being the performance leader in four major benchmarks at the same time.
- D. A breakfast item on the menu at Denny's restaurant.
- E. All of the above

IBM Power Systems with POWER6 "Grand Slam" for Major Workloads

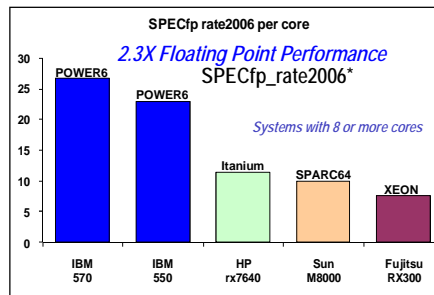
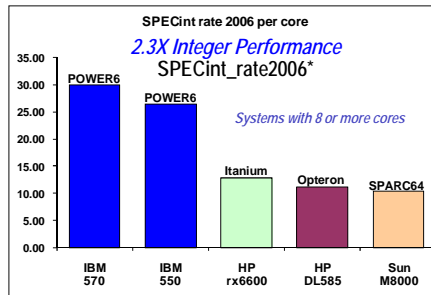
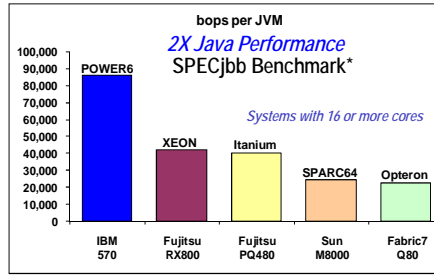
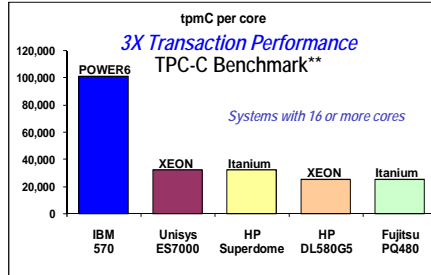

* Source: www.spec.org
** Source: www.tpc.org

Not Just a Grand Slam, It Is a "Slam Dunk," Power Systems Versus The Best Competitive Result

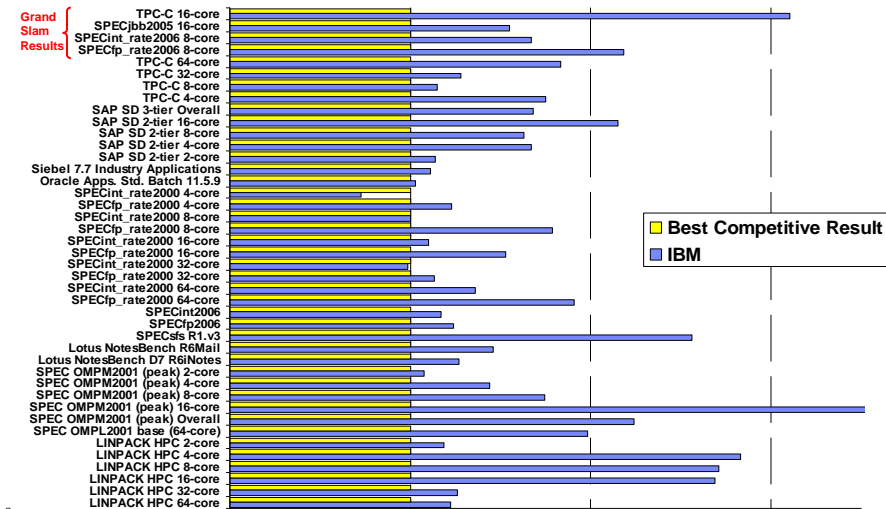

Source:
<http://www.spec.org>
<http://www.tpc.org>
<http://www.sap.com/benchmark/>
http://performance.siebel.com/performance/html/PDS/sgo_r6.htm
 For a complete list of all IBM POWER results, go to <http://ibm.com/systems/o/benchmark>

Power Systems with POWER6 Delivers More Than Just Lightning Fast Processor Speed

- Breaks the 4 GHz milestone within the same energy envelope as POWER5
- On-chip energy efficiency intelligence for dynamic energy savings
- Balanced design with highest system bandwidth
- Integrated hardware accelerators for specialized performance
- Designed for continuous availability

Power Systems Support Standard Programming Interfaces In a Flexible Ecosystem

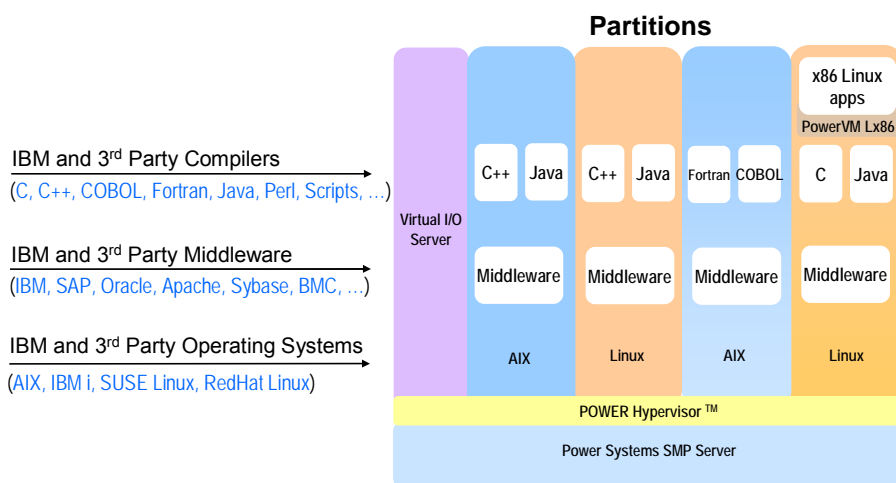

Survey of 277 Enterprise Customers Rank AIX the Best

- AIX has a long history of binary compatibility
Binary Compatibility Guarantee: <http://www-03.ibm.com/systems/p/os/aix/compatibility/>
- More than 8000 applications from 3000+ software vendors

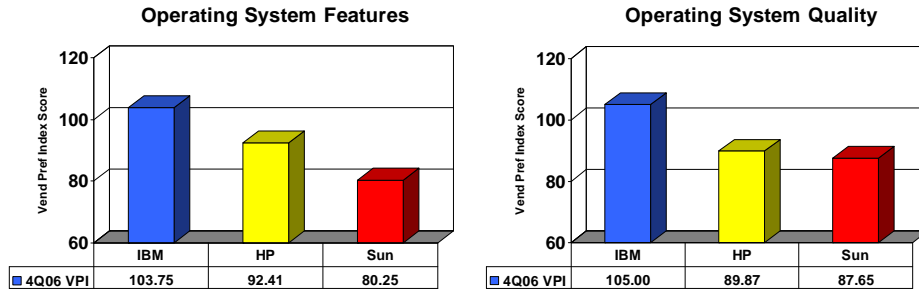

Source: UNIX Vendor Preference Survey, Gabriel Consulting Group, December 2006.

AIX Leads Competitors in Operating System Downtime Comparison

(400 participants in 27 countries)

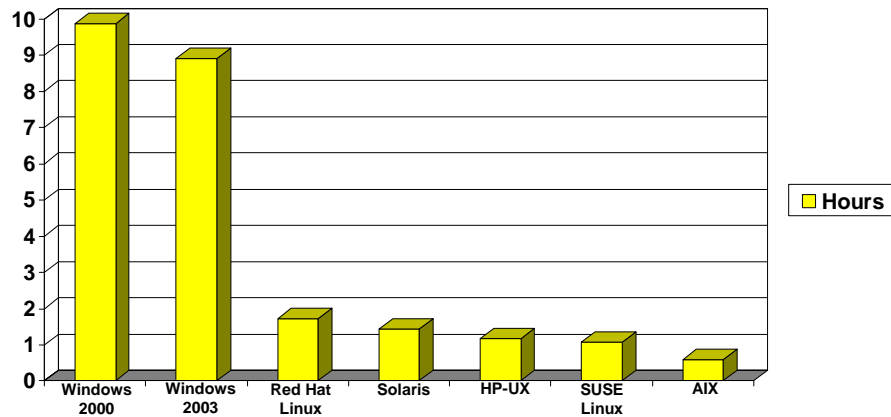

Source: 2007-2008 Global Server Operating Systems Reliability Survey, Yankee Group, March 2008. As quoted in "Windows Server: The New King of Downtime" by Mark Joseph Edwards at www.windowsitpro.com/article/articleid/98475/windows-server-the-new-king-of-downtime.html, March 5, 2008 and in <http://www.sunbeltsoftware.com/stu/Yankee-Group-2007-2008-Server-Reliability.pdf>. Measured in hours per year.

Power Systems User Interfaces

Command Interface on ASCII Terminal



Command Interface on ASCII Emulator

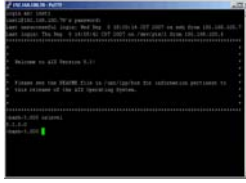

X Windows Server with Power Systems

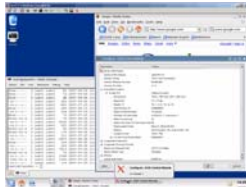

ASCII Terminal

ASCII Emulator

Desktop OS

X Windows Server

Desktop OS

Server Application



Power 570

DEMO: Demonstrations in Partitions on One Power Systems p5-505

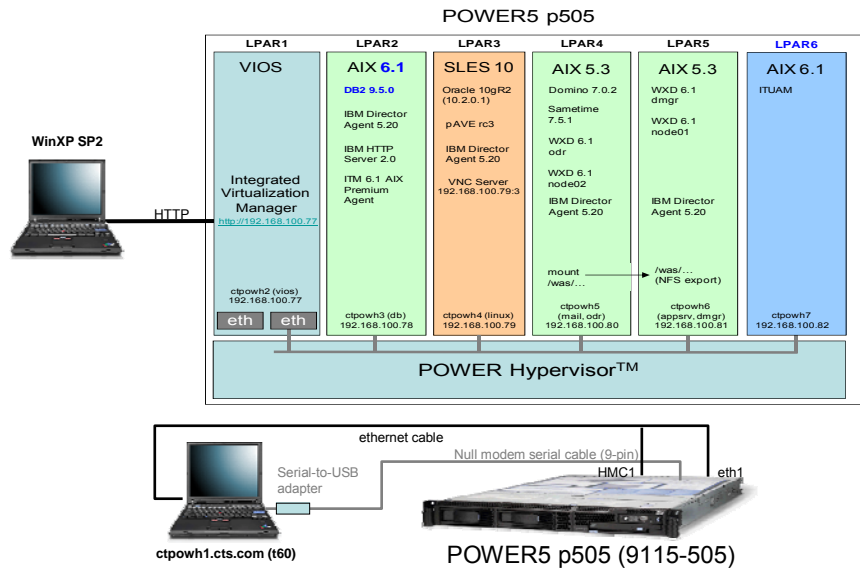

Cool Blue Power Systems Are Environmentally Friendly

- Energy efficiency management functions for POWER6 chips
 - ▶ Power reduction
 - ▶ Nap mode
 - ▶ Thermal tuning
- Energy efficiency management and control functions in the new Power Systems with EnergyScale
 - ▶ Enhanced design and implementation
 - ▶ Variable fan speed
 - ▶ Power off PCI slots when not in use
 - ▶ Rear door heat exchanger
 - ▶ System energy efficiency management software
- Consolidation and virtualization inherently reduce energy requirements



IBM Energy Efficiency Self Assessment Tool: http://www.ibm.com/itsolutions/optimize/cost_efficiency/energy_efficiency/services.html

02 - POWER Hardware 2008 v3.0

22

Cool Blue Power Systems Are Green

- IBM Project Green - The IBM Energy Efficiency Initiative
 1. Best practices and services
 2. Technology and management innovations
 3. Environmental responsibility
- The innovation green design of the Power 570 saves energy

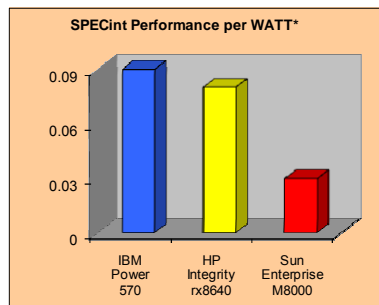

The top 26 most energy efficient computers are Power processor based systems (Green500).**

* Performance per WATT based on dividing SPECint_rate2006 performance by vendor recommended maximum power requirement.

Source: www.spec.org
** Only systems where measured power is available.
Source: <http://www.green500.org/>

02 - POWER Hardware 2008 v3.0

23

What Is Power Systems Capacity Upgrade on Demand?



Power 570
2-16 cores
2-768 Gb RAM

Customer orders Power 570* with maximum cores and memory, but with only half activated

Only pay in full for active resources and get 65% discount to cover the cost of unactivated processors

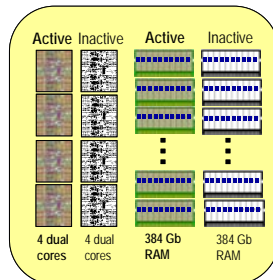

Customer determines they need additional capacity for their workload and activates** remaining processors and memory

Additional payment required for newly activated resources, total cost is the same as if all hardware was activated at the time of the original purchase

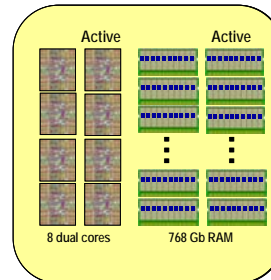

* System optional capacity options do not require purchase of a new system. Assumes appropriate storage, IO drawers, software licensing, etc. for the configuration. Only processors and memory are shown here as an illustration.

** Activation occurs via one of the optional capacity options available for Power Systems. Not all processors or memory need to be activated at one time. This was done as an illustration

Four Other Capacity on Demand Options Are Available

- Capacity Upgrade on Demand (processors, memory)
 - ▶ Activate capacity permanently for non-disruptive growth
- On/Off Capacity on Demand (processors, memory)
 - ▶ Temporary capacity for fluctuating workloads
- Trial Capacity on Demand (processors)
 - ▶ Temporary capacity for workload testing or any one time need
- Utility Capacity on Demand (processor minutes)
 - ▶ Autonomic, charges based on measured workload
- Capacity Backup (processors, memory)
 - ▶ Only pay for installed disaster recovery capacity when used
 - ▶ Can be used with PowerHA Cluster Manager and PowerHA Cluster Manager/XD software in failover scenarios

Power Systems Reliability

- Error detection
 - ▶ Predictive failure analysis on processors, caches, memory, I/O and DASD
- Built-in redundancy
 - ▶ Redundant power supplies, fans, service processor
- Processor instruction retry
 - ▶ Transparent retry of soft errors on application fault
- Storage protection keys
 - ▶ POWER6 storage keys will isolate data and protect against memory overlay that can cause subtle, intermittent problems
- First Failure Data Capture (FFDC)
 - ▶ Automatic capture of diagnostic information

Power Systems Serviceability

- AIX supports concurrent maintenance
 - ▶ Non-disruptive fixes to AIX
 - ▶ No downtime (reboot) required to apply fix and make it active
- Hot swappable parts replacement
- Electronic Service Agent (ESA)
 - ▶ Automatically contact IBM if problem



ESA runs automatically in the background!

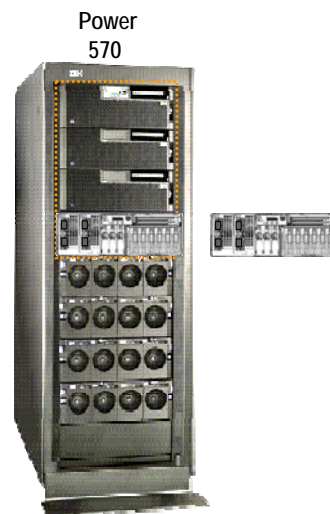

PowerHA Cluster Manager Increases Availability

- PowerHA Cluster Manager manages Resource Groups
- Resource Groups move from one node to the other when an event happens
- Resources in a group could be one of the following
 - ▶ Applications, Disk Drives, Volume Groups, File Systems, NFS File Systems, Tape Drives, IP Addresses, Replicated Resources
- AIX and Linux support

PowerHA Cluster Manager with Failover

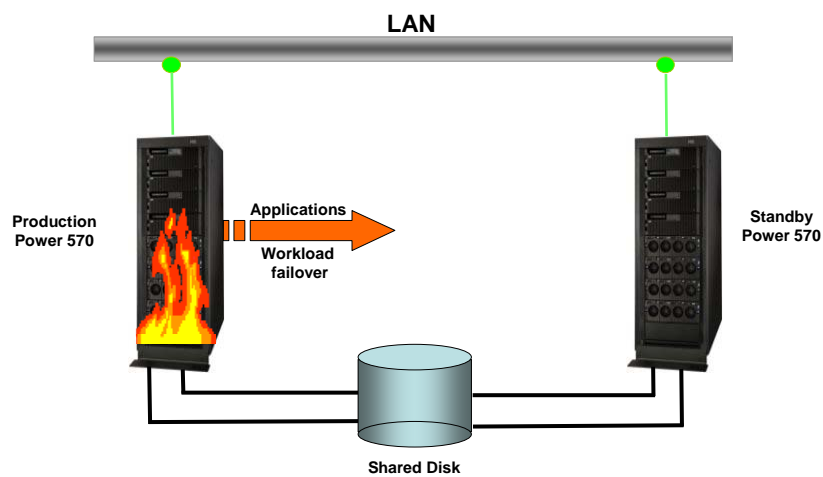

PowerHA Cluster Manager/XD (Extended Distance) Provides Disaster Recovery

- Provides high availability and disaster recovery solutions
 - ▶ Recovers locally or moves entire application to backup site
- Integrates PowerHA Cluster Manager with unique data replication code to provide a fully automated solution
- Resources automatically failover to surviving node, no manual steps required
- Clusters
 - ▶ Campus wide – resources in multiple buildings, customer owns network
 - ▶ Metro wide – separate datacenters within same metro area, local network provider
 - ▶ Unlimited – datacenters in different states or countries, leased line networks
- Setup typically requires IBM services

02 - POWER Hardware 2008 v3.0

30

PowerHA Cluster Manager/XD Can Provide Data Center Level Disaster Recovery

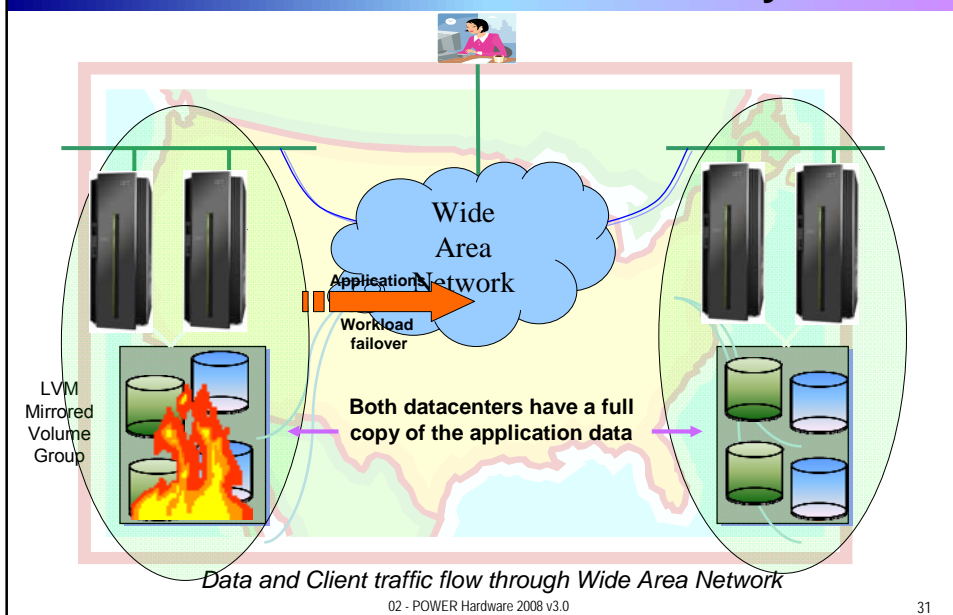

02 - POWER Hardware 2008 v3.0

31

Compare the Competition

	IBM ★ Power Systems	Sun Families	HP Families
Processor speed within an energy envelope	✓	Slower	Slower
Integrated energy efficiency functions	✓	Future	Future
Overall, price/performance	✓	Higher Cost	Higher Cost
Integrated hardware decimal floating point	✓	No	No
Integrated RAS functions	✓	Partial	Partial
Single unified processor architecture	✓	No (SPARC, UltraSPARC, SPARC64)	No (Itanium, PA-RISC)
Integrated virtualization assists	✓	Only UltraSPARC T1,T2	Only With Itanium (Limited Capability)
Has gone to Mars	✓	No	No

02 - POWER Hardware 2008 v3.0

32

POWER Processor Has Gone To Mars!

NASA's New Phoenix Lander



The Phoenix Lander is powered by a processor based on the POWER Architecture, similar to the one used in Sony's PlayStation 3.

02 - POWER Hardware 2008 v3.0

33

