



What System z Can Do That Intel Can't

**The New zEnterprise –
A Cost-Busting Platform**

What System z Can Do That Intel Can't

1. Run Bigger and More Workloads



Intel Sandy Bridge



System z

System z Delivers More Raw Processing Capacity Than Intel

<i>World's fastest clock speed</i>	5.5 GHz
<i>Total cores</i>	120
<i>Configurable cores</i>	101
<i>General processor core performance</i>	1,514 MIPS
<i>Specialty processor core performance</i>	1,514 MIPS
<i>Total Capacity</i>	78,426 MIPS



zEC12



Intel Sandy Bridge

Maximum x86 clock speed = **3.4 GHz**

Maximum x86 cores = **32**

Parallel Sysplex Enables System z To Scale To Capacities Far Beyond What Intel Can



Single System Sysplex

Parallel sysplex clustering delivers **highest availability**

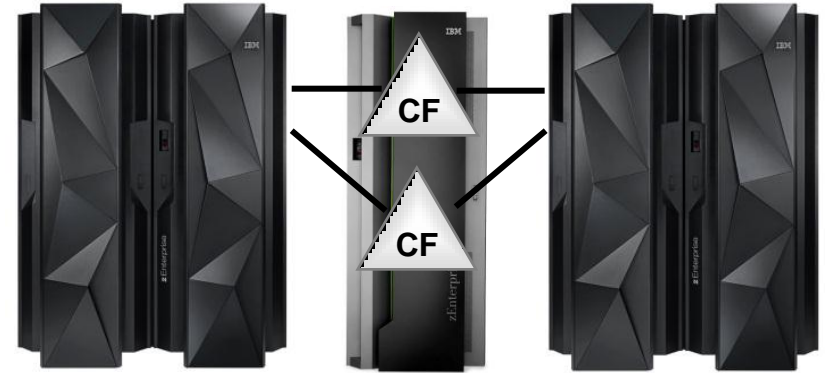

External Coupling Facility
(Can be different class server)

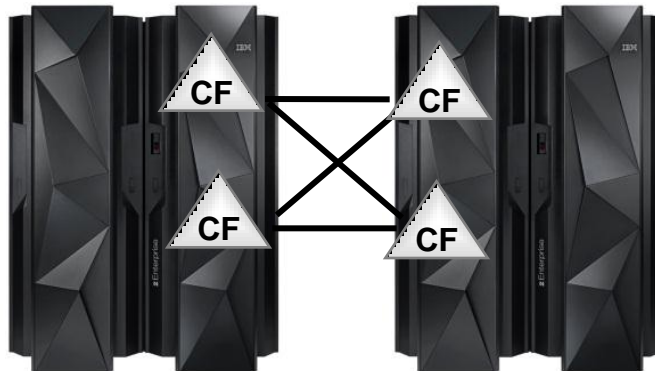

Cross Connected Servers with internal Coupling Facilities

Potentially
2.5 million MIPS
per 32-way cluster

Supports rolling software updates via automatic sysplex failover

Intel Does Not Have The Physical Capacity For State-of-the-Art Systems Of This Magnitude

- 1B CICS trans/day
- 4,000 IMS trans/sec
- 14M ACH transactions in 2.5 hours
 - ▶ 6-way sysplex
 - ▶ 30ms response
 - ▶ 216 CPU's at primary site
 - ▶ 200K MIPS

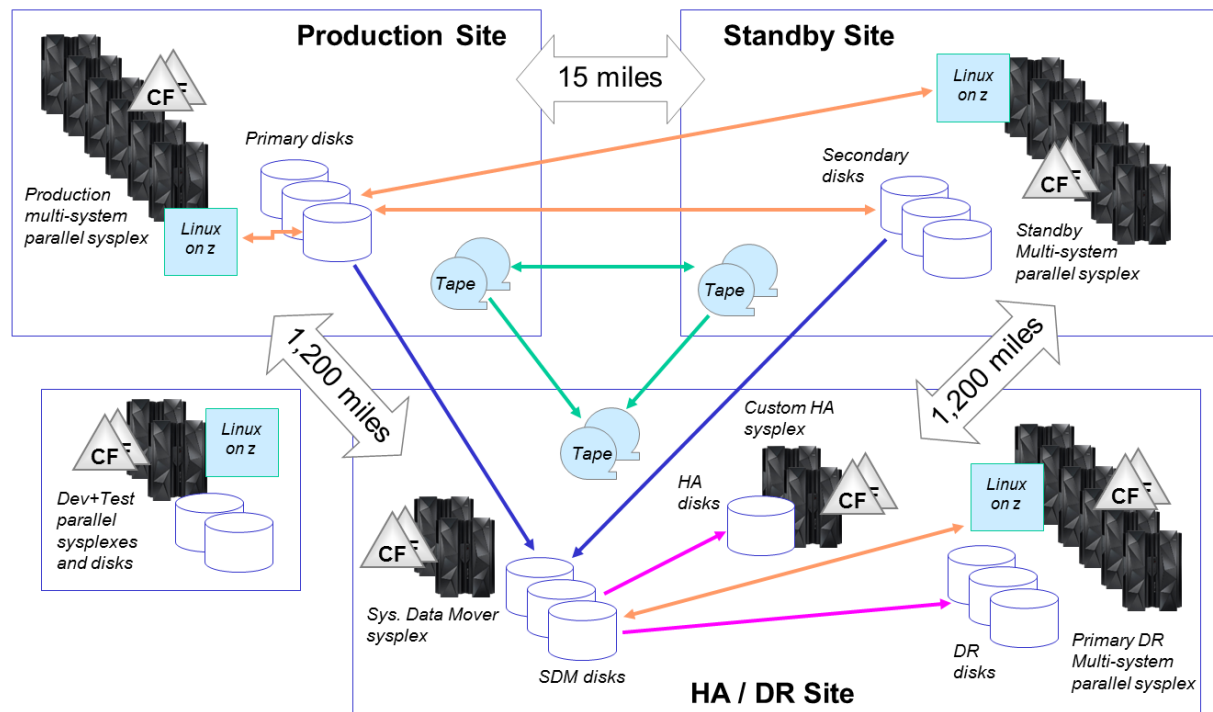

- Zero outages, zero customer impact
- Linux is Active-Active in the two data centers, with zero downtime
 - ▶ 15% Linux, growing at 30%
- *“Crazy about security overall, and the z system has a fortress around it”*

Real-World Benchmarks Show System z Runs Bigger Workloads Than Intel

System z and BaNCS Online Banking

- **Kookmin Bank**
 - ▶ IBM System z and DB2
 - ▶ TCS BaNCS
 - ▶ 15,353 Transactions/second
 - ▶ 50 Million Accounts
 - ▶ IBM benchmark for customer
 - ▶ DB2 V9, CICS 3.1, z/OS V1.8

- **State Bank of India¹**
 - ▶ HP Superdome
 - ▶ TCS BaNCS
 - ▶ 10,716 Transactions/second
 - ▶ 500 Million Accounts
 - ▶ Largest banking benchmark performance claimed by HP

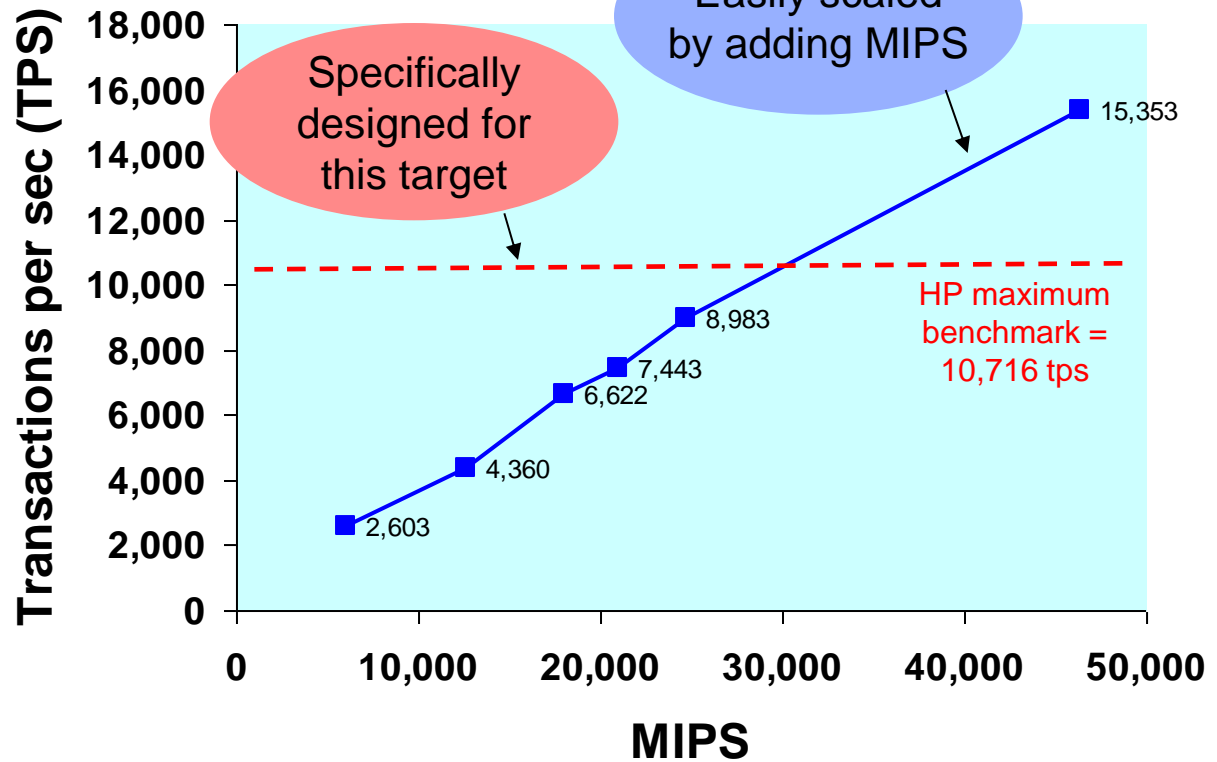

¹ Source: http://www.tcs.com/SiteCollectionDocuments/Case%20Studies/BaNCS_Case-Study_SBI-Celent_120210.pdf

System z Has More Cache Than Intel To Support Cache Intensive Workloads

zEC12 chip

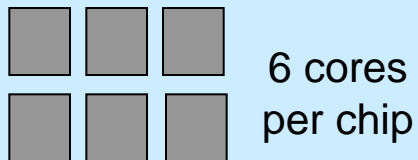

L1 Cache 960KB

L2 Cache 12MB

L3 Cache 48MB
(8MB per core)

L4 Cache 1,536MB across 4 books

Memory 3TB

Sandy Bridge chip

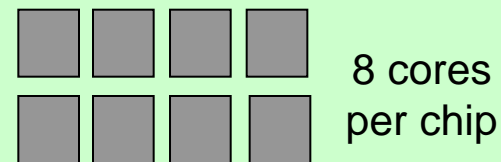

L1 Cache 512KB

L2 Cache 2MB

L3 Cache 20MB
(2.5MB per core)

No L4 Cache

Processor reported busy during a memory fetch, but no useful work is getting done

Memory 768GB

System z Is More Efficient For Data Processing Workloads

Cost advantage for smaller scale SAP database

SQL Server on Intel

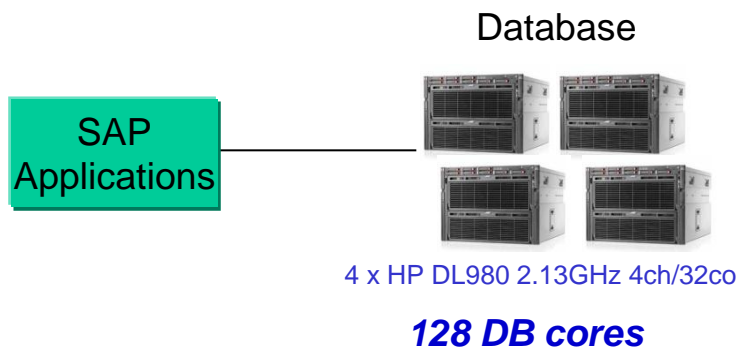

DB2 on z/OS

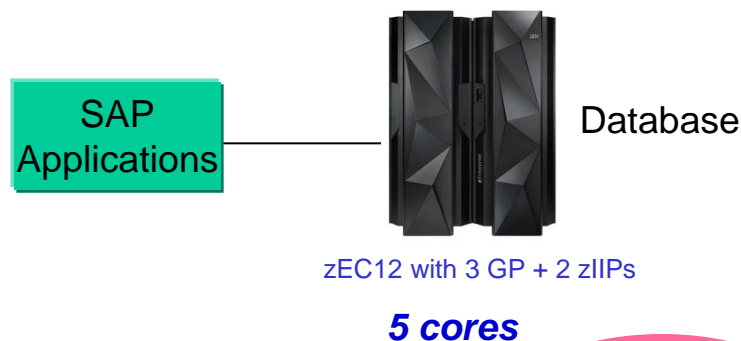

**96% less core
29% less cost**

**Database Unit Cost
\$86/User**

# of Users	23,000
Hardware	\$0.34M
Software	\$1.64M
Total (3 yr. TCA)	\$1.98M

**Database Unit Cost
\$61/User**

# of Users	23,000
DB2 Solution Edition(HW+SW)	\$1.40M
Total (3 yr. TCA)	\$1.40M

Note: Workload Equivalence established from a large US Retailer SAP DB offload incorporating estimated CPU Savings from DB2 for z/OS upgrade (107 Performance Units per MIPS). Upgrading from DB2 V8 to V10 reduces average CPU usage by 28%. DB2 V10 for z/OS on zEC12 and SQL Server 2008 on Intel

System z Has A Dedicated I/O Subsystem For High I/O Bandwidth, Intel Doesn't

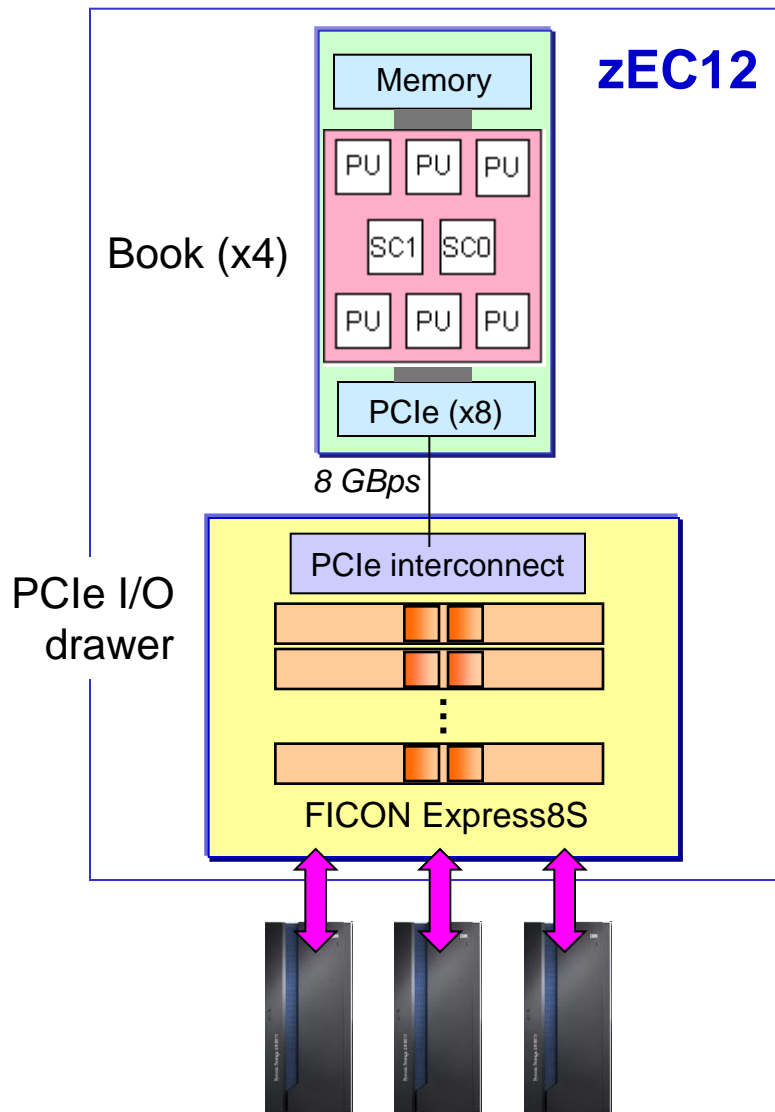

- **Up to 16 dedicated System Assist Processors (SAPs)**
 - ▶ All I/O requests are offloaded to SAPs
 - ▶ 16 SAPs can sustain up to **2.4M IOPS***
 - ▶ I/O subsystem bus speed of 8 GBps
 - ▶ Number of SAPs increases from 4 to 16 according to system size
- **Up to 160 physical FICON cards for I/O transfers**
 - ▶ Up to 320 RISC processors (2 per card)
 - ▶ Up to 320 FICON channels (2 per card)
 - ▶ 8 Gbps per link, 288 GB/Sec I/O aggregate per zEC12
- **IBM DS8800 Storage System**
 - ▶ Up to 440K IOPS capability
- **Delivers I/O efficiency at scale**

* Recommend 70% max utilization – 1.7M IOPS
Numbers represent High Performance FICON traffic

More Critical Data Workload Increases I/O Demand

Bank of China System z Benchmark required huge I/O bandwidth capacity

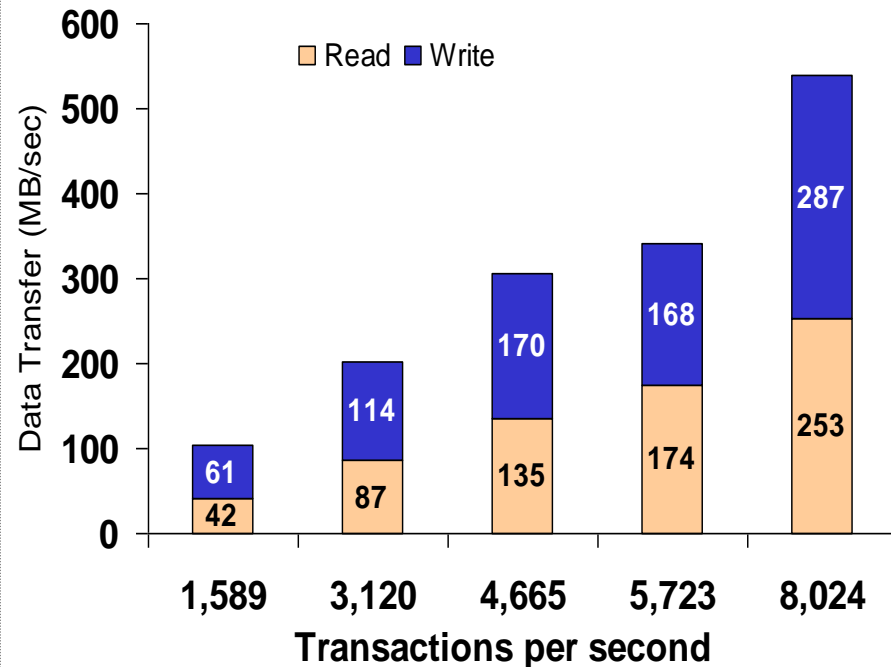
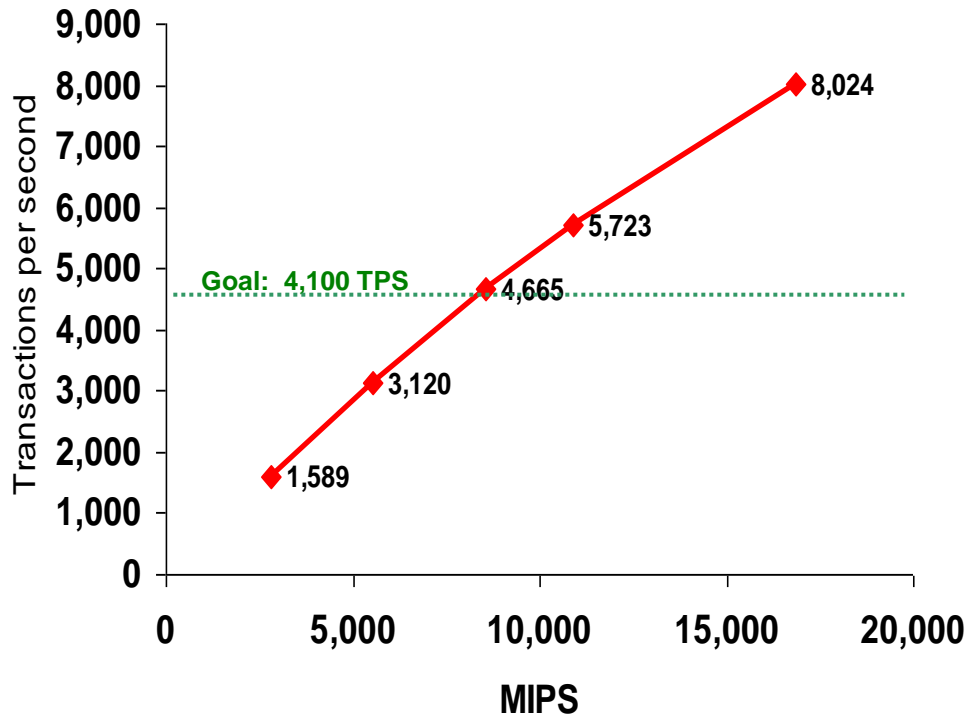

System z scaled smoothly despite increasing I/O demand

Intel Performance Degrades As I/O Demand Increases

- Test case scenario: Run multiple virtual machines on x86 server
 - ▶ Each virtual machine has an average I/O rate
 - ▶ Increasing the I/O rate uses more of the x86 processor for I/O processing
 - ▶ Therefore reducing the number of virtual machines that can be run

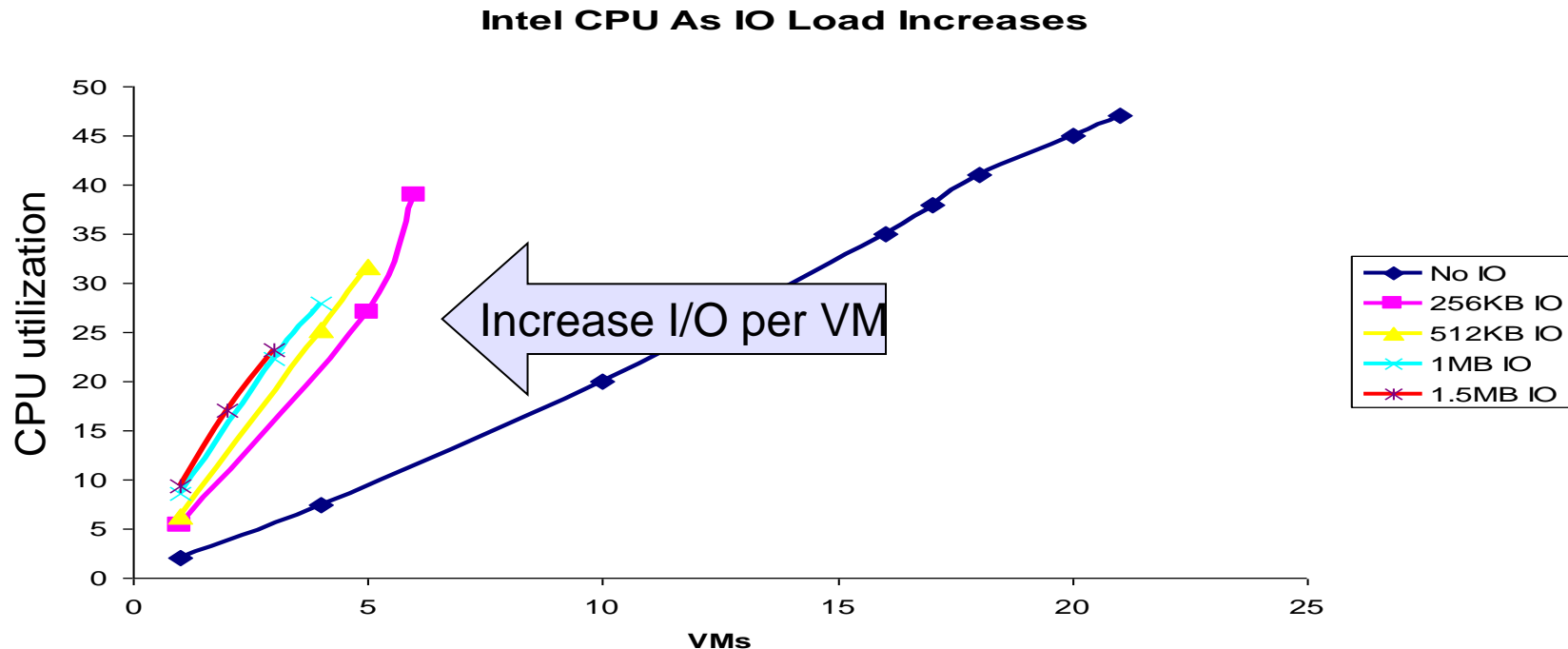

z/OS Database Workloads Benefit From Higher I/O Bandwidth

Competitor DB on Intel

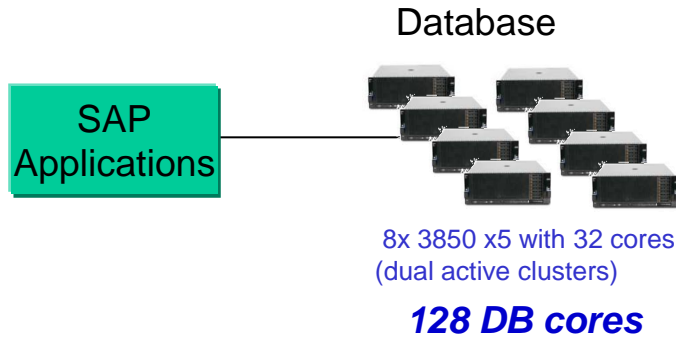

DB2 on z/OS

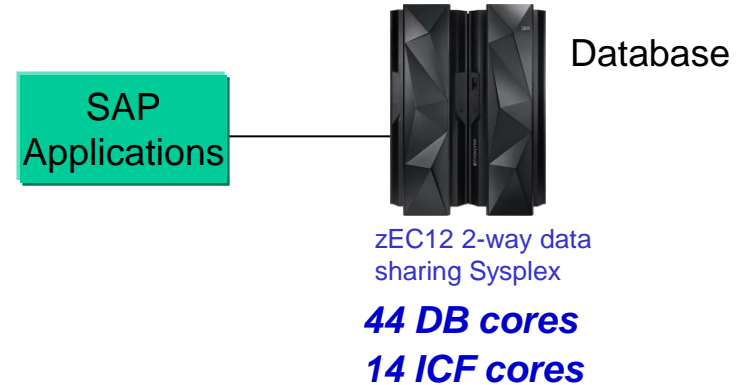

Database Unit Cost \$0.30/Postings per hour

Postings per Hour	42.0M
# of Accounts	90M
Hardware	\$0.63M
Software	\$12.0M
Total (5 yr. TCA)	\$12.6M

Database Unit Cost \$0.15/Postings per hour

Postings per Hour	59.1M
# of Accounts	150M
DB2 Solution Edition (HW+SW)	\$7.49M
Capacity Backup (CBU)	\$1.24M
Total (5 yr. TCA)	\$8.73M

A world record at half the cost!

Cost of platform infrastructure for comparative transaction production. Cost of packaged application software not included. List prices used.

Linux On System z Workloads Also Benefit From Higher I/O Bandwidth

Comparison of consolidation platforms

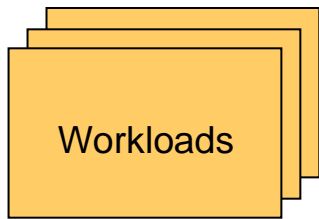

Online banking workloads, each driving **22** transactions per second, with **1 MB I/O per transaction**

1 workload per 16-core x86 blade



Virtualized on x86 16 core HX5 Blade

48 workloads per 32-way z/VM



I/O bandwidth large scale pool

Virtualized on z/VM on zEC12 32 IFLs

24x more workload density than x86

What System z Can Do That Intel Can't

1. Run Bigger and More Workloads

2. Perfect Workload Management



Intel Sandy Bridge



System z

System z Has Perfect Workload Management

Intel can't do this



- z/OS Workload Manager (WLM) is perfect for processes
 - ▶ I/O subsystem extends prioritization to the storage disks
- PR/SM provides workload management across LPARs



Intel Sandy Bridge



System z

Priority Transactional Workload With Constant Demand Running Standalone On z/OS

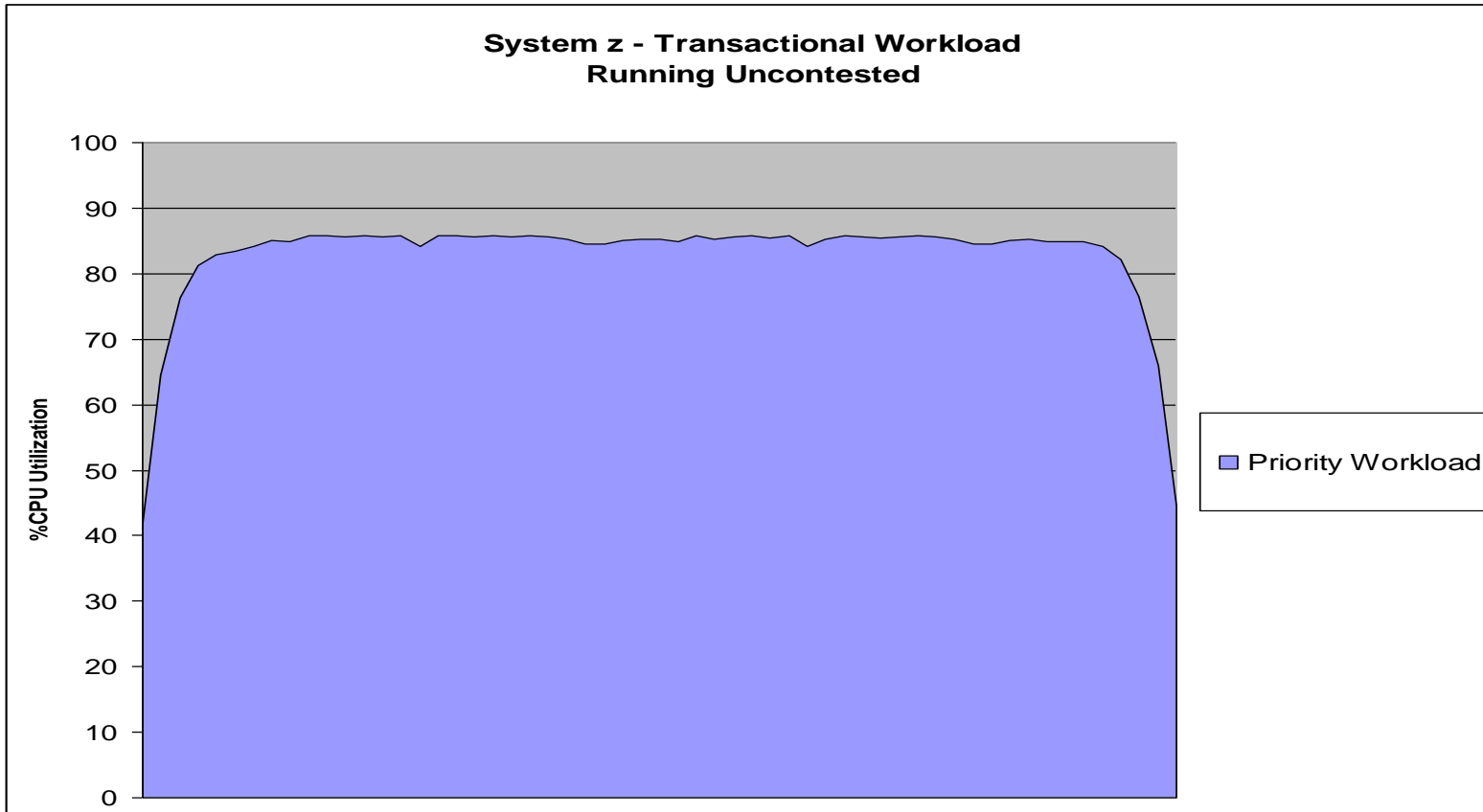

Capacity Used

High Priority Steady State – 85.2% CPU Minutes
Unused (wasted) – 14.8% CPU Minutes

Priority Workload Metrics

Total Throughput: 418K

Priority Transactional Workload On z/OS Does Not Degrade When Low Priority Donor Workload Is Added

z/OS WLM - Priority Transactional Workload
Running With Other Workloads - 1 Hour Run

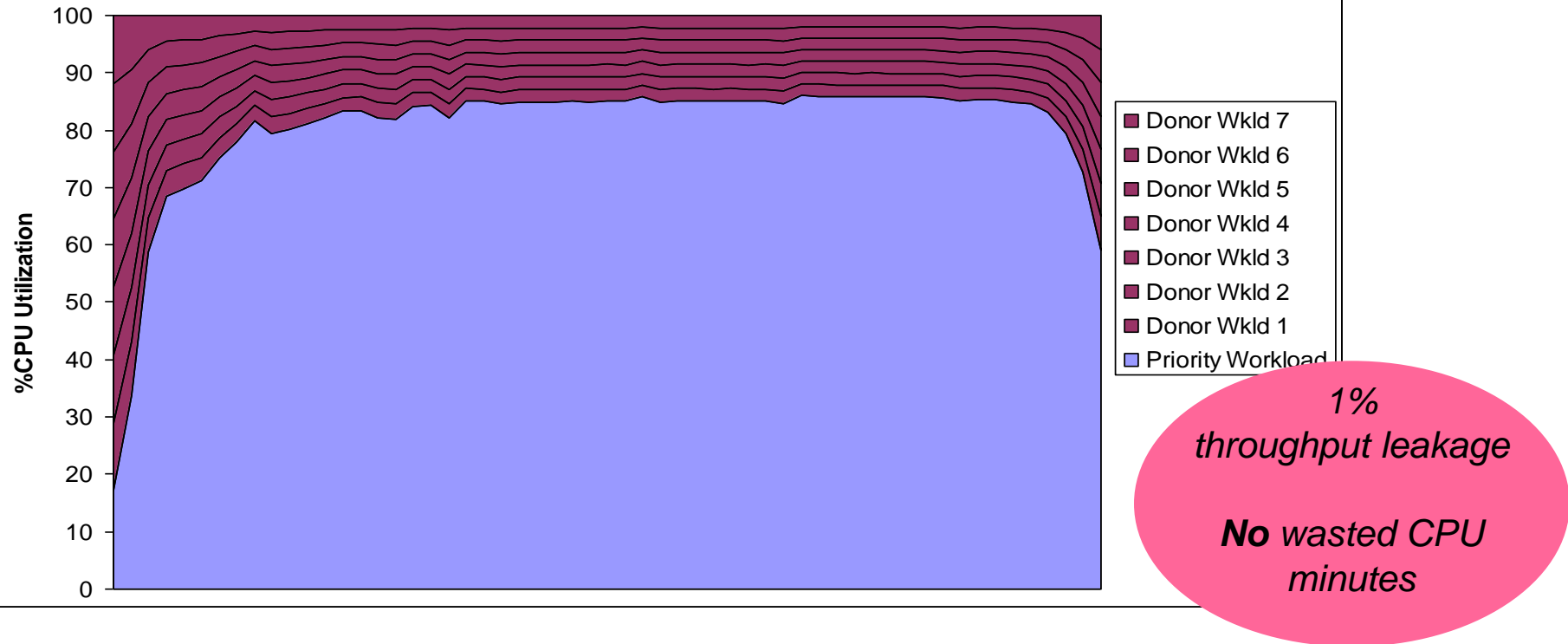

Capacity Used

High Priority Steady State – 85.3% CPU Minutes
Unused (wasted) – 0% CPU Minutes

Priority Workload Metrics

Total Throughput: 415K

z/OS Workload Management Extends Priority All The Way Down To Storage

- FICON protocol supports advanced storage connectivity features not found in x86
- Priority Queuing:
 - ▶ Priority of the low-priority programs will be increased to prevent high-priority channel programs from dominating lower priority ones

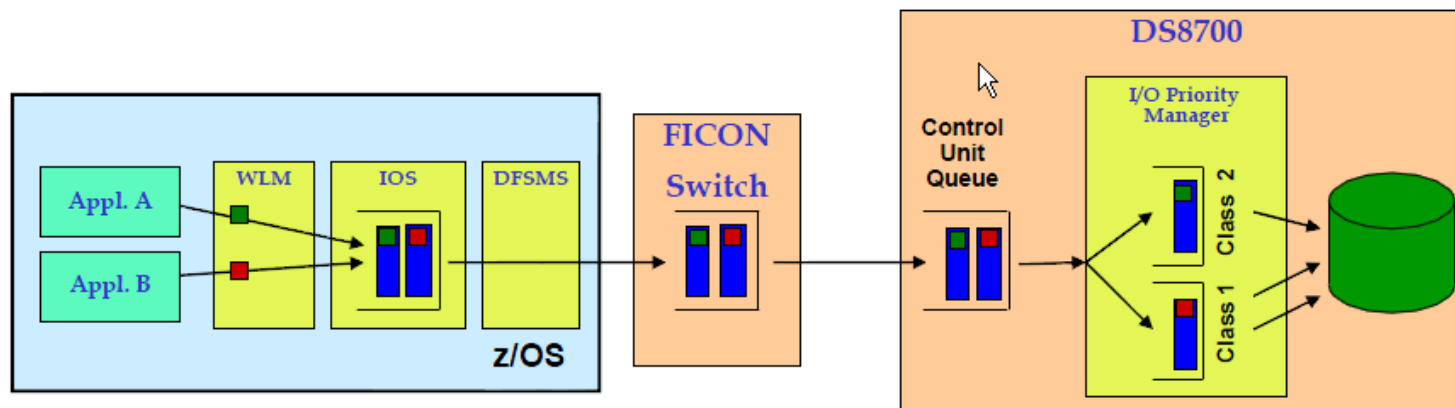

Intel can't do this

DEMO: z/OS Workload Management

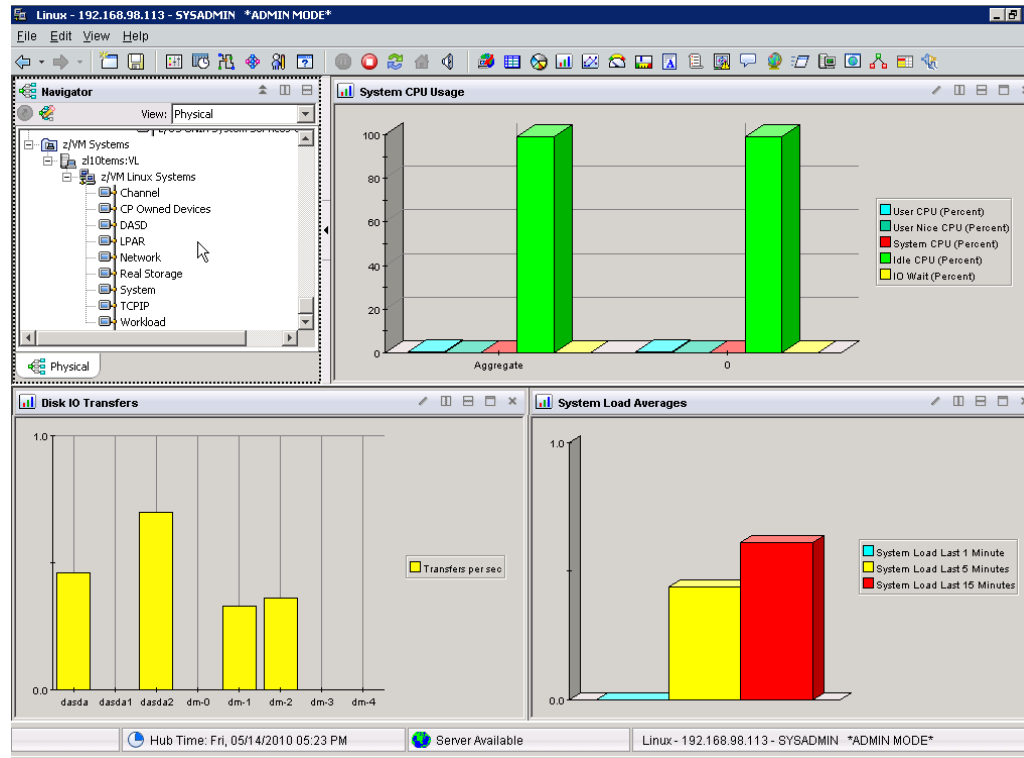

Comparison of System z PR/SM To Common Hypervisor Virtualization Environments

- High Priority web workload has defined demand over time
- SLA requires that response time does not degrade
- Low Priority web workload has unlimited demand
- It “soaks up” unused CPU minutes

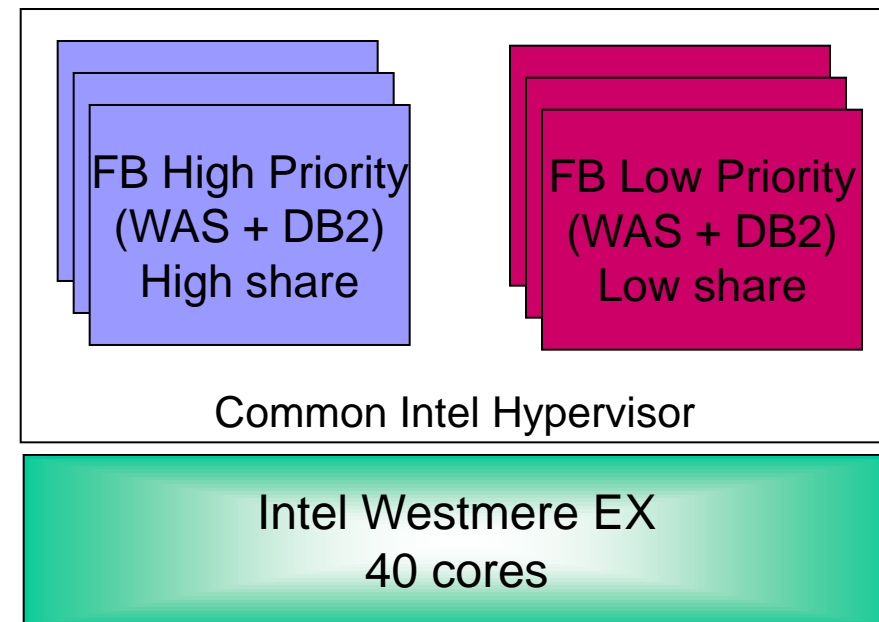
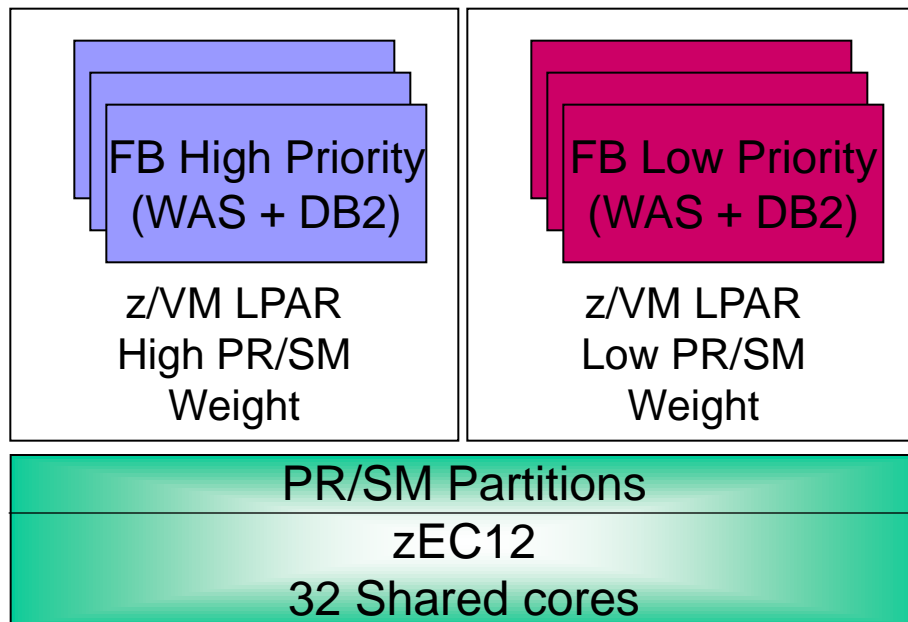

Priority Workload With Varying Demand Running Standalone On System z PR/SM

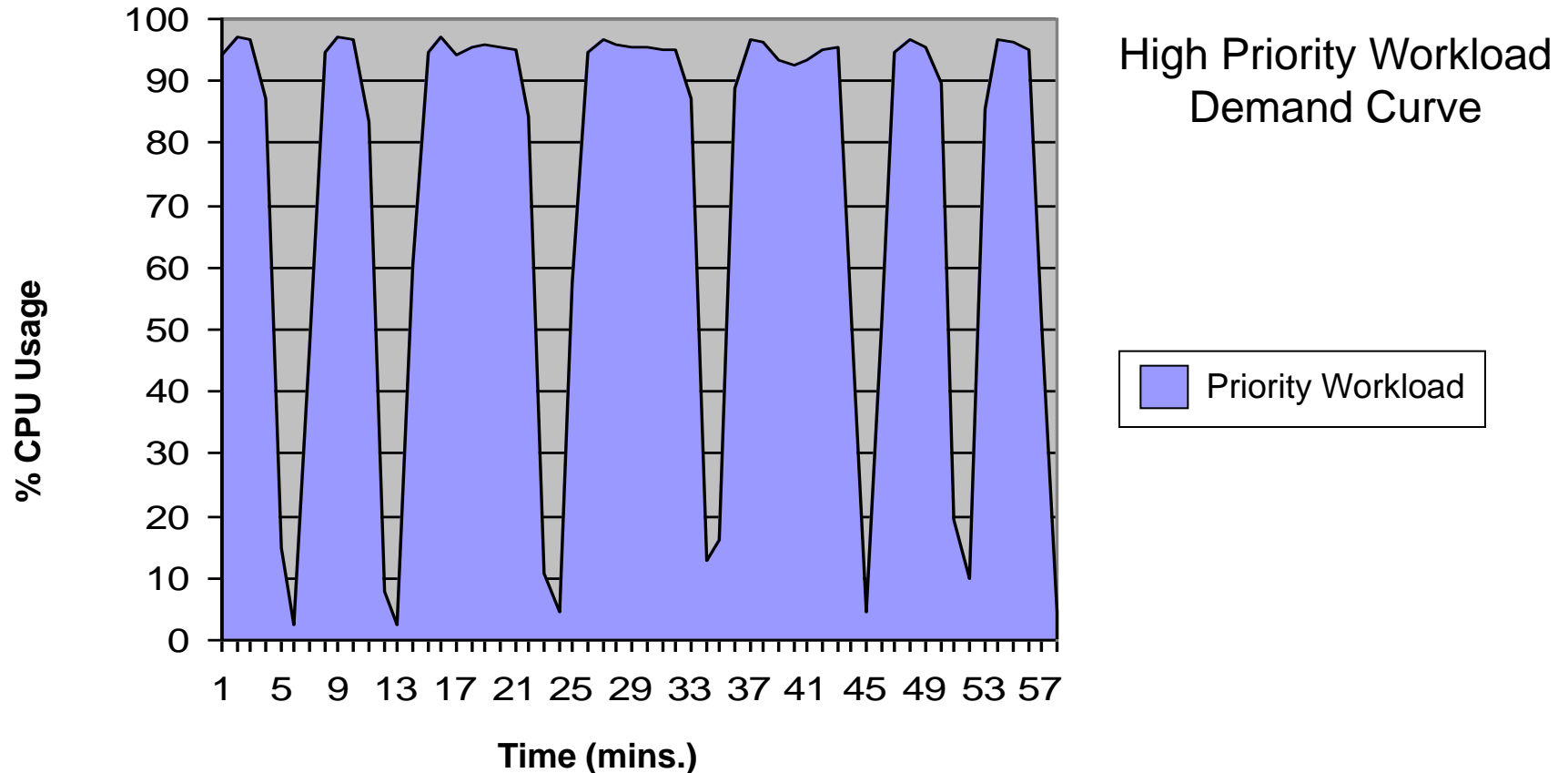

Capacity Used

High Priority – 72.2% CPU Minutes
Unused (wasted) – 27.8% CPU Minutes

Priority Workload Metrics

Total Throughput: 9.13M
Avg Response Time: 140ms

Priority Workload On System z Does Not Degrade When Low Priority Donor Workload Is Added

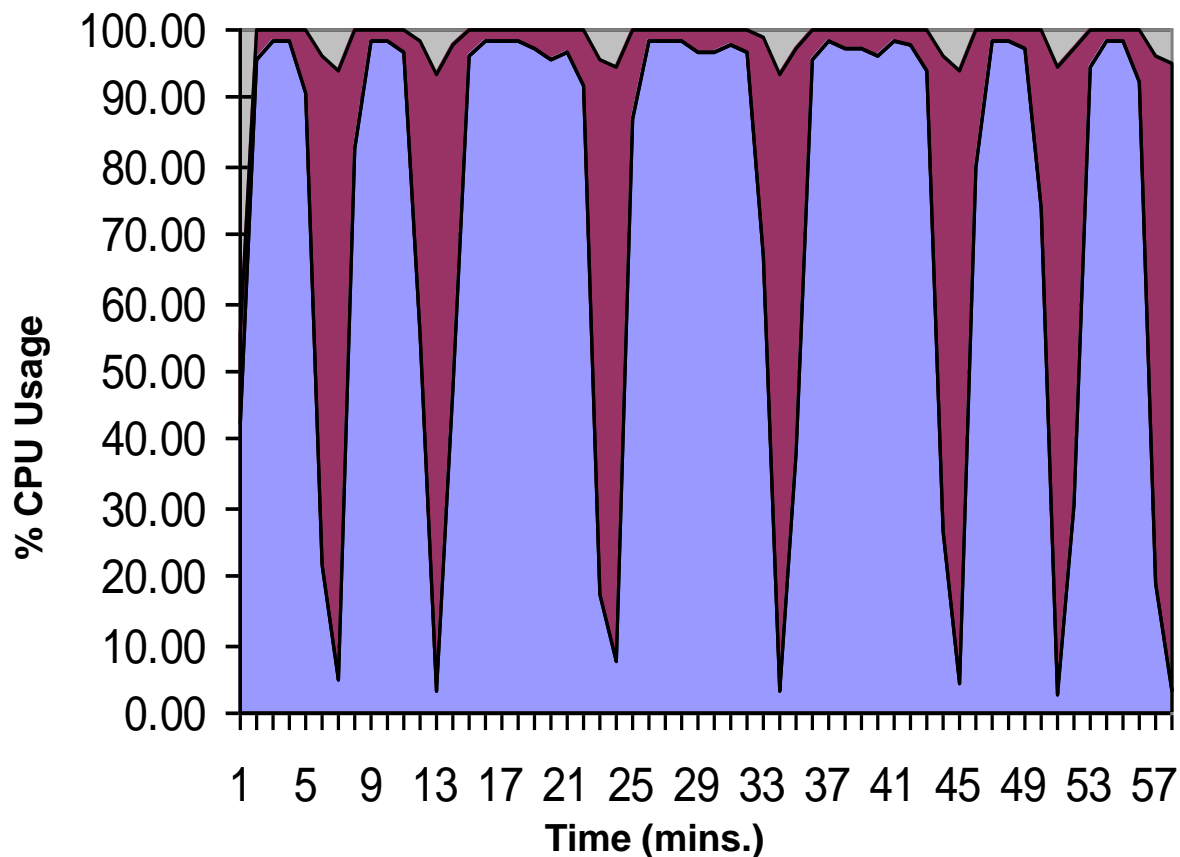

Run High Priority
And Low Priority
Workloads Together

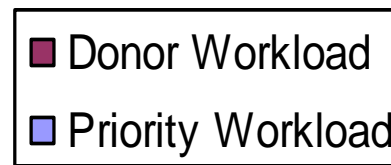

NO
throughput leakage
NO
response time increase

Capacity Used
High Priority – 74.2% CPU Minutes
Low Priority – 23.9% CPU Minutes
Wasted – 1.9% CPU Minutes

Priority Workload Metrics
Total Throughput: 9.13M
Avg Response Time: 140ms

Priority Workload With Varying Demand Running Standalone On Common Hypervisor

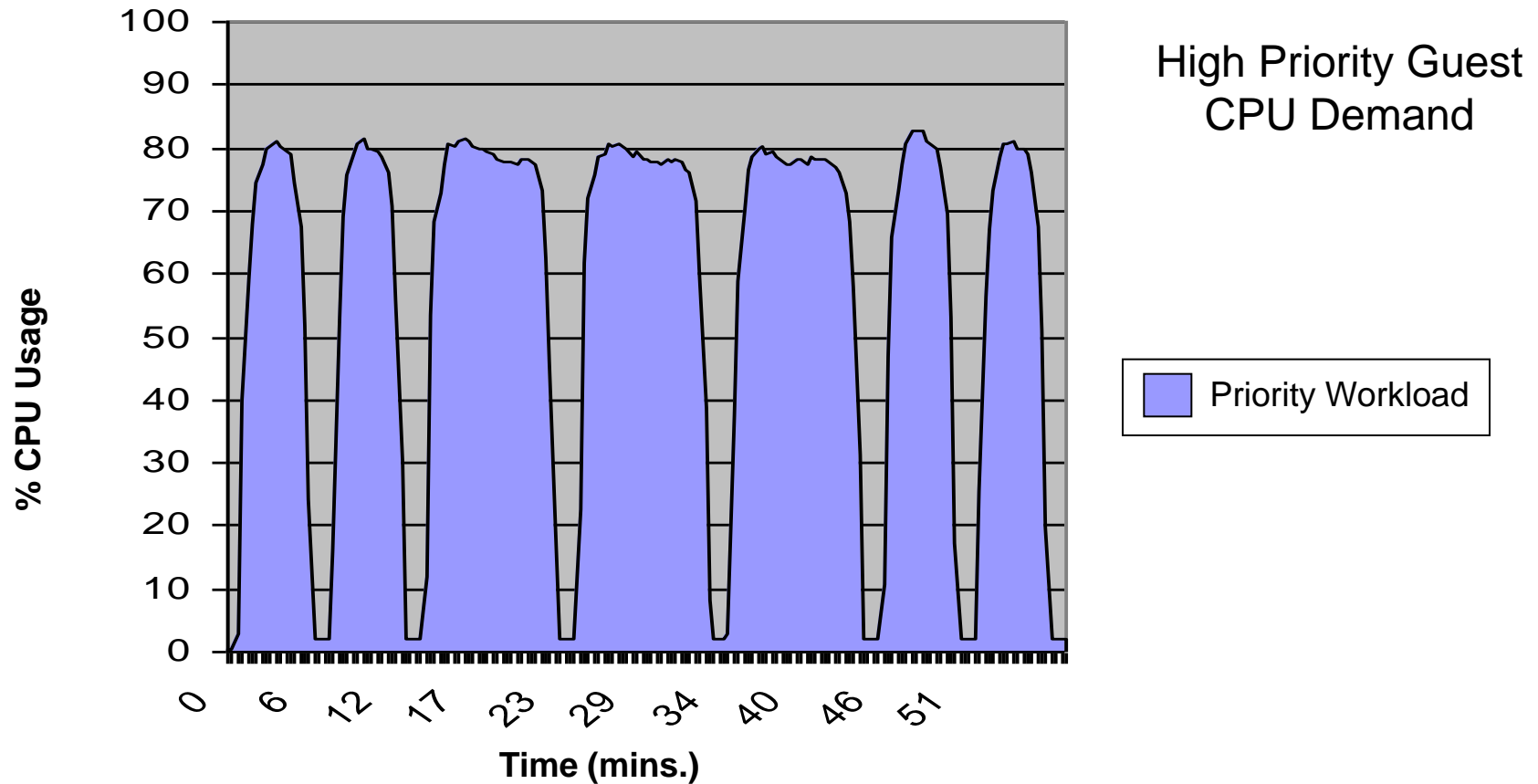

Capacity Used

High Priority – 57.5% CPU Minutes
Unused (wasted) – 42.5% CPU Minutes

Priority Workload Metrics

Total Throughput: 6.47M
Avg Response Time: 153ms

Priority Workload On Common Hypervisor Degrades Severely When Low Priority Workload Is Added

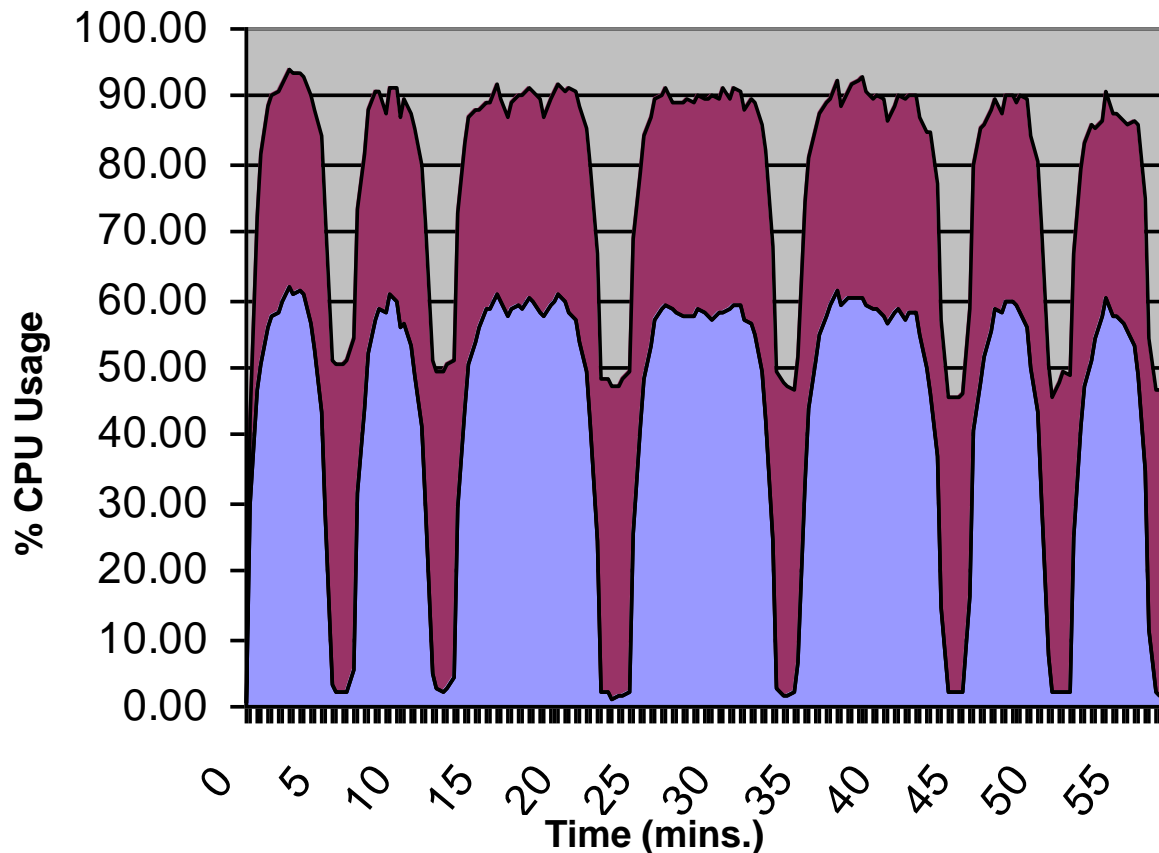

Run High Priority
And Low Priority
Workloads Together

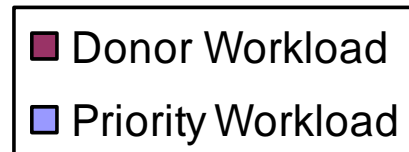

30.7%
throughput leakage
45.1%
response time increase
21.9%
wasted CPU minutes

Capacity Used
High Priority – 42.3% CPU Minutes
Low Priority – 35.8% CPU Minutes
Wasted – 21.9% CPU Minutes

Priority Workload Metrics
Total Throughput: 4.48M
Avg Response Time: 220ms

System z Virtualization Enables Mixing Of High And Low Priority Workloads Without Penalty

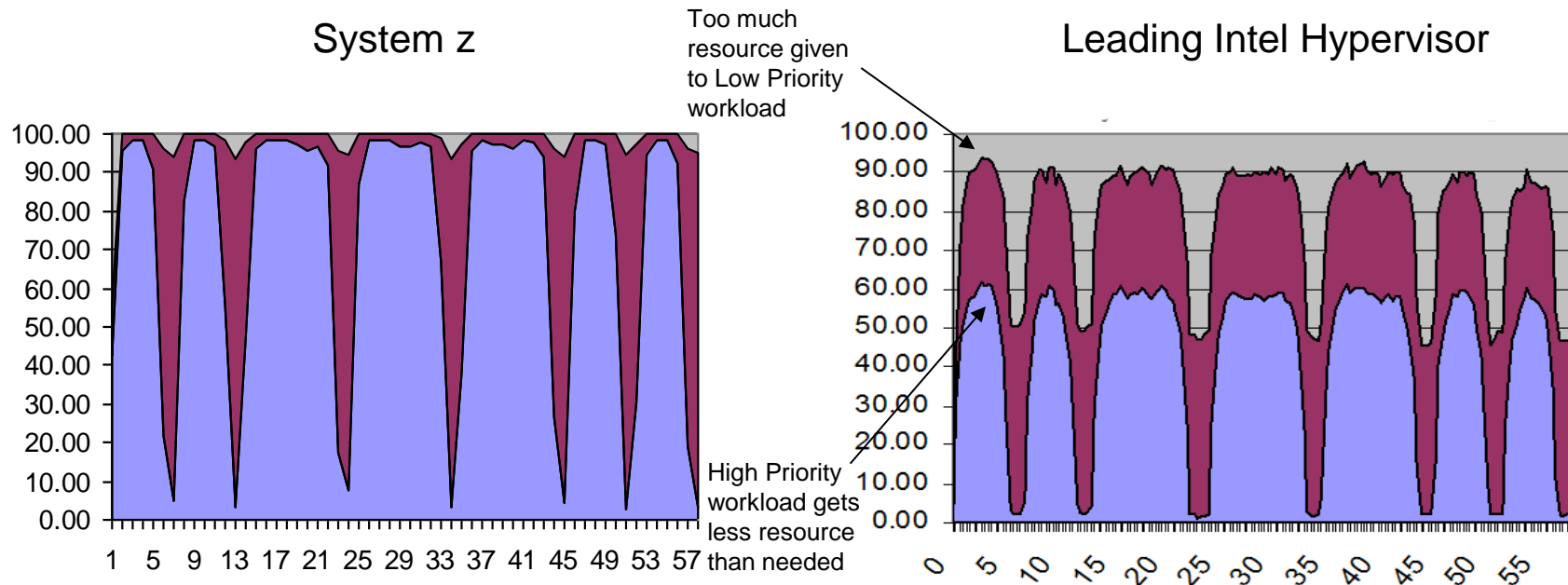

- Priority Workload
 - ▶ No throughput reduction
 - ▶ No response time increase
- Low Priority Workload
 - ▶ Soaks up remaining CPU minutes
- Unused CPU minutes 1.9%

- Priority Workload
 - ▶ 31% throughput reduction
 - ▶ 45% response time increase
- Low Priority Workload
 - ▶ Soaks up more CPU minutes
- Unused CPU minutes 21.9%

System z Virtualization Enables Mixing Of High And Low Priority Workloads Without Penalty

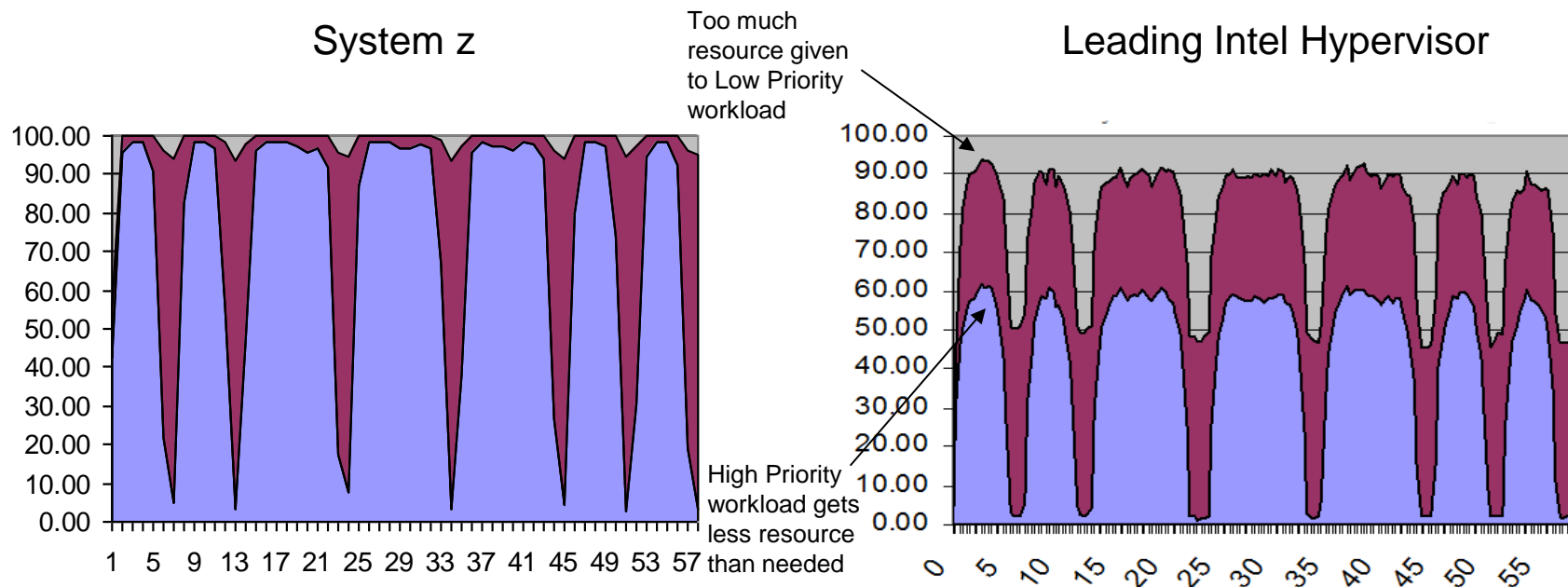

- Perfect workload management
- Consolidate workloads of different priorities on the same platform
- Full use of available processing resource (high utilization)

- Imperfect workload management
- Forces workloads to be segregated on different servers
- More servers are required (low utilization)

Deliver High And Low Priority Workloads Together While Maintaining Response Time SLA

Comparison to determine which platform provides the lowest TCA over 3 years

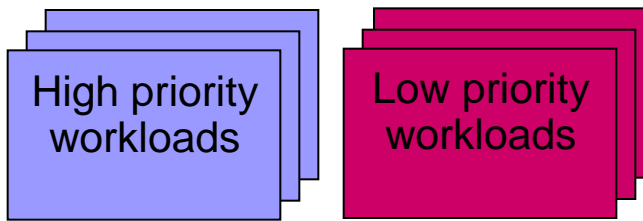

- IBM WebSphere 8.5 ND
- IBM DB2 10 AESE
- Monitoring software

High priority online banking workloads driving a total of **9.1M** transactions per hour and low priority discretionary workloads driving **2.8M** transactions per hour

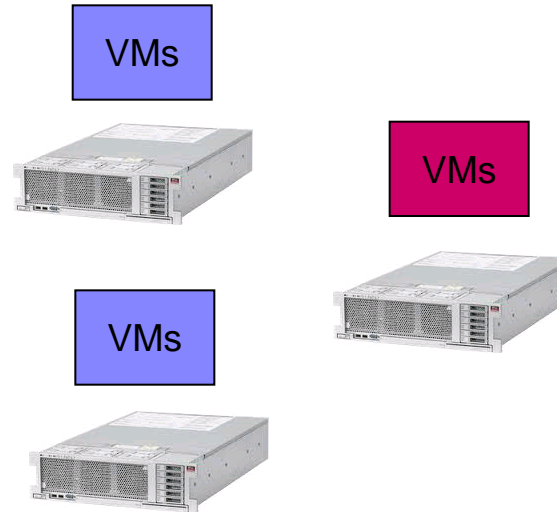

Virtualized on 3 Intel 40 core servers
\$13.7M (3 yr. TCA)

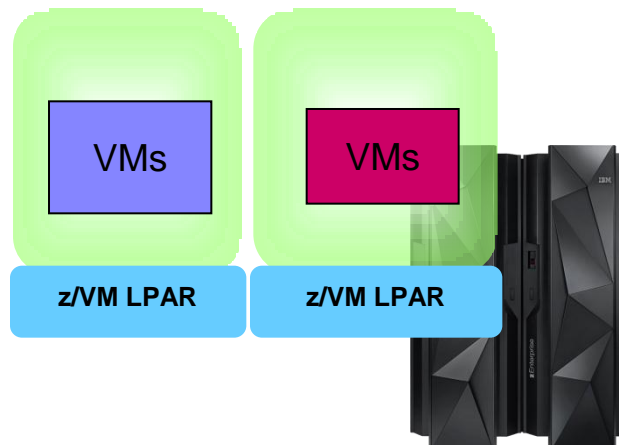

z/VM on zEC12
 32 IFLs
\$5.77M (3 yr. TCA)

58%
lower cost!

Consolidation ratios derived from IBM internal studies.. zEC12 numbers derived from measurements on z196. Results may vary based on customer workload profiles/characteristics. Prices will vary by country.

What System z Can Do That Intel Can't

1. Run Bigger and More Workloads

2. Perfect Workload Management

3. Greater Core Density



Intel Sandy Bridge



System z

Why Core Proliferation Happens When Moving Workload From System z To Intel

- De-consolidation of applications to dedicated servers – decomposing highly tuned co-located components
- Processing expansion requirements for CICS/COBOL applications
- 3x expansion when converting hierarchical databases to relational
- Functional segregation into production, development and test
- 100% hardware coverage for Disaster Recovery costs double



Intel Sandy Bridge



System z

Core Proliferation For A Large Workload

16x 32-way HP Superdome
App. Production / Dev / Test

8x 48-way HP Superdome
DB Production / Dev / Test



41 GP processors
(38,270 MIPS)

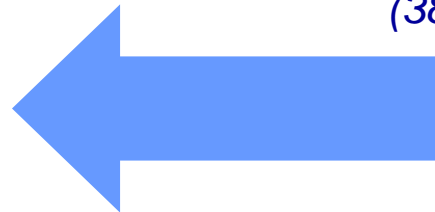

896 processors
(3,668,600 Perf Units)

22x more cores!

\$180M (5 yr. TCA)

zEC12 41-way Production / Dev / Test



\$111M (5 yr. TCA)

NOTE: To cover DEV/QA capacity, add 100% servers for distributed servers, add 25% MIPS (8,000) to System z

Core Proliferation For A Mid-sized Workload

6x 8-way Production / Dev
2x 64-way Production / Dev
Application/MQ/DB2/Dev partitions



6 processors
(1,660 MIPS)



176 processors
(800,072 Performance units)

\$25.4M (5 yr. TCO)

\$17.9M (5 yr. TCO)

29x more cores!

482 Performance Units per MIPS

Core Proliferation For Oracle Workloads

Benchmark study for a Media and Entertainment Industry customer



107 HP servers

1440 cores total

30x more cores!



zEC12

48 IFLs

1 PS701

1 HX5

Hardware	\$2.9M
Software	\$24.2M
Labor	\$7.9M
Space, Power and cooling	\$1.2M
Disaster Recovery	\$6.5M
Total (5 yr. TCO)	\$42.7M

Hardware	\$4.9M
Software	\$8.5M
Labor	\$1.8M
Space, Power and cooling	\$0.5M
Disaster recovery	\$4.8M
Total (5 yr. TCO)	\$20.5M

Intel: Oracle DB + App costs = \$13.1M (LIC + maint over 5 yrs.).

IBM: Oracle DB + App costs = \$1.92M (LIC + maint over 5 yrs.)

Migration Offloads Have Additional Costs

Typical Eagle TCO Study For A Financial Services Customer

x86 – 4 HP Proliant DL 980 G7 servers



256 cores total

Hardware	\$1.6M
Software	\$80.6M
Labor (additional)	\$8.3M
Power and cooling	\$0.04M
Space	\$0.08M
Disaster Recovery	\$4.2M
Migration Labor	\$24M
Parallel Mainframe costs	\$31.5M
Total (5 yr. TCO)	\$150M

System z z/OS Sysplex



2,800 MIPS

Hardware	\$1.4M
Software	\$49.7M
Labor	Baseline
Power and cooling	\$0.03M
Space	\$0.08M
Disaster recovery	\$1.3M
Total (5 yr. TCO)	\$52M

What System z Can Do That Intel Can't



Intel Sandy Bridge

1. Run Bigger and More Workloads

2. Perfect Workload Management

3. Greater Core Density

4. Spare Capacity for Growth



System z

System z's Integrated Capacity On Demand (CoD) Extends To Storage

- System z ships with spare processors installed
 - ▶ Capacity on Demand can turn on spare processors without service interruption
 - ▶ **Intel can't do this**
- Capacity on Demand extends to DS8870
 - ▶ Up to six standby disk drive sets (96 disk drives total) can be concurrently field-installed into the system*
 - ▶ Non-disruptive activation
 - ▶ Easy to logically configure the disk drives for use – no IBM intervention required
 - ▶ **Midrange storage typically used by Intel can't do this**



System z



DS8870

*SSDs not available for CoD configurations

What System z Can Do That Intel Can't



Intel Sandy Bridge

1. Run Bigger and More Workloads
2. Perfect Workload Management
3. Greater Core Density
4. Spare Capacity for Growth
5. Comprehensive Disaster Recovery

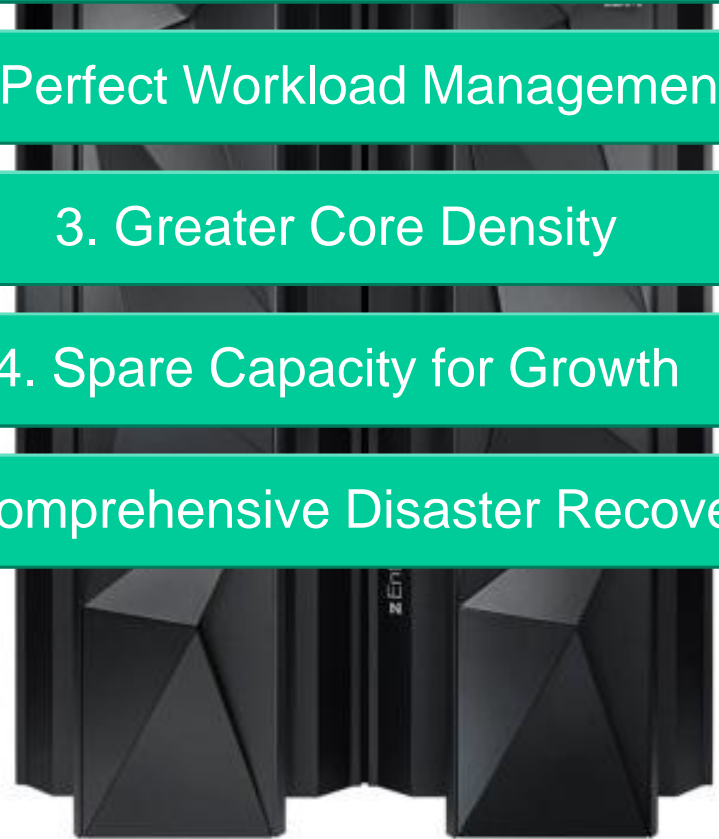

System z

System z Disaster Recovery Is Systematic And Comprehensive

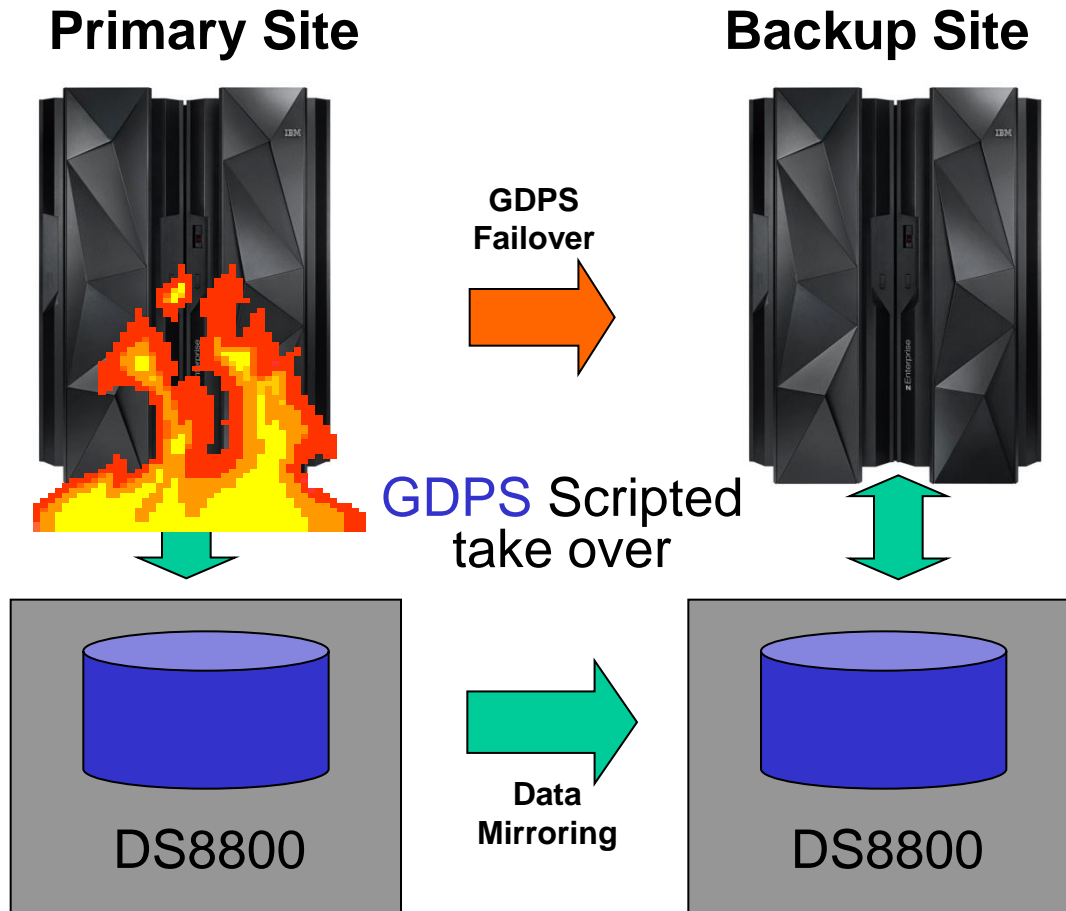

■ Site Failover

- ▶ Failover to secondary site in case of complete site failure

■ Data Mirroring

- ▶ Protect data in the event of a disk system failure

Supports systematic Disaster Recovery for virtualized Linux environments also

Complexity Of Intel Disaster Recovery Solutions Inhibits Wide Spread Use

- Workloads on standalone Intel servers require a disaster recovery solution for each server
 - ▶ Data mirroring
 - ▶ Failover and restart
- Embedded storage is difficult to mirror
- Comprehensive workload failover is not feasible for hundreds of servers

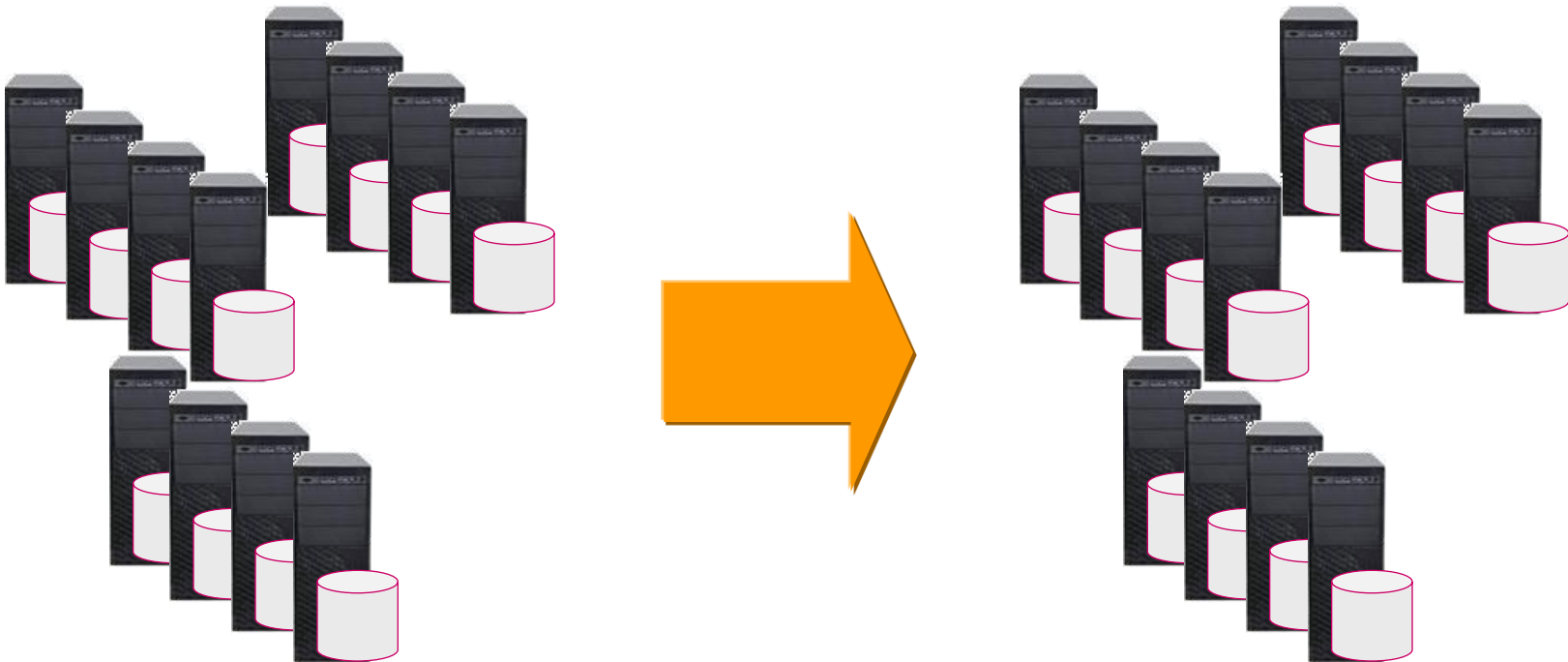

Consolidation Of Workloads On System z Simplifies Disaster Recovery

- Workloads are consolidated onto z/VM partitions as Linux guests
- Linux on System z can be failed over as part of GDPS

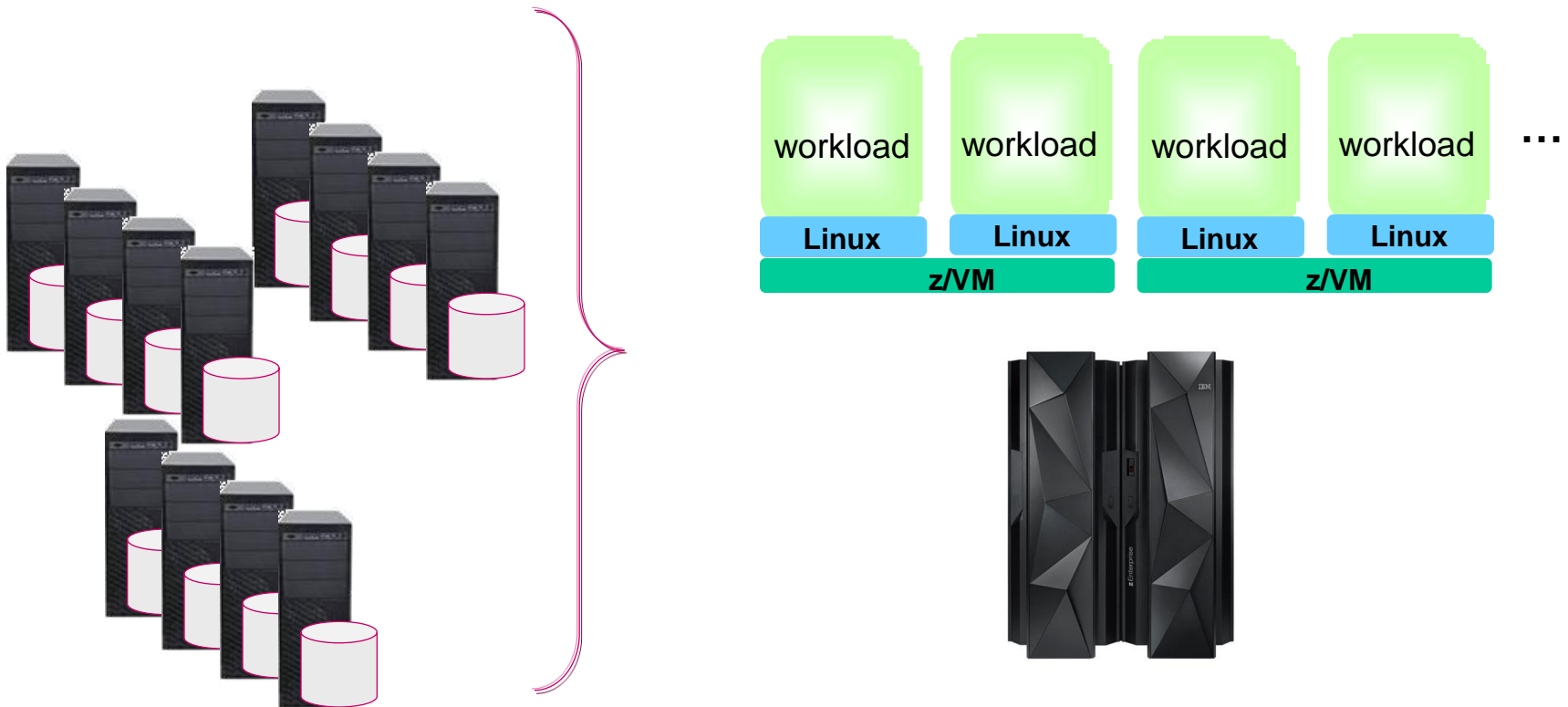

What System z Can Do That Intel Can't



Intel Sandy Bridge

1. Run Bigger and More Workloads
2. Perfect Workload Management
3. Greater Core Density
4. Spare Capacity for Growth
5. Comprehensive Disaster Recovery
6. Runs Longer without Stopping

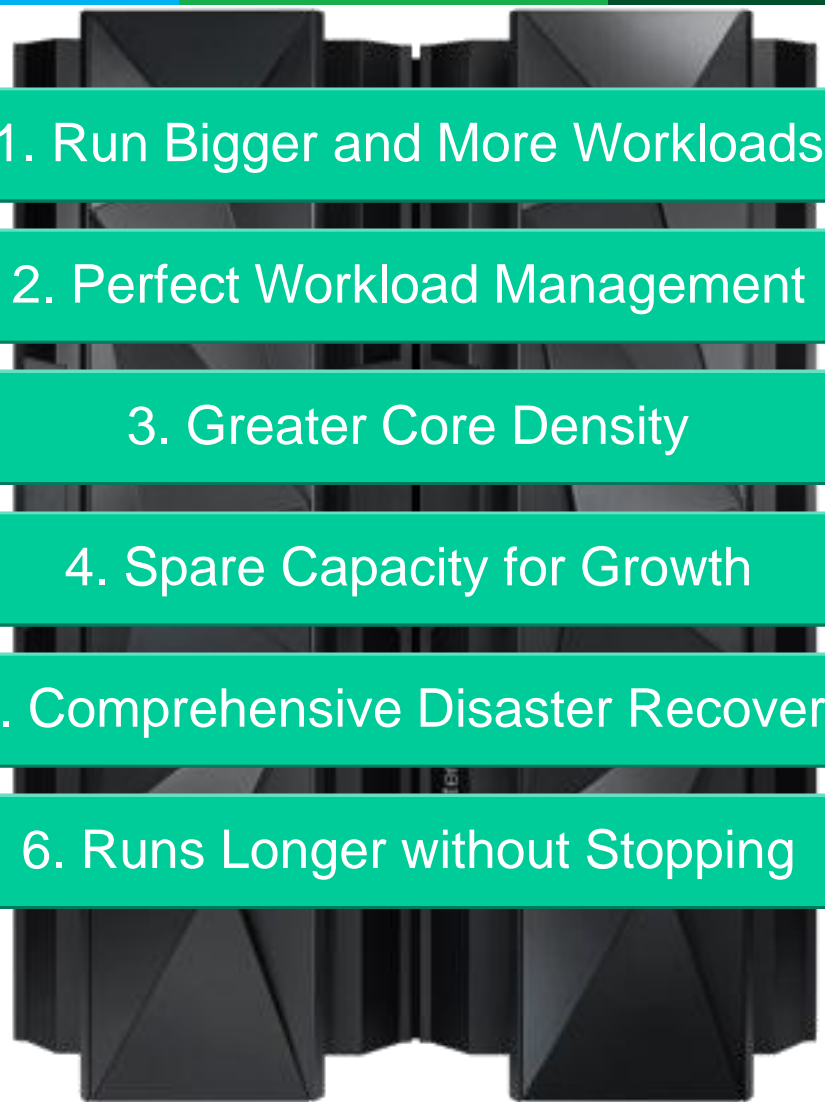

System z

System z Has More Comprehensive Protection To Ensure Better Availability Than Intel

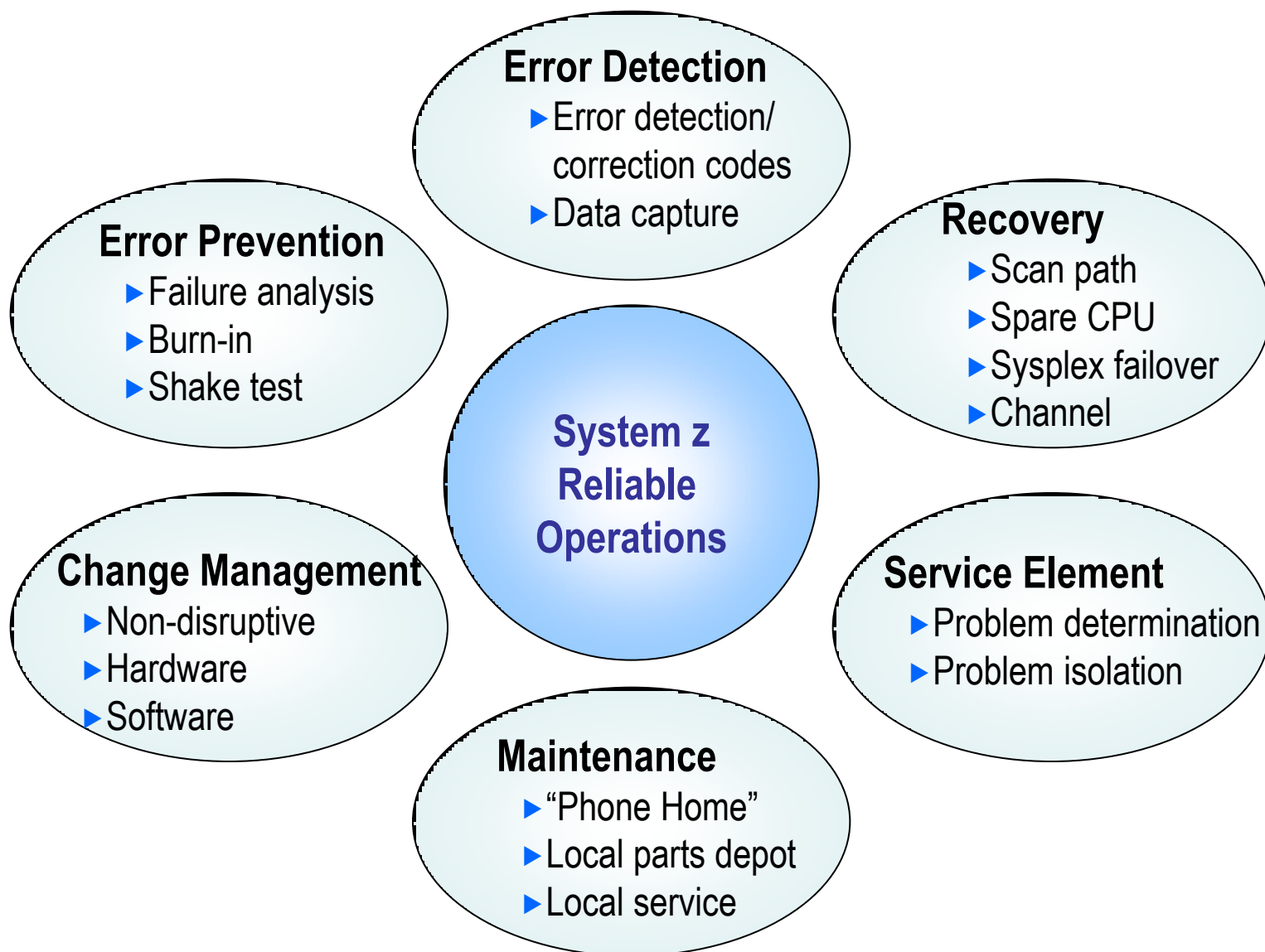

Example:

zEC12 Provides Transparent CPU Sparing

- Transparent sparing for all CPU types
 - ▶ CP, ICF, IFL, zAAP, zIIP
- zEC12 has 2 spare CPUs per server
 - ▶ Spares do not have to be local to the same book
- Processor Availability Facility (PAF) saves state and switches to spare CPU
 - ▶ Error detection circuits detect a failing processor
 - ▶ Failing processor is stopped
 - ▶ Data contents of failing processor are transferred to spare processor
 - Scan register technology
 - ▶ Processing resumes on spare processor
 - ▶ NO apparent interruption to the workload

System z Supports Concurrent Operations During Hardware Repair – *Intel Can't*

Capability	zEC12	x86
ECC on Memory Control Circuitry	Transparent While Running	Can recognize/repair soft errors while running; limited ability with hard errors
Oscillator Failure	Transparent While Running	Must bring server down to replace
Core Sparing	Transparent While Running	Must bring server down to replace
Microcode Driver Updates	While Running	Some OS-level drivers can update while running, not firmware drivers; reboot often required
Book Additions, Replacement	While Running	Must bring server down to replace core, memory controllers, cache, etc.
Memory Replacement	While Running	Must bring server down to replace
Memory Bus Adaptor Replacement	While Running	Must bring server down to replace
I/O Upgrades	While Running	Must bring server down to replace (limited ability to replace I/O in some servers)
Concurrent Driver Maintenance	While Running	Limited – some drivers replaceable while running
Redundant Service Element	2 per System	“Support processors” can act as poor man’s SE, but no redundancy

Single book systems may not support concurrent memory upgrades

The Choice Is Clear!

System z is better than Intel for Systems of Record

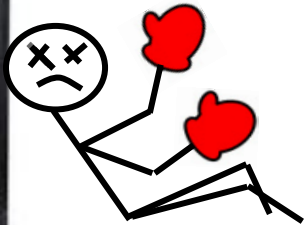

1. Run Bigger and More Workloads
2. Perfect Workload Management
3. Greater Core Density
4. Spare Capacity for Growth
5. Comprehensive Disaster Recovery
6. Runs Longer without Stopping



Notice Regarding Specialty Engines (e.g., zIIPs, zAAPs and IFLs):

Any information contained in this document regarding Specialty Engines ("SEs") and SE eligible workloads provides only general descriptions of the types and portions of workloads that are eligible for execution on Specialty Engines (e.g., zIIPs, zAAPs, and IFLs). IBM authorizes customers to use IBM SE only to execute the processing of Eligible Workloads of specific Programs expressly authorized by IBM as specified in the "Authorized Use Table for IBM Machines" provided at

www.ibm.com/systems/support/machine_warranties/machine_code/aut.html ("AUT").

No other workload processing is authorized for execution on an SE.

IBM offers SEs at a lower price than General Processors/Central Processors because customers are authorized to use SEs only to process certain types and/or amounts of workloads as specified by IBM in the AUT.