



The Gold Standard for Enterprise Computing

**Unique Innovations
That Make zEnterprise Superior**

Today's agenda

60 mins	Unique Innovations that make zEnterprise Superior
60 mins	Business Analytics on the Ultimate Data Platform
<i>15 mins</i>	<i>Break</i>
60 mins	Dynamic Cloud with zEnterprise
<i>60 mins</i>	<i>Lunch</i>
60 mins	Is Your Enterprise Ready for the Mobile Revolution?
60 mins	Mainframe Skills – The Myths and the Reality
<i>15 mins</i>	<i>Break</i>
60 mins	Innovative Workloads for zEnterprise

Fifty years ago, IBM introduced the first mainframe computer...



System 360 – April 7, 1964

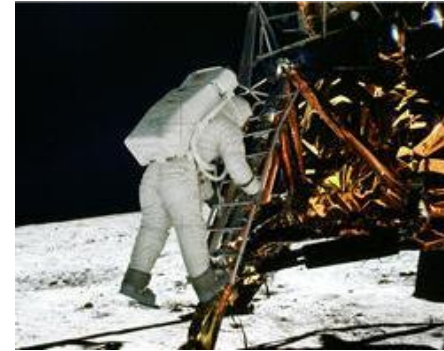

It helped put men on the moon...

It touches all of us from the day we were born...

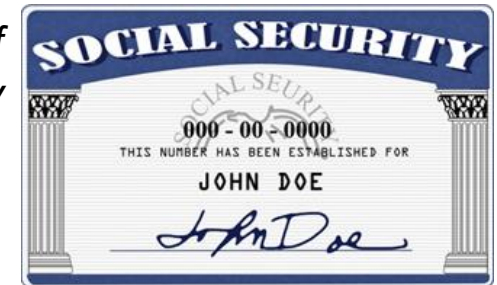

It was revolutionary...

It was innovative...

It changed the world!



It changed the way we live and work...



Fifty years ago, IBM introduced the first mainframe computer...



System 360 – April 7, 1964

It is still revolutionary...

It is still innovative...

It is still changing the world!

***NO!!
IBM continues
to invest \$BILLIONS
in mainframe
technology***

Model 5150 – c.1981

Customer demand and technical leadership have lead to *continuous re-invention of the mainframe*

Hardware carry-forward + continuous application compatibility

- 24-bit addressing (32-bit architecture)
- 1 or 2 cores
- 16MB storage
- 24K core memory

- 24-bit or 31-bit virtual addressing
- Fully integrated monolithic memory
- 256 channel architecture
- Virtual storage

- CMOS processors
- More than 1,000 MIPS
- Parallel sysplex
- Enterprise Systems Architecture (ESA)

- Specialty engines
- Hardware-assisted compression and encryption
- Decimal floating point
- 64-bit superscalar architecture

- zEC12: up to 120 cores, 5.5GHz speed, 78,000+ MIPS
- zBC12 for mid-range
- RAIM and Hardware Transactional Memory
- DB2 Analytics Accelerator

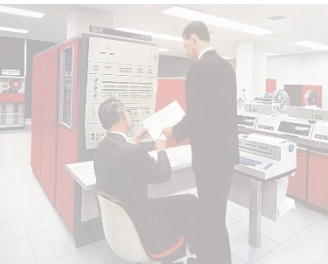

- VM operating system

- MVS, IMS, CICS, and DB2

- WebSphere

- Rational Development & Test

S/360

S/370

S/390

zSeries

zEnterprise

1964

1970

1990

2000

2010

The IBM zEnterprise server – ready for the business challenges of today and the future



IBM zEnterprise EC12



IBM zEnterprise BC12

- The most available and secure platform commercially available
- Supports today's newest workloads
 - Data and analytics
 - Cloud
 - Mobile
- A multi-architecture platform for hybrid workloads
- Lowest total cost of ownership for most enterprise workloads

Let's look at some of the key mainframe innovations...

The IBM mainframe was the world's first virtualized server

Virtualization

- Shared-everything design
- Virtualization built into the microcode
- Thousands of virtual guests
- Near 100% utilization
- Ideal choice for cloud deployments

IBM System z virtualization is built-in, not added-on, to give the best workload isolation

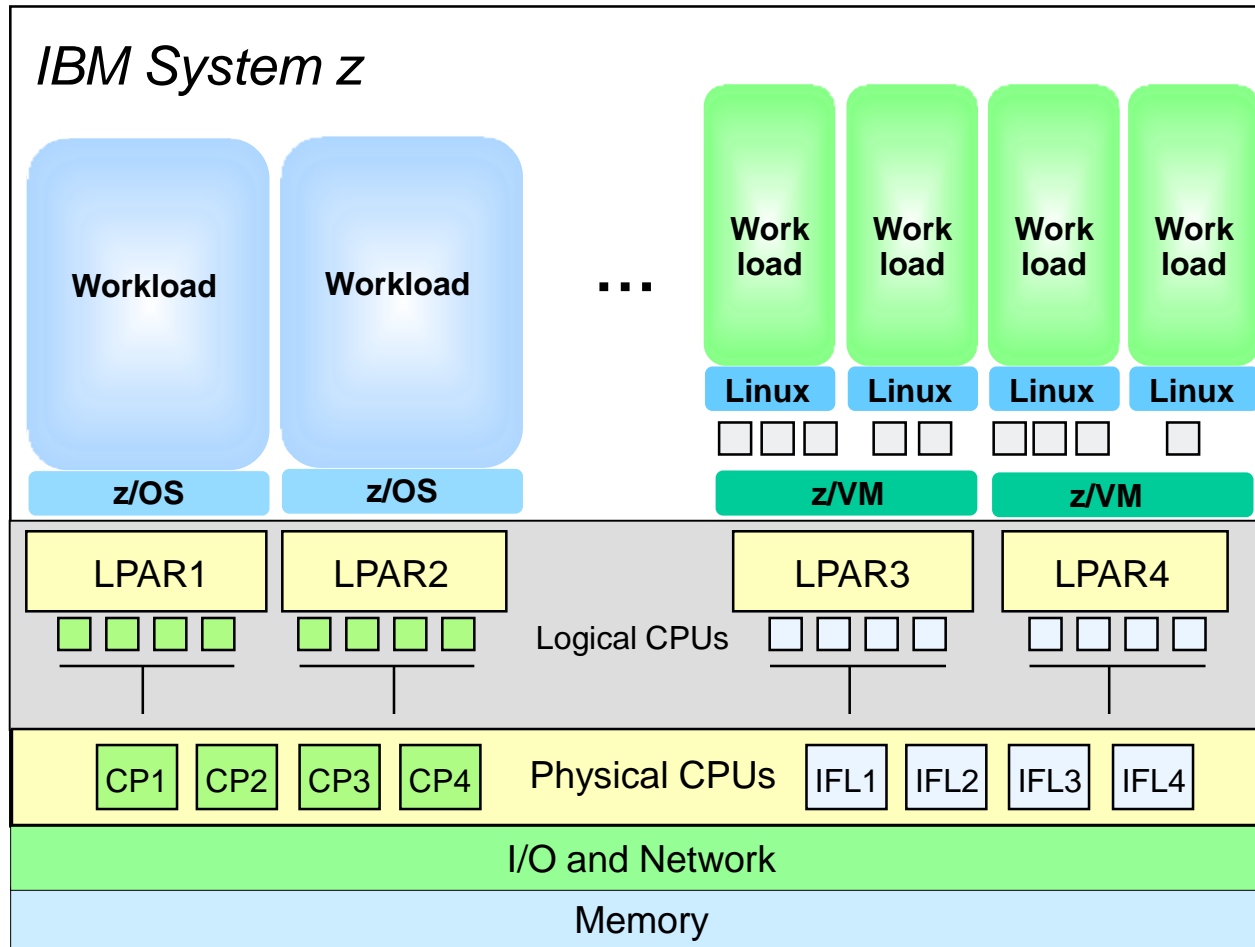

z/VM – a **software** virtualization hypervisor layer supporting 1,000s of Linux guests; up to 32 physical IFLs per z/VM LPAR

PR/SM – virtualization hypervisor layer in **firmware**; each **LPAR** is 1 operating system; workloads in LPARs are completely **isolated**

Shared-everything architecture

Hardware-enforced isolation: 10% of circuits support virtualization

DEMO: How many virtual machines can zEnterprise create?

Creating new Linux images.....Servers in seconds with IBM

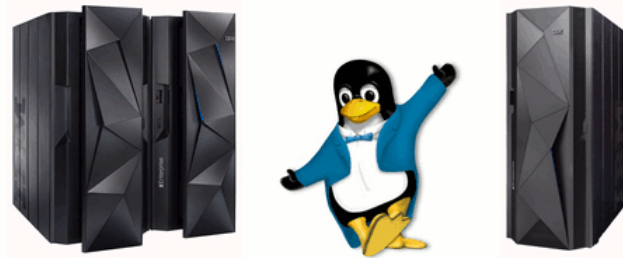

1000 Servers

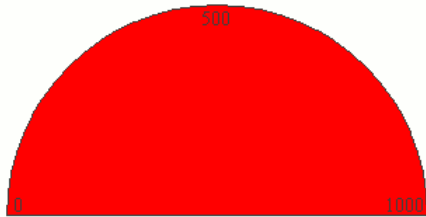

1000

Time Elapsed: 4:24:22 Avg 15

Compared to leading distributed hypervisors, z/VM demonstrates better scalability

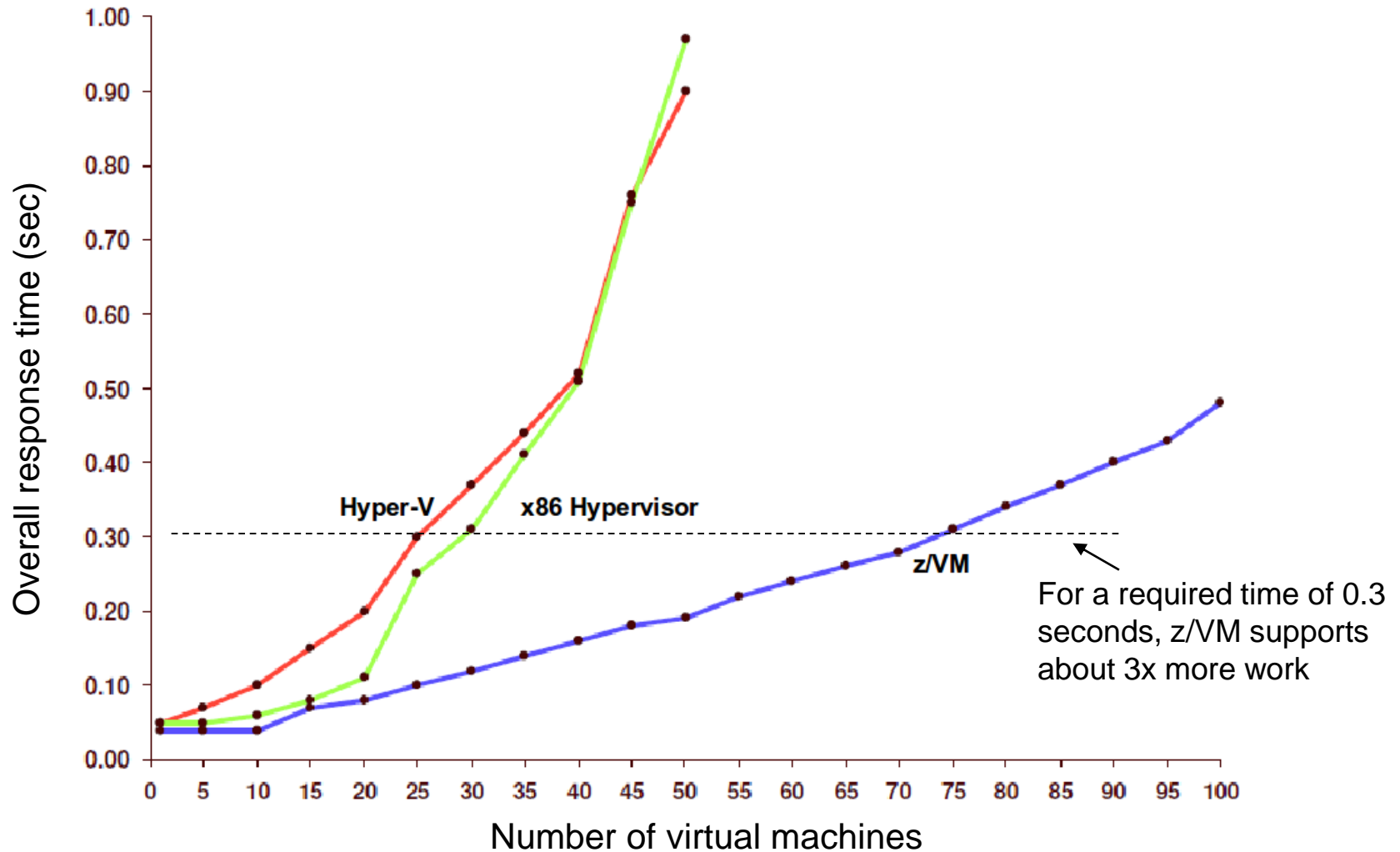

A unique zEnterprise feature not found on other servers is the I/O subsystem

Virtualization

I/O Subsystem

- Reduces CPU usage by offloading I/O overhead
- Reduces number and cost of software licenses
- Improves I/O performance for batch and high performance OLTP
- Allows introduction of new facilities into existing I/O subsystem

zEnterprise includes special processors dedicated to driving I/O

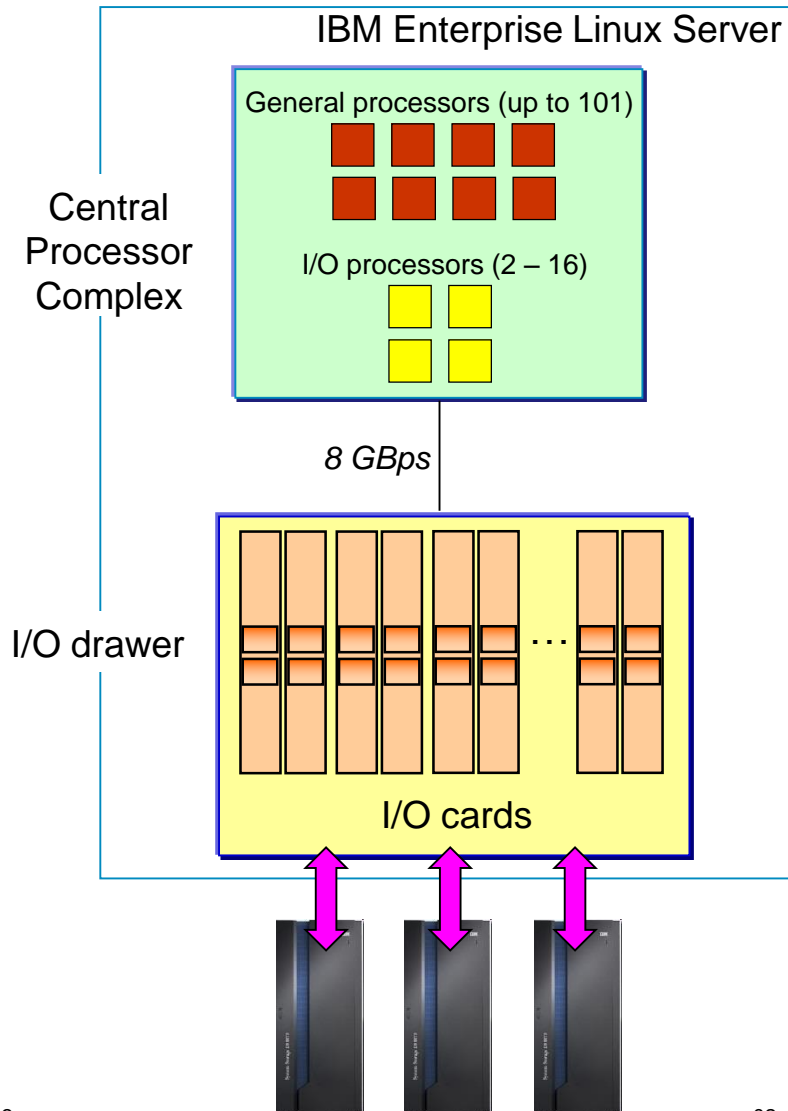

- I/O processing logic is offloaded to special processors
 - Isolates general processing cores for business logic
- I/O processors manage Logical I/O Channel Subsystem
 - Determines optimal physical I/O path to be used
 - Delivers optimized I/O efficiency
- Dedicated I/O subsystem is excellent for high I/O workloads, such as Batch and OLTP
- Intel servers have no dedicated I/O subsystem

In comparison tests of I/O load capacity, Intel times were significantly slower

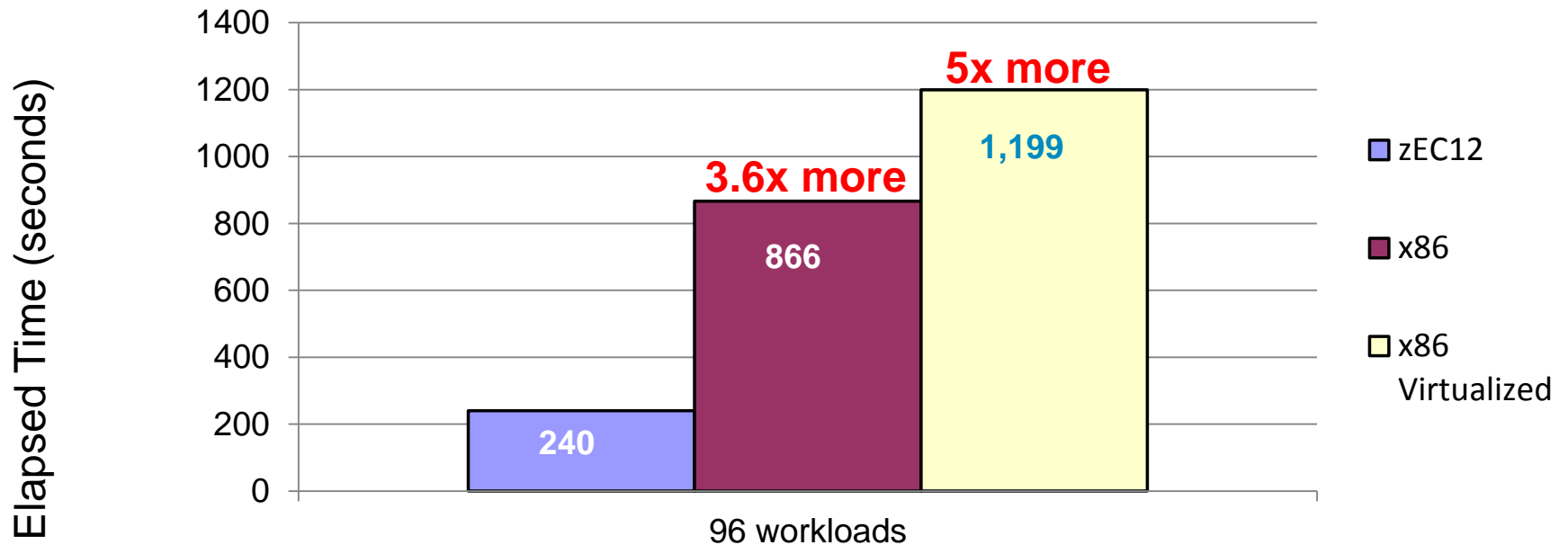

Performance comparison test of an I/O intensive workload with identical enterprise class storage. zEC12 had **8** core. Westmere EX server had **40** core @2.4GHz. Each system connected via 4 x 8Gb links to DS8800. zEC12 running against 8 SSD DASD CKD volumes. Intel server running against 8 SSD LUNs FB volumes. Note: Storage limitations came into effect at workload counts greater than 96.

Batch workloads take advantage of zEnterprise capability to support high I/O capacity

Intel Xeon E7-4870 + DS8300

40 processors
128 GB RAM
Linux Sort

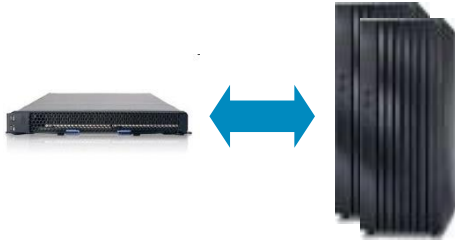

Sorting
Average CPU
89%

z/OS + DS8800

8 processors
128 GB RAM
DFSORT



Sorting
Average CPU
72%

SORT Job: Sort a 3 GB transaction file – Repetitions: 300

Total Elapsed
Bytes Per Sec

2,657 secs
240 MB

Total Elapsed
Bytes Per Sec

515 secs
3,000 MB

**13x more I/O
bandwidth
than Intel**

MERGE Job: Merge 30 sorted files into a 90 GB master file – Repetitions: 10

Total Elapsed
Bytes Per Sec

4,051 secs
157 MB

Total Elapsed
Bytes Per Sec

446 secs
3,460 MB

**Intel Batch window
is 7x longer than z/OS**

Source: IBM Internal Study. Intel system was constrained by CPU. Differences in storage device was not a factor in testing. Results may vary based on customer workload profiles/characteristics.

IBM continues to innovate with new PCIe features – Shared Memory Communications (SMC-R) introduced in 2013

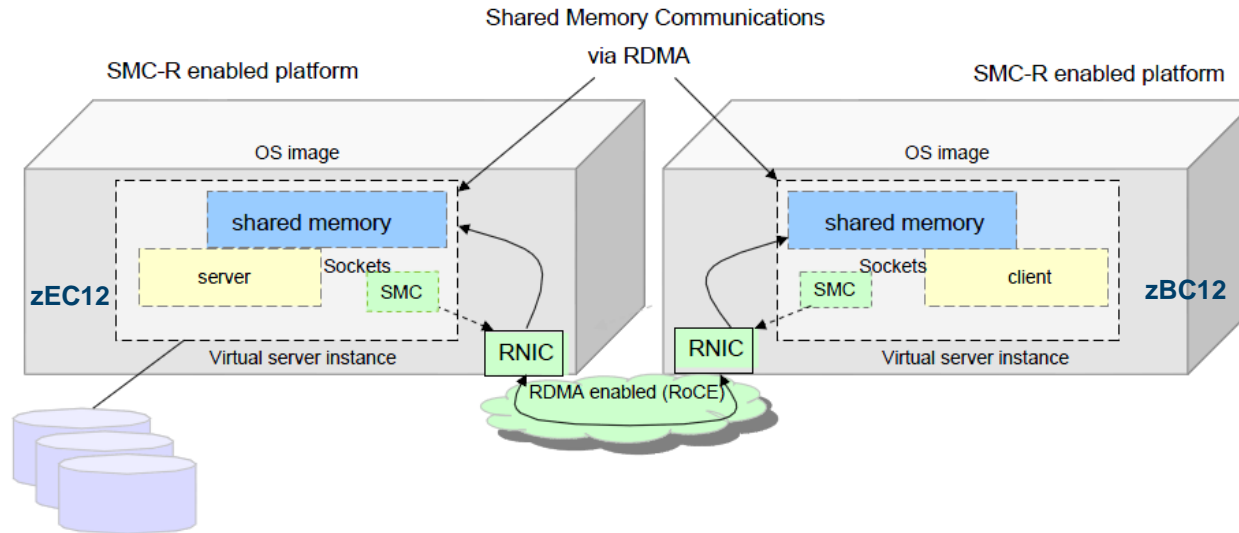

Network latency
reduced up to
80%*

- 10GbE RDMA over Converged Ethernet (RoCE) Express card
- Helps reduce latency and CPU resource consumption
- Runs over TCP/IP across z/OS systems
- Can be used seamlessly by *any* z/OS TCP sockets-based without any changes

* Based on internal IBM benchmarks of modeled z/OS TCP sockets-based workloads with request/response traffic patterns using SMC-R vs. TCP/IP. The actual throughput that any user will experience will vary.

Parallel sysplex gives zEnterprise continuous availability with near linear scalability

Virtualization

I/O Subsystem

Parallel Sysplex

- Optimized to support IBM middleware
- Provides a single image across the cluster
- Centralized design optimizes data sharing
- Enables near-infinite elasticity

zEnterprise parallel sysplex clusters provide unmatched processing power and availability



- Clustering driven by specialty engines (Coupling Facility)
- Presents a single system image of a z/OS workload
- Potentially **2.5M MIPS** per 32-way cluster*

Single System Sysplex

*Equivalent to about 240 of the largest Oracle servers

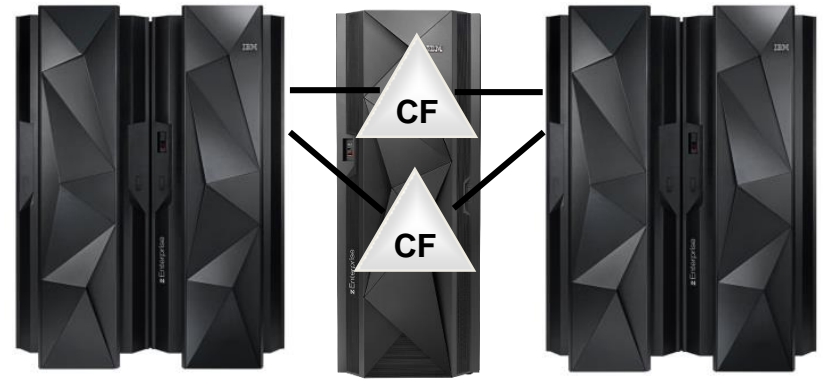

External Coupling Facility
(Can be different class server)

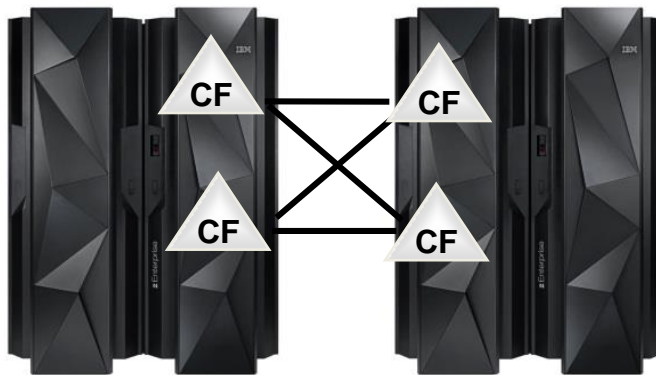

Cross Connected Servers with internal Coupling Facilities

- Enables rolling updates
- Supports continuous access to business services and data – from anywhere, at anytime
- Designed for **99.999%** availability

zEnterprise's centralized Coupling Facility permits efficient lock and cache management in DB2

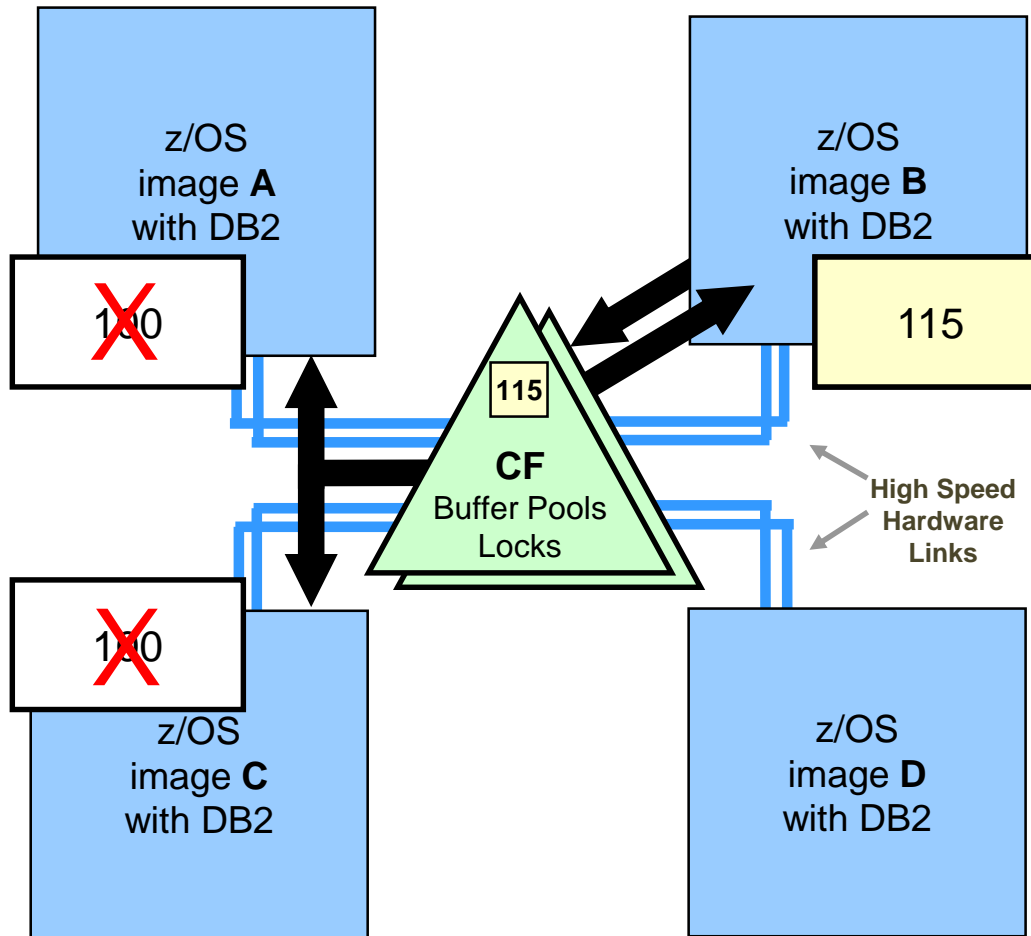

A and C have data in local buffer pool without locks

1. B registers page to CF and obtains write lock
2. B updates data
3. B commits update

B caches update in group buffer pool

CF invalidates all cached copies without interrupting processors

Cache and locks are maintained with no inter-node disturbance!

Oracle RAC's distributed lock management design causes overhead

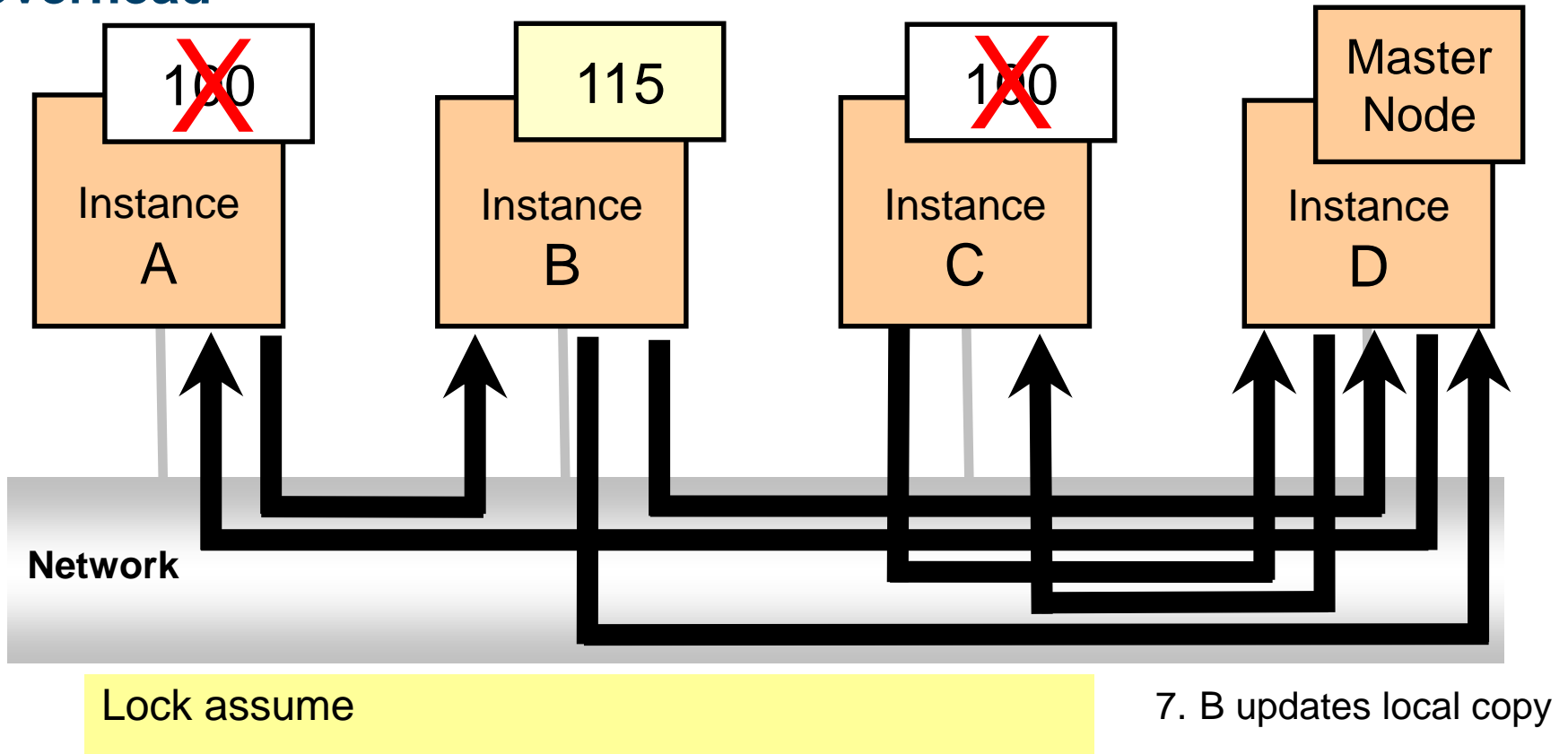

Inter-node connections: 6

In a cluster with 4 nodes, an update operation may need 6 network connections and two in-memory calls (not shown).

Example based on Oracle's US Patent 7,107,319 B2.

DB2 for z/OS in a parallel sysplex scales efficiently and transparently

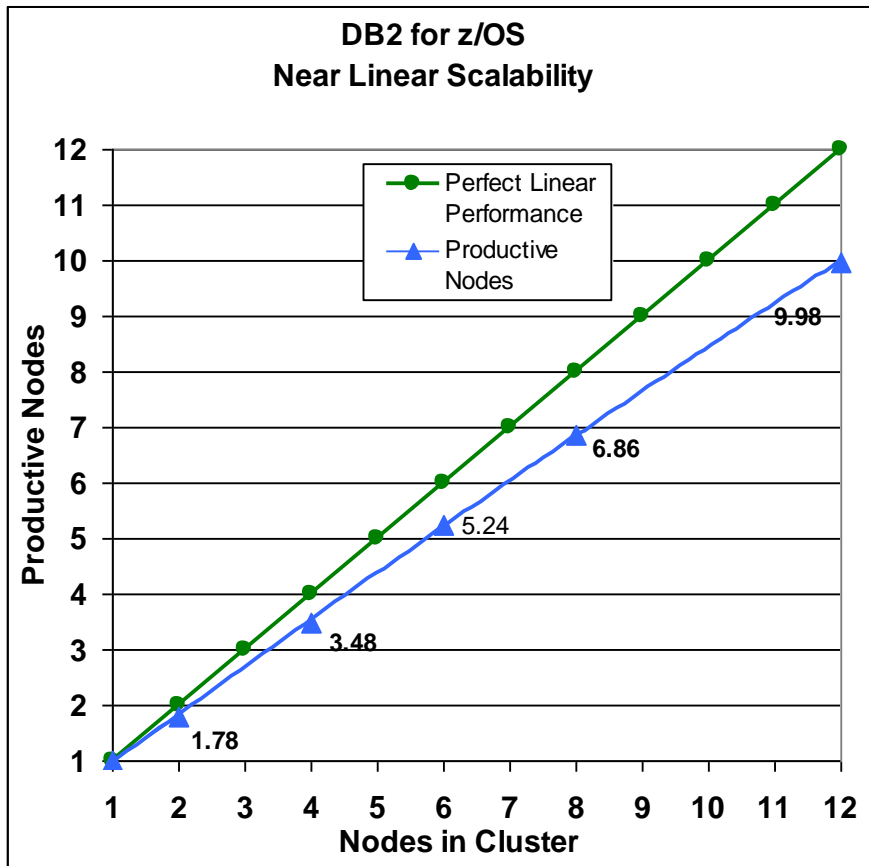

- DB2 leverages unique Parallel Sysplex clustering design to achieve near linear scaling
 - No data partitioning required
 - No transaction routing required
 - No cluster awareness required in applications

- Elastic processing capacity
 - Applications are not tied to database partitioning schemes
 - Automatically balances workload across cluster

The only option for Intel-based servers is Oracle RAC

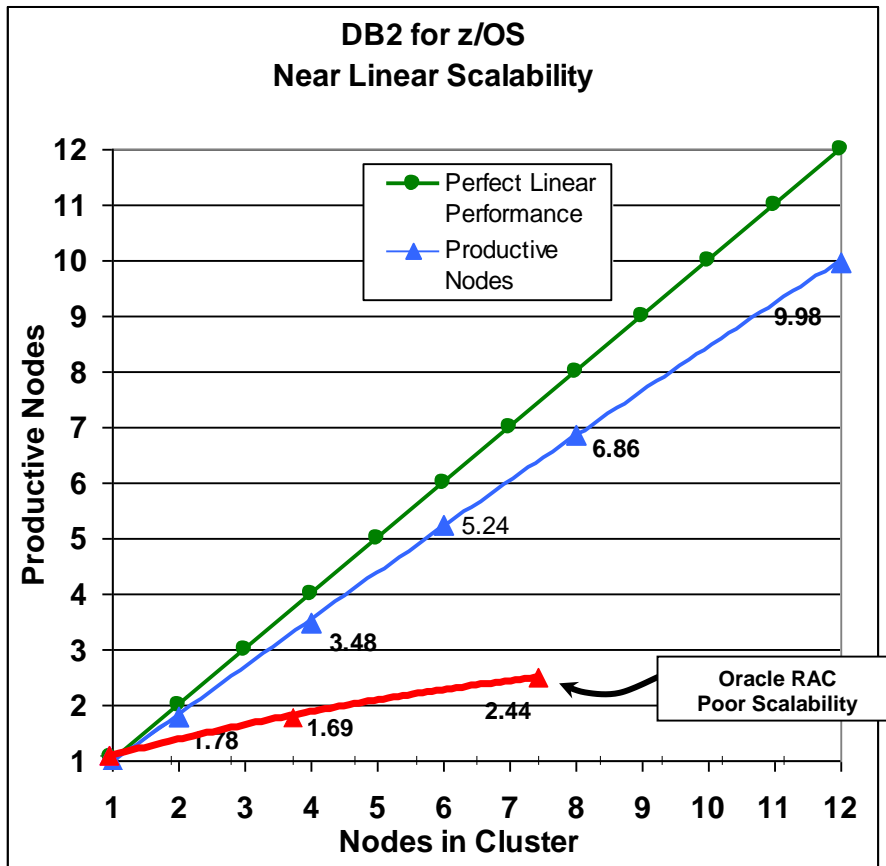

- Oracle RAC's lock and cache system is inefficient by design
 - Scaling RAC requires complex tuning and partitioning
 - Application partition awareness makes it difficult to add or remove nodes

- Published studies demonstrate difficult or poor scalability
 - Dell (shown in chart): Poor scalability despite using InfiniBand for RAC interconnect
 - CERN: Four month team effort to tune RAC, change database, change application
 - Insight Technology: Even a simple application on two node RAC requires complex tuning and partitioning to scale

Oracle RAC characteristics as shown in Dell RAC InfiniBand Study <http://www.dell.com/downloads/global/power/ps2q07-20070279-Mahmood.pdf>
 CERN (European Organization for Nuclear Research) http://www.oracreracsig.org/pls/apex/RAC_SIG.download_my_file?p_file=1001900
 Insight Technology <http://www.insight-tec.com/en/mailmagazine/vol136.html>

The zEnterprise demonstrates “perfect” workload management

Virtualization

I/O Subsystem

Parallel Sysplex

Workload Management

- Applies across all resources, not just CPU
- Ensures priority workloads meet service level agreements
- Cross platform
- Covers heterogeneous platforms

System z demonstrated perfect workload management and very high utilization – x86 hypervisor did neither

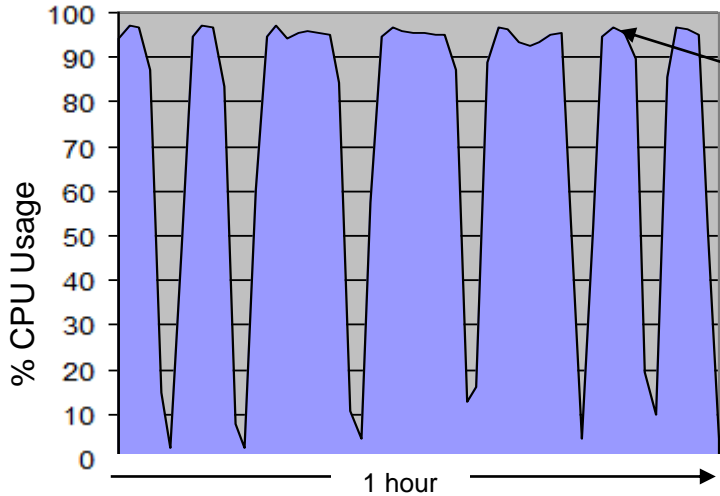

High priority workloads (blue) run at very high utilization and do not degrade

System z

Low priority workloads (maroon) consume all but 2% of remaining resources (gray)

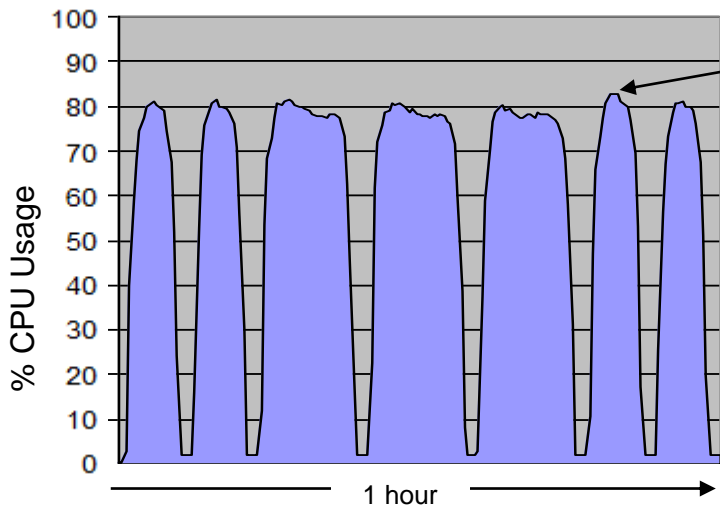
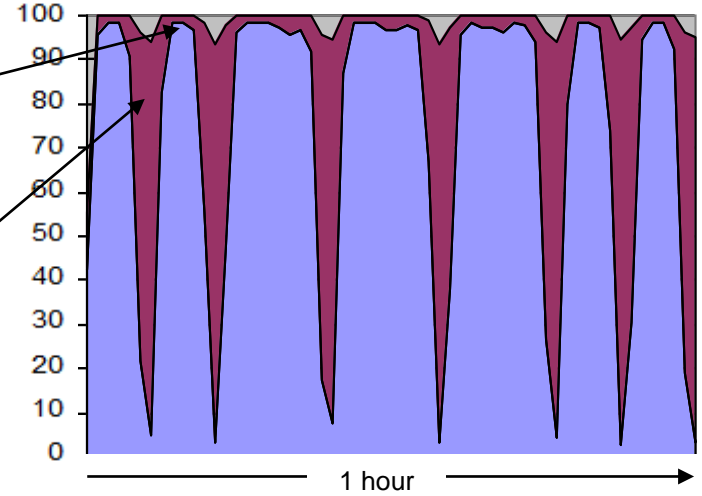

High priority workloads (blue) run at less high utilization and *degrade* when low priority workloads (maroon) added

x86 hypervisor

Too much resource (gray) remains unused (22%)

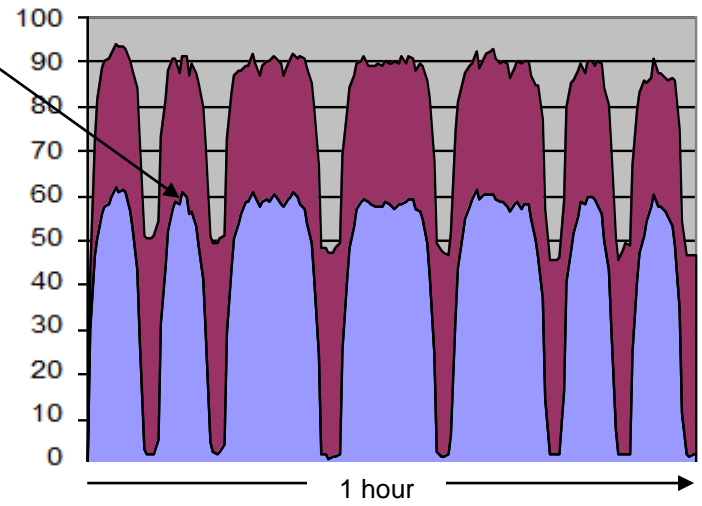

System z virtualization is much more efficient, and assures workload requirements are met

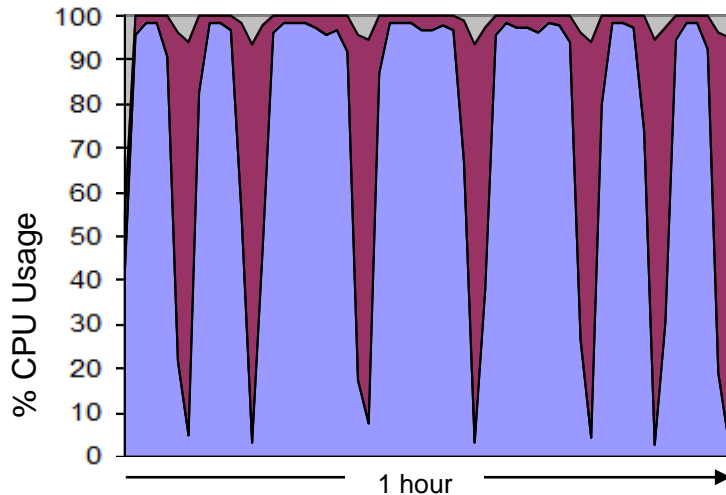

System z

- Perfect workload management
- Consolidate workloads of different priorities on the same platform
- Full use of available processing resource (high utilization)

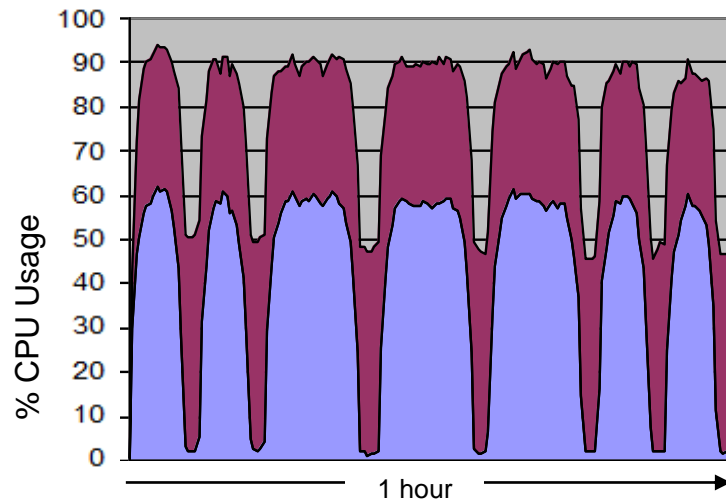

Common hypervisor on Intel

- Imperfect workload management
- *Forces workloads to be segregated on different servers*
- *More servers are required (low utilization)*

zEnterprise easily manages mixed priority workloads and lowers costs

Which platform provides the lowest TCA over 3 years?

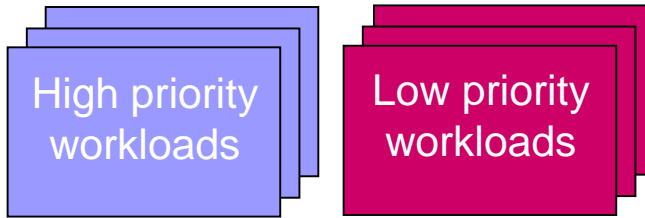

- IBM WebSphere 8.5 ND
- IBM DB2 10 AESE
- Monitoring software

High priority online banking workloads driving a total of **9.1M** transactions per hour and low priority discretionary workloads driving **2.8M** transactions per hour

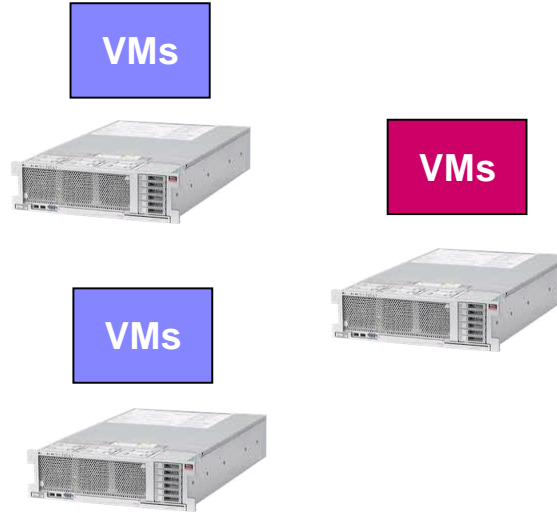

Virtualized on 3 Intel 40 core servers
\$16.3M (3 yr. TCA)

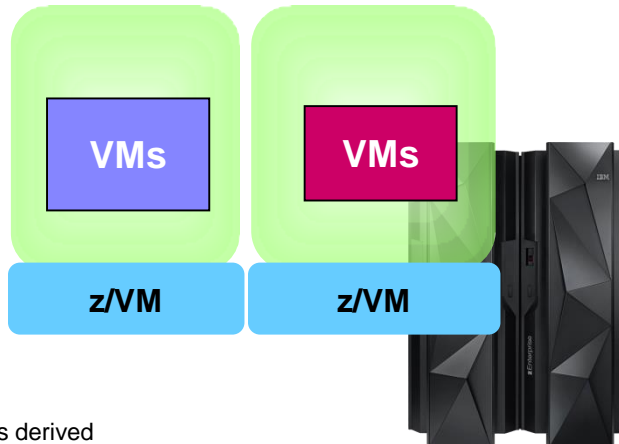

z/VM on zEC12
 32 IFLs
\$6.6M (3 yr. TCA)

60% lower cost!

Consolidation ratios derived from IBM internal studies.. zEC12 numbers derived from measurements on z196. Results may vary based on customer workload profiles/characteristics. Prices will vary by country.

Only zEnterprise offers numerous options for optimizing workloads to reduce costs

Virtualization

I/O Subsystem

Parallel Sysplex

Workload Management

Workload Optimization

- Tuned for highly efficient transaction handling
- Specialty engines for offload of some specific workloads
- Appliances can be added for workload acceleration
- Reduces costs and improves price/performance ratio

System z is first server to implement Hardware Transactional Memory

- Software-defined sequence treated by hardware as atomic “transaction”
- Enables significantly more efficient software
 - Highly-parallelized applications
 - Better concurrency for multi-threaded applications
 - Speculative code generation
- Exploited by Java and COBOL; longer-term opportunity for DB2, z/OS, others

*One of a number of features contributing to aggregate **60% improvement** in throughput for Java workloads*

```

* R1 - address of the new queue element to be inserted.
* R2 - address of the insertion point; new element is inserted
      before the element pointed to by R2.

NEW      USING      QEL,R1
CURR     USING      QEL,R2
                SETLOCK      OBTAIN, ...   Serialize access to queue.

PREV     LG         R3,CURR.BWD      Point to previous element.
                USING      QEL,R3      Make it addressable.
                STG        R1,PREV.FWD  Update prev. forward ptr.
                STG        R1,CURR.BWD  Update curr. backward ptr.
                STG        R2,NEW.FWD   Update new forward ptr.
                STG        R3,NEW.BWD   Update new backward ptr.
                SETLOCK      RELEASE, ...
  
```

```

* R1 - address of the new queue element to be inserted.
* R2 - address of the insertion point; new element is inserted
      before the element pointed to by R2.

NEW      USING      QEL,R1
CURR     USING      QEL,R2
                LHI         R15,10      Load retry count.
LOOP     TBEGIN      TDB,X'C000'      Begin transaction (save GRs 0-3)
                JNZ        ABORTED     Nonzero CC means aborted.
PREV     LG         R3,CURR.BWD      Point to previous element.
                USING      QEL,R3      Make it addressable.
                STG        R1,PREV.FWD  Update prev. forward ptr.
                STG        R1,CURR.BWD  Update curr. backward ptr.
                STG        R2,NEW.FWD   Update new forward ptr.
                STG        R3,NEW.BWD   Update new backward ptr.
                TEND       TDB         End transaction.
                ...
ABORTED  JO         NO_RETRY        CC3: Nonretryable abort.
                JCT       R15,LOOP    Retry transaction a few times.
                J         NO_RETRY        No joy after 10x; do it the hard way.
  
```

Source: IBM. Multi-threaded benchmark run on z/OS 1.13 comparing z196 with Java7SR1 and zEC12 with Java 7SR3

System z installed specialty engine capacity

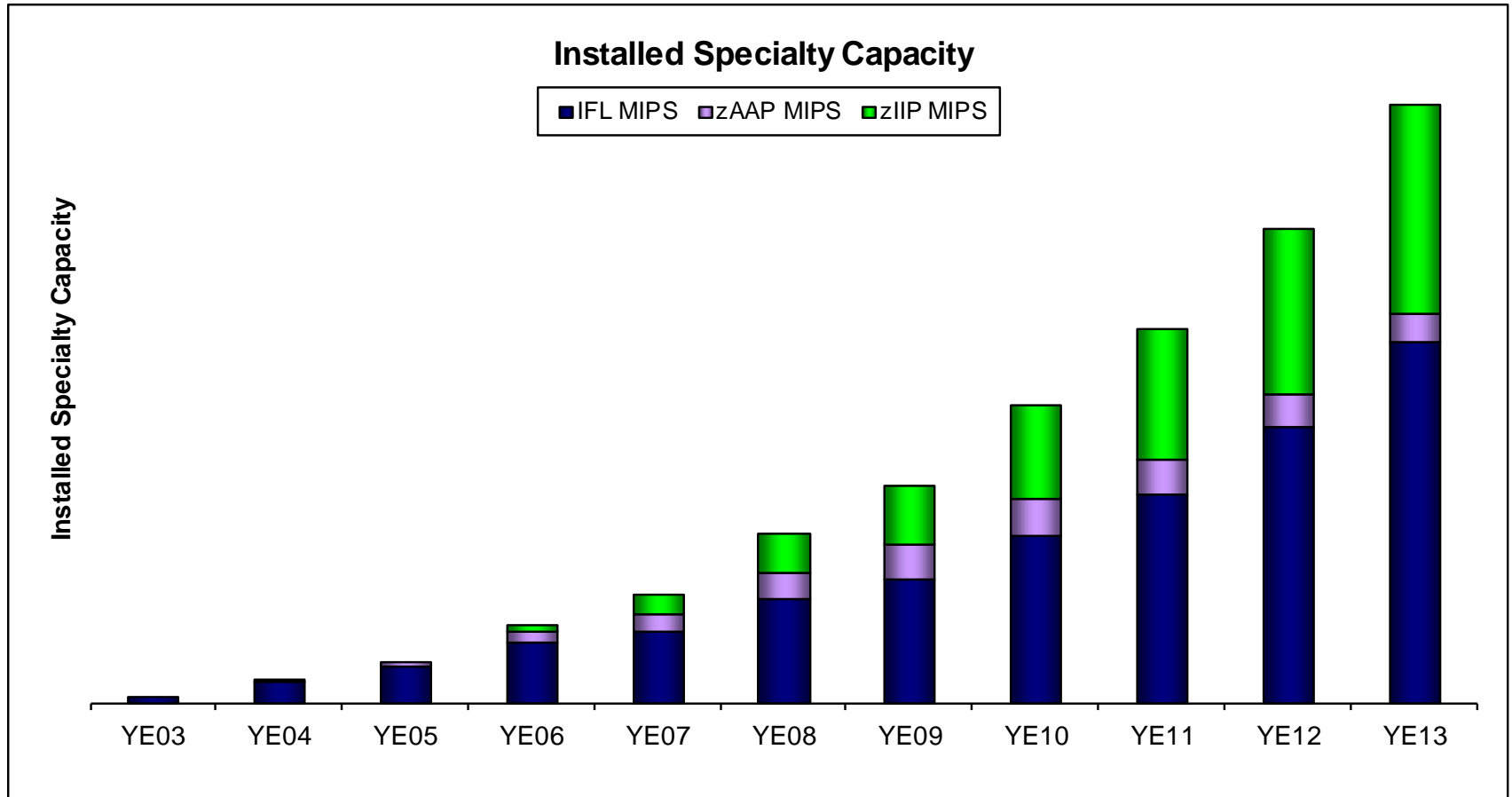

Workload optimizations are achieved via special I/O cards

zEnterprise Data Compression (zEDC) introduced in 2013



- Compatible with current coprocessor-based compression
- Specifically designed for large amounts of bulk data
- Cost effective – reduces CPU overhead, and storage overhead
- Optimizes cross-platform exchanges
 - Compatible with zlib compression – an industry standard widely used across all platforms

Up to **4x** data compression
Up to **118x** reduction in CPU

Up to **24x** throughput improvement with zlib

IBM DB2 Analytics Accelerator speeds up deep analytics queries

- A workload-optimized, blade-based appliance that runs queries in seconds versus hours
- Integrated with DB2 for z/OS, and transparent to applications
- Drives down the costs of data warehousing and business analytics

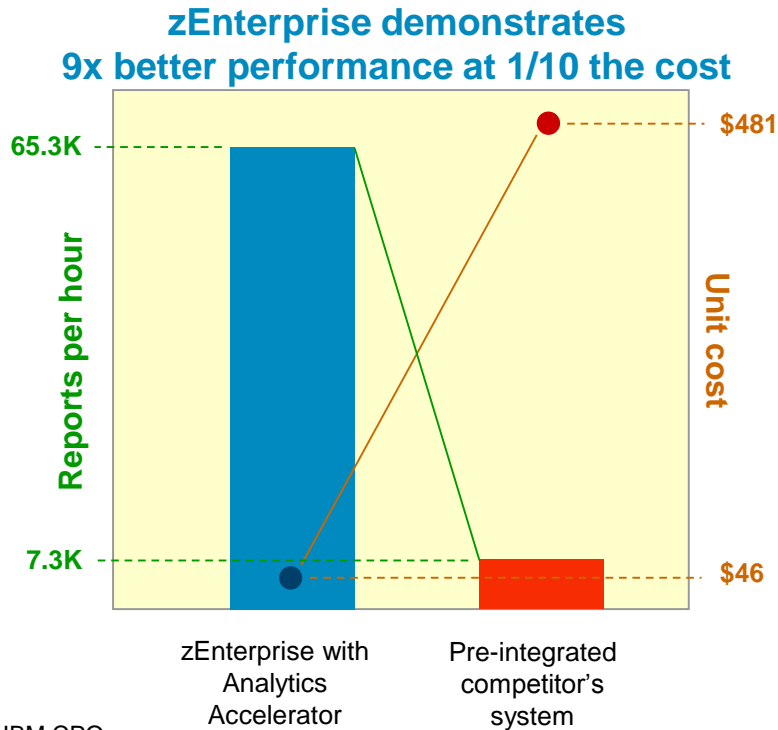

zEnterprise – the *most* secure commercially available platform

Virtualization

I/O Subsystem

Parallel Sysplex

Workload Management

Workload Optimization

Security

- Highest commercially available EAL ratings
- Multiple encryption options
- Provides full function Public Key certificate authority
- APIs extend encryption services across the enterprise
- State of the art security monitoring

Resource Access Control Facility (RACF) provides security throughout the entire zEnterprise stack

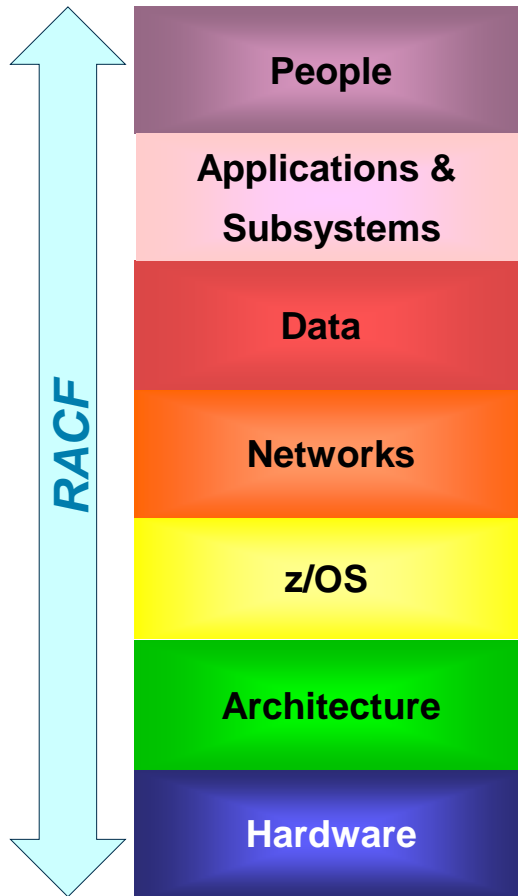

- Tools, reporting, auditing
- Access control to all classes of resources
- Integrated into the operating system
- Provides Enterprise Identity Management
- Supports cryptographic services
- Supports digital certificates

System z is the *hub* of security for the data center

IBM's Advanced Cryptographic Services extend System z security infrastructure to remote applications and platforms

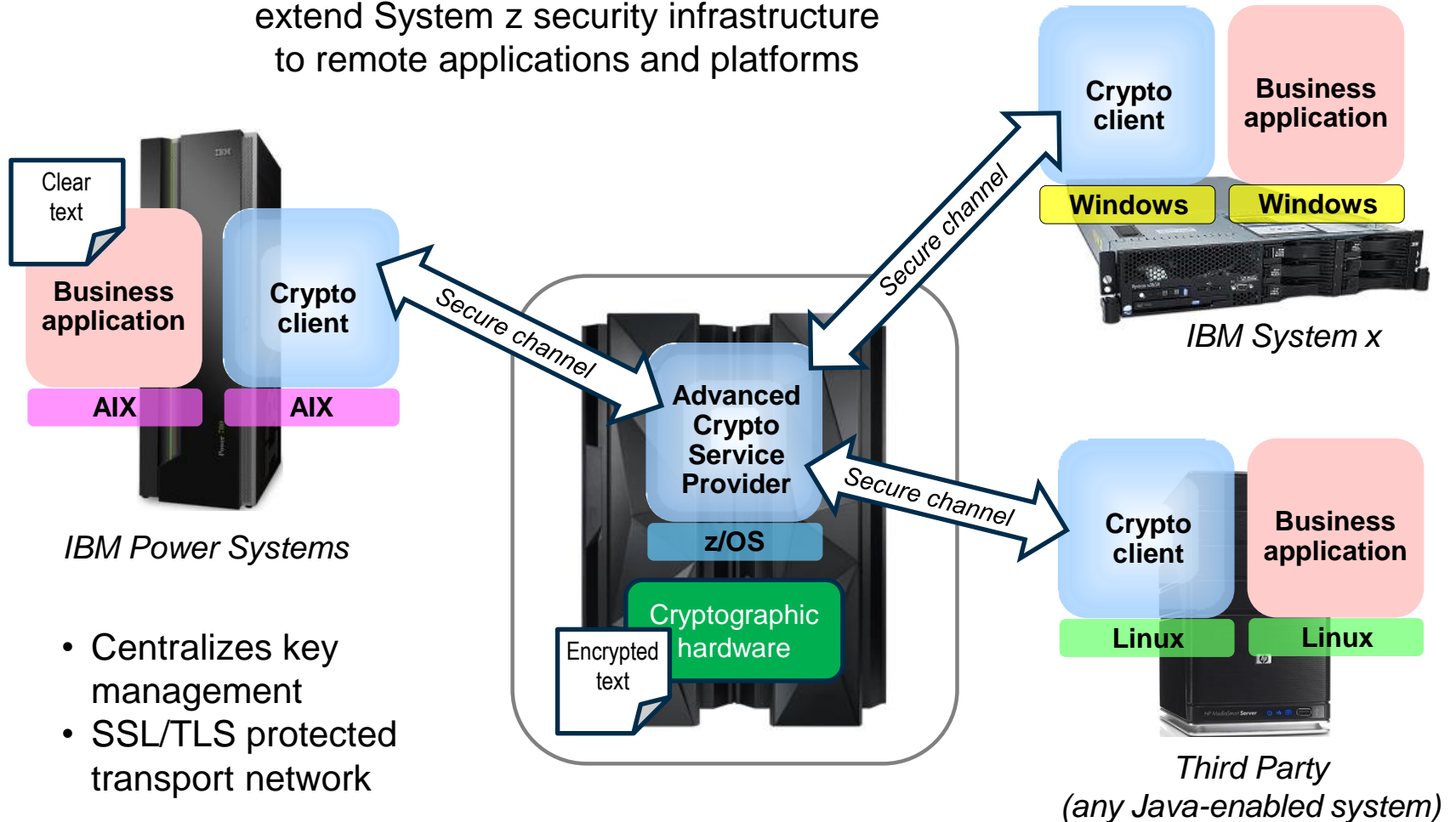

- Centralizes key management
- SSL/TLS protected transport network

Virtualized System z security is superior to other platforms and augmentation costs less

Security Natively Covered by Platform

Security Level Description	IBM System z	x86	Competitive UNIX
Normal corporate	100.00%	18.16%	30.26%
Credit card processing involved	99.00%	11.04%	18.28%
Banking	94.00%	5.26%	10.22%
Healthcare	100.00%	3.24%	8.51%
Research	92.50%	2.86%	4.16%
Defense	85.54%	0.26%	1.86%

- On System z, most security requirements are standard
- Major security deficiencies exist on distributed platforms

Incremental Cost to Achieve Required Security

- Distributed platforms require considerable additional expense to achieve required security levels

Security Level Description	IBM System z	x86	Competitive UNIX
Normal corporate	0.00%	32.54%	12.37%
Credit card processing involved	2.32%	46.27%	29.53%
Banking	2.07%	51.31%	26.58%
Healthcare	0.00%	67.26%	35.89%
Research	4.28%	91.26%	64.28%
Defense	11.36%	125.41%	102.26%

Source: "Tracked, Hacked and Attacked?"

© 2013, Solitaire Interglobal Ltd. https://www.ibm.com/services/forms/signup.do?source=stg-web&S_PKG=ov14292

zEnterprise's reliability, availability and serviceability are legendary

Virtualization

I/O Subsystem

Parallel Sysplex

Workload Management

Workload Optimization

Security

Reliability

- Comprehensive, multi-layered strategy for reliability and serviceability
- Supports large number of concurrent operations during maintenance
- “Five 9s” availability
- Lowest costs

Redundant Array of Independent Memory (RAIM) provides more protection against failures, improving availability

- Soft memory errors are primarily caused by background radiation (i.e., cosmic rays)
- Most servers use ECC (error correcting code) and parity checking to correct these errors
- System z uses RAIM – more robust than ECC
 - Each Memory Controller has an extra channel, equivalent to 20% additional memory
 - Protects against DRAM, socket, memory channel or DIMM failures
 - More cost effective than full 100% memory mirroring (i.e., complete redundancy)
 - No performance penalty

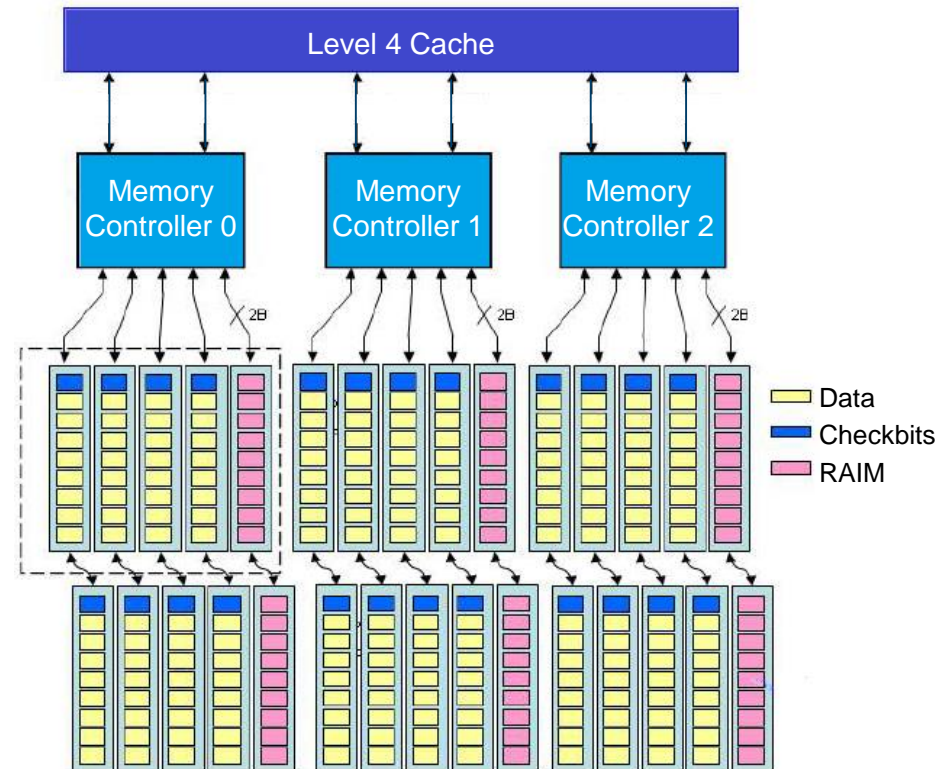

Downtime seriously effects sales, revenue, customer satisfaction

Revenue Impact of Downtime per Hour

Figure 1 Cost of downtime by industry segment
Average = \$2.7M

Industry/Sector	Revenue/Hour
Energy	\$1,468,798
Telecommunications	\$4,611,604
Financial	\$8,213,470
Information Technology	\$3,316,058
Insurance	\$2,582,382
Pharmaceuticals	\$2,058,710
Banking	\$1,145,129
Consumer Products	\$989,795
Chemicals	\$1,071,404
Transportation	\$1,463,128

Source: Robert Frances Group 2006

Business Impact of 10 Minutes of Downtime

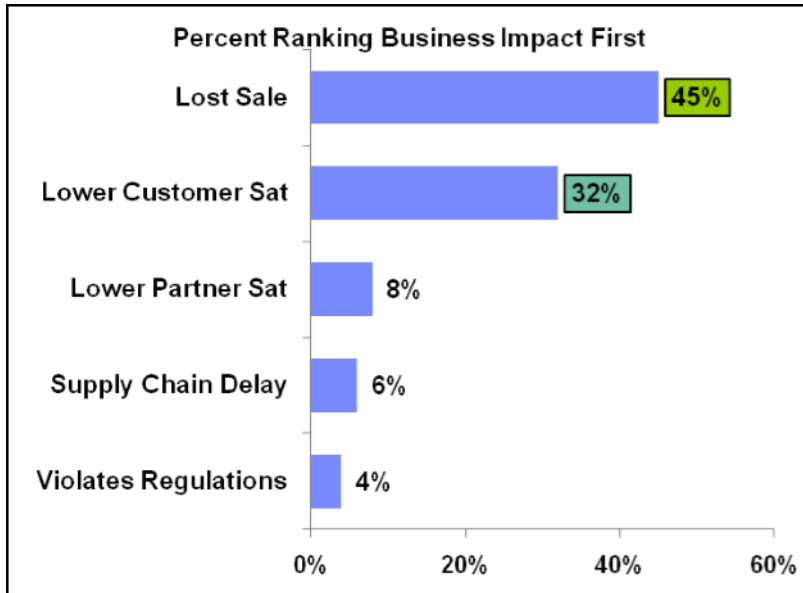

Source: IBM Customer Survey

Profit Impact of Downtime

A Telco	%	Profit 2009	Profit/Hr	Profit/Min
Wireless	68%	\$3,000,000,000	\$342,466	\$5,708
Cable	29%	\$1,300,000,000	\$148,402	\$2,473
Media	3%	\$120,000,000	\$13,699	\$228
Total	100%	\$4,420,000,000	\$504,566	\$8,409

zEnterprise supports concurrent operations during maintenance

Capability	zEC12	x86
ECC on Memory Control Circuitry	Transparent While Running	Can recognize/repair soft errors while running; limited ability with hard errors
Oscillator Failure	Transparent While Running	Must bring server down to replace
Core Sparing	Transparent While Running	Must bring server down to replace
Microcode Driver Updates	While Running	Some OS-level drivers can update while running, not firmware drivers; reboot often required
Book Additions, Replacement	While Running	Must bring server down
Memory Replacement	While Running	Must bring server down
Memory Bus Adaptor Replacement	While Running	Must bring server down
I/O Upgrades	While Running	Must bring server down to replace (limited ability to replace I/O in some servers)
Concurrent Driver Maintenance	While Running	Limited – some drivers replaceable while running
Redundant Service Element	2 per System	“Support processors” can act as poor man’s SE, but no redundancy

Single book systems may not support concurrent memory upgrades

DEMO: Dynamically add processing capacity to z/VM LPAR to handle increased workload... *without disruption*

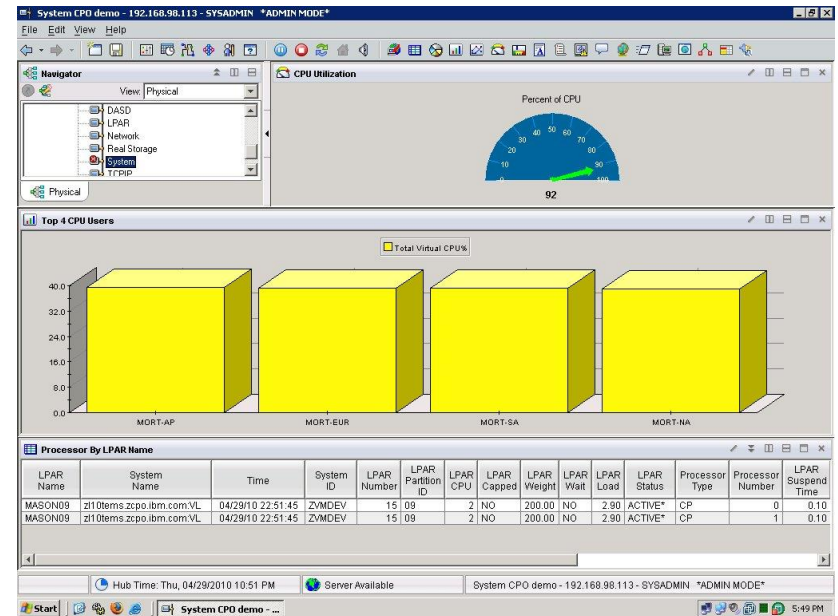
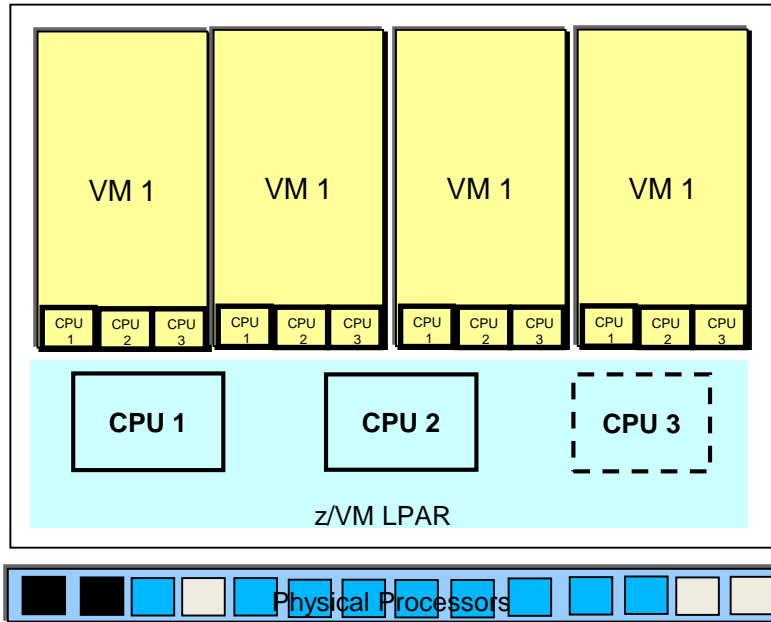

Tivoli Enterprise Portal

- Guest VMs run without disruption
- Dynamically add logical processors to z/VM LPAR
- Dynamically add processors shared among LPARs

Today's mainframe – 50 years of *continuous* innovation...

Virtualization

I/O Subsystem

Parallel Sysplex

Workload Management

Workload Optimization

Security

Reliability



IBM zEnterprise EC12

**Now let's look at several
new opportunities
for zEnterprise workloads...**