

# Positioning Your Enterprise for Cloud, Analytics and Mobile Computing

The mainframe and mobile computing: A perfect match



# Sessions in this track

1. Positioning your enterprise for cloud, analytics and mobile computing  
*Break (15 minutes)*
2. **The mainframe and mobile computing: A perfect match**  
*Break (15 minutes)*
3. Scoring fast and winning big with analytics on z Systems  
*Lunch (60 minutes)*
4. Implementing hybrid clouds with z Systems  
*Break (15 minutes)*
5. Easy and agile development and administration for cloud, analytics and mobile computing  
*Break (15 minutes)*
6. Building the business case for cloud, analytics and mobile computing

# Use of mobile devices for business is *soaring* – evidenced by recent Cyber Monday sales

## Department Stores Cyber Monday

Sales ▲ 17.92%

Transaction Metrics	Cyber Monday 2014	Cyber Monday 2014 vs. 2013
Items per Order	3.25	2.20%
Average Order Value	\$146.07	-9.74%
Conversion Rate	5.05%	3.48%
New Visitor Conversion Rate	3.91%	3.17%
Shopping Cart Sessions	16.41%	0.86%
Shopping Cart Conversion Rate	30.51%	3.95%
Shopping Cart Abandonment Rate	69.49%	-1.64%

2013: "Mobile Shopping Soars: Mobile traffic grew to 31.7% of all online traffic, increasing by 45% over 2012. Mobile sales were also strong, exceeding 17% of total online sales, an increase of 55.4% year-over-year."<sup>\*\*</sup>

## Cyber Monday

U.S. Retail, Performance by Device/Platform

IBM Digital Analytics Benchmark

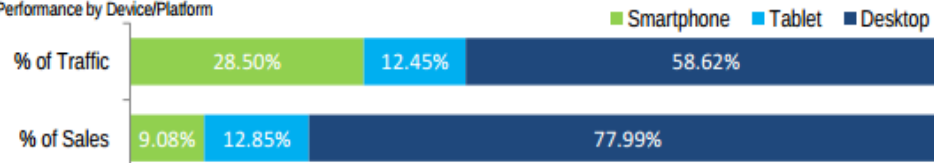

2014: "Cyber Monday Becomes Mobile Monday: Cyber Monday mobile traffic accounted for 41.2% of all online traffic, up 30.1% over 2013. Mobile sales were also strong, reaching 22% of total Cyber Monday online sales, an increase of 27.6% year-over-year."<sup>\*</sup>

<sup>\*</sup> <http://www-01.ibm.com/software/marketing-solutions/benchmark-reports/benchmark-2014-cyber-monday.pdf>

<sup>\*\*</sup> <http://www-01.ibm.com/software/marketing-solutions/benchmark-reports/benchmark-2013-cyber-monday.pdf>

Order value down by almost 10% in 2014 but overall sales up from more orders

# Mobile is changing the way customers interact – yielding far more possibilities for business

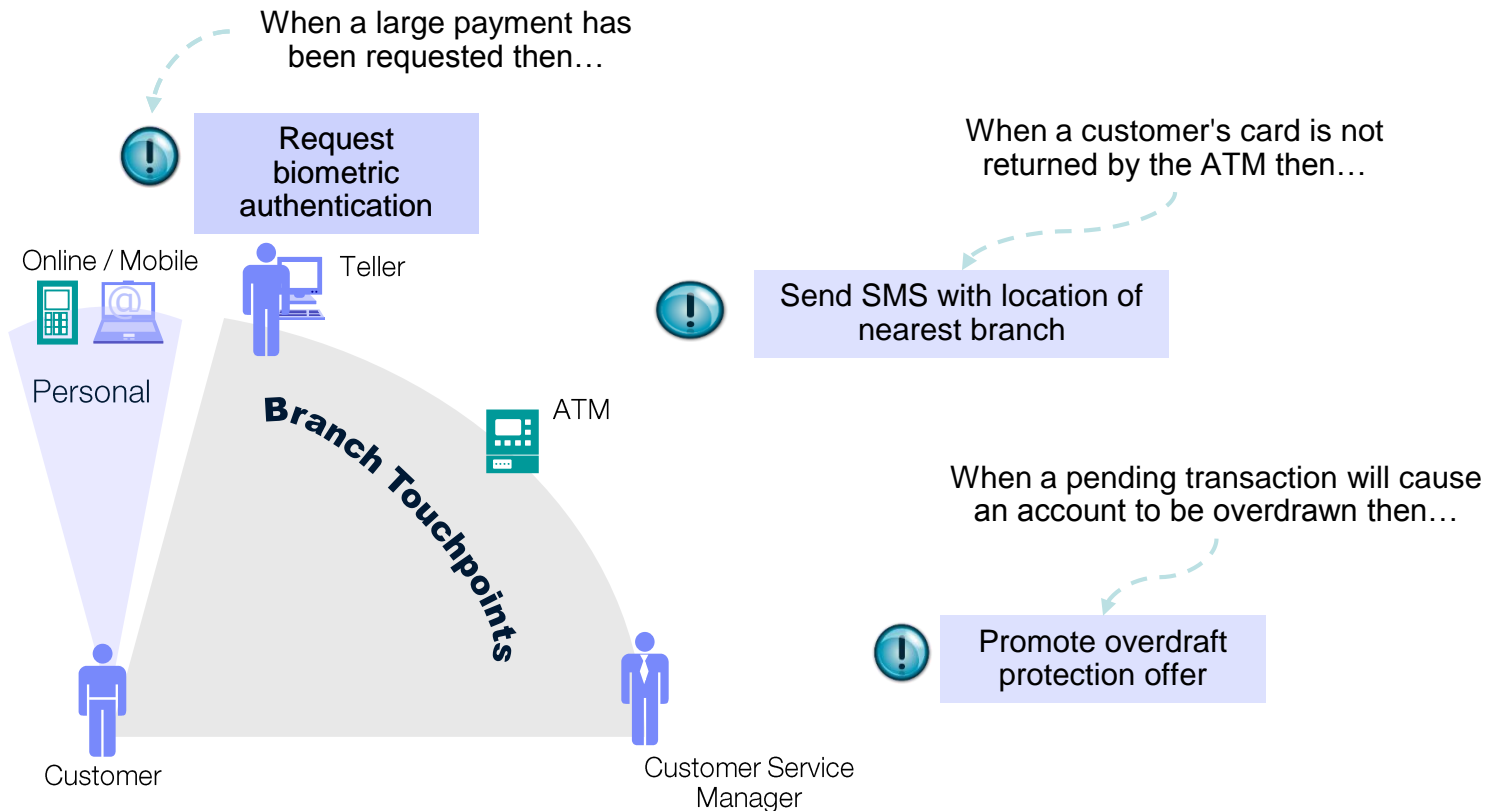

# A mobile strategy is critically important to business today

- Enables premium customer service
- Broadens market reach
- Increases revenue
- Increases operational efficiency

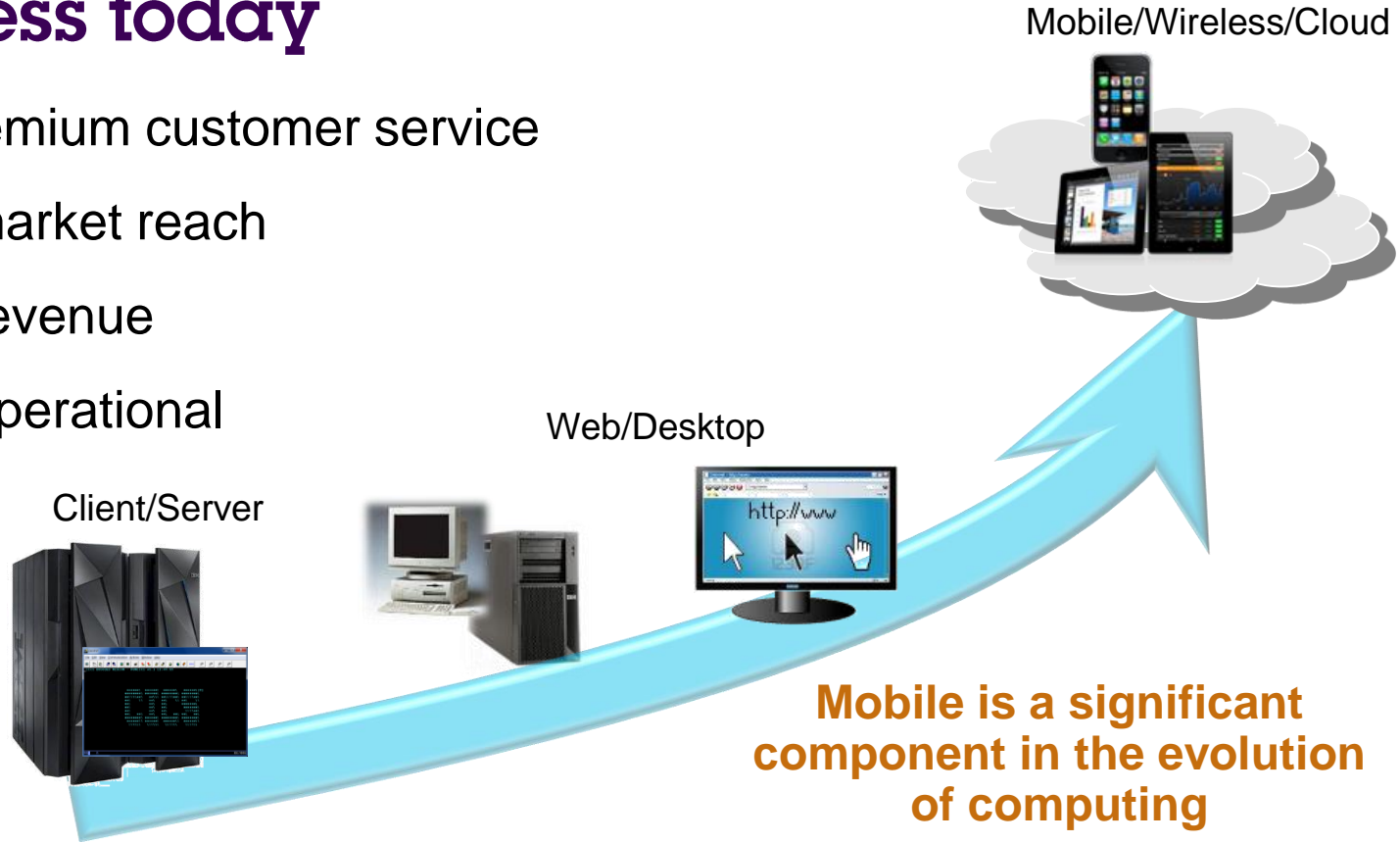

# The mobile revolution is putting new demands on business and IT infrastructure

## Systems of Record must handle:

- Huge increases in system load
- Inconsistent, unpredictable peaks
- New security and privacy requirements

## Systems of Engagement must handle:

- Agile and social connection to mobile users
- Interface to a vast array of device types
- Very frequent revisions of apps
- Easy-to-use, standards-based app development tools

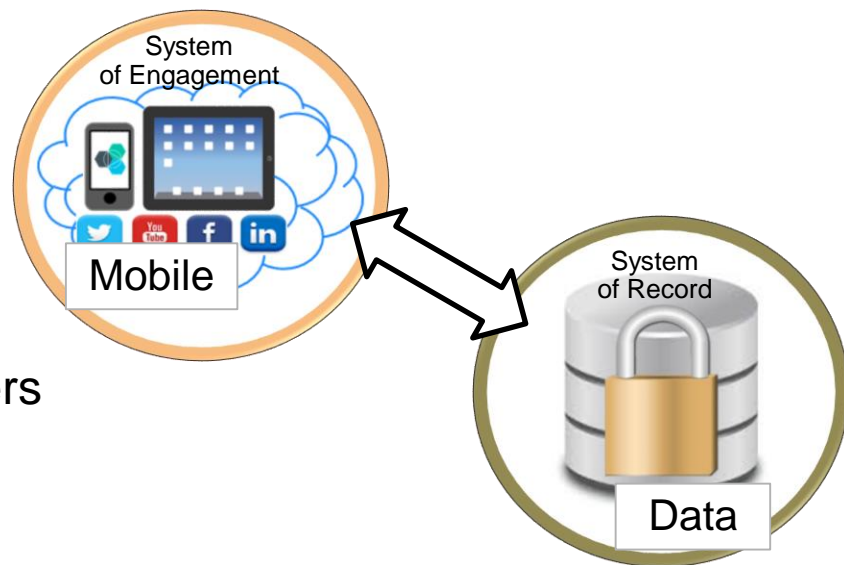

# IBM MobileFirst embodies a superior System of Engagement for mobile computing on z Systems

## IBM MobileFirst –

A foundation for exceptional mobile experiences with z Systems

Highest performance

Complete integration

Ultimate security

Low cost

**z Systems delivers unmatched performance for mobile applications**

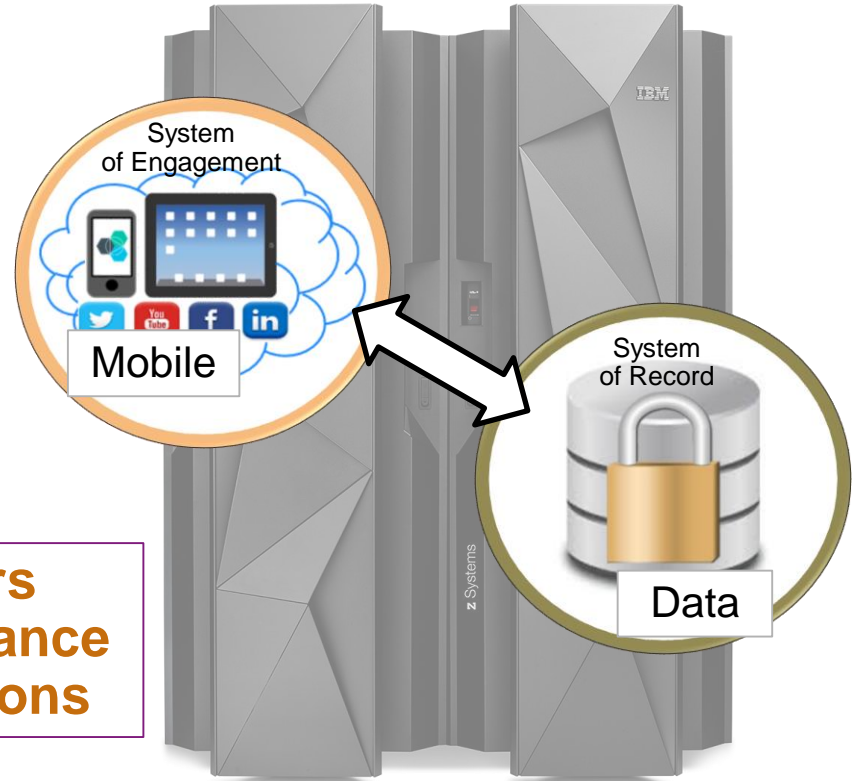

# z Systems delivers the capacity and performance to securely and reliably support all transactions

- **Support for huge transaction rates**
  - A single IMS Fast Path has been benchmarked at over 100,000 TPS, sustained\*
- **Perfect workload management**
  - z/OS Workload Manager insures that high priority jobs meet their service levels
- **Massive scalability**
  - Parallel sysplex and data sharing provide clustering and load balancing
- **Capacity on demand**
  - Add physical processors as needed to handle unexpected peaks
- **Unparalleled qualities of service**
  - Least amount of downtime of any commercially available server; built-in redundancy for highest availability



\* <http://www-01.ibm.com/software/data/ims/benchmark.html>



# Internet giants *wish* they had the traffic volume handled by z Systems

## Let's get some perspective

Every *second*, every day:

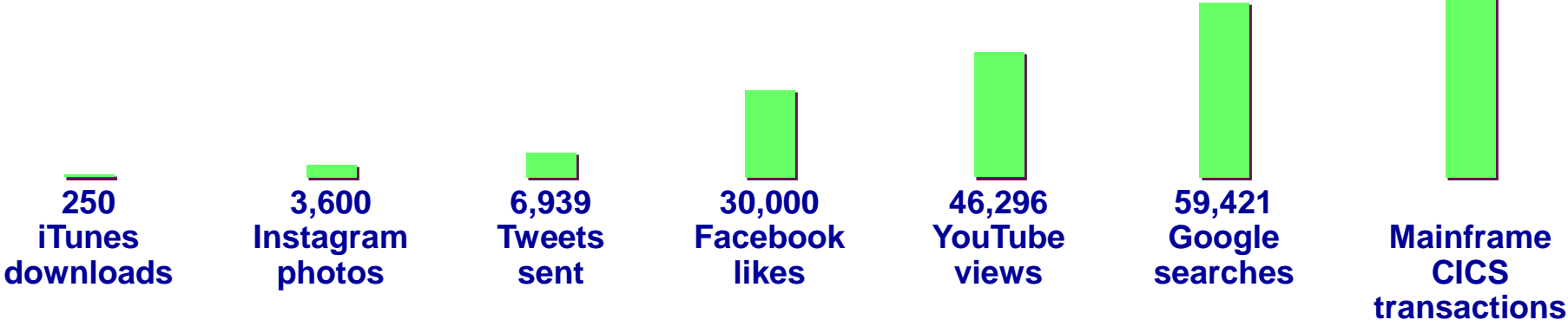

Competitive Project Office

Source: IBM Hursley 2013-10-7



# IBM MobileFirst embodies a superior System of Engagement for mobile computing on z Systems

## IBM MobileFirst –

A foundation for exceptional mobile experiences with z Systems

Highest performance

Complete integration

Ultimate security

Low cost

**Mobile apps integrate seamlessly with data and business applications**

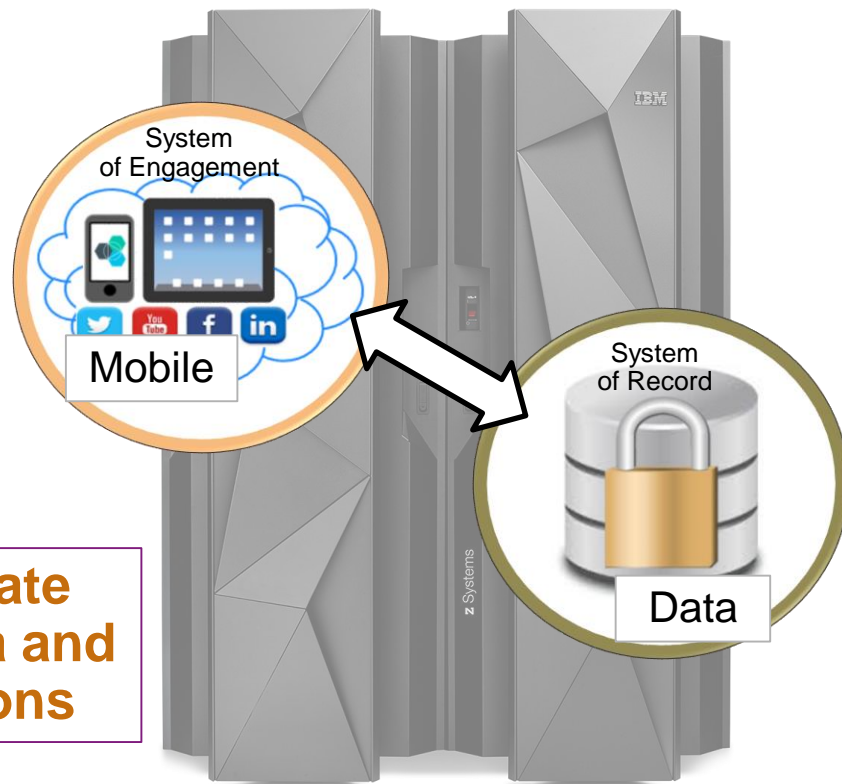

# MobileFirst, running on Linux on z, provides centralized connectivity to z/OS applications

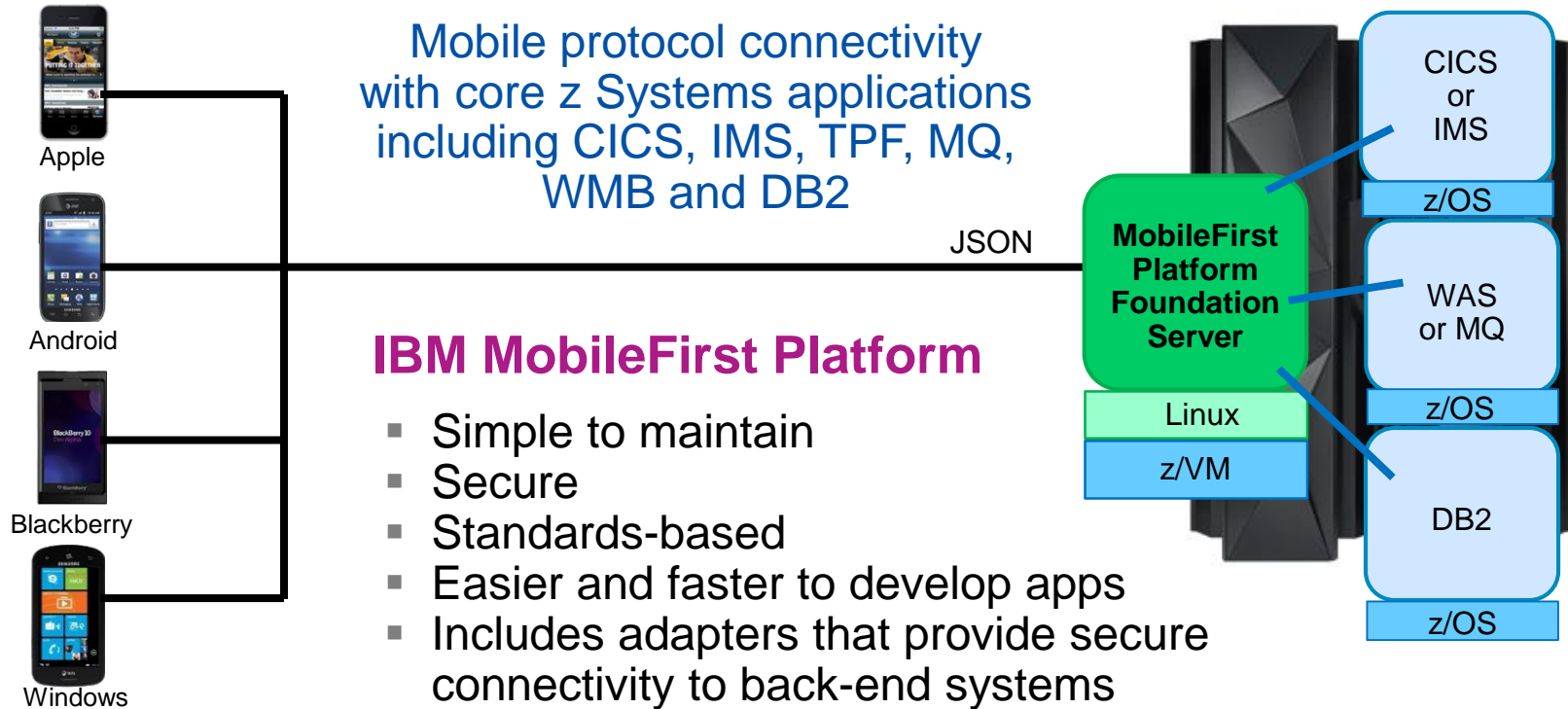

# Business applications can be mobile-enabled using MobileFirst and JSON Web Services

Expose an existing CICS application as a JSON-callable service:



JSON

- Use stored procedure to generate a JSON schema corresponding to the language structure of the existing CICS application.
- CICS Pipeline processing converts the request into the correct format
- WSBIND maps CICS format data to JSON

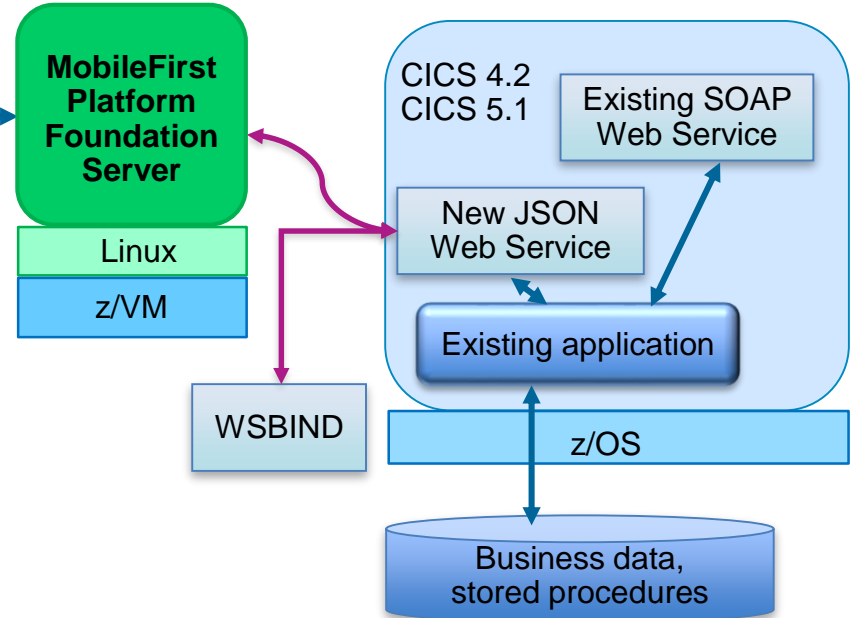

Existing SOAP/Web Services interface remains unaffected by the introduction of new mobile based clients

# IMS is easily accessed by mobile devices

Mobile Devices



IBM DataPower Gateway



**MobileFirst  
Platform  
Foundation  
Server**

SQL  
Adapter

HTTP  
Adapter

Linux

z/VM

IBM z/OS

IMS  
Connect

Database  
Manager

Transaction  
Manager

IMS  
Application

IMS  
DB

- Access to both transactions and DB data from MobileFirst Platform Foundation Adapters and from DataPower Gateway

# IMS goes mobile at FNB (South Africa)

...in South Africa, more people have *cellphones* and *smart mobile devices* than **bank accounts**. FNB wanted to launch a reliable, secure and highly responsive mobile channel...

- FNB is committed to IMS – it's strategic to their business
- Solution:
  - Implemented IMS Connect and SOAP Web Services around core z/OS IMS applications
- Benefit:
  - IMS workload grew by 920M transactions a month
  - Customer-initiated transactions workload – including mobile
  - has doubled every year for 6 years

*“Innovation and technology are core to FNB business strategy. We achieved our goals with IMS as our core strategic transactional system providing both transactional and batch workload support, capability to scale in both transactional and database volumes, cloud-like concepts, and 24x7 service capability.”*

— Jay Prag, FNB of South Africa



# Co-locating MobileFirst Server on z Systems yields more throughput and lower cost per workload

Mobile Insurance workload

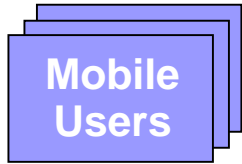

- 400 concurrent connections
- 60% Login, 30% Add or Delete, 10% Update

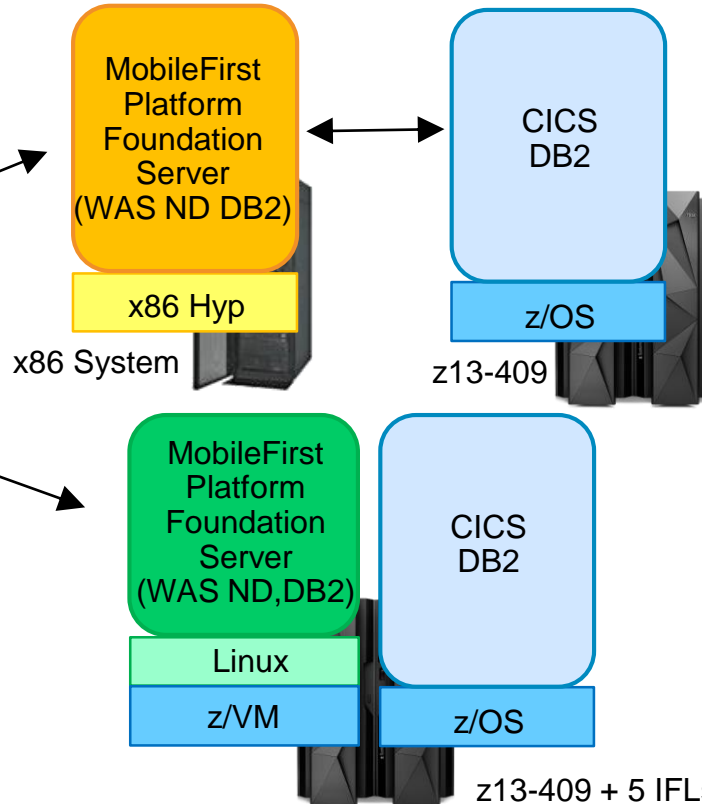

2,145 trans/sec (tps)  
205 ms response time  
\$2,490 per tps\*

3,446 trans/sec (tps)  
131 ms response time  
\$2,070 per tps\*

<b>61%</b>	More throughput
<b>17%</b>	Lower cost per tps

Competitive Project Office

Estimated performance, sizing and cost for z13 based on tests conducted on zEC12.  
Competitor x85 System – Intel E5-2697v2 2.7 GHz 6co used  
\* 3 yr. TCA (Prod + Dev/QA + DR)

# Easily and quickly extend mainframe-based business applications to mobile users

## IBM MobileFirst Platform Foundation Studio

Develop

Test

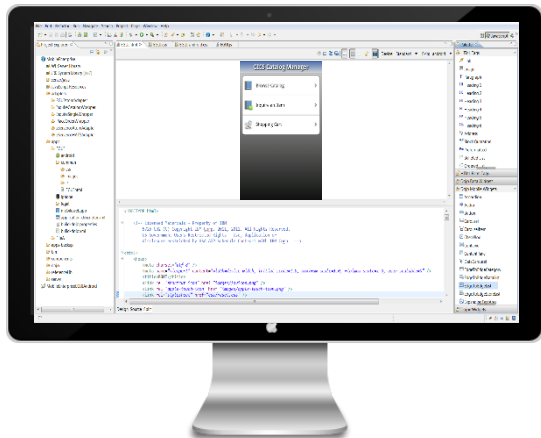

Deploy

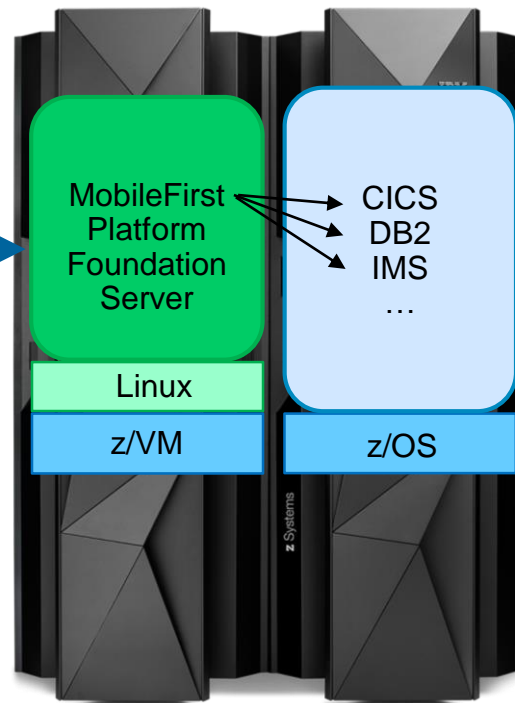

- MobileFirst Platform Foundation Studio includes tools for mobile application development, with programming models and web support
- Fully integrated into the RDz Eclipse-based platform



# DEMO: Use MobileFirst Platform Studio to mobile-enable a COBOL application

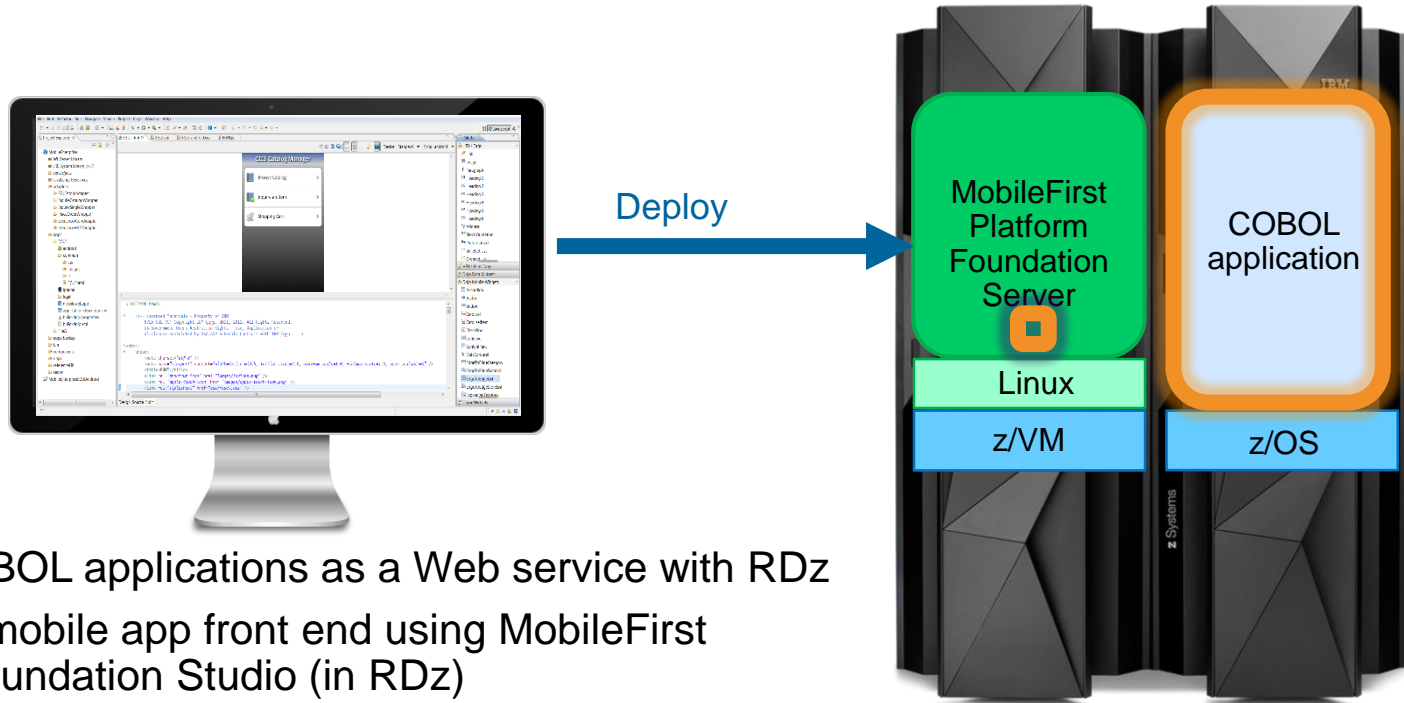

1. Enable COBOL applications as a Web service with RDz
2. Develop a mobile app front end using MobileFirst Platform Foundation Studio (in RDz)
3. Deploy it to the MobileFirst Platform Foundation Server
4. Test with the Mobile Browser Simulator

# Business applications also connect to MobileFirst through a centralized brokerage service

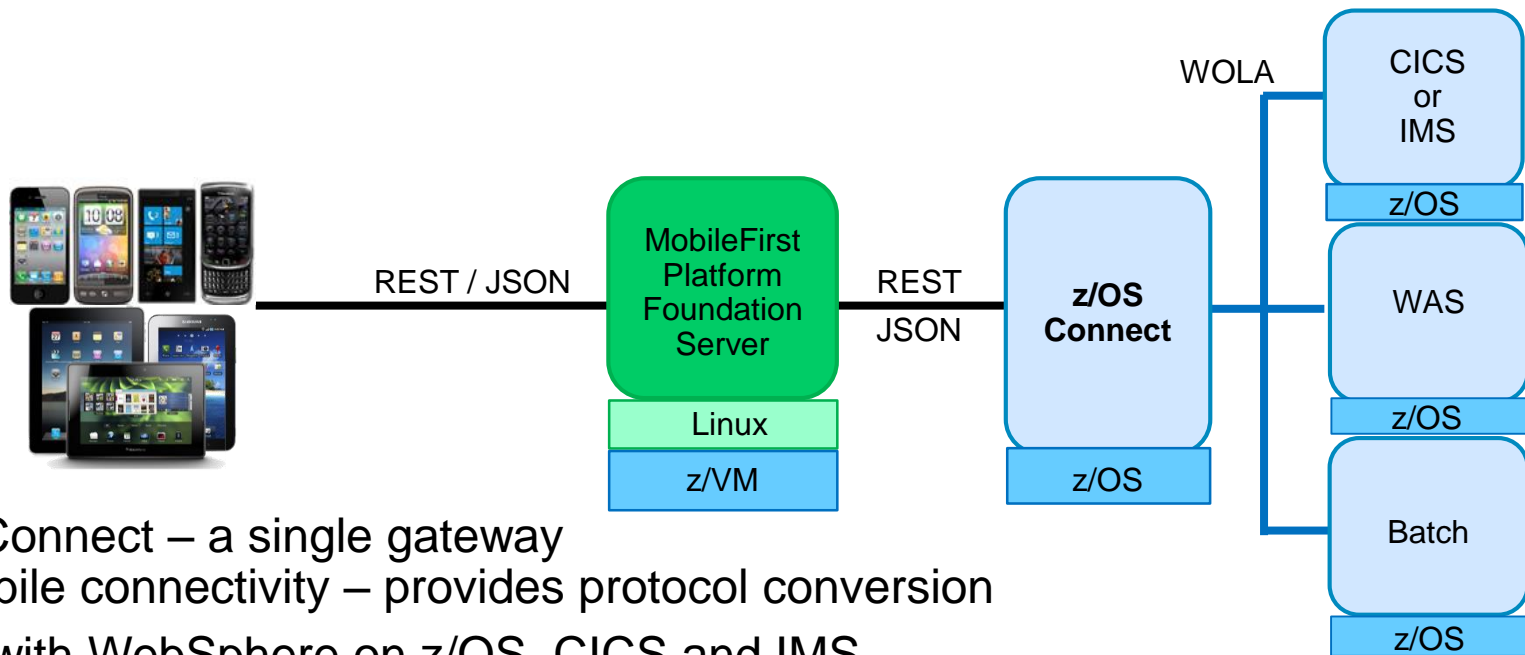

- z/OS Connect – a single gateway for mobile connectivity – provides protocol conversion
- Ships with WebSphere on z/OS, CICS and IMS – at no additional charge
- Integrated into z/OS services (e.g., WLM, SMF, etc.)

# Interceptors enhance and protect access to business applications

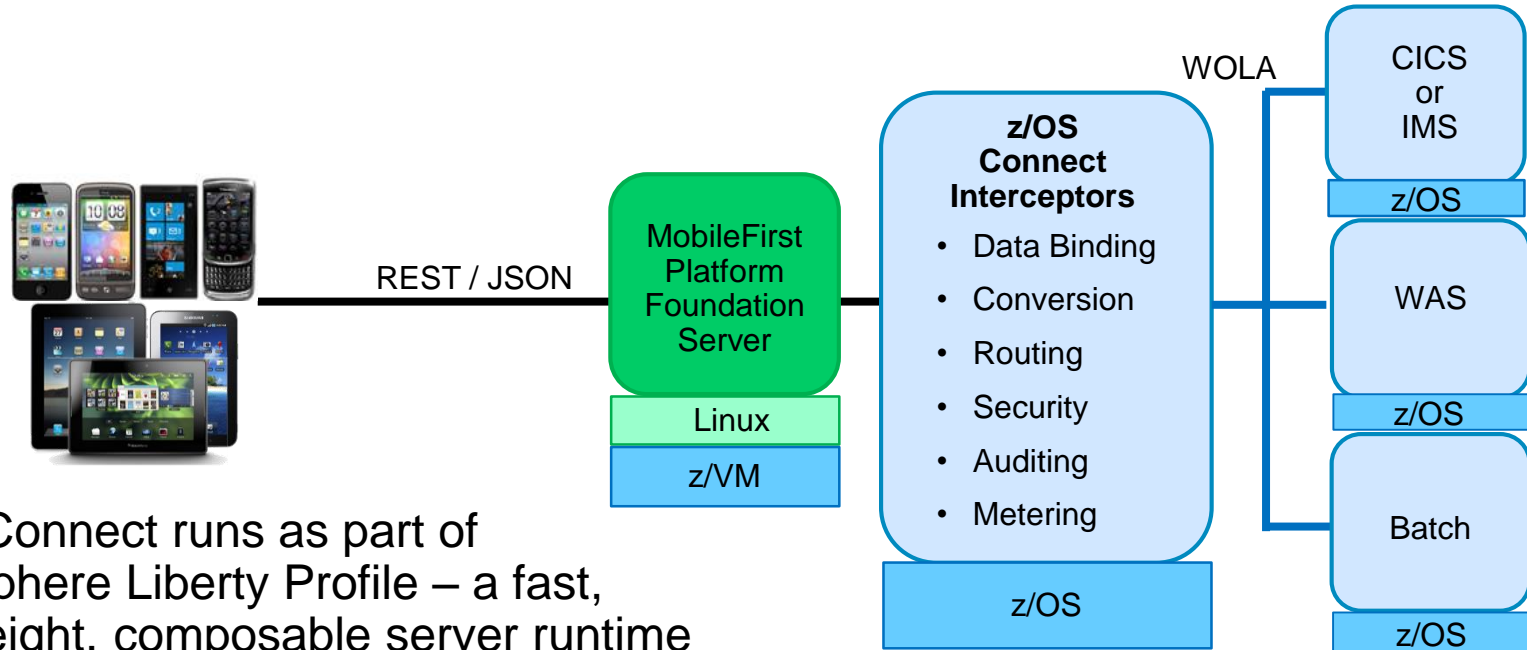

- z/OS Connect runs as part of WebSphere Liberty Profile – a fast, lightweight, composable server runtime
- Low cost option – Java-based, runs on zIIPs
- Also includes additional logging, security and metering services, plus an API

# IBM MobileFirst embodies a superior System of Engagement for mobile computing on z Systems

## IBM MobileFirst –

A foundation for exceptional mobile experiences with z Systems

Highest performance

Complete integration

Ultimate security

Low cost

**MobileFirst and z Systems have end-to-end, strong, coordinated security**

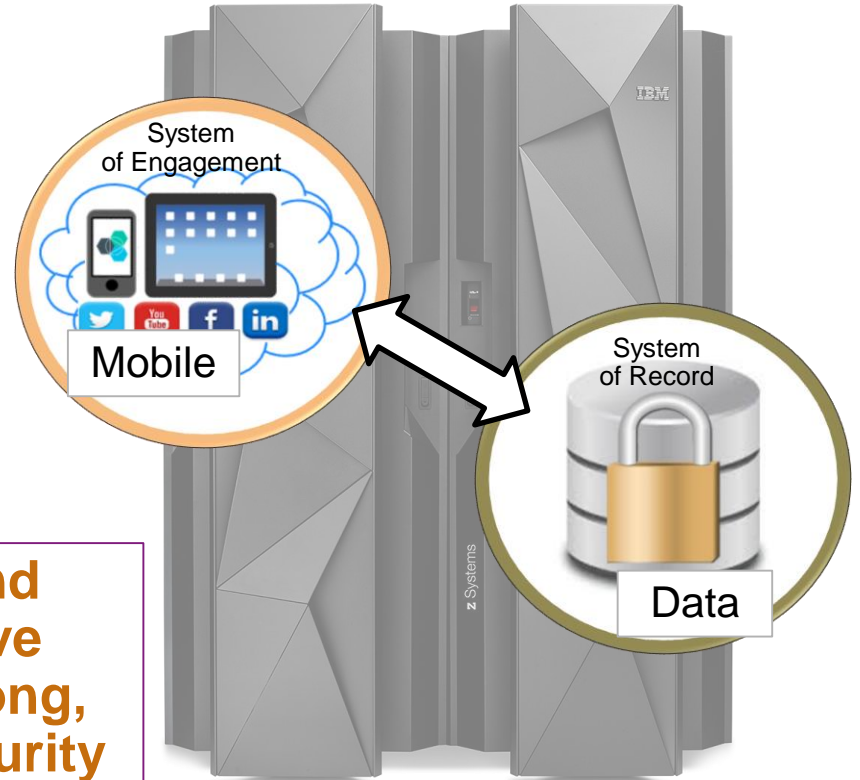

# Failure to secure Mobile apps can cost millions and damage business credibility

Mobile malware grew

**155%**  in 2011

**614%** 

from March 2012 to March 2013



**73%** of all malware exploit holes in mobile payments by sending fraudulent premium SMS messages, each generating around **\$10 USD** in immediate profit



Android is responsible for **92%** of all known mobile malware. An increase from **47%** in 2012...

...a significant threat given more than

**1 BILLION**

Android-based smart phones are estimated to be shipped in 2017\*



There are more than **500** third-party app stores containing malicious apps



**77%** of Android threats could be largely eliminated today if all Android devices had the latest OS. Currently only **4%** do

# A comprehensive security stack protects the device, content, app and transaction

## The IBM MobileFirst security stack

- IBM provides best of breed security layering on top of IBM enterprise hardware and software security
- iOS and Android 5 are examples of a secure mobile OS when not jail-broken or rooted

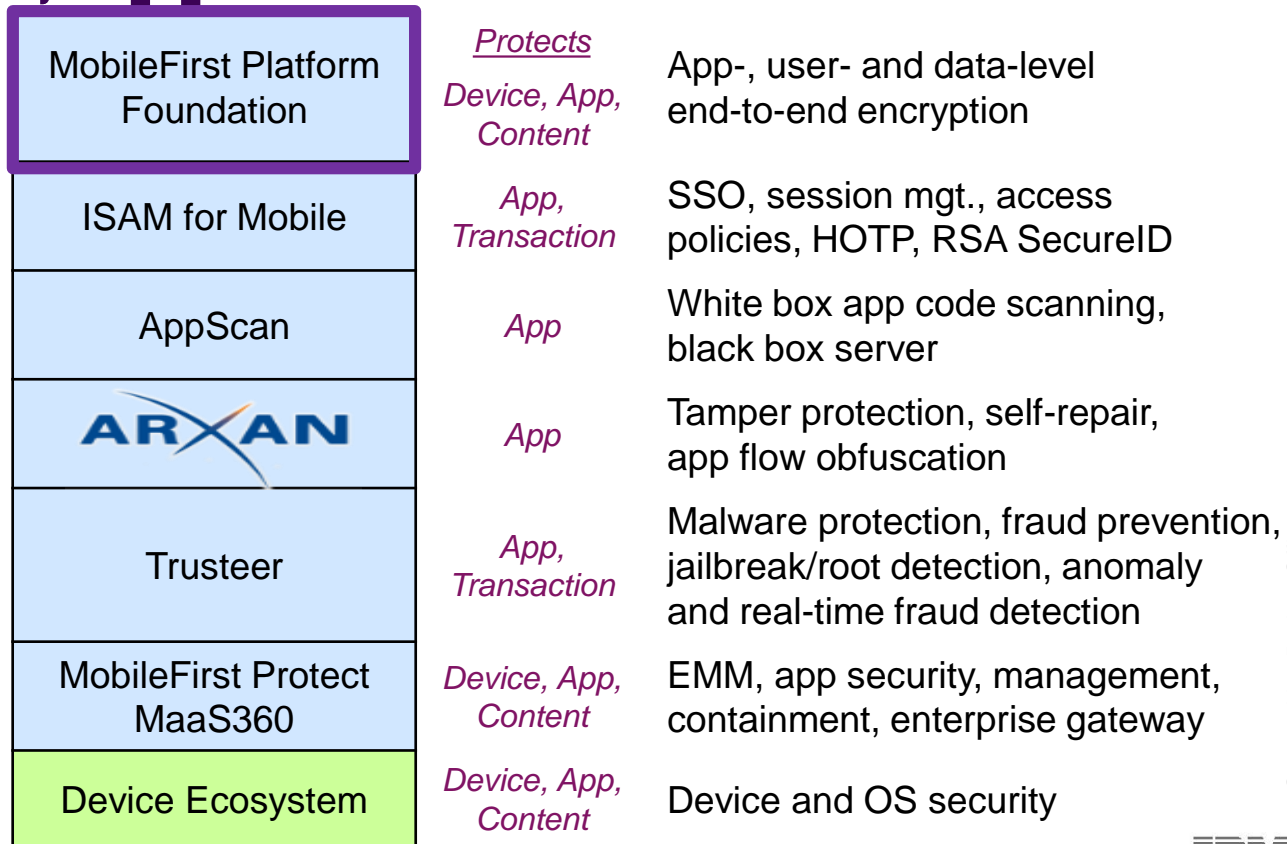

# Use the MobileFirst Platform Foundation to address enterprise security requirements

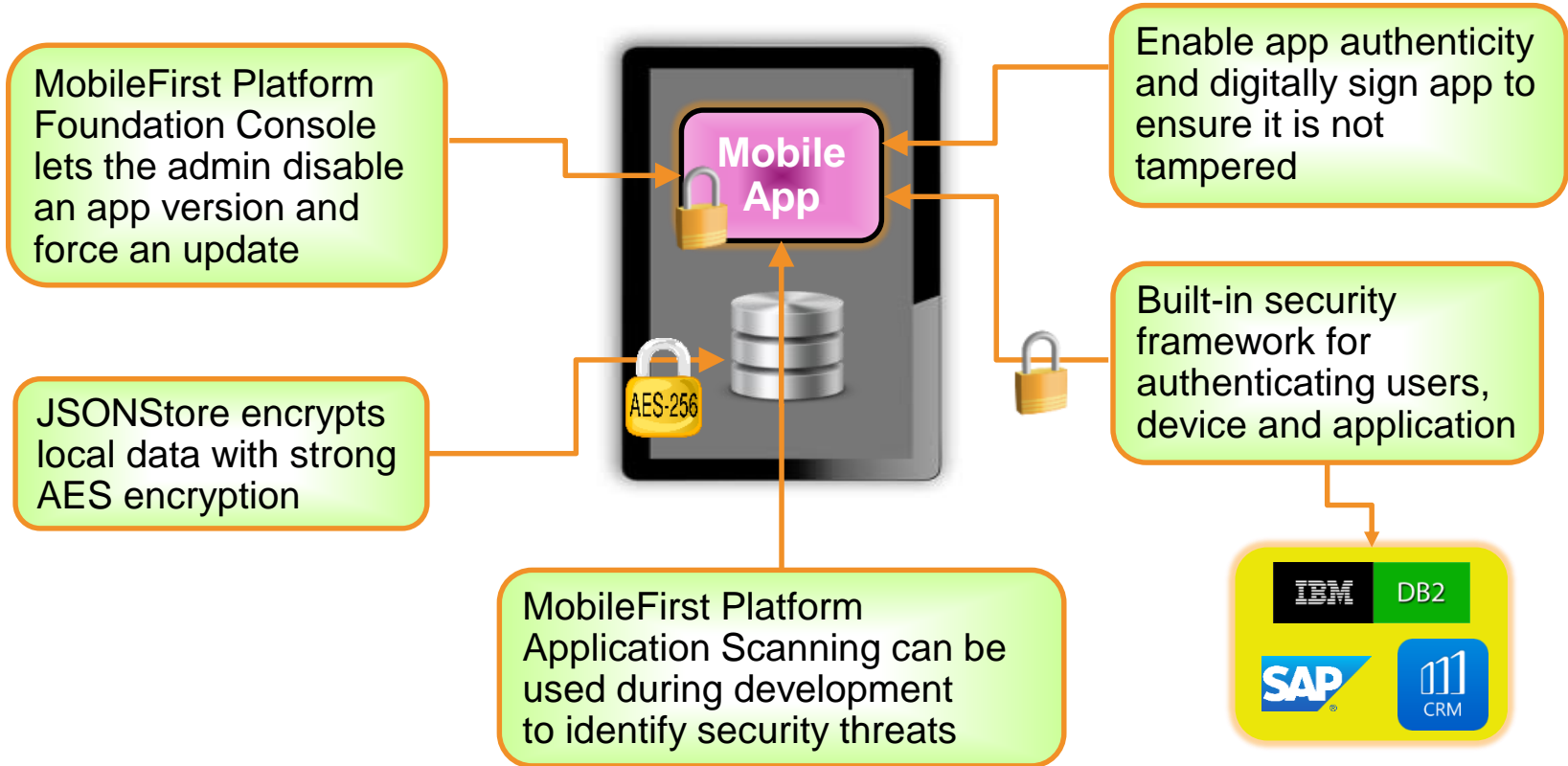

# QRadar adds actionable and comprehensive security intelligence across the entire data center

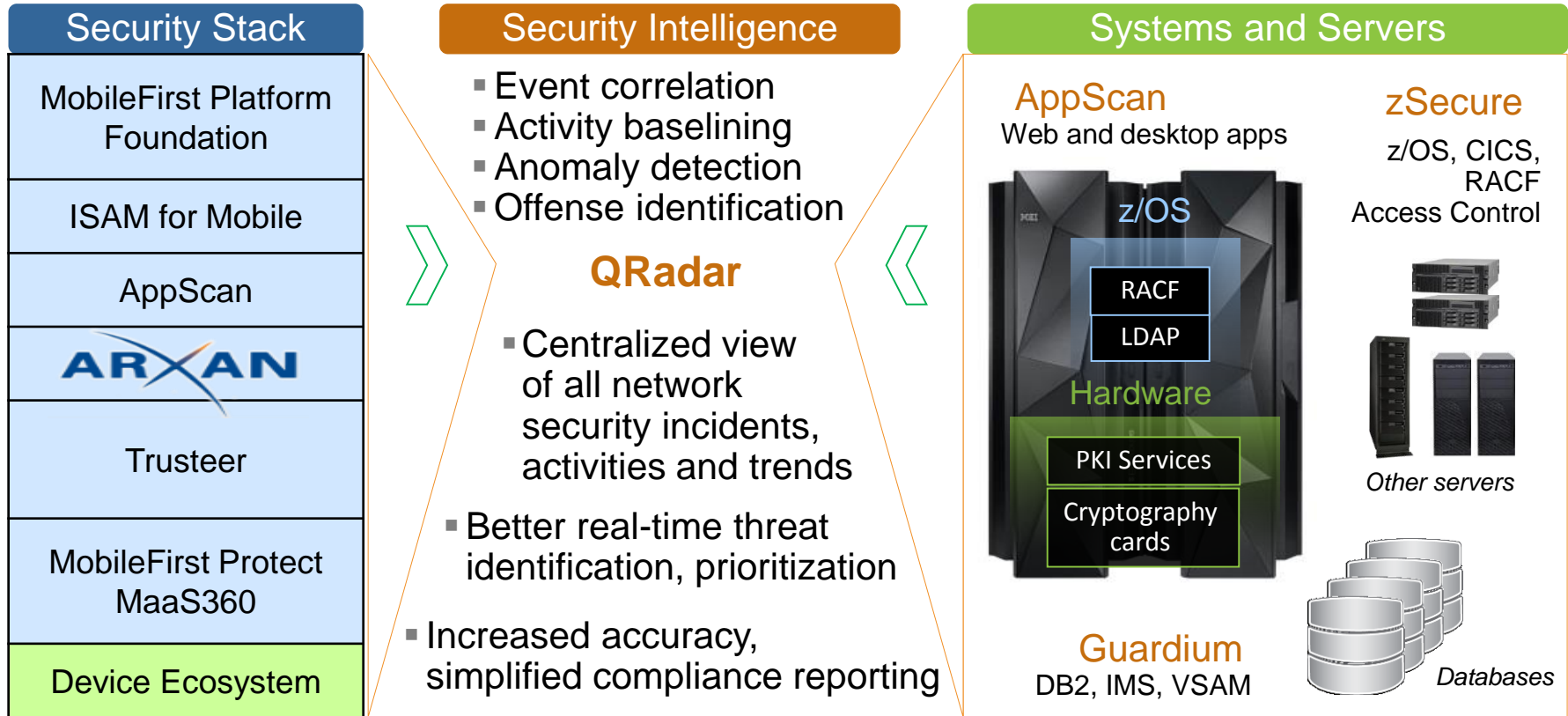



# IBM MobileFirst embodies a superior System of Engagement for mobile computing on z Systems

## IBM MobileFirst –

A foundation for exceptional mobile experiences with z Systems

Highest performance

Complete integration

Ultimate security

Low cost

**The cost impact of increased transaction rates from mobile activity is greatly reduced with Mobile Workload Pricing**

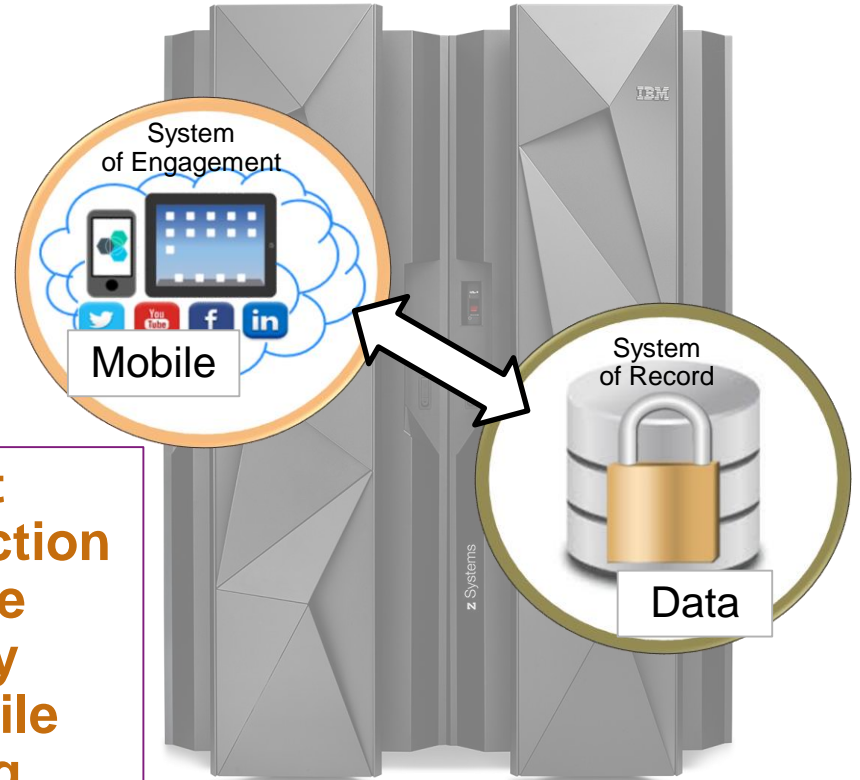

# Mobile Workload Pricing helps alleviate spikes caused by increased mobile usage...

*...and lowers costs!*

① Measure LPAR peak with standard methodology

1,500 MSUs



② Measure CICS usage in new IBM reporting tool

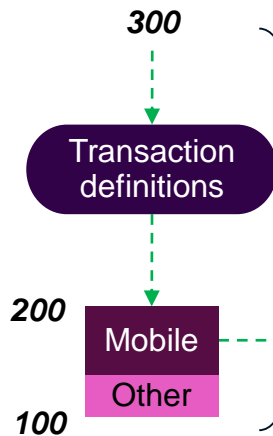

③ Capture CICS transaction details and filter by transaction type, mobile or not

④ Subtract 60% of mobile usage:  $-60\% * 200$

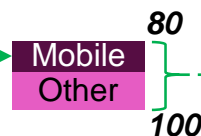

⑤ Adjust LPAR peak with new reporting tool

1,380 MSUs



⑥

Adjusted LPAR peak for month → Pricing & billing BAU based on peak

# Co-locating data and transactions with mobile front-end is more cost-effective than offloading

Blended mobile workload



- 500 concurrent connections
- 70% run 1 read/session; 25% run 4 reads/ session; 5% run 20 reads/session with 100ms think time
- 1 second cache invalidation (WXS scenario)

Mobile read-only workload driving minimum throughput of 6,300 transactions per second and response time of 12ms

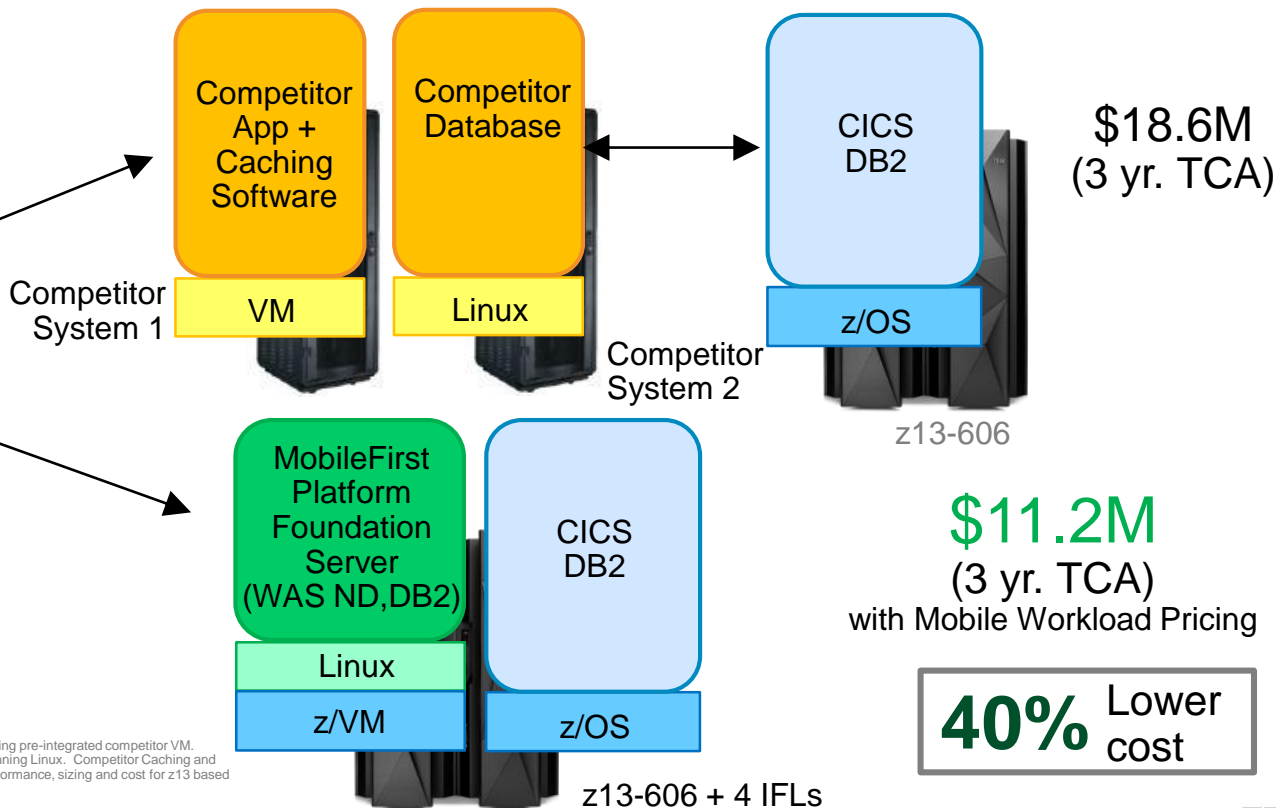

**40%** Lower cost

Competitor system 1= Pre-integrated Competitor Eighth Unit with 30 cores pro-rated, running pre-integrated competitor VM. Competitor system 2 = Pre-integrated Competitor Eighth Unit with 24 cores pro-rated, running Linux. Competitor Caching and Database sizing estimated from WebSphere Extreme Scale Caching Test. Estimated performance, sizing and cost for z13 based on tests conducted on zEC12.  
 \* 3 yr. TCA (Prod + Dev/QA + DR)

# z13 provides the capacity, security and reliability to meet the challenges of mobile computing

## **Increased performance and capacity**

*Improves ability to handle workload spikes*

## **SMT technology**

*Improves response time and throughput of transactional workloads*

## **10 TB Memory & Faster I/O**

*Means faster transaction response times*

## **Increase in # of LPARs**

*Balances growth, improves TCO*

## **Faster Crypto**

*2x improvement in cryptography*

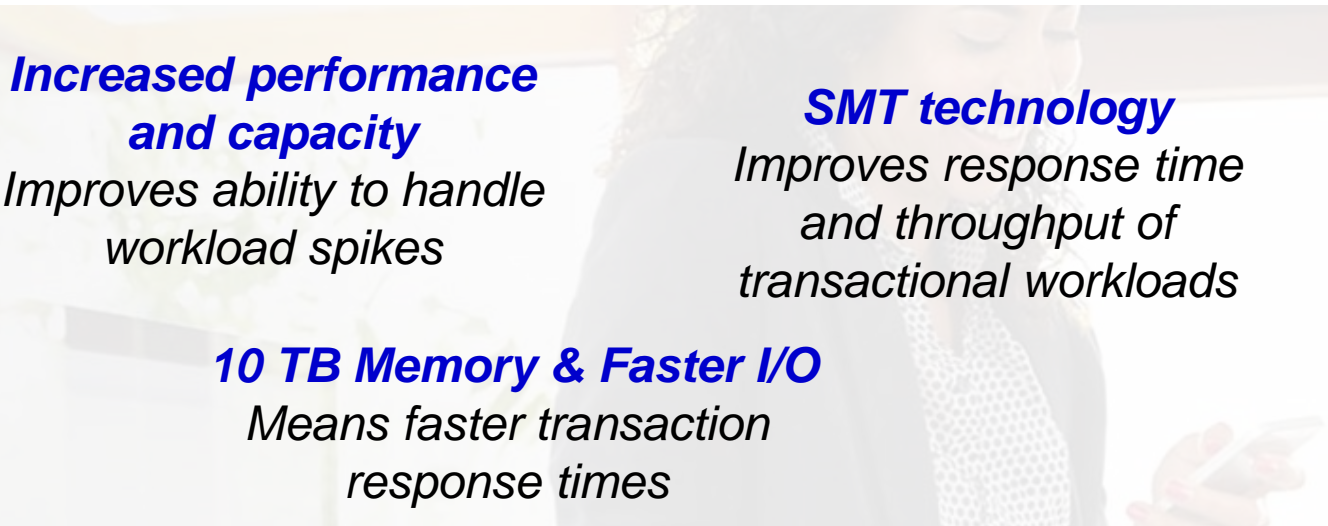

# Tesco transforms warehouse management with IBM MobileFirst Platform and z Systems

## Tesco – world's second largest retailer

- Runs a CICS-based warehouse management application
- Installed IBM MobileFirst on z Systems to enable mobile access for warehouse
- Custom-designed mobile app for Android and iOS, with re-usable adapters for integration

ROI in less than 1 month

Up to \$2M savings per year



# IBM MobileFirst embodies a superior System of Engagement for mobile computing on z Systems

## IBM MobileFirst –

A foundation for exceptional mobile experiences with z Systems

**141** Cores Per z13 server  
**111K+** MIPS

**1.2M**  
CICS tps  
*every day*

**17%** Lower cost per tps when  
MobileFirst runs on Linux on z

**60%** Reduction in costs with  
Mobile Workload Pricing

