



IBM zEnterprise Technology Summit

The New zEnterprise –
A Cost-Busting Platform
World's Fastest Analytics



IBM zEnterprise EC12 Is Optimized For Analytics

- Full function analytics software
- Extreme query acceleration with IBM DB2 Analytics Accelerator
- Run analytics workloads on same platform as operational data

Grow the business

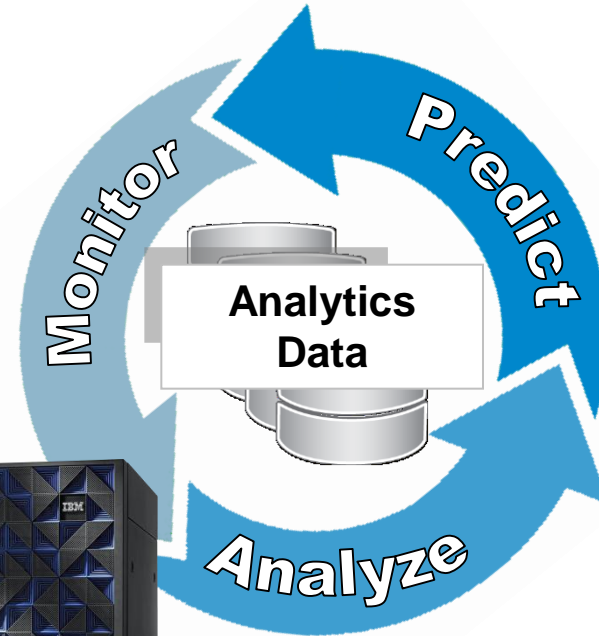

IBM zEnterprise EC12



IBM DB2 Analytics Accelerator

Getting Analytics Out To Frontline Workers Is More Critical Than Ever ...



40% decline
in homicide rates



600% increase
in cross-sell
campaign



\$13.8 Million
in cost savings

The more analytics a
business uses, the better it
performs



1000's of Reps
run their daily business using
IBM Business Analytics



80% decrease
in reporting time on top of
Oracle e-business suite

OmnicomGroup



\$200 Million
increase in cash flow

Some Customers Choose A “Mainframe Quarantine” Strategy To Support Analytics

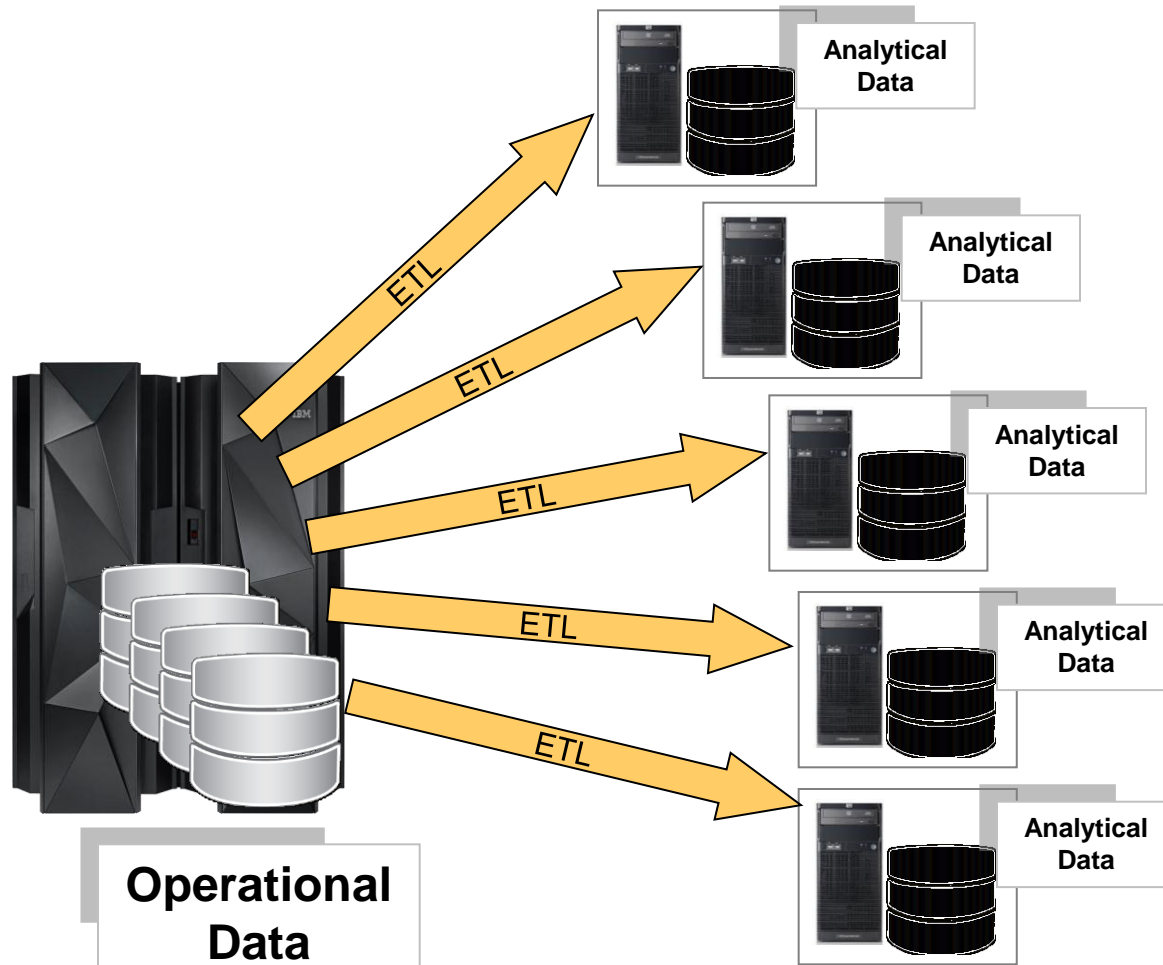

A large European bank:

- 120 database images created from bulk data transfers
- 1,000 applications on 750 cores with 14,000 software titles
- ETL consuming 28% of total distributed cores and **16% of total MIPS**

A large Asian bank:

- One mainframe devoted exclusively to bulk data transfers
- ETL consuming 8% of total distributed core and **18% of total MIPS**

With this strategy, IT costs were growing faster than the business growth

The Solution – Add Analytics Workloads Closer To The Data

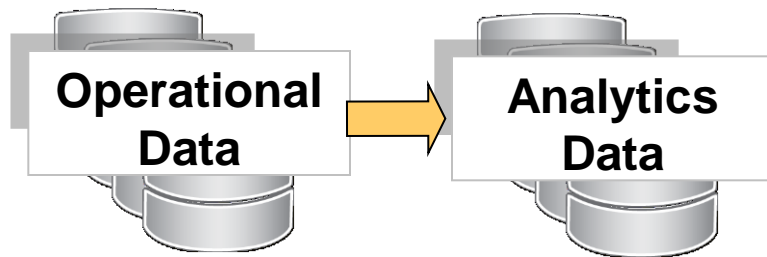

- Run analytics workloads on DB2 for z/OS in a separate LPAR
- Option to use IBM DB2 Analytics Accelerator
- Reduce data transfer costs
- Achieve lowest cost for analytic workload



zEnterprise EC12



IBM DB2 Analytics Accelerator

Run A Complete Portfolio Of Analytics Software On IBM zEnterprise EC12

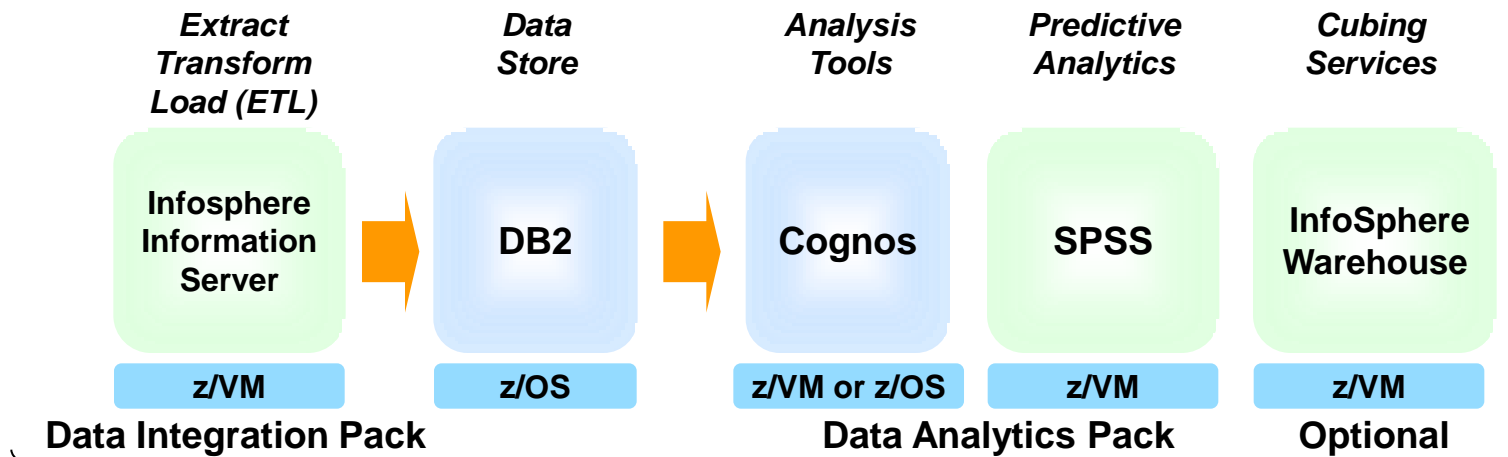

IBM zEnterprise Analytics System –

A comprehensive packaged solution including hardware, OS, and business analytics software

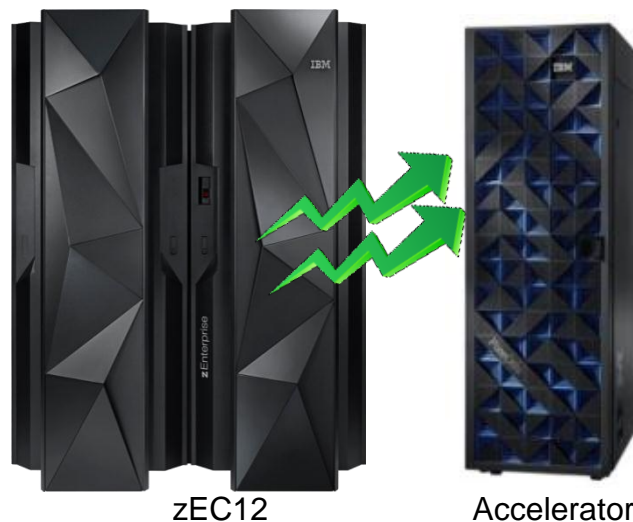

FastStart Services Pack

02. World's Fastest Analytics

DB2 For z/OS Is A First Class Platform For Operational Analytics

Business Analytics
Deep Analytics Operational Analytics



Many concurrent queries of varying complexity,

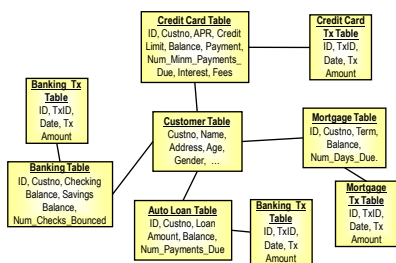

- DB2 Cost Based Optimizer provides best access path and query execution plan
- Parallel sysplex yields near-linear scaling and high availability
- z/OS Workload Management optimizes resource sharing to minimize impact on high priority transactional workloads

Customer Performance Study Proves DB2 For z/OS Operational Analytics Beats The Competition

1.2X More
Simple Queries

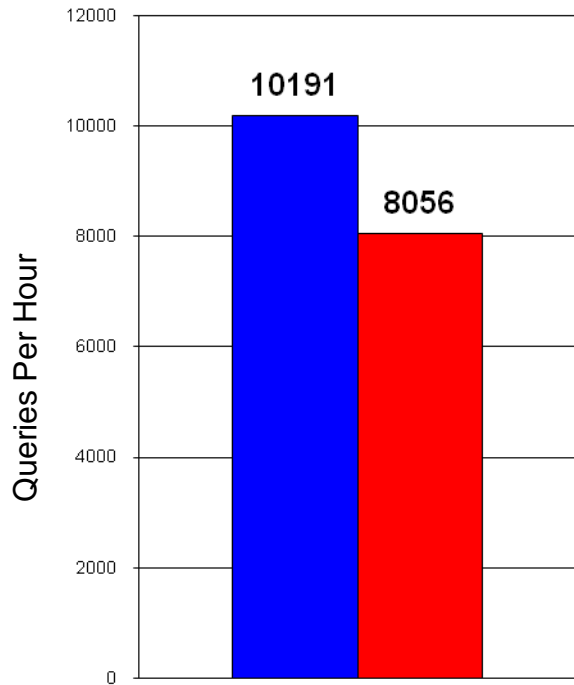

■ DB2 10 for z/OS
■ Pre-Integrated DB Competitor V2

Queries Per Hour
at 750GB data size
(Higher is Better)

3.2X More
Intermediate Queries

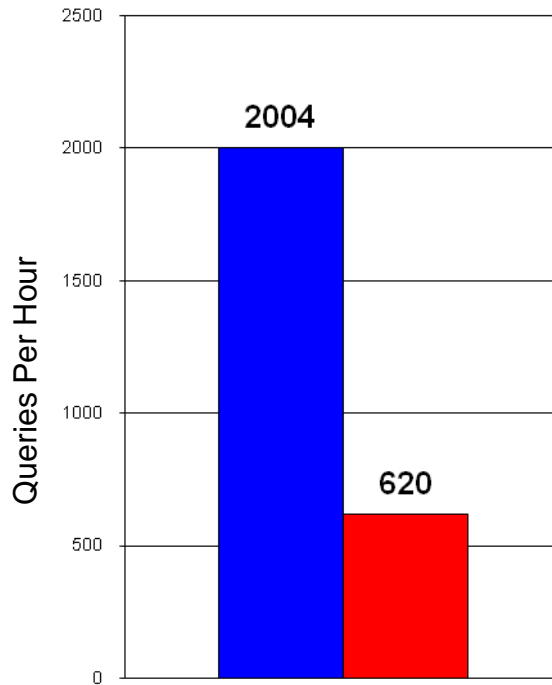

■ DB2 10 for z/OS
■ Pre-Integrated DB Competitor V2

Queries Per Hour
at 750GB data size
(Higher is Better)

1.1X More
Complex Queries

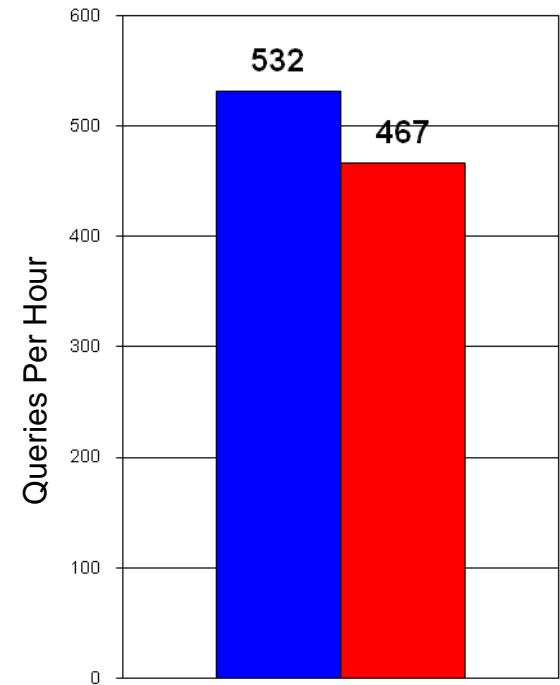

■ DB2 10 for z/OS
■ Pre-Integrated DB Competitor V2

Queries Per Hour
at 750GB data size
(Higher is Better)

DB2 For z/OS Is Also Optimized For Deep Analytics

Business Analytics Deep Analytics Operational Analytics



Intermediate and Complex analytical queries

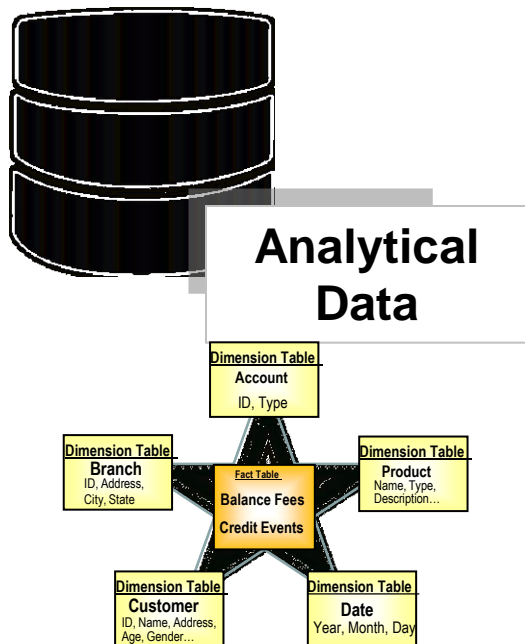

- Data is partitioned to increase parallelism and compressed to increase I/O performance
- DB2 Cost Based Optimizer decides best execution plan for each query
 - ▶ Complex queries may be decomposed into parallel operations
 - ▶ Queries may be automatically rewritten to take advantage of pre-computed partial results in materialized query tables (MQT)
- Optional IBM Data Analytics Accelerator

Add IBM DB2 Analytics Accelerator To Speed Up Deep Analytics Queries

- A workload-optimized, blade-based appliance based on Netezza Technology that runs queries in seconds versus hours
 - ▶ Storage integrated into the hardware rack
 - ▶ Eliminate table indexing and query tuning
- Integrated with DB2 for z/OS, and transparent to applications
 - ▶ Pre-load data from DB2 for z/OS into Accelerator at over 400GB/hr
 - ▶ Maintain a single copy of table or partition in Accelerator and update incrementally (High Performance Storage Saver)
 - ▶ System z workload management implemented across Accelerator
- Significantly speeds up the response time
- Drives down the costs of data warehousing and business analytics

***Breakthrough technology
enabling new opportunities***



New V3.1!

Analytics Accelerator Leverages Massively Parallel Processing To Speed Up Deep Analytics Queries

Data partitioned across CPUs and storage

Query distributed to CPU/FPGAs which decompress and filter data in real-time.

SMP Host assembles results and returns



Storage

SMP Hosts

CPU
Field Programmable Gate
Array

"...when something took 24 hours I could only do so much with it, but when something takes 10 seconds, I may be able to completely rethink the business..." SVP, Nielsen

Key Reason For World's Fastest Analytics – Field Programmable Gate Arrays

```
select DISTRICT,
       PRODUCTGRP,
       sum(REVENUE)
from   SALES_DATA
where  MONTH = '20091201'
and    MARKET = 509123
and    SPECIALTY = 'DAIRY'
```

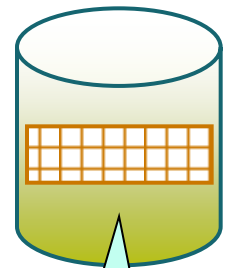

Slice of table
SALES_DATA
(compressed)

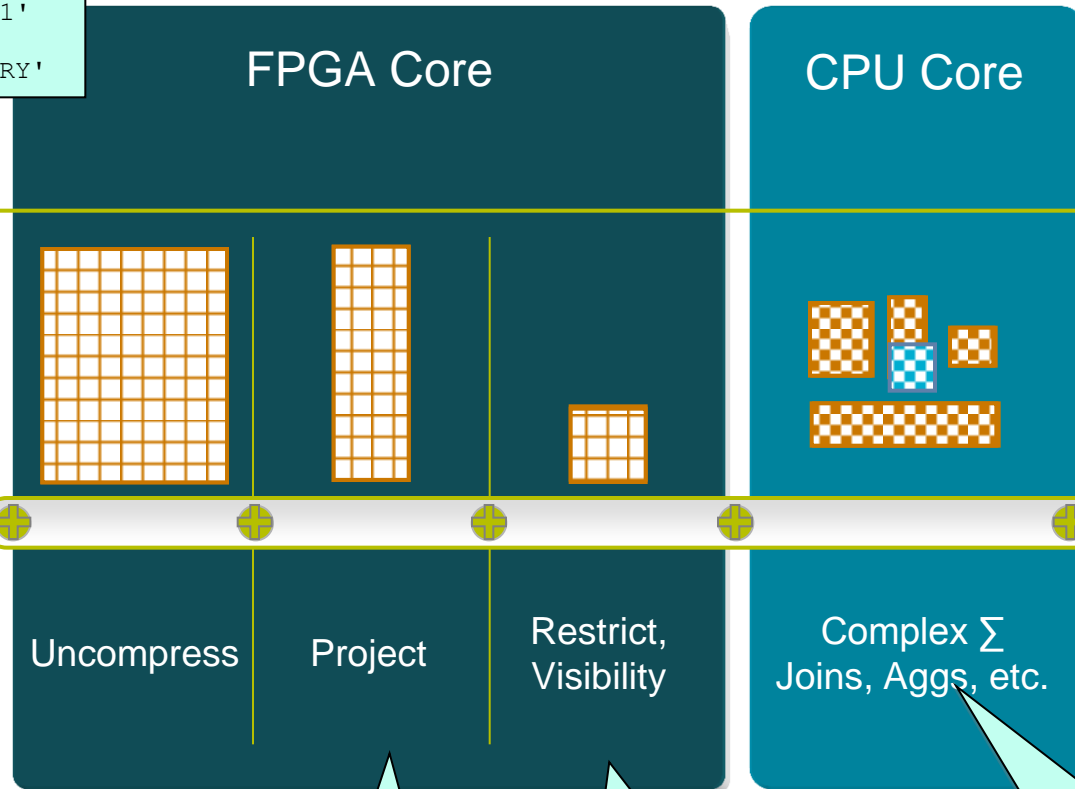

```
select DISTRICT,
       PRODUCTGRP,
       sum(REVENUE)
```

```
where MONTH = '20091201'
and    MARKET = 509123
and    SPECIALTY = 'DAIRY'
```

sum (REVENUE)

Analytics Accelerator Speeds Up Complex Queries

Query	DB2 (Secs)	DB2 + Analytics Accelerator (Secs)	Speed Up	Rows Reviewed	Rows Returned
Query 1	9,540	5	1,908x	2,813,571	853,320
Query 2	8,220	5	1,644x	2,813,571	585,780
Query 3	4,560	6	760x	8,260,214	274
Query 4	4,080	5	816x	2,813,571	601,197
Query 5	4,080	70	58x	3,422,765	508
Query 6	3,180	6	530x	4,290,648	165
Query 7	3,120	4	780x	361,521	58,236
Query 8	2,640	2	1,320x	342,529	724
Query 9	2,520	193	13x	4,130,107	137



N1001-10

“We had this up and running in days with queries that ran over 1000 times faster”, AETNA

“We expect ROI in less than 4 months”, Swiss Re

**Now with
“trickle” feed!**

Analytics Accelerator Speeds Up SAP Business Warehouse Too



- Accelerates SAP Business Warehouse on DB/2 for z/OS
- Dramatic decrease in elapsed time for SAP Business Warehouse ad-hoc reporting
- Model N1001-10

No	Description	Records read	Records returned	DB2 [sec]	IDAA [sec]	Speed Up
1	Simple mass aggregation	17116647	21	117	0.78	150
2	Query #1 + 70% filter	11980812	21	94.2	0.86	110
3	Query #1 + 30% filter	5133708	21	54.8	0.82	67
4	Query #1 + 10% filter	1710293	21	17.6	0.87	20
5	Screwed data, low filtering	10790019	21	96.8	2.47	39
6	Screwed data, high filtering	24	14	7.28	0.83	9
7	Many restrictions	3805941	21	128	7.65	17
8	Navigational attributes	823646	21	17.1	1.27	13
9	Navigational attributes + selective condition	811	21	15.8	1.17	14
10	Open value ranges	2006	21	19.6	3.52	6
11	Hierarchy	1653981	21	17.6	0.97	18
12	Hierarchy + selective condition	55068	21	38.6	0.98	39
13	Restricted key figures on 2 dimensions	1314964	1948	207	7.22	29
14	Query #14 + hierarchy	132564	1499	> 1000	1.27	> 787
15	Calculated key figures (OLAP)	5321586	10	57.8	2.37	24
16	OR linked values	6212609	13	40.5	0.92	44
17	Non uniform data distribution	11016253	13	31.2	0.99	32
18	Selective line item	1724	1706	0.71	1.17	0.6
19	Non-selective line item	115481	68619	33.8	1.36	25
20	All together	3087692	468	87.7	4.42	20

Table 2: Dedicated Query Test on a 18-million-records InfoCube

DEMO: Accelerator Outperforms Pre-Integrated Database Competitor Running Deep Analytics Queries

Same queries, same clients, same data...
Different Results

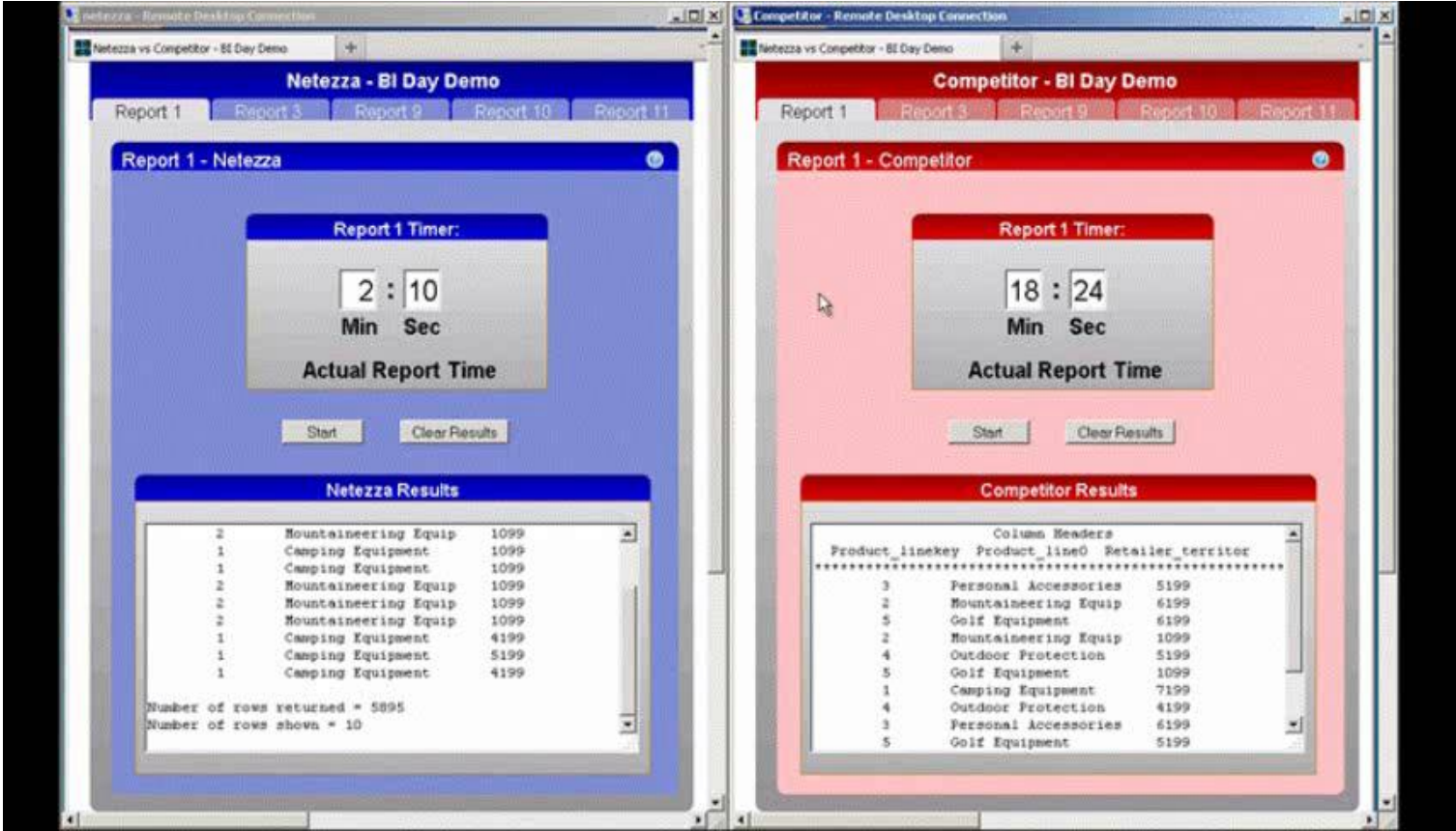

N1001-10

Pre-Integrated Database Competitor V2

See more like this on YouTube: http://www.youtube.com/watch?v=T3O6yJ_hdUU

BI Day Workload – A Typical Day's Worth Of Analytics Reports

BI Day Fixed Execution Test: Total Number of reports = 161,166

4	3	21	179	99	29,078	84,854	19,600	27,328
Complex Report 1	Complex Report 3	Intermediate Report 9	Intermediate Report 10	Intermediate Report 11	Simple Report 2	Simple Report 4	Simple Report 5	Simple Report 6

4 connections

20 connections

56 connections

- 80 concurrent connections to DB2 for z/OS
- All short running SQL queries processed by DB2 for z/OS
- Long running SQL queries directed to accelerator

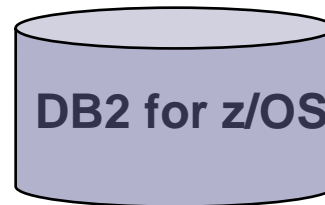

Each report executes one or more SQL queries

zEnterprise Is Optimized For Operational Analytics

**Standalone
Pre-integrated
Competitor V3
Quarter Unit**



Unit Cost (3yr TCA) \$481/RpH

Workload Time	1,318 mins
Reports per Hour (RpH)	7,337
Competitor ¼ Rack (HW+SW+Storage)	\$3,530,041

**IBM zEnterprise Analytics
System 9700**

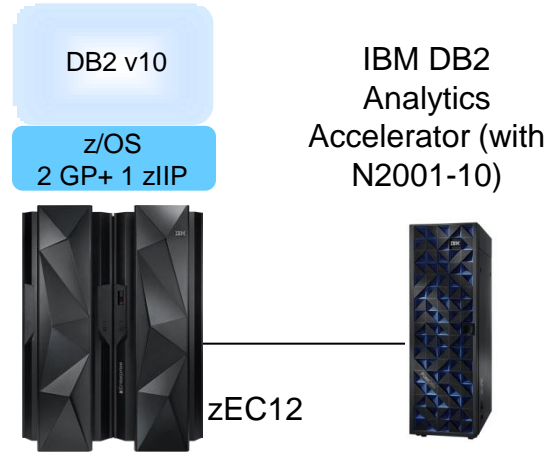

Unit Cost (3yr TCA) \$46/RpH

Workload Time	148 mins
Reports per Hour (RpH)	65,338
zEC12 (2 GP + 1 zIIP, HW+SW+ Storage) + Accelerator V3.1 with N2001-10 hardware	\$3,012,750

**9x Performance
10x Price Performance!**

Source: Customer Study on 10TB BIDAY data running 161,166 concurrent reports. Intermediate and complex reports automatically redirected to IBM DB2 Analytics Accelerator for z/OS. Results may vary based on customer workload profiles/characteristics. Note: Indicative 9700 pricing only internal to IBM, quotes to customer require a formal pricing request with configurations.

zEnterprise Is Best For Analytics

Traditional Data Warehouse Competitor



6650H

(current generation)

Unit Cost
\$330K/Queries per Hour

Workload Time*	1,591 secs
Queries per Hour	9.05
Total Cost (3 yr. TCA) - Teradata 6650H 1-Node (HW+SW+Storage)	\$2,946,046

IBM zEnterprise Analytics System 9700

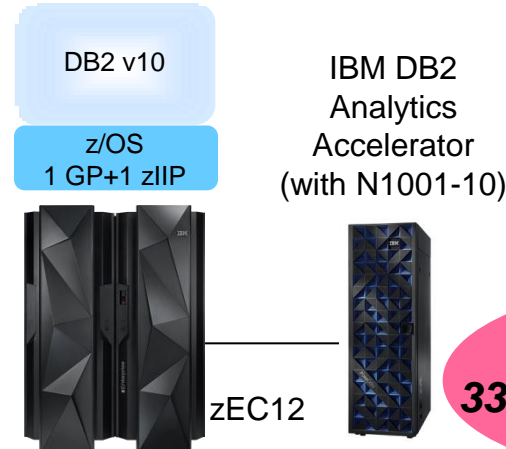

(current generation)

Unit Cost
\$10K/Queries per Hour

26x performance
33x price performance

Workload Time*	60.98 secs
Queries per Hour	236
Total Cost (3 yr. TCA) – 9700 : zEC12 (1 GP + 1 zIIP) + DB2 Analytics Accelerator (HW+SW+Storage)	\$2,337,400

Source: Customer Study running 4 complex analytical queries across a 353GB Data Mart, Total User Data shared across 8 older generation Teradata Servers was 15TB. Customer workload was not from any benchmark applications, nor are they based on any benchmark standard. As such, customer applications, differences in the stack deployed, and other systems variations or testing conditions may produce different results and may vary based on actual configuration, applications, specific queries and other variables in a production environment. List Prices used in the comparison. Teradata 6650H price available from <ftp://public.dhe.ibm.com/software/data/sw-library/infosphere/analyst-reports/ITG-ISAS-Exadata-Teradata.pdf>. The 3 year total cost of acquisition includes expected hardware, software, service & support. Prices will vary by country. Results will vary based on actual configuration, applications, specific queries, and other variables in a production environment. Users of this document should verify the applicable data for their specific environment. Contact IBM and see what we can do for you. *Throughput projected for Teradata 6650H using [TPerf data](http://www.monash.com/uploads/Teradata-Active-EDW-6660-6680.pdf) (<http://www.monash.com/uploads/Teradata-Active-EDW-6660-6680.pdf> : Rated TPerf per 6650H node 121.5) . Throughput for zEnterprise Analytics System 9700 was based on lab measurements for equivalent workload performance improvement on upgrading to DB2 10 for z/OS on zEC12

IBM Blue Insight Uses System z Platform To Deploy An Internal Private Analytics Cloud

Project Scope

- Over 200K named users, 390 distinct Cognos BI reporting projects, over 2M reports/quarter
- 250 data sources - DB2, PowerCube, XML, Power, Linux on System z, z/OS
- Savings of over 74K sqft floor space, 30K MWh energy and cut per user cost from \$250K to \$13K

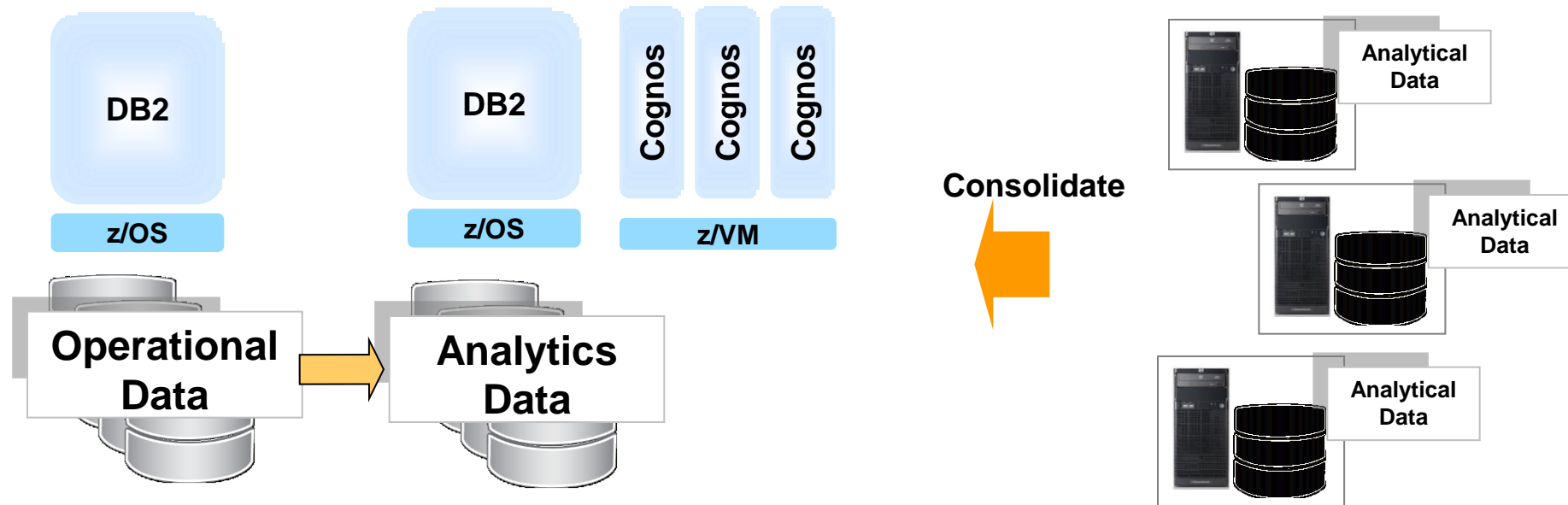

“ Our commitment to informed decision making led us to consider private **cloud delivery of Cognos via System z**, which is the enabling foundation that makes possible **+\$25M savings over 5 years.** ”

-- IBM CIO Office

Add Business Analytics Tools To Answer Key Questions That Drive A Competitive Edge

How are we doing?

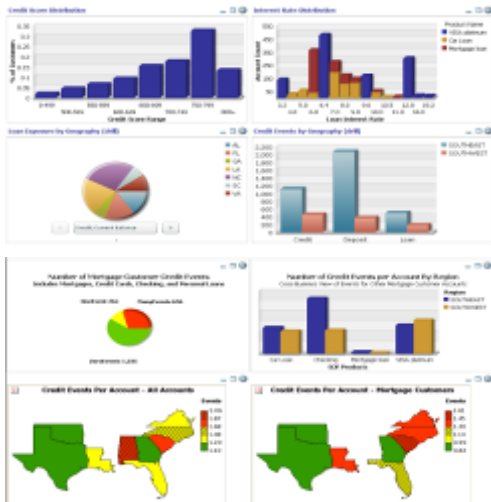

Dashboard
Operational or Strategic

Why are we on/off track?

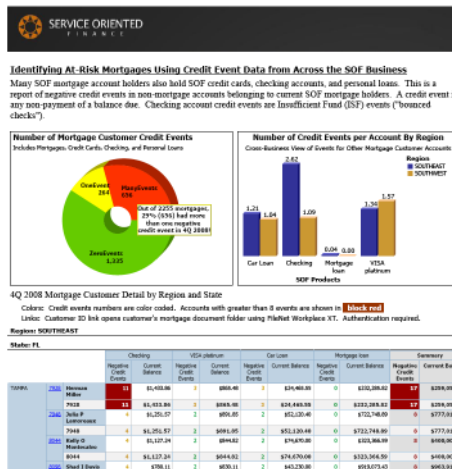

Query and Reporting
Exploratory Analysis

What should we do next?

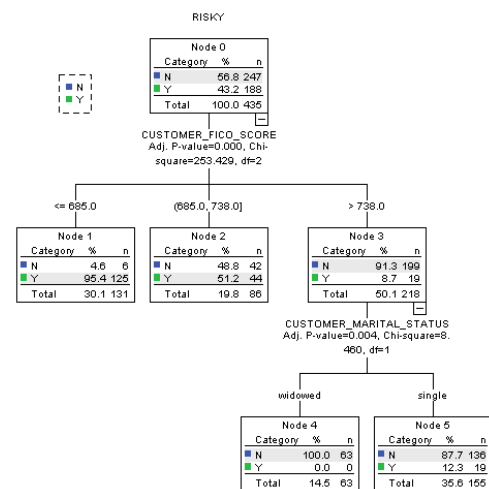

Analytics Statistics
and Predictive Analytics



Business Analytics Tools Can Be Grouped Into Two Areas

Descriptive Analytics:

- Provides reports/dashboards
- Insight into what has happened
- Drill-down on data using different dimensional attributes such as by date (month, year), geography (state, county, city), demographics (age, gender, race)
- Aggregate data
- Visualize data using interactive charts, graphs, maps and other objects
- IBM Cognos Enterprise

Predictive Analytics:

- Provides scores that helps in optimized decision support
- Predicts what might happen
- Build Models using historical data
- Some models provide rules that can be integrated into business processes
- Uses mathematical algorithms that can be unsupervised (such as clustering) or supervised (such as classification)
- IBM SPSS Statistics and Modeler

Cognos Can Generate Reports And Dashboards For Operational BI And Deep Analytics Queries

■ People-centric

- ▶ Server based business analytics accessed via browser
- ▶ Consistent user interface for different analytic activities
- ▶ Reuse new intelligence assets
- ▶ Built-in collaboration and social networking
- ▶ Threaded discussions, activities, and notifications

■ Easy to deploy and manage

- ▶ Implemented in Java, runs on WebSphere
- ▶ Scales up and out across heterogeneous hardware and operating systems
- ▶ Runs on Linux on System z or z/OS

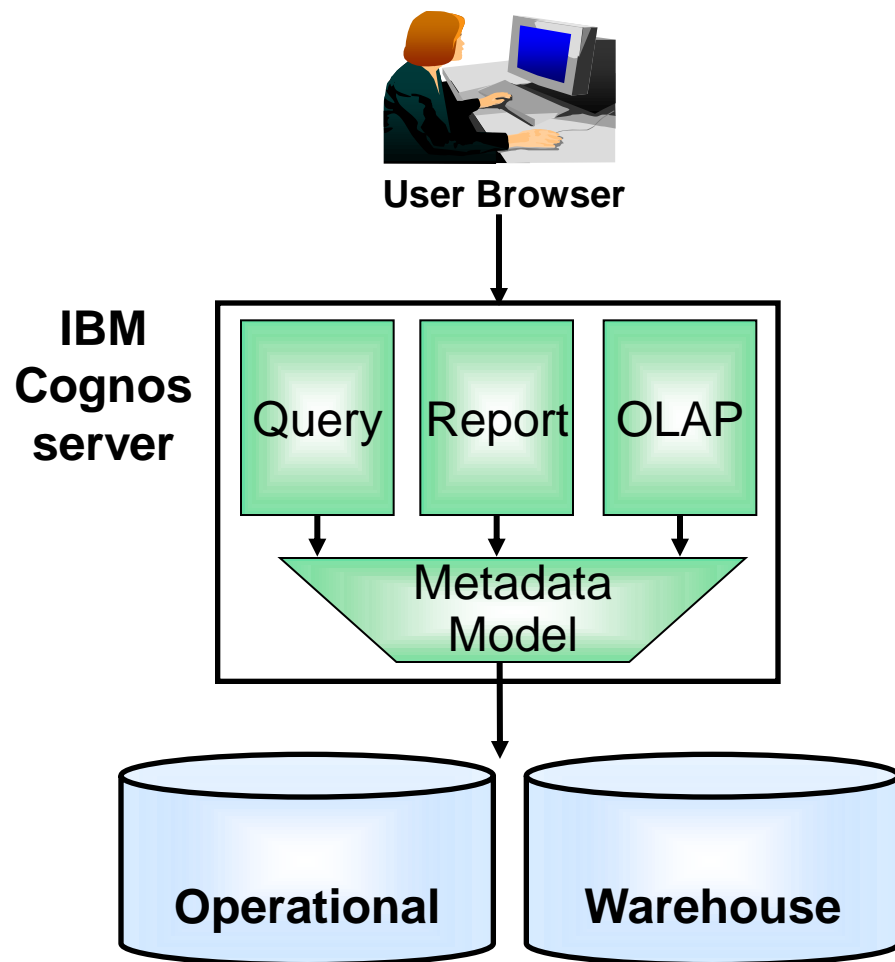

DEMO: Use Cognos To Identify New Business Insights From The Data Warehouse

1. Reviewing Mortgage data provides false impression of credit risk
2. Report looking at negative credit events (bounced checks, missed payments) of customer across all accounts (Credit Card, Checking, etc.
3. Identify high risk mortgage customers



Identifying At-Risk Mortgages Using Credit Event Data from Across the SOF Business

Many SOF mortgage account holders also hold SOF credit cards, checking accounts, and personal loans. This is a report of negative credit events in non-mortgage accounts belonging to current SOF mortgage holders. A credit event is any non-payment of a balance due. Checking account credit events are Insufficient Fund (ISF) events ("bounced checks").

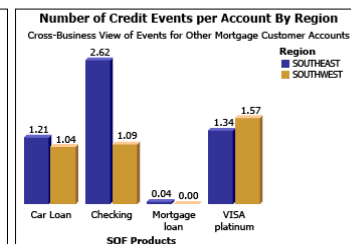
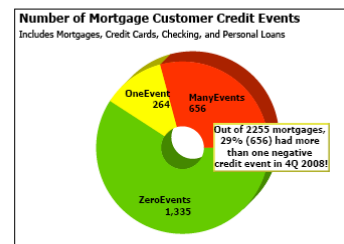

4Q 2008 Mortgage Customer Detail by Region and State

Colors: Credit events numbers are color coded. Accounts with greater than 8 events are shown in **block red**.

Links: Customer ID link opens customer's mortgage document folder using FileNet Workplace XT. Authentication required.

Region: **SOUTHEAST**

State: FL

			Checking		VISA platinum		Car Loan		Mortgage loan		Summary	
			Negative Credit Events	Current Balance	Negative Credit Events	Current Balance	Negative Credit Events	Current Balance	Negative Credit Events	Current Balance	Negative Credit Events	Current Balance
TAMPA	2326	Herman Miller	11	\$1,433.86	3	\$865.48	3	\$24,465.55	0	\$232,285.82	17	\$259,050.71
		7928	11	\$1,433.86	3	\$865.48	3	\$24,465.55	0	\$232,285.82	17	\$259,050.71
	2346	Julia P Lamoreaux	4	\$1,251.57	2	\$891.85	2	\$52,120.40	0	\$722,748.89	8	\$777,012.71
		7948	4	\$1,251.57	2	\$891.85	2	\$52,120.40	0	\$722,748.89	8	\$777,012.71
	2041	Kelly O Montcalvo	4	\$1,127.24	2	\$844.82	2	\$74,670.00	0	\$323,366.59	8	\$400,008.65
		8044	4	\$1,127.24	2	\$844.82	2	\$74,670.00	0	\$323,366.59	8	\$400,008.65
2025	Shad I Davis	4	\$780.11	2	\$830.11	2	\$43,230.00	0	\$919,073.43	8	\$963,913.65	

At risk customers are identified

Miami-Dade County Runs IBM Cognos Enterprise On Linux On System z

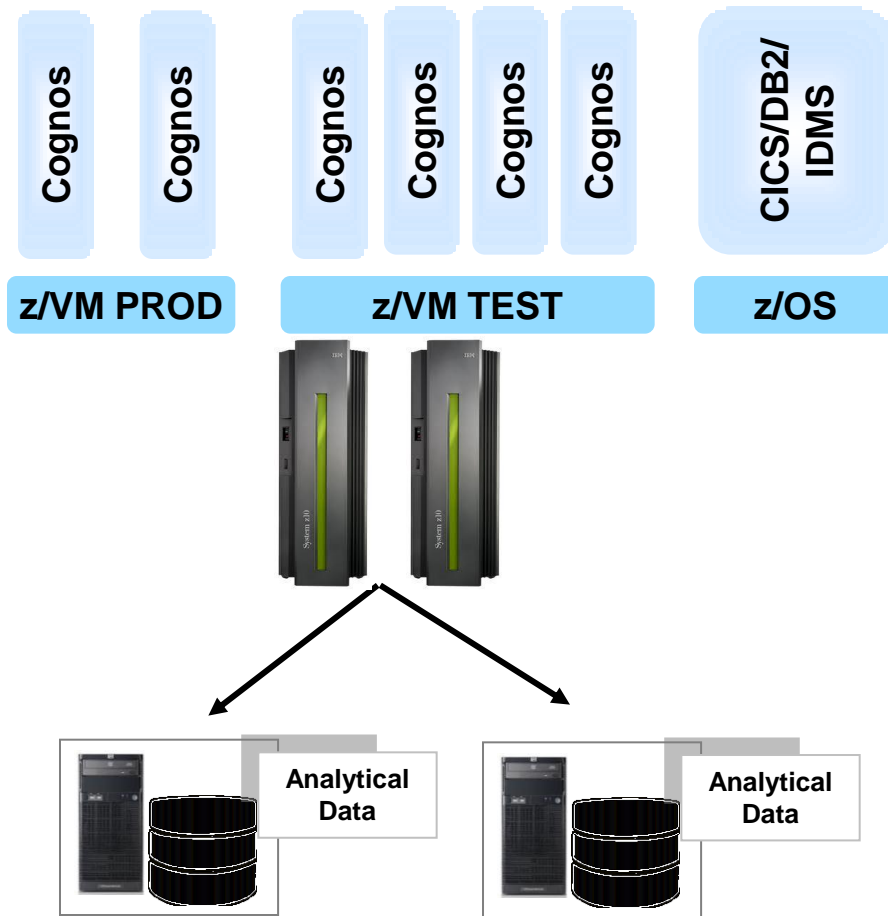

Business Benefit:

- Moved Cognos BI deployment from Intel servers to System z in 11 days
 - ▶ Consolidated multiple deployments to a single platform
 - ▶ Consolidated multiple disparate data sources
 - ▶ Single point for BI administration
 - ▶ Offer a complete disaster recovery plan
 - ▶ Additional green savings
- Easily met requirements for growth, 24x7 availability and TCO savings
- Upgrading to Cognos 10

“We are now able to expand the usage of our Business Intelligence reporting. We have users from 25 County Service departments with almost 2000 users consuming and creating reports with stable environments on System z” - Jaci Newmark, Miami-Dade County

Predictive Analytics Helps A Business Run Smarter

Turn a Call Center in a Profit Center.



A large Dutch financial services company generated **\$30 Million in incremental sales**. Essentially, 1M calls generated 180,000 suggestions, reps made 60,000 offers generating 30,000 leads and 22,000 sales.

Turn clients into advocates.



A large Swiss telco provider adopted a client retention approach based on satisfaction. And **reduced churn from 14% to 2%**.

Prevent crime before it happens.



A large city in the US optimized deployment of police resources, **reducing homicides by 35%** year over year, and robberies by 20%.

Reduce the cost of claims.



A large US insurer maximized and accelerated the collections process achieving an **ROI of 403% with payback in 3 months**.

SPSS Enables Customers To Predict Future Events And Drive Better Business Outcomes

SPSS Statistics for Linux on System z

- Version: Statistics v20
- Apply math to decision making and research for commercial, government, and academic users

SPSS Modeler for Linux on System z

- Version: Modeler v15
- Data mining tool used for generating hypotheses and scoring
- Text analysis for unstructured data to model consumer behavior
- **In-Transaction Scoring with DB2 z/OS**

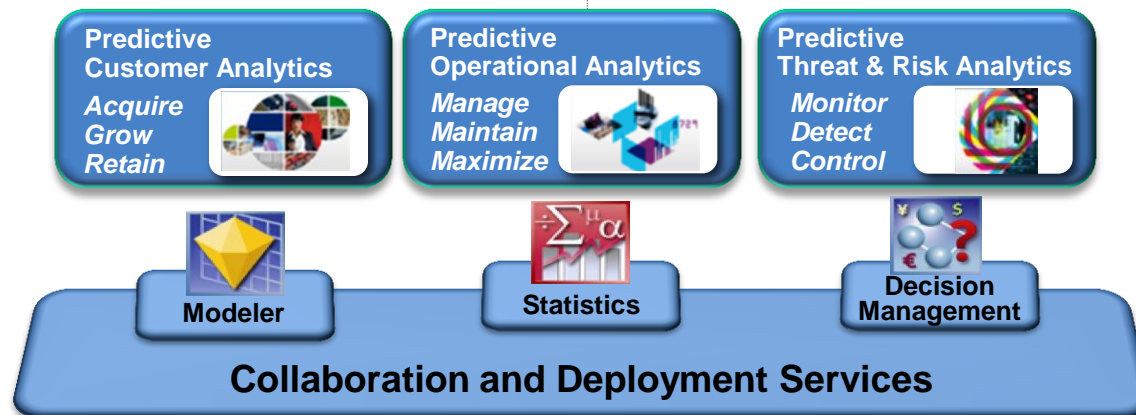

What Can We Learn From Historical Data That Would Help Evaluate New Customers

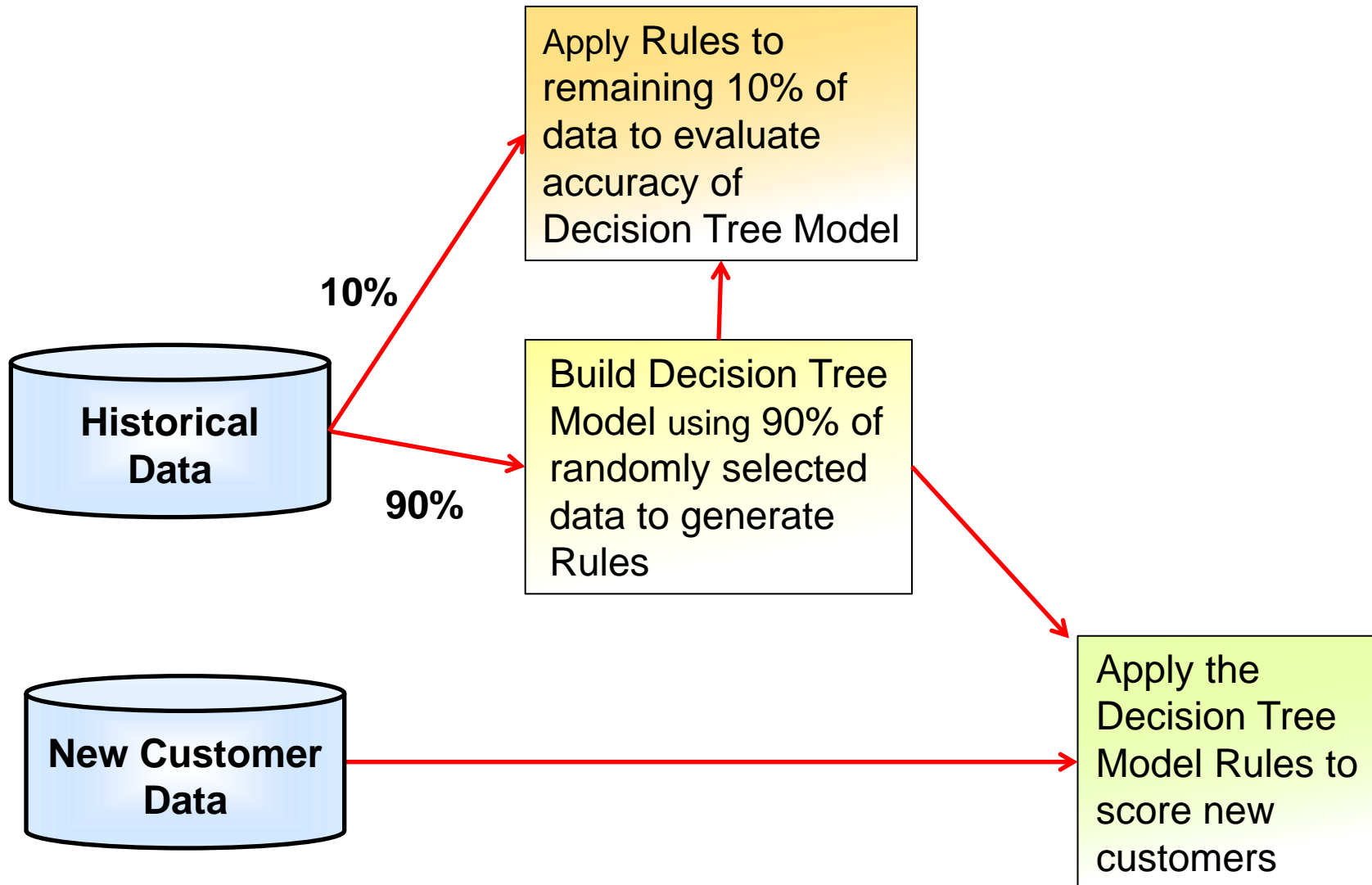

Example: Create A Model For Identifying Risky Customers For Loan Approval

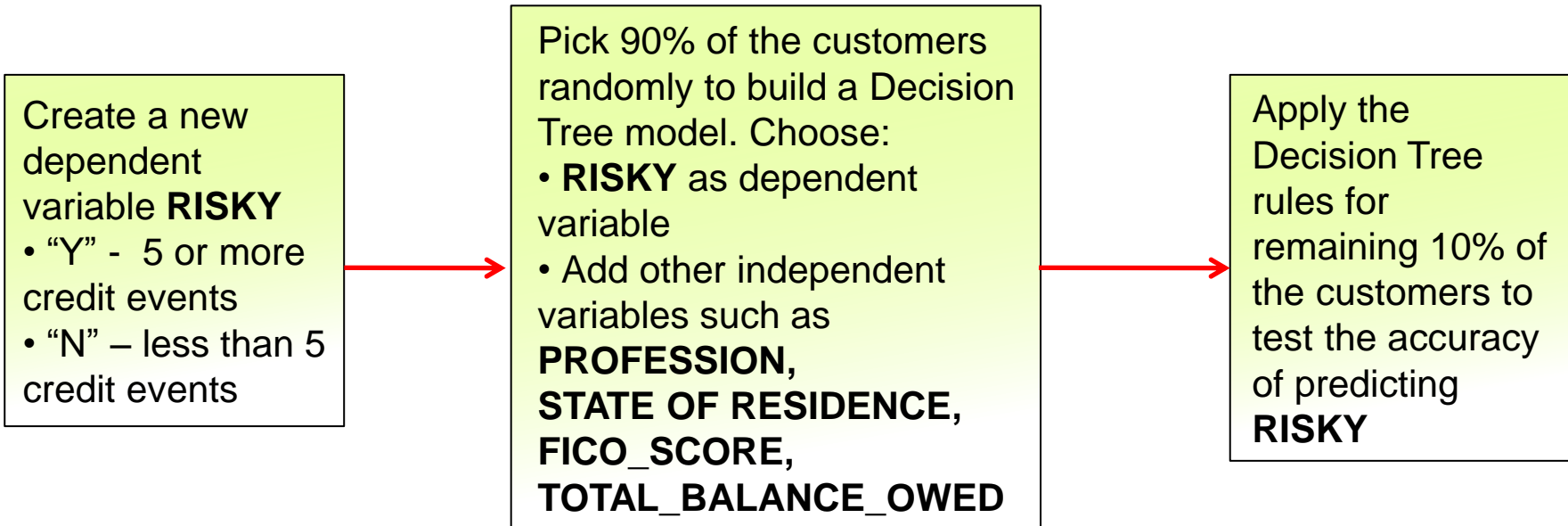

DEMO: Discover Rules For Identifying Risky Customers Using SPSS Statistics

1. Load data from Data Warehouse on DB2 for z/OS into SPSS Statistics
2. Pre-process the data to create new attributes for quantifying negative credit events across different product lines and create a risk flag for mortgage
3. Run Decision Tree to discover rules for characterizing risky customers
4. Evaluate if Herman Miller is classified as “RISKY” by applying the Decision Tree rules

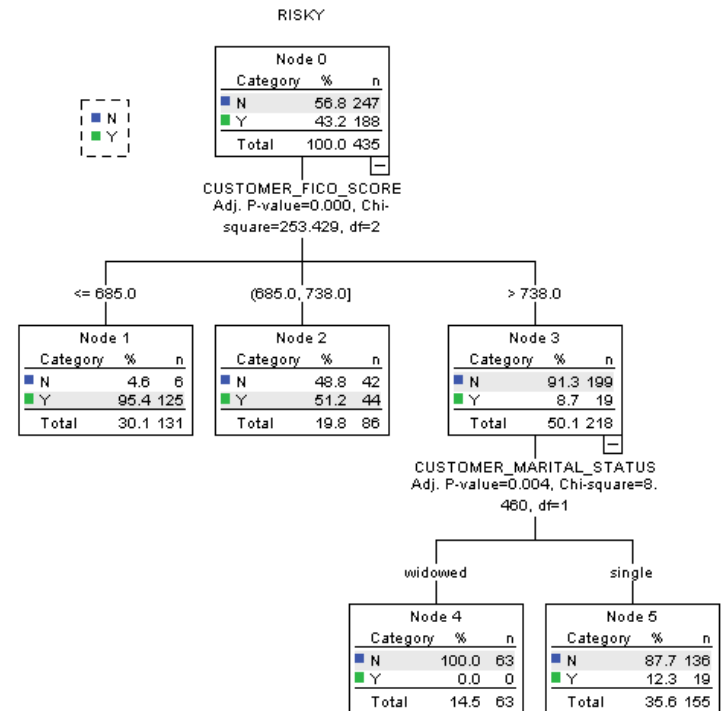

- Credit Limits identified for characterizing risky customers
- Use these credit limits for automated loan approval process

Improve Business Outcomes With SPSS Modeler In-Transaction Scoring

- Instantaneous and accurate decision based on real-time information or events
- Reduce risk by putting high risk customers on “watch”
- Increase satisfaction of valued customers by providing the “next-best offer”

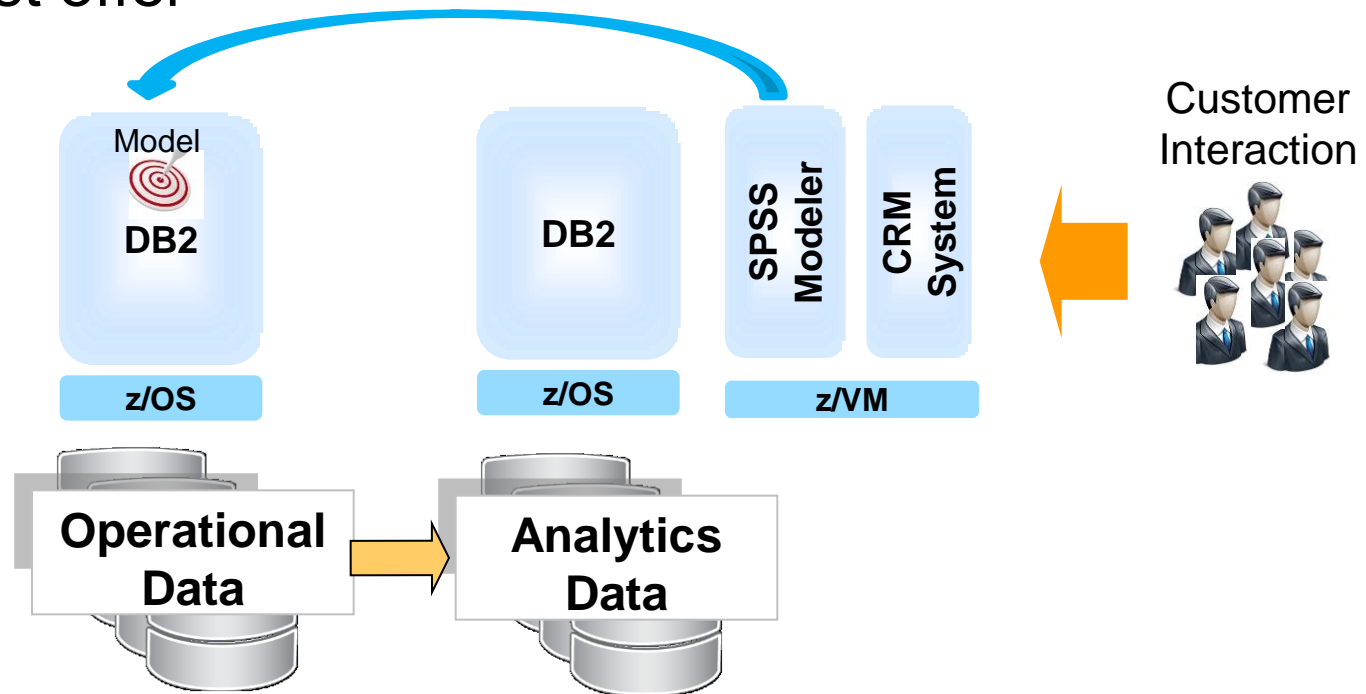

Run End-To-End Analytics On zEnterprise To Reduce Costs And Improve Reliability

- 60-70% of operational data resides on System z*
- zEnterprise offers a fully integrated, optimized solution on one platform
 - ▶ From operational data to business analytics
- Consolidating data warehouses on zEnterprise with Analytics Accelerator can reduce costs over 90%
- Cognos and SPSS add unmatched predictive intelligence



* Source <http://www.ibmssystemsmag.com/mainframe/trends/whatsnew/The-Mainframe-at-a-Crossroads/>



Notice Regarding Specialty Engines (e.g., zIIPs, zAAPs and IFLs):

Any information contained in this document regarding Specialty Engines ("SEs") and SE eligible workloads provides only general descriptions of the types and portions of workloads that are eligible for execution on Specialty Engines (e.g., zIIPs, zAAPs, and IFLs). IBM authorizes customers to use IBM SE only to execute the processing of Eligible Workloads of specific Programs expressly authorized by IBM as specified in the "Authorized Use Table for IBM Machines" provided at www.ibm.com/systems/support/machine_warranties/machine_code/aut.html ("AUT").

No other workload processing is authorized for execution on an SE.

IBM offers SEs at a lower price than General Processors/Central Processors because customers are authorized to use SEs only to process certain types and/or amounts of workloads as specified by IBM in the AUT.