



The Gold Standard for Enterprise Computing

**Unique Innovations
That Make zEnterprise Superior**

Today's agenda

9:15am	Unique innovations that make zEnterprise superior
10:15am	Business analytics on the ultimate data platform
11:15am	Advantages of a private cloud on zEnterprise
12:00pm	<i>Lunch</i>
1:00pm	Is your enterprise ready for the mobile revolution?
2:00pm	Mainframe skills - the myths and the reality
3:00pm	The enterprise server for the 21 st century

Fifty years ago, IBM introduced the first mainframe computer...



System 360 – April 7, 1964

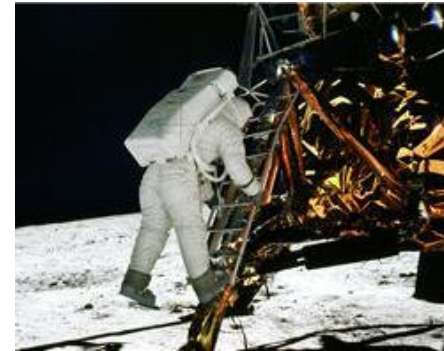

It helped put men on the moon...

It touches all of us from the day we were born...

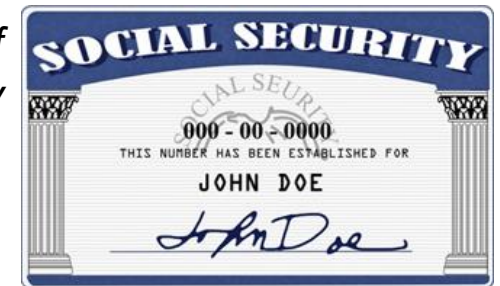

It was revolutionary...

It was innovative...

It changed the world!



It changed the way we live and work...



Fifty years ago, IBM introduced the first mainframe computer...



System 360 – April 7, 1964

It is still revolutionary...

It is still innovative...

It is still changing the world!

**NO!! – IBM
continues to
invest
\$BILLIONS in
mainframe
technology**

IBM model 5150 – c.1981

Customer demand and technical leadership have lead to *continuous re-invention of the mainframe*

Hardware carry-forward + continuous application compatibility

- 24-bit addressing (32-bit architecture)
- 1 or 2 cores
- 16MB storage
- 24K core memory

- 24-bit or 31-bit virtual addressing
- Fully integrated monolithic memory
- 256 channel architecture
- Virtual storage

- CMOS processors
- More than 1,000 MIPS
- Parallel sysplex
- Enterprise Systems Architecture (ESA)

- Specialty engines
- Hardware-assisted compression and encryption
- Decimal floating point
- 64-bit superscalar architecture

- zEC12: up to 120 cores, 5.5GHz speed, 78,000+ MIPS
- zBC12 for mid-range
- Hybrid computing
- zBladeCenter extension and zManager

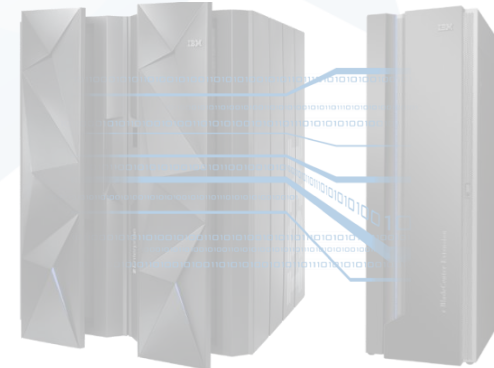
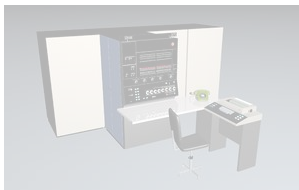
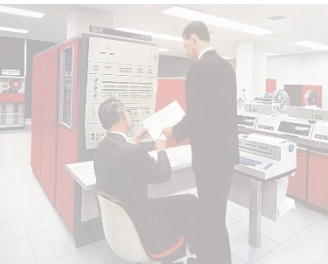

- VM operating system

- MVS, IMS, CICS, and DB2

- WebSphere

- Rational Development & Test

S/360

S/370

S/390

zSeries

zEnterprise

1964

1970

1990

2000

2010

The IBM zEnterprise server – ready for the business challenges of today and the future



IBM zEnterprise EC12



IBM zEnterprise BC12

- The most available and secure platform commercially available
- Supports today's newest workloads
 - Data and analytics
 - Cloud
 - Mobile
- A multi-architecture platform for hybrid workloads
- Lowest total cost of ownership for most enterprise workloads

Let's look at some of the key mainframe innovations...

The IBM mainframe was the world's first virtualized server

Virtualization

- Shared-everything design
- Virtualization built into the microcode
- Thousands of virtual guests
- Near 100% utilization
- Ideal choice for cloud deployments

DEMO: How many virtual machines can zEnterprise create?

Creating new Linux images.....Servers in seconds with IBM

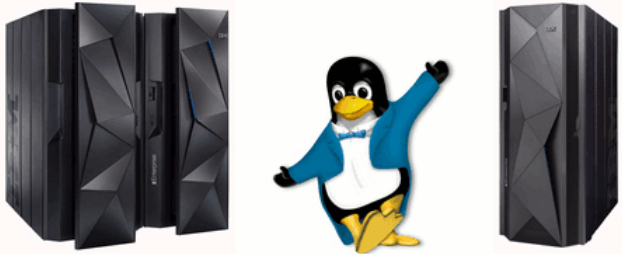

1000 Servers

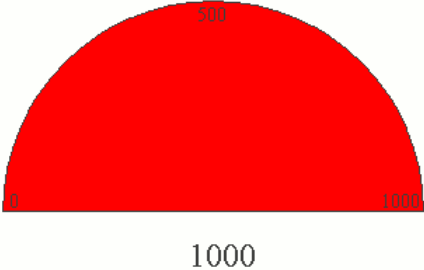

Time Elapsed: 4:24:22 Avg 15

Compared to leading distributed hypervisors, z/VM demonstrates better scalability

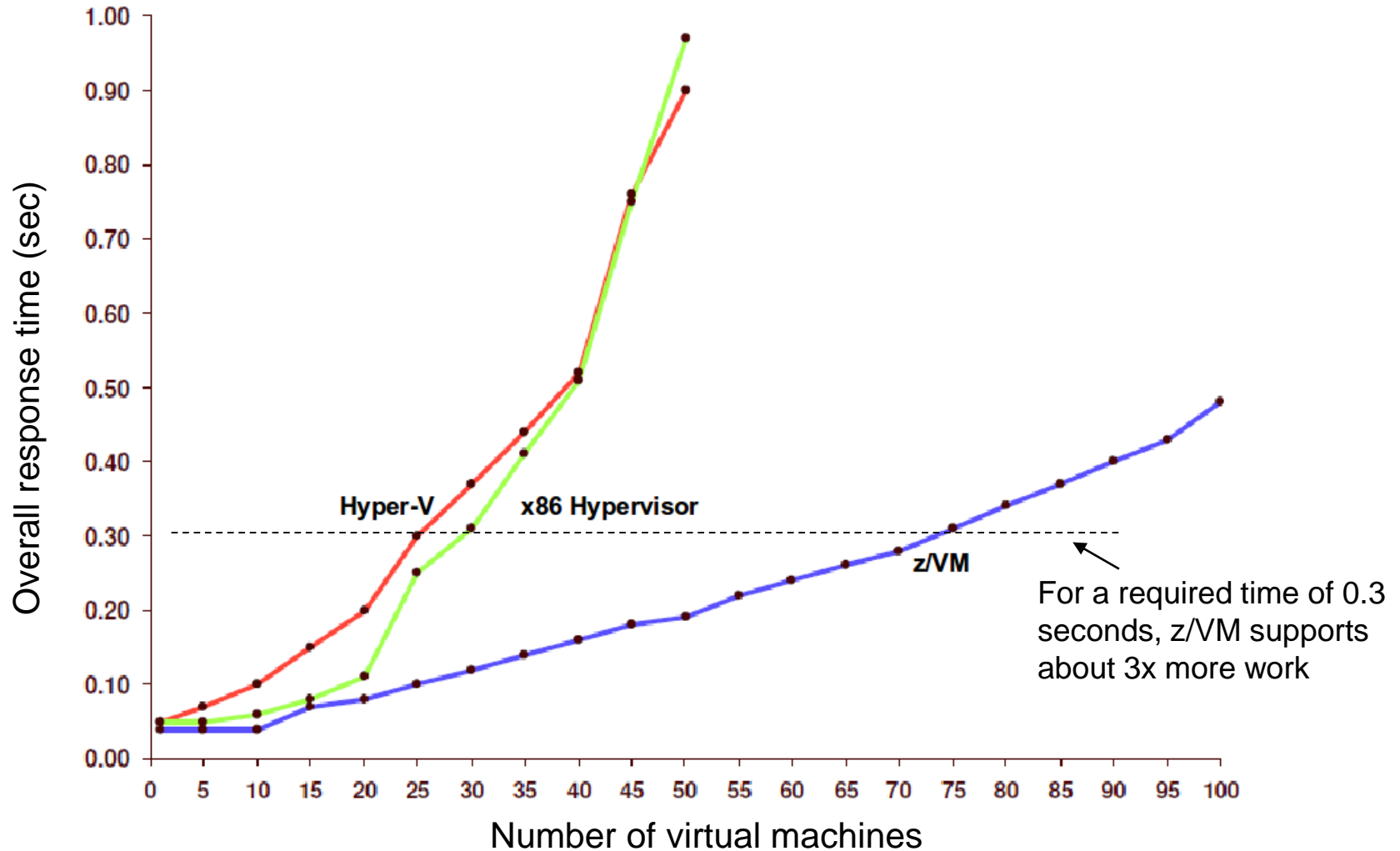

A unique zEnterprise feature not found on other servers is the I/O subsystem

Virtualization

I/O Subsystem

- Reduces CPU usage by offloading I/O overhead
- Reduces number and cost of software licenses
- Improves I/O performance for batch and high performance OLTP
- Allows introduction of new facilities into existing I/O subsystem

In comparison tests of I/O load capacity, Intel times were significantly slower

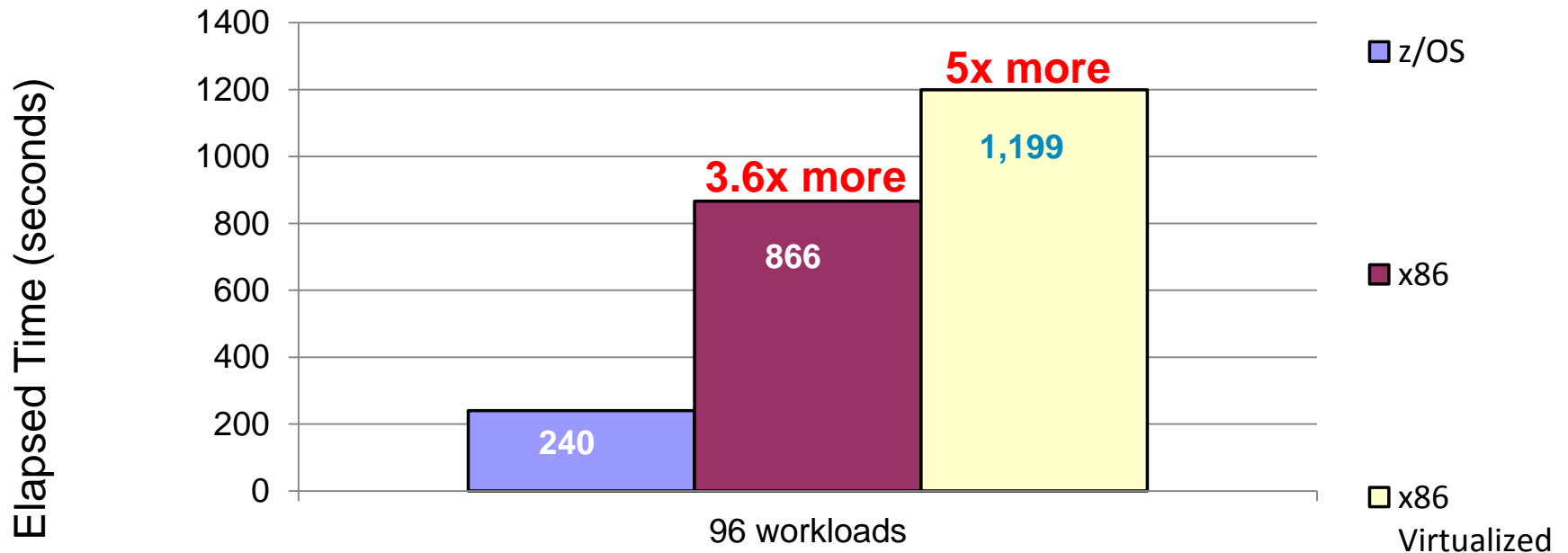

Performance comparison test of an I/O intensive workload with identical enterprise class storage. zEC12 had **8** core. Westmere EX server had **40** core @2.4GHz. Each system connected via 4 x 8Gb links to DS8800. zEC12 running against 8 SSD DASD CKD volumes. Intel server running against 8 SSD LUNs FB volumes. Note: Storage limitations came into effect at workload counts greater than 96.

Batch workloads take advantage of zEnterprise capability to support high I/O capacity

Intel Xeon E7-4870 + DS8300

40 processors
128 GB RAM
Linux Sort

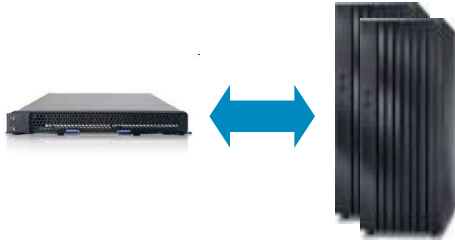

Sorting
Average CPU
89%

z/OS + DS8800

8 processors
128 GB RAM
DFSORT



Sorting
Average CPU
72%

SORT Job: Sort a 3 GB transaction file – Repetitions: 300

Total Elapsed
Bytes Per Sec

2,657 secs
240 MB

Total Elapsed
Bytes Per Sec

515 secs
3,000 MB

**13x more I/O
bandwidth
than Intel**

MERGE Job: Merge 30 sorted files into a 90 GB master file – Repetitions: 10

Total Elapsed
Bytes Per Sec

4,051 secs
157 MB

Total Elapsed
Bytes Per Sec

446 secs
3,460 MB

**Intel Batch window
is 7x longer than z/OS**

IBM continues to innovate with new PCIe features – Shared Memory Communications (SMC-R) introduced in 2013

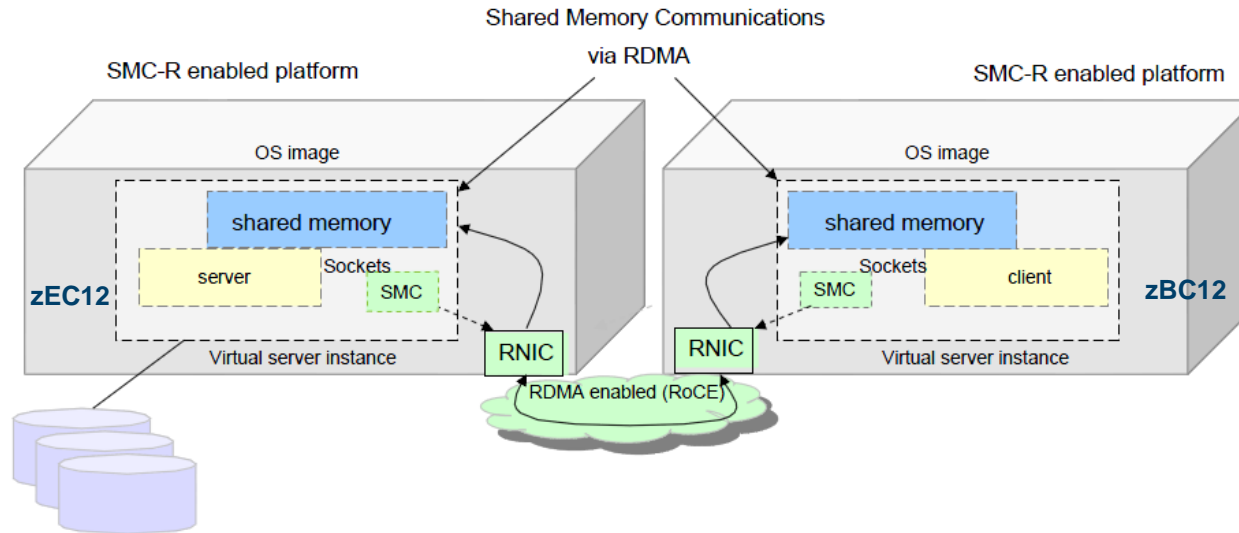

Network latency
reduced up to
80%*

- 10GbE RDMA over Converged Ethernet (RoCE) Express card
- Helps reduce latency and CPU resource consumption
- Runs over TCP/IP across z/OS systems
- Can be used seamlessly by *any* z/OS TCP sockets-based without any changes

* Based on internal IBM benchmarks of modeled z/OS TCP sockets-based workloads with request/response traffic patterns using SMC-R vs. TCP/IP. The actual throughput that any user will experience will vary.

Parallel sysplex gives zEnterprise continuous availability with near linear scalability

Virtualization

I/O Subsystem

Parallel Sysplex

- Optimized to support IBM middleware
- Provides a single image across the cluster
- Centralized design optimizes data sharing
- Enables near-infinite elasticity

zEnterprise parallel sysplex clusters provide unmatched processing power and availability



- Clustering driven by specialty engines (Coupling Facility)
- Presents a single system image of a z/OS workload
- Potentially **2.5M MIPS** per 32-way cluster*

Single System Sysplex

*Equivalent to about 240 of the largest Oracle servers

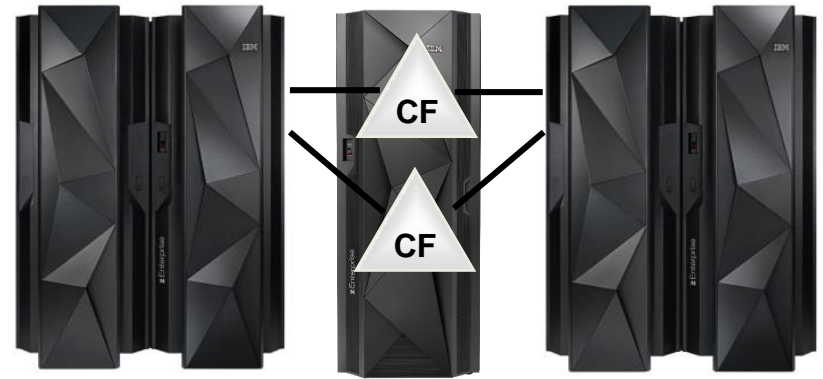

External Coupling Facility
(Can be different class server)

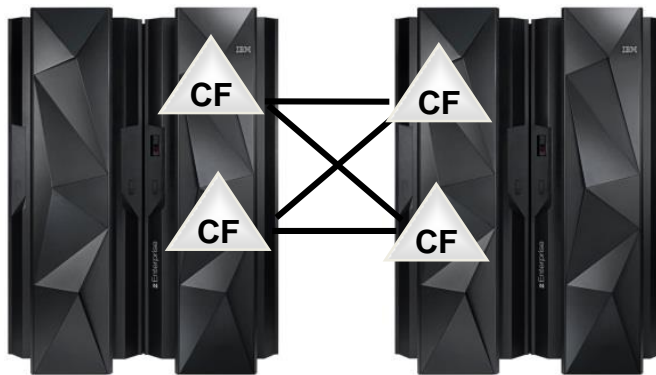

Cross Connected Servers with internal Coupling Facilities

- Enables rolling updates
- Supports continuous access to business services and data – from anywhere, at anytime
- Designed for **99.999%** availability

zEnterprise's centralized Coupling Facility permits efficient lock and cache management in DB2

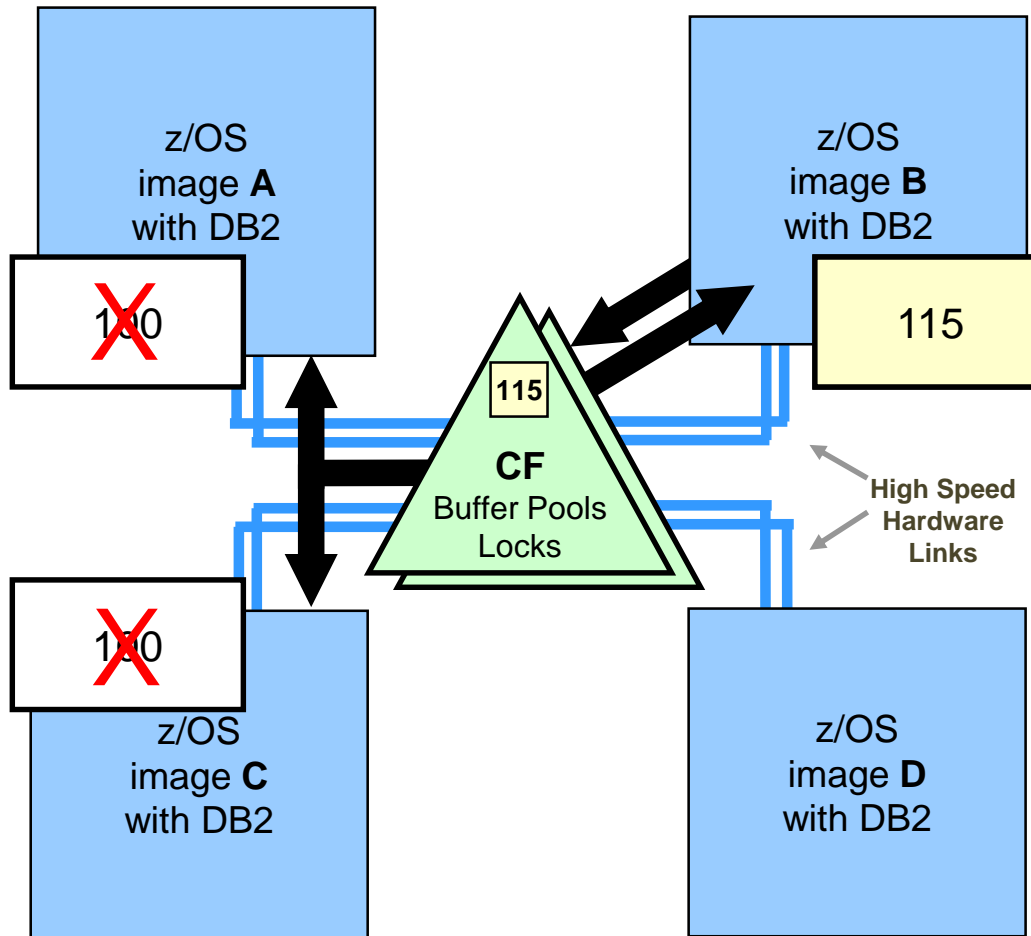

A and C have data in local buffer pool without locks

1. B registers page to CF and obtains write lock
2. B updates data
3. B commits update

B caches update in group buffer pool

CF invalidates all cached copies without interrupting processors

Cache and locks are maintained with no inter-node disturbance!

Oracle RAC's distributed lock management design causes overhead

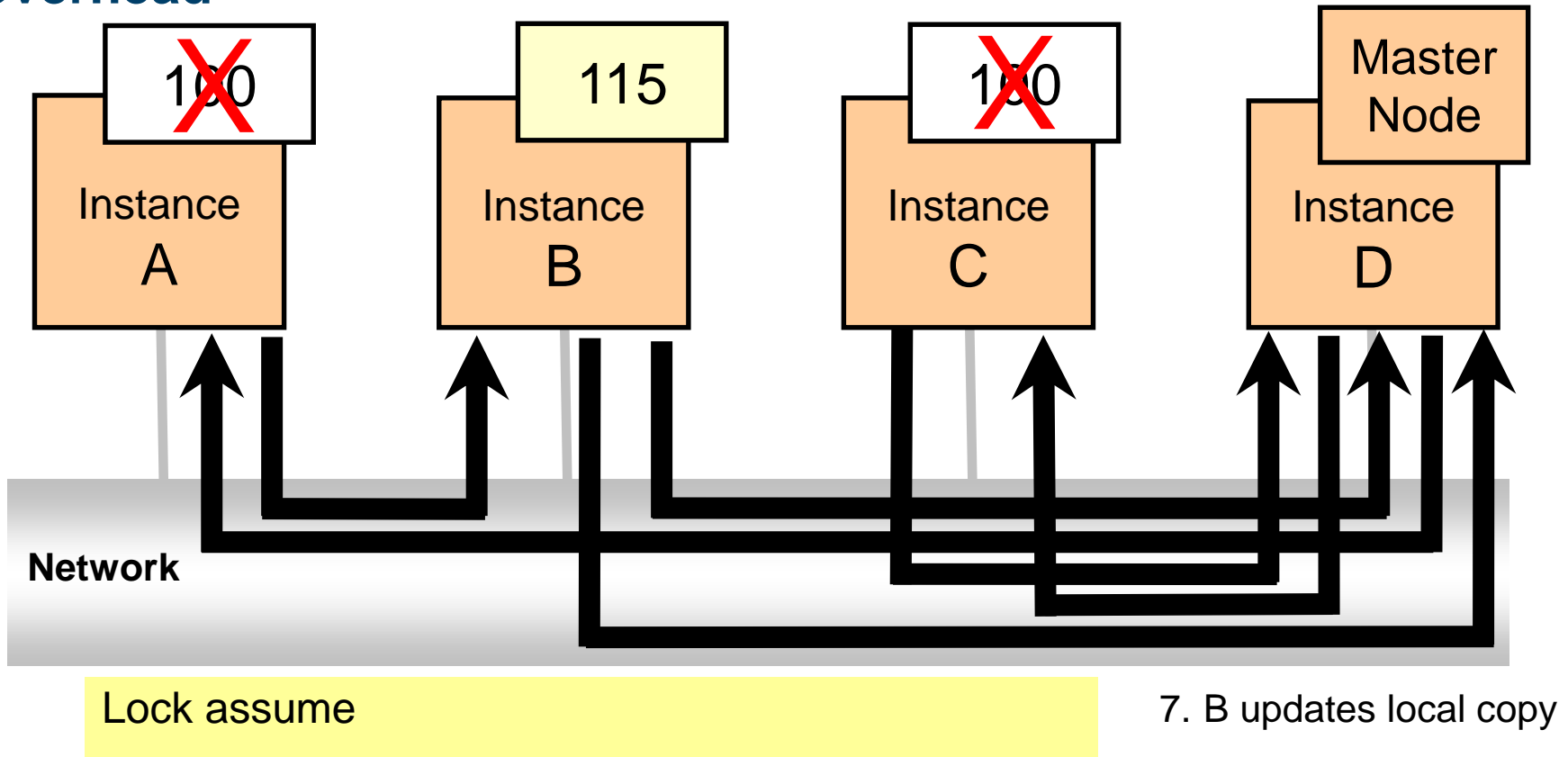

Inter-node connections: **6**

In a cluster with 4 nodes, an update operation may need 6 network connections and two in-memory calls (not shown).

Example based on Oracle's US Patent 7,107,319 B2.

DB2 for z/OS in a parallel sysplex scales efficiently and transparently

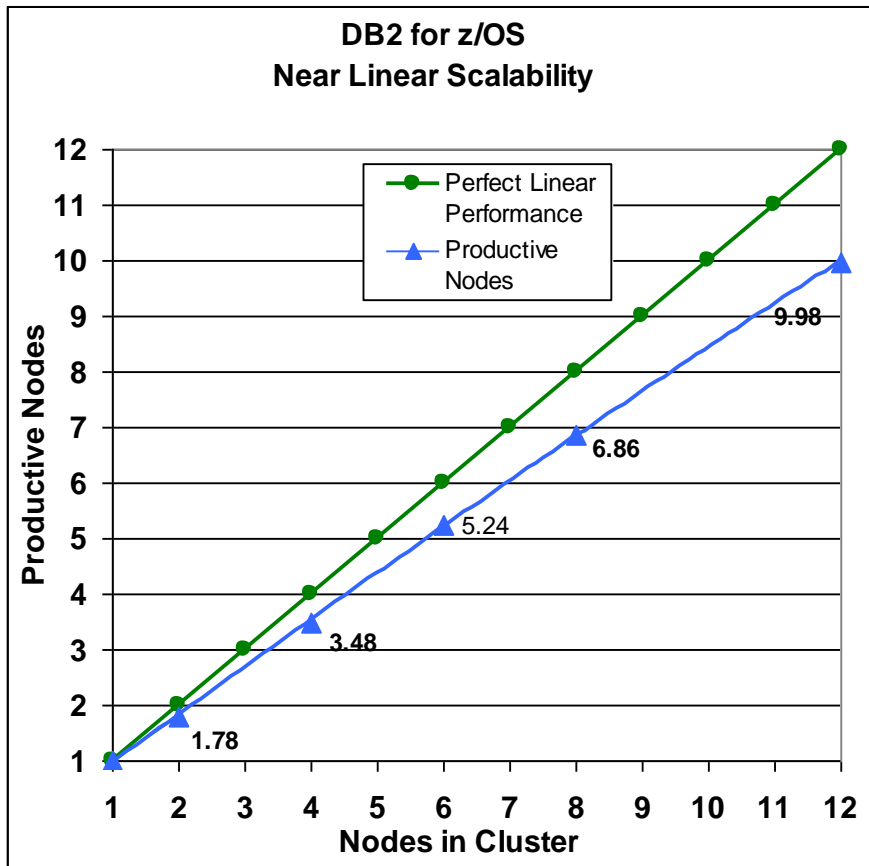

- DB2 leverages unique Parallel Sysplex clustering design to achieve near linear scaling
 - No data partitioning required
 - No transaction routing required
 - No cluster awareness required in applications

- Elastic processing capacity
 - Applications are not tied to database partitioning schemes
 - Automatically balances workload across cluster

The only option for Intel-based servers is Oracle RAC

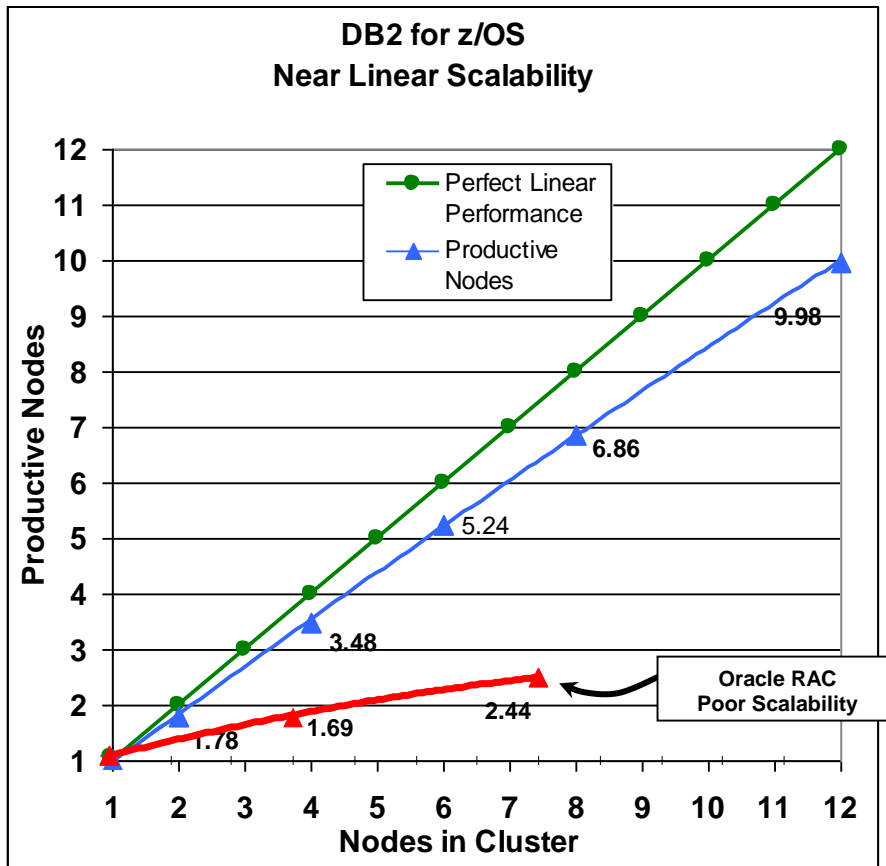

- Oracle RAC's lock and cache system is inefficient by design
 - Scaling RAC requires complex tuning and partitioning
 - Application partition awareness makes it difficult to add or remove nodes

- Published studies demonstrate difficult or poor scalability
 - Dell (shown in chart): Poor scalability despite using InfiniBand for RAC interconnect
 - CERN: Four month team effort to tune RAC, change database, change application
 - Insight Technology: Even a simple application on two node RAC requires complex tuning and partitioning to scale

Oracle RAC characteristics as shown in Dell RAC InfiniBand Study <http://www.dell.com/downloads/global/power/ps2q07-20070279-Mahmood.pdf>
 CERN (European Organization for Nuclear Research) http://www.oracreracsig.org/pls/apex/RAC_SIG.download_my_file?p_file=1001900
 Insight Technology <http://www.insight-tec.com/en/mailmagazine/vol136.html>

The zEnterprise demonstrates “perfect” workload management

Virtualization

I/O Subsystem

Parallel Sysplex

Workload Management

- Applies across all resources, not just CPU
- Ensures priority workloads meet service level agreements
- Cross platform
- Covers heterogeneous platforms

System z demonstrated perfect workload management and very high utilization

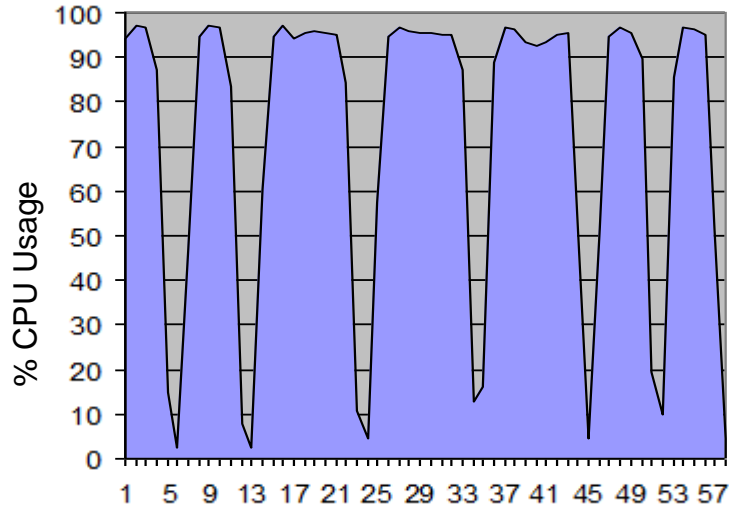

Demand curve for 10 high priority workloads running in LPAR 1

- Workloads consume 72% of available CPU resources (28% unused)
- Total throughput: 9.13M
- Average response time: 140ms

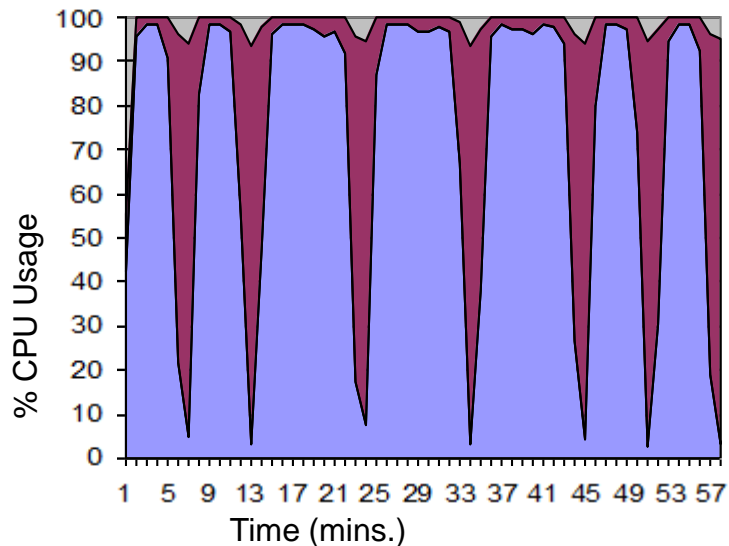

Demand curve when 14 low priority workloads are added in LPAR 2

- All but 2% of available CPU resources is used (high=74%, low=24%)
- High priority workload throughput is maintained (9.13M)
- No response time degradation (140ms)

Common x86 hypervisor could not manage high priority workloads correctly, and ran at much lower utilization rate

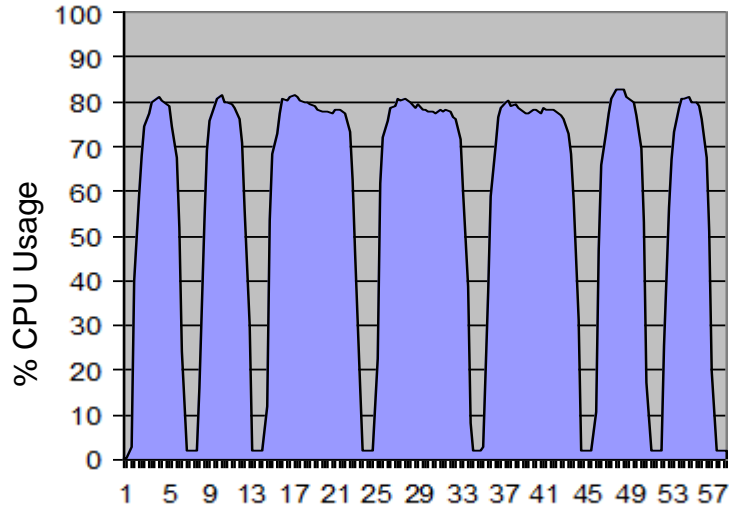

Demand curve for 10 high priority workloads running on a common Intel hypervisor (high share)

- Workloads consume 58% of available CPU resources (42% unused)
- Total throughput: 6.47M
- Average response time: 153ms

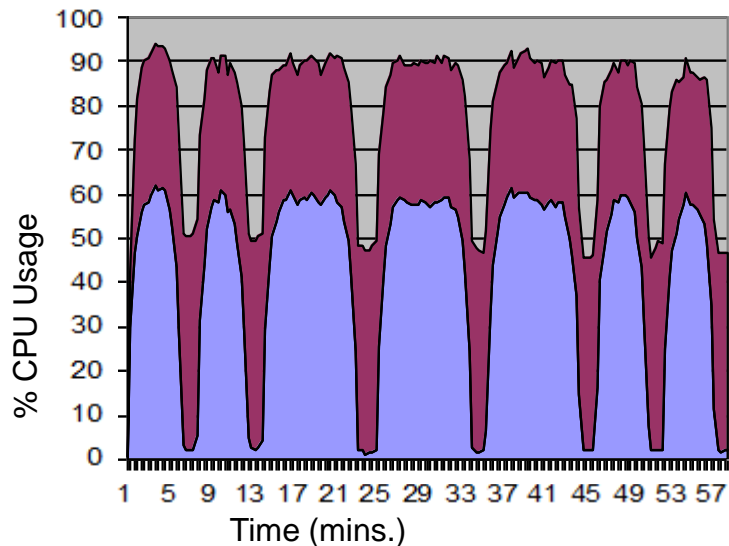

Demand curve when 14 low priority workloads are added (low share)

- 22% of available CPU resources is unused (high=42%, low=36%)
- High priority workload throughput drops 31% (4.48M)
- Response time degrades 45% (220ms)

System z virtualization enables mixing of high and low priority workloads without penalty

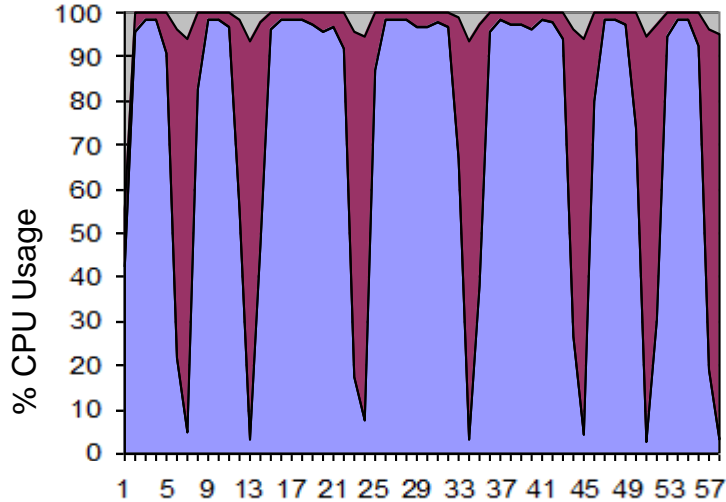

System z

- Perfect workload management
- Consolidate workloads of different priorities on the same platform
- Full use of available processing resource (high utilization)

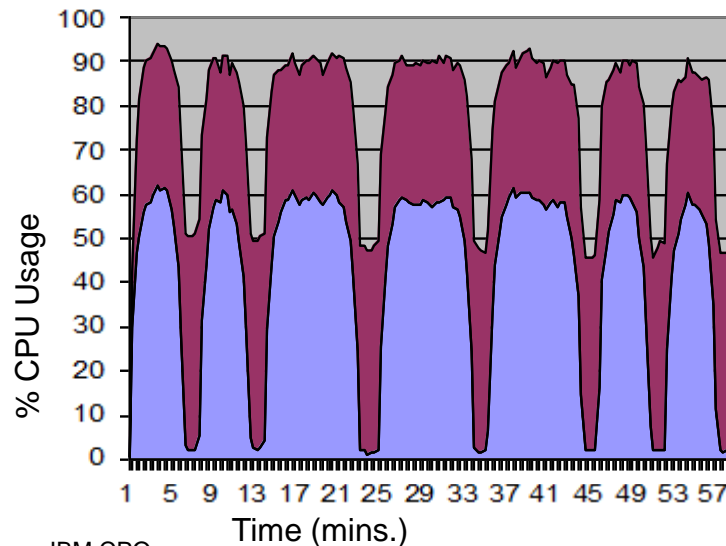

Common Intel hypervisor

- Imperfect workload management
- *Forces workloads to be segregated on different servers*
- *More servers are required (low utilization)*

zEnterprise easily manages mixed priority workloads and lowers costs

Which platform provides the lowest TCA over 3 years?

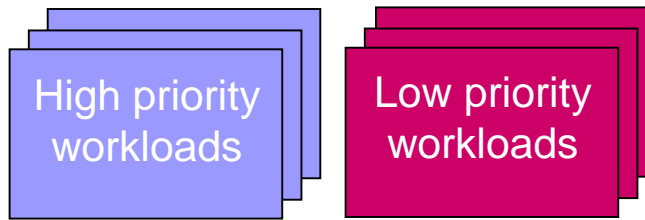

- IBM WebSphere 8.5 ND
- IBM DB2 10 AESE
- Monitoring software

High priority online banking workloads driving a total of **9.1M** transactions per hour and low priority discretionary workloads driving **2.8M** transactions per hour

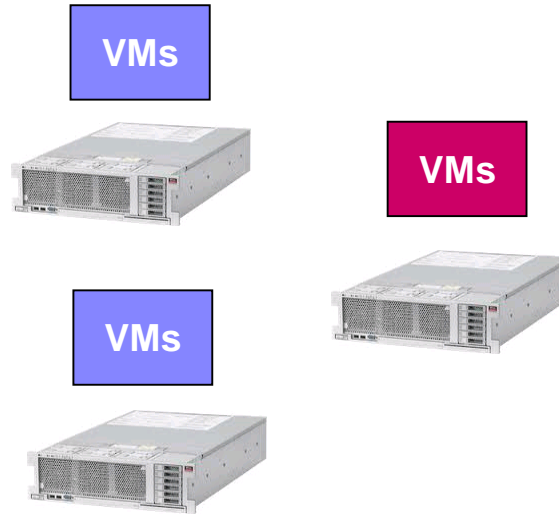

Virtualized on 3 Intel 40 core servers
\$15.9M (3 yr. TCA)

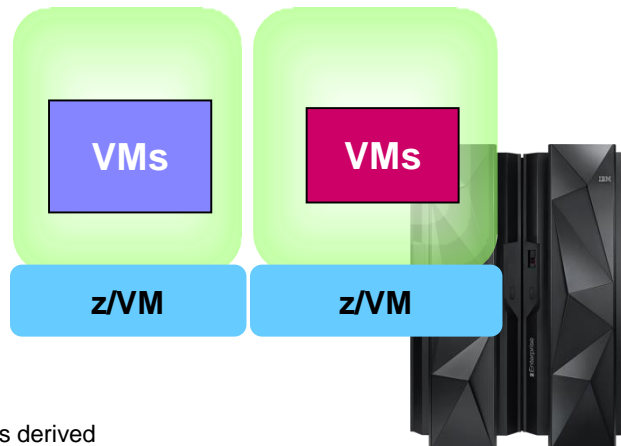

z/VM on zEC12
 32 IFLs
\$6.5M (3 yr. TCA)

59%
lower cost!

Consolidation ratios derived from IBM internal studies.. zEC12 numbers derived from measurements on z196. Results may vary based on customer workload profiles/characteristics. Prices will vary by country.

Only zEnterprise offers numerous options for optimizing workloads to reduce costs

Virtualization

I/O Subsystem

Parallel Sysplex

Workload Management

Workload Optimization

- Specific workloads can be moved to custom hardware
- Hybrid workloads supported by multi-architecture platform
- Reduces costs and improves price/performance ratio

Workload optimizations are achieved via special I/O cards

zEnterprise Data Compression (zEDC) introduced in 2013



- Compatible with current coprocessor-based compression
- Specifically designed for large amounts of bulk data
- Cost effective – reduces CPU overhead, and storage overhead
- Optimizes cross-platform exchanges
 - Compatible with zlib compression – an industry standard widely used across all platforms

Up to **4x** data compression
Up to **118x** reduction in CPU

Up to **24x** throughput
improvement with zlib

IBM DB2 Analytics Accelerator speeds up deep analytics queries

- A workload-optimized, blade-based appliance that runs queries in seconds versus hours
- Integrated with DB2 for z/OS, and transparent to applications
- Drives down the costs of data warehousing and business analytics

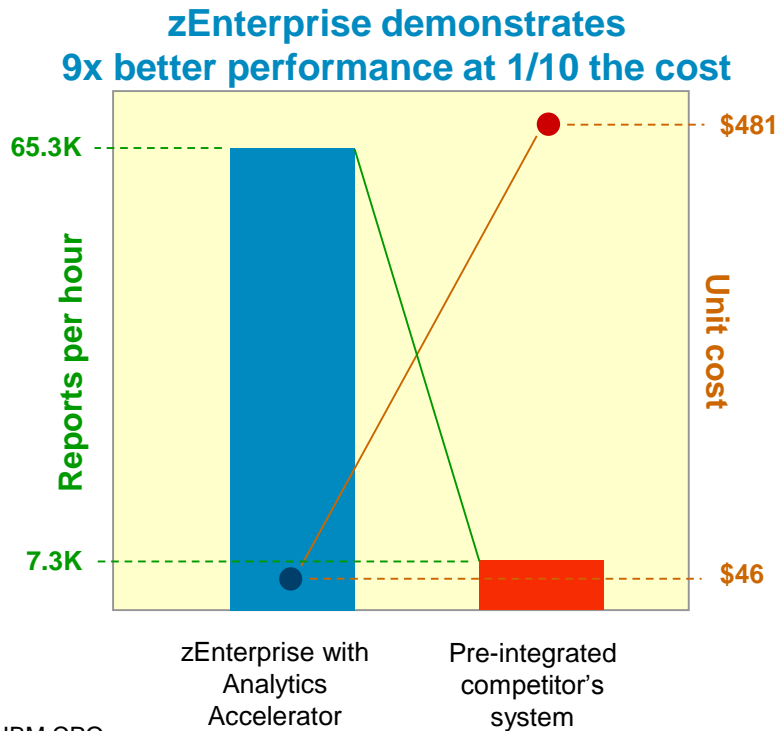

zEnterprise extends to support hybrid computing

zEnterprise BladeCenter Extension (zBX) and Unified Resource Manager (URM)

- Industry's first multi-architecture platform
 - zBX includes Power, x86, and accelerator blades
- URM extends System z governance extended to zBX blades
 - Provides resource and workload management across mainframe and blades
- Supports application integration with Microsoft Windows, Linux and AIX
- Greater opportunities for consolidation and simplification
- Consistent business controls across applications and platforms



*zEnterprise
BladeCenter Extension*

zEnterprise – the *most* secure commercially available platform

Virtualization

I/O Subsystem

Parallel Sysplex

Workload Management

Workload Optimization

Security

- Highest commercially available EAL ratings
- Multiple encryption options
- Provides full function Public Key certificate authority
- APIs extend encryption services across the enterprise
- State of the art security monitoring

Resource Access Control Facility (RACF) provides security throughout the entire zEnterprise stack

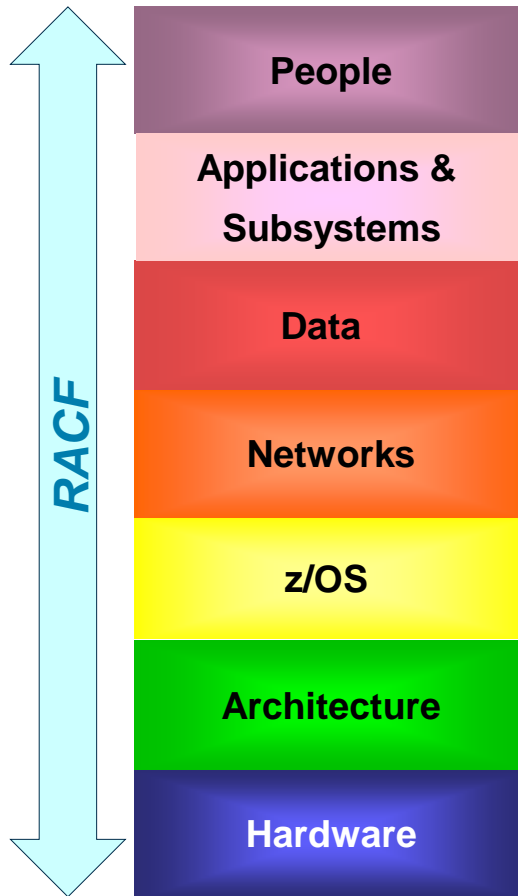

- Tools, reporting, auditing
- Access control to all classes of resources
- Integrated into the operating system
- Provides Enterprise Identity Management
- Supports cryptographic services
- Supports digital certificates

Virtualized System z security is superior to other platforms and augmentation costs less

Security Natively Covered by Platform

Security Level Description	IBM System z	x86	Competitive UNIX
Normal corporate	100.00%	18.16%	30.26%
Credit card processing involved	99.00%	11.04%	18.28%
Banking	94.00%	5.26%	10.22%
Healthcare	100.00%	3.24%	8.51%
Research	92.50%	2.86%	4.16%
Defense	85.54%	0.26%	1.86%

- On System z, most security requirements are standard
- Major security deficiencies exist on distributed platforms

Incremental Cost to Achieve Required Security

- Distributed platforms require considerable additional expense to achieve required security levels

Security Level Description	IBM System z	x86	Competitive UNIX
Normal corporate	0.00%	32.54%	12.37%
Credit card processing involved	2.32%	46.27%	29.53%
Banking	2.07%	51.31%	26.58%
Healthcare	0.00%	67.26%	35.89%
Research	4.28%	91.26%	64.28%
Defense	11.36%	125.41%	102.26%

Source: "Tracked, Hacked and Attacked?"

© 2013, Solitaire Interglobal Ltd. https://www.ibm.com/services/forms/signup.do?source=stg-web&S_PKG=ov14292

zEnterprise's reliability, availability and serviceability are legendary

Virtualization

I/O Subsystem

Parallel Sysplex

Workload Management

Workload Optimization

Security

Reliability

- Comprehensive, multi-layered strategy for reliability and serviceability
- Supports large number of concurrent operations during maintenance
- “Five 9s” availability
- Lowest costs

Downtime seriously effects sales, revenue, customer satisfaction

Revenue Impact of Downtime Per Hour

Figure 1 Cost of downtime by industry segment
Average = \$2.7M

Industry/Sector	Revenue/Hour
Energy	\$1,468,798
Telecommunications	\$4,611,604
Financial	\$8,213,470
Information Technology	\$3,316,058
Insurance	\$2,582,382
Pharmaceuticals	\$2,058,710
Banking	\$1,145,129
Consumer Products	\$989,795
Chemicals	\$1,071,404
Transportation	\$1,463,128

Source: Robert Frances Group 2006

Business Impact of 10 Minutes Of Downtime

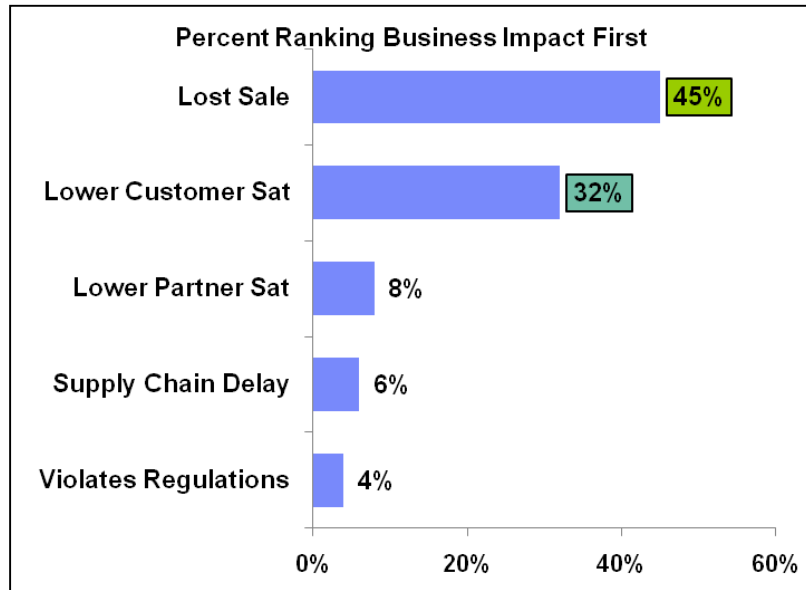

Source: IBM Customer Survey

Profit Impact of Downtime

A Telco	%	Profit 2009	Profit/Hr	Profit/Min
Wireless	68%	\$3,000,000,000	\$342,466	\$5,708
Cable	29%	\$1,300,000,000	\$148,402	\$2,473
Media	3%	\$120,000,000	\$13,699	\$228
Total	100%	\$4,420,000,000	\$504,566	\$8,409

zEnterprise supports concurrent operations during maintenance

Capability	zEC12	x86
ECC on Memory Control Circuitry	Transparent While Running	Can recognize/repair soft errors while running; limited ability with hard errors
Oscillator Failure	Transparent While Running	Must bring server down to replace
Core Sparing	Transparent While Running	Must bring server down to replace
Microcode Driver Updates	While Running	Some OS-level drivers can update while running, not firmware drivers; reboot often required
Book Additions, Replacement	While Running	Must bring server down
Memory Replacement	While Running	Must bring server down
Memory Bus Adaptor Replacement	While Running	Must bring server down
I/O Upgrades	While Running	Must bring server down to replace (limited ability to replace I/O in some servers)
Concurrent Driver Maintenance	While Running	Limited – some drivers replaceable while running
Redundant Service Element	2 per System	“Support processors” can act as poor man’s SE, but no redundancy

Single book systems may not support concurrent memory upgrades

DEMO: Dynamically add processing capacity to z/VM LPAR to handle increased workload... *without disruption*

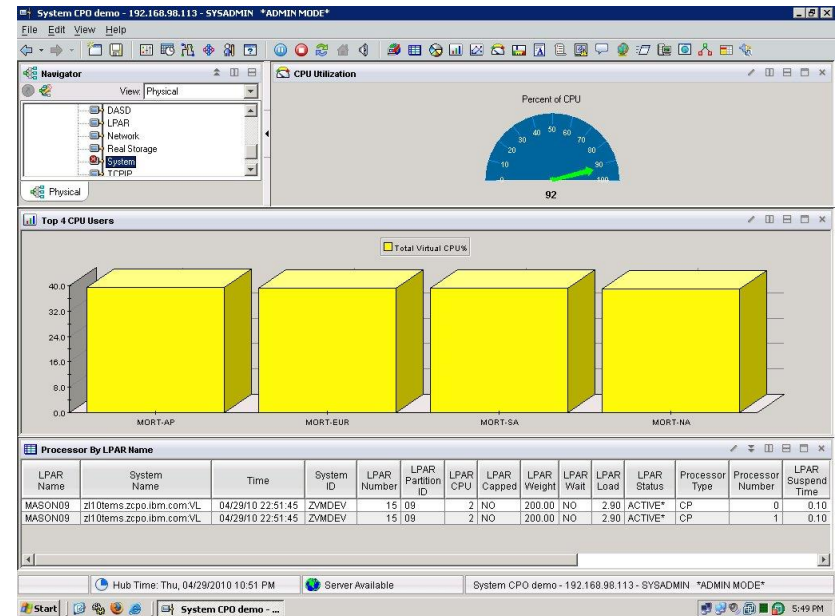
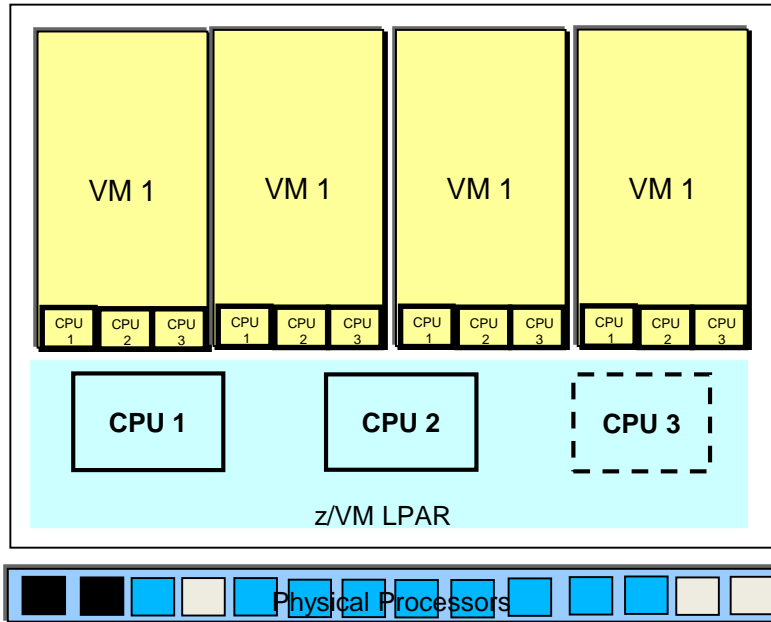

Tivoli Enterprise Portal

- Guest VMs run without disruption
- Dynamically add logical processors to z/VM LPAR
- Dynamically add processors shared among LPARs

Today's mainframe – 50 years of *continuous* innovation...

Virtualization

I/O Subsystem

Parallel Sysplex

Workload Management

Workload Optimization

Security

Reliability



IBM zEnterprise EC12

**Now let's look at several
new opportunities
for zEnterprise workloads...**