

The IBM Enterprise Linux Server – A Solution to Your IT Challenges

The Right Solution: IBM's Enterprise Linux Server



What's the right solution to address today's IT challenges?

Is this what
your data center
looks like?



Is this where
you'd like to be?



- Currently running *lots* of x86 or UNIX servers
- Have serious concerns about
 - Downtime
 - Data security
 - Data center floor space and energy usage
 - Growth and scalability
- Strategically committed to Linux and open source
- Improved efficiency
 - Fewer servers, less networking
 - Fewer software licenses
 - Growth within the box
 - Better utilization of compute resources
- Reduced risk, better security, higher availability
- Reduced costs, reduced staff, simplification

Introducing the IBM Enterprise Linux Server (ELS)



- An excellent platform for large scale consolidation
 - Highly virtualized, and designed to run at very high CPU utilization rates
- Fast, very high-capacity processors; extreme scalability and elasticity; ultimate levels of reliability, availability and security
- Simplified administration, efficient IT operations
- Low comparable total cost of ownership (TCO)
- Ideal Linux platform for today and the future

Statistical multiplexing models show how consolidating on a highly virtualized platform drives up CPU utilization

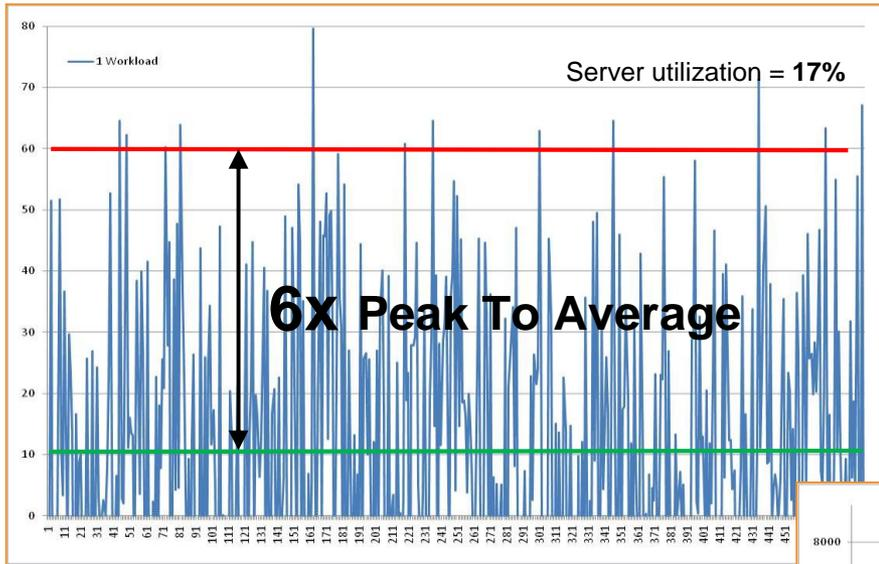

- Consolidating variable workloads on a virtualized server reduces the overall variance (statistical multiplexing)
- Consequently, larger servers with capacity to run more workloads can be driven to higher average utilization levels without violating service level agreements

1 variable workload:
Machine capacity (red) =
6x average demand (green)

144 variable workloads:
Machine capacity (red) =
1.42x average demand (green)

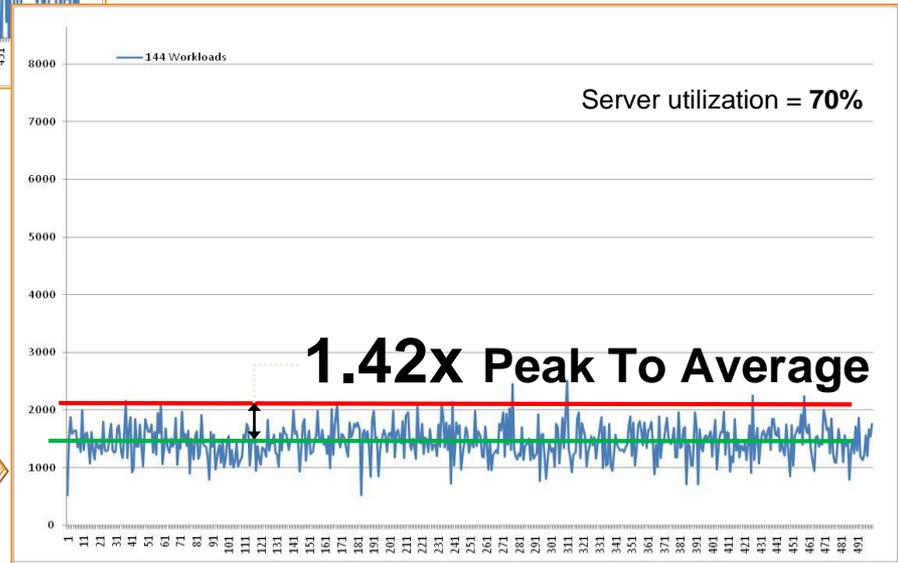

Enterprise Linux Server virtualization is built-in (not added-on) to give the best workload isolation

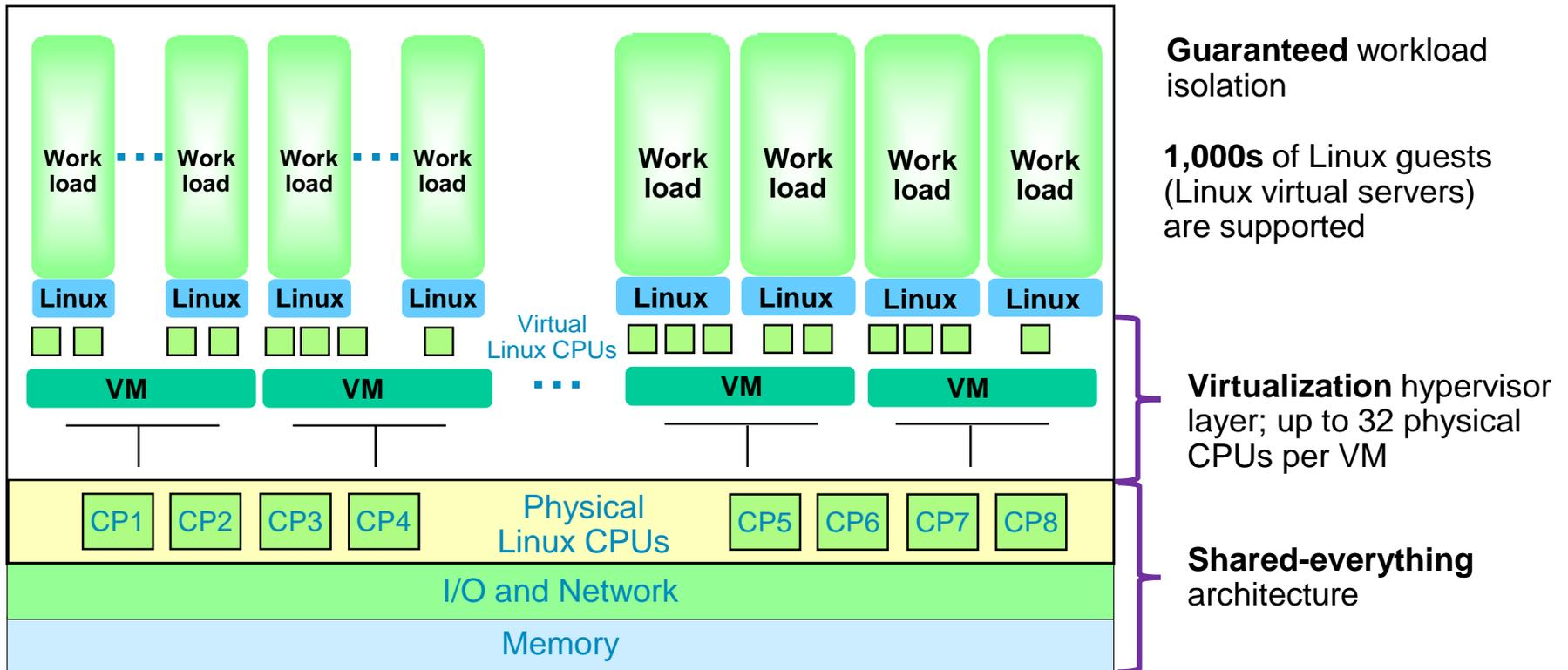

Hardware-enforced isolation: 10% of circuits support virtualization

Enterprise Linux Server has superior virtualization compared to distributed servers

*Enterprise Linux Server is designed to run
1,000s of Linux virtual servers at nearly 100% utilization
nearly 100% of the time*

Enterprise Linux Server

- **Most sophisticated** and functionally complete hypervisors, based on **shared everything** architecture
- Virtualization can **simulate devices** not physically present
- Highly **granular** resource sharing (<1%)
- **Deploy** Linux virtual servers (guests) in **seconds**
- Add physical resources without taking system down, scale out to **1,000s** of Linux guests
- Extensive built-in facilities for virtual server **life-cycle management**
- **Hardware-enforced isolation**

Distributed Platforms

- Limited per-core virtual server scalability
- Physical server sprawl is needed to scale
- Operational complexity increases as virtual server images grow
- VMware tools only support VMware hypervisor (ESX)

A key strength to ELS virtualization is the ability to over-commit resources

- Hosted environment consumes considerably more CPU and memory, in aggregate, than what is configured for the VM instance
 - Translate directly into cost savings for hardware *and* software

Example: Software is licensed for two **physical CPUs**, but runs on 50 virtual Linux CPUs

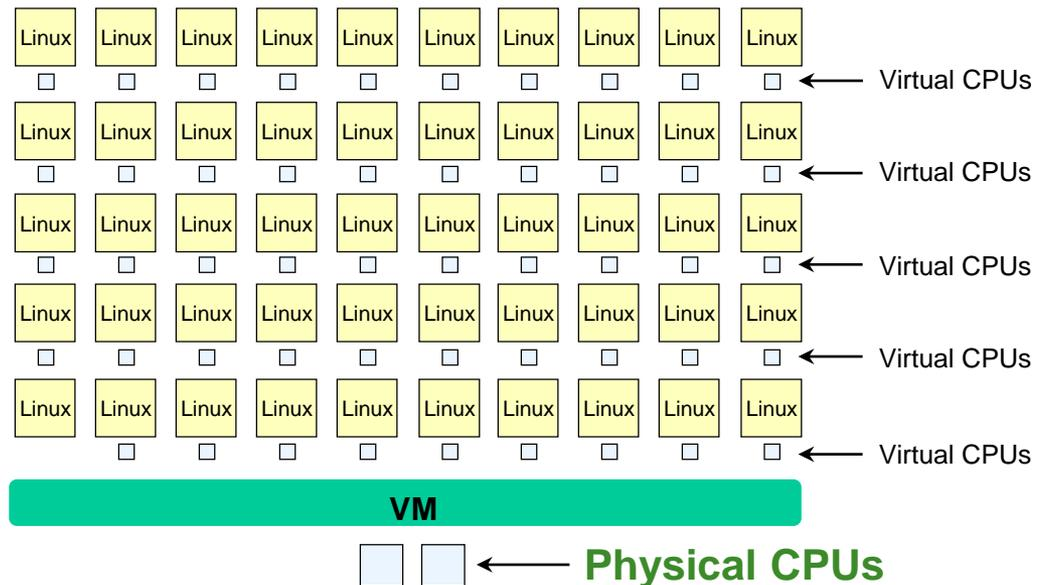

Throughput comparison for different virtualization platforms

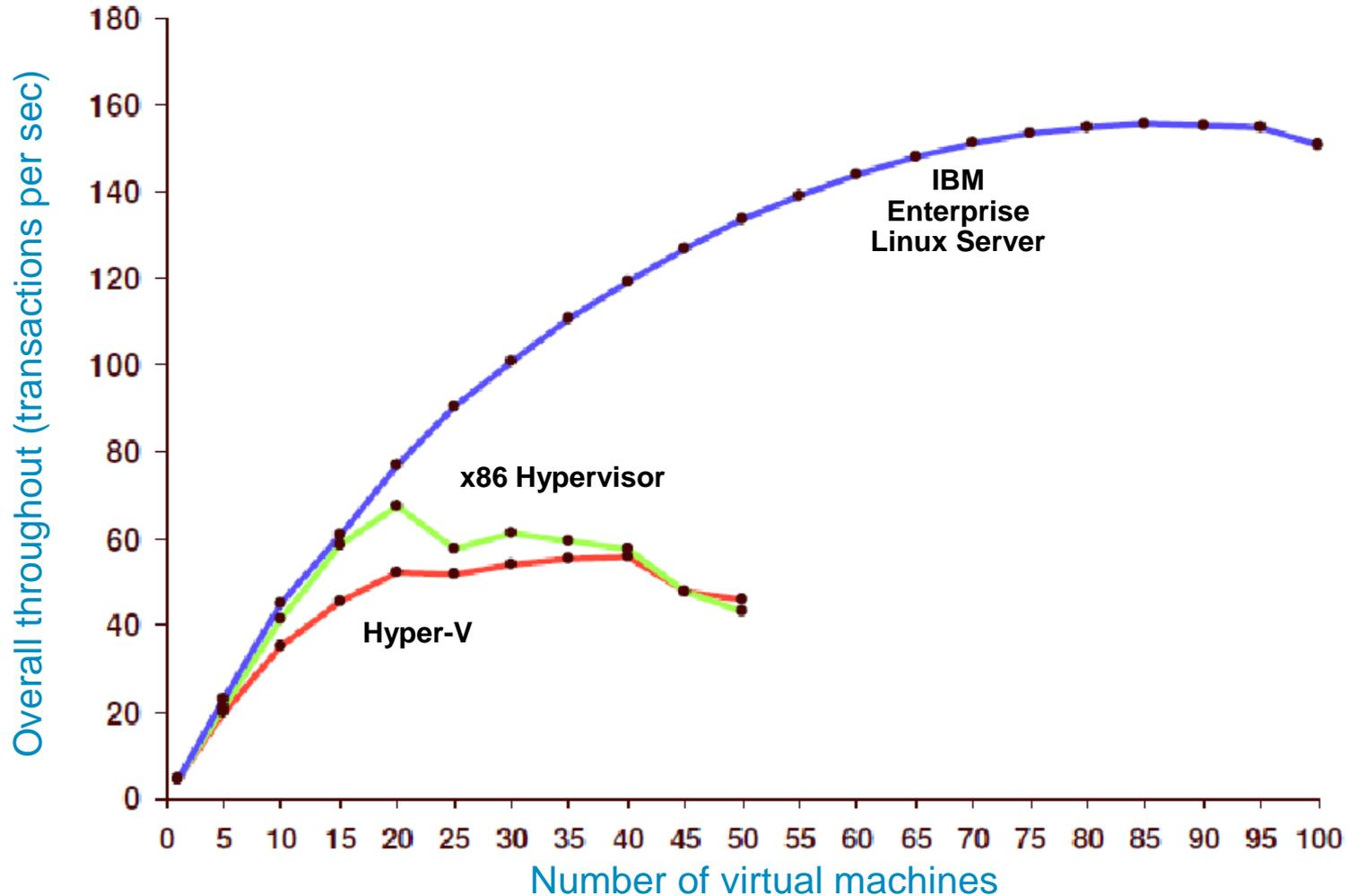

Response time comparison for different virtualization platforms

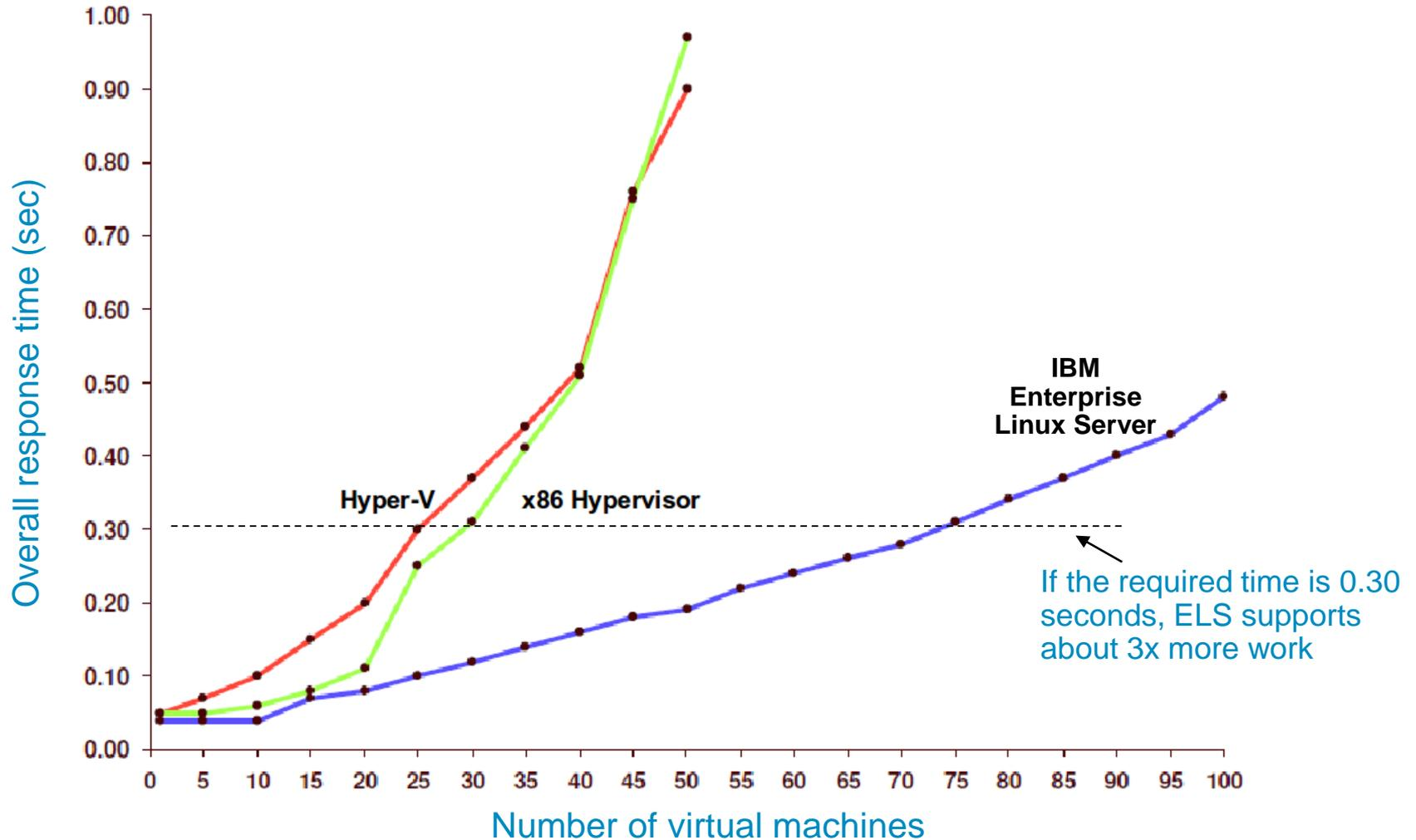

IBM Enterprise Linux Server has many unique virtualization advantages

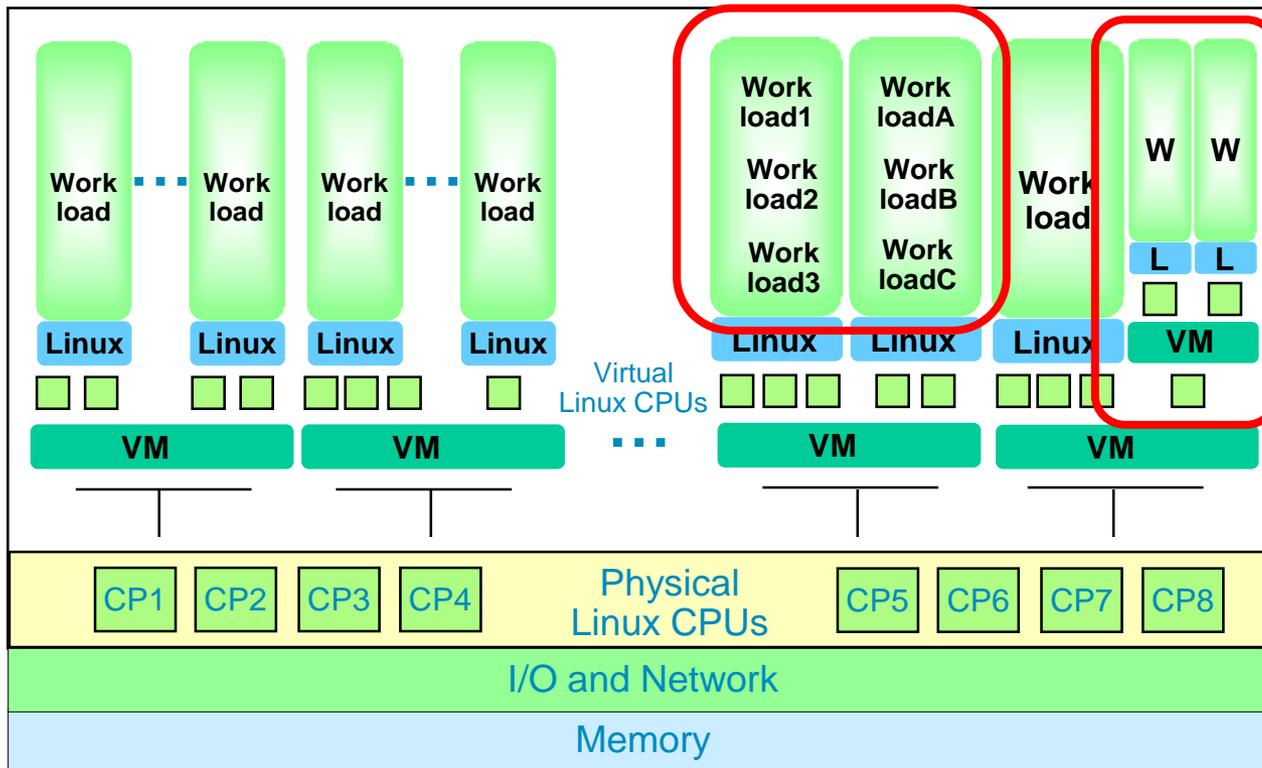

Hypervisor recursion!

Multiple application instances per Linux guest

Easy partition and virtual server cloning enables high availability

Partition-to-Partition communication via very fast in-memory TCP/IP

Tests demonstrate comparison of Enterprise Linux Server virtualization to a common x86 hypervisor

- High priority workloads had defined demand over time
 - Service Level Agreement (SLA) requires that response time not degrade over time
- Low Priority workloads had unlimited demand
 - Allowed to “soak up” any unused CPU resource

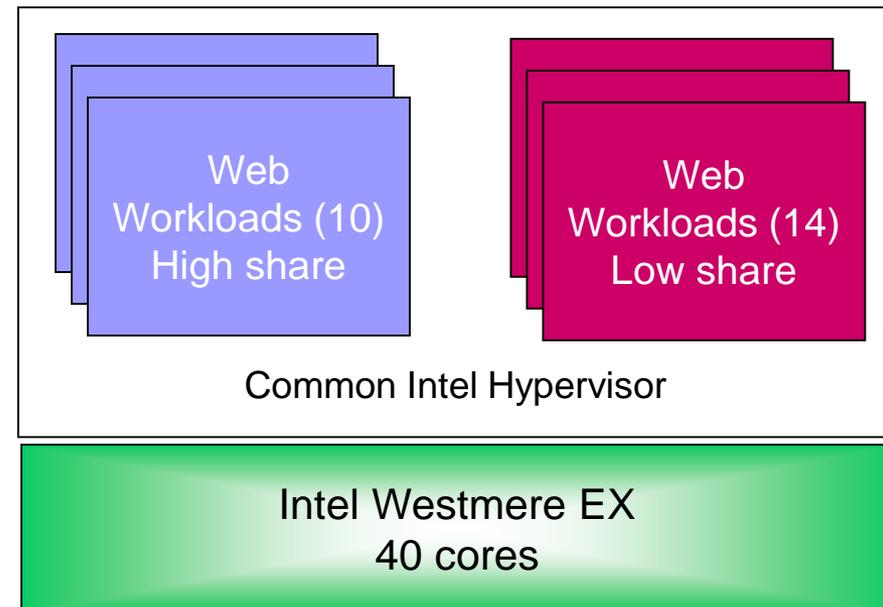
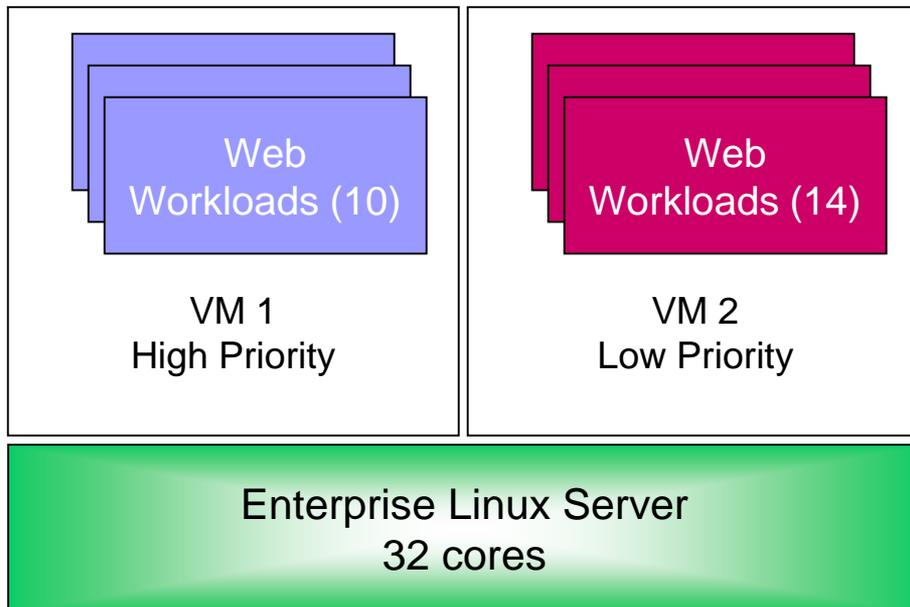

Enterprise Linux Server demonstrated perfect workload management and very high utilization

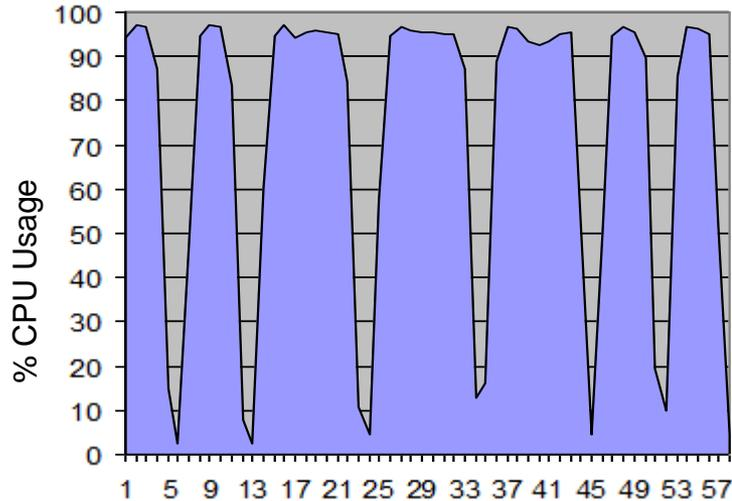

Demand curve for 10 high priority workloads running in VM 1

- **Workloads consume 72% of available CPU resources (28% unused)**
- **Total throughput: 9.13M**
- **Average response time: 140ms**

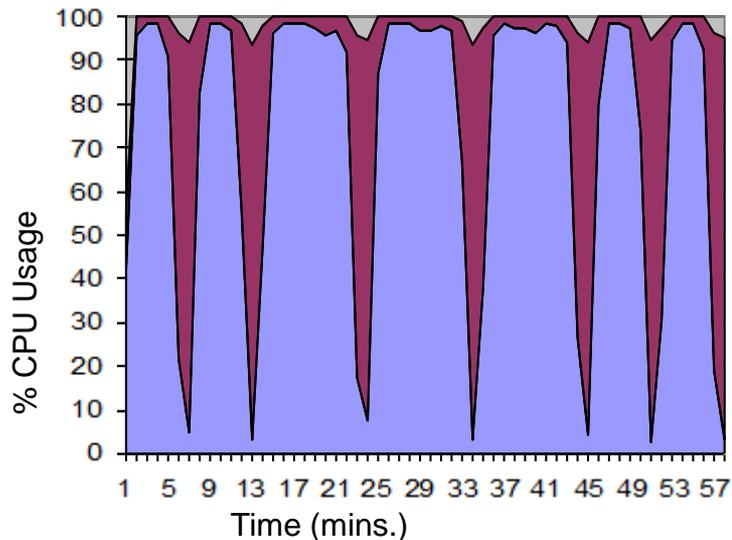

Demand curve when 14 low priority workloads are added in VM 2

- **All but 2% of available CPU resources is used (high=74%, low=24%)**
- **High priority workload throughput is maintained (9.13M)**
- **No response time degradation (140ms)**

Common x86 hypervisor could not manage high priority workloads correctly, and ran at much lower utilization rate

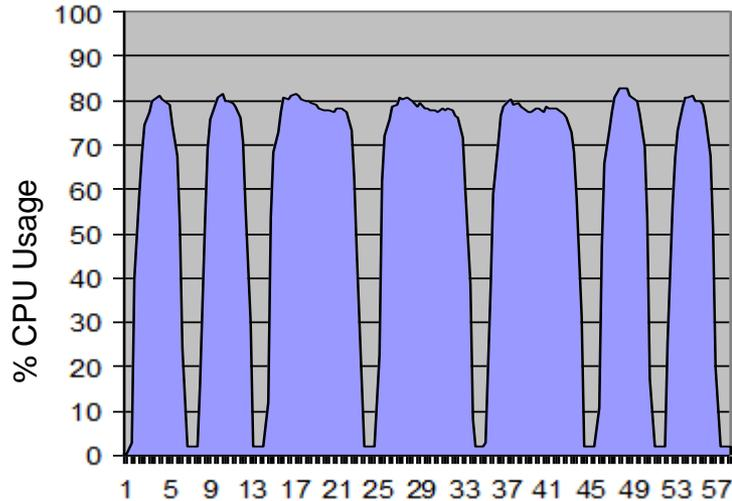

Demand curve for 10 high priority workloads running on a common Intel hypervisor (high share)

- **Workloads consume 58% of available CPU resources (42% unused)**
- **Total throughput: 6.47M**
- **Average response time: 153ms**

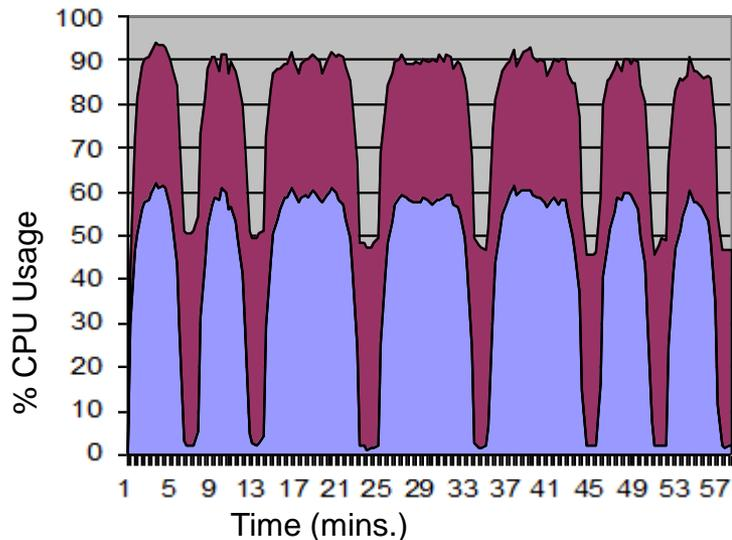

Demand curve when 14 low priority workloads are added (low share)

- **22% of available CPU resources is unused (high=42%, low=36%)**
- **High priority workload throughput drops 31% (4.48M)**
- **Response time degrades 45% (220ms)**

Enterprise Linux Server virtualization is much more efficient, and assures workload requirements are met

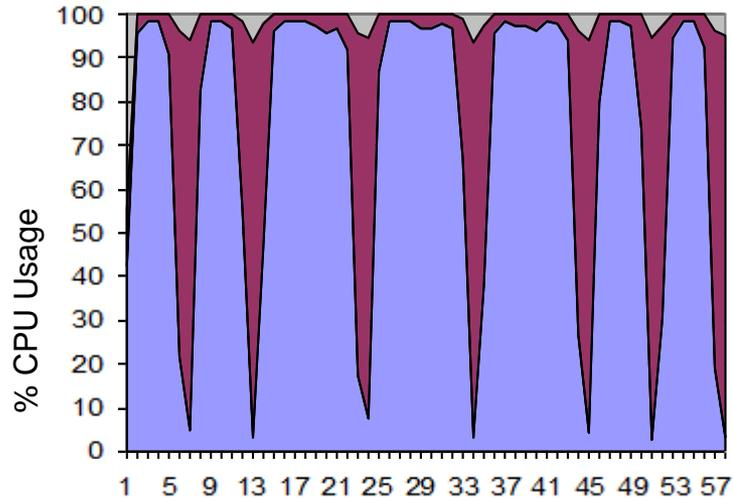

IBM Enterprise Linux Server

- Perfect workload management
- Consolidate workloads of different priorities on the same platform
- Full use of available processing resource (high utilization)

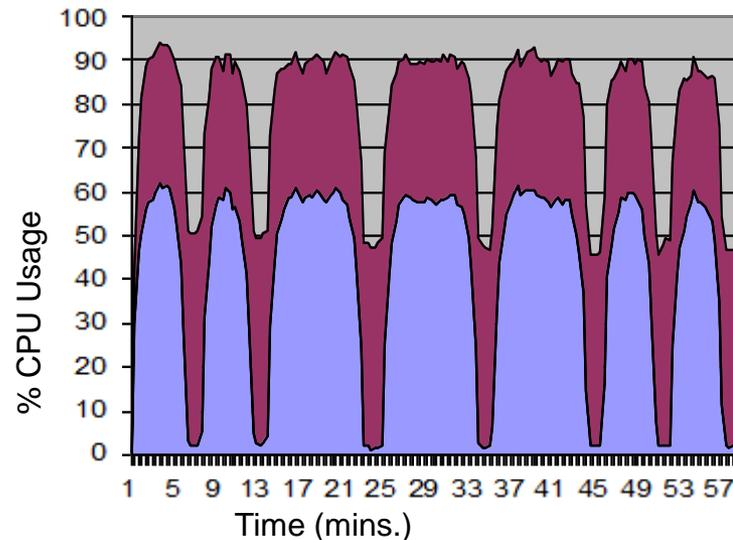

Common hypervisor on Intel

- Imperfect workload management
- *Forces workloads to be segregated on different servers*
- *More servers are required (low utilization)*

Result: Enterprise Linux Server easily manages mixed priority workloads at lower cost

Which platform provides the lowest TCA over 3 years?

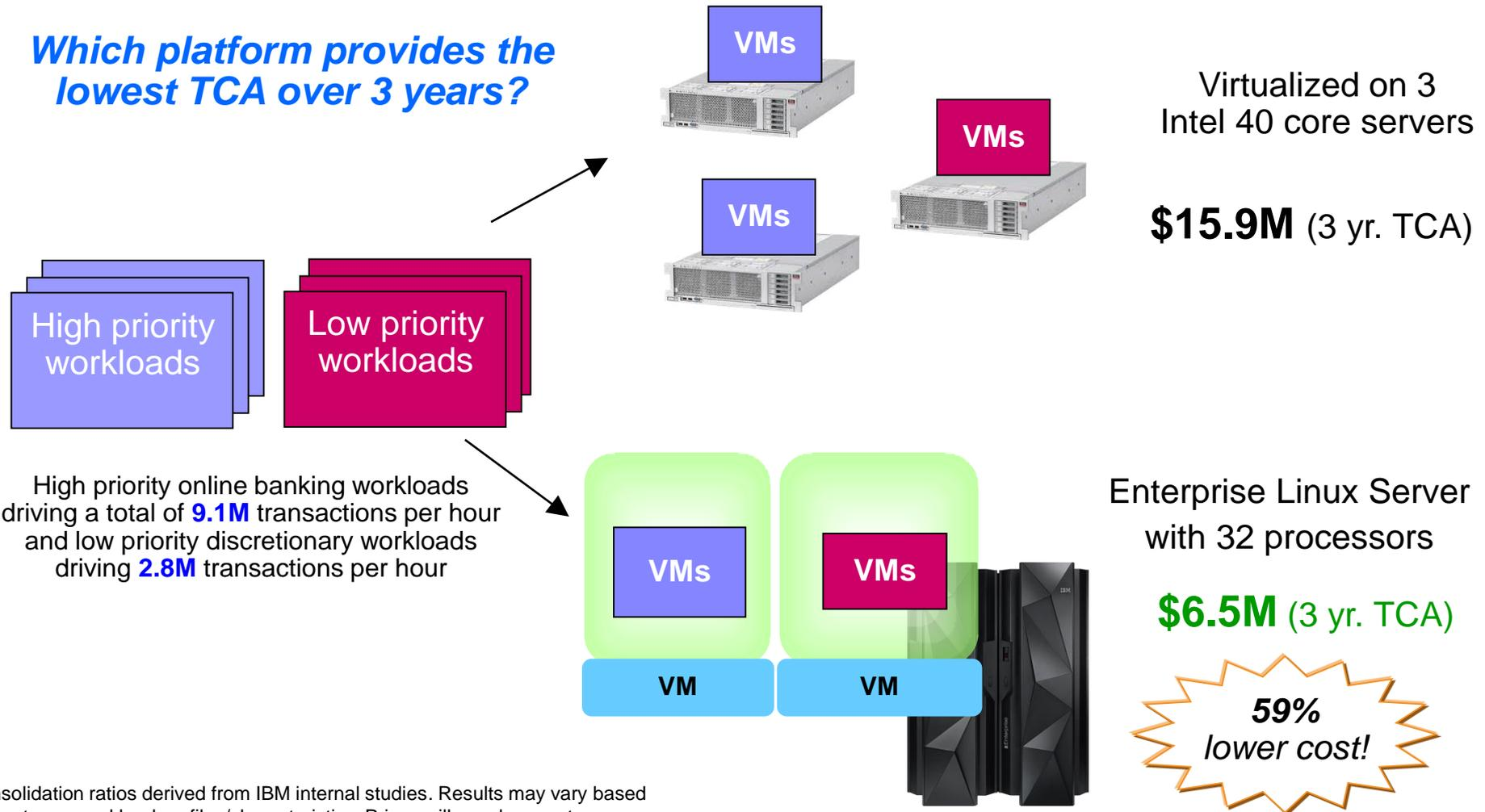

Consolidation ratios derived from IBM internal studies. Results may vary based on customer workload profiles/characteristics. Prices will vary by country.

When compared to other virtualization platforms, Enterprise Linux Server demonstrates real economies of scale

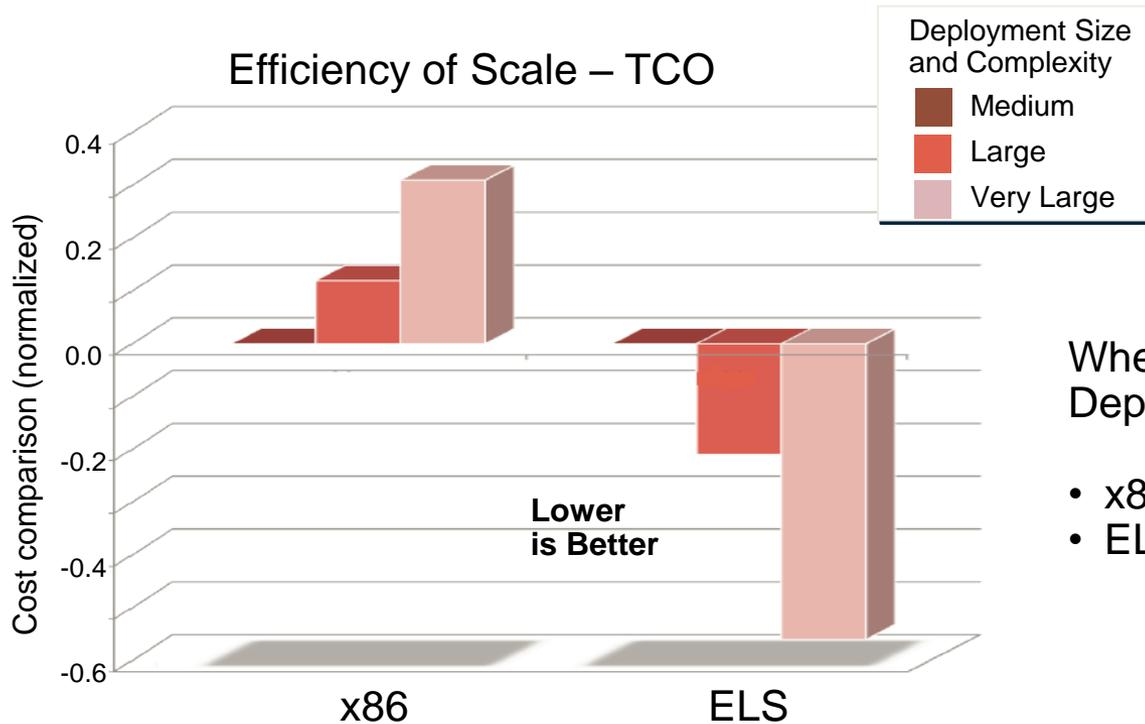

When going from Medium to Large Deployments:

- x86 - **1.35x increase** in cost per VM
- ELS - **68% reduction** in cost per VM

Better efficiency leads to savings of millions of dollars in deployment and operational costs

Better economies of scale leads directly to reduced administration staffing levels

Staffing levels required to maintain a “gold standard”:

- Normalized to VMWare in Medium environment
- Staffing levels for ELS was as much as **13x smaller**

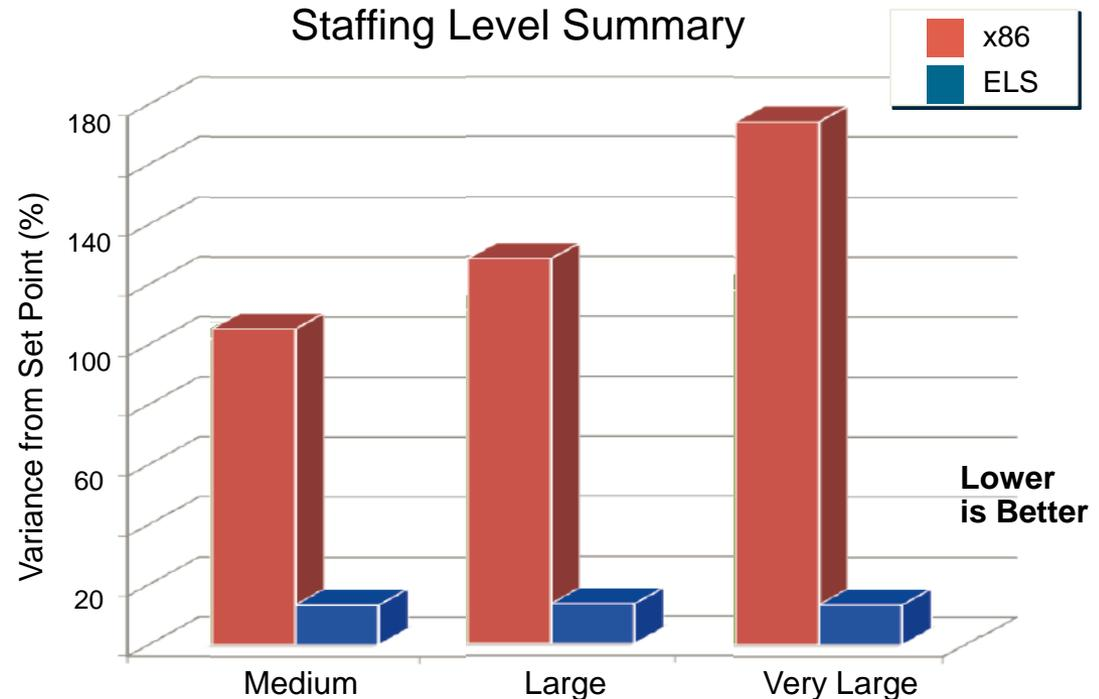

IBM Enterprise Linux Server has multi-system clustering and virtual server mobility

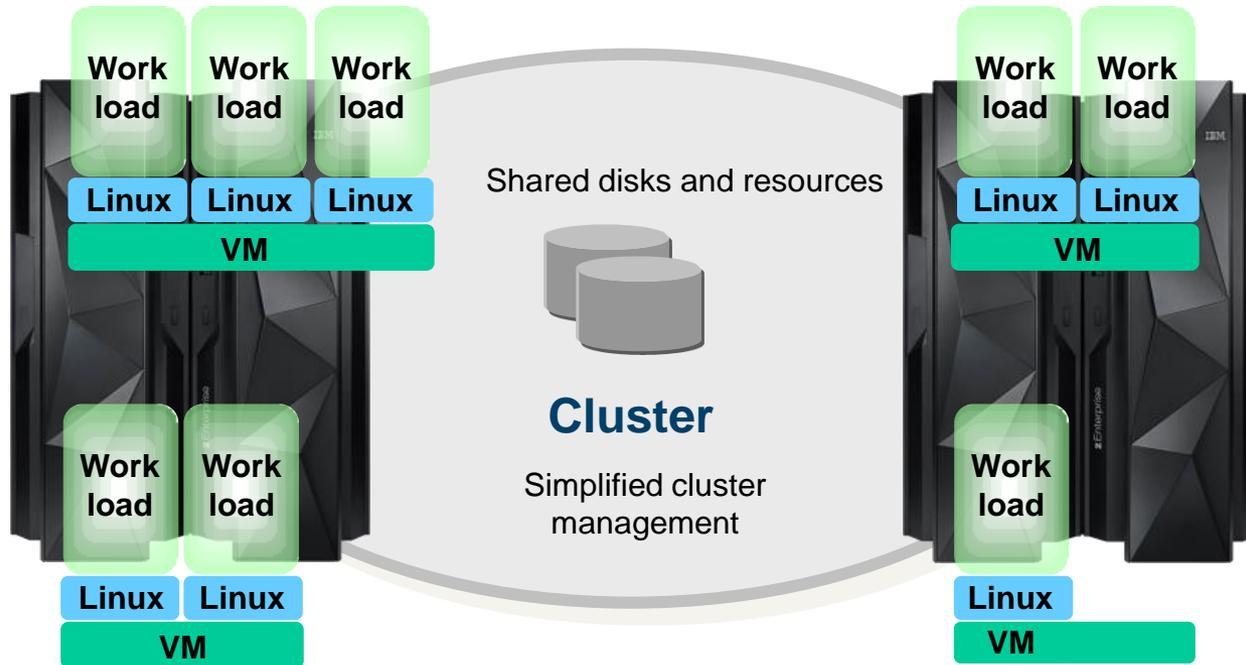

Clustering – Up to 4 VM instances can be clustered as a single system image; cluster members can be on the same or different physical servers

Live Guest Mobility – Move Linux virtual servers non-disruptively to another VM instance on the same or another physical server in the single system image

Manage the complete virtualized network using a simple, intuitive, rich graphical user interface

IBM-WAVE virtualization management software for Enterprise Linux Server systems

- Intuitive graphical workspace with powerful drag-and-drop capability
- Automatically detects all resources in the environment
 - Spans partitions, servers, sites, geographies
 - Supports SSI clustering and Live Guest Mobility
- Simplifies and automates management
 - Monitor, provision, manage user accounts
- **Significantly reduces administration requirements and costs**

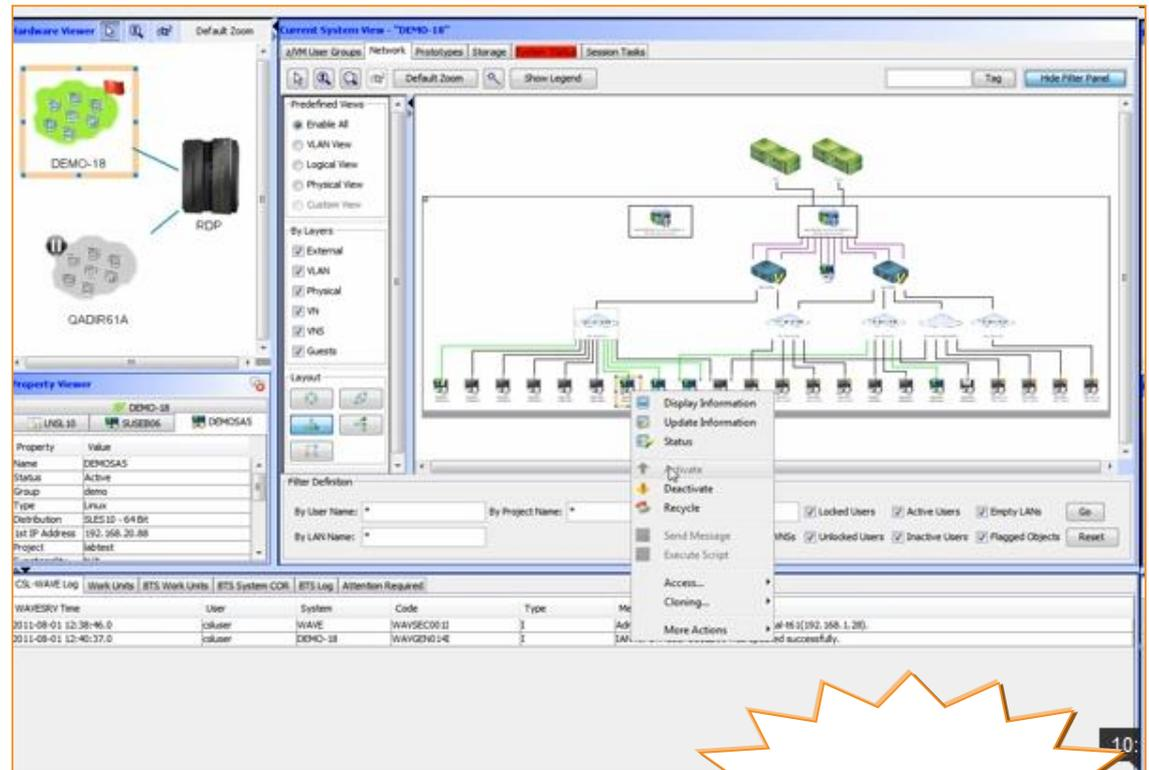

DEMO!

IBM-WAVE greatly simplifies management of the Enterprise Linux Server

Operation management example: Live Guest Migration

With IBM Wave:

- Graphical user interface
- Execute via menu selection

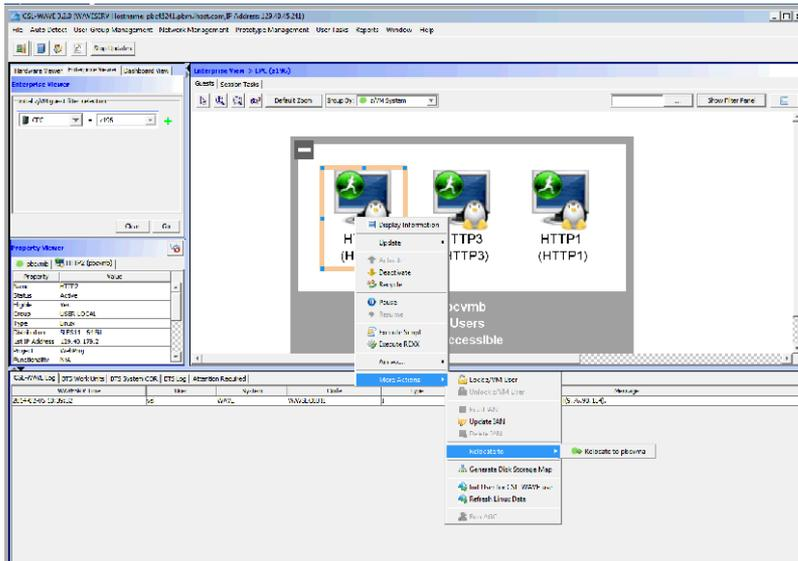

Using manual control program commands:

Task	Task Steps
Log into both VM instances	Login PBCVMA Login PBCVMB
Find out which instance has the running guest	q HTTP2 in PBCVMA q HTTP2 in PBCVMB
Verify the guest can be moved	vmrelo test HTTP2 to PBCVMB
Move the guest	vmrelo move HTTP2 to PBCVMB
Log out of both instances	Logoff PBCVMA Logoff PBCVMB

Enterprise Linux Server distributions supported

- Enterprise Linux Server supports both **Red Hat** and **SUSE** distributions
- Plentiful availability of skills administrators and developers
- Large selection of applications middleware and tooling from IBM, ISVs and Open Source

IBM has been collaborating on innovative Linux solutions for years

- IBM has been an active Linux community member since 1999
- IBM has over 600 full-time developers working with Linux and open source

Top 10 Linux Kernel Contributors (2013)

Company	Changes	Total
None	12,550	13.6%
Red Hat	9,483	10.2%
Intel	8,108	8.8%
Texas Instruments	3,814	4.1%
Linaro	3,791	4.1%
SUSE	3,212	3.5%
Unknown	3,032	3.3%
 IBM	2,858	3.1%
Samsung	2,415	2.6%
Google	2,255	2.4%
Vision Engraving Systems	2,107	2.3%
Consultants	1,529	1.7%
Wolfson Microelectronics	1,516	1.6%
Oracle	1,248	1.3%
Broadcom	1,205	1.3%



Virtually all IBM middleware runs on the Enterprise Linux Server

IBM Competitive Project Office



AIM / WebSphere (51)	IM (52)	SCI / Tivoli (57)	Industry Solutions (28)
<p>CICS Transaction Gateway Desktop Edition CICS Transaction Gateway for Multiplatforms Communications Server for Linux HTTP Server for WAS HE Novell SLES IBM Business Monitor IBM Business Process Manager Advanced IBM Business Process Manager Standard IBM Integration Bus IBM Mobile Foundation IBM Runtime Environment, Java Technology IBM Worklight TPF Toolkit WebSphere Adapter for Email WebSphere Adapter for ECM WebSphere Adapter for File Transfer Protocol WebSphere Adapter for Flat Files WebSphere Adapter for IBM i WebSphere Adapter for JDBC WebSphere Adapter for Lotus Domino WebSphere Adapter for Oracle E-Business WebSphere Adapter for PeopleSoft WebSphere Adapter for SAP Software WebSphere Adapter for Siebel Business WebSphere Adapters WebSphere Application Server WebSphere Application Server - Express WebSphere Application Server FP Web 2.0 WebSphere Application Server for Developers WebSphere Application Server Hypervisor WAS HE for Novell SLES on System z (2) WAS HE for Red Hat Enterprise Linux Server WAS HE Intelligent Management Pack WAS HE V7.0 on RHEL for System z (2) WebSphere Application Server Liberty Core WebSphere Application Server ND WebSphere Enterprise Service Bus WebSphere Extended Deployment WebSphere Extended Deployment CG WebSphere eXtreme Scale WebSphere Lombardi Edition WebSphere Message Broker WebSphere MB Connectivity for Healthcare WebSphere MQ, FTE, Low Latency (3) WebSphere Service Registry and Repository WebSphere SSR Advanced Lifecycle Edition WebSphere SSR Client WebSphere Virtual Enterprise</p>	<p>Cúram Social Program Management Database Enterprise Developer Edition DB2 Advanced Enterprise Server Edition DB2 Advanced Workgroup Server Edition DB2 Connect Application Server Advanced DB2 Connect Application Server Edition DB2 Connect Enterprise Edition DB2 Connect Unlimited Advanced z, I (3) DB2 Enterprise Server Edition DB2 for Linux, UNIX and Windows for SAP DB2 Merge Backup for Linux UNIX, Win DB2 Recovery Expert for Linux, UNIX, Win IBM Data Studio IBM InfoSphere Business Info. Exchange IBM InfoSphere Foundation Tools IBM InfoSphere Identity Insight IBM InfoSphere QualityStage Module US Cert IBM Metadata Workbench IBM solidDB Information Server Bus. Glossary Anywhere Informix Client Software Development Kit Informix Connect Runtime Informix Dynamic Server Enterprise Edition InfoSphere Business Glossary InfoSphere Change Data Capture InfoSphere Change Data Delivery InfoSphere Data Replication InfoSphere Federation Server InfoSphere Guardian InfoSphere Information Analyzer InfoSphere Information Server, SAP (2) InfoSphere Master Data Management InfoSphere Master Data Management Server InfoSphere Optim Configuration Manager InfoSphere Optim Performance Manager (2) InfoSphere Optim pureQuery Runtime z/OS InfoSphere Optim Query Capture and Replay InfoSphere Warehouse Advanced Depart. InfoSphere Warehouse Advanced Enterprise InfoSphere Warehouse Departmental Edition InfoSphere Warehouse Developer Edition InfoSphere Warehouse Enterprise Base InfoSphere Warehouse Enterprise Edition InfoSphere Warehouse Optim Data Retention Optim High Performance Unload for DB2 Optim Performance Manager (2) Optim Query Tuner for DB2</p>	<p>IBM License Metric Tool IBM SmartCloud Control Desk IBM SmartCloud Cost Management IBM TRIRIGA Application Builder IBM TRIRIGA Application Platform IBM TRIRIGA Connector Business Apps (2) IBM TRIRIGA Connector for Offline Forms Maximo Adapter for Microsoft Project Maximo Adapter for Primavera Maximo Archiving Adapter for Optim Data Gr. Maximo Asset Configuration Manager Maximo Asset Mgmt, Essentials, Schedule (3) Maximo Calibration Maximo Change and Corrective Action Mgr Maximo Enterprise Adapter, SAP (2) Maximo Everyplace Maximo for Government Maximo for Life Sciences Maximo for Nuclear Power Maximo for Oil and Gas Maximo for Service Providers Maximo for Transportation Maximo for Utilities Maximo Health, Safety and Environment Mgr Maximo Linear Asset Manager Maximo Mobile Asset Manager Maximo Mobile Inventory Manager Maximo Mobile Suite Maximo Mobile Work Manager Maximo Spatial Asset Management Tivoli Application Dependency Discovery Mgr Tivoli Asset Discovery for Distributed Tivoli Business Service Manager Tivoli Monitoring, Energy Mgmt, VE (3) Tivoli Netcool/Impact Tivoli Netcool/OMNibus Tivoli NetView for z/OS Tivoli Network Manager IP Edition Tivoli Provisioning Manager Tivoli Service Automation Manager Tivoli Storage Productivity Center Editions (3) Tivoli System Automation Application Mgr Tivoli System Automation for Multiplatforms Tivoli Usage and Accounting Manager, Ent (2) Tivoli Workload Scheduler, z/OS, Agent (3) TotalStorage SAN Volume Controller</p>	<p>Case Foundation Case Manager Content Analytics Content Foundation Content Integrator Enterprise Edition Content Manager Enterprise Edition Content Manager OnDemand Multiplatforms Cúram Social Program Management Enterprise Records FileNet Business Process Manager FileNet Content Manager IBM WebSphere Multichannel Bank Toolkit Sterling B2B Integrator Sterling Connect:Direct Sterling Connect:Express Sterling Control Center WebSphere Commerce Enterprise WebSphere Multichannel Bank Toolkit WebSphere Transformation Extender WebSphere Transformation Extender SEPA WebSphere Transformation Extender SAP WebSphere Transformation Extender SWIFT WebSphere Transformation Extender EDI WebSphere Transformation Ext. Financial WebSphere Transformation Ext. Healthcare WebSphere Transformation Ext. NACHA</p>
			<p>Rational (19)</p> <p>Rational Asset Manager Enterprise Edition Rational Asset Manager Standard Edition Rational Automation Framework Rational Build Forge Rational Build Forge Enterprise Edition Rational Build Forge Enterprise Plus Edition Rational Build Forge Standard Edition Rational ClearCase Rational ClearCase MultiSite Rational Collaborative Lifecycle Management Rational Developer for System z Rational Developer for zEnterprise Rational DOORS Rational Host Access Transformation Service Rational Programming Patterns Rational Programming Patterns for System z Rational Quality Manager Rational Requirements Composer Rational Team Concert</p>
<p>ICS / Portal (15)</p> <p>IBM Connections IBM Connections Mail IBM Customer Experience Suite Rich Media IBM Domino IBM Forms Experience Builder IBM Forms Server IBM Mobile Portal Accelerator IBM Web Content Manager, Rich Media (2) IBM Web Experience Factory Lotus Domino WebSphere Dashboard Framework WebSphere Portal Enable, Extend, Server (3)</p>	<p>BA (15)</p> <p>Cognos Business Insight Cognos Business Intelligence & Analysis Cognos Insight Cognos Mobile Cognos Real-time Monitoring IBM SPSS License Authorization Wizard IBM SPSS Modeler Limited SPSS Collaboration and Deployment Services SPSS Decision Management SPSS Modeler & Server (2) SPSS Statistics & Server (2)</p>	<p>Security (7)</p> <p>IBM Security Access Manager for Web IBM Security Identity Manager Tivoli Access Manager for e-business Tivoli Directory Integrator Tivoli Federated Identity Manager Tivoli Federated Identity Mgr Bus. Gateway Tivoli Key Lifecycle Manager</p>	<p>Source: IBM Clearinghouse Last Updated: 9/11/13</p>

The ISV ecosystem for the Enterprise Linux server is strong and continues to grow



Over 3,000 total Linux applications available from hundreds of ISVs

The IBM Enterprise Linux Server is designed for high availability and redundancy

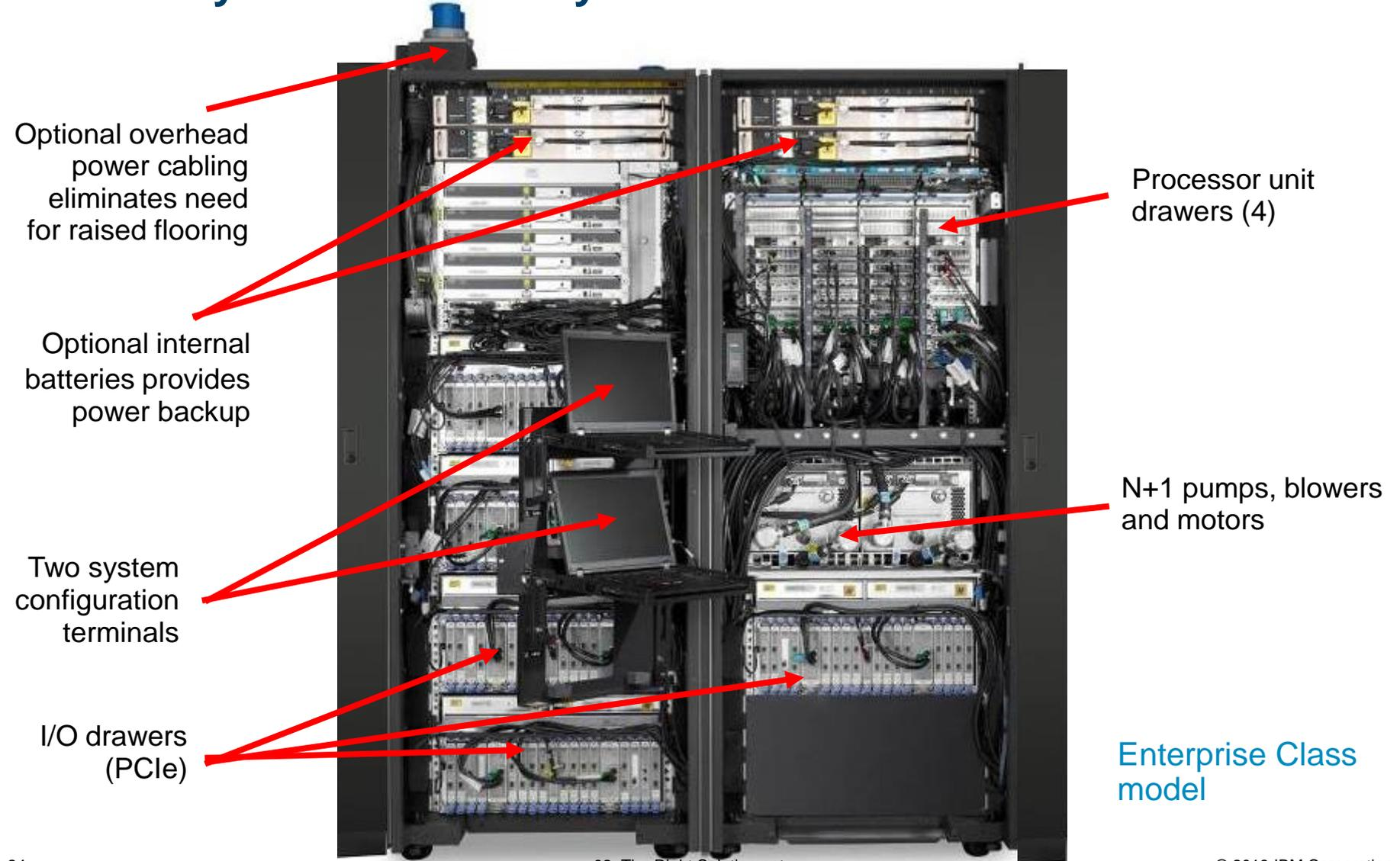

Optional overhead power cabling eliminates need for raised flooring

Optional internal batteries provides power backup

Two system configuration terminals

I/O drawers (PCIe)

Processor unit drawers (4)

N+1 pumps, blowers and motors

Enterprise Class model

Mid-sized businesses may prefer the business class model



1 of the 10
"coolest" servers
of 2013
(CRN)

Business Class
model



Processor unit
drawers (2)

Two system
configuration
terminals

PCIe I/O
drawers

Blade-like processing unit drawers support a balanced, pluggable technology

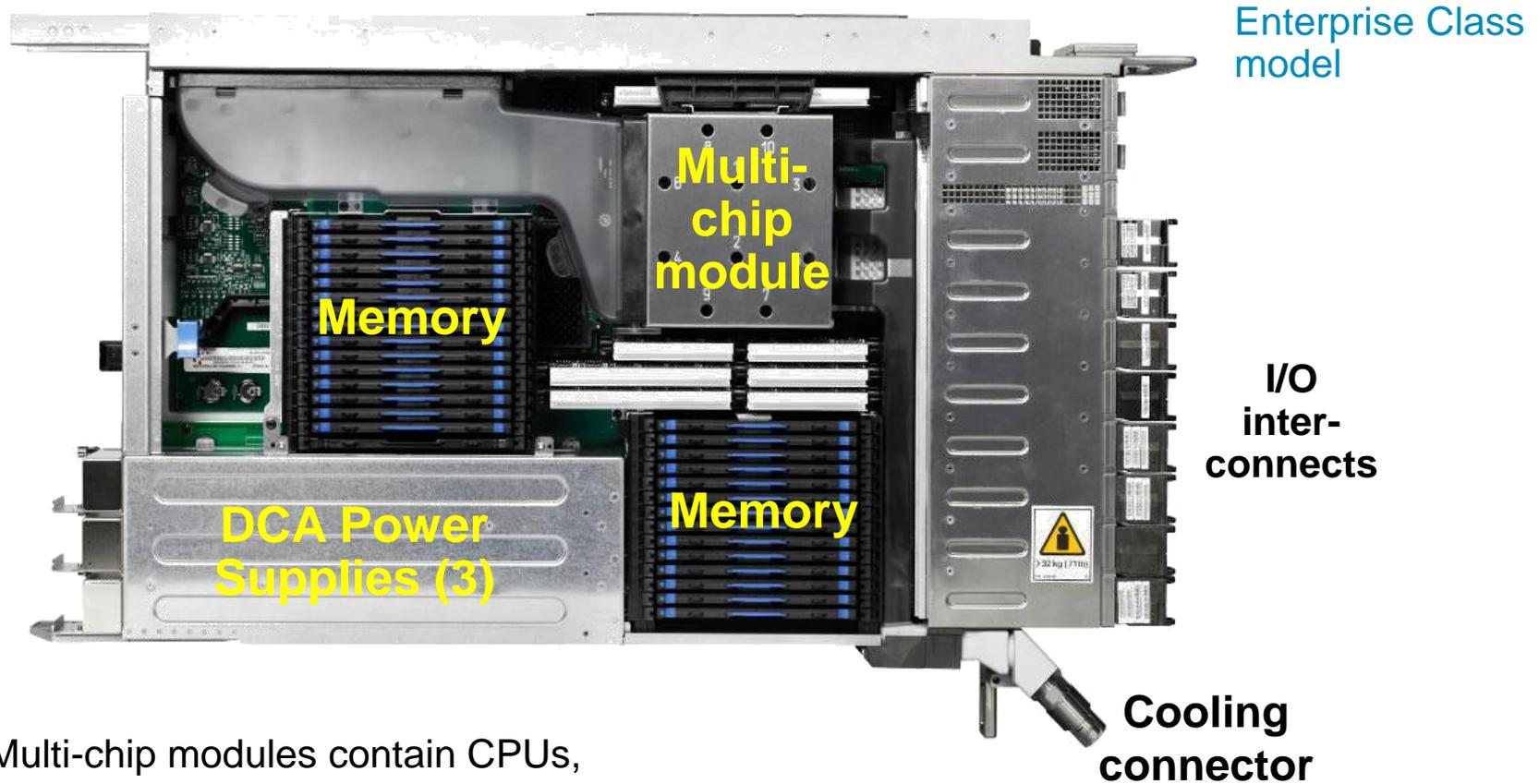

- Multi-chip modules contain CPUs, co-processors, memory controllers and cache
- Drawers support concurrent maintenance

Enterprise Linux Server yields exceptional processing power from highly advanced processing unit chips

- Enterprise Class model
 - 5.5 GHz clock speed
 - *Fastest commercially available!*
 - 6 to 101 Linux processors total
 - Across 6 chips
 - 32 GB RAIM memory per core
- Business Class model
 - 4.4 GHz clock speed
 - 2 to 13 Linux processors
 - Across 3 chips
 - 28 GB RAIM memory per core
- Superscalar design, with advanced pipelining and out-of-order processing
- Each processor has dedicated cryptographic and compression coprocessors

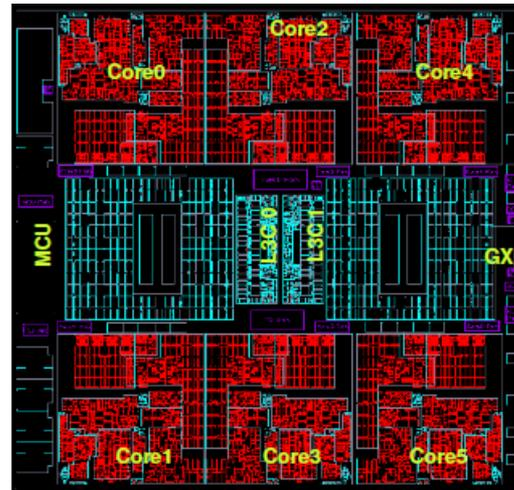

Enterprise Linux Server
Processing Unit chip

Intel x86 chip

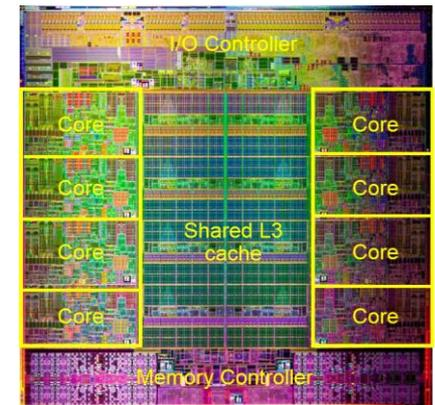

- Typical servers have 3.0-3.3 GHz and 8-24 cores
- Max: 3.8 GHz or 64 cores

Pay only for the number of processors needed – use Capacity on Demand for additional processing power when needed

- Servers are shipped fully populated
 - Customers purchase (activate) only the number of processors desired
- Customers can also purchase “inactive” processors at reduced price (Capacity on Demand)
 - Activate only as needed
 - Use for temporary or permanent capacity
 - Self-managed on/off
- New capacity is immediately available for work without service disruption

Enterprise Linux Server with 36 processors

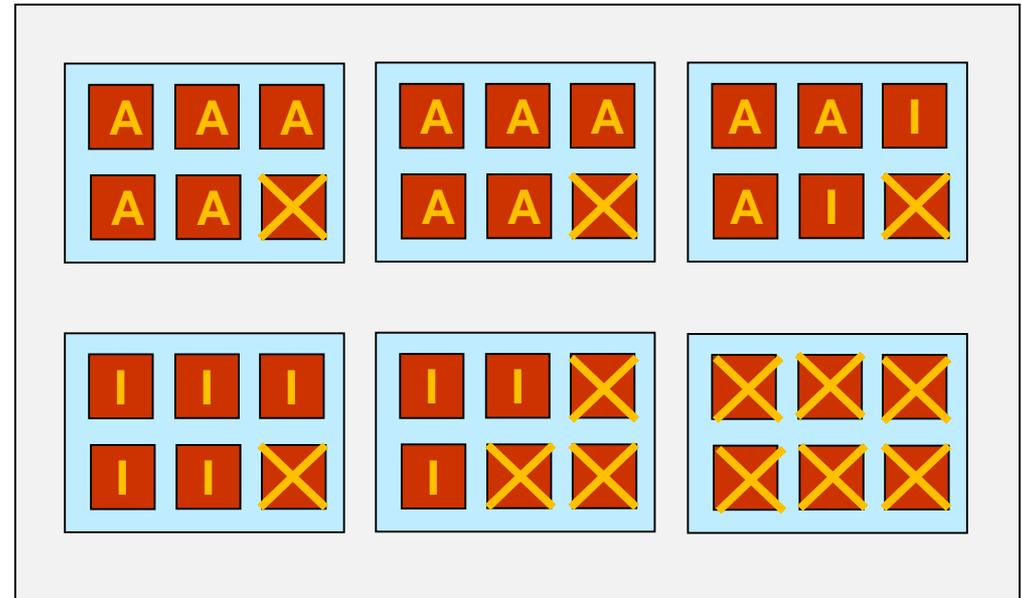

-  Active processors (13) – pay standard price
-  Inactive processors (10) – pay only 2% of full price
-  Dark processors (13) – no charge

Enterprise Linux Server includes optimized cache structure, designed to support large data sets

Enterprise Linux Server
Processing Unit chip with 6 Linux cores

Total
L1 Cache
per chip =
960KB

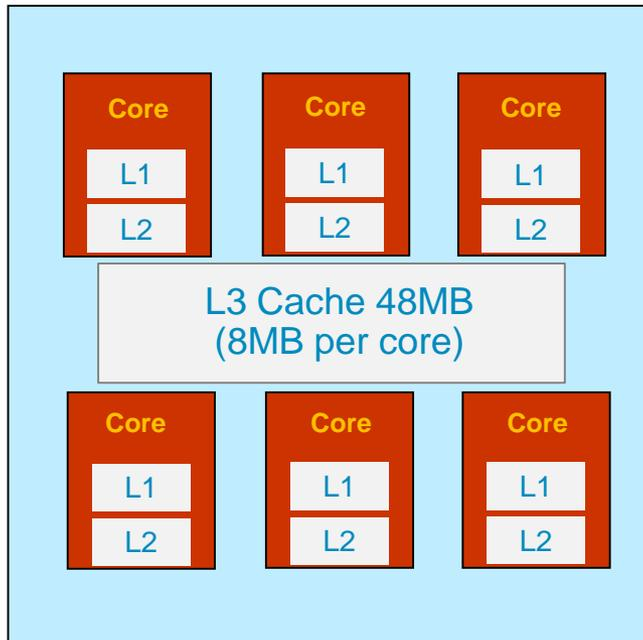

Total
L2 Cache
per chip =
12MB

Intel Sandy Bridge x86 chip with 8 cores

Total
L1 Cache
per chip =
512KB

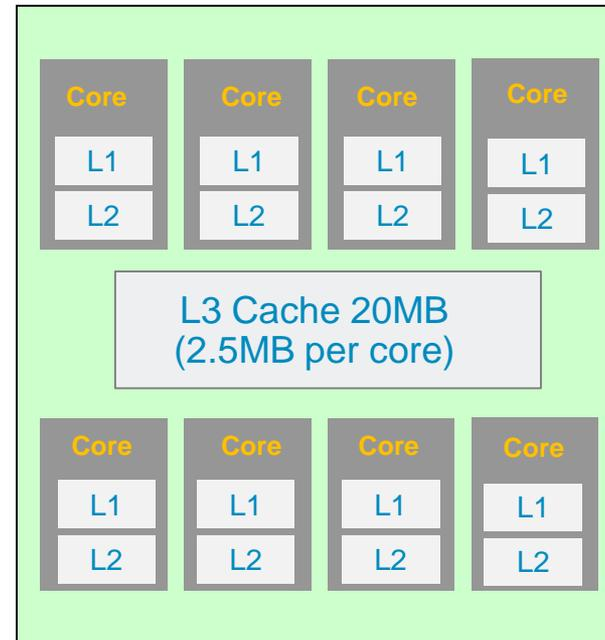

Total
L2 Cache
per chip =
2MB

Enterprise Linux
Server Storage
Control chip

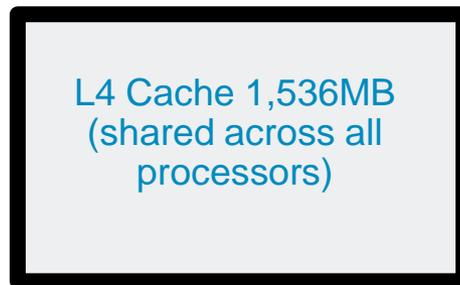

Enterprise Linux server can be configured to support either DASD or SCSI storage



Tests demonstrate how ELS with DASD storage can be the right option for certain workloads

- Tests confirm:
DASD option required less CPU than FCP to drive the same amount of workload

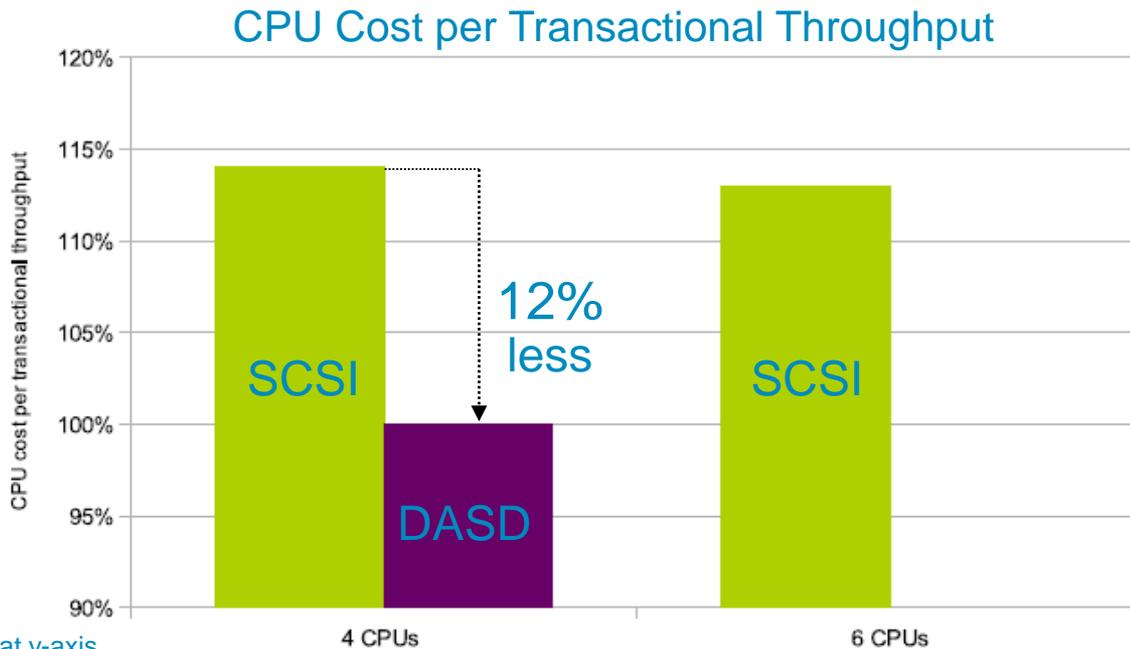

- SCSI yields higher performance, but requires additional CPU to drive the workload
- DASD makes sense when workloads have high I/O, and CPU costs must be kept low

Note that y-axis starts at 90%

Source: <http://pic.dhe.ibm.com/infocenter/lnxinfo/v3r0m0/topic/lnaag/l0orac00.pdf>

With DASD storage, special processors are dedicated to driving I/O

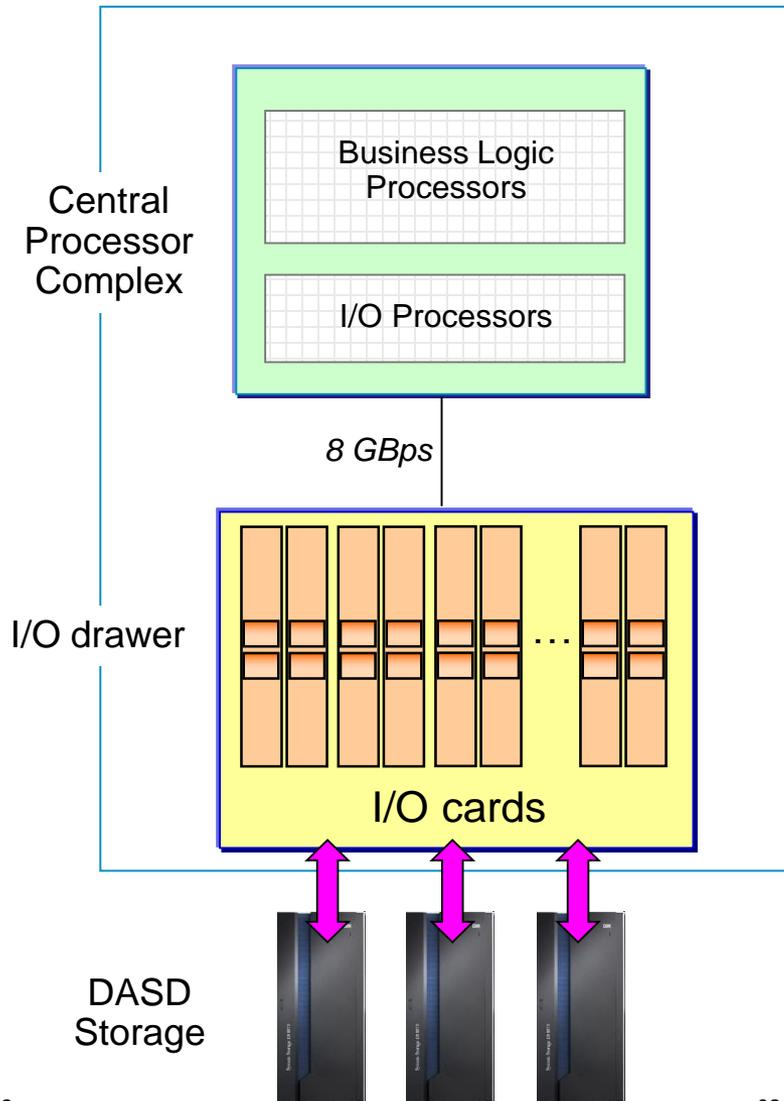

- I/O processing logic is offloaded to special processors
 - Isolates main Linux processor for business logic processing
- I/O processors managed Logical I/O Channel Subsystem
 - Determines optimal physical I/O path to be used
 - Delivers optimized I/O efficiency
- Dedicated I/O subsystem is excellent for high I/O workloads
- Intel servers have no dedicated I/O subsystem

In comparison tests of I/O load capacity, Intel times were significantly slower

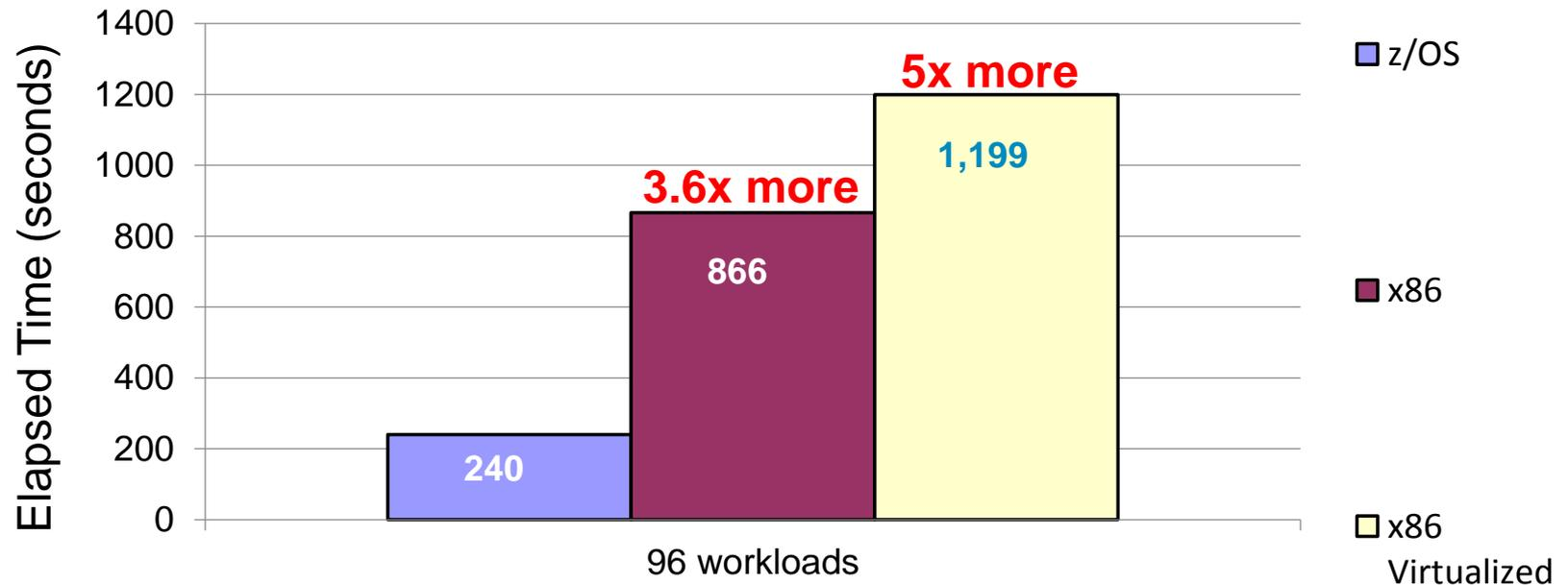

Performance comparison test of an I/O intensive workload with identical enterprise class storage. Enterprise Linux Server EC model with **8** core. Westmere EX server with **40** core @2.4GHz. Each system connected via 4 x 8Gb links to DS8800. Enterprise Linux Server running against 8 SSD DASD CKD volumes. Intel server running against 8 SSD LUNs FB volumes. Note: Storage limitations came into effect at workload counts greater than 96.

Workloads with higher I/O bandwidth requirements benefit from Enterprise Linux Server architecture

Which platform provides the lowest TCA over 3 years?

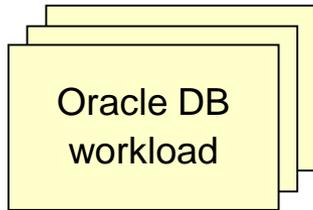

Customer Database Workloads
each supporting 4K TPS

Oracle Enterprise Edition
Oracle Real Application Cluster

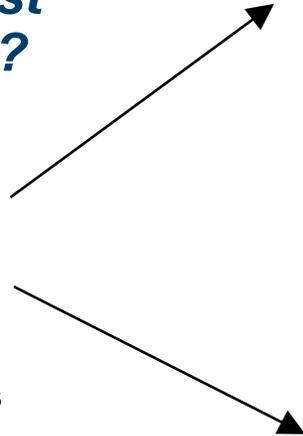

T5-8 server
(128 cores)

3 x 4-node Oracle RAC DB

\$8.9M (3 yr. TCA)



ELS with 16 IFLs

3 x 4-node Oracle RAC DB

\$3.6M (3 yr. TCA)



TCA includes hardware, software, maintenance, support and subscription. Workload Equivalence derived from a proof-of-concept study conducted at a large Cooperative Bank and projecting to T5-8 servers using published TPC-C Results normalizing them to Relative Performance Units as available from Ideas International

Trusted reliability – comprehensive protection to ensure highest availability

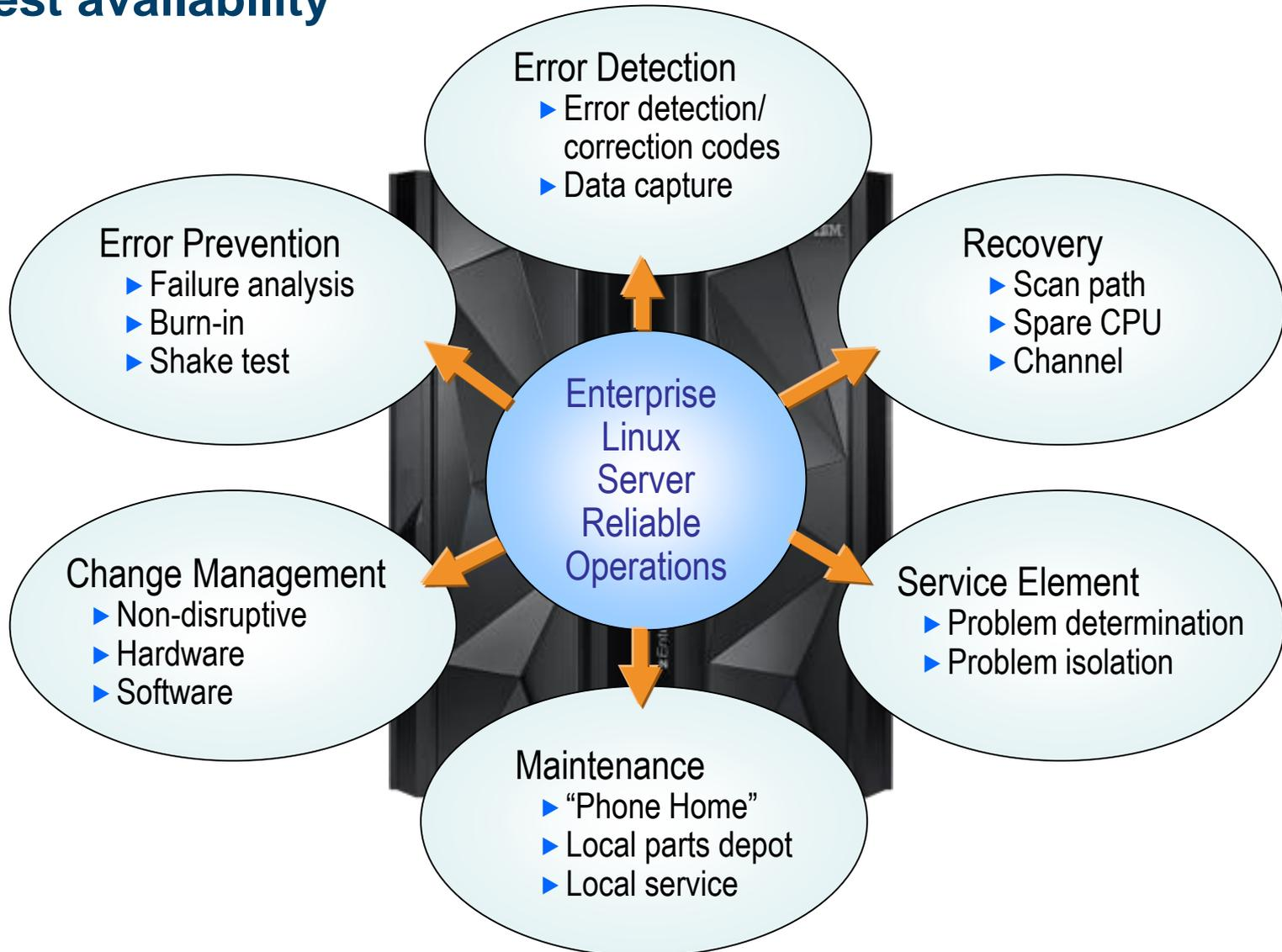

IBM Enterprise Linux Server supports concurrent operations during maintenance

Capability	ELS	x86
ECC on Memory Control Circuitry	Transparent While Running	Can recognize/repair soft errors while running; limited ability with hard errors
Oscillator Failure	Transparent While Running	Must bring server down to replace
Core Sparing	Transparent While Running	Must bring server down to replace
Microcode Driver Updates	While Running	Some OS-level drivers can update while running, not firmware drivers; reboot often required
Book Additions, Replacement	While Running	Must bring server down
Memory Replacement	While Running	Must bring server down
Memory Bus Adaptor Replacement	While Running	Must bring server down
I/O Upgrades	While Running	Must bring server down to replace (limited ability to replace I/O in some servers)
Concurrent Driver Maintenance	While Running	Limited – some drivers replaceable while running
Redundant Service Element	2 per System	“Support processors” can act as poor man’s SE, but no redundancy

Single book systems may not support concurrent memory upgrades

Ultimate security is a key feature of the Enterprise Linux Server

- Tight authentication and access control surround VM resources
- Virtualization architecture rated at one of the highest Common Criteria EAL ratings (5+)
 - By comparison, VMWare ESXi 5.0 rated at 4+

- Independent study shows security incursion rates are lowest on Enterprise Linux Server compared to x86 and Unix servers

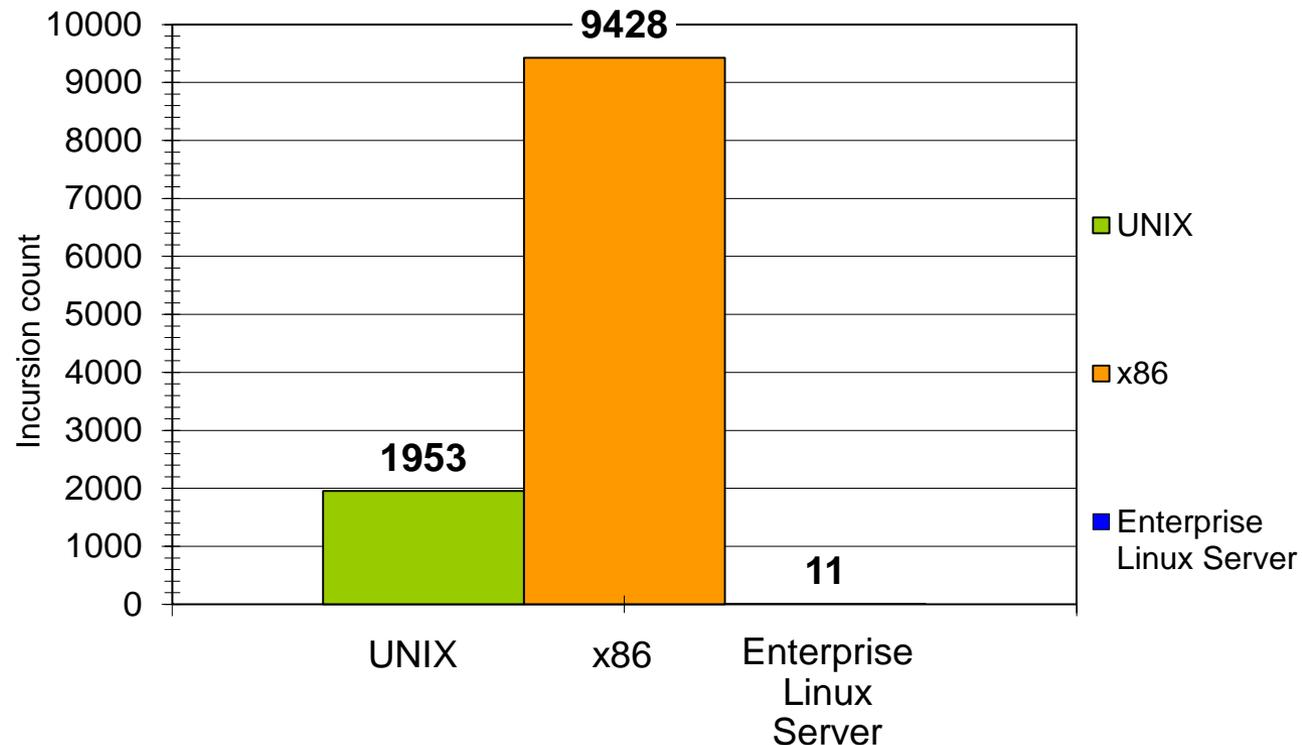

Independent studies show how ELS security is superior to other platforms, and augmentation costs less

Security Natively Covered by Platform

Security Level Description	IBM Enterprise Linux Server	x86	Competitive UNIX
Normal corporate	100.00%	18.16%	30.26%
Credit card processing involved	99.00%	11.04%	18.28%
Banking	94.00%	5.26%	10.22%
Healthcare	100.00%	3.24%	8.51%
Research	92.50%	2.86%	4.16%
Defense	85.54%	0.26%	1.86%

- On System z, most security requirements are standard
- Major security deficiencies exist on distributed platforms

Incremental Cost to Achieve Required Security

- Distributed platforms require considerable additional expense to achieve required security levels

Security Level Description	IBM Enterprise Linux Server	x86	Competitive UNIX
Normal corporate	0.00%	32.54%	12.37%
Credit card processing involved	2.32%	46.27%	29.53%
Banking	2.07%	51.31%	26.58%
Healthcare	0.00%	67.26%	35.89%
Research	4.28%	91.26%	64.28%
Defense	11.36%	125.41%	102.26%

Summary – Advantages of Enterprise Linux Server over distributed server farms

- Exceptional virtualization – complete workload isolation and perfect workload management
- World's fast CPU clock rates, with no overcommit of resources – nearly 100% utilization nearly all the time
- Designed for superior reliability, highest availability, and ultimate security
- Low total cost of ownership – reduced costs for software licenses, networking, real estate, power and administration

