

The New zEnterprise – A Cost-Busting Platform

System z is Optimized for Critical Data Workloads



Agenda

60 minutes	System z is Optimized for Critical Data Workloads
60 minutes	World's Fastest Analytics
15 minutes	<i>Break</i>
60 minutes	Smarter Solution Delivery on System z
60 minutes	<i>Lunch</i>
50 minutes	Reduce Costs with a System z Private Cloud
40 minutes	Security on System z – Inspector "z" and The Case of the Web Intrusion
15 minutes	<i>Break</i>
45 minutes	TCO Lessons Learned, Part 1 – Establishing Equivalence
45 minutes	TCO Lessons Learned, Part 2 – Discovering Total Costs
	<i>Close</i>

DEMO: Architecture

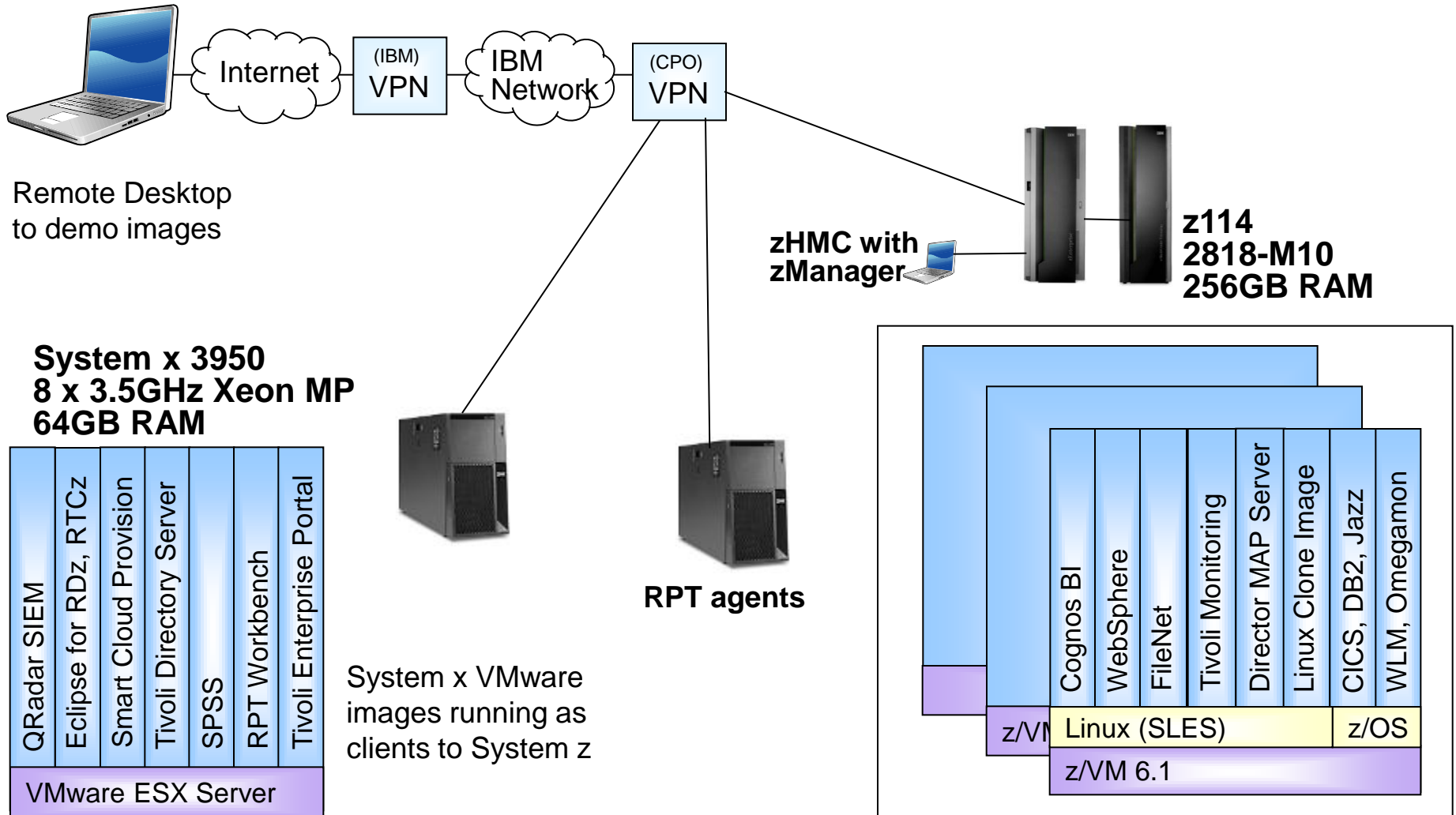

Businesses trust their most mission-critical applications and data to the mainframe

85%

of business transactions are processed on a mainframe

24 of top 25

US retailers use DB2

70%

of top 500 System z customers run CICS

96%

of top 500 System z customers who run CICS also run DB2



Today

IBM zEC12

1964



IBM S/360

97 of top 100 world's banks use System z

Today, businesses face new challenges in the way information is accessed, applied and architected

90%

of the world's data has been created in the last two years

Big Data & Analytics

\$241B

investment in cloud computing by 2020 (22% growth)

Cloud

96%

year to year increase in mobile cyber Monday sales between 2011 and 2012

Mobile

51%

of projects are over budget and often lack critical features

DevOps

\$5.4M

cost per incident (on average) for a security breach

Security

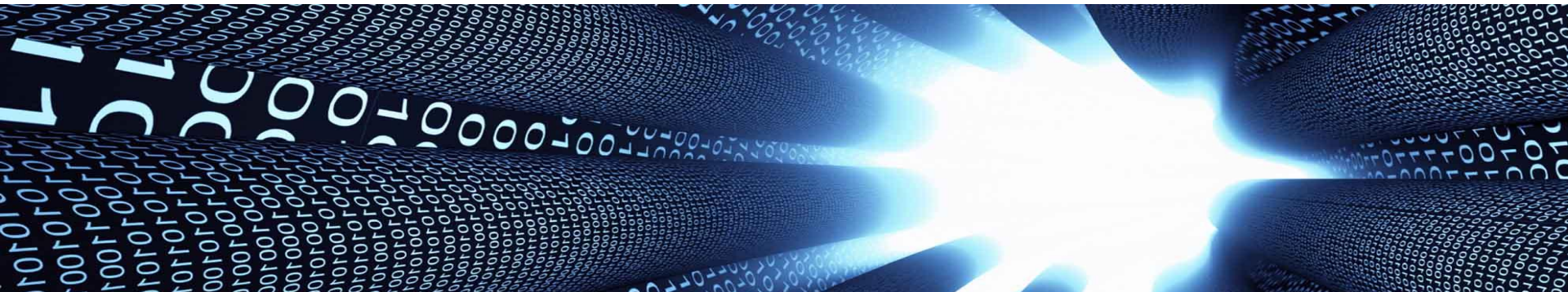

With the introduction of its newest business class mainframe, IBM is leading the way for enterprises of all sizes



IBM zEnterprise EC12



IBM zEnterprise BC12



An integrated platform for Data & Analytics



An efficient foundation for Cloud Computing



Sophisticated for Mobile Computing

Still the best platform for critical data and transaction workloads!



Provides the ultimate in Trusted Security & Resiliency

Only System z can provide state-of-the-art global scale transaction processing capability of this magnitude

- 1B CICS trans/day
- 4,000 IMS trans/sec
- 14M ACH transactions in 2.5 hours
- 6-way sysplex
 - 30ms response
 - 216 engines at primary site
 - 200K MIPS

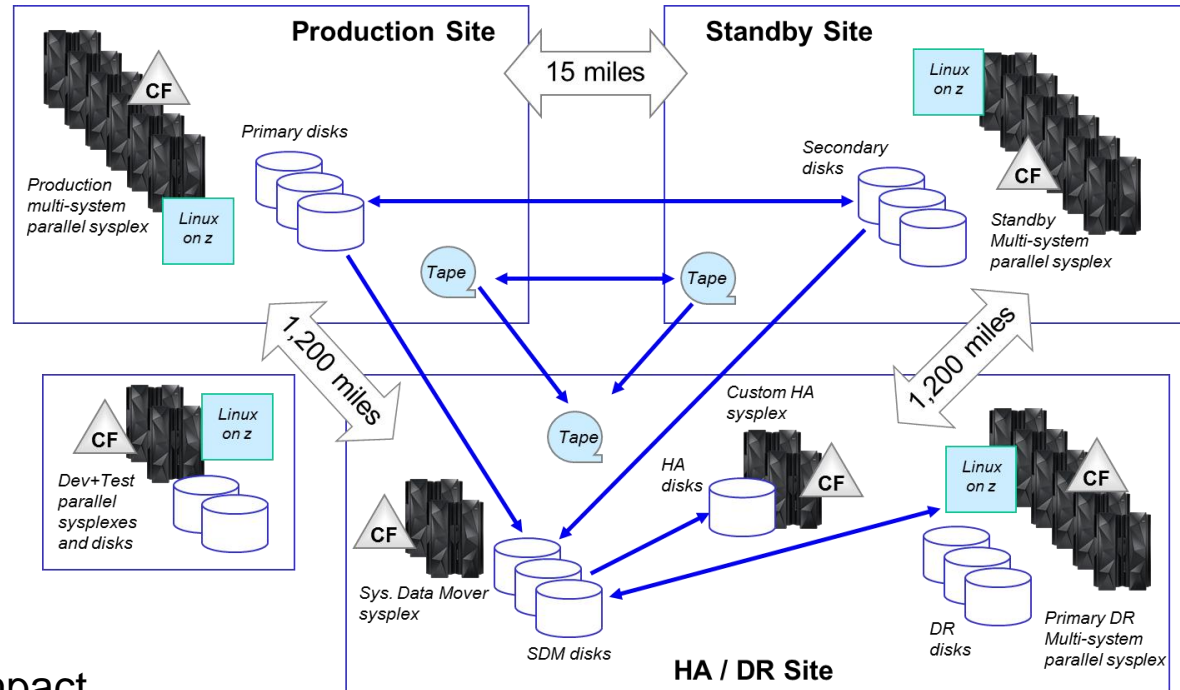

- Zero outages, zero customer impact
- Linux is Active-Active in the two data centers, with zero downtime
 - 15% Linux, growing at 30% p.a.
- *“Crazy about security overall, and the z system has a fortress around it”*

Both zEC12 and zBC12 are designed to support today's business challenges

- Concentrated processing power in a single complex
- Cache structures optimized for larger working sets
- Dedicated I/O sub-system with large I/O bandwidth
- DS8000 storage systems capacity and performance
- Hardware data compression accelerator to reduce CPU and storage **NEW**
- High-speed, transparent server to server networking **NEW**
- “Perfect” workload management
- Industry-leading RAS and security
- DB2 Analytics Accelerator to facilitate co-located analytics

Unbeatable performance with best economics



A closer look inside the zBC12 box...

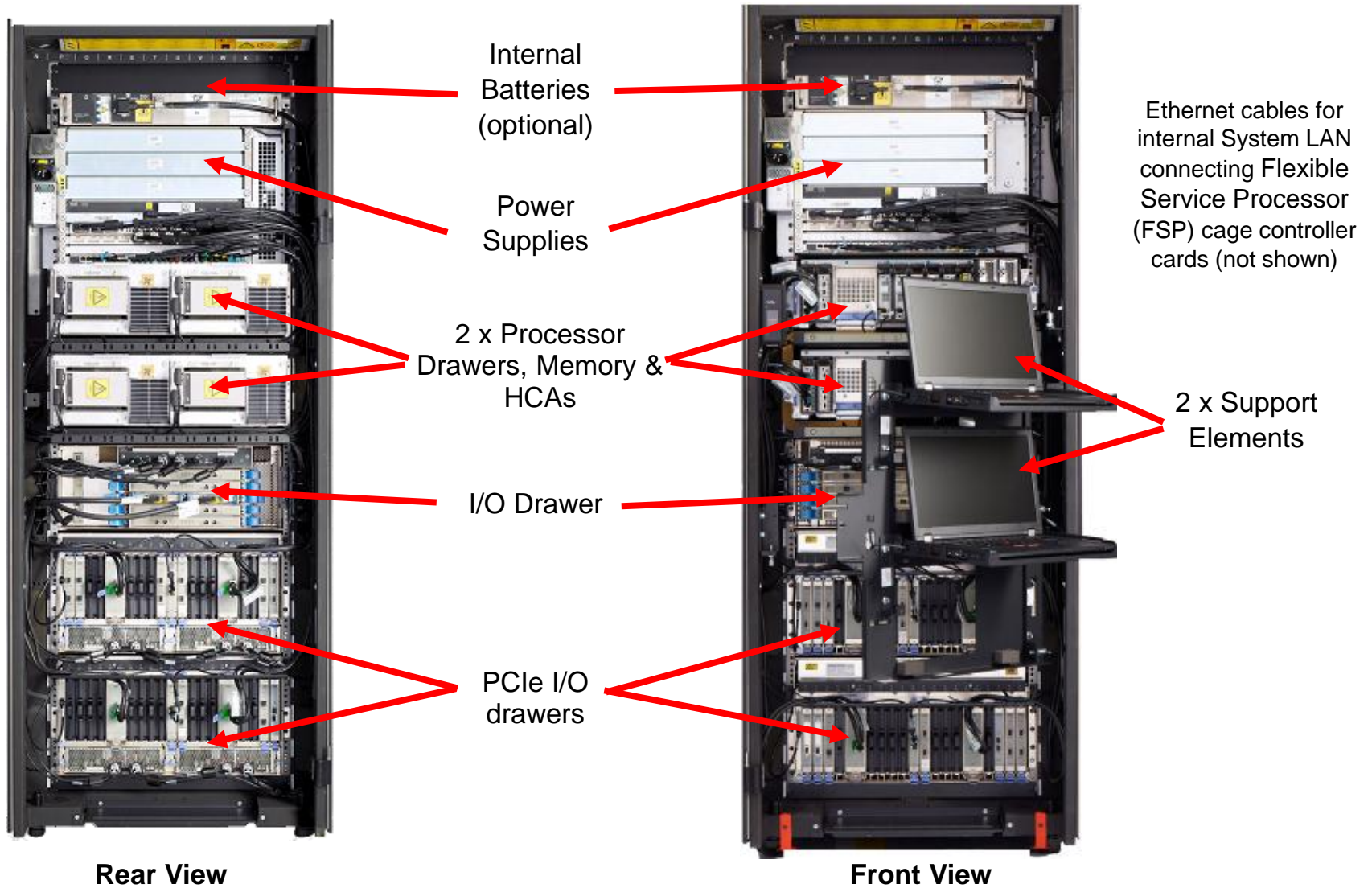

The zEnterprise EC12 delivers unmatched enterprise class processing capacity

- World's fastest processor
 - 5.5 GHz clock rate
 - 120 total processors
 - 101 configurable as IFL, ICF, zIIP, or zAAP specialty engines

- Optimized cache, more memory
 - 48MB on-chip L3 shared cache
 - 8MB on-chip cache/core
 - 1.5GB total shared L4 cache
 - Shared across all 4 books
 - Up to 3TB main memory

- Large server design
 - Over 78,000 MIPS capacity

6 cores
per chip

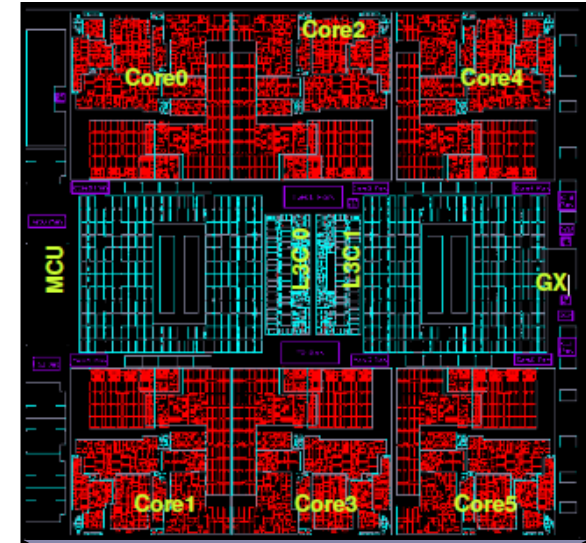

Multi Chip
Module
One per book



The new zEnterprise BC12 delivers best processing capacity for business class environments

- Leverages 32 nm SOI technology
- 4.2 GHz clock rate
- Model H06 has 9 total cores
 - 6 max for GPs, IFLs and ICFs;
 - 3 max for zIIPs and zAAPs
- Model H13 has 18 total cores
 - 6 max for GPs; 13 max for IFLs or ICFs,
 - 3 max for zIIPs and zAAPs
- 26 capacity levels across 6 GPs (156 total capacity levels)
- Almost 2x more cache per chip
- Capacity
 - Uni-processor = 1,064 MIPS
 - Max z/OS (with 6 GPs) = 4,958 MIPS
 - Max Linux (with 13 IFLs) = 8,733 MIPS

zBC12 uses same hexa-core Processing Unit (PU) as zEC12 but with only 4-5 active cores per chip

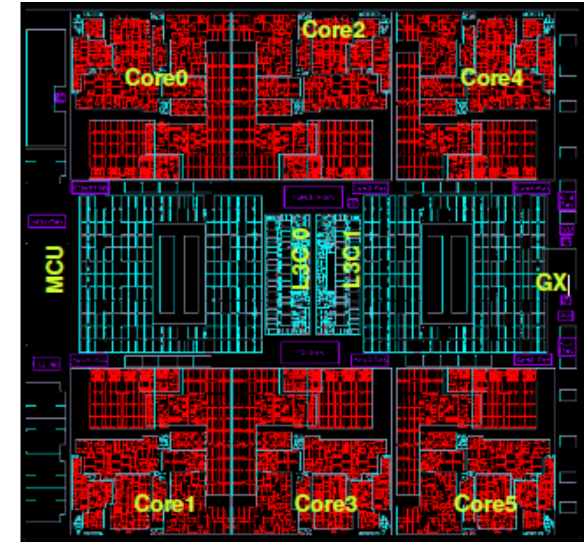

Single PU Chip (without Module Thermal Cap)

*2 PU SCMs for H06 and
4 PU SCMs for H13*



zEnterprise delivers processing improvements for transactional workloads

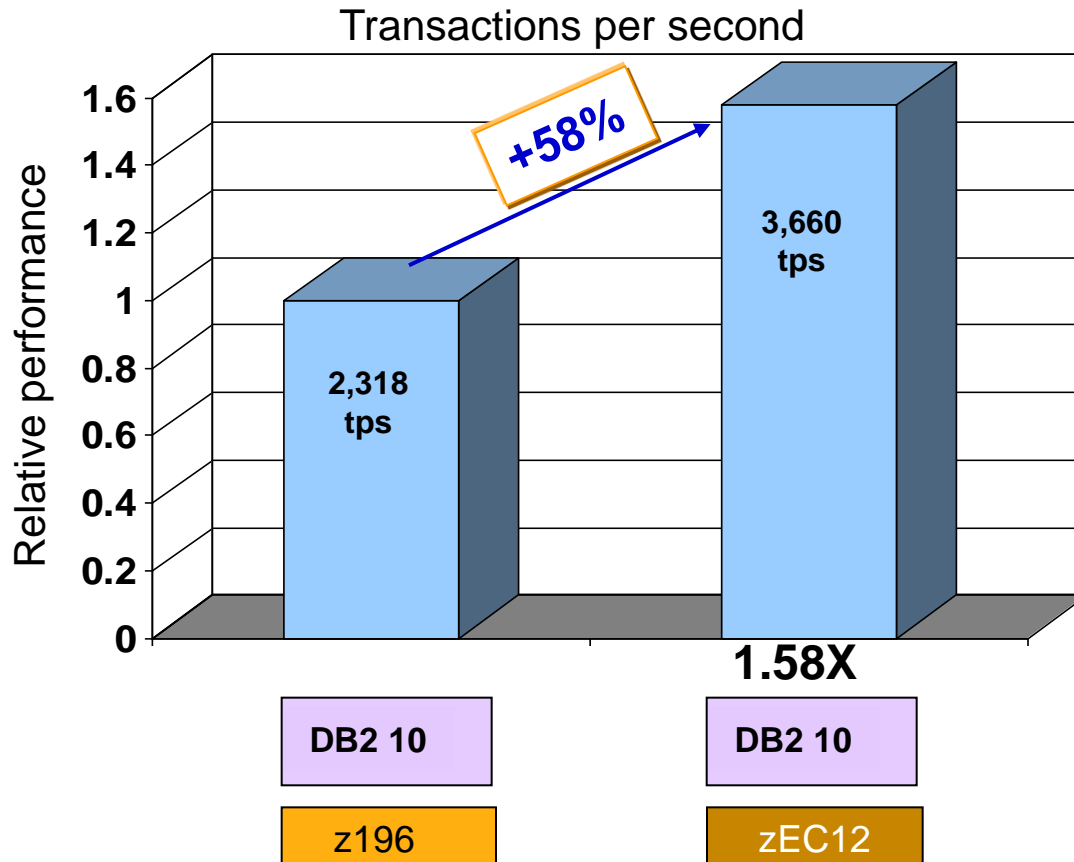

- Faster processors
- More I/O bandwidth due to:
 - 8GBps PCIe interface
 - Upgrade to FICON Express8S
- Both using SSDs

Database I/O intensive performance study

Performance measured in User Interactions per second.
z196 results run on GA1. Results may vary.

Transactional workloads see continuous processing improvements with each new upgrade of hardware and software

IBM internal core banking transactional workload

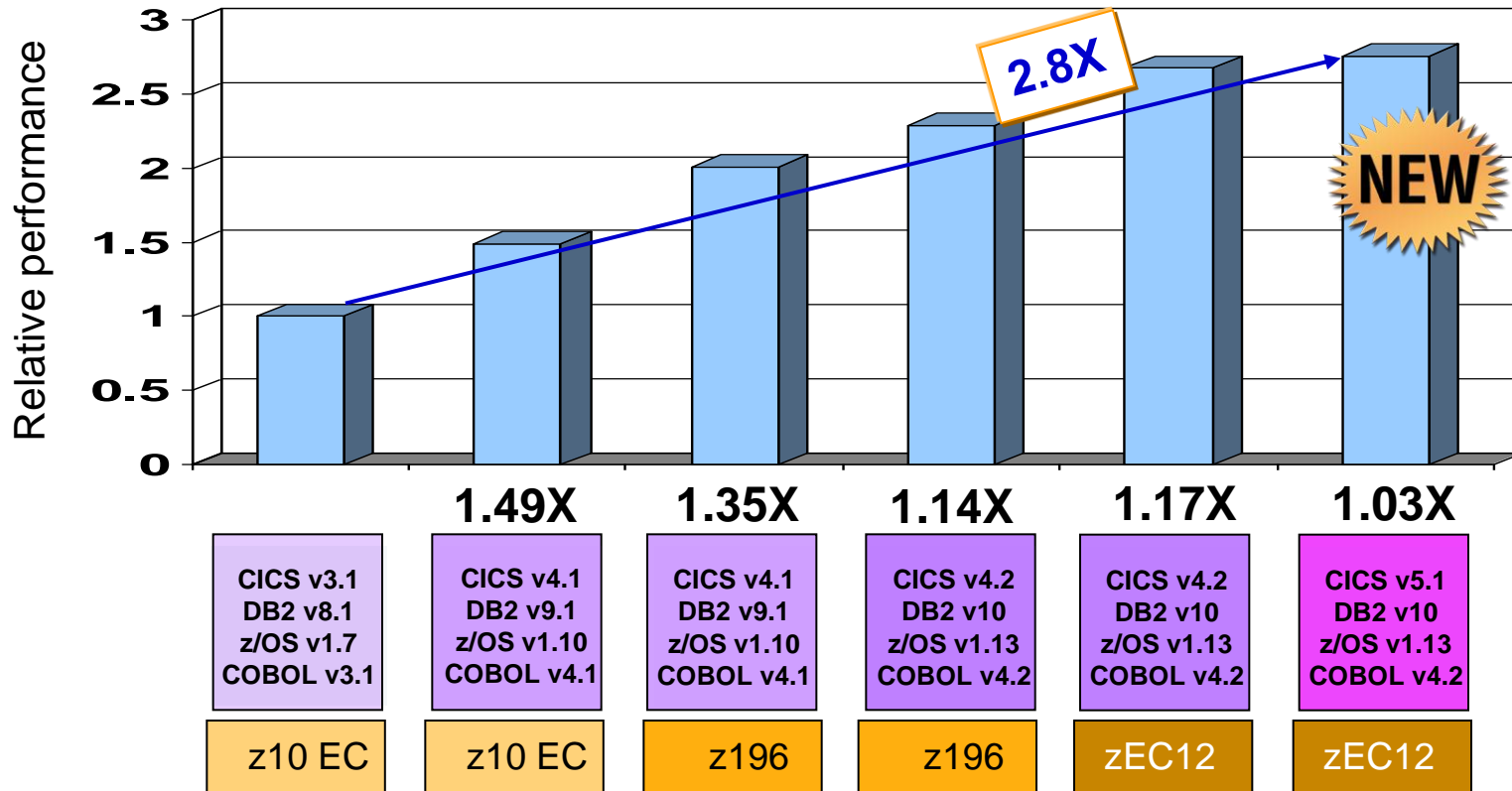

CICS 5.1 adds significant new functionality (e.g. Liberty profile, mobile, cloud, etc.) AND boosts performance by 3%!

Performance measured in User Interactions per second.
z196 results run on GA1. Results may vary.

Continuous software efficiency improvements for Java transactional workloads on System z

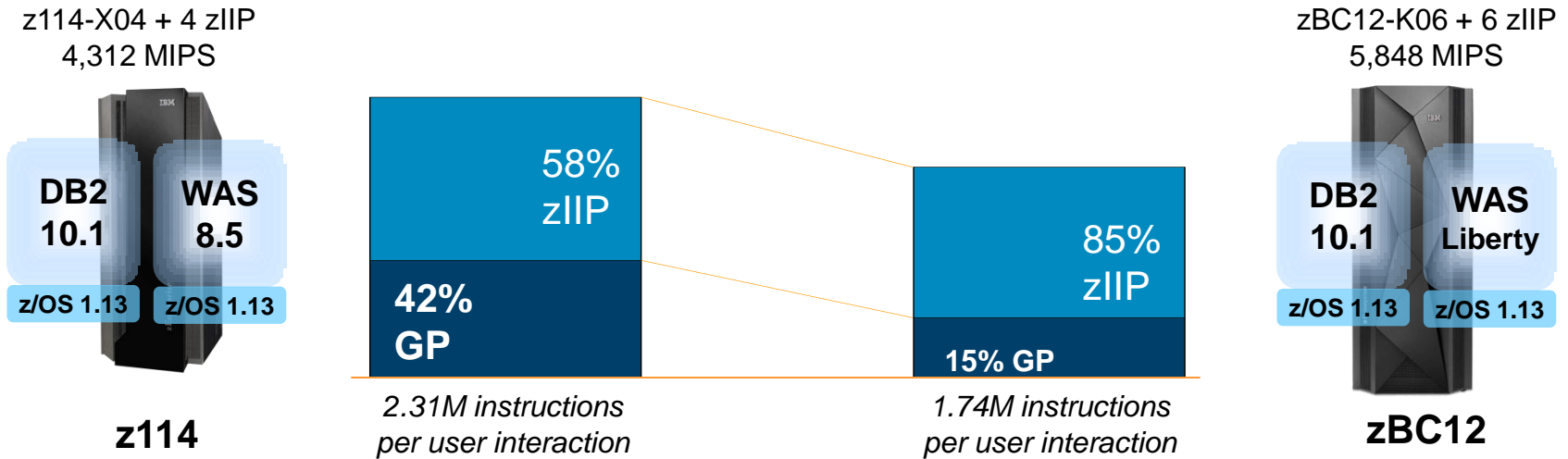

- **New generation specialty processors provide more MIPS**
- **WAS Liberty offloads more Java processing to zAAP or zIIP**

1,863* User interactions per second (UI per sec)

\$2,449 / UI per sec



3,364* User Interactions per second (UI per sec)

\$836 / UI per sec

81% more throughput at 66% lower cost

* Friendly Bank Java workload on WAS. z114 and zBC12 UI per sec results projected from actual measurements on z196 and zEC12 respectively.

zEnterprise parallel sysplex clusters provide even more processing power



Single System Sysplex

- Coupling Facility processors coordinate sharing of resources (locks, data structures, buffer pools)
- Present a single system image of a z/OS workload

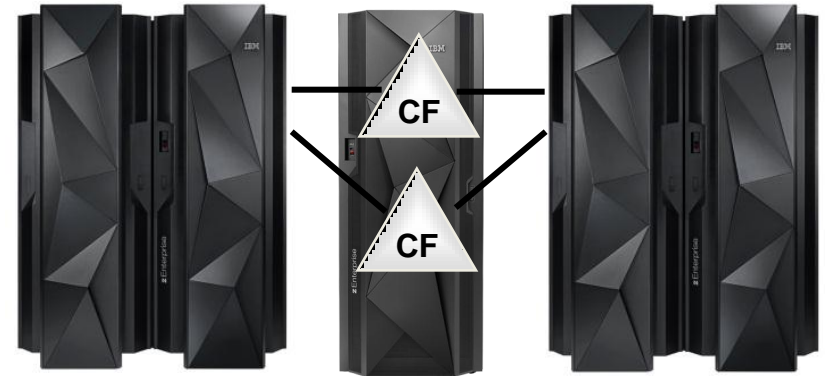

External Coupling Facility
(Can be different class server)

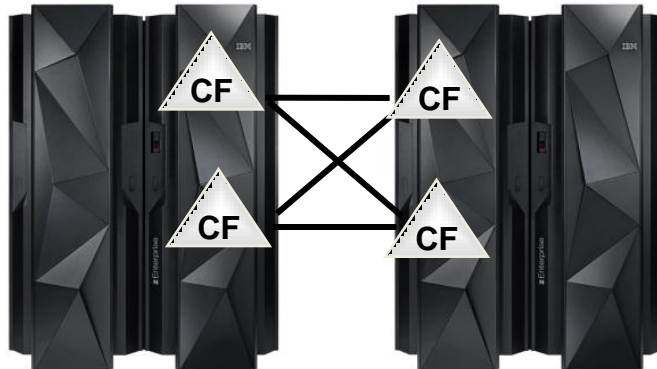

Cross Connected Servers with internal Coupling Facilities

- Parallel sysplex clustering delivers highest availability
- Potentially 2.5 million MIPS per 32-way cluster

Both zBC12 and zEC12 have a dedicated I/O subsystem for high I/O bandwidth

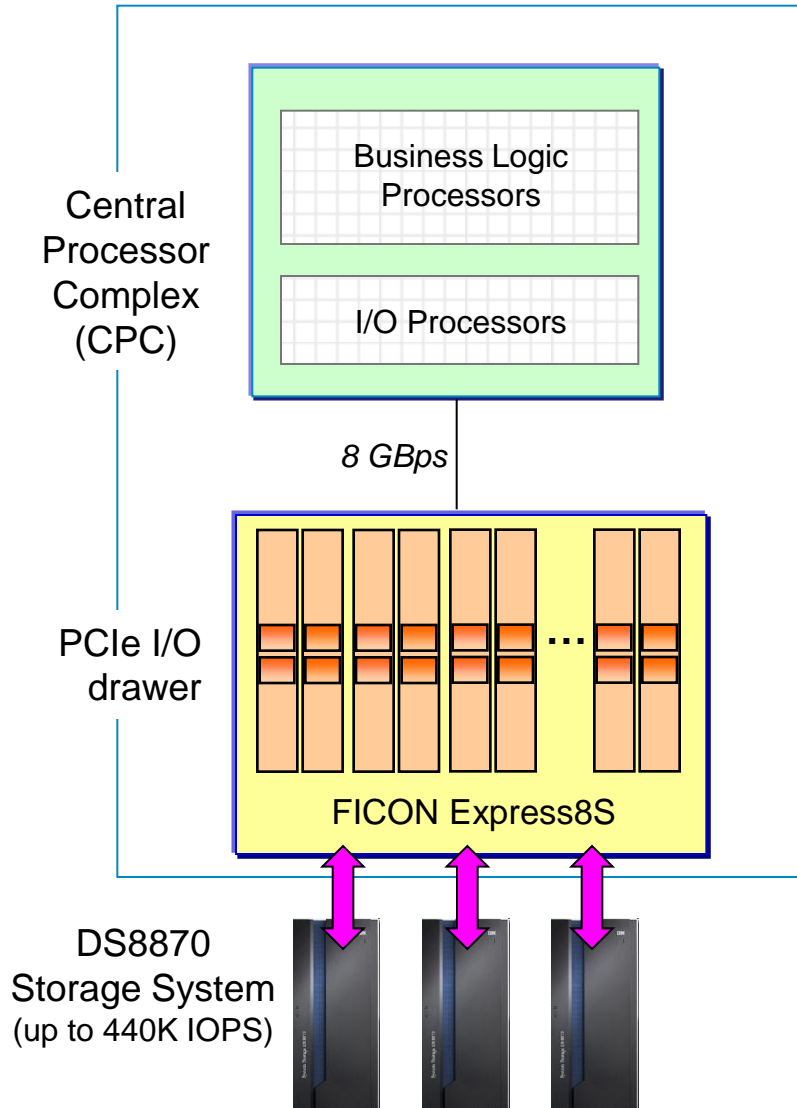

- I/O processing logic can be offloaded to specialty engines – System Assist Processors (SAPs)
 - 2-4 SAPs per zBC12
 - 2-16 SAPs per zEC12
 - Max sustainable IOPS on zBC12 = 600K*
 - Max sustainable IOPS on zEC12 = 2.4M*
- I/O transfers processed by PCIe FICON cards
 - Up to 64 cards per zBC12, up to 160 per zEC12
 - Each card has 2 RISC processors and 2 channels
- Delivers optimized I/O efficiency
 - SAPs and FICON cards offload I/O processing from business logic processors
 - Virtualized and built for sharing
 - Intel servers have no dedicated I/O subsystem

* Recommend 70% max utilization

zEnterprise efficiency – Lower cost for multi-tenant database workloads

Which platform can achieve the lowest cost per workload?

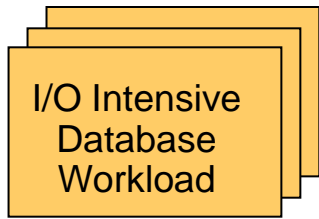

1 workload on 16-core quarter unit



Pre-integrated DB Competitor V2 Multi-Tenant Private Cloud

\$2.27M
per workload

Brokerage High Volume Trading workload driving a minimum* of **243** transactions per second on 200GB database (using SSD storage)

5 multi-tenant workloads on zBC12
4 GPs + 3 zIIPs



DB2 10 for z/OS on zBC12

\$1.70M
per workload

25% lower cost

* Maximum TPS was measured at 270 based on 70 ms injection interval for customer threads. SLA requires no more than 10% degradation in throughput, yielding a Minimum TPS of 243.

Efficiency at scale – consolidated Oracle DB workloads benefit from Linux on System z’s I/O bandwidth

Which platform provides the lowest TCA over 3 years?

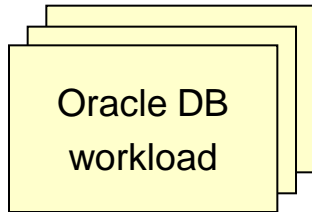

Customer database workloads each supporting 18K tps

Oracle Enterprise Edition
Oracle Real Application Cluster



3 Oracle RAC clusters
4 server nodes per cluster

12 total HP DL580 servers
(192 cores)

\$13.2M (3 yr. TCA)



3 Oracle RAC clusters
4 nodes per cluster
Each node is a Linux guest
zEC12 with 27 IFLs

\$5.7M (3 yr. TCA)



TCA includes hardware, software, maintenance, support and subscription.
Workload Equivalence derived from a proof-of-concept study conducted at a large Cooperative Bank.

IBM DS8000 Smarter Storage is self-optimizing to improve performance and productivity

- Easy Tier migrates most frequently accessed data to faster storage
 - Less frequently accessed data moved to high capacity storage
- Migration based on actual usage
 - No administrator intervention
 - No missed hot spots
 - No application changes needed
- Performance gains up to 9x on I/O intensive workloads*



* Note: Based on IBM internal study of Brokerage database workload run on Easy Tier with 95% migration to SSD vs. well tuned baseline running on all HDDs. Performance measurements were specific to the configuration used. Your results may vary. Contact IBM to see what we can do for you.

Transaction workloads see up to 9x throughput benefit using SSDs, automatically

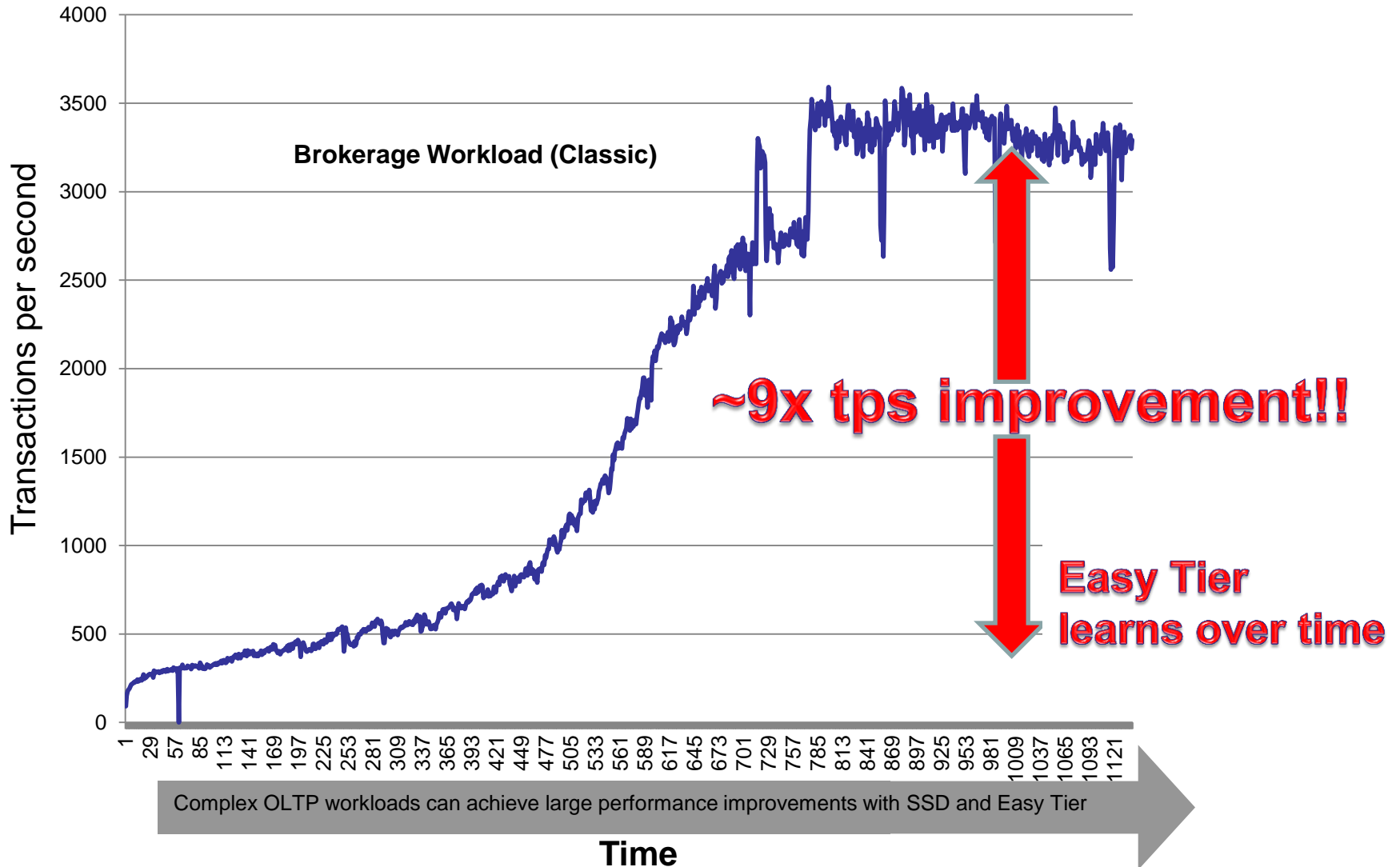

New hardware data compression accelerator can reduce CPU and storage

- Explosive growth today in volume of data being generated
- Storing and handling data is increasingly costly
- Data that is infrequently accessed should be compressed and archived

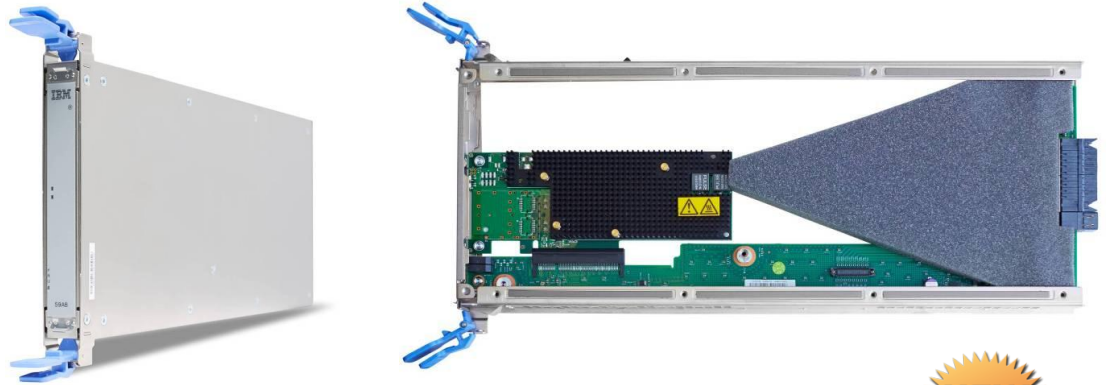

Announcing:
 z/OS compression acceleration –
 zEnterprise Data Compression (zEDC) –
 using zEDC Express I/O card

4x*
data
compression
 (efficient system data
 compression)

- Complements on-chip compression coprocessor used primarily by DB2
- Card-based compression reduces CPU resources and storage costs
- Designed for large files such as BSAM/QSAM sequential files; more efficient storage of audit data in application logs
- Delivered via z/OS 2.1

* The amount of data sent to an SMF logstream can be reduced by up to 75% using zEDC compression – reducing logger overhead

New “HiperSockets-like” capability optimizes server to server networking – transparently

Requires z/OS V2.1

10GbE RoCE Express card for zEC12 and zBC12

SOD z/VM 6.3 support for guests

*Network latency reduced up to **80%****

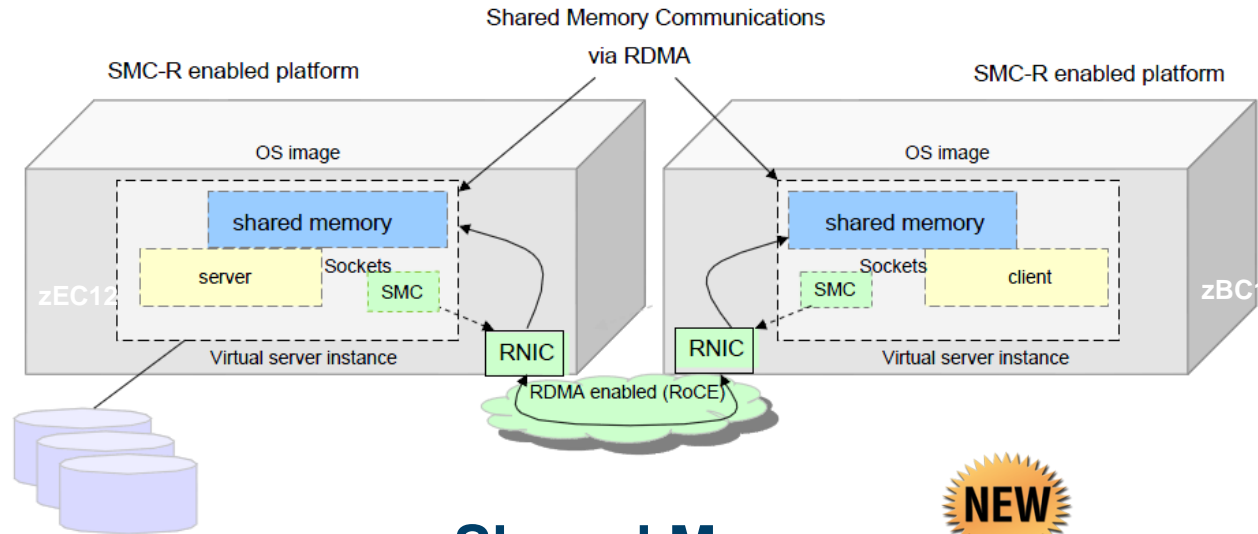

Shared Memory Communications (SMC-R): NEW

Exploit RoCE on zBC12 and zEC12 – with System z qualities of service support for dynamic failover to redundant hardware

Help to reduce both latency and CPU resource consumption over traditional TCP/IP for communications across z/OS systems

Any z/OS TCP sockets based workload can *seamlessly* use SMC-R without requiring any changes

* Based on internal IBM benchmarks of modeled z/OS TCP sockets-based workloads with request/response traffic patterns using SMC-R vs. TCP/IP. The actual throughput that any user will experience will vary.

Trusted resiliency – protect critical data end to end

SECURITY dark READING

10 Top Government Data Breaches Of 2012

SQL injection, post-phishing privilege escalation, and poorly secured back-up information all played their part in exposing sensitive government data stores this year

Nov 29, 2012 | 04:26 AM | [1 Comment](#)

Privacy Rights

Clearinghouse noted **292** US hacking breaches from 2012 through May 2013, involving 9.5 million sensitive records ...

Zaxby's Computers Possibly Compromised, Diners Alerted

Posted on: 1:52 pm, January 16, 2013, by Carter Watkins

[Recommend](#) 3
 [Share](#) 3
 [Twitter](#) 0
 [Email](#)

FLORENCE, Ala. (WHNT) – A data security breach at a well-known chicken restaurant may have led to your credit and debit card being compromised.



Zaxby's restaurants across the south-east made this announcement after malicious software was found on their computer servers.

System z breached data records: **0**

Source: <http://www.privacyrights.org/data-breach/new>
<http://www.darkreading.com/database-security/167901020/security/news/240142846/10-top-government-data-breaches-of-2012.html>
<http://whnt.com/2013/01/16/zaxbys-computers-possibly-compromised-diners-alerted/>

DB2 includes top to bottom data security

- DB2 provides multiple options for table encryption
 - Row and column level encryption
- DB2 supports encryption at every level
 - In memory, buffers, disk, and archival media
 - Table, index, logs, and backup copies
- DB2 supports Multi-Level Security (MLS)
 - Allows users with different access authority to safely access the same database image
- Encryption provided by Integrated Cryptographic Facility (ICSF) using either CPACF or Crypto Express4S

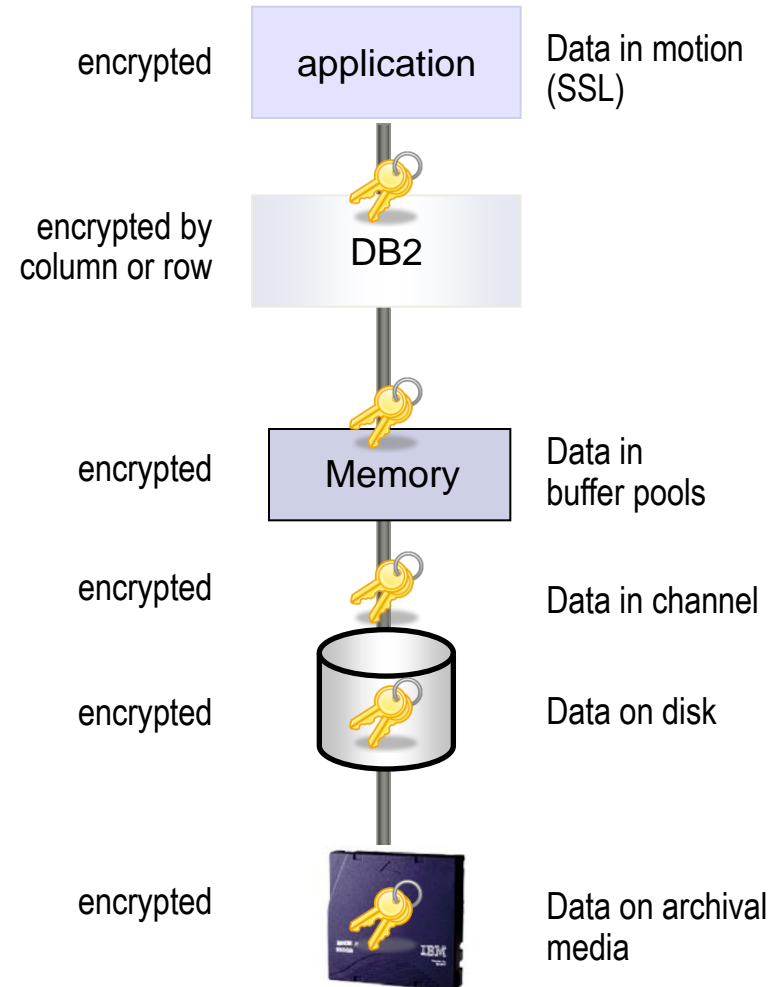

DB2 maturity delivers a proven track record for data security

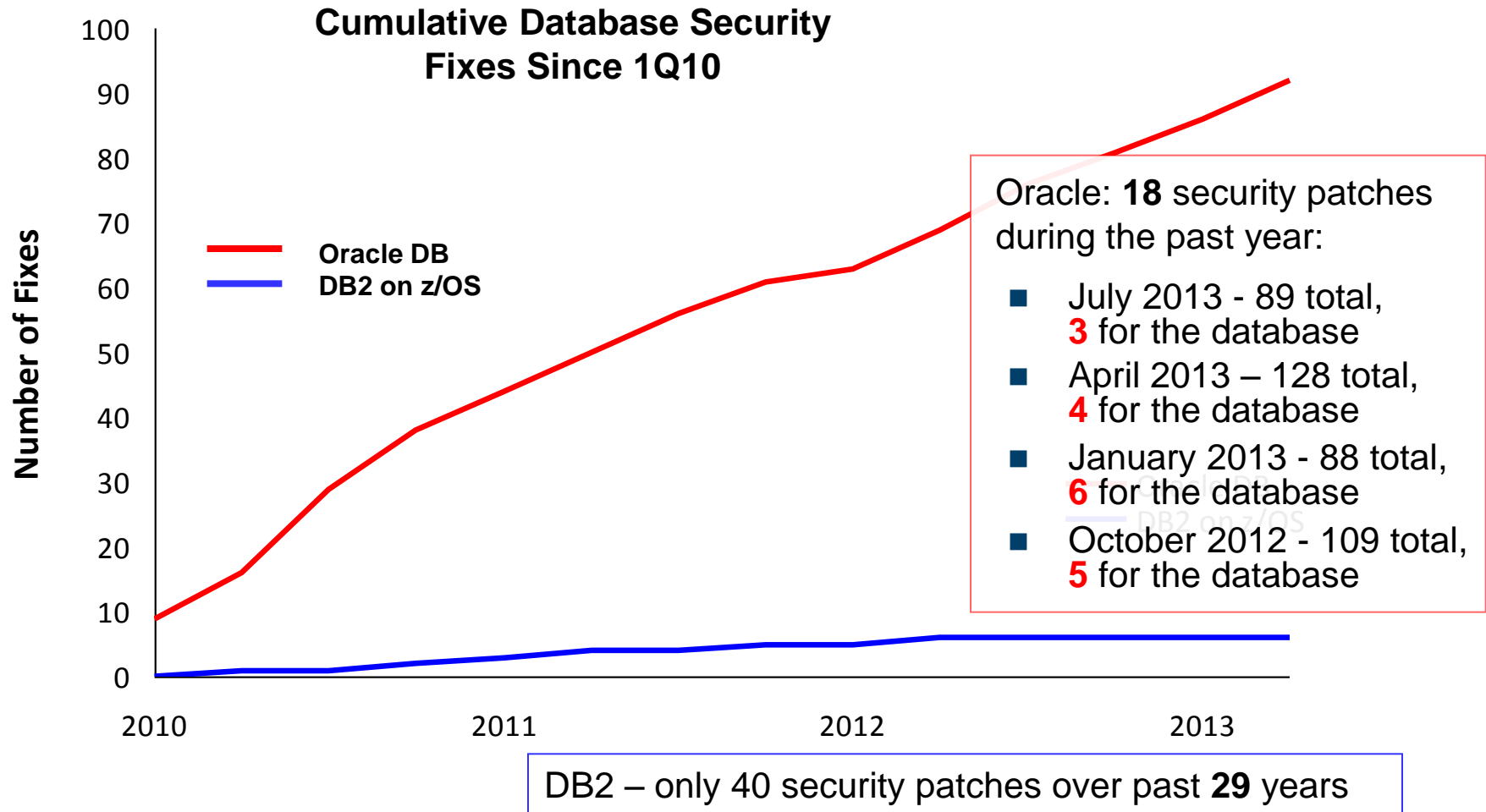

Source: <http://www.oracle.com/technetwork/topics/security>

Communications Server end-to-end data security

- z/OS Communications Server Encrypts Network Data End-to-End
- Multiple styles of encryption for network traffic
 - Application layer encryption, Network layer encryption, Virtual Private Networks with IPsec
- Application Transparent Transport Level Security (AT-TLS) transparently encrypts application data
 - Used by DB2, FTP, CICS Sockets, etc.
- TCP/IP SSL processed by crypto processor

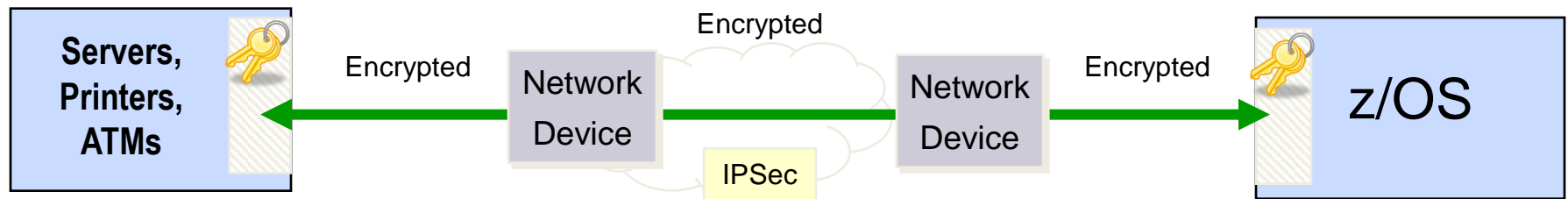

zEnterprise – End-to-end network encryption

z/OS Communications Server provides defense against network attacks

- Automatic application of defensive mechanisms
 - Evaluates inbound encrypted data for suspect activity
 - Policy controls connection limits, packet discard
 - Detects anomalies in *real-time*
 - *Avoids overhead* of per packet evaluation against known attacks
- Scan detection and reporting
 - Can map the target of an attempted attack
- Integrates with Tivoli Security Operations Manager

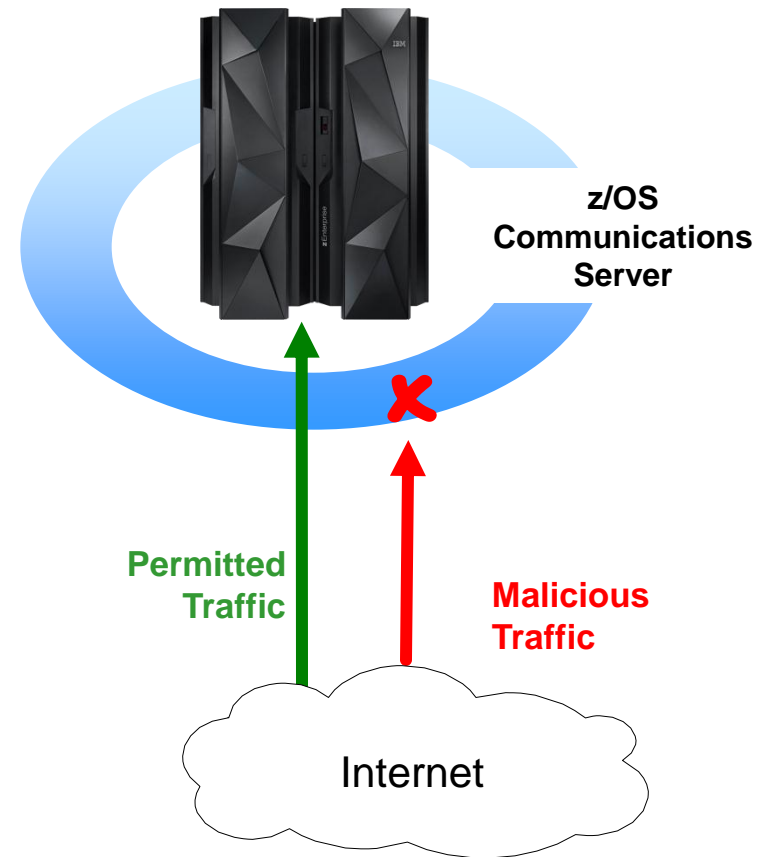

Virtualized System z security is superior to other platforms and augmentation costs less

Security Natively Covered by Platform

Security Level Description	IBM System z	x86	Competitive UNIX
Normal corporate	100.00%	18.16%	30.26%
Credit card processing involved	99.00%	11.04%	18.28%
Banking	94.00%	5.26%	10.22%
Healthcare	100.00%	3.24%	8.51%
Research	92.50%	2.86%	4.16%
Defense	85.54%	0.26%	1.86%

Major security deficiencies on distributed platforms

Distributed platforms require **considerable additional expense**

On System z most security requirements are standard

Little additional augmentation required on System z

Incremental Cost to Achieve Required Security

Security Level Description	IBM System z	x86	Competitive UNIX
Normal corporate	0.00%	32.54%	12.37%
Credit card processing involved	2.32%	46.27%	29.53%
Banking	2.07%	51.31%	26.58%
Healthcare	0.00%	67.26%	35.89%
Research	4.28%	91.26%	64.28%
Defense	11.36%	125.41%	102.26%

Source: "Tracked, Hacked and Attacked?"

© 2013, Solitaire Interglobal Ltd. https://www.ibm.com/services/forms/signup.do?source=stg-web&S_PKG=ov14292

Trusted reliability – comprehensive protection to ensure availability of critical data

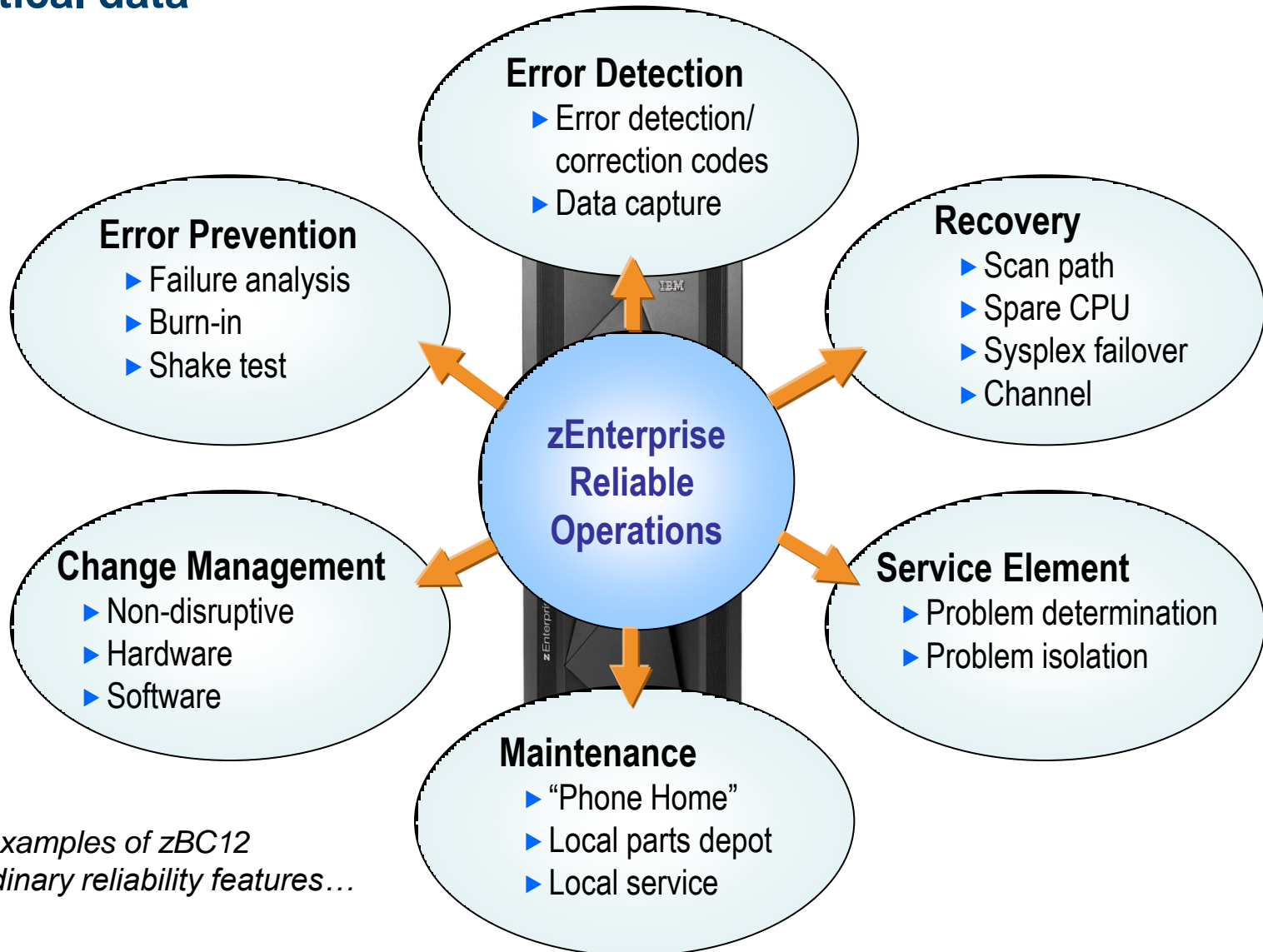

Some examples of zBC12 extraordinary reliability features...



“IBM’s System z mainframes recorded the least amount of downtime of any hardware platform”

Downtime of more than four hours on each server hardware platform (2012-2013)

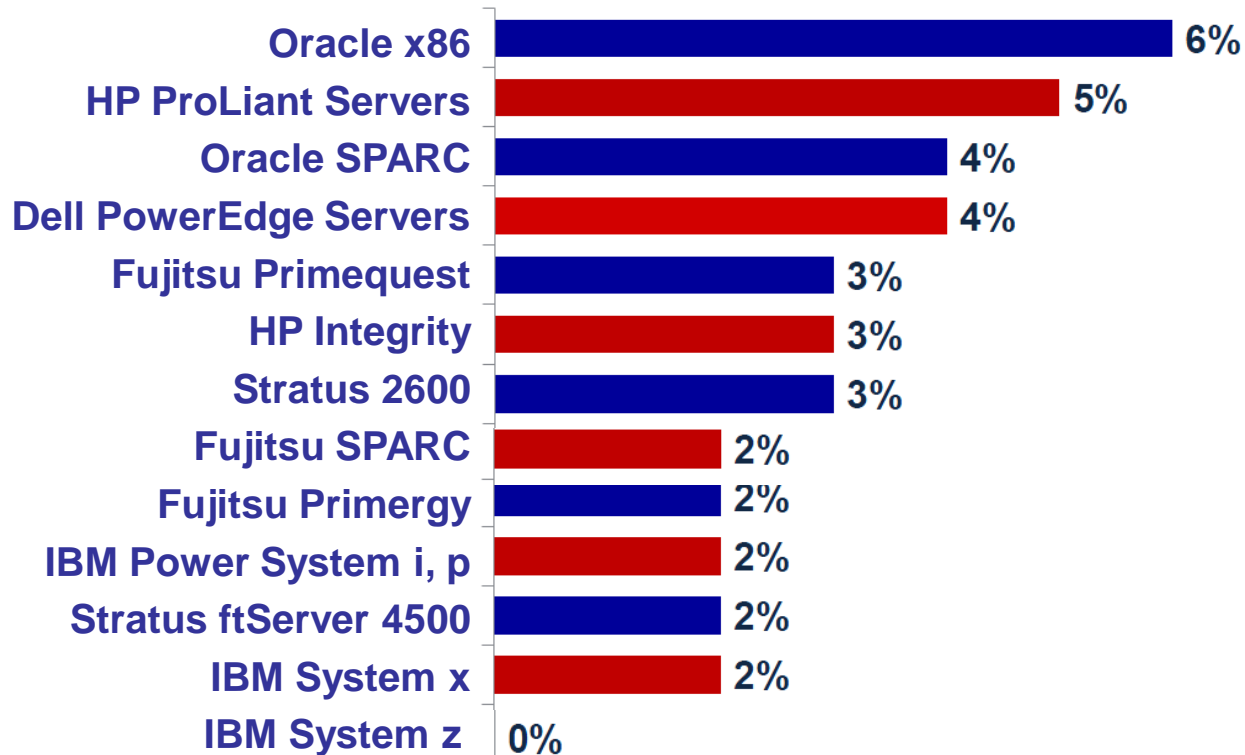

Copyright © 2012 ITIC All Rights Reserved

Cost of downtime for SAP on DB2 for z/OS trumps that of SAP on Oracle RAC

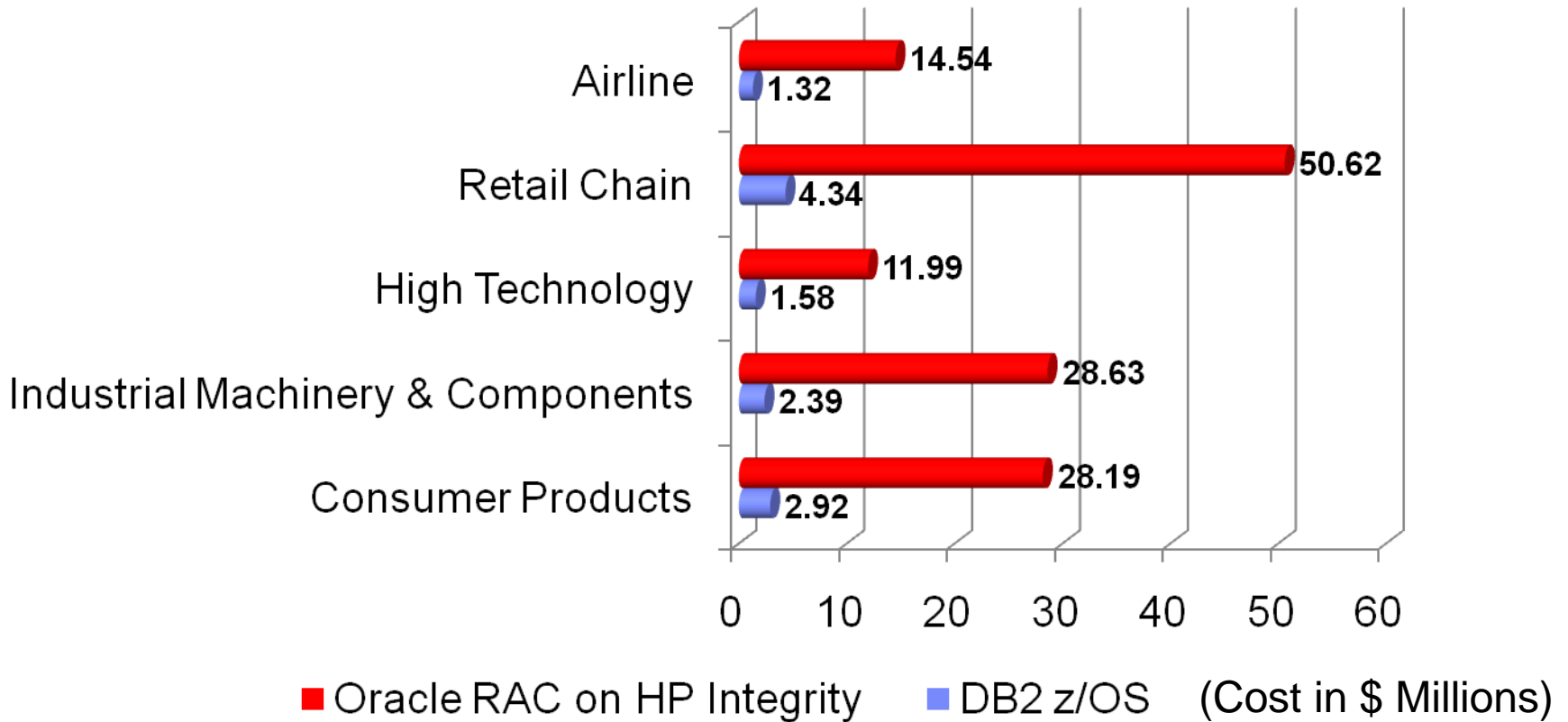

Source: ITG 1005: Business Case for IBM System z – Bottom Line Impact of Availability and Recovery For SAP Enterprise Systems

Demand for critical data access via mobile is here and increasing

Banking

18M

people use mobile devices for bank transactions – that's 8% of all bank transactions

90%

of all phones in Africa are mobile, and primarily used for money deposits

Retail

75%

of mobile shoppers take action after receiving a location-based message

67%

of global consumers want to use mobile devices for checkout and service

Doing business against a replicated data-mart with stale, week-old data is no longer viable

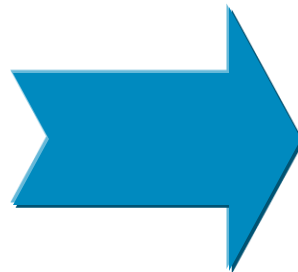

Today, customers and businesses are demanding real-time access to the latest, up-to-date operational data

Why System z and mobile?



The users are here...

Business-critical applications and data are here...



- System z is uniquely able to handle unpredictable load peaks and fluctuations
- System z provides ultimate security for data



Connect mobile applications to System z data using IBM Worklight

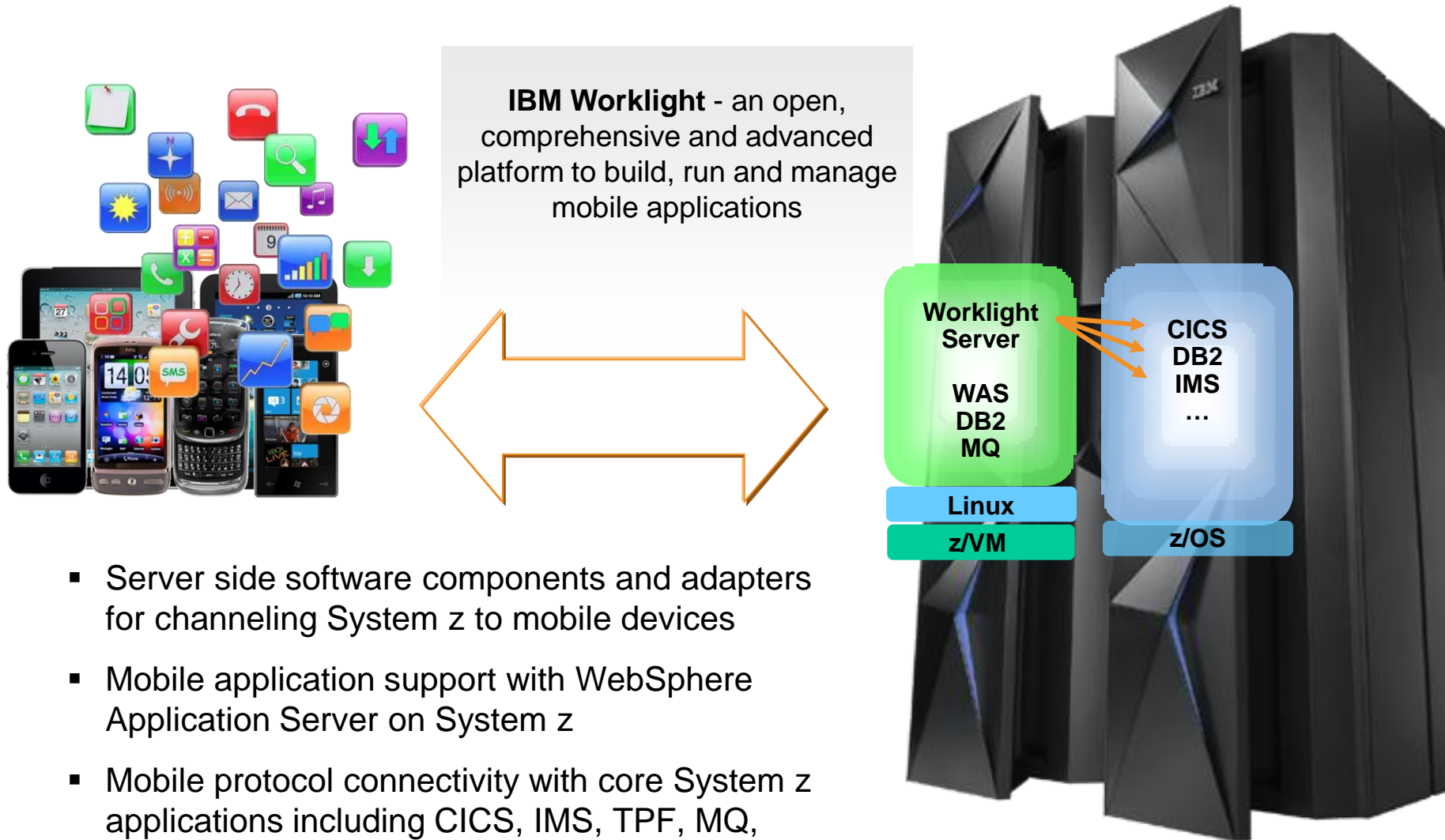

University of Florida goes mobile with CICS and System z



Data provided to students real time

Mobile formatted information of class schedules, textbooks, academic dates, grades, emergency information and campus map

Enables 50,000 students and 5,400 faculty members and staff to access online features anytime, anywhere

IBM Solution

Accessing CICS with System z information via smartphones

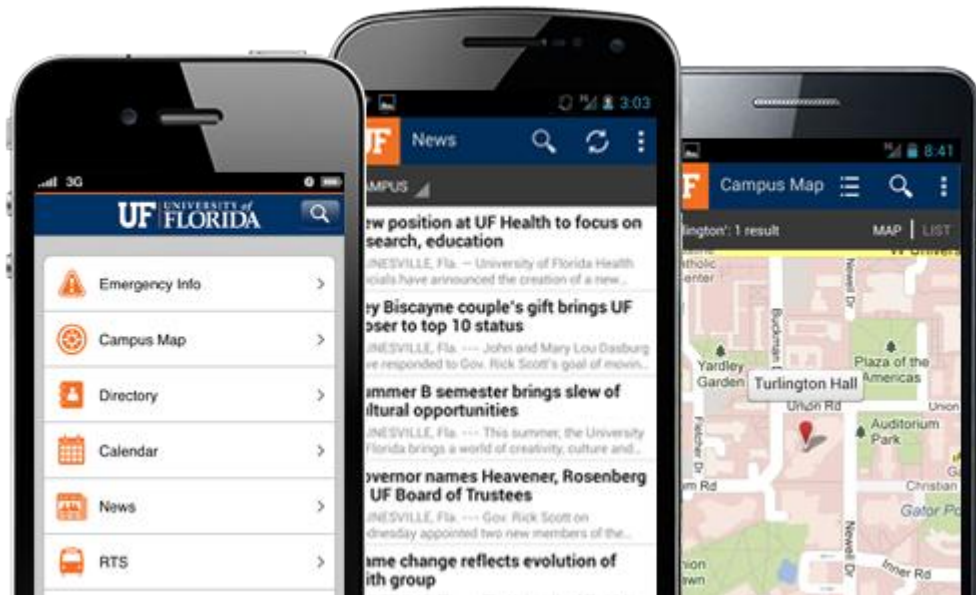
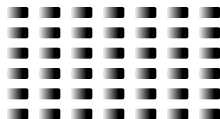

Smarter planet, smarter cities need a smarter infrastructure for critical data

- Not just banks, insurance, logistics, travel companies
- Smarter cities have critical data workload requirements
 - Global scale transaction processing
 - Large scale Batch processing
 - Co-located business analytics

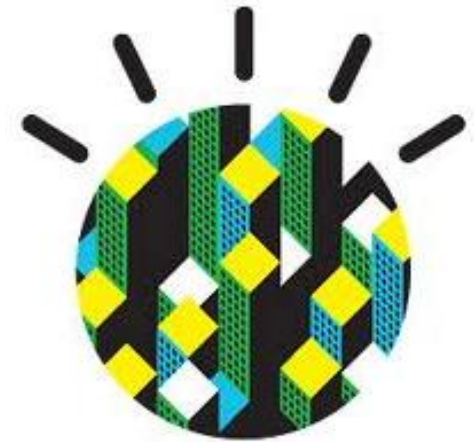

For example,

IBM's Smarter Cities Intelligent Operations Center

DEMO: Smarter cities common alerting protocol



1 Fire Hydrant is struck by a car
Maintenance crew fill out a order
which will take 4 days

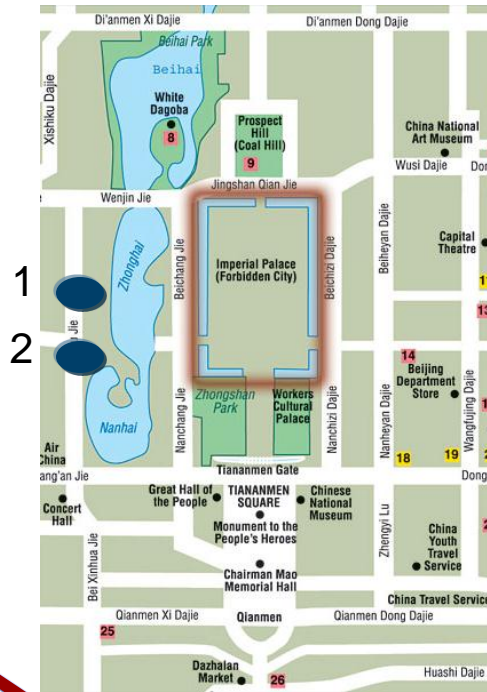

2 Fire breaks out
on same block

Bring water Truck



Extra Long Hose



5 Fire Truck gets better information
on equipment choice



4 Alerts are sent to IOC in addition
to the current city systems
IOC see same time / same place
correlation and updates fire
house



3 Fire is reported

The momentum is growing around zEnterprise!

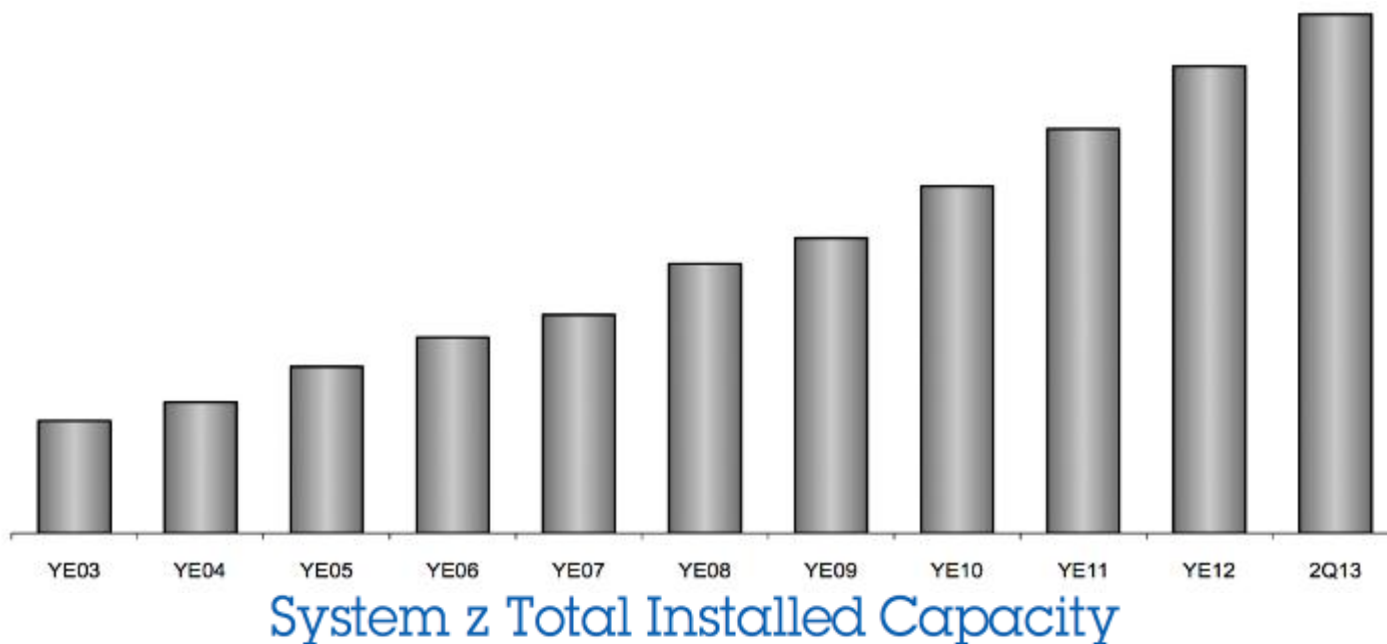

23%

MIPS growth and 10% revenue growth year-to-year

210+

new accounts since 3Q10 zEnterprise® launch, with 1/3+ in growth markets

275+

hybrid computing units shipped since 3Q10

3/4+

of Top 100 clients have installed IFLs
[IFL = Linux-on-z Only Engine]

1,000+

schools in 67 countries are part of the IBM Academic Initiative for System z®

7,400+

ISV apps run on IBM System z; 55 new ISVs added in 1H13

“Mainframes have a bright future!” – ZDNet Japan

“ IBM announced a new cost-efficient mainframe system, the zEnterprise BC12, **designed for analytics, cloud and mobile computing.** ” *eWeek*

“ With a starting price of only \$75,000, IBM's new zEnterprise BC12, or zBC12, can actually be a **low-cost alternative to a traditional distributed server environment.** ” *CRN*

“ The zEnterprise BC12 announced [July 23] offers a well-balanced collection of improvements for existing main-frame customers, and **even more reasons for a new customer to consider System z for critical workloads.** ” *The Clipper Group*



Notice regarding specialty engines (e.g., zIIPs, zAAPs and IFLs):

Any information contained in this document regarding Specialty Engines ("SEs") and SE eligible workloads provides only general descriptions of the types and portions of workloads that are eligible for execution on Specialty Engines (e.g., zIIPs, zAAPs, and IFLs). IBM authorizes customers to use IBM SE only to execute the processing of Eligible Workloads of specific Programs expressly authorized by IBM as specified in the "Authorized Use Table for IBM Machines" provided at www.ibm.com/systems/support/machine_warranties/machine_code/aut.html ("AUT").

No other workload processing is authorized for execution on an SE.

IBM offers SEs at a lower price than General Processors/Central Processors because customers are authorized to use SEs only to process certain types and/or amounts of workloads as specified by IBM in the AUT.