

Going Beyond Today: Extending the Platform for Cloud, Mobile and Analytics





So now let's sit back and envision possibilities...



How can we better unlock the value of our data?

I want to implement analytics, but I need a flexible, yet fast platform...

A big challenge today is “The ETL Problem”^{*} – data is always being moved somewhere else...

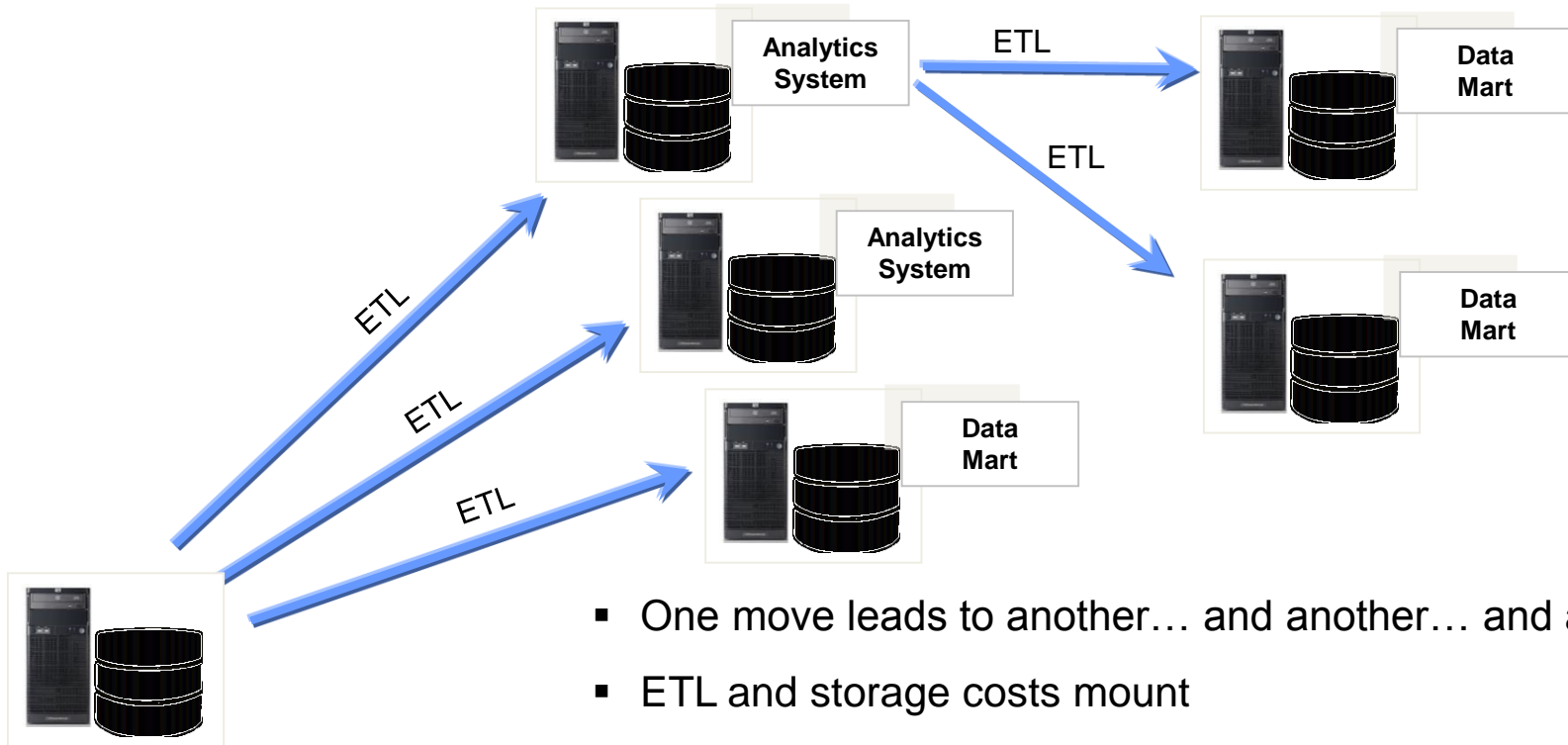

- One move leads to another... and another... and another
- ETL and storage costs mount
- Increase in distributed core required to support the data
- Security may be overlooked
- Each new copy is further removed from the source – *which is the “truth”?*

^{*} See <http://www.clabbyanalytics.com/uploads/ETLfinal.pdf>

Consolidation on the Enterprise Linux Server reduces costs and improves overall agility

Consolidate the ever growing proliferation of data copies onto a single, easily managed platform

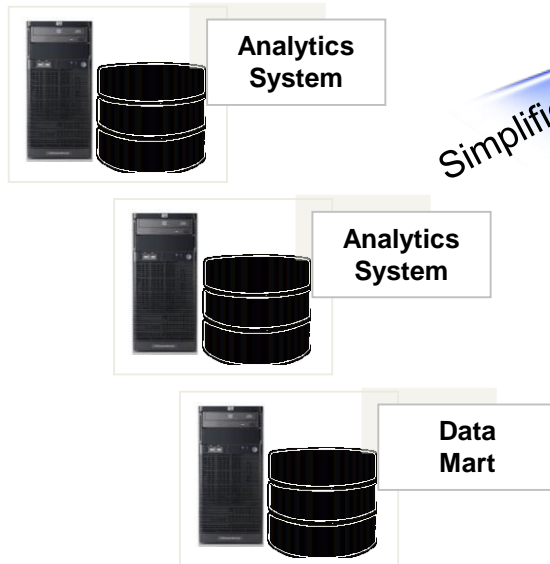

A single platform to manage and administer

Benefits

- Concentrate data into one single source of truth
- Easier to surround data with highest levels of security
- Simplifies management
- Provides consistency to informational data
- Enable application queries on real-time data

Consolidate Oracle on distributed servers onto ELS – save on hardware *and* software costs

- Oracle is most widely used distributed database
- Oracle is fully supported on the Enterprise Linux Server platform

IBM Case Studies

Distributed cores to ELS core

Major Transportation Company:

Software costs reduced by 84%

46 : 1

Middle East Bank:

Software costs reduced by 76%

50 : 1



Also, DB2 for Linux, Unix, and Windows (DB2 LUW) offers tremendous value



Low Cost

Unparalleled automation, compression, and virtual appliances

Simple

Easy Development, XML support, and virtual appliances

Reliable

World class audit & security features, high availability, and workload management

“My DBAs have been playing with DB2 and they're blown away. I've got two guys who have a lot of experience with Oracle and SQL server and they were a little leery about DB2 when I hired them. But they're very happy with the capabilities and functionality so far.”

— Kevin Barber, director, data systems, UA College of Pharmacy

Business analytics answer key questions and drive a competitive edge

Descriptive Analytics:

- Insight into what has happened
- Provides reports/dashboards
 - Aggregate and drill-down on data using different dimensional attributes such as by date, geography, demographics, etc.
- Visualize data using interactive charts, graphs, maps and other objects

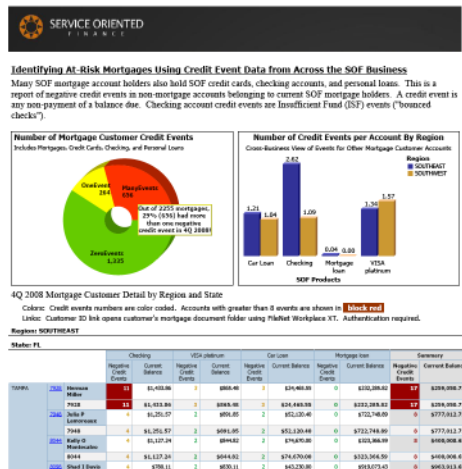

IBM Cognos Enterprise

Predictive Analytics:

- Predicts what might happen
- Provides scores that helps in optimized decision support
 - Build models using historical data and mathematical algorithms such as clustering or classification
- Some models provide rules that can be integrated into business processes

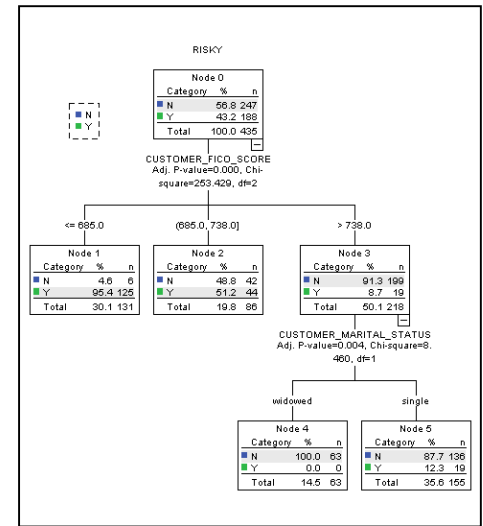

IBM SPSS Statistics and Modeler

A private cloud platform can be ideal, especially for deployment of business analytics



Private cloud

- Infrastructure operated solely for an organization
- Managed by the organization or a third party
- *Applications and data remain “inside the firewall”*
- *Data is secure and not replicated*
- *Easy to administer*
- *More customization and flexibility options*



Public cloud

- Available to the general public or a large industry group
- Owned by an organization selling cloud services
- *For customers who opt against owning the hardware*
- *Applications and data are publicly exposed*
- *Minimal visibility into day-to-day operations, yet still requires considerable administration*
- *Few avenues available for customization*

IBM SmartCloud enables fast, agile and low cost provisioning of applications onto Enterprise Linux Server

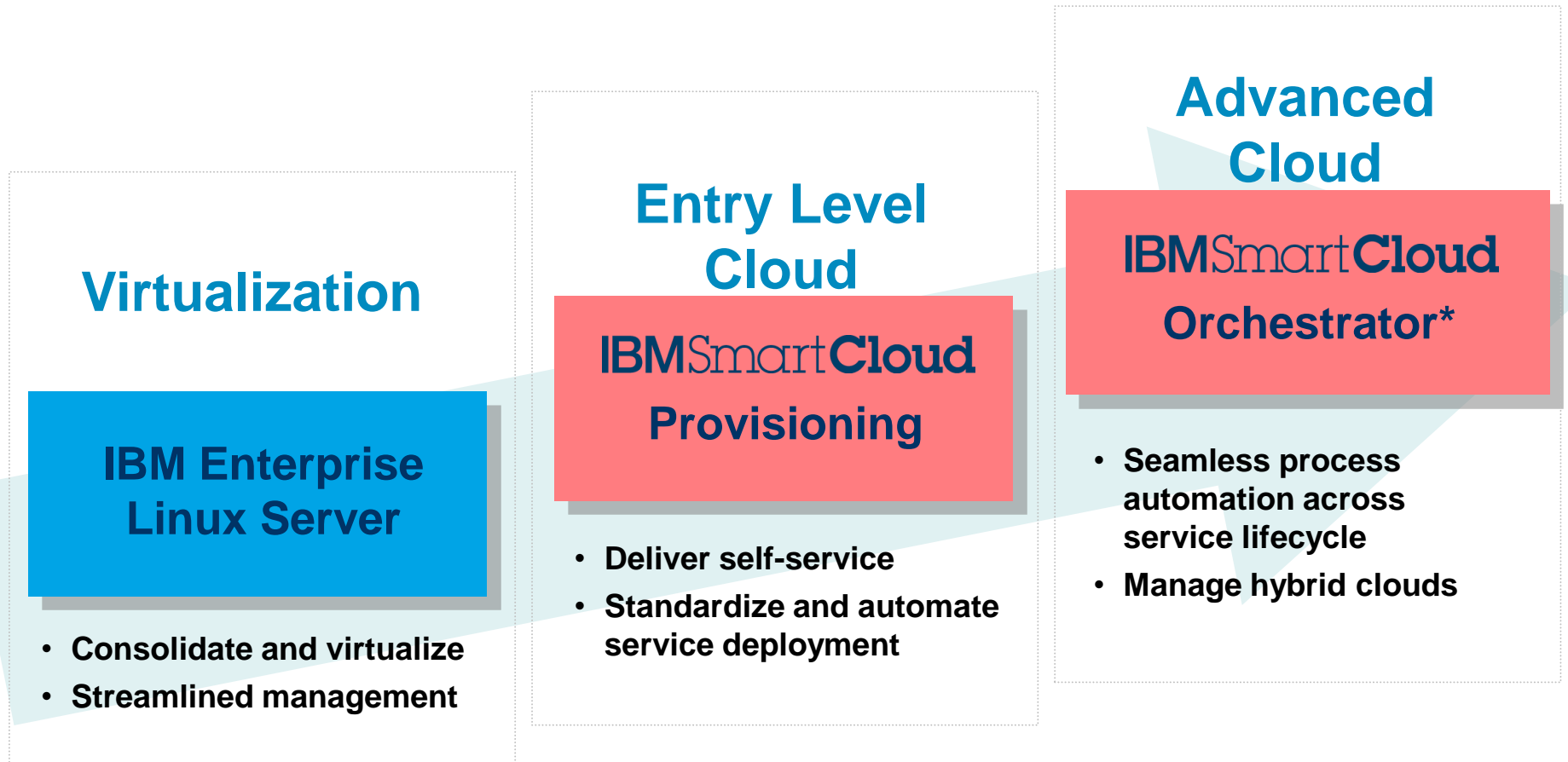

*Under development on Linux on System z

IBM SmartCloud Provisioning automates the process, simplifying and hastening application deployment

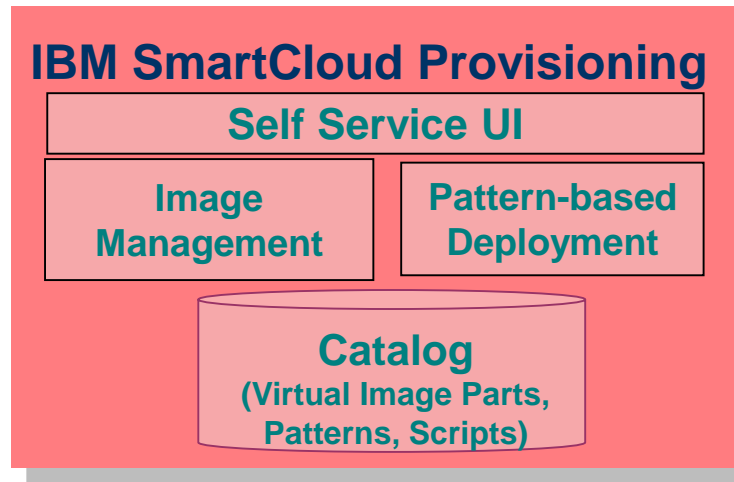

- Self-service console for users
- Virtual images and patterns for quick-starts
- Drag and drop tooling for creating and deploying cloud services using catalog
- Intelligent placement algorithm optimizes resource utilization based on cloud activity

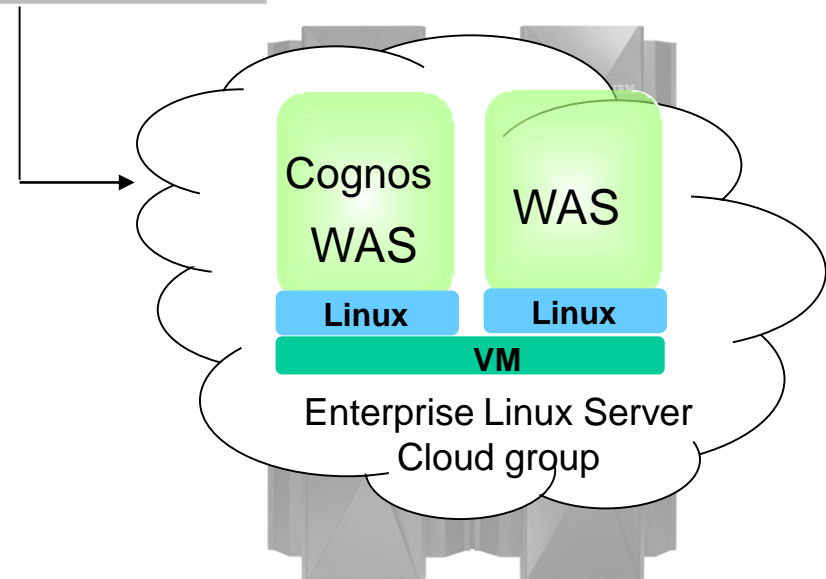

Deploying workloads on a private cloud on Enterprise Linux Server is extremely cost effective

Case Study: 225 Workloads

201 light workloads
plus 24 heavy I/O workloads

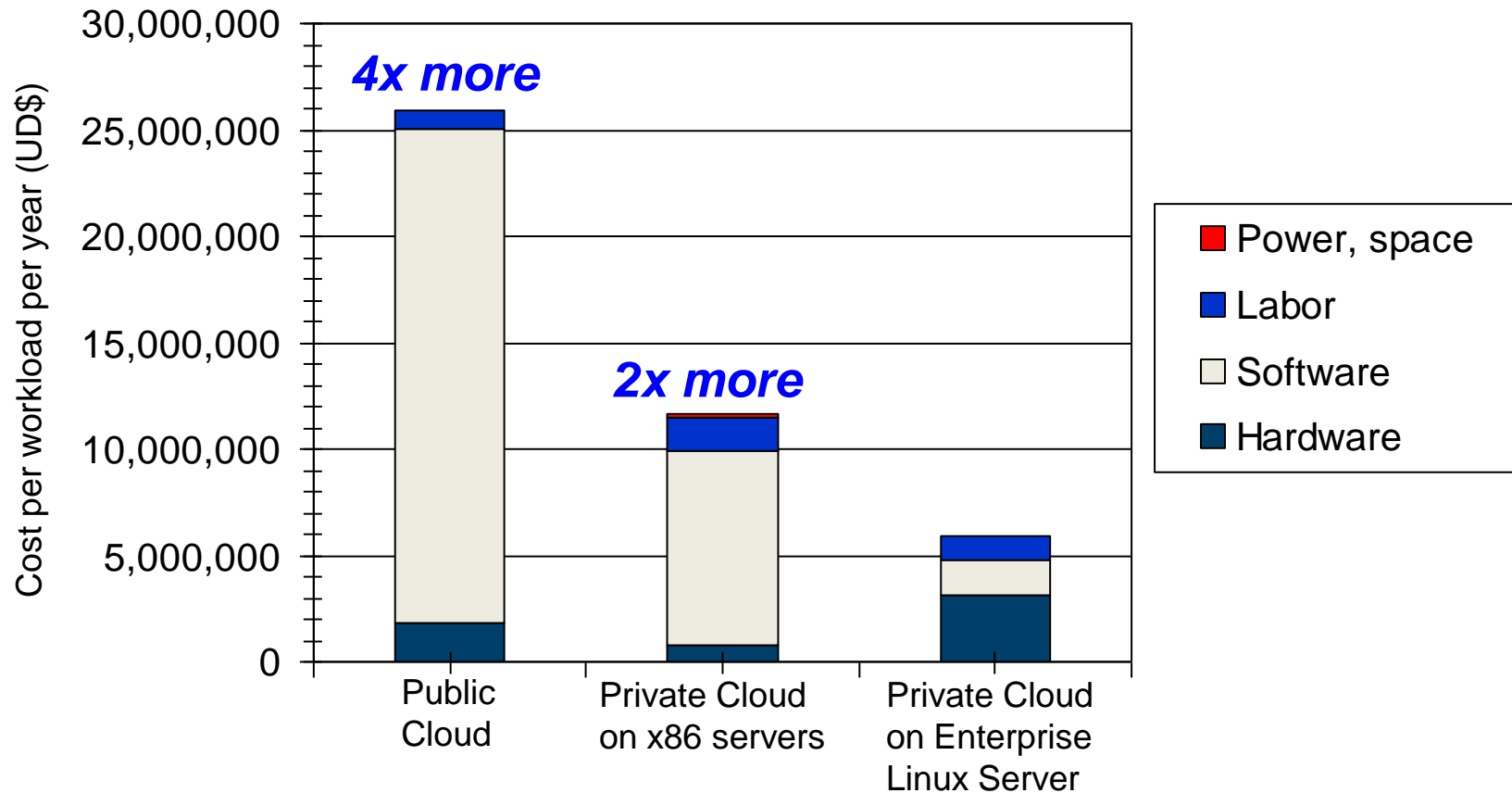

Server configurations are based on consolidation ratios derived from IBM internal studies. Prices are in US currency and will vary by country. Amazon case includes costs of hardware (instances, data in/out), middleware and labor. Enterprise Linux Server and x86 cases include costs of hardware (OS, virtualization, cloud mgmt), middleware, power, floor space and labor.



So now let's sit back and envision possibilities...



Is my system ready for the mobile revolution?

What's the best platform for hybrid computing?

Mobile business truly will be HUGE – just look at the numbers!

Time Magazine, January 2014

Projections of mobile growth and PC decline based on Gartner data



The Death Of the PC?

Now that we carry computers in our pockets, desktops and laptops are on the decline

SMALLER DEVICES WILL TAKE OVER



1.2B

(NOTE: World population is about 7.2B)

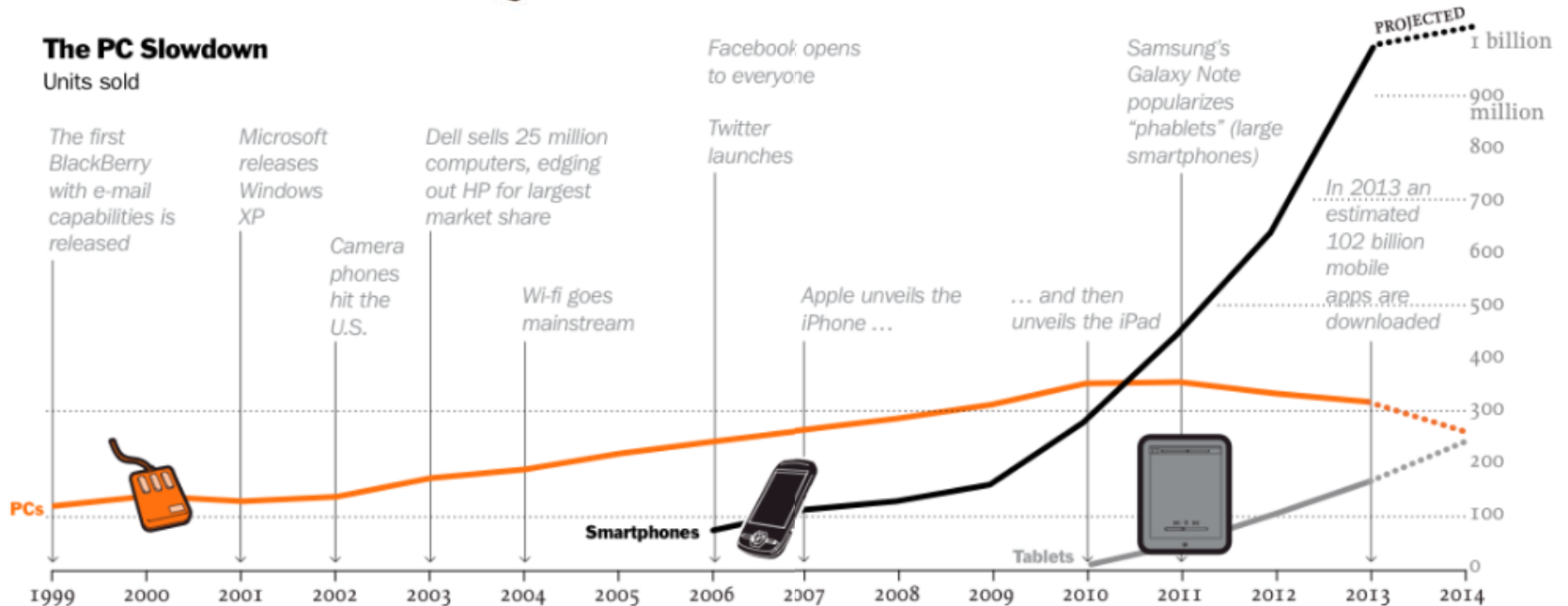

Adopting a mobile strategy will be critically important to business

- Enables premium customer service
- Broadens market reach
- Increases revenue
- Increases operational efficiency



Mobile is a significant component in the evolution of computing

But the mobile revolution will put huge demands on business and IT – *are you ready?*

- Inconsistent peaks 24/7 are common
- Increased system load
- New versions of apps occur weekly vs. yearly
- Development, control and support of apps and multiple devices is not standard
- Security and privacy are paramount

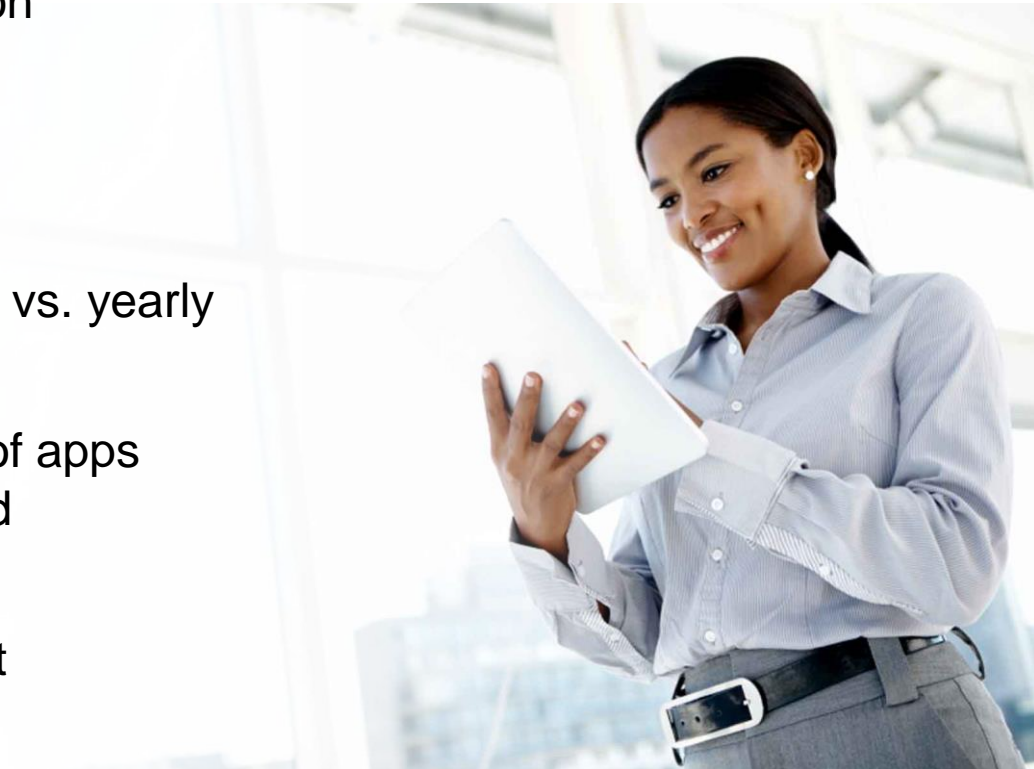

To become a successful mobile enterprise, there are three things to understand

1. The magnitude of the mobile revolution will overshadow the eBusiness revolution
 - Anticipate huge numbers of transactions, with potentially wildly varying fluctuations in numbers
 - Exceptional levels of scalability and elasticity will be required
 - Optimizations through hardware and software must be cost effective
2. Every transaction must be immediate, authentic and secure
 - Centralize content and information management
 - Ensure highest levels of protection and privacy
 - Use a rock-solid infrastructure – reliable, consistent, sustainable
3. Extending business workloads to mobile devices has to be easy
 - Optimize development and delivery
 - Support a unified platform and open technologies

Centralized server technology provides a platform to manage and drive all mobile applications

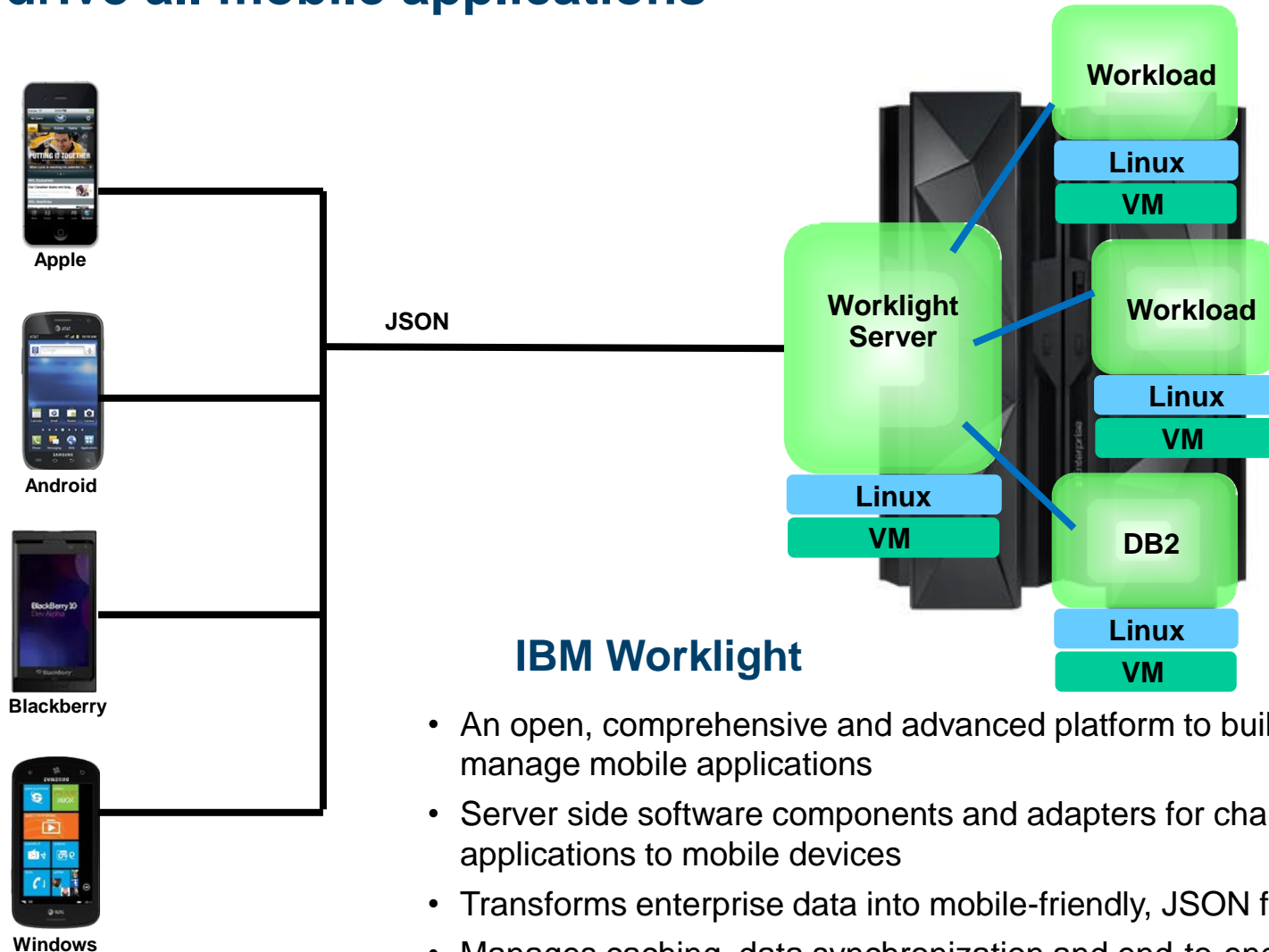

IBM Worklight

- An open, comprehensive and advanced platform to build, run and manage mobile applications
- Server side software components and adapters for channeling applications to mobile devices
- Transforms enterprise data into mobile-friendly, JSON format
- Manages caching, data synchronization and end-to-end encryption

The IBM Enterprise Linux Server also has an optional BladeCenter extension



- Supports POWER, x86 and special optimizer blades
- Ideal for consolidation of Windows workloads
- Cross-platform resources managed by a unified resource manager
- Allows for a best fit strategy across the complete Enterprise Linux Server platform



Izumiya

Integrating over 100 distributed servers into a hybrid system with IBM Enterprise Linux Server - Anticipating IT administration cost reduction of 20%