



*The future runs on System z*

# **Enterprise Modernization**

*Lowering the cost of multi-platform application development and delivery*

*Hayden Lindsey*

*VP & Distinguished Engineer*



*Enterprise Modernization,  
Modeling, Construction & Compilers  
Rational Software*

# Change is the new norm



There are **1 billion** camera phones in use today



*IBM Sequoia Super Computer...*

It would take the **entire population of the earth**, about six billion, each of us working a handheld calculator at the rate of one second per calculation, **more than 320 years** to do what Sequoia can do in one day.

**“8 of 10 CEOs see significant change ahead”**  
- 2008 IBM CEO Survey

The **internet of people** is over one billion strong. The **internet of things** is almost one trillion.

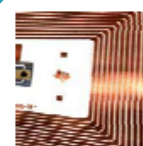

By 2010, there will be **30 billion RFID tags** in circulation

Soon there will be over **2 billion people** on the web



China sends more text messages in a **week** than the U.S. does in **1 year**



# Change can be ~~very disruptive~~ an opportunity

IT skills shortage reaches highest level in 10 years

All software systems crashed due to software bug when F-22 flew over international dateline



50% of outsourced projects are expected to under perform

*“The gap between expected change and the ability to manage it has almost tripled since 2006.”*

– 2008 IBM CEO study



COBOL thwarts California's “Governator”

North Carolina Jobless Claims Crash State's Web Site



Ohio election web site shut down after being hacked

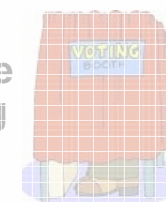

View fashion shows and collections on your iPhone



Malta is building a smart grid to link the power and water systems



Mobile phone provider “3” launches new handset to allow users to make free calls via Skype

## Is your IT infrastructure flexible enough?



*“The message for IT is clear; business needs and expects greater agility from IT. A new approach to IT delivery models and sourcing options is required that allows IT organizations to be more responsive to the needs of the business.”*

*– Gartner, October 14, 2008, “Changing the Cost Structure of IT Will Become a Business Imperative for Most CIOs”*

# Treat software development as a strategic business process

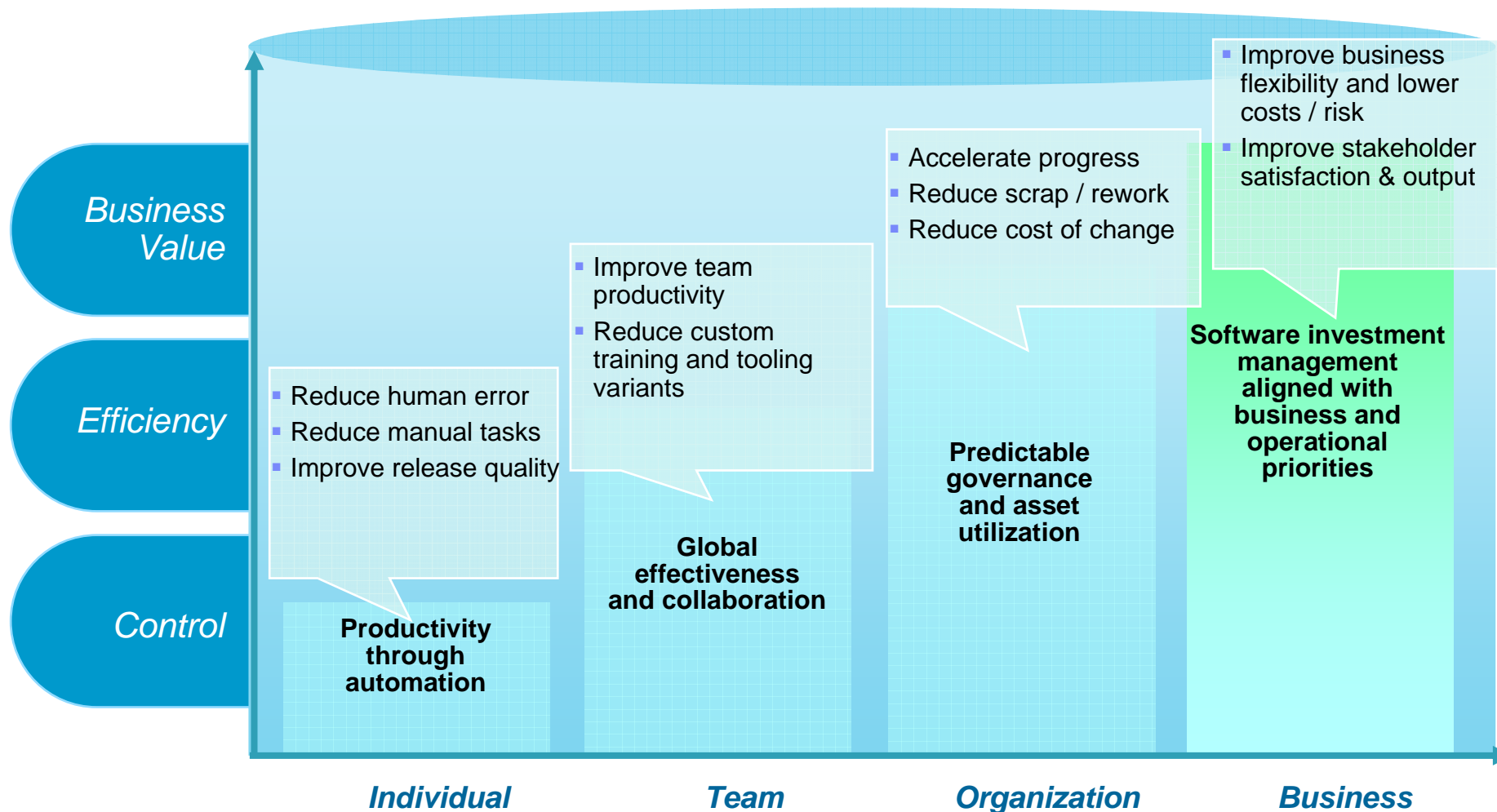

## Rational solutions can help in 3 domains

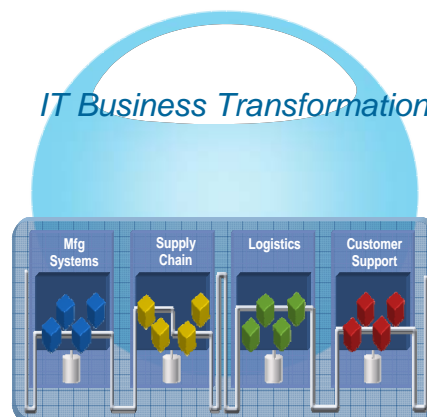

- **Enterprise Modernization** – harness the same power and flexibility for all types of applications, no matter what platform they are deployed on
- **IT Business Transformation** – align your IT infrastructure with your business strategy and vision to innovate new business strategies and meet long term objectives
- **Complex/Embedded Systems** – deliver innovative software for your products, while integrating across mechanical, electronic, and software domains

# Key modernization challenges for IT organizations



*"We don't understand the effort, risk and impact of modernizing our legacy software portfolio"*



*"Our skills gap just seems to keep growing. How do we stay current with all the language and technology changes?"*



*"Our architecture has evolved to be too complex and convoluted— we need to be flexible and agile."*

*"Our development teams working on different platforms are struggling to communicate. How do we collaborate in the context of our work?"*



## **Application Challenges**

- Lost application knowledge
- Architectural complexity
- Poor quality and performance
- Regulatory and compliance risks
- Higher costs

## **People Challenges**

- Skills lock-in
- Plethora of new technologies
- Unattractive, low productivity tools
- Steep learning curve due to platform/language-unique tools

## **Team Challenges**

- Poor communication
- Incompatible tools & processes across platforms
- Weak project oversight
- Lack of traceability across lifecycle

# Enterprise Modernization solutions

*A smarter way to maximize the value of your applications, people and teams*

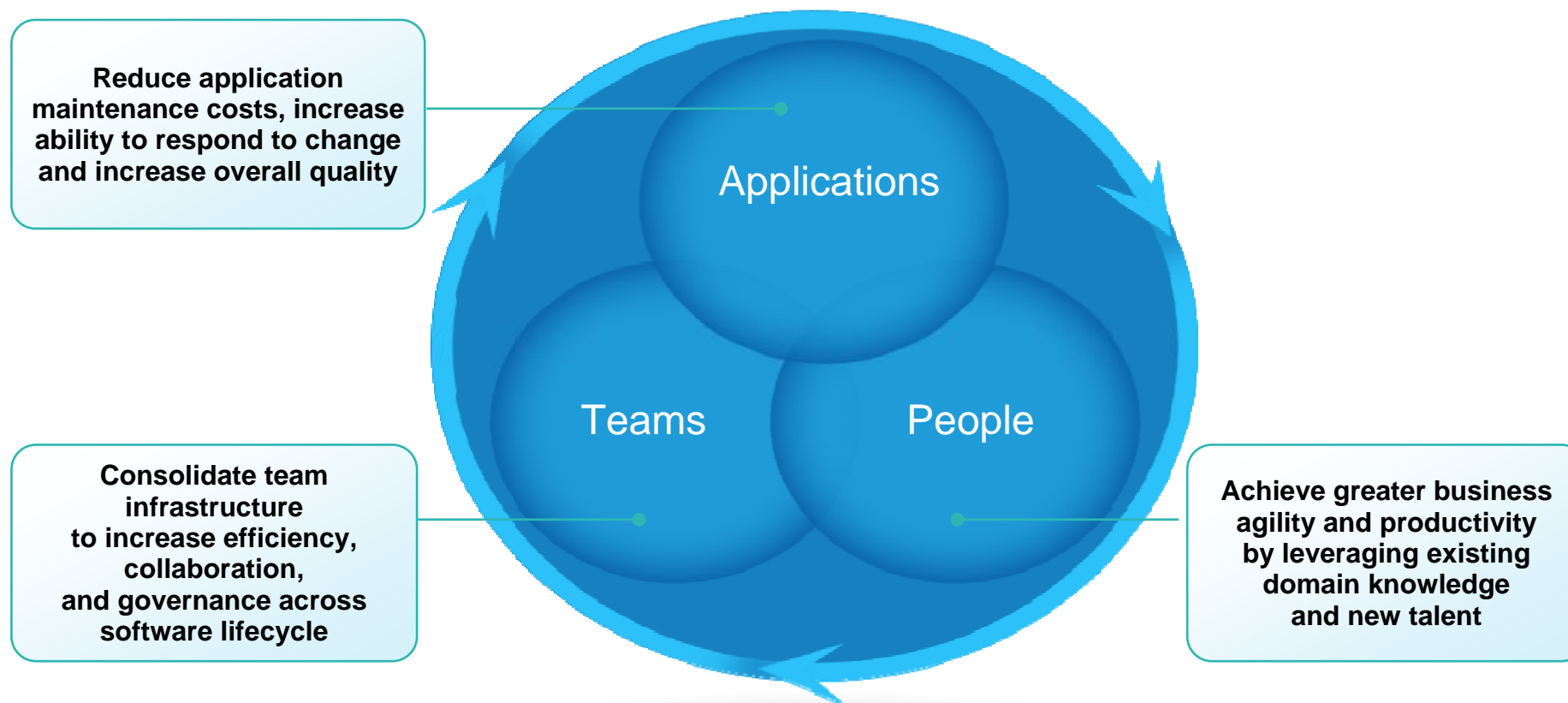

For more information, visit:  
[www.ibm.com/rational/modernization](http://www.ibm.com/rational/modernization)



# Enterprise Modernization solutions

*A smarter way to maximize the value of your applications, people and teams*

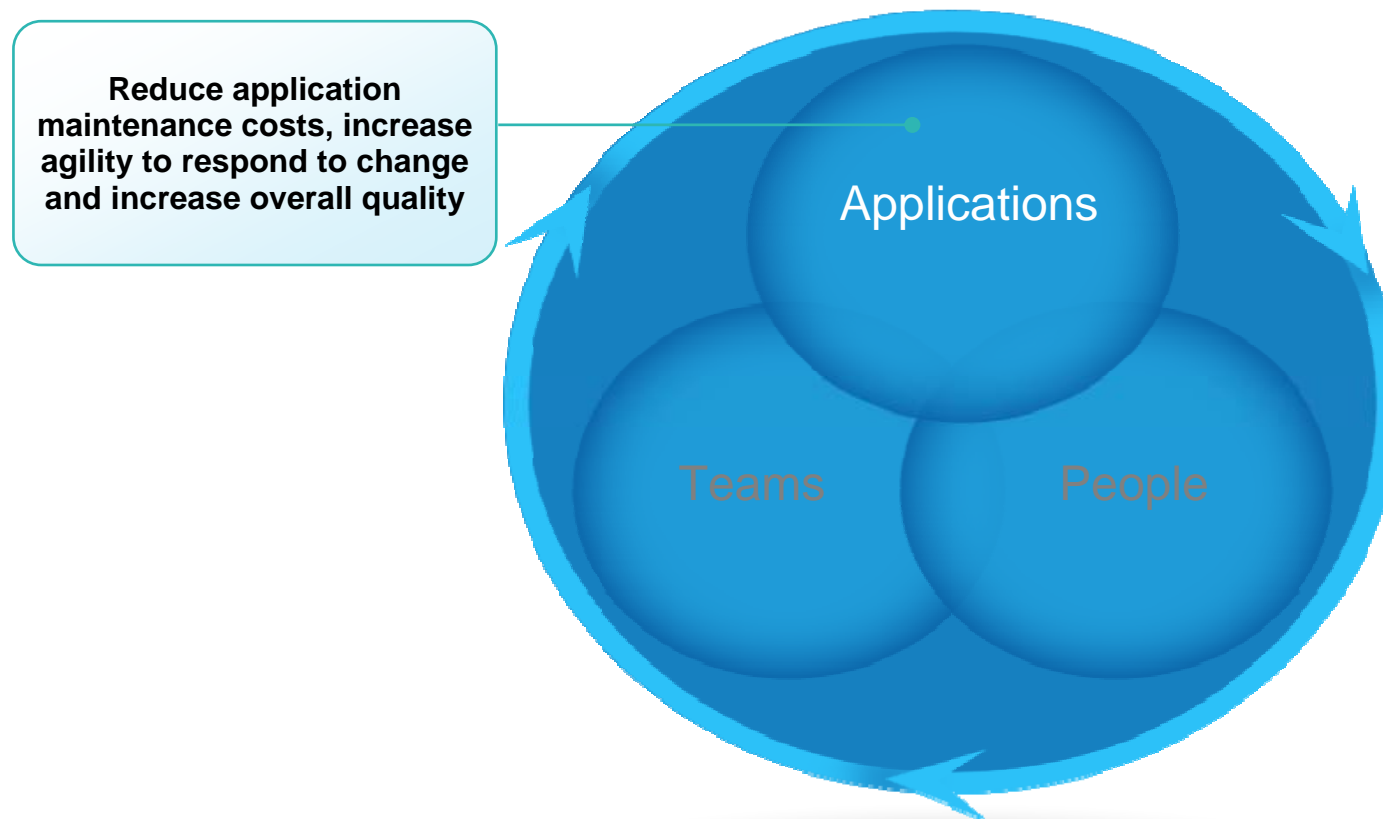

For more information, visit:  
[www.ibm.com/rational/modernization](http://www.ibm.com/rational/modernization)



## Enterprises want to

**Understand the impact and cost of change to their IT systems**

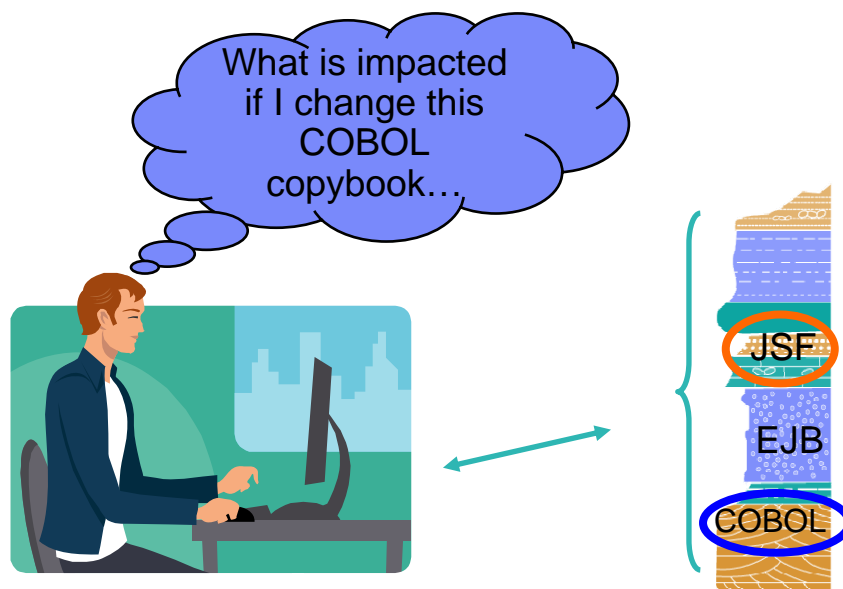

**But**

**They have no business intelligence inventory of their application assets, relying instead on manual and error-prone processes and incomplete knowledge. They must compensate with more extensive planning and extra testing.**

# Solution: Business intelligence for applications

Restore lost application knowledge via technical analysis

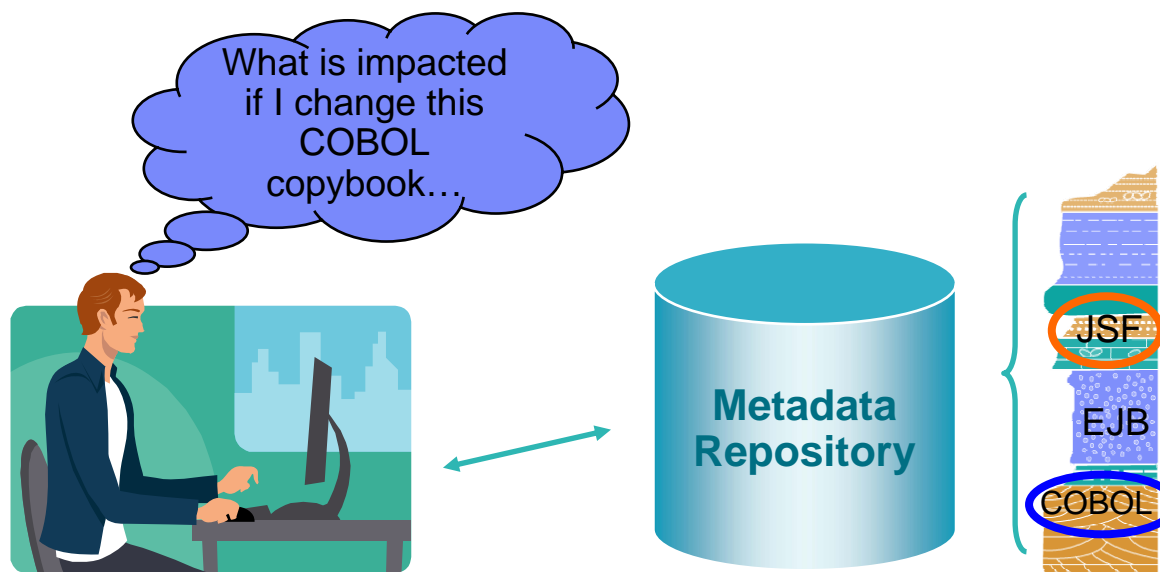

*Rational Asset Analyzer*  
*WebSphere Studio Asset Analyzer*

## Delivering

Reduced risk by quickly determining the full impact of proposed changes and lowered costs via dead code elimination, optimal planning, focused testing and faster development

## Enterprises want to

**Better align IT activities and investments with their business goals and objectives**

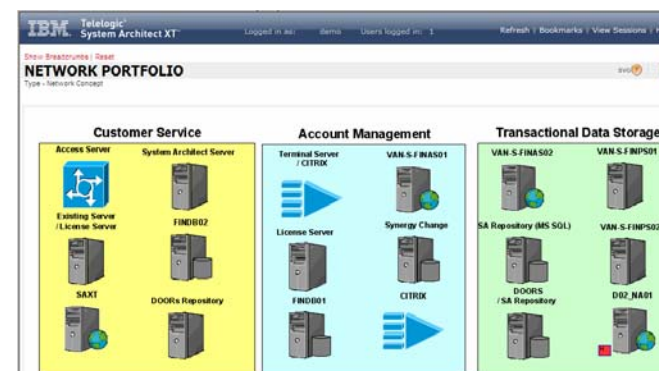

## But

**They do not have a tool or process for capturing business goals or prioritizing projects, nor for linking them to the associated IT efforts. They rely instead upon less rigorous verbal discussions and difficult-to-maintain documents.**



# Solution: Enterprise architecture and portfolio management

**Make enterprise IT planning actionable and trackable**



*Rational System Architect  
Rational Focal Point for Product  
and Portfolio Management  
Rational Focal Point for Project  
Management*

**Beta**

## Delivering

**Prioritization of competing projects, impact analysis of portfolio decisions, assurance projects remain aligned with business goals, and central oversight of budget, risks, demands and investment management**

## Enterprises want to

Have a nimble IT organization that leverages SOA to respond more quickly to the needs of the business

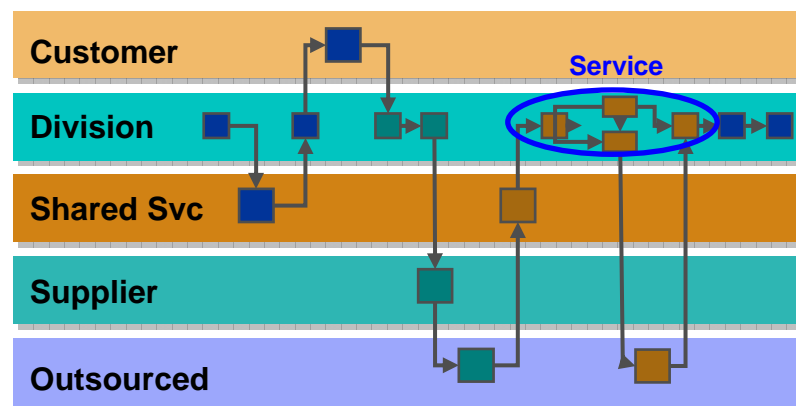
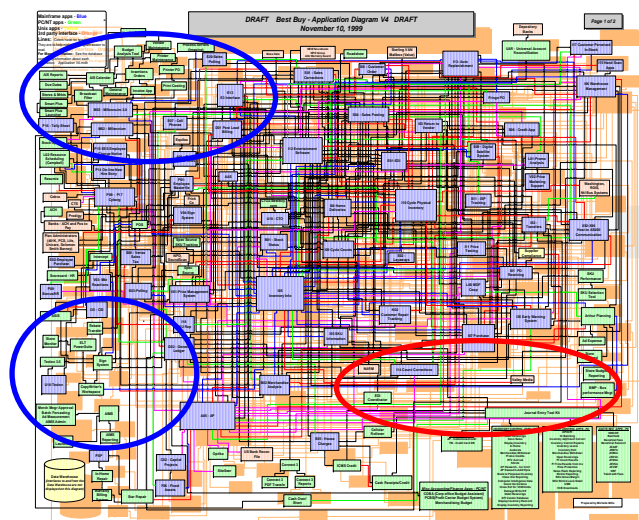

But

They have application architectures that were built incrementally over the last 20-30 years and are no longer flexible or agile



# Solution: SOA tools for all platforms, languages

Use powerful tools to quickly begin SOA evolution by leveraging the proven assets that have been running the enterprise for years, and then accelerate with visual specifications and platform-independent services

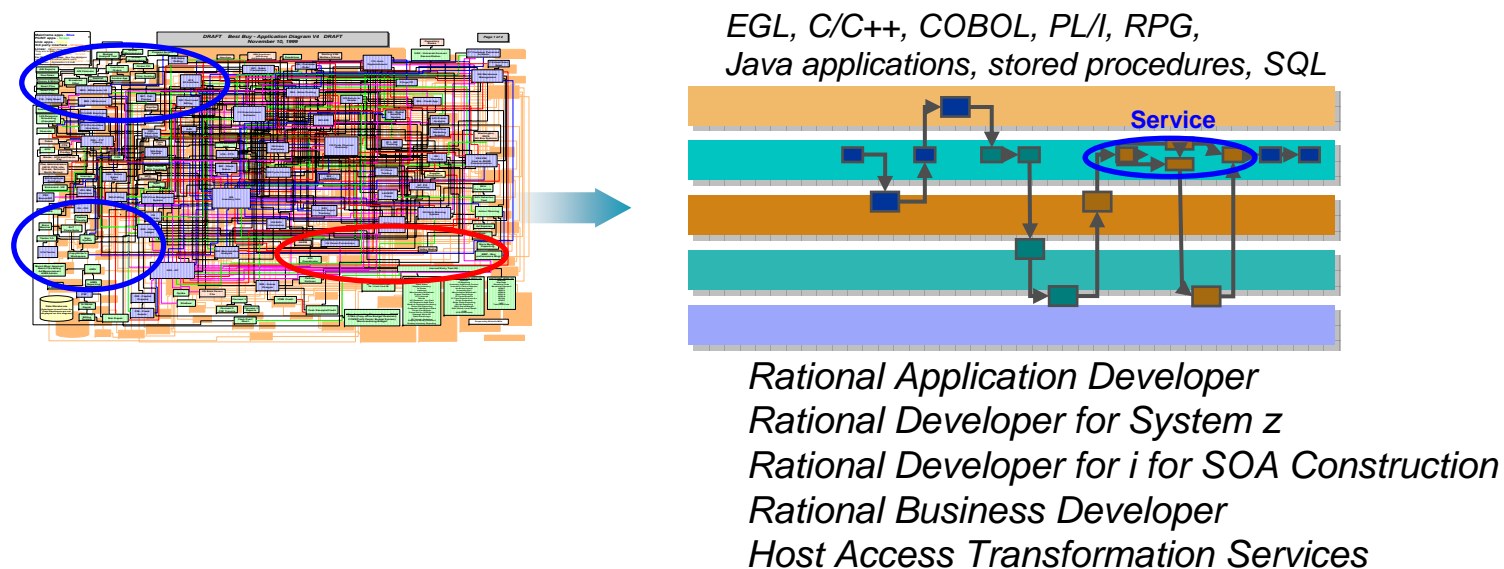

## Delivering

5x lower costs through reuse of existing assets, higher productivity and platform portability of new services



## Enterprises want to

**Reuse existing assets to reduce duplication and speed time to market**

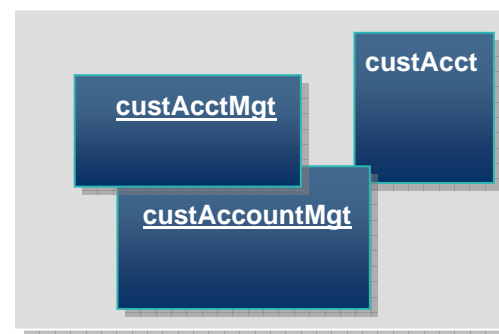

**But**

**They do not have the infrastructure to implement a reuse culture**



## Solution: Operational reuse



**Instill proactive asset management of all IT artifacts into the organization's processes and culture by deploying a reuse infrastructure**

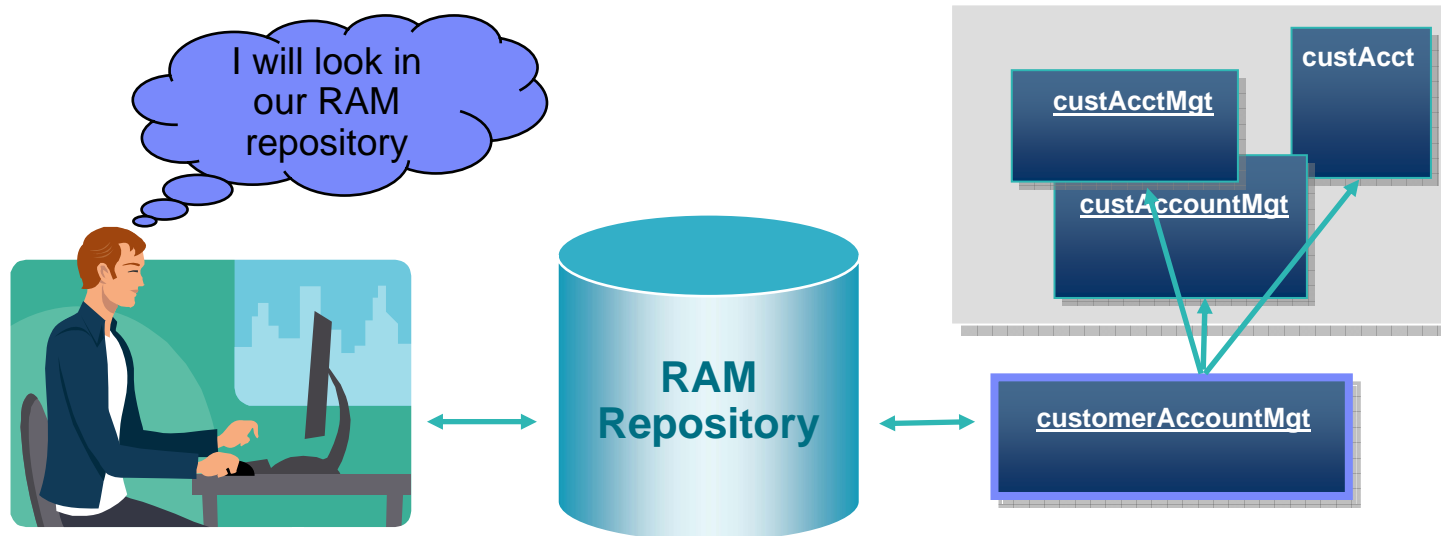

*Rational Asset Manager  
WebSphere Service Registry and Repository*

## Delivering

**Greater reuse, development efficiency, faster time-to-market, and higher quality**

## Enterprises want to

**Provide a range of appealing, more intuitive user interfaces to increase employee productivity and boost customer satisfaction**

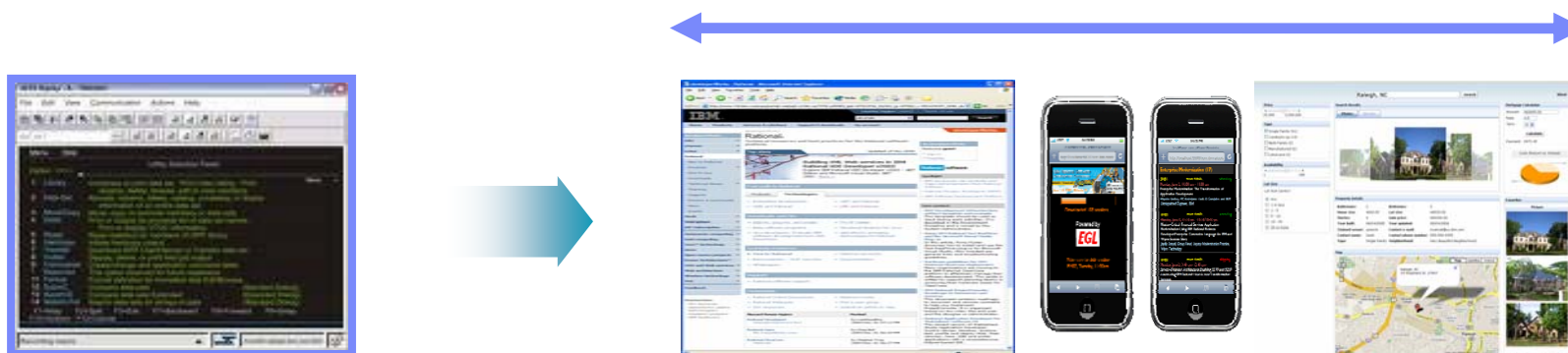

## But

**The cost of replacing or re-writing these applications is prohibitive, and they may not have the necessary web and UI technology skills**



## Solution: UI modernization

Deploy the ideal UI for your application, from quickly creating a modern web UI from an existing green screen application to customizing a highly interactive, graphical web 2.0 UI



*Host Access Transformation Services  
Rational Application Developer  
Rational Developer for System z  
Rational Business Developer*

## Delivering

Greater customer satisfaction, lower employee training costs, and fewer errors from more modern and compelling UIs



## Enterprises want to

**Maximize application performance on existing hardware to reduce capital expenses**



## But

**They have back-level compilers or are not fully using optimization**

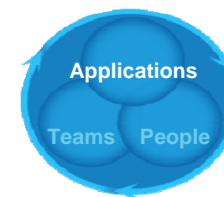

## Solution: Advanced Compiler Technology

Exploit new advanced optimization technology in C/C++, Java, COBOL, PL/I and Fortran compilers

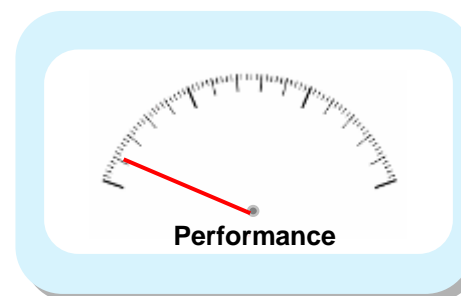

*IBM Compilers on System z*  
*IBM Compilers on POWER systems*

## Delivering

Lower capital outlays by increasing capacity on existing hardware, and improved performance of application suite

# Enterprise Modernization solutions

*A smarter way to maximize the value of your applications, people and teams*

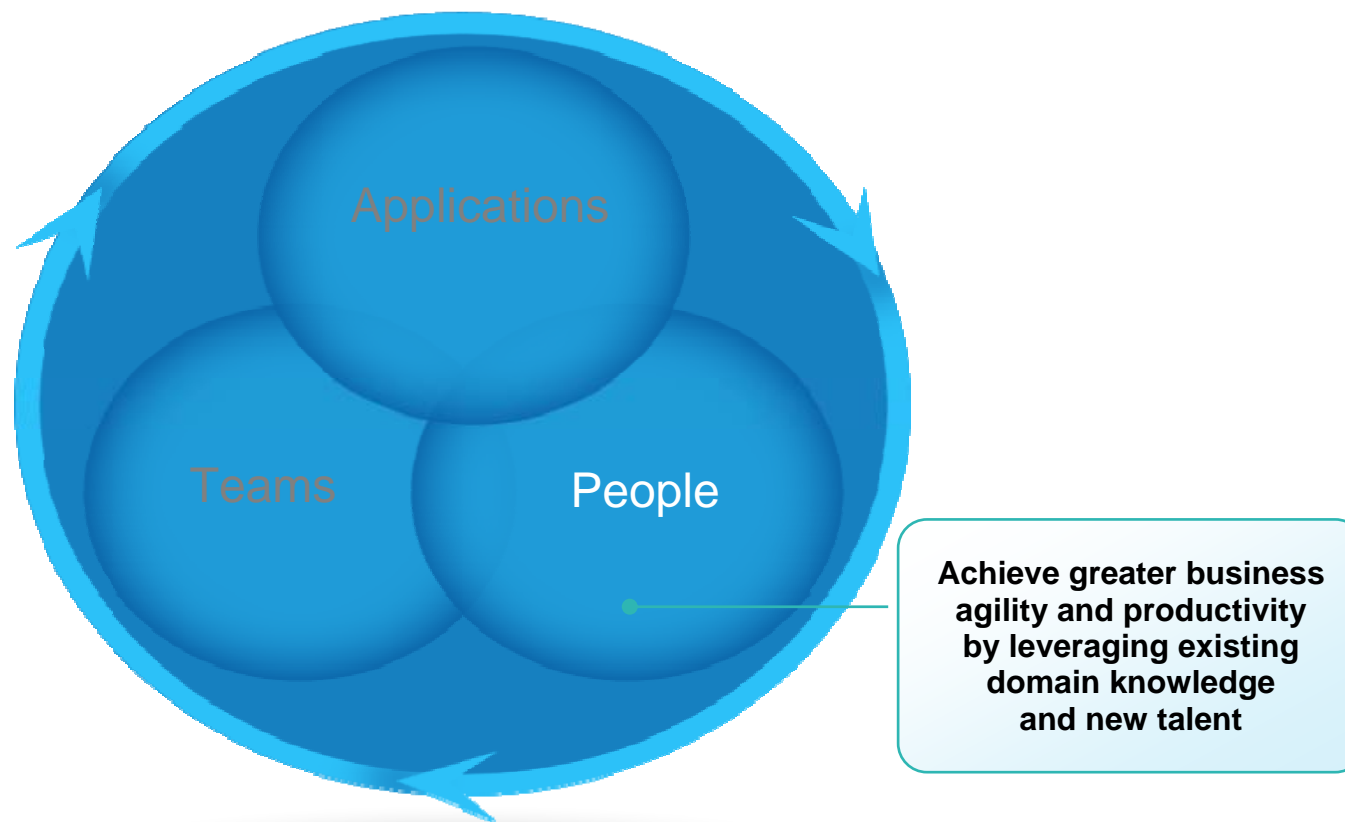

For more information, visit:  
[www.ibm.com/rational/modernization](http://www.ibm.com/rational/modernization)



Enterprises want to

**Increase productivity of their “backend” development staff, as well as attract new employees to this work**

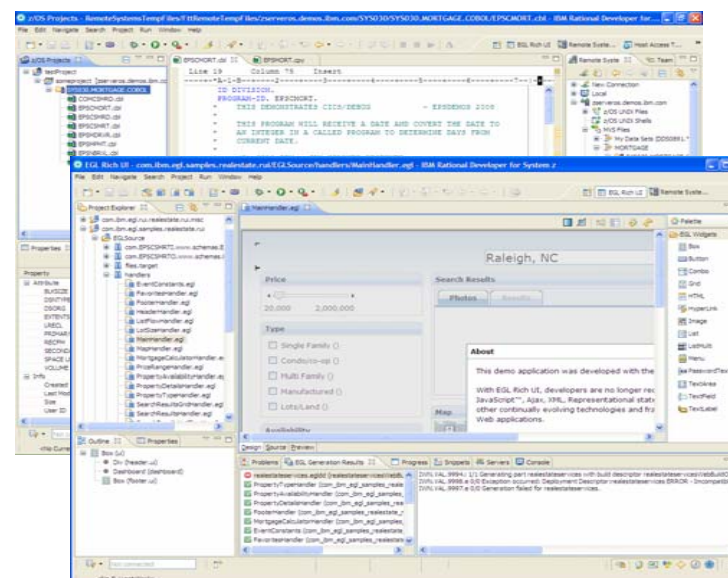
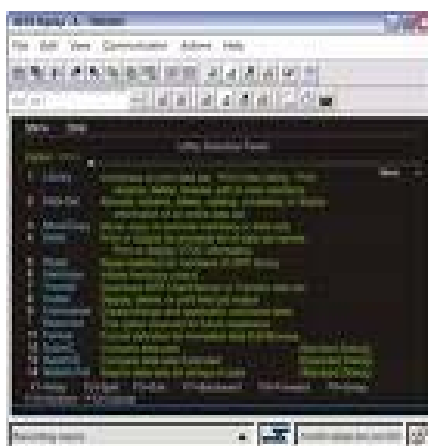

But

**They have antiquated development tools which deliver low productivity and are repulsive to younger staff**



## Solution: Modern IDEs for all platforms and languages

**Upgrade to modern Eclipse-based tools to develop and maintain enterprise applications spanning multiple platforms and languages**

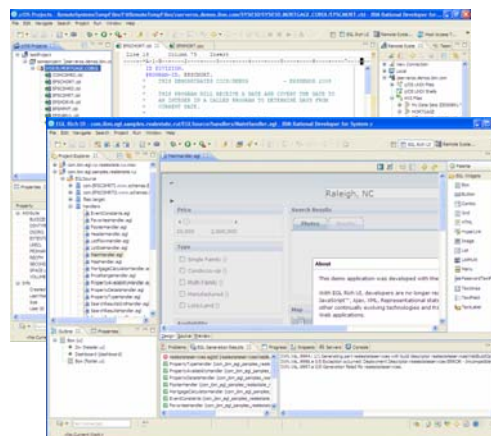

*Rational Developer for System z  
Rational Developer for System i  
Rational Developer for System i for SOA  
Rational Business Developer*

## Delivering

**50%-80%<sup>1</sup> reduction in host CPU usage with workstation syntax checking,  
~15% improvement in developer productivity<sup>1</sup>, and tools with which to  
attract new talent**

<sup>1</sup> Aggregation of results from a productivity study conducted by IBM System z customers.





# Enterprises want to

**Build modern, multi-platform applications with existing and new staff**

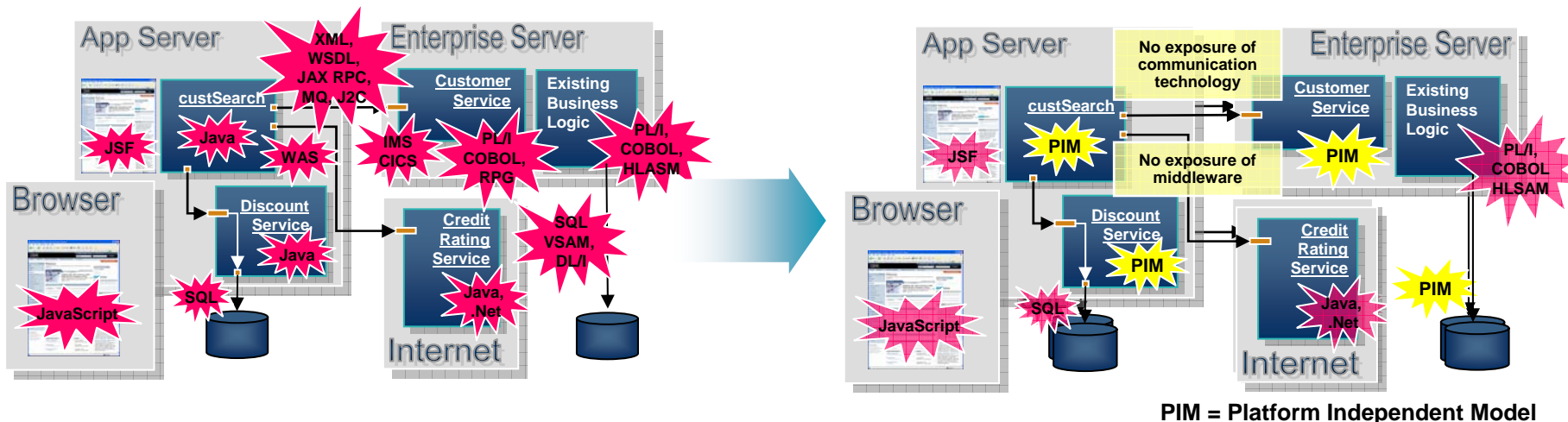

But

**They have different teams of developers for each platform, and re-training them to all the new technologies would be costly, time consuming, and often impractical**



# Solution: EGL – next gen business language

**Build new or extend existing multi-platform enterprise applications leveraging EGL with its middleware abstractions and high productivity language and development environment**

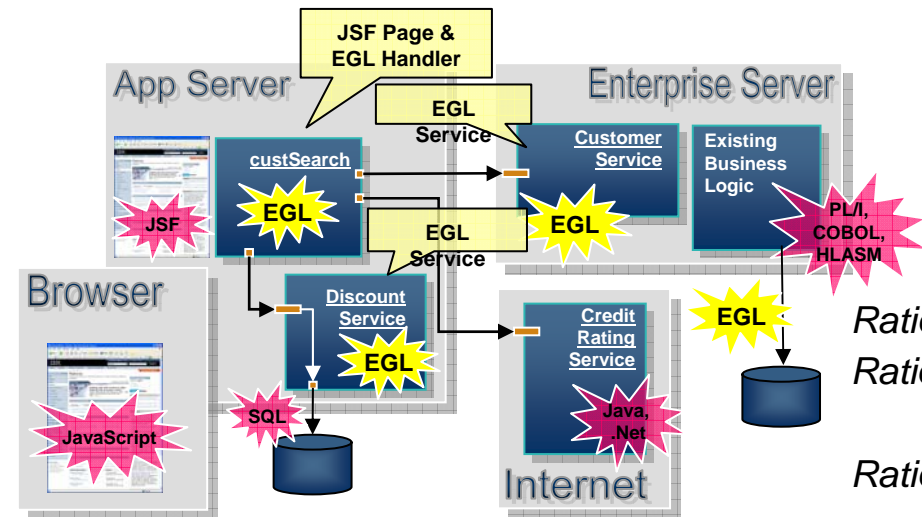

*Rational Business Developer  
 Rational Developer for  
 System z with EGL  
 Rational Developer for i  
 for SOA Construction*

## Delivering

**Skills flexibility, high productivity and platform portability for existing and new developers when building all types of modern enterprise applications**



## Enterprises want to

**Reduce tool support costs and move to modern platforms, languages, and tools for their multi-platform application development**

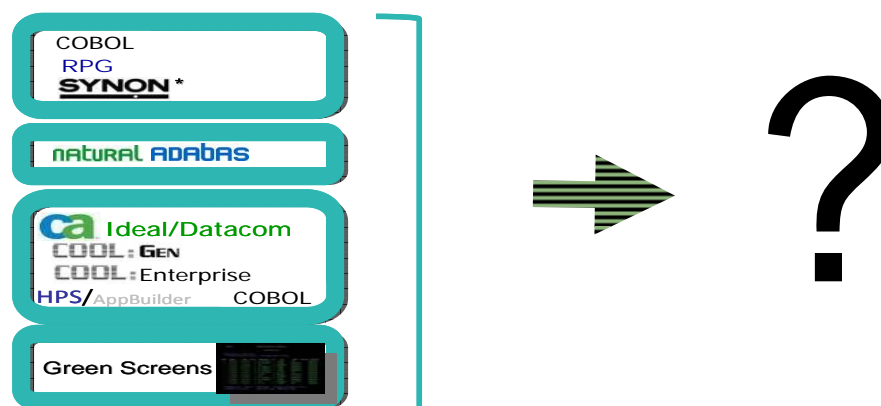

**But**

**They are stuck on poorly supported, expensive, legacy development platforms**



# Solution: Application transformation tools and services

**Migrate from old, stagnant languages to modern development platforms, languages and tools**

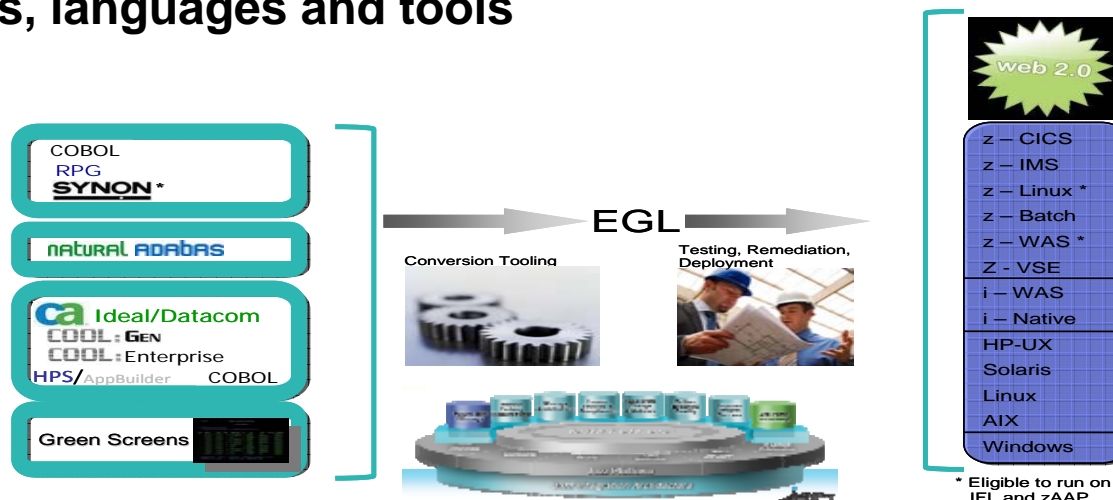

- Rational Migration Extension for Natural*
- Rational Migration Extension for IBM I*
- Rational Migration Extension for CA*
- Rational Migration Extension for Rich UI*

## Delivering

**Greatly reduced development platform support costs, and more flexible, integrated SDLC environment for making future application enhancements (eg. SOA and web 2.0)**



# Enterprises want to

## Maintain the necessary skills within their IT workforce

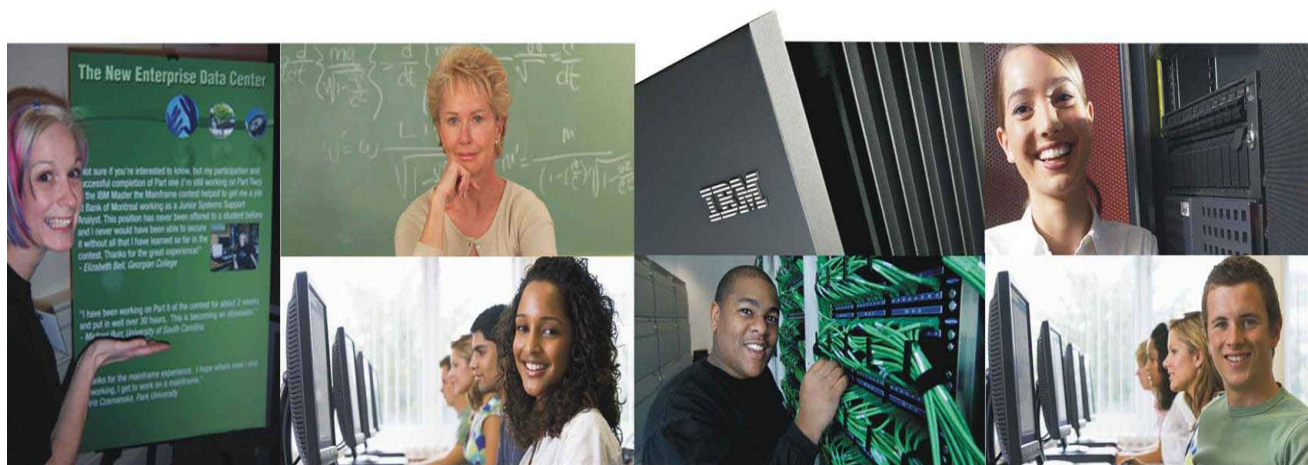

# But

**They are concerned about how they will replace experienced enterprise developers when they retire**



## Solution: Enterprise training programs

**Hire skilled employees from universities in the IBM Academic Initiative, and leverage IBM on-line resources to train existing staff**



*IBM Academic Initiative*  
*IBM Enterprise Modernization sandbox*  
*Community Cafés:*

- ✓ C/C++ Café
- ✓ EGL Café
- ✓ RPG Café
- ✓ COBOL Café

## Delivering

**New talent with enterprise skills, convenient training for existing employees, and a growing community of skilled business partners, customers, students and IBM employees**

# Enterprise Modernization solutions

*A smarter way to maximize the value of your applications, people and teams*

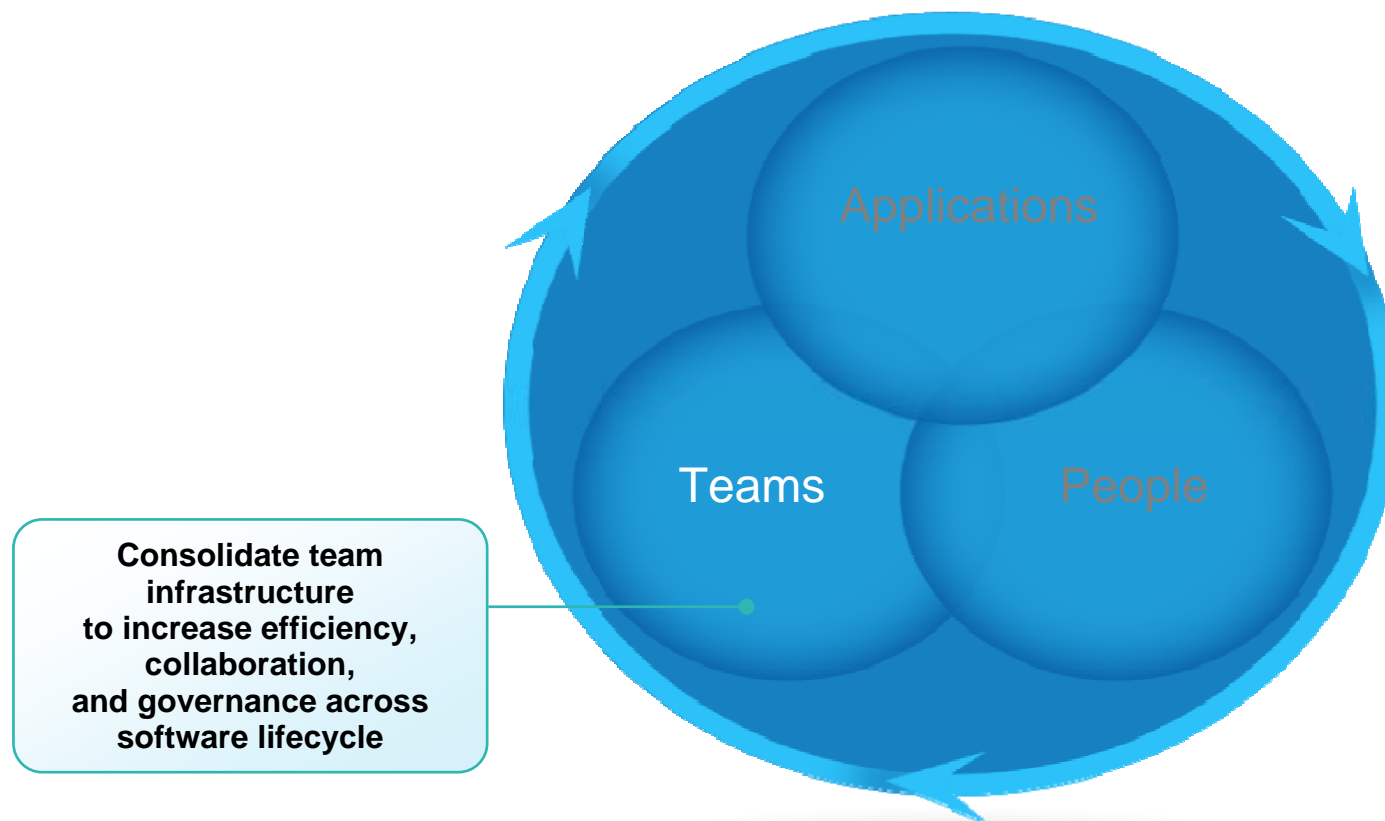

For more information, visit:  
[www.ibm.com/rational/modernization](http://www.ibm.com/rational/modernization)



## Enterprises want to

Quickly build and deploy composite applications and reduce their team infrastructure costs

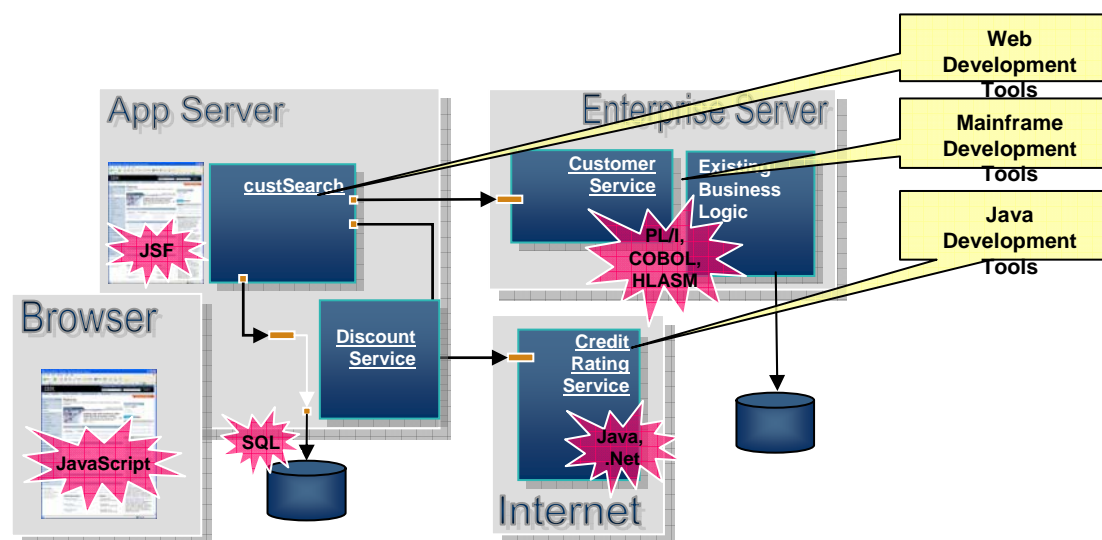

But

They have different tools, processes and team infrastructure for each deployment platform, greatly complicating development of composite apps, and they are using expensive, legacy SCM tools





## Solution: Consolidated team infrastructure

Standardize, consolidate and simplify the team infrastructure for multi-platform projects including source code management, problem tracking, and build

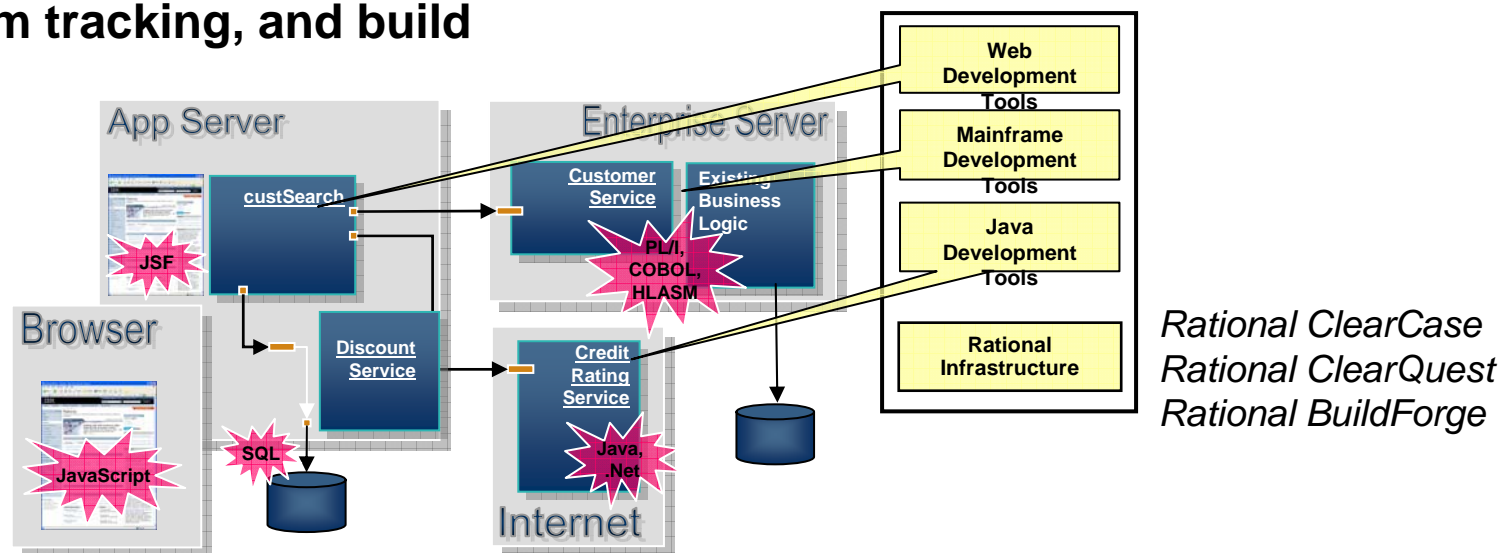

## Delivering

Reduced costs, improved quality, greater team efficiency, and a comprehensive, holistic view of the entire multi-platform development effort



## Enterprises want to

Enable agile, multi-platform and cross-geo collaboration and governance

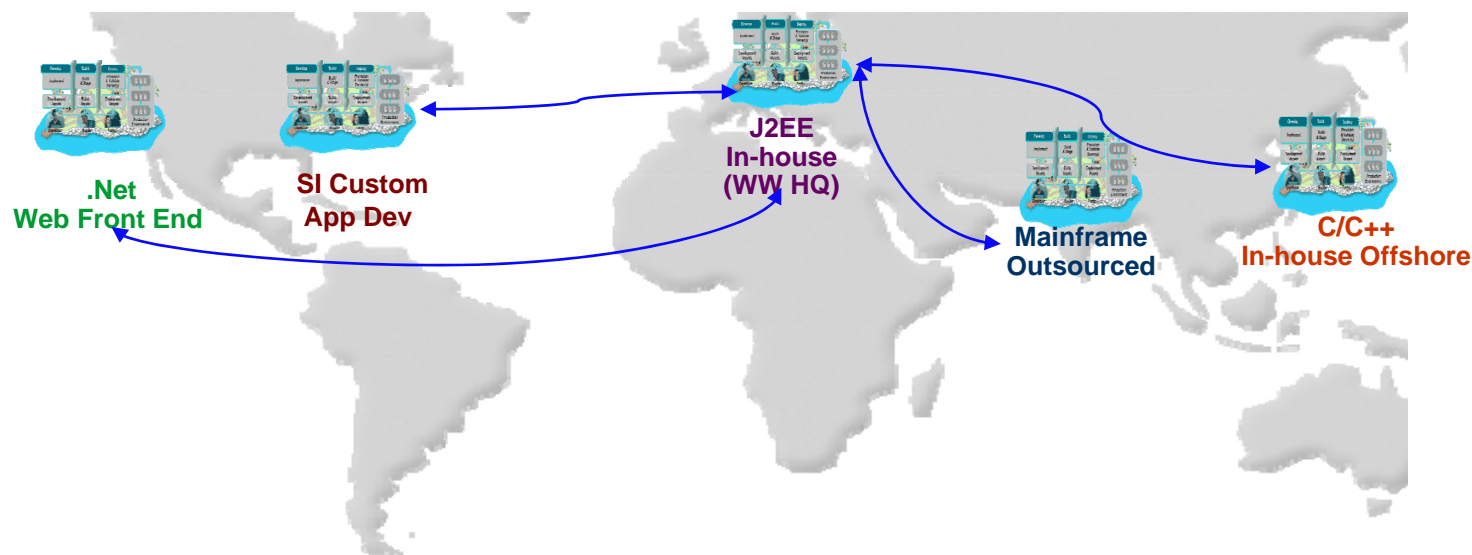

But

They have “islands” of development, each with different tools, processes and team infrastructure, and they do not support real-time collaboration or integrated, comprehensive oversight



## Solution: Modern team infrastructure

**Deploy new team infrastructure that supports collaboration in context across all platforms and geographies, real-time, automated monitoring of project health, and built-in development workflows**

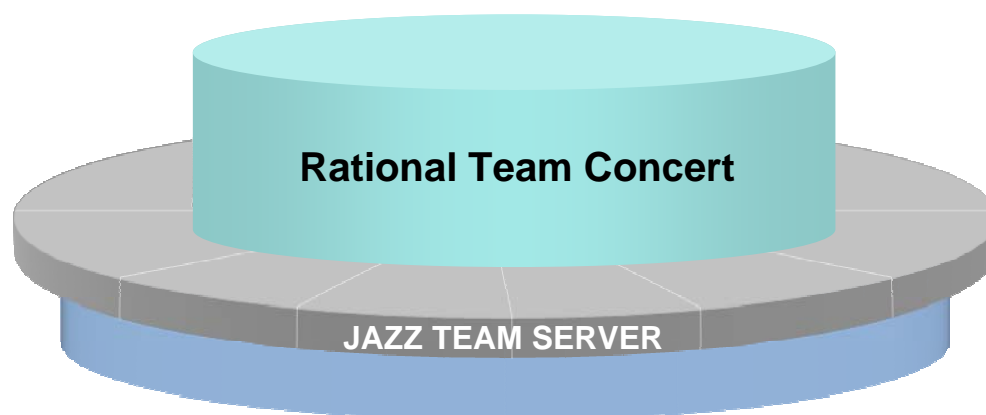

*Rational Team Concert for System z  
Rational Team Concert for IBM i  
Rational Team Concert*

## Delivering

**Improved communication, higher quality, informed decision-making, and more automated, transparent and predictable software development**

# Rational Enterprise Modernization Solutions

*Lowering the cost of multi-platform application development and delivery*

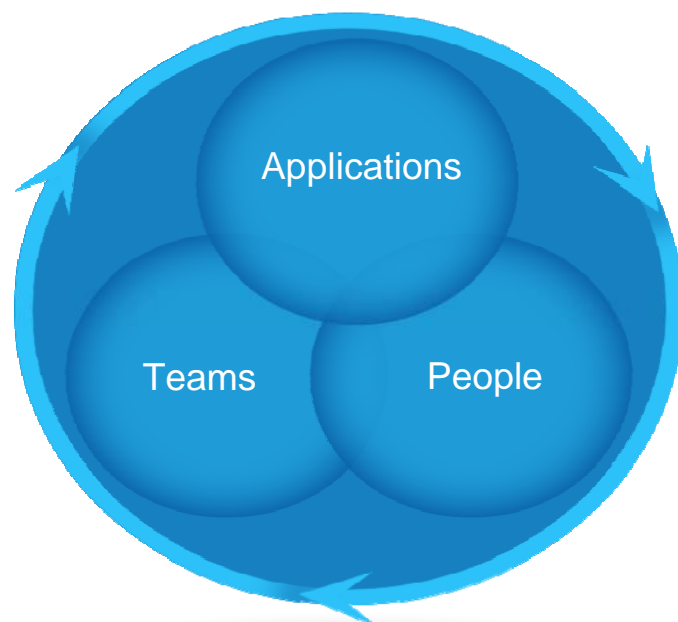

- ✓ **Difficult times present opportunities to companies that can adapt quickly**
- ✓ **IT frequently inhibits flexibility due to fragile and poorly understood applications, limited staff productivity, poor collaboration and traceability across teams**
- ✓ **Rational Enterprise Modernization solutions deliver flexibility by:**
  - ▶ Improving how you build, maintain, and manage your Applications
  - ▶ Helping your People be more productive
  - ▶ Consolidating Teams across locations, roles, and platforms

# Rational Developer for System z 7.6

- Faster content assist, searching and editing
- Real-time syntax checking
  - Support for COBOL, PL/I, CICS and DB
- Better Integration
  - CICS TS 4.1, IMS V11
  - CA Endeavor Software Change Manager
  - IBM File Manager
  - Rational Team Concert for System z

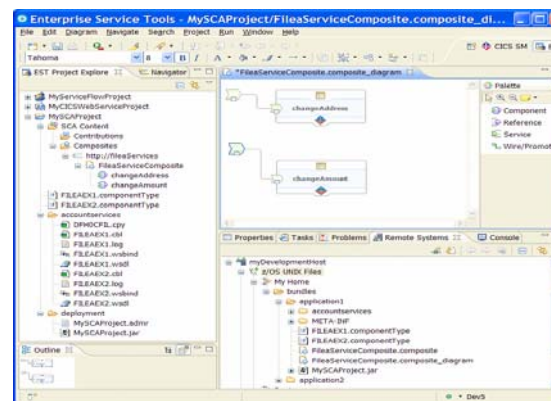

# Rational Team Concert for System z 2.0

- System z repository option using z/OS or Linux for System z
- Host SCM Co-existence - Endeavor, ChangeMan, SCLM
- z/OS File and Build Agents
  - Manage z/OS artifacts (Cobol, PL/I...)
  - Build with Antz or JCL
- System z process templates - designed for mainframe development
- RDz integration
  - In-context collaboration
  - Collaborative debugging with IBM Debug Tool



# Rational EGL Community Edition

- **Simplify development of Web 2.0 solutions – for free!**
  - Client and server side code is written in one language (EGL) and is compiled into standard JavaScript and Java
- **Eclipse-based development environment**
  - WYSIWYG visual editor
  - Instant application previewing without deploying to a server
  - Full debug support for client and server-side code
  - Small download, simple install – get up and running quickly!
- **Rich Web user interfaces using Dojo**
  - Fully extensible architecture supports other popular JavaScript widget libraries
- **Build Java-based Web services without coding in Java**
  - Take advantage of EGL's powerful keywords for accessing data in most popular databases
- **Fully functional, but no-cost**
- **Spend more time innovating and less time fighting with technology!**





## Statistics

- **1,200 downloads** in the first 5 days
- **Over 1,800** views of "Hello World with EGL" video on YouTube
- Press coverage: InfoWorld, SearchSOA, The Register, InternetNews.com, Dr. Dobb's, System i Network, D'Technology, and others.







Check out the EGL CE video on YouTube!



**Download EGL Community Edition today!**

<http://www.ibm.com/software/rational/cafe/community/egl/ce>

## System z Solution Edition for Application Development

- Build a Private Cloud for development of new workloads for System z
- Through use of z/VM developers can bring up and take down mainframe system images when they would like to versus when the IT Operations team tells them it is okay
- Target development environment has operational fidelity with the production environment.
- Cost structure has been developed to make this affordable and accessible to all developers in a business.
- Leveraging separately priced RDz, a business can target workloads for the best business value on the mainframe and distributed systems.



***Gain a competitive advantage for your business,  
with IBM System z technology***

# Leverage IBM Services to get started today

- **Executive Services**
  - ▶ Schedule an *Enterprise Modernization Executive Planning Session* to define modernization strategies
  
- **Application Modernization Services**
  - ▶ Application Assessments to:
    - ▶ Develop Modernization roadmaps to resolve specific business issues
    - ▶ Improve Application Quality & Performance
    - ▶ Identify opportunities for business software delivery improvements
  
- **People and Team Modernization Services**
  - ▶ Provide Implementation Services for Rational Enterprise Modernization tools
  - ▶ Provide SCM migration assistance
  - ▶ SDLC Assessments to:
    - ▶ Improve Software Delivery performance
    - ▶ Implement Software Delivery Metrics to more effectively manage the software development environment

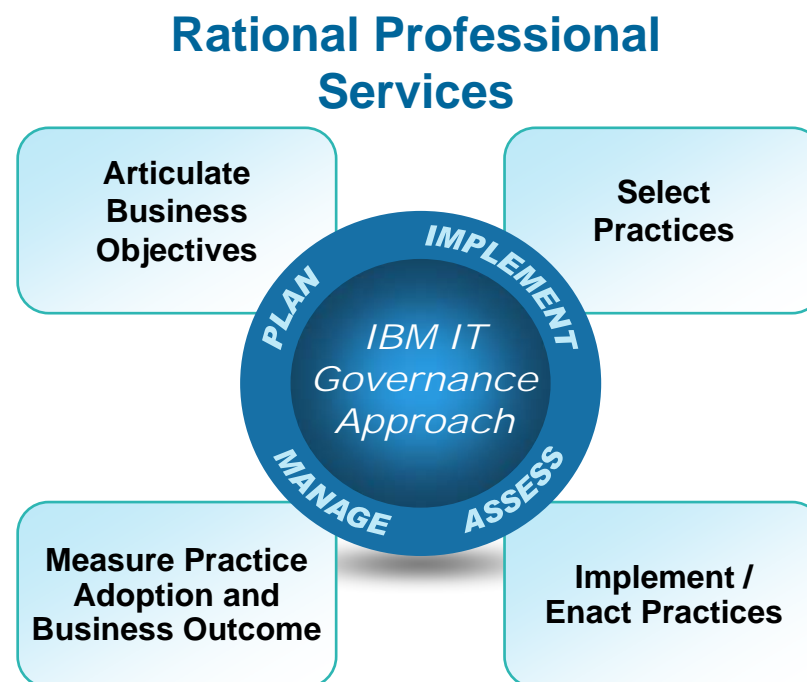



## To learn more...

**e-kit: IBM System z can do it**

<http://www-01.ibm.com/software/os/systemz/emekit/index.html>

**Webcast on 10/20 SAVE MONEY NOW: Cross-Platform Software Configuration Management Consolidation**

[https://www14.software.ibm.com/webapp/iwm/web/preLogin.do?lang=en\\_US&source=dw-c-wcsdpr&S\\_PKG=102009](https://www14.software.ibm.com/webapp/iwm/web/preLogin.do?lang=en_US&source=dw-c-wcsdpr&S_PKG=102009)

**Webcast on 11/4: Webcast Bridging the IT Silos: An evolutionary approach to Application Development & Delivery**

<http://www-01.ibm.com/software/os/systemz/webcast/nov4/>

**Webcast on 11/18: Forrester Analyst: Phil Murphy - IBM Rational Change and Release Management solution vs. CA Endevor**

<http://www-01.ibm.com/software/rational/webcasts/index.html>

**Online Virtual Product Trials: Enterprise Modernization Sandbox for System z**

[http://www.ibm.com/developerworks/downloads/emsandbox/systemz.html?S\\_TACT=105AGX23&S\\_CMP=EM](http://www.ibm.com/developerworks/downloads/emsandbox/systemz.html?S_TACT=105AGX23&S_CMP=EM)

**New Announcement Page: IBM Rational Enterprise Modernization Solutions**

<http://www-01.ibm.com/software/rational/announce/modernization/>

**Home Page: IBM Rational Enterprise Modernization Solutions**

<http://www-01.ibm.com/software/rational/solutions/em/>

**Virtual communities: IBM Rational Café Communities Portal**

<http://www-949.ibm.com/software/rational/cafe/index.jspa>

**New IBM Compilers Flash Demo:**

[http://ibmtvdemo.edgesuite.net/software/rational/demos/IBM\\_Compilers\\_Flash\\_Demo.zip?cm\\_sp=CT548-\\_-SW760-\\_-7315](http://ibmtvdemo.edgesuite.net/software/rational/demos/IBM_Compilers_Flash_Demo.zip?cm_sp=CT548-_-SW760-_-7315)



Thank  
You

© Copyright IBM Corporation 2009. All rights reserved. The information contained in these materials is provided for informational purposes only, and is provided AS IS without warranty of any kind, express or implied. IBM shall not be responsible for any damages arising out of the use of, or otherwise related to, these materials. Nothing contained in these materials is intended to, nor shall have the effect of, creating any warranties or representations from IBM or its suppliers or licensors, or altering the terms and conditions of the applicable license agreement governing the use of IBM software. References in these materials to IBM products, programs, or services do not imply that they will be available in all countries in which IBM operates. Product release dates and/or capabilities referenced in these materials may change at any time at IBM's sole discretion based on market opportunities or other factors, and are not intended to be a commitment to future product or feature availability in any way. IBM, the IBM logo, Rational, the Rational logo, Telelogic, the Telelogic logo, and other IBM products and services are trademarks of the International Business Machines Corporation, in the United States, other countries or both. Other company, product, or service names may be trademarks or service marks of others.