

System z Decision Management

Where business rules and events are transformed

Presenter – Title

Date



Agenda

- ▶ Operational Decisions: the why and the what
- ▶ WebSphere Operational Decision Management: the how
- ▶ Synergy with decision management
- ▶ Adoption
- ▶ Operational Decision Management use cases
- ▶ Next steps

Agenda

- ▶ Operational Decisions: the why and the what
- ▶ WebSphere Operational Decision Management: the how
- ▶ Synergy with decision management
- ▶ Adoption
- ▶ Operational Decision Management use cases
- ▶ Next steps

The business environment is increasingly dynamic

CEOs expect change to be more frequent and less predictable

To what extent is the economic environment different?

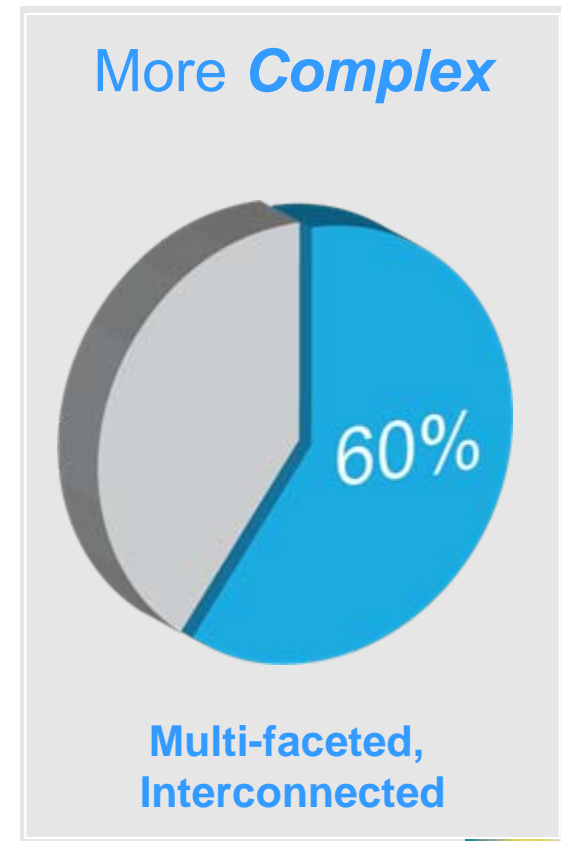
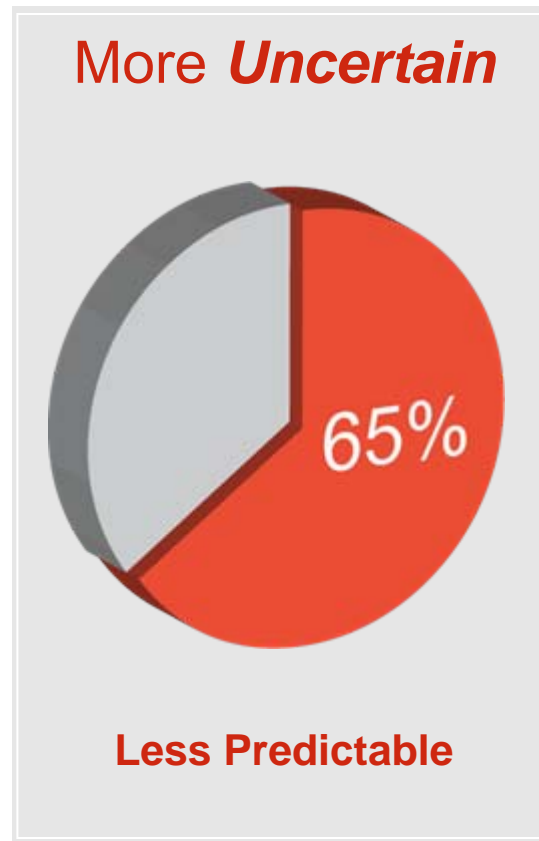
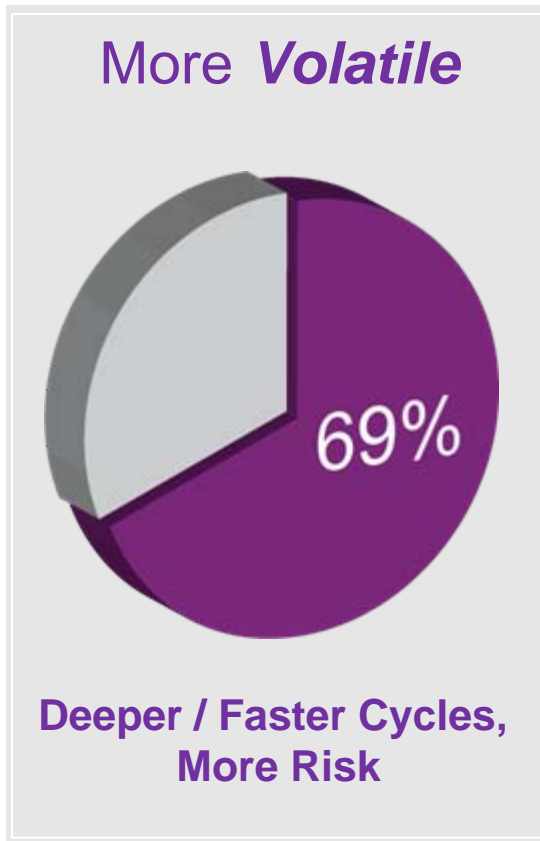

Percent of CEOs who answered "**To a large or very large extent**"

Source: IBM CEO Study 2010



Why better decisions are critical to success

Accurate, real-time decisions improve business performance and results



Identify opportunities to *increase profitability*



Enforce consistency to *ensure compliance*



Leverage information to *manage risk*

“Decisions are what make strategy real and drive results and performance against metrics... decisions made about how to interact with partners, suppliers, customers, employees.”

James Taylor, “Becoming a Decision-centric Organization,” 2011

What is Decision Management?

Decision Management is a business discipline, supported by **operational** and **analytics** software, that enables organizations to automate, optimize and govern repeatable business decisions to improve the value of customer, partner and internal interactions.

Business Processes, Applications & Solutions

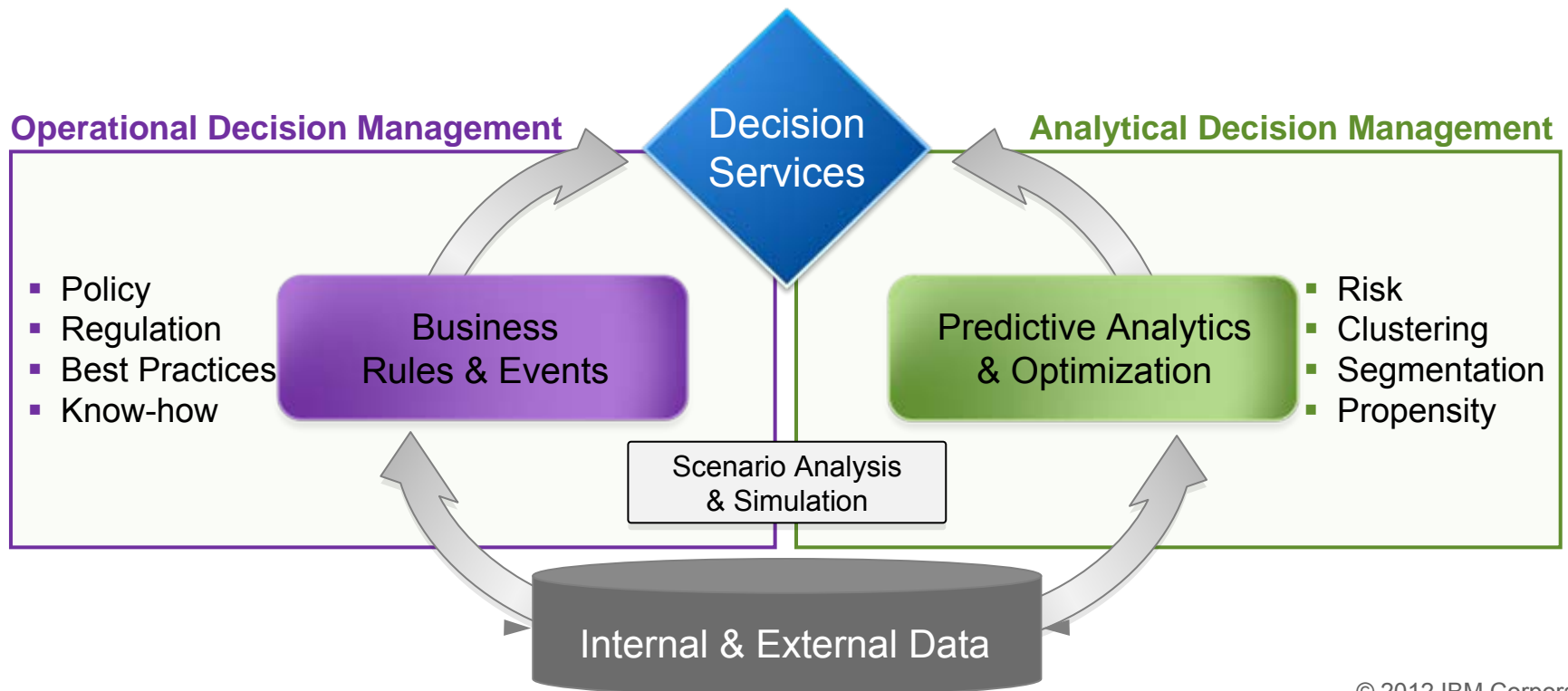

Operational Decision Management

Business Rules

Primarily implements a decision model - given a snapshot view of data, determines best course of action at a specific point in a process or application

Main purpose is to automate a decision based on a combination of factors (business policies, regs., best practices)

If the **Passenger** is a **gold frequent traveler** and the **flight distance** is more than 4000 miles and the **flight destination** is in Europe or Asia Then Add 10.000 points to the fidelity card of the **Passenger**

Business Events

Primarily implements a time-based pattern detection model – correlating events as data is in motion

Main purpose is to determine what of interest is transpiring and coordinate one or more responses by other systems or generate alerts to people

If more than 2 **customer withdraws in an ATM** are done **in the same day** and the 2 ATMs are from 2 foreign countries Then **Investigate possible fraud**
Reduce to cash redraw max amount to 100\$



Gartner characterizes Rules and Complex Event systems as complementary notions. The combination being required to implement intelligent decision management programs.

Business Rules in organizations

Can get quite large

Are scattered everywhere

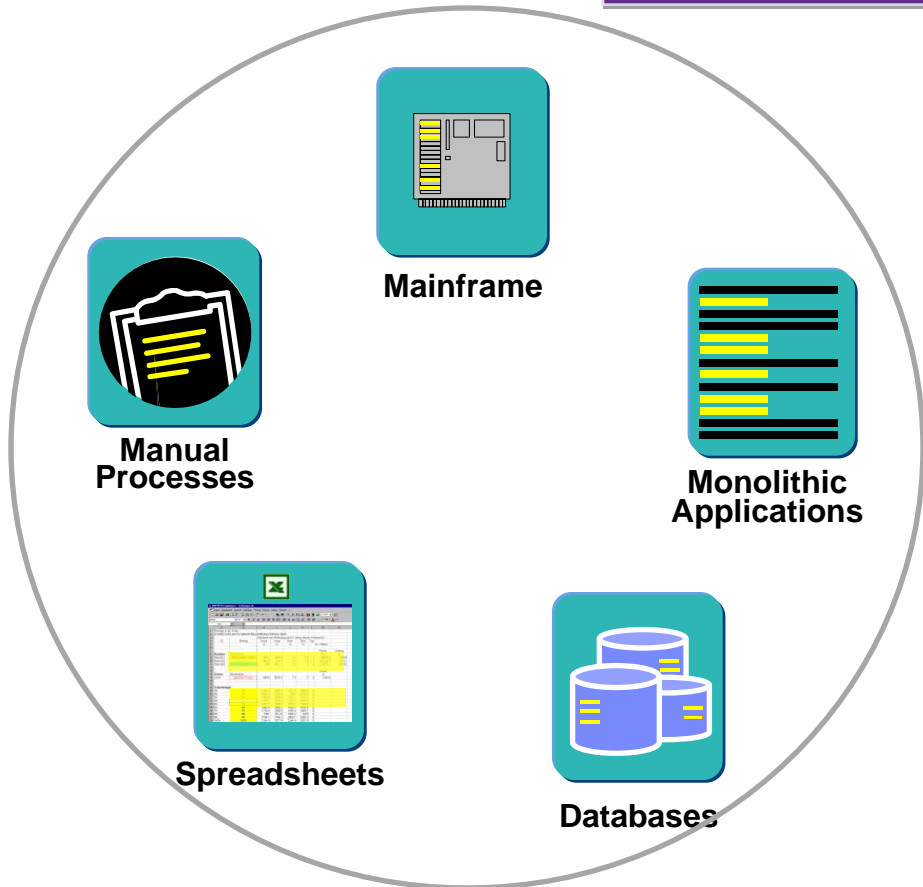

Are subject to change

Challenges for a Change Request

- **Changes are costly, resource & time-intensive**
 - Rules are hidden in code
 - Most changes have to be programmed – costly
- **Lack of consistency**
 - No central management of rules
 - No reuse of rules
- **Gap between business analysts & IT administrators**
 - Business rules knowledge fades over time
- **Lack of auditability**
- **No easy way to test/simulate the change**

Business Rule Management System

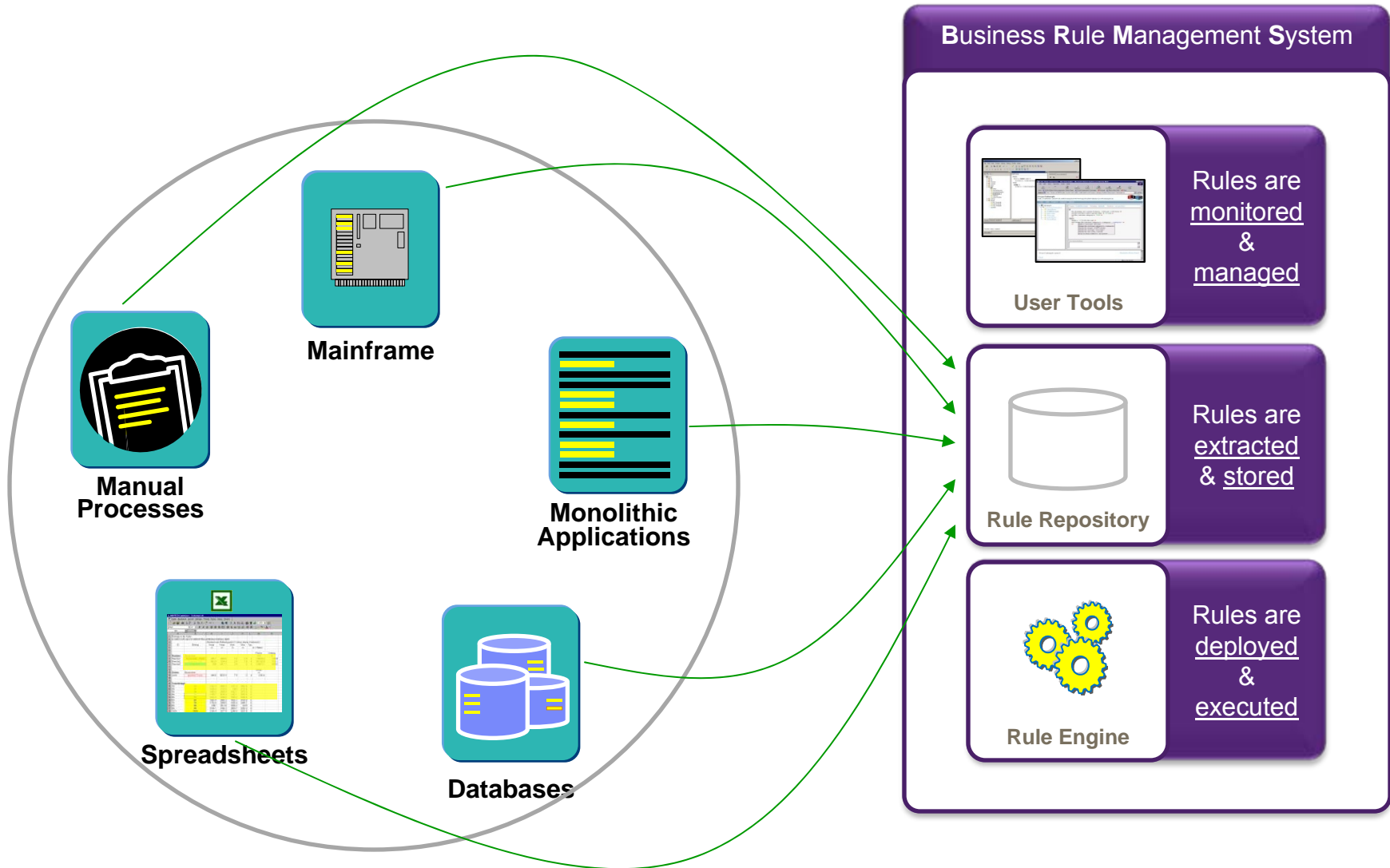

Agenda

- ▶ Operational Decisions: why and what
- ▶ WebSphere Operational Decision Management: how
- ▶ Synergy with decision management
- ▶ Adoption
- ▶ Operational Decision Management use cases
- ▶ Next steps

Introducing WebSphere Operational Decision Management

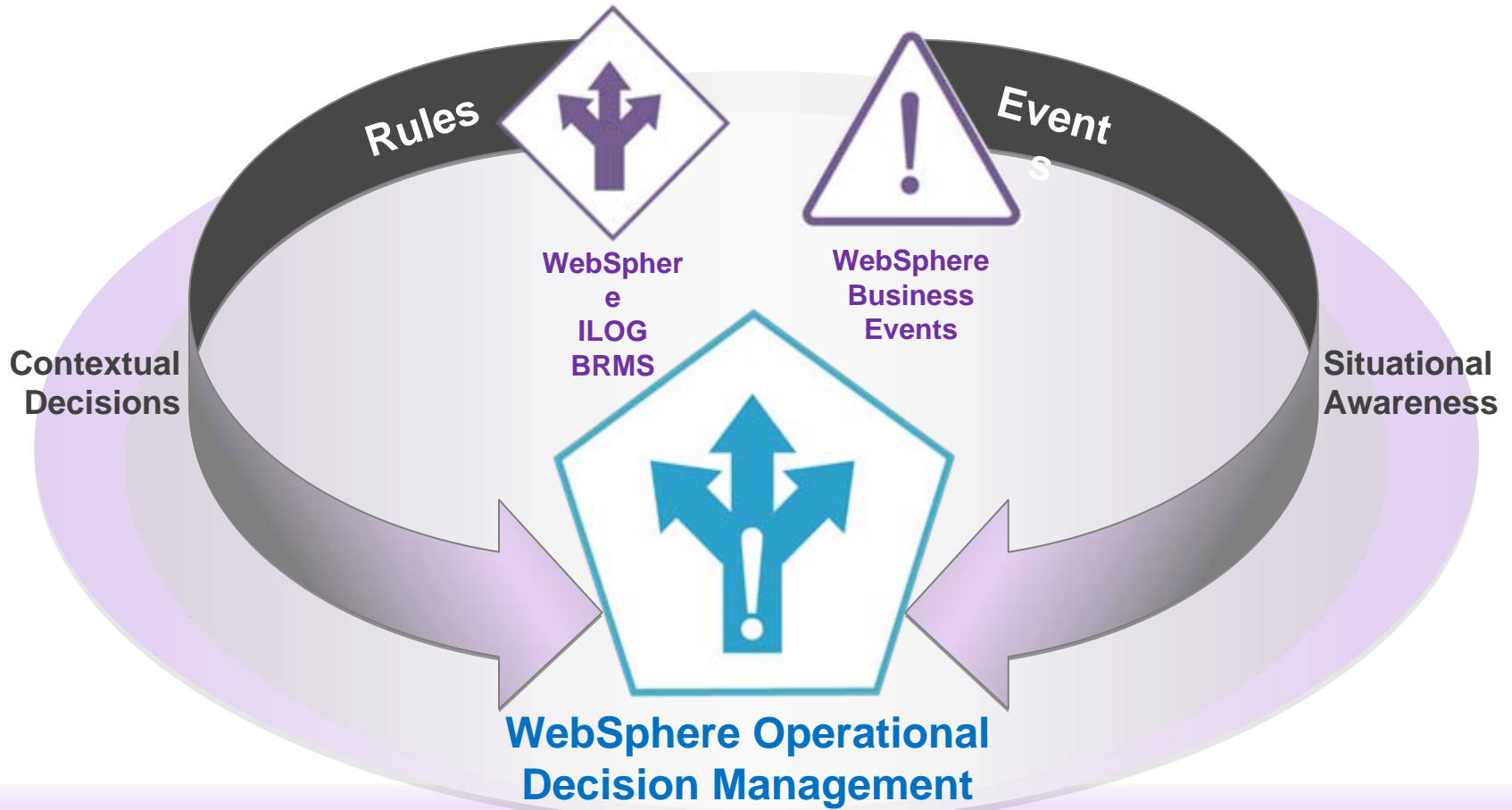

Your business decisions.

Made by your business *experts*.

Delivered in *real-time* by technology.

Putting it Together – Business Events and Business Rules

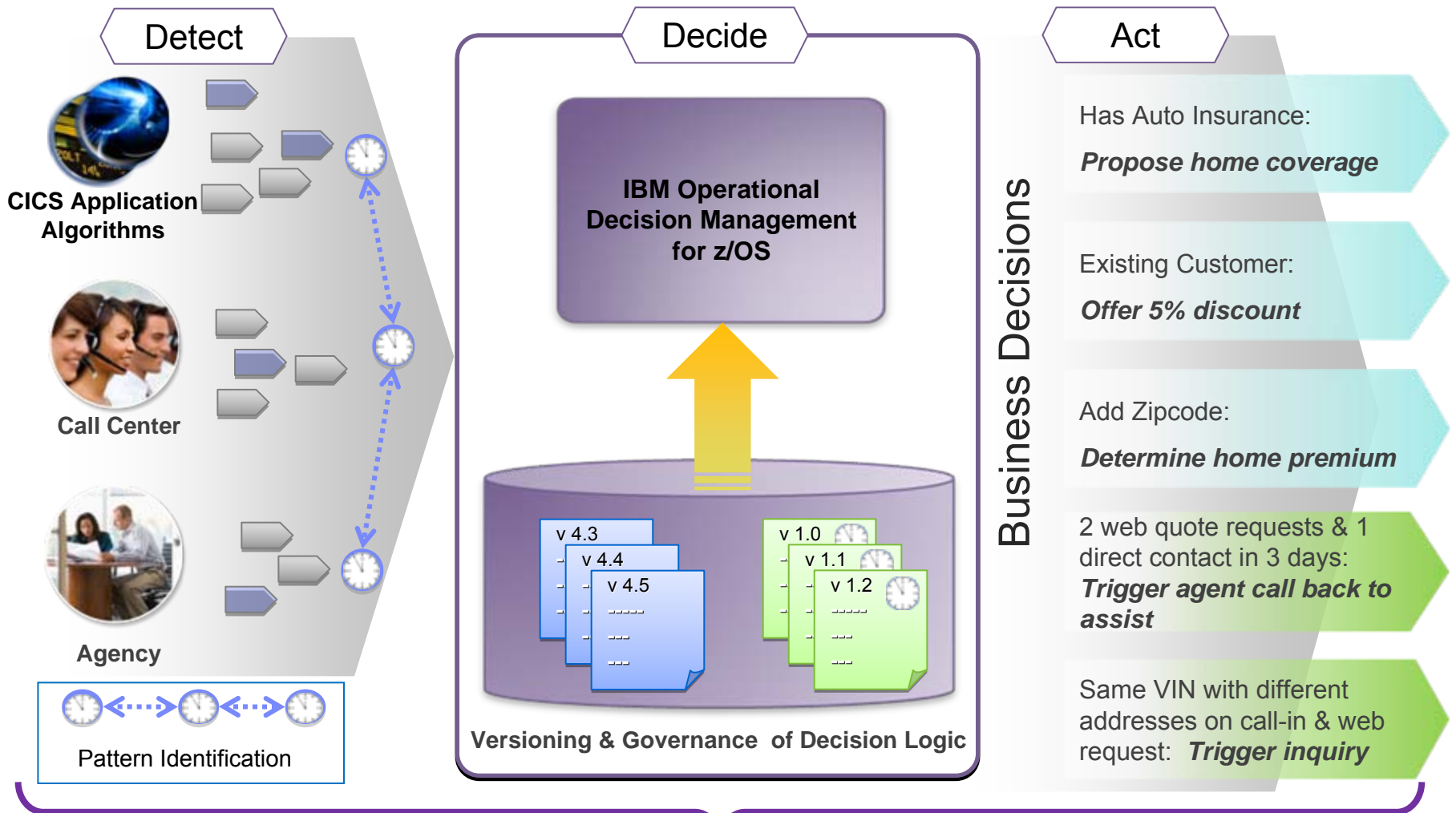

IBM WebSphere Operational Decision Management for z/OS

Insurance use case: Customer acquisition

WebSphere Operational Decision Management Components

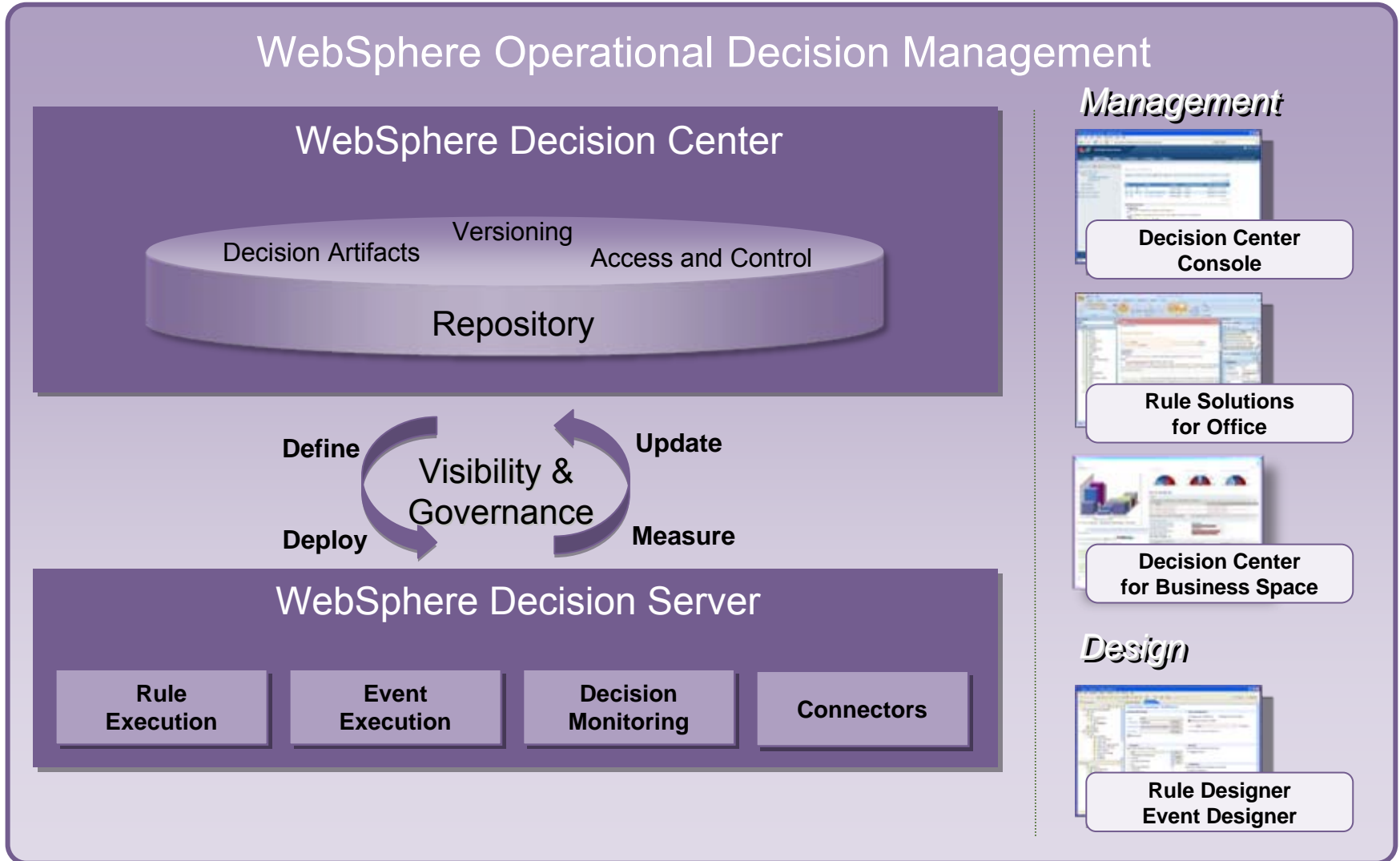

Business Decisions stated in business language

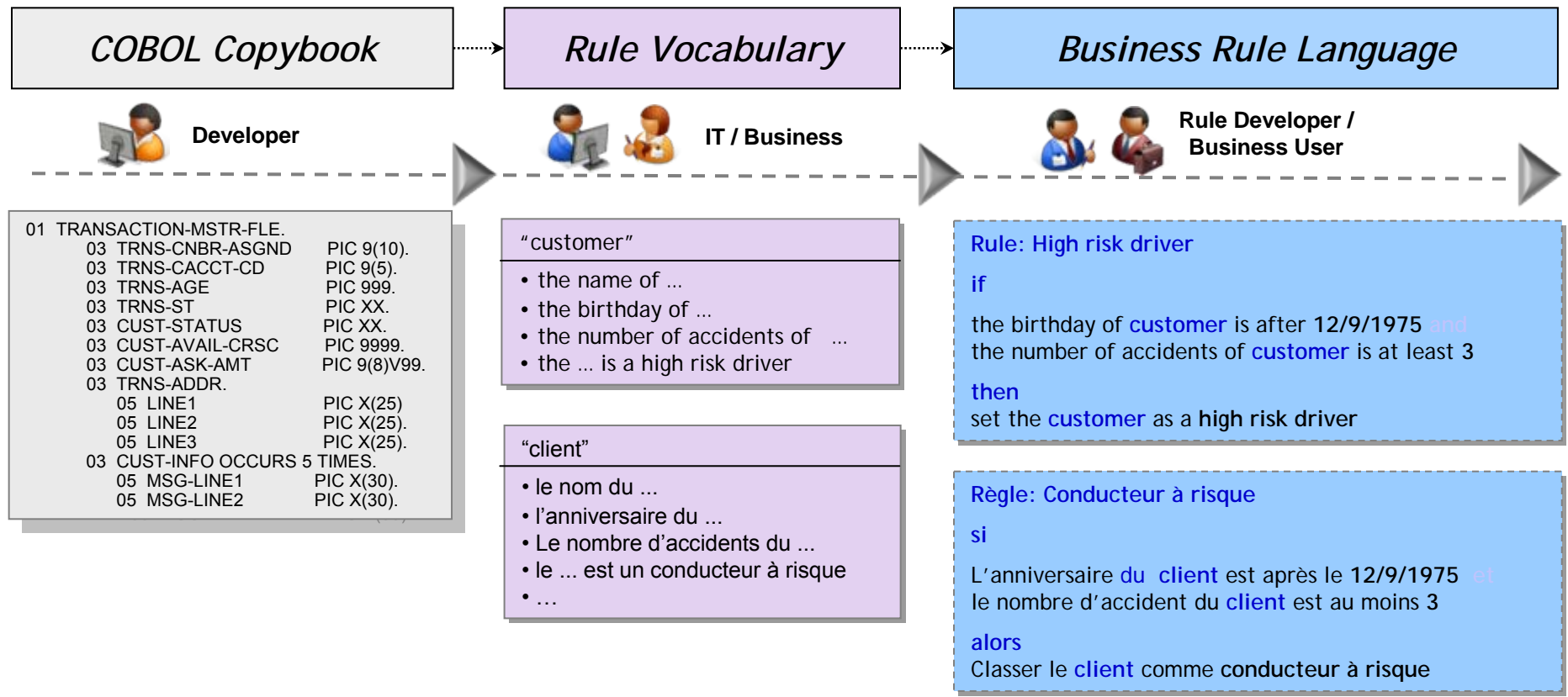

- Customizable vocabulary specific to your organization, industry, application (etc.)
- Supports language localization
- Integrates with external data sources (e.g. list of countries)
- Drop down lists for customized domain data
- Templates facilitate new rule and event creation
- Empower business experts to manage and validate decision logic, eliminating delays in business

Rule Designer

Decision Tables

	Grade	Amount of loan ✖		Insurance required	Insurance rate
		Min	Max		
0	A	< 100,000		false	⊘
1		100,000	300,000	true	0.001
2		300,000	600,000	true	0.003
3		≥ 600,000		true	0.005
4	B	< 100,000		false	⊘
5		100,000	300,001	true	0.0025
6		300,000	600,000	true	0.005
7		≥ 600,000		true	0.0075
8	C	< 100,000		true	0.0035
9		100,000	300,000	true	0.006
10		300,000	600,000	true	0.0085
11		≥ 600,000		true	0.0145
12	Otherwise			true	0.022

Actions

Built-in Gap/Overlap checking

Automatic Rule generation

if
all of the following conditions are true :
 - the loan grade in 'the loan report' is "C"
 - the amount of 'the loan' is at least 600000 ,
then
 set insurance required in 'the loan report' to *true* ;
 set the insurance rate in 'the loan report' to 0.0145 ;

Multiple release management

Greater flexibility for deploying business decisions

- Enable business users to make changes to a deployed rule application without interfering with work they are doing on an upcoming release
- Merge and diff between releases

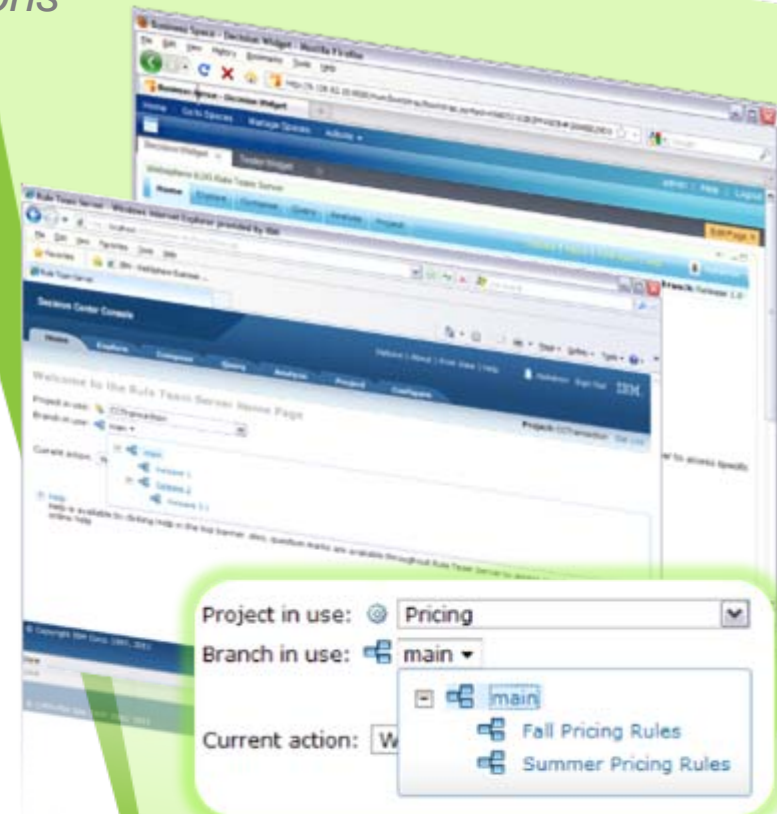
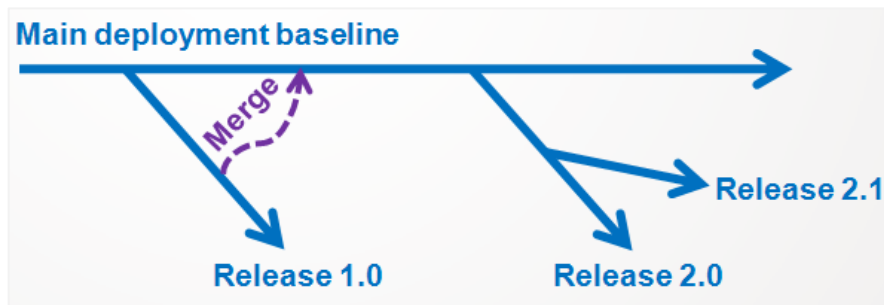

Easily implement changes in distinct versions and better control how to merge them across different releases

Multiple release management visual support

Improving ease and confidence of managing change

- Detailed **side-by-side graphical** difference highlights between releases
- **Multi-directional** merge from one release to another

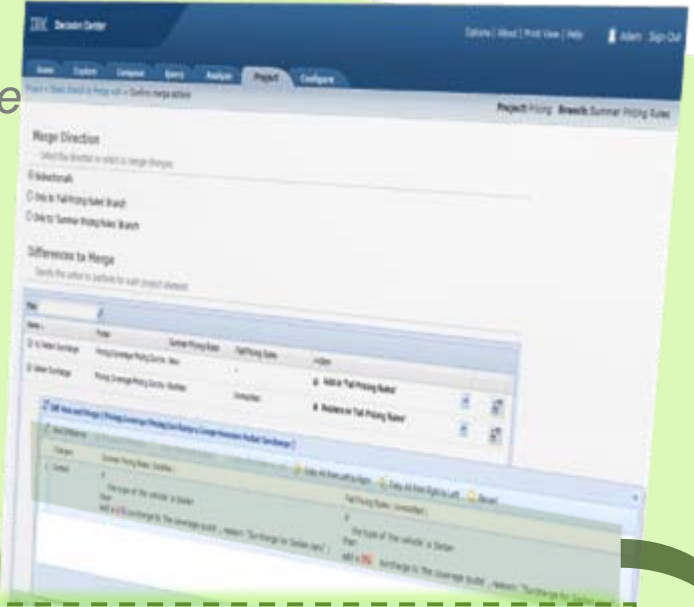

Summer Pricing Rules (Modified)	Fall Pricing Rules (Unmodified)
if the type of the vehicle' is Sedan then add a 4 % surcharge to 'the coverage quote' , reason: "Surcharge for Sedan cars" ;	if the type of 'the vehicle' is Sedan then add a 3% surcharge to 'the coverage

Visually see and understand differences across releases and decide accordingly on how to perform merge between them

IBM WebSphere Operational Decision Management

Leverage a wide range of platforms to meet the varying needs of enterprise architectures

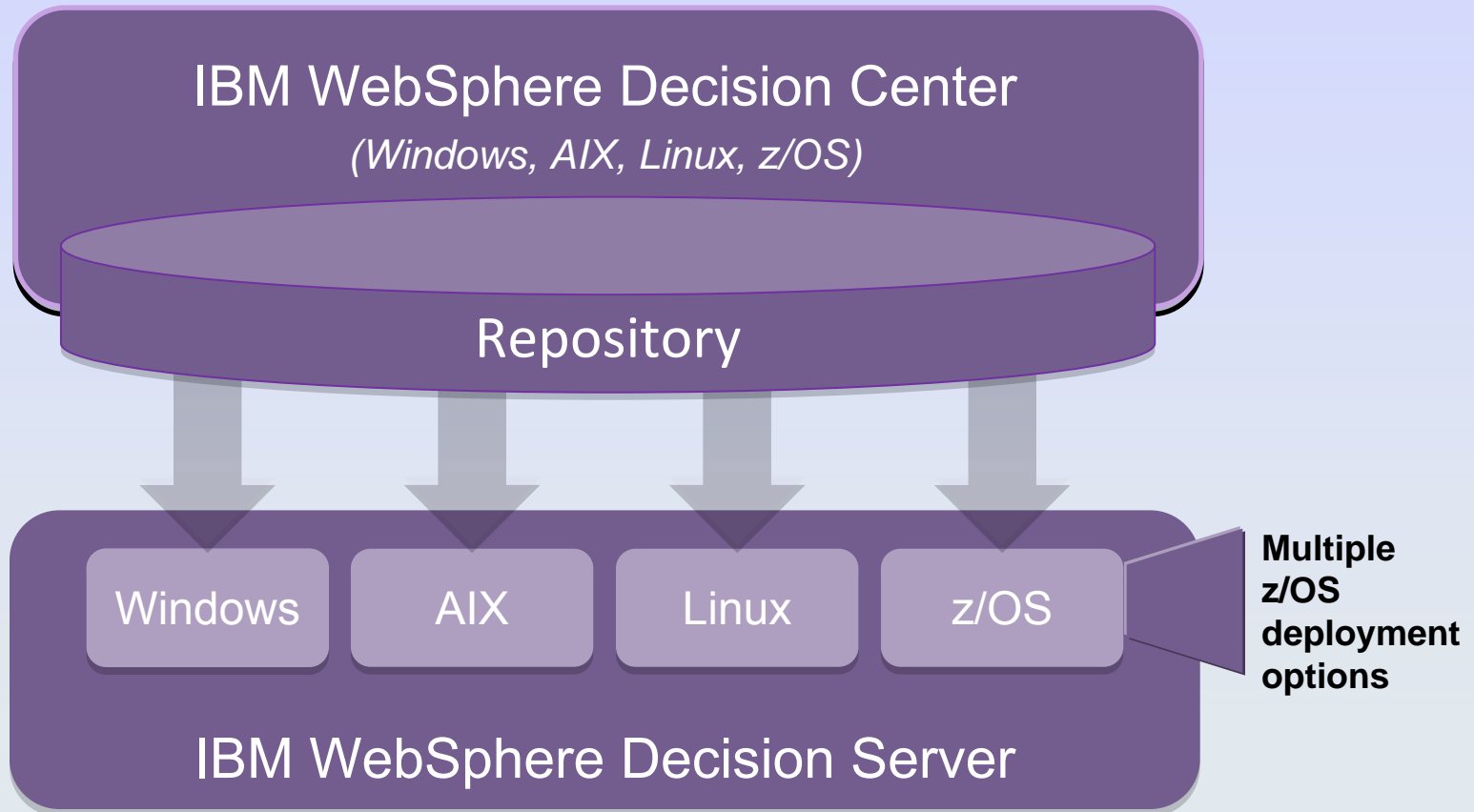

Decision Server for zOS

Business rules execution options

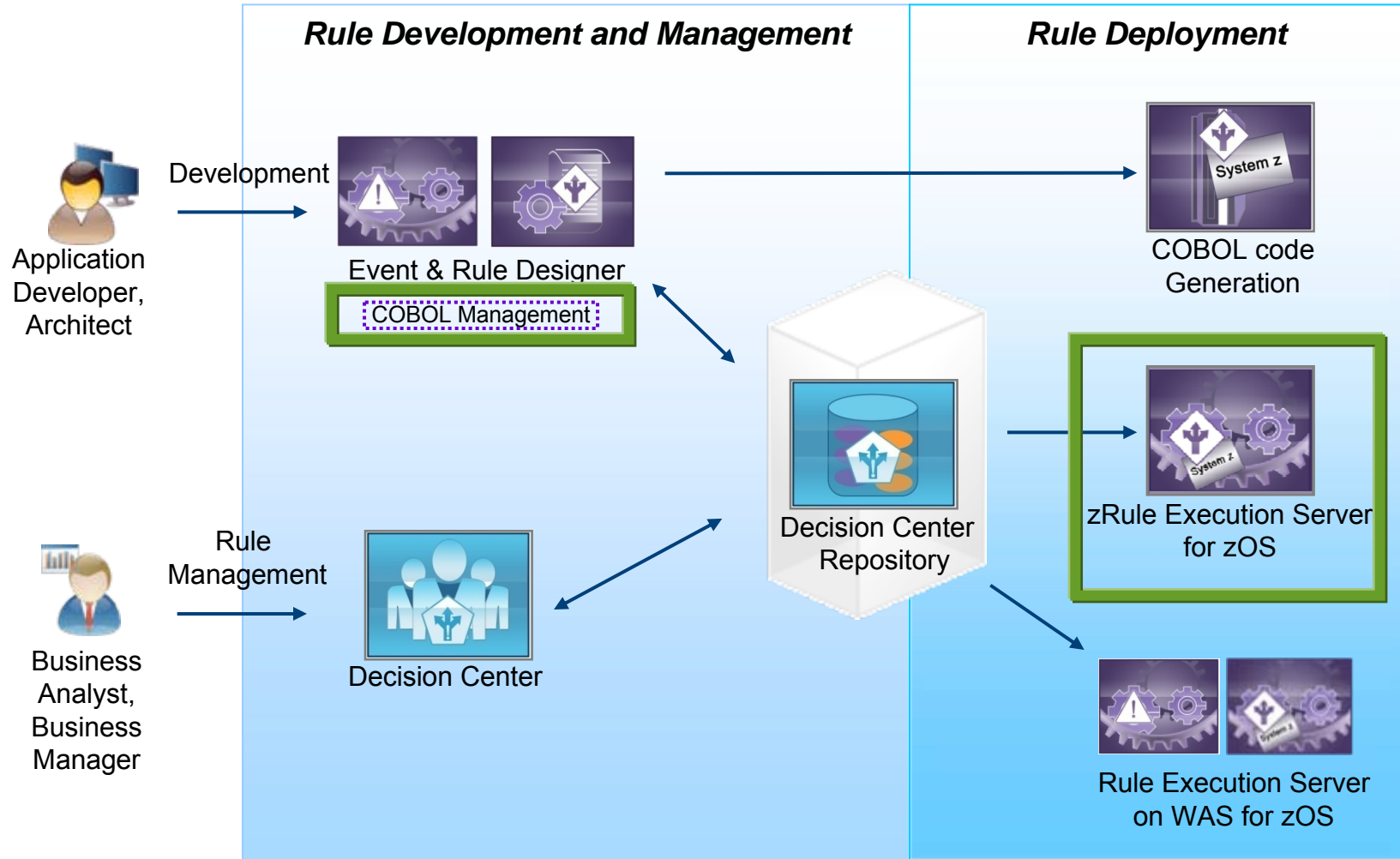

Operational Decision Management on System z

Runtime options

Decisions can be invoked from existing CICS and batch applications

Runtime support for COBOL data types

Flexible runtime deployment to fit any System z environment:

- Deployed on WebSphere Application Server for z/OS
- Deployed on CICS TS 4.x (JVM server environment)
- Deployed standalone to z/OS

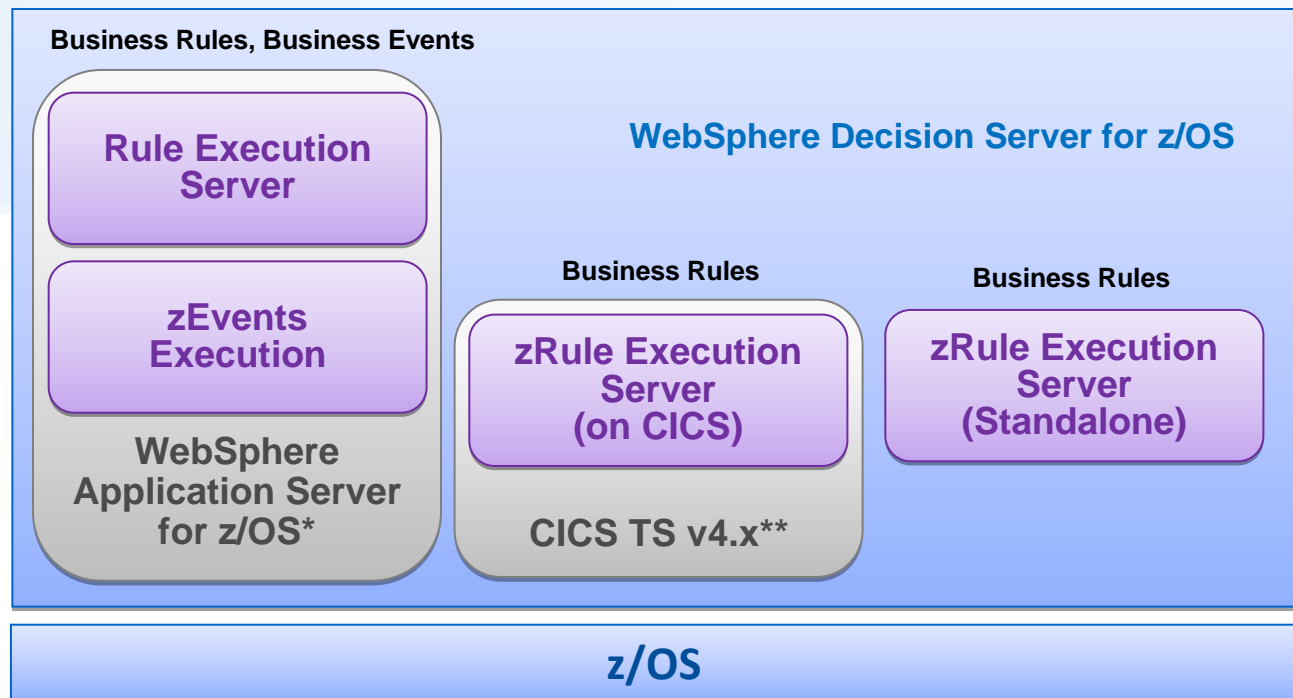

* WAS for z/OS OEM entitlement included with Decision Server

** CICS Transaction Server licenses purchased separately

Deployment options for WODM on System z

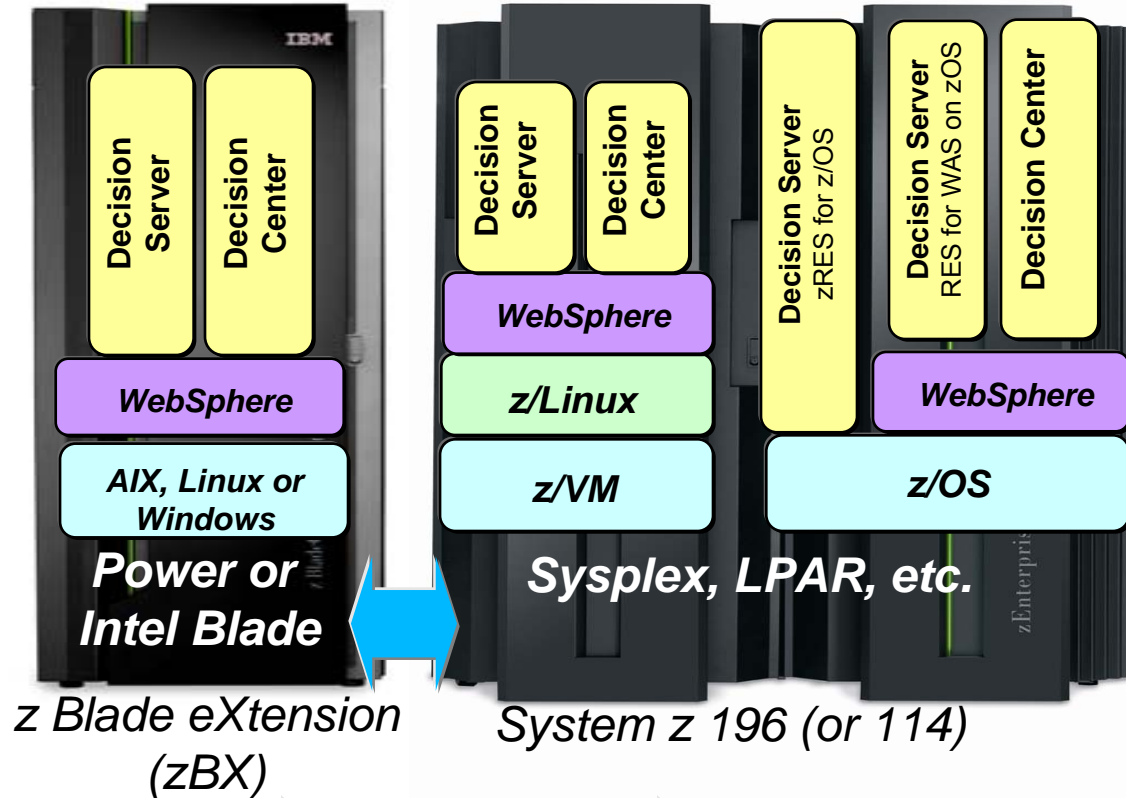

Security

Safe

Safer

Safest

Application/Data Access

Fast

Faster

Fastest

The value of this solution for your z/OS applications

- *WebSphere Operational Decision Management enables organizations in every industry to make their business rules and business decisions clear, consistent and **expressed in business language** to be able to change when the business needs.*
- *Transformation or **modernization** of z/OS applications*
- *Ability to **react to change** (timely reaction to market and competitive changes)*
- *Overcome IT and Business mis-alignment – keep up and service **business requests***
- *Eliminate resource drain on application maintenance – **reuse of business decisions** across applications and platforms*

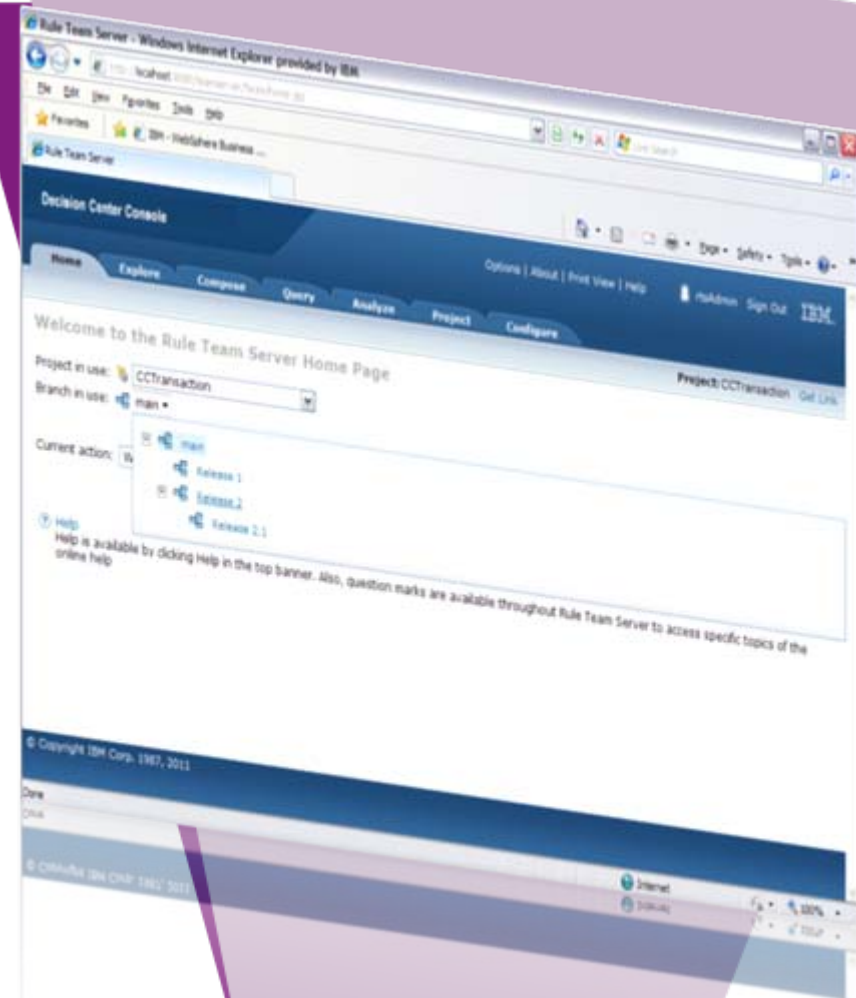

Why modernize with decision man on z and why now?

Modernization issues to resolve

1. **Consolidation of COBOL application portfolio**
2. **Be able to react to changes requested by business in days, not months.**
3. **Sharing rules across platform**
4. **Running parallel**

Benefits of a BRMS

- ✓ **Cost savings**
 - More effective application development & maintenance with less business risk
 - Consolidation/restructure of existing applications, saving hardware & resources
 - Rule testing and simulation to ensure accuracy of changes prior to deployment which will minimize re-work
- ✓ **Changing ratio of source inventory to development skills**
 - Forcing need for formal processes with an on line electronic repository
- ✓ **Improved agility**
 - Decouple development and business rule lifecycles
 - New rules to enforce new business policies to multiple applications
- ✓ **Incremental rule modernization: applying technology and process to gain increased “decision making” agility**
 - Gradually pull out rules from existing applications - does not require a “big bang” change
 - Rewrite business rules in natural language

Rational Asset Analyzer with Rule Mining

Simplify identification of candidate business rules

- For customers who ...
 - Want to be more responsive in supporting an organizations or business units requirements for change
 - Need to get a detailed, complete view of existing business processing and how it fits into today's architectures
- Business Value
 - Improve developer productivity
 - Lower development, training, and mining costs
 - Increase speed and completeness of modernization
- Key RAA Capabilities
 - Visualization of application architectures, programs, data, and their interactions
 - Powerful search and tracing via impact analysis
- Highlights of RAA with rule mining functionality
 - Identification of terms and synonyms
 - Search across portfolios for direct and indirect usage of terms and rules
 - Identify and persist coding constructs that are candidate rules
 - Ability to author structure rules with the WebSphere Operational Decision Management rule editors for import to Websphere Operational Decision Management (WODM)

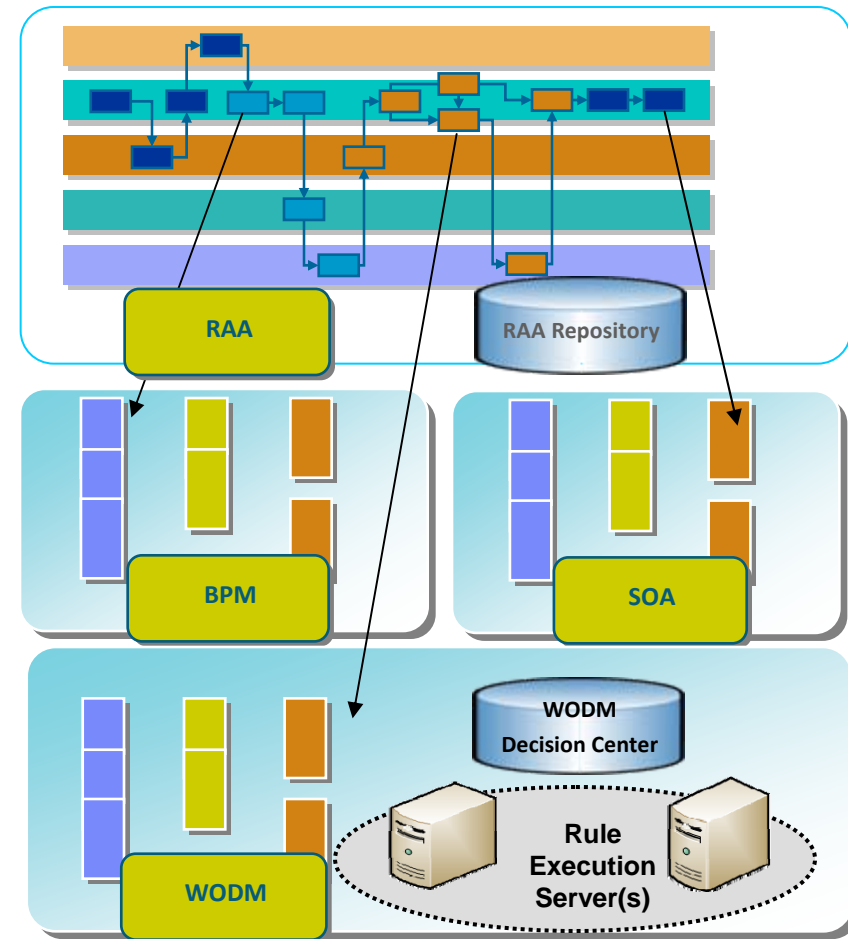

Agenda

- ▶ Operational Decisions: why and what
- ▶ WebSphere Operational Decision Management: how
 - ▶ Synergy with decision management
- ▶ Adoption
- ▶ Operational Decision Management use cases
- ▶ Next steps

Connectivity and integration

- ✓ **CICS**
- ✓ **IMS**
- ✓ **IBM Business Process Manager**
- ✓ **IBM Business Monitor**
- ✓ **Cognos BI**
- ✓ **Smarter Commerce**
- ✓ **Enterprise Service Bus**
- ✓ **Message Broker**
- ✓ **Analytical decision management (SPSS)**
- ✓ **InfoSphere Streams**
- ✓ **Unica**
- ✓ **Tivoli**
- ✓ **Event and Action Connectors**

CICS and IMS

With a minor amount of configuration (not coding), events can be automatically generated to WebSphere Operational Decision Management

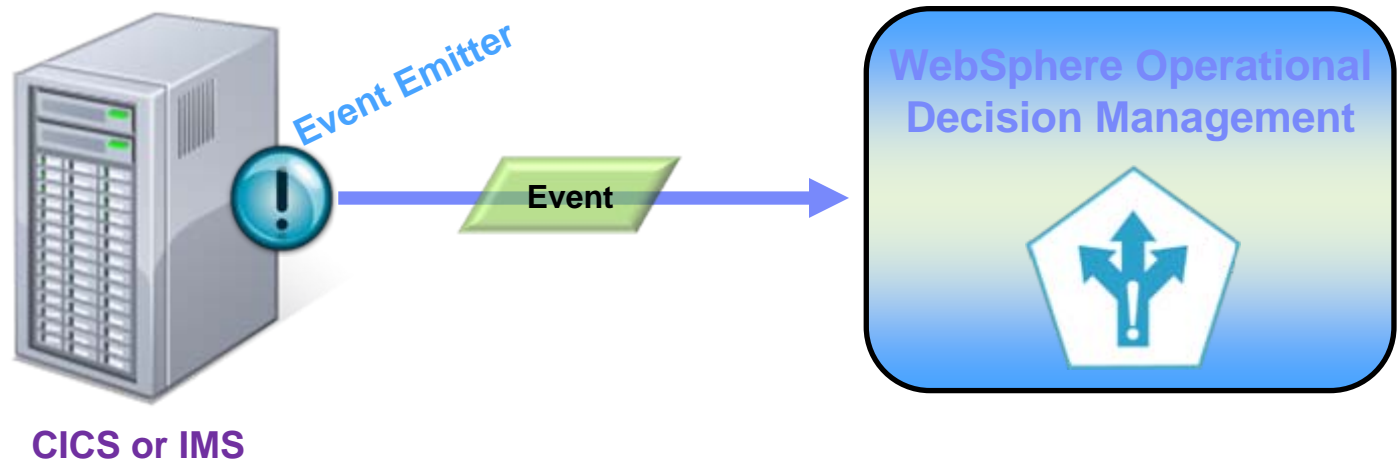

Business event emission from CICS Transaction Server to WODM

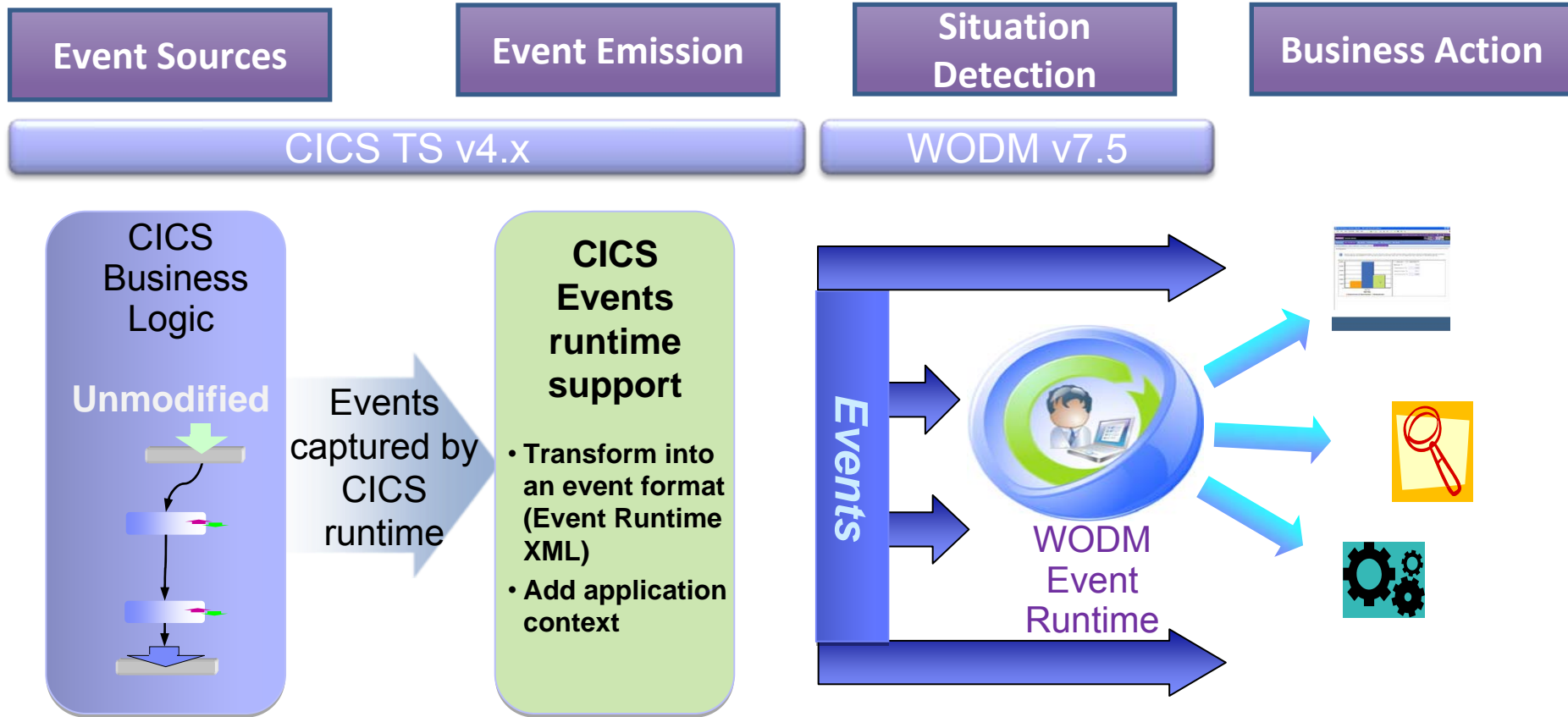

CICS Events with WODM 7.5 help you to

- ***Observe business applications***
- ***Recognize interesting or suspicious situations***
- ***Drive new processing***

Decisions are often locked within processes

Without Decision Management

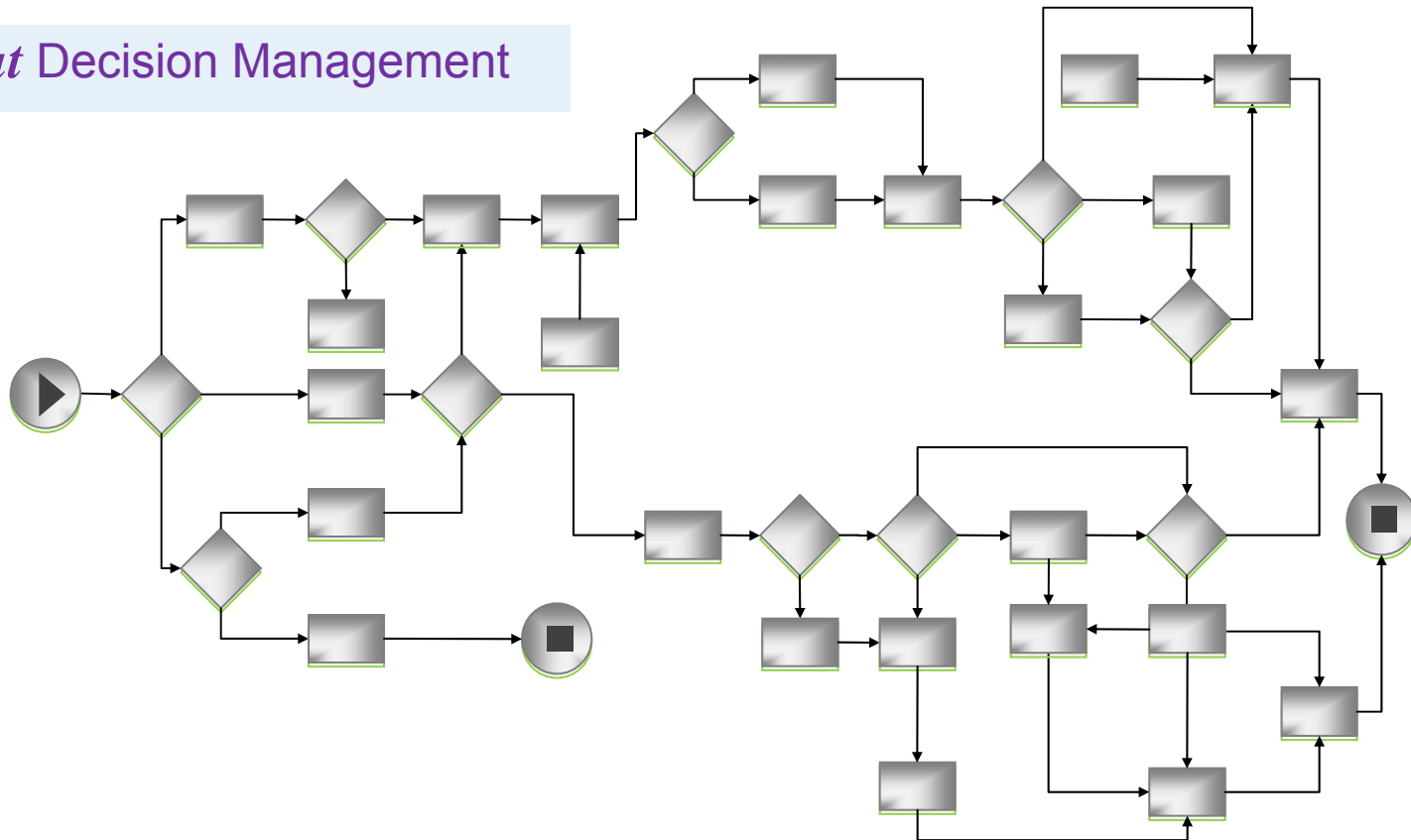

- Decisions are locked in processes and applications
- Programming skills are needed to create & modify decision logic
- Speed of business change is limited by IT bandwidth
- Manual intervention increases costs & reduces customer satisfaction

Decision Management enables reuse across processes

With Decision Management

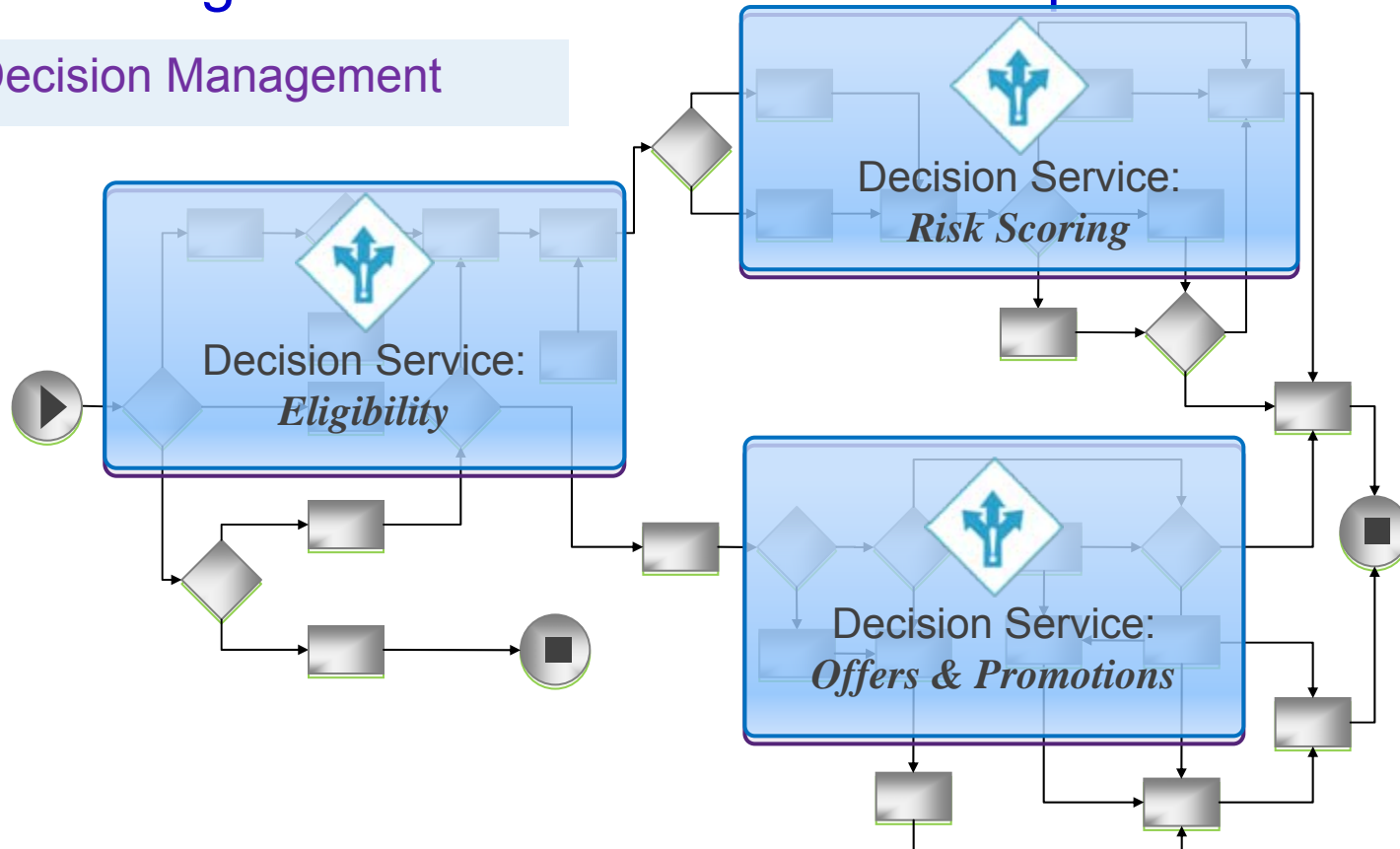

- **Reuse decision assets** across processes
- **Empower business people** to own, author and update decision services
- **Respond quickly** to changing market conditions
- **Maximize automation** and straight-through processing

IBM Business Monitor provides additional visibility and insight

- Provides richer, more graphical reporting capabilities than what is available in WODM
 - Rule execution data can be used to provide *business-level context*
- Native integration for sending and receiving of events and messages
- Execution data can be analyzed for trends – is following up with a customer producing real revenue or is it a waste of time?
- Allows rule execution data to be combined with other business system data for a consolidated view of metrics
- Additional capabilities for alerts or actions when a business situation occurs or is about to occur

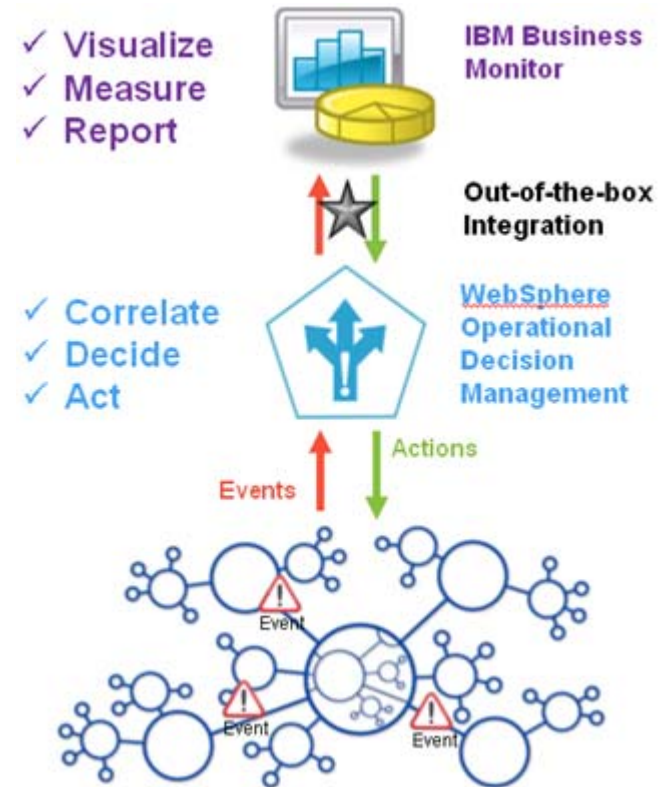

Alert Manager							
Alert Name	Description	Owner	Dashboard Alert	Cell Phone	E-mail	Pager	Actions
Total loan amount too high	Total loan amount more than 5 million	admin	<input checked="" type="checkbox"/>	<input type="checkbox"/>	<input type="checkbox"/>	<input type="checkbox"/>	

Agenda

- ▶ Operational Decisions: why and what
- ▶ WebSphere Operational Decision Management: how
 - ▶ Synergy with decision management
- ▶ Adoption
 - ▶ Operational Decision Management use cases
 - ▶ Next steps

How can WODM add value to your solution?

■ Are you a good candidate?

- Existing CICS, IMS, Batch and WAS z/OS Customers as well as existing JRules Distributed Customers

■ Questions to ask yourself...

- Are you able to quickly make the changes, that are required by the market, competition, and regulatory conditions, to your z/OS applications?
- Could your company benefit from having a central place to manage the decision logic (rules) for both business analysts and IT developers to facilitate rapid change and adaptation?
- How confident are you that the business policies you have in your system actually reflect your business needs? And that you are compliant with current regulations?
- Do you have the ability to reuse your existing rules assets to assemble and reconfigure applications rapidly so you can meet current and future requirements?



Review of a business rule maturity model

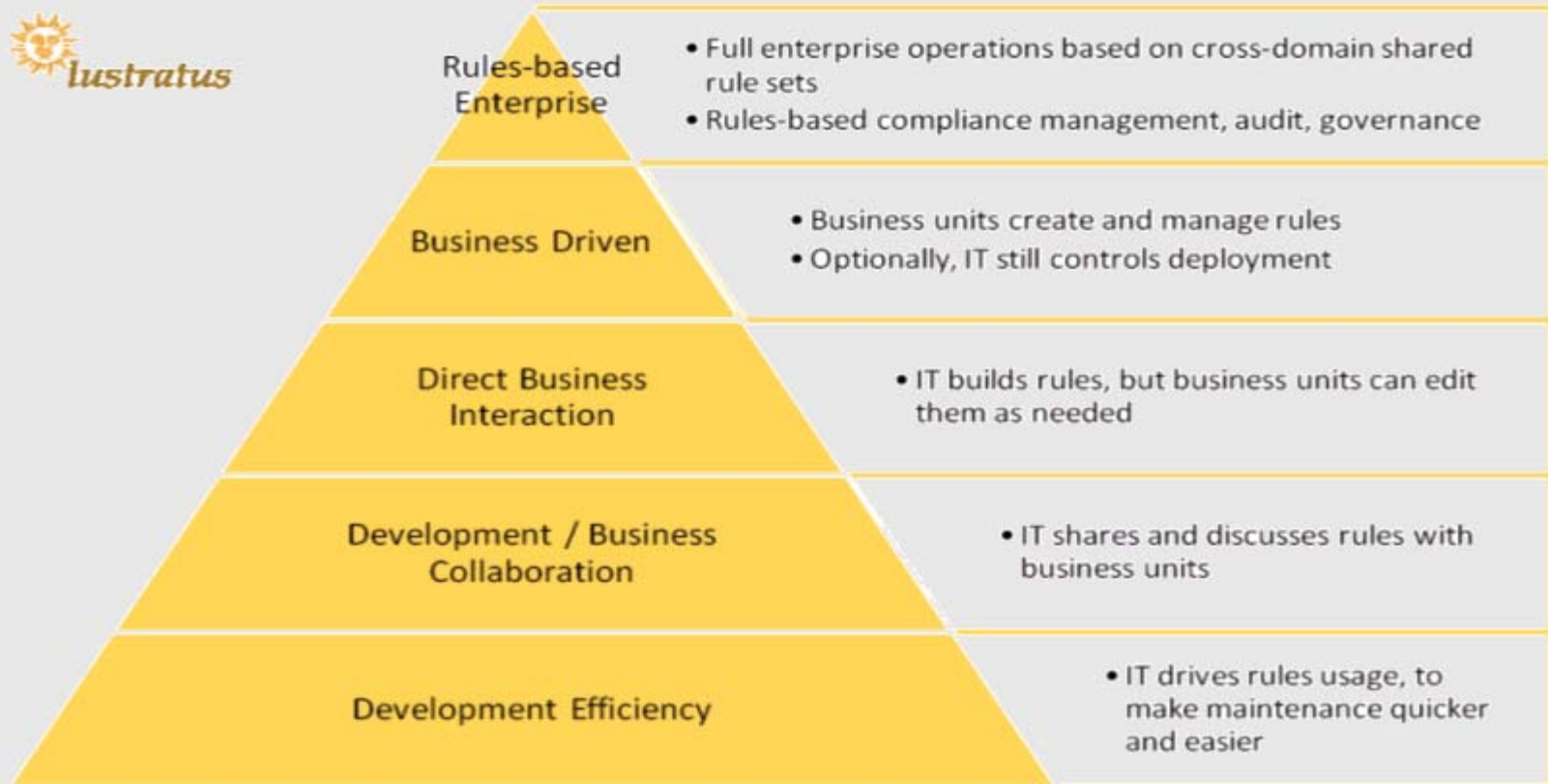

Source: The Lustratus BRMS Maturity Model

Agenda

- ▶ Operational Decisions: why and what
- ▶ WebSphere Operational Decisions Management: how
- ▶ Synergy with decision management
- ▶ Adoption
- ▶ Operational Decision Management use cases
- ▶ Next steps

Operational Decision Management Helps Solve Many Common Business Problems

Identify opportunities to increase profitability



Personalized Product Recommendations
Promotions & Loyalty Programs
Automated Sales Commissioning

Enforce consistency to ensure compliance



Claims Validation
Payment Authorization
Eligibility Determination

Leverage information to manage risk



Underwriting and Credit
Border Control
Physical Infrastructure Monitoring

Visa Europe Unifies Payments Across 36 Countries

Scalable, automated payment authorization and settlement system

Challenge:

- Complex European market with multiple currencies
- Payment authorization & settlement across 36 countries
- Regulatory requirement to unify payments across countries

Benefits:

- 3x faster time-to-market
- 25% cost reduction to maintain business logic
- Increased flexibility and responsiveness with business users managing the rules

Decision Management Solution

- *Financial payments authorization & settlement system*
- *System handles 30,000 rules and 500 transaction types for 4,000 institutions*

“Within 13 months we’ve made 60 rule changes... What [the system] gives us is tools that can put key capabilities into the hands of users. They become an integral part of the process, rather than mere consumers of it. That’s a tremendously powerful concept...”

~ Justin Snoxall, VP, Head of Development Services, Visa Europe

HealthNow Speeds Up Member Enrollment

Speed to market gains of over 50% to roll out new programs

Challenge:

- Respond quickly to regulatory mandates
- Increase efficiency by streamlining internal processes
- Address growing complexity in healthcare

Benefits:

- Reduce enrollment time and administrative costs
- Increased speed to market by 50%
- Greater consistency from externalized decision logic and process visibility

BPM and Decision Management Solution

- *Member enrollment process to automate eligibility and coverage for new member applications*
- *Comprehensive audit trail of rules and decisions*

“Providing innovative products and services while improving the availability, quality, and cost of healthcare is central to our corporate vision. WebSphere Process Server and ILOG JRules have enabled us to automate, optimize and monitor critical business decisions within our core processes.”

~ John Walsh, Chief Enterprise Architect, HealthNow New York Inc.

Business Events and Tivoli Success Story: Large U.S. Utility

Streamlining operations and improving service



Challenge: Maximizing investment in infrastructure modernization to connect silo operations and improve customer service

What's smart?

- Intelligent Utility Network from IBM
- Phased implementation of advanced meter management
- Integrated network management using event correlation across grid and IT
- Coordinated real-time information flows for timely cross-organizational response

Smarter Business Outcomes

- Streamlined operations
- Enabled new products and services to retail electric providers
- Improved transparency for effective communication and service to customers

Agenda

- ▶ Operational Decisions: why and what
- ▶ WebSphere Operational Decision Management: how
- ▶ Synergy with decision management
- ▶ Adoption
- ▶ Operational Decision Management use cases
- ▶ **Next steps**

Key takeaways

Adapt to change with increased speed & agility

Intuitive natural language for specifying rules and events

Align business units and IT with enhanced visibility & governance

Integrated repository for reliable versioning and change control

Act in real-time with high performance & reliability

Robust runtime for mission-critical deployment

WebSphere Operational Decision Management

Your business decisions.

Made by your business experts.

Delivered in real-time by technology.

Join us at SHARE in Atlanta, March 11-16, 2012



CICS and Decision Management: Perfect Together

Tuesday, March 13, 2012: 3:00 PM-4:00 PM

Using Business Rules to Achieve Affordable Agility in System z Applications

Thursday, March 15, 2012: 8:00 AM-9:00 AM

Modernization of Mainframe Applications with WebSphere Operational Decision Manager for z/OS

Thursday, March 15, 2012: 9:30 AM-10:30 AM

Why Business Rules and Business Process Management are Important to System z Apps (and to you)

Thursday, March 15, 2012: 4:30 PM-5:30 PM

IBM Software

Impact2012

The Premier Conference for Business & IT Leadership

Innovate. Transform. Grow.

April 29-May 4 Las Vegas, NV



Early registration discounts available!

<http://www-01.ibm.com/software/websphere/events/impact/registration.html>

Next steps



See Operational Decision Management - *In Action*

- Go to ibm.com/operational-decision-management/scenarios to see and hear customer videos and podcasts
- Schedule an online custom demo

Learn what's possible - *Discovery Workshop*

On-site [workshop](#) with business and IT stakeholders to evaluate the applicability of decision management for your project



Implement a real project in 10 weeks - *Quick Win Pilot*

- Demonstrate immediate value to your LOB end-users with your first 'Quick Win' in 10 weeks
- Accelerate the deployment of decision management using a proven, incremental approach and a [production-ready pilot](#)
- Collaborate with IBM experts on your first win

Where can I find out more?

- [WebSphere Operational Decision Management for z/OS](#)
- White papers & tech docs
 - [WebSphere z/OS – The Value of Co-Location](#)
 - [Brief introduction to WebSphere Optimized Local Adapters](#)
 - [WebSphere for System z Prescriptive Use Cases \(Oct. 28, 2011 Addendum\)](#)
- Redbooks
 - [Batch Modernization on z/OS](#)
 - [Patterns: Integrating WebSphere ILOG JRules with IBM Software](#)
- [WebSphere Operational Decision Management YouTube demo](#)
- [9 day-to-day decisions you can make better with Operational Decision Management](#)
- [Good Decision! Decision Management blog](#)
- [System z pricing](#)

Thank You



Why IBM for Operational Decision Management?



Unparalleled Expertise and Investment

- Expert consulting and implementation services for **fast realization** of business value
- Industry expertise to **customize solutions** for your specific industry

Largest Customer Base

- **#1** in Business Rule Management Systems (BRMS) market share according to all leading analysts
- **#1** in Business Process Management (BPM) market share according to all leading analysts



Strongest Ecosystem and Partner Network

- **800+** Business Partners authorized and certified to support customers
- Strongest global ecosystem including major global and regional system integrators skilled to provide **comprehensive solutions**