

Model-Driven Systems Engineering (MDSE)

How?

2010/11/30

LGE Business Solutions Company



Why MDSE?

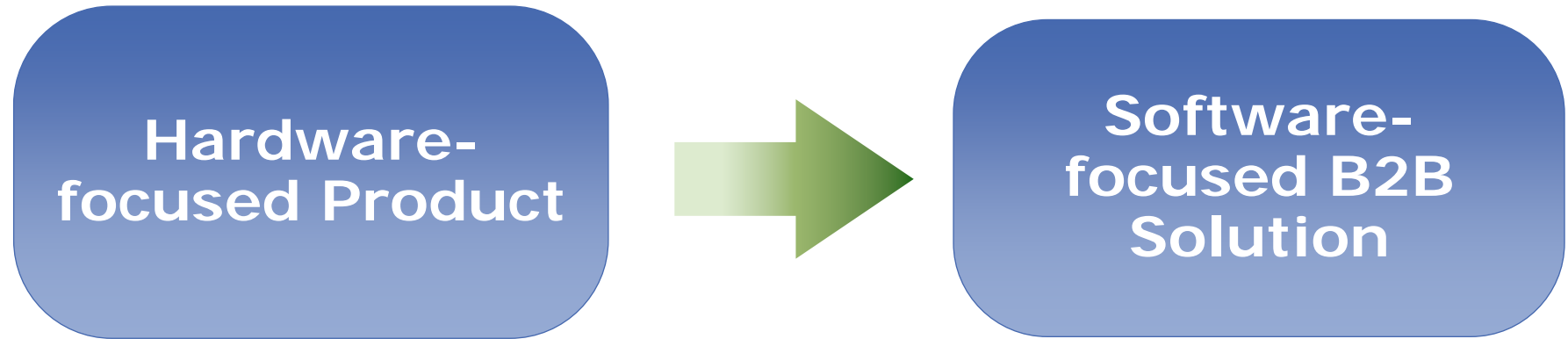

What were missing?

1. Requirement management
2. Development to meet or exceed requirements
3. Change management
4. Test based on requirements

“The SE is an interdisciplinary approach to enable the realization of successful systems. It focuses on defining customer needs and required functionality **early in the development cycle**, documenting requirements, then proceeding with design synthesis and **system validation** while considering the complete problem.”

<http://www.incose.org/practice/whatissystemseng.aspx>

Overview of Traceability

MRD (Marketing Requirement Doc.)
SRD (Solution Requirement Doc.)
SRS (System Requirement Spec.)
HLD (High-Level Design)
LLD (Low-Level Design)

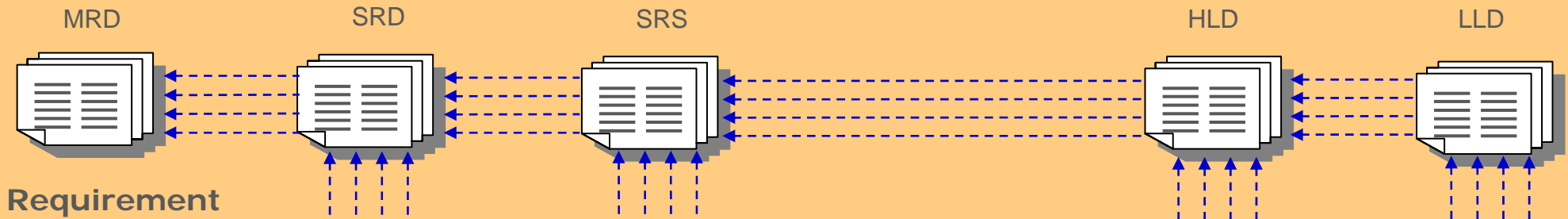

Requirement

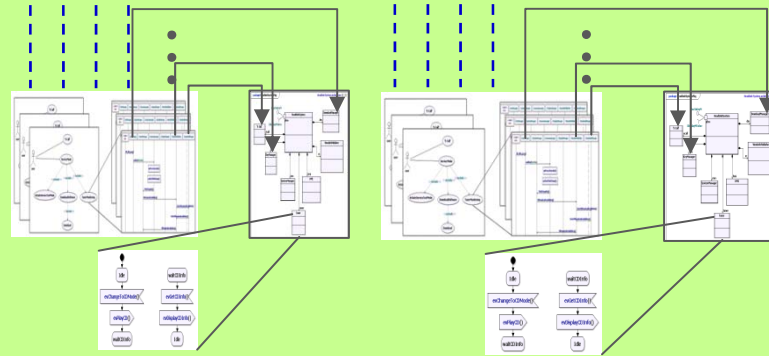

Model

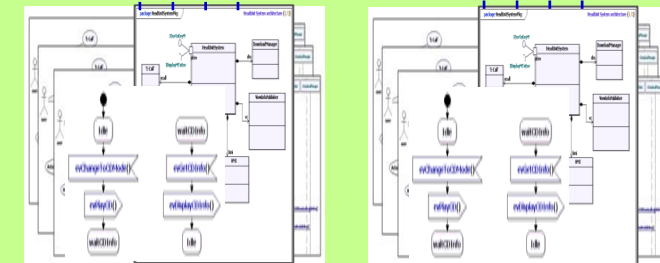

Design

1. Requirement Management (RM)

1. Requirement management
2. Development to meet or exceed requirements
3. Change management
4. Test

1.1 RM: Stakeholder Requirement

- Stakeholders are individuals and organizations that are actively involved in the project.
 - Have an interest
 - because affected by a result of project execution/completion
 - May have a positive/negative influence in the project
 - Gain upon a successful completion of the project

1.2 RM: Use Case

Use case expresses what user would do with the system to accomplish user goals.

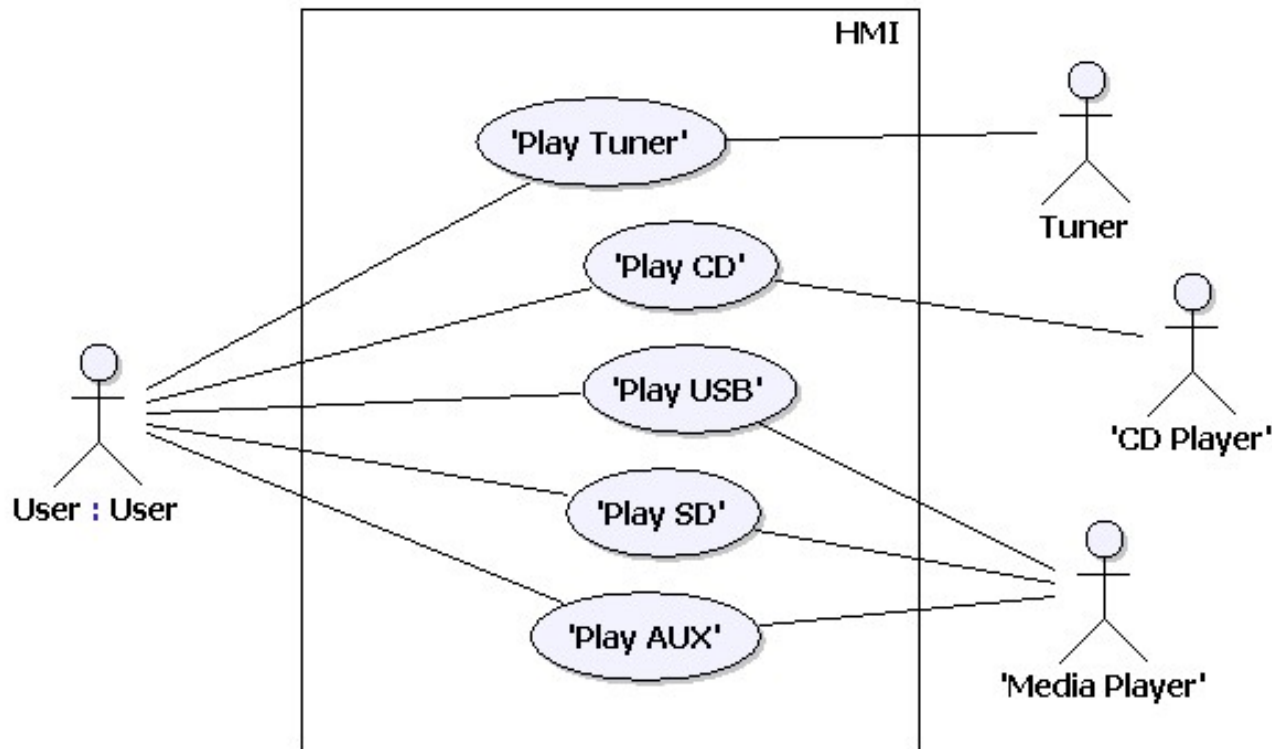

1.3 RM: Baseline

Generally, a baseline may be a single work product, or set of work products that can be used as a **logical basis for comparison**. A baseline may also be established (whose work products meet certain criteria) as the **basis for subsequent select activities**. Such activities may be attributed with **formal approval**.

- Capability Maturity Model for Integrations (CMMI)

1.4 RM: Good Requirements

- Verifiable
- Atomic
- Clear
- Consistent

Example A) 시스템은 뛰어난 성능을 가져야 한다.

→ 시스템은 1초에 2500개 이상의 transaction을 처리할 수 있어야 한다.

Example B) 시스템은 다양한 OS에서 동작할 수 있어야 한다.

→ 시스템은 Red Hat Enterprise Linux 6/5/4에서 동작할 수 있어야 한다.

2. Development

1. Requirement management
2. Development to meet or exceed requirements
3. Change management
4. Test

Overview of Traceability: Requirement and Model

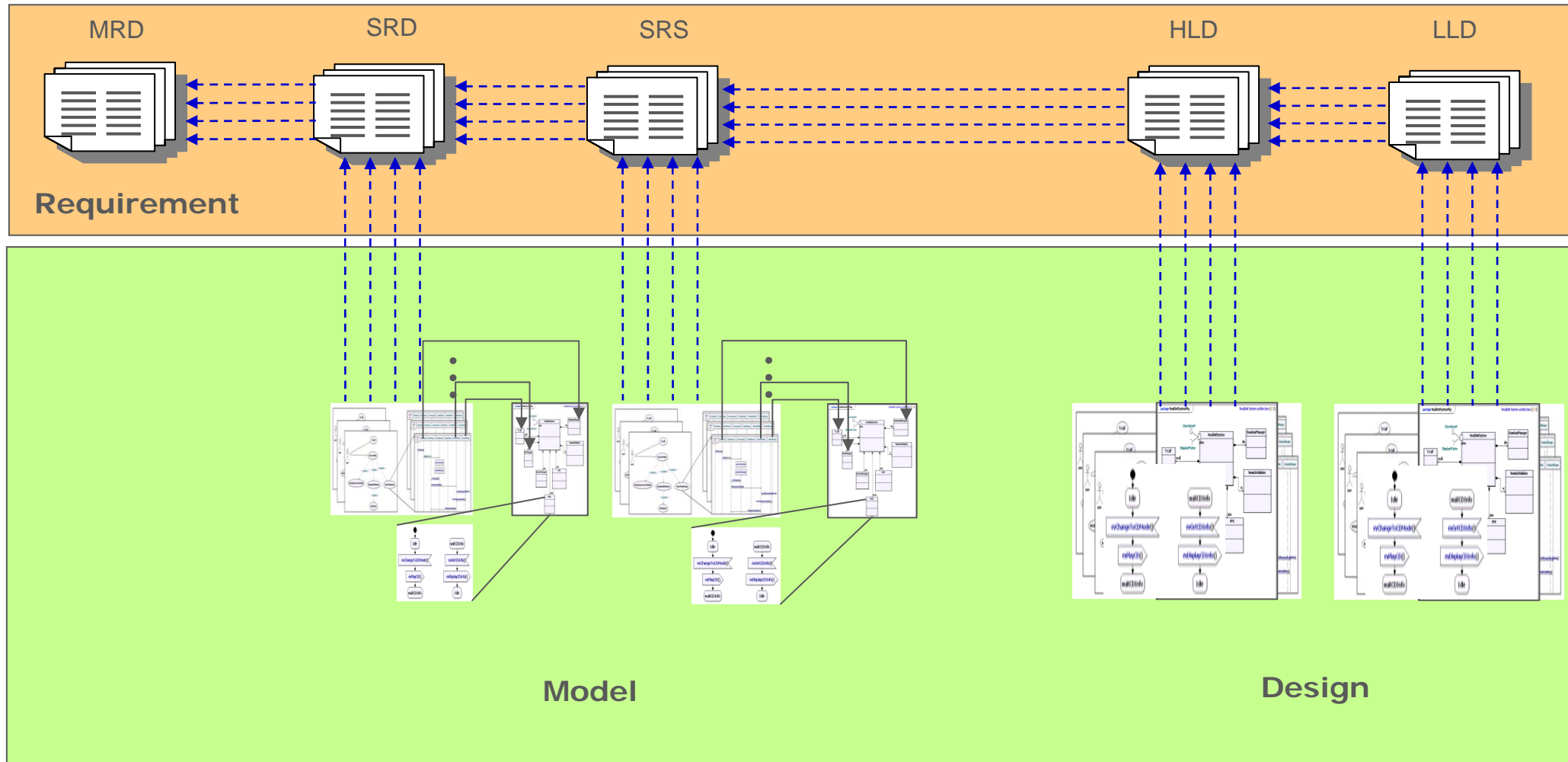

2.1 Development: Example of Req. Traceability

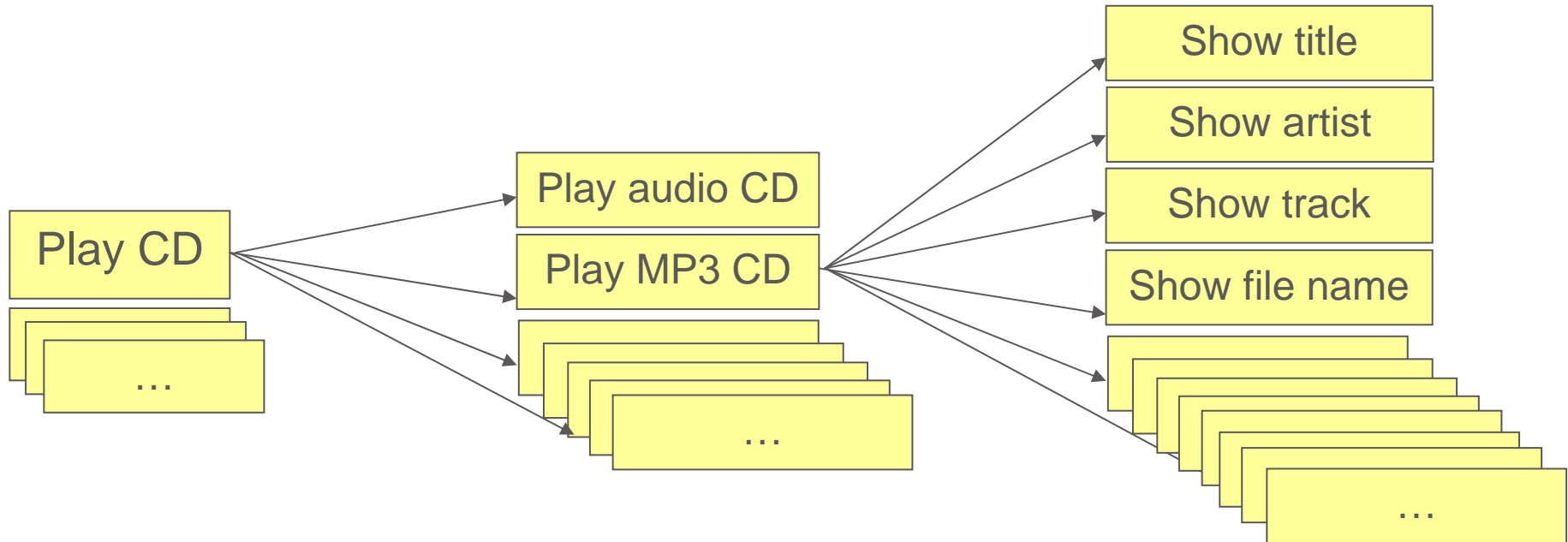
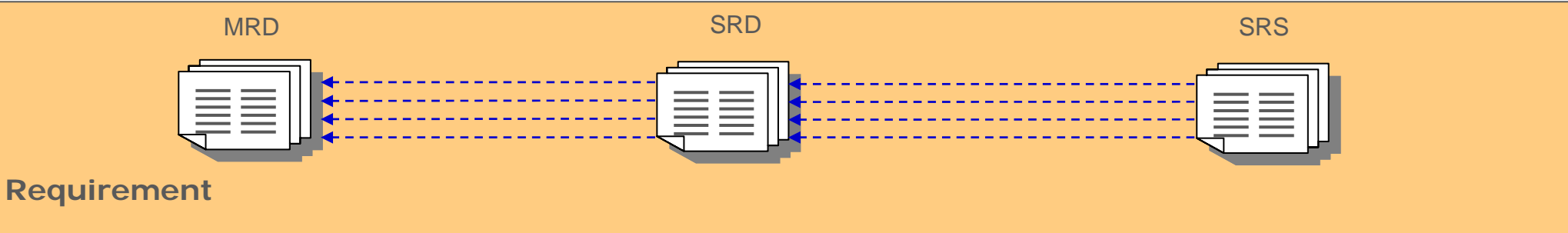

2.2 Development: Model-Driven Development I

Requirements

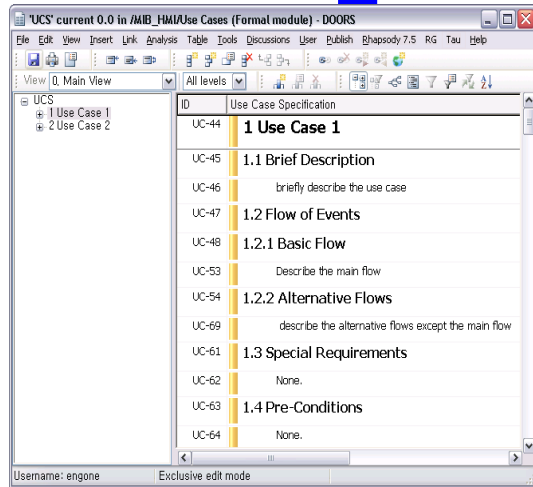

Requirements

Architecture

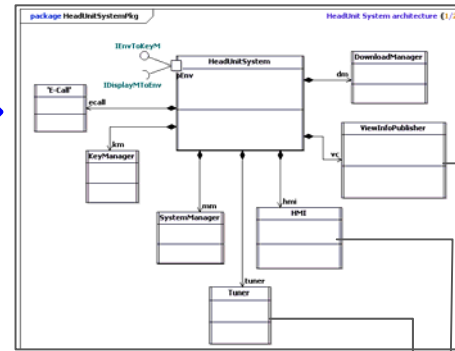

Static Structure

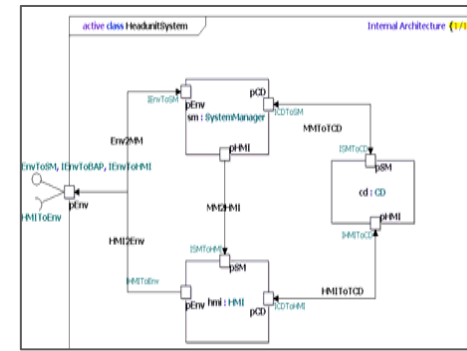

Internal Structure

Behavior

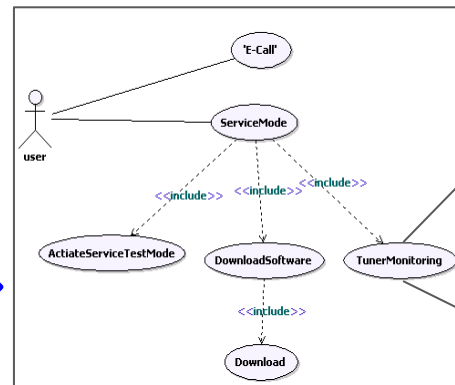

Functions of System

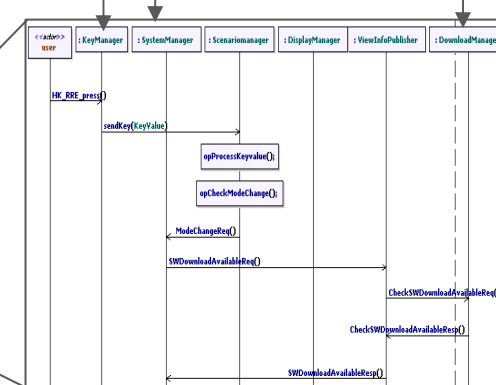

Behavior of Function

2.3 Development: Model-Driven Development II

Architecture

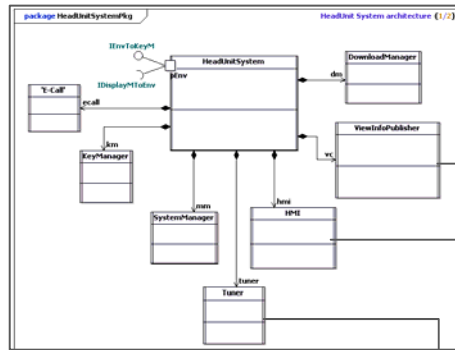

Static Structure

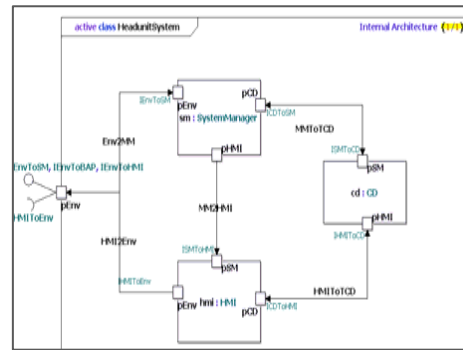

Internal Structure

Model Verification

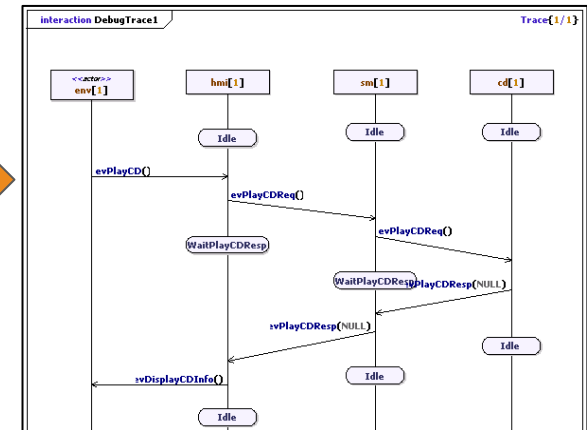

Behavior

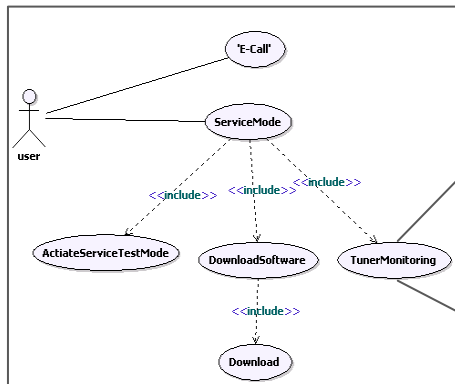

Functions of System

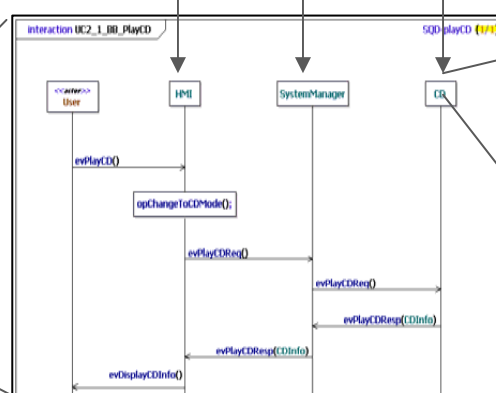

Behavior of Function

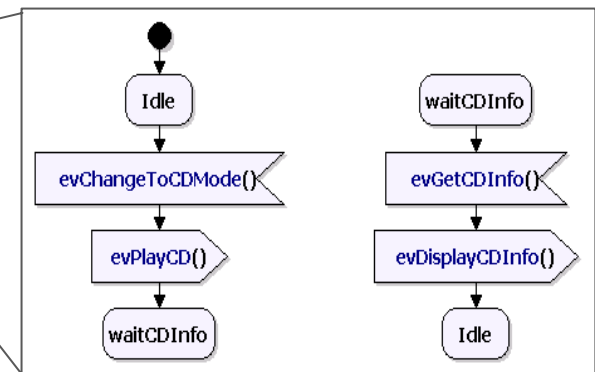

Behavior of Class

3. Change Management

1. Requirement management
2. Development to meet or exceed requirements
3. Change management
4. Test

3.1 Change Management: Baseline

Baseline must be established first!

- Once the project requirements have been accepted and the client has **signed them off**, they are considered baselined. They should then be placed under change control as part of the project's change management process.

- Successful project change management relies on the project having a clear set of baselined project plans and requirements in place.

The implication is that from this point on, any changes to the requirements must then be handled through the **agreed and formalized** change management process.

4. Test

1. Requirement management
2. Development to meet or exceed requirements
3. Change management
4. Test

4.1 Test Overview

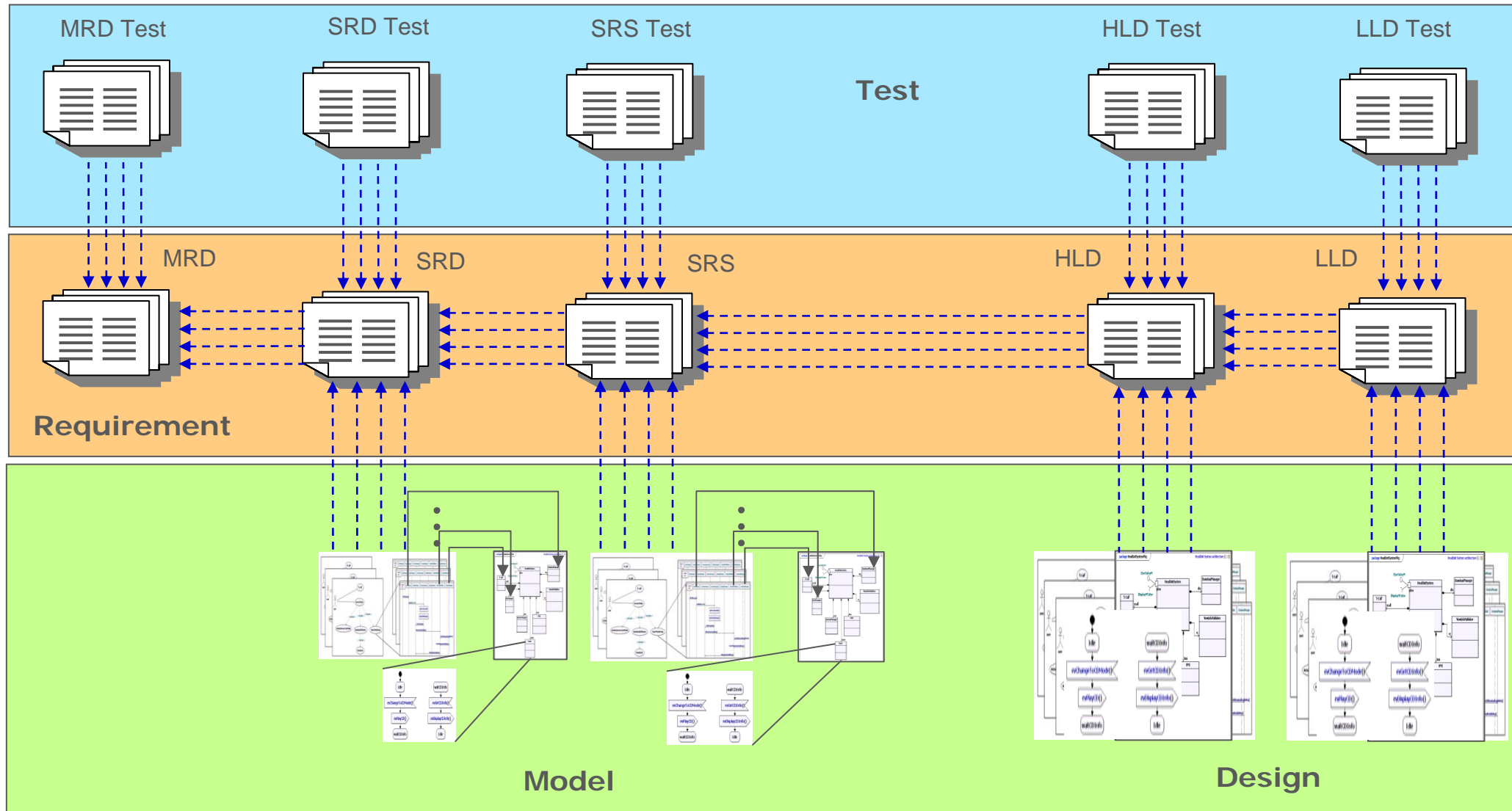

Summary

To successfully apply MDSE, the followings are essential.

- 1. Requirement management**
- 2. Development to meet or exceed requirements**
- 3. Change management**
- 4. Test based on requirements**