

DI - A Look Ahead

Anthony Lewitt
DataInterchange Development
Manager
IBM Global Services

DI: A Look Ahead

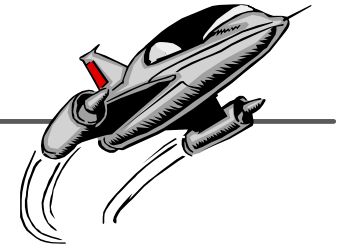

Abstract:

- ★ "Everyone wants to know what the new millennium will bring. One thing is certain: change; and here's your chance to get a handle on it. This session provides a quick look at the technical trends and directions for the DataInterchange product."

DataInterchange Directions

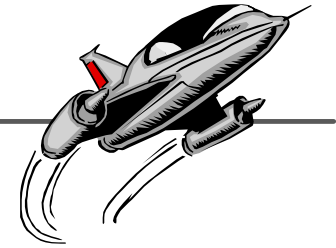

FINE PRINT

This presentation describes some options being considered for future DataInterchange development. It does not imply a commitment to providing any such features in any future product.

DI Roadmap

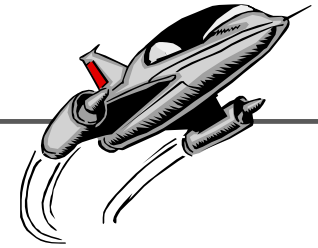

★ Highlights

- Migration to DI 3.1
- XML <--> ADF Support
- Any-to-Any Mapping
- SWG: MQSI and WS B2BI

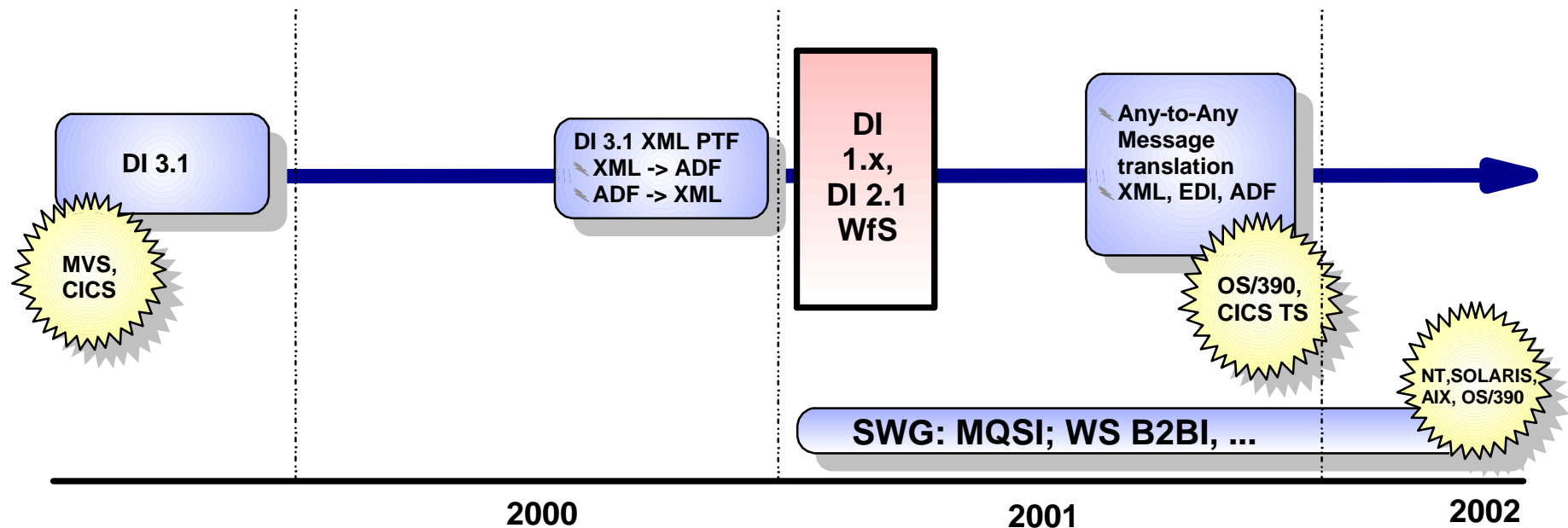

WfS: Withdrawal from Support

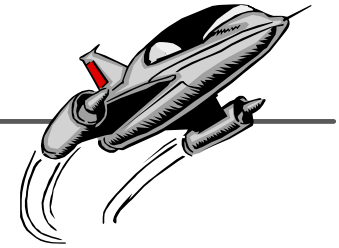

★ Effective January 31, 2001

- ✦ DataInterchange 1.5 (and previous versions); DataInterchange 2.1
- ✦ Customers should be working now to migrate to DI 3.1
 - HOST Features
 - Pageable translation
 - Complete VSAM and DB2 Installation support
 - Allow Multiple ALPHANUM tables
 - CLIENT Features
 - Mapping Fixed-to-Fixed
 - Full Compliance checking
 - Client ported to 32-Bit
 - Allow envelope profile to be exported/imported on receive maps
 - "Where Used" function
 - Allow Multiple ALPHANUM tables
 - Export/Import of Client Maps
 - Mandatory Segments and Elements Identifier

XML: DI 3.1 PTF

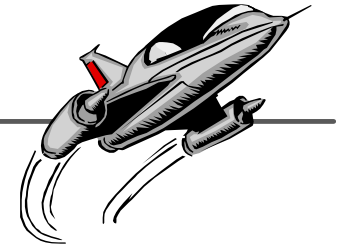

★ XML: eXtensible Markup Language

- ✍ Interim support for XML
- ✍ Allows for ADF --> XML (send), and XML --> ADF (receive)
- ✍ Will allow for DTD importing
- ✍ Enabling XML as a "standard" within DI
- ✍ Allow for customer migration to 3.1 following WfS (31 JAN 2001) of 1.x, and 2.1
 - Target availability: Nov 30, 2000

Any-to-Any Translation

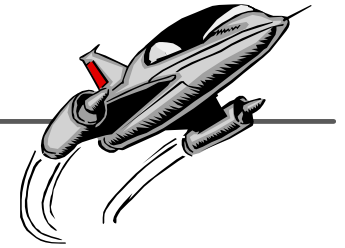

- ⚡ Looking to add any-to-any transformation capabilities along with support for a new syntax "comma separated values" (CSV)
 - Allows for translation of XML-to-XML, XML-to-EDI, EDI-to-EDI, XML-to-CSV, etc. (i.e. any combination of the data types XML, EDI, ADF and CSV)
- ⚡ Looking to enhance Client interface to provide any-to-any graphical mapping with native support for storing, displaying and mapping DTD's
- ★ Add the capability to call sub maps from within a map to handle the transmission of HL7 documents within an X12 document

SWG: IBM Software Group

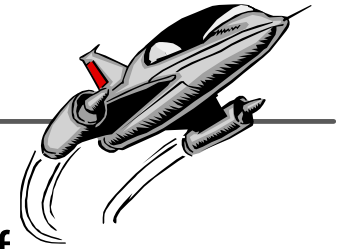

★ WebSphere B2B Integrator

- ✦ provides a middleware framework for the implementation of business-to-business solutions
 - A comprehensive, business-process-oriented, business-to-business (B2B) application solution which addresses both intra/extra enterprise transactions
 - Built-in features for communications, security, configuration, and process traceability which allow for intelligent data transformation, content-based routing and event-driven business process execution
 - Promotion of web based interaction and collaboration by providing for easy integration with a range of partners, using a variety of industry standard open data exchange protocols such as RosettaNet
 - Exploitation of both message-oriented and object-oriented component interaction models to effectively address the often complex requirements arising from integration of business processes and applications within and across enterprise
 - A representative set of reusable, installable, and configurable solution templates which will accelerate solution deployment and so reduce time to market

SWG: IBM Software Group...

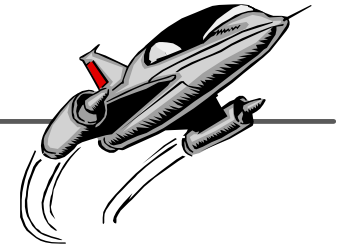

★ MQSeries Integrator

- ✦ Powerful message-brokering software that provides real-time, intelligent rules-based message routing, and content transformation and formatting
 - Reformatting, working dynamically with the rules component, parses, maps and reformats messages by using on-the-fly conversions, transformations, and message enrichment
 - Usability features for those defining broker actions include graphical user interfaces, editable definition files, and a visual tester
 - MQSeries Integrator accommodates custom-built or predefined libraries of application templates, and e-business extensions are provided to ensure new systems are easily and quickly integrated

Seek and Learn!

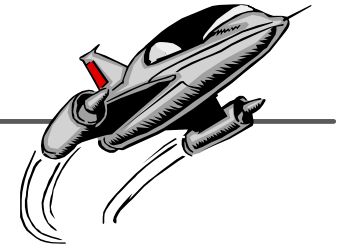

★ You are now at the

DataInterchange User's Conference

DI - Electronic Commerce and Beyond

- ✦ SEEK out the Answers to your questions
 - Sessions, Workshops, Developers, Support Personnel, Sales, Marketing Support
- ✦ LEARN how DI can better your IT Solutions
 - Also, how to make the move to DI 3.1
 - If you haven't already done so
 - Ask the tough Questions!