



Electronic Commerce in a Regulated Environment

Kristy Johnson

Columbia Gas
TransmissionSM

Columbia Gulf
TransmissionSM

Columbia Gas Transmission

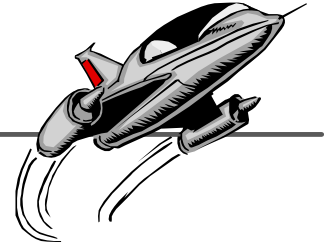

- ★ 12,550 miles of pipeline
- ★ Crosses 10 Midwestern, Northeastern and Mid-Atlantic states

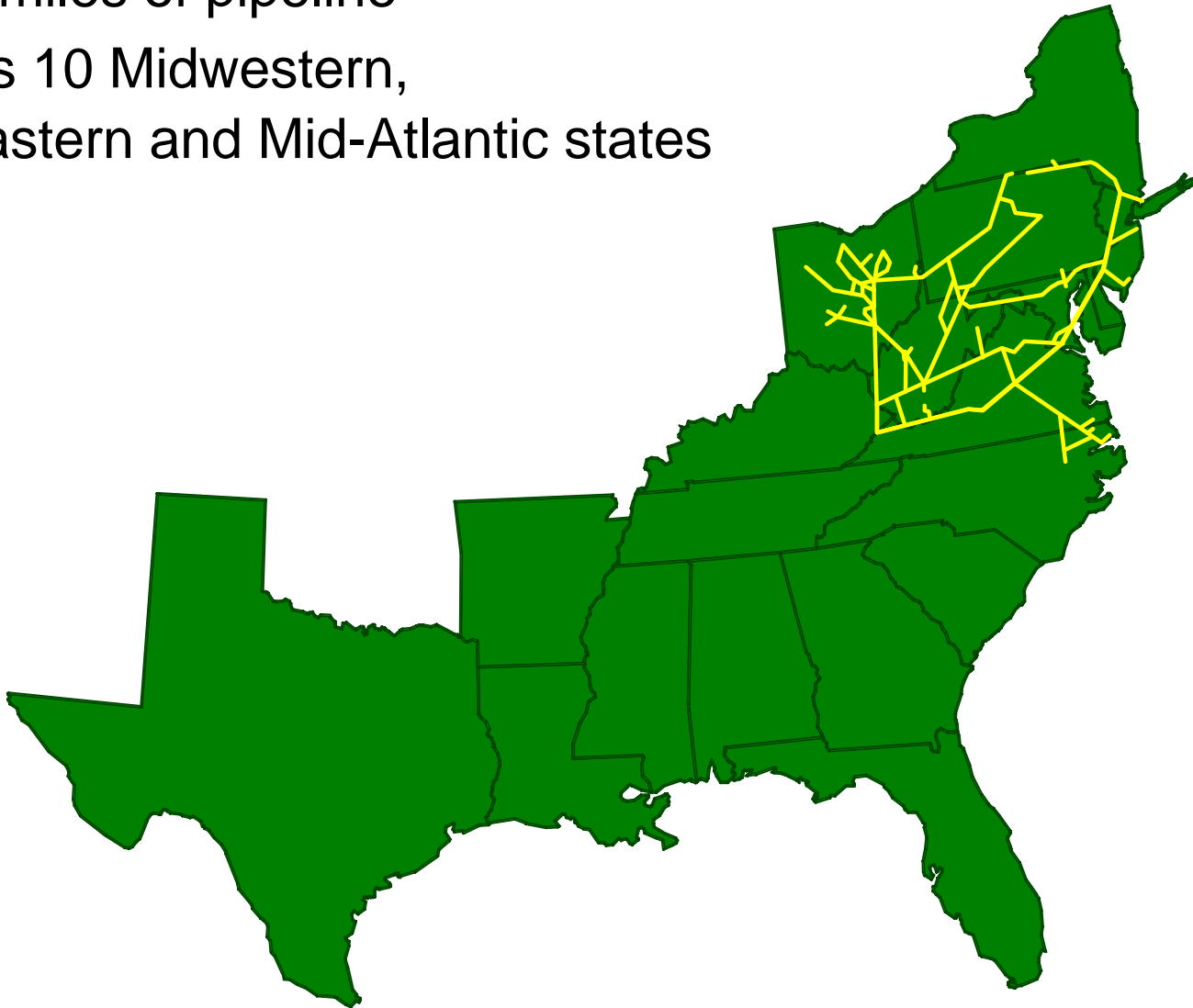

Columbia Gulf Transmission

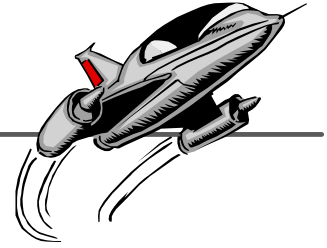

- ★ Operates a 4,200-mile pipeline system
- ★ Extends from offshore Louisiana to Kentucky
- ★ Interconnects with facilities of virtually every major natural gas producer in the Gulf of Mexico

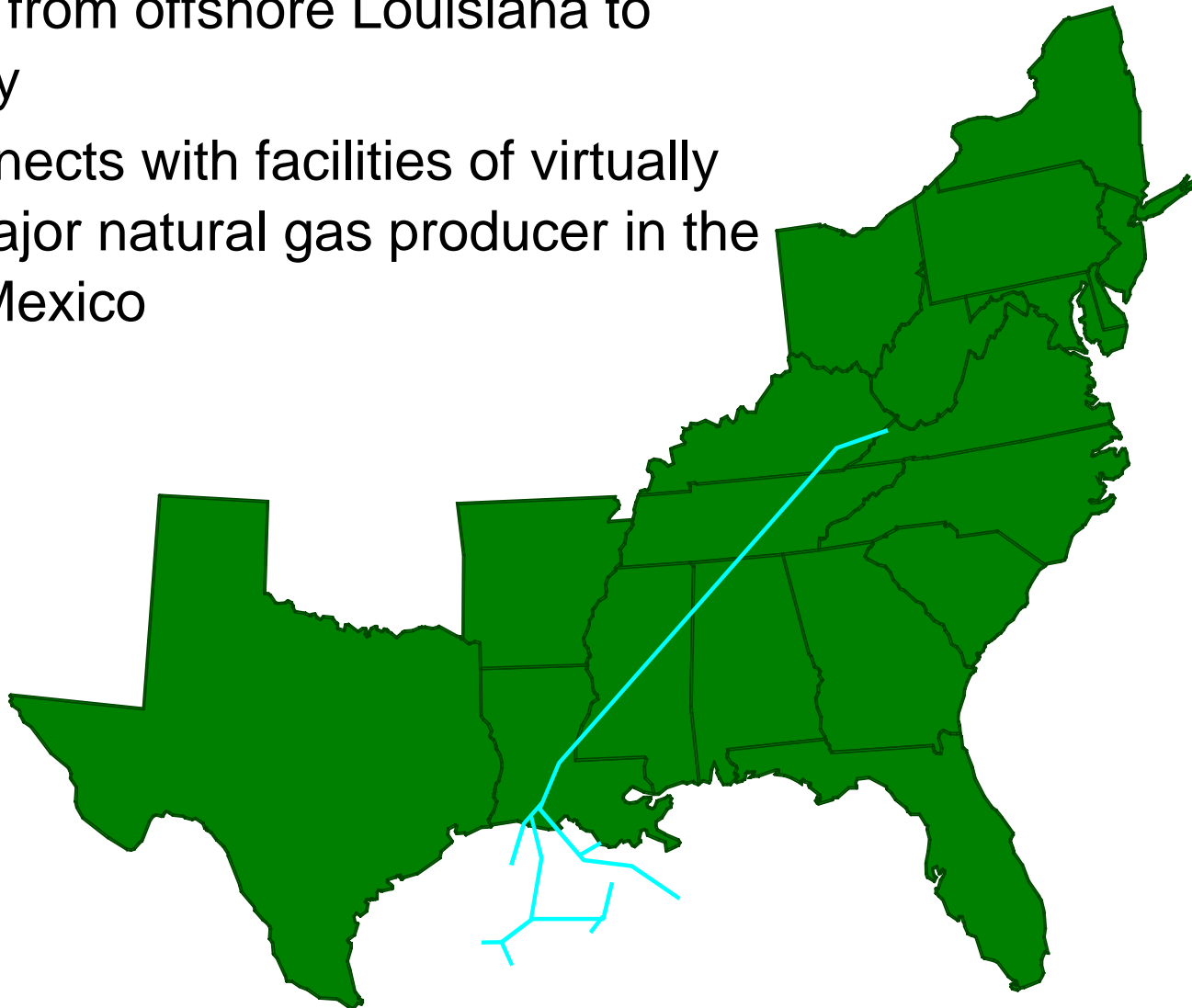

Transmission Storage

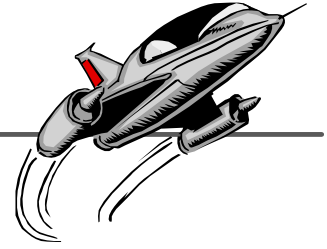

- ★ 44 underground storage fields in West Virginia, Ohio, Pennsylvania and New York. Most fields are one mile below the surface

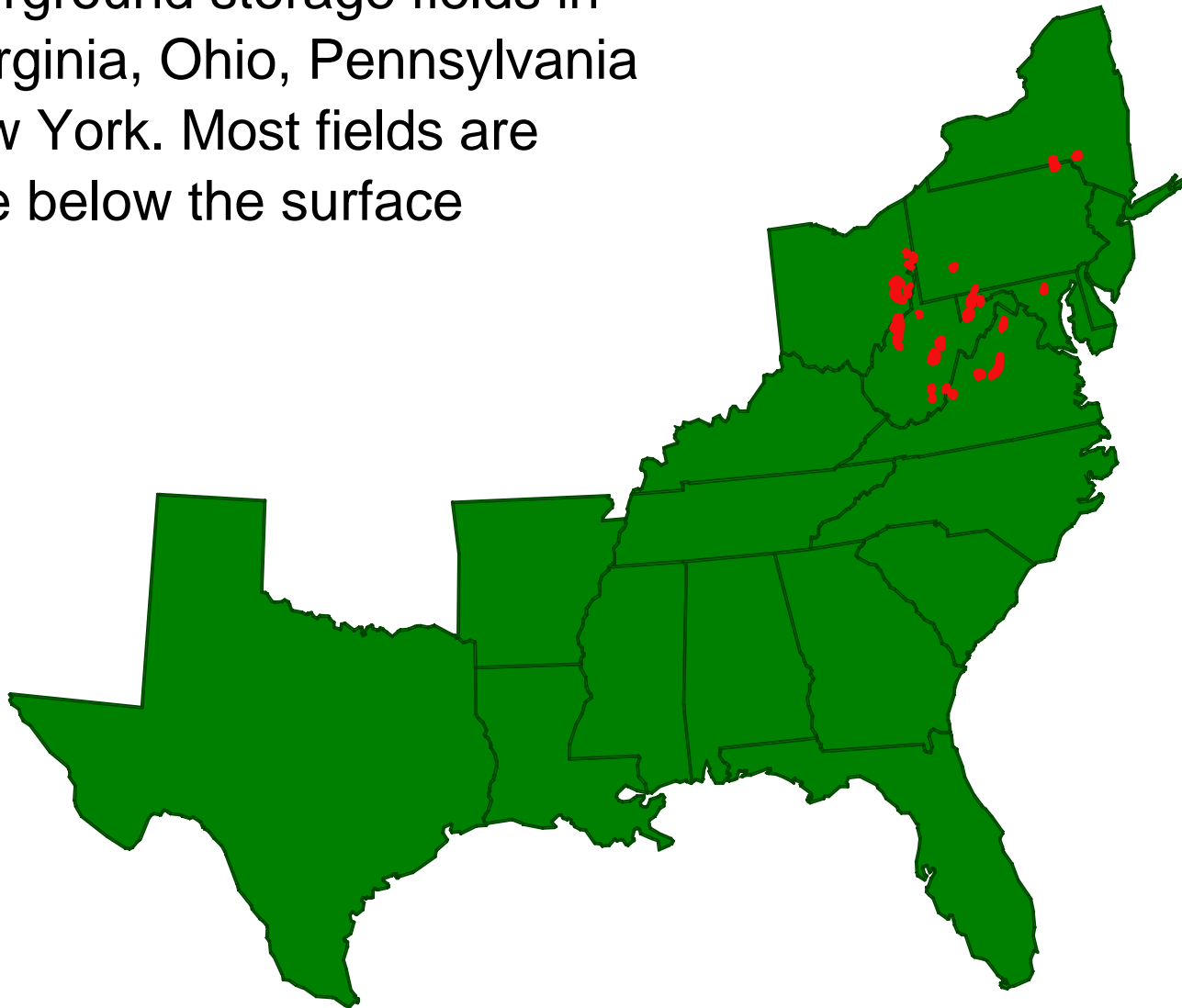

Transmission Volumes

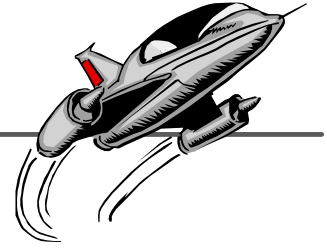

- ★ Delivers 1.3 trillion cubic feet of gas per year to 72 local distribution companies and several hundred gas end-users in southern, northeastern, mid-western and mid-Atlantic states
- ★ Peak day deliveries 7.5 billion cubic feet

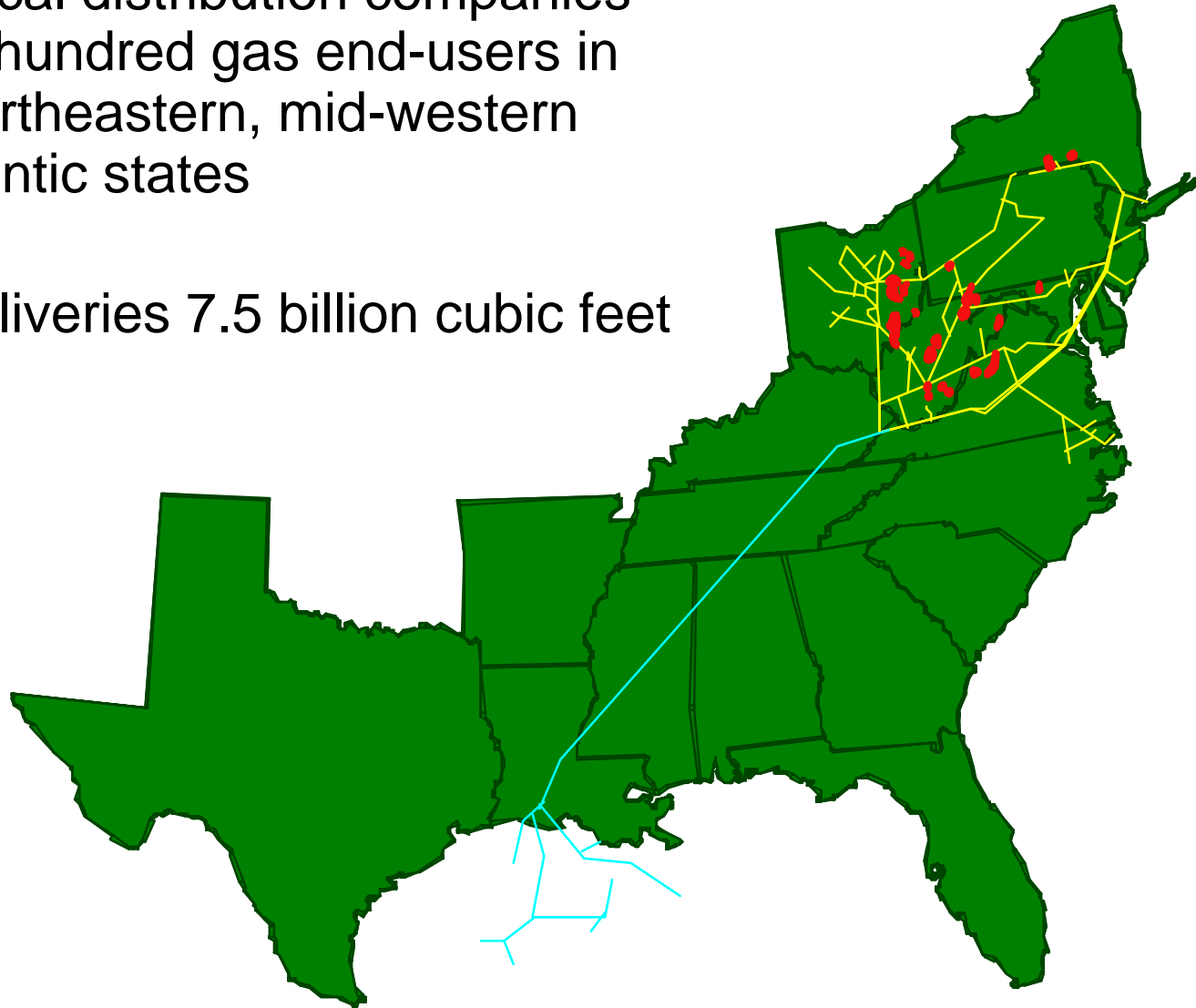

Transmission Facilities

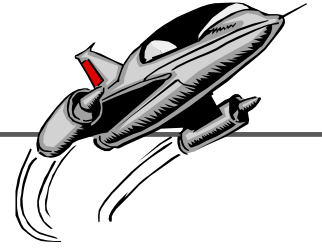

- ★ 12,550 miles of pipeline
- ★ 140 compressor stations
- ★ Combined total of more than 600,000 horsepower

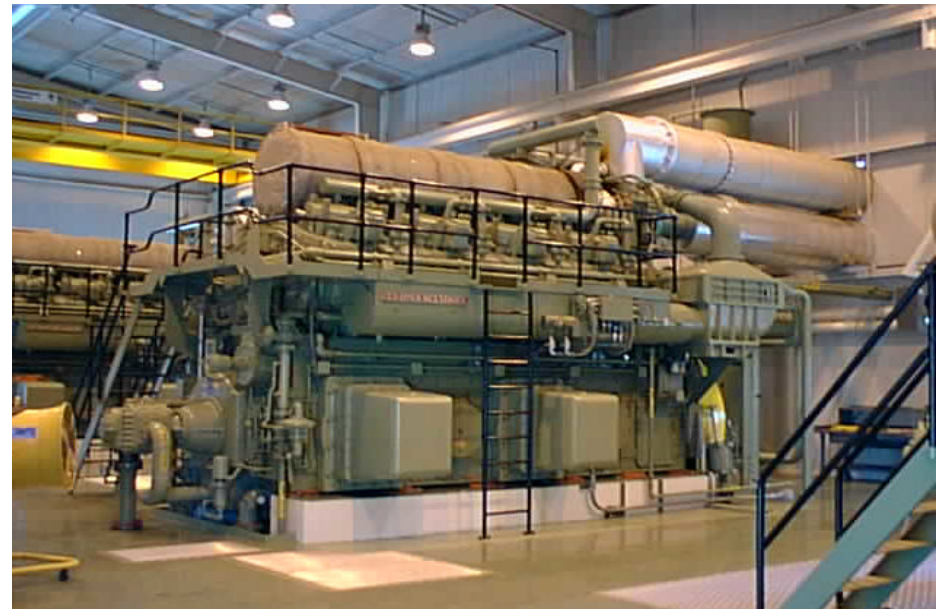

Transmission Storage

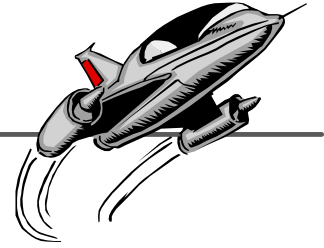

- ★ 239 billion cubic feet of working capacity
- ★ 44 underground storage fields in West Virginia, Ohio, Pennsylvania and New York. Most fields are one mile below the surface
- ★ 3,650 wells on 870,000 acres
- ★ Total capacity greater than 619 billion cubic feet
- ★ Includes more than 4.4 billion cubic feet from storage on peak day
- ★ One of the largest systems in the nation



Electronic Commerce

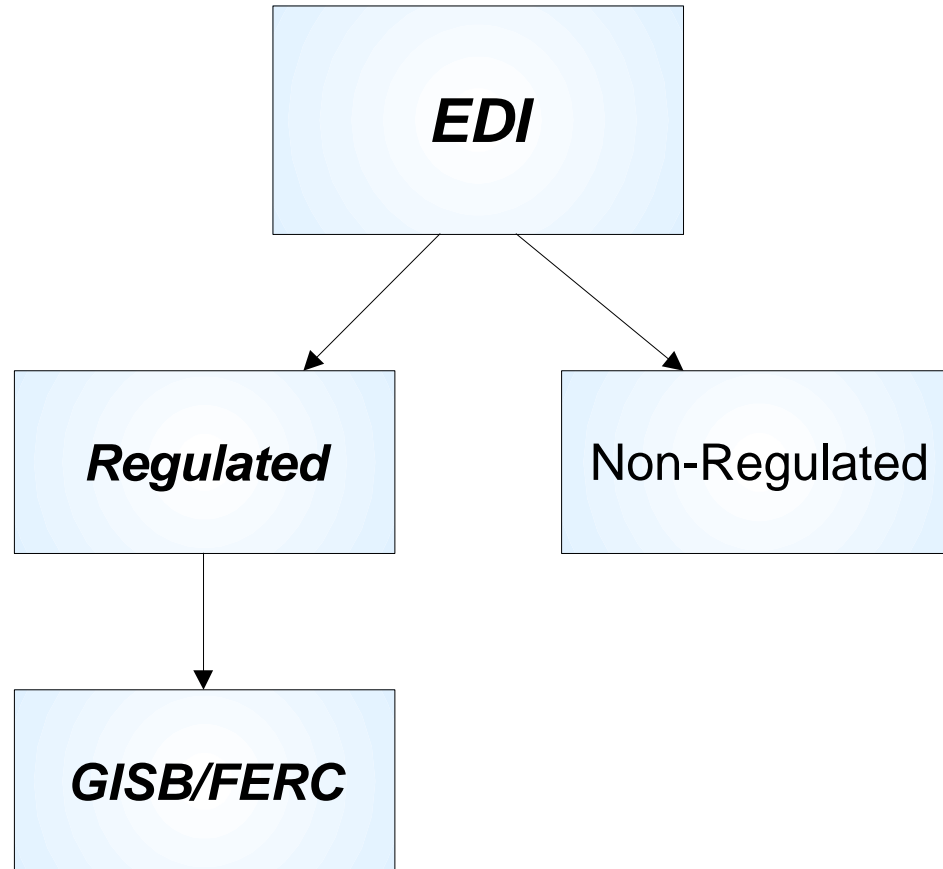
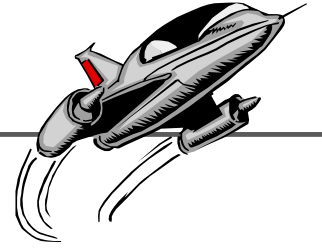

Regulated Electronic Commerce

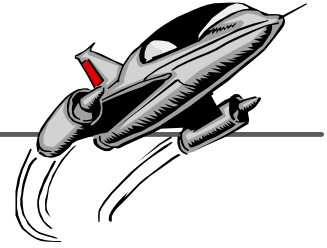

- ★ Support 36 GISB defined transaction sets
- ★ Process EDI 24X7
 - ✍ No scheduled weekday outages
 - ✍ Some weekend maintenance outages
- ★ Over 300 transactions daily

Federal Regulation

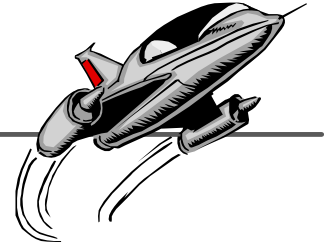

GISB Recommended - FERC Mandated

★ GISB - Gas Industry Standards Board

★ FERC - Federal Energy Regulatory Commission

GISB Process

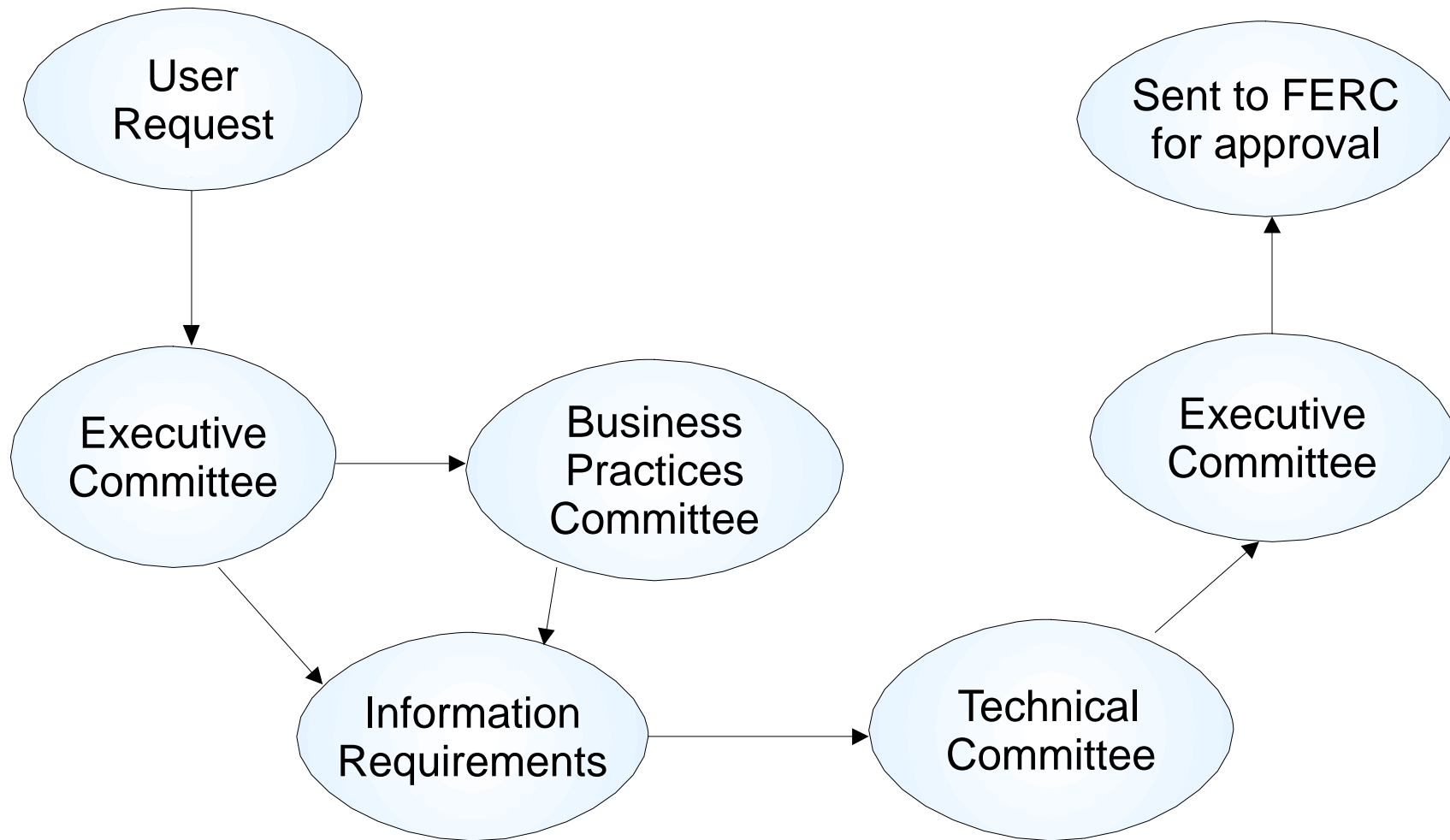
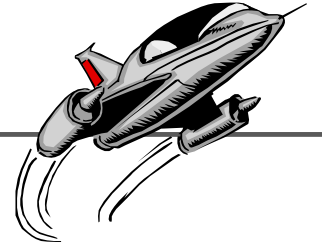

FERC Process

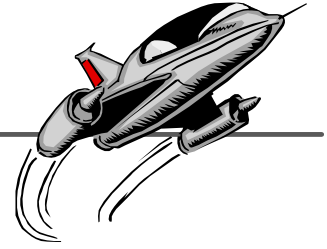

- ★ Meets almost monthly
- ★ Receives and reviews GISB's recommendations
- ★ Invites discussion
- ★ Issues ruling
- ★ Usually allow 90 days for implementation after ruling

FERC Mandates

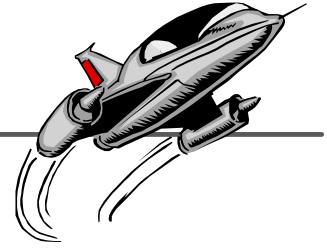

- ★ Internet based EDI
- ★ Internet based EBB



GISB Requirements

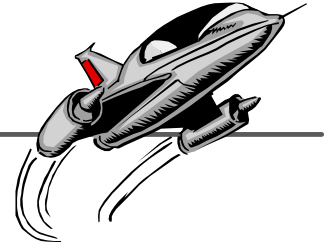

- ★ Accept X12V3R40
- ★ Trade 36 datasets
- ★ Provide secure EDM process
- ★ Insure EDI has same capability as EBB

GISB/FERC Approved Datasets

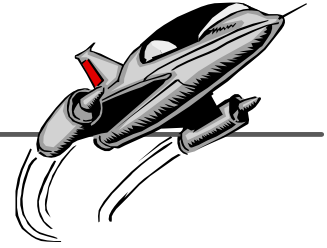

★ Nominations -

- ✍ 850 Nomination
- ✍ 855 Nomination Quick Response
- ✍ 850 Request for Confirmation
- ✍ 855 Confirmation Response
- ✍ 865 Scheduled Volumes
- ✍ 865 Scheduled Quantity for Operators
- ✍ 855 Confirmation Response Quick Response

★ Flowing Gas -

- ✍ 860 Pre-Determined Allocation
- ✍ 865 PDA Quick Response
- ✍ 811 Shipper Imbalance
- ✍ 865 Allocation
- ✍ 867 Measurement Information
- ✍ 867 Measured Volume Audit

★ Invoicing -

- ✍ 810 Invoice
- ✍ 820 Payment Remittance
- ✍ 822 Statement of Account

GISB/FERC Approved Datasets (cont.)

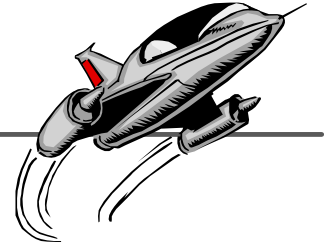

★ Capacity Release -

- ✍ 840 Upload to Pipeline of Prearranged Deal (UPPD)
- ✍ 843 UPPD Validation Quick Response
- ✍ 840 UPPD Notification
- ✍ 843 UPPD Bidder Confirmation
- ✍ 824 UPPD Bidder Confirmation Validation Quick response
- ✍ 567 UPPD Final Disposition
- ✍ 846 Upload of Request for Download of Posted Datasets
- ✍ 846 Response to Upload of request for Download of Posted Datasets
- ✍ 840 Offer
- ✍ 843 Bid
- ✍ 843 Award
- ✍ 843 Withdrawal
- ✍ 840 Operationally Available
- ✍ 840 Unsubscribed Capacity
- ✍ 864 System Wide Notices
- ✍ 864 Notes

X12 - The GISB Way

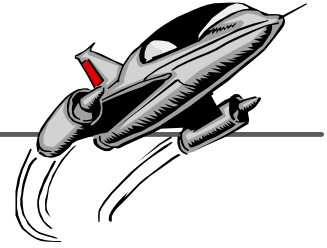

ISA~00~ ~00~ ~14~791182710INTT ~01~054748041
~000323~0929~U~00304~000000791~0~T~`
GS~PO~ENOMI054748041~850NOM~000323~092944~771~X~003040
ST~850~000000001
BEG~00~G1~U000066000000000020270~~000323
DTM~102~~~~~DT~200003230928
N1~SJ~~1~054748041
N1~78~~1~791182710
PO1~1~~~~~CR~37147~MN~P
DTM~007~~~~~DT~200003240900
DTM~197~~~~~DT~200003250900
SLN~65809~65809~I~20000~BZ
SI~AP~QT~D~TT~08~PG~65809~R1~010~R2~900~R3~900~R4~099~UK~57514-IPP~DK~37147-IPP
N1~M2~~29~222388
N1~MQ~~29~222388
N1~US~~1~176806198
N1~DW~~1~791182710
SLN~65555~65555~I~0~BZ
SI~AP~QT~D~TT~08~PG~65555~R1~010~R2~900~R3~900~R4~099~UK~51860-IPP~DK~37147-IPP
N1~M2~~29~222388
N1~MQ~~29~222388
N1~US~~1~966238628
N1~DW~~1~791182710
CTT~1
SE~21~000000001
GE~1~771
IEA~1~000000791

The EDM Process

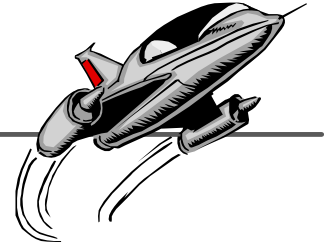

★ *X12 data is encrypted and digitally signed using PGP*

EDM Schematic

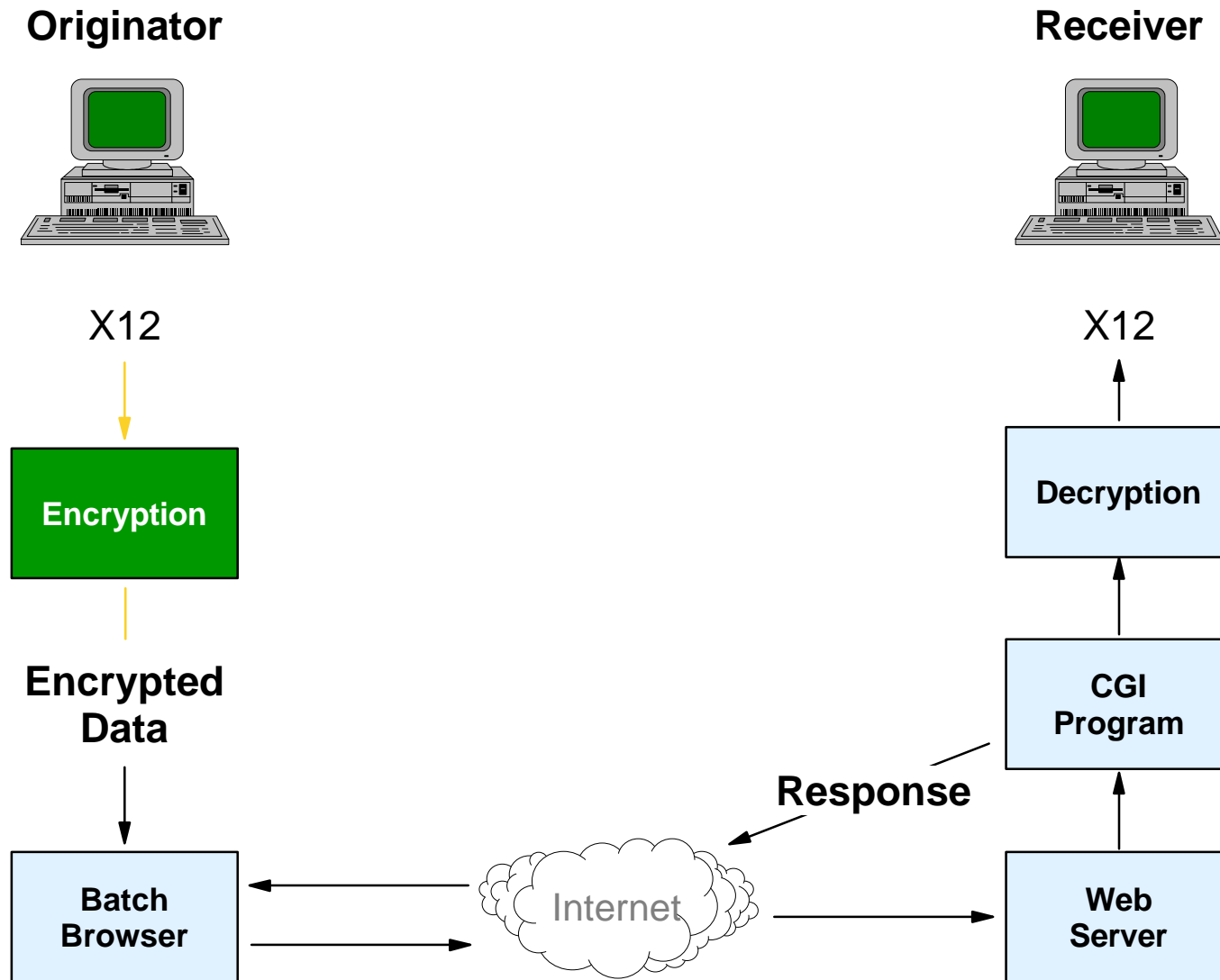
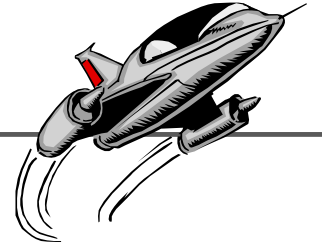

The EDM Process

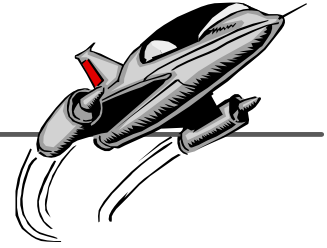

★ *X12 data is encrypted and digitally signed using PGP*

The EDM Process (cont.)

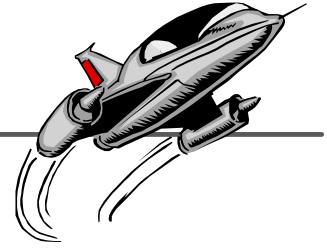

- ★ *X12 data is encrypted and digitally signed using PGP*
- ★ *Encrypted data is sent to the receiver's web server*

EDM Schematic

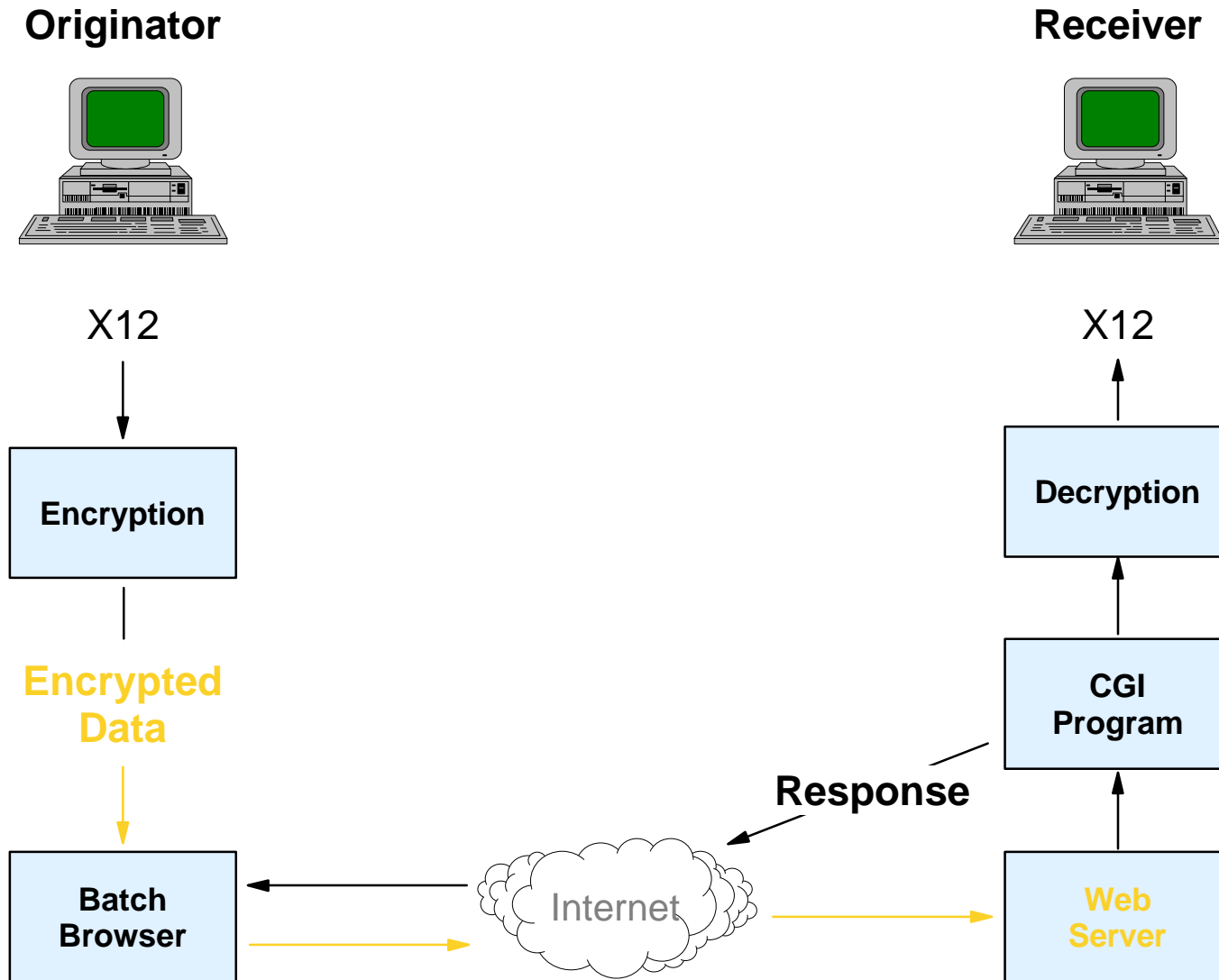
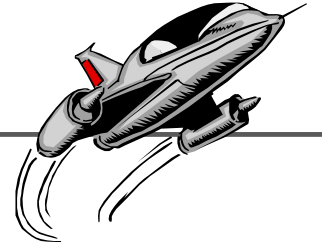

HTTP POST

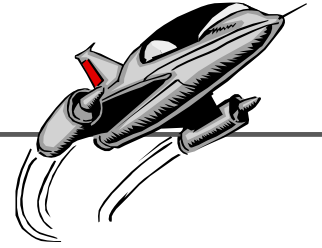

```
POST http://edi.columbiaenergy.com/transmission/edm.pl HTTP/1.0
Connection: Keep-Alive
User-Agent: Mozilla/3.01 (WinNT; I)
Host: edi.columbiaenergy.com
Accept: image/gif, image/x-xbitmap, image/jpeg, image/pjpeg, */*
Content-type: multipart/form-data; boundary=-----70331776229593
Content-Length: 842
```

```
-----70331776229593
Content-Disposition: form-data; name="from"
```

123456789

```
-----70331776229593
Content-Disposition: form-data; name="to"
```

234567890

```
-----70331776229593
Content-Disposition: form-data; name="input-format"
```

X12

```
-----70331776229593
Content-Disposition: form-data; name="input-data"; filename="D:\Temp\Ugh.pgp"
```

<encrypted X12 data>

```
-----70331776229593--
```

The EDM Process

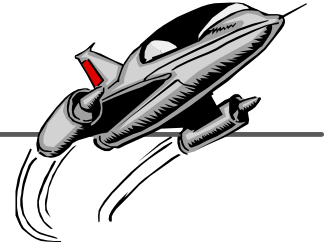

- ★ *X12 data is encrypted and digitally signed using PGP*
- ★ *Encrypted data is sent to the receiver's web server*

The EDM Process (cont.)

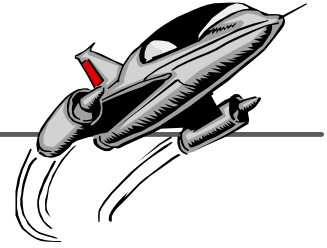

- ★ *X12 data is encrypted and digitally signed using PGP*
- ★ *Encrypted data is sent to the receiver's web server*
- ★ *Receiver's CGI program saves the data and responds*

EDM Schematic

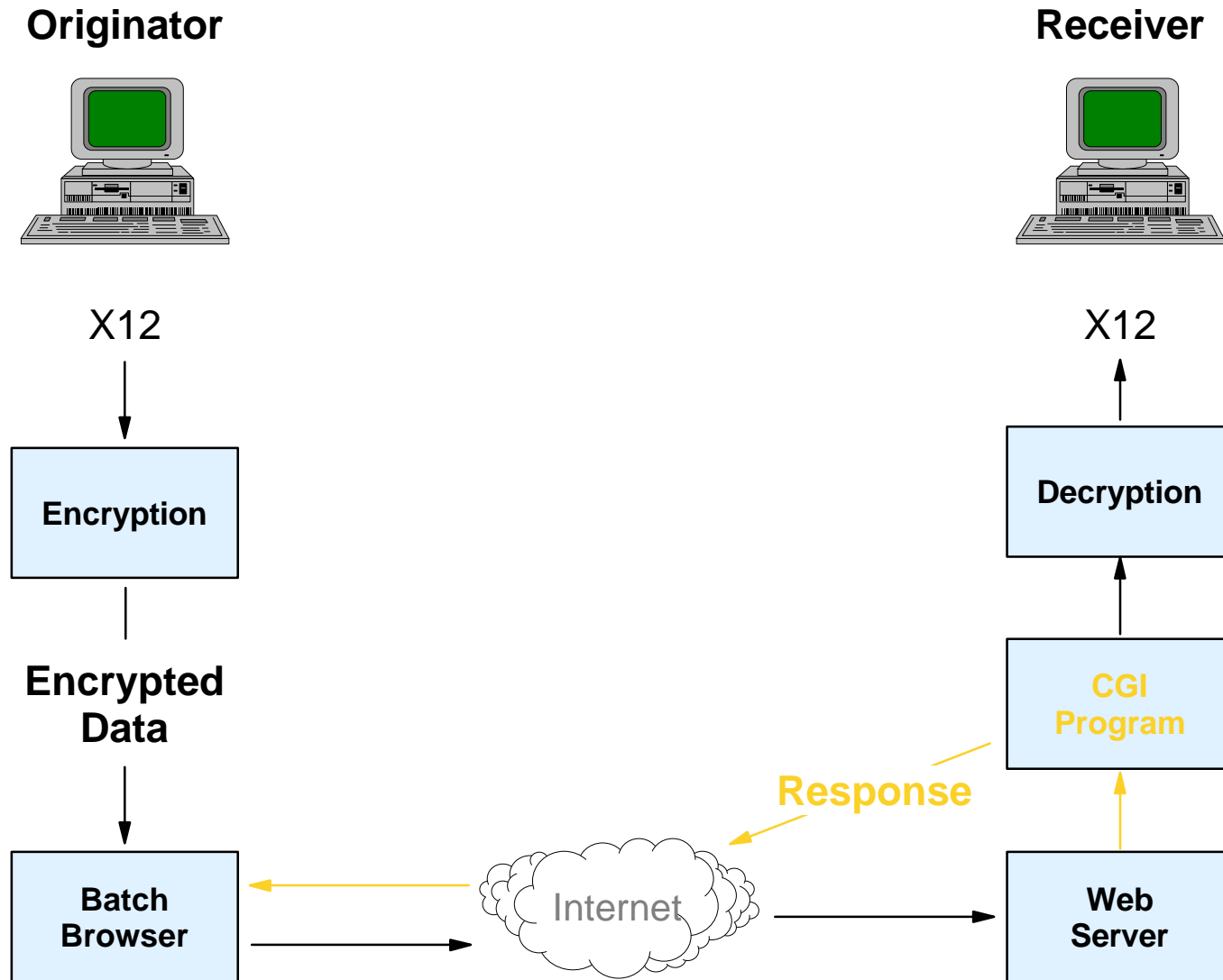
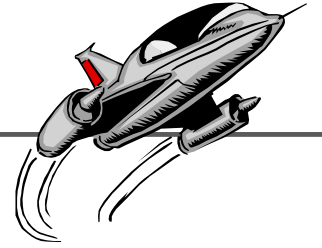

HTTP Response

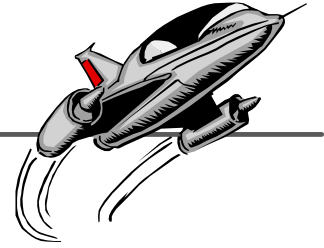

HTTP/1.0 200 OK
Content-type: text/html

```
<HTML>  
time-c=19960619082855*  
request-status=ok*  
server-id=edi*  
trans-id=2369875932*  
</HTML>
```

The EDM Process

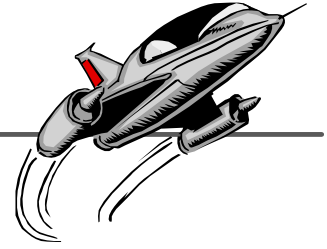

- ★ *X12 data is encrypted and digitally signed using PGP*
- ★ *Encrypted data is sent to the receiver's web server*
- ★ *Receiver's CGI program saves the data and responds*

The EDM Process (cont.)

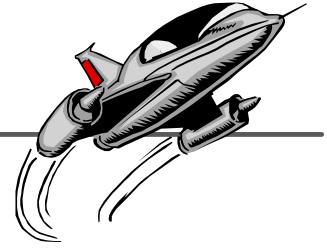

- ★ *X12 data is encrypted and digitally signed using PGP*
- ★ *Encrypted data is sent to the receiver's web server*
- ★ *Receiver's CGI program saves the data and responds*
- ★ *Receiver decrypts the data using PGP and verifies the digital signature*

EDM Schematic

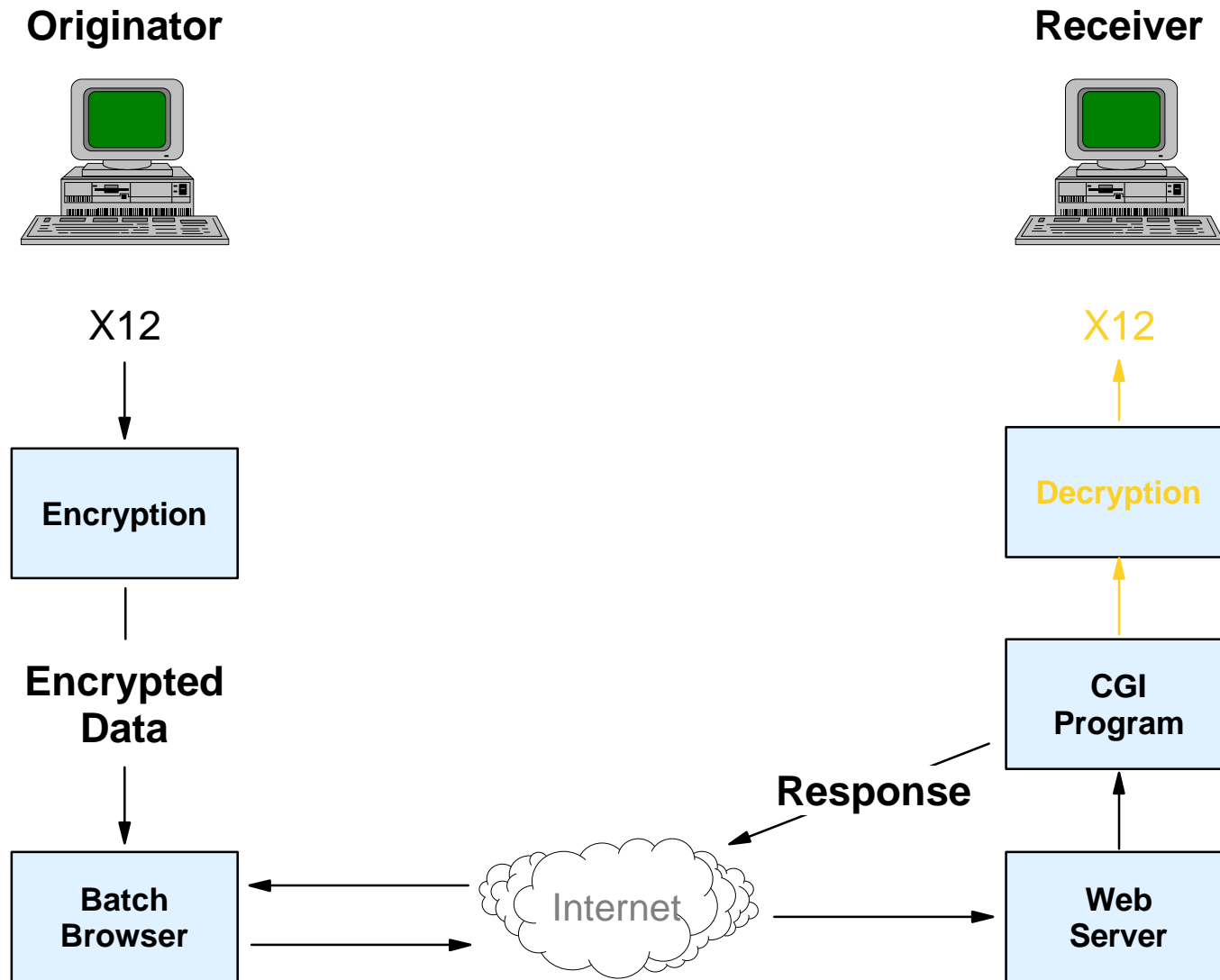
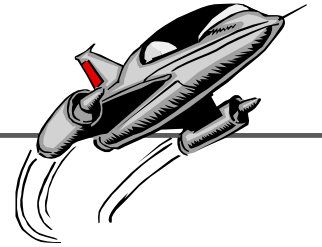

Requirements

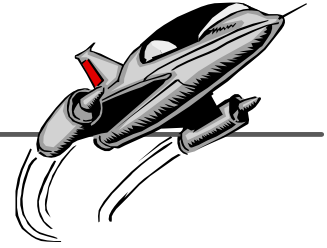

- ★ Designated site
 - ✍ Persistent Internet connection
 - ✍ Firewall
- ★ Web server
- ★ Batch browser
- ★ PGP cryptography software
- ★ CGI programming

Award Winning EBB

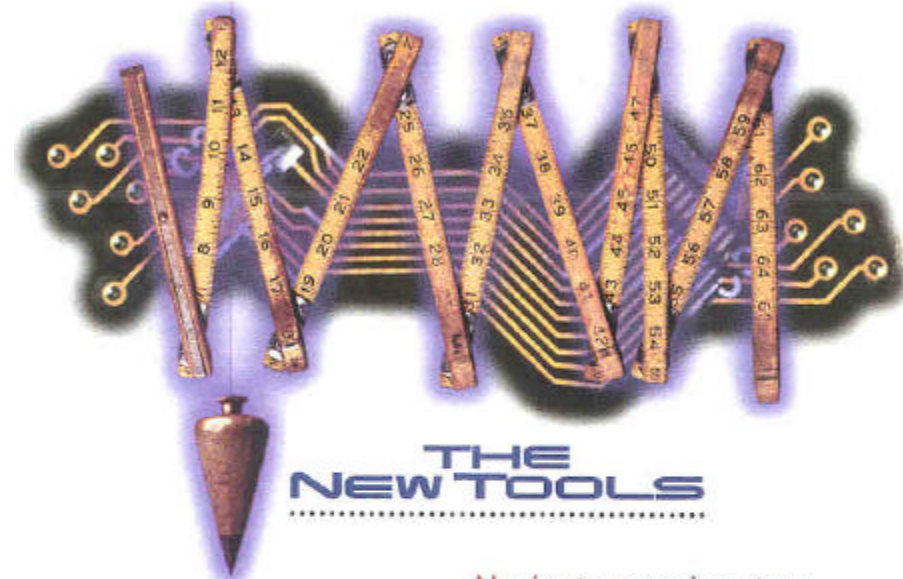
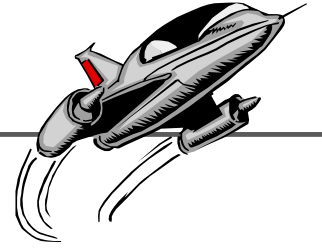

THE
NEW TOOLS

Navigator receives top
honors two years running

The Rankings

Gas Daily's NG Magazine

Award Winning EBB

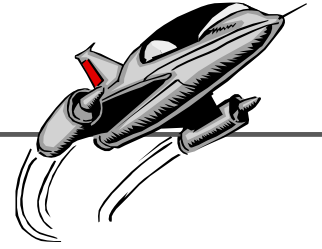

Navigator is
“far and away
the most
user-friendly,
useable platform
to conduct
daily
nominations.”

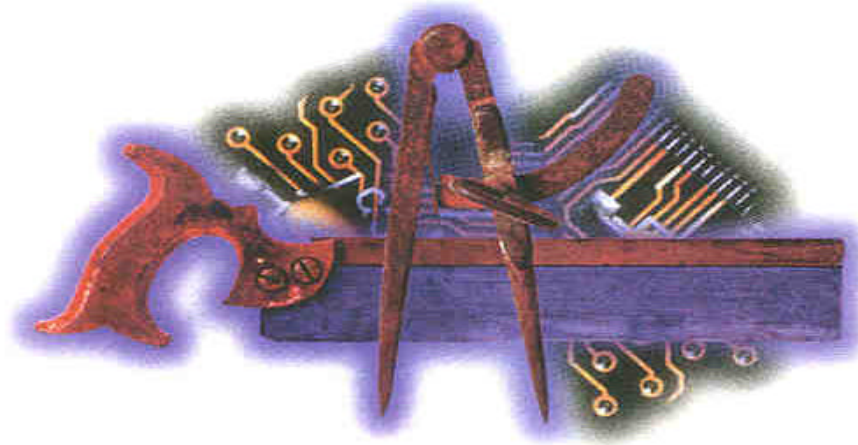

... s NG Magazine