

“Who moved my Cheese?”



Jackie Sullivan
Kraft Foods, Inc
DataInterchange Conference
October 2000



“Who moved my cheese!”



"Who moved my cheese!"

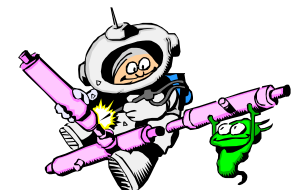

🐜 “It doesn’t look like this store’s supplier participates in a vendor managed inventory (VMI) program. If they had, then this little guy wouldn’t be without any cheese”



What is VMI?





Supplier

-  Product replenishment
-  Purchase Order
-  Forecasting



Collaborative effort

-  Reduce inventory investments
-  Improve Cash Flow
-  Enhance value to the consumer

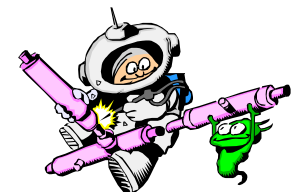

VMI Overview

- 🤖 Managed by a 3rd party software package
- 🤖 Currently represents 18% to 20% of Kraft business
- 🤖 Customers transmit 852s (Product Activity data)
- 🤖 Purchase Orders generated
- 🤖 855s (PO Acknowledgements) sent back to the customer
- 🤖 Lead time consideration

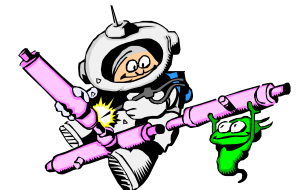



How does my store's supplier participate?



Suppliers and their distributors



Understand each other's business needs, requirements, and technical capabilities



Establish cross-functional teams



Establish measurement criteria



To participate with a supplier



Electronically deliver accurate product activity information (852)



Integrate purchase order acknowledgments (855) into their existing purchasing system

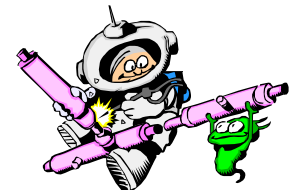

What are the benefits (besides my cheese not being out of stock)?



Supplier Benefits

- 🐹 Proper lead times and consistent order frequency
- 🐹 Daily analysis of the distributor's inventory levels
- 🐹 An accurate daily item forecast
- 🐹 Regular performance analysis tools
- 🐹 Proactive steps taken by the supplier to handle delivery delays or exceptions

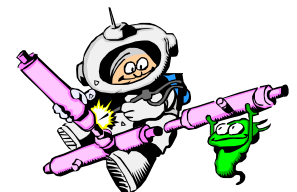

How about the benefits for the Distributor?





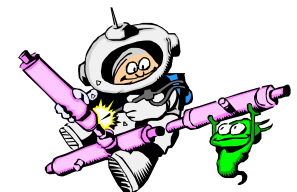

Distributor Benefits

- 🐭 Maintain the lowest possible level of inventory in their distribution centers (DCs)
- 🐭 Minimizes the potential for damage and/or returns
- 🐭 Inventory monitored in the distributor's DC
- 🐭 Generated VMI orders



Are there any additional benefits?



-  More time available to build business
-  Minimizes out-of-stock conditions
-  Shortened lead times and order cycle times
-  Provides an opportunity to improve return on assets
-  Tighter customer relationships

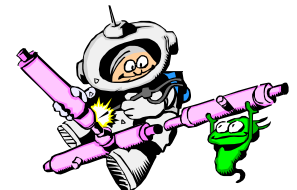



**“This is all great stuff,
but how does it all
work?”**

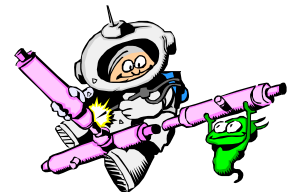

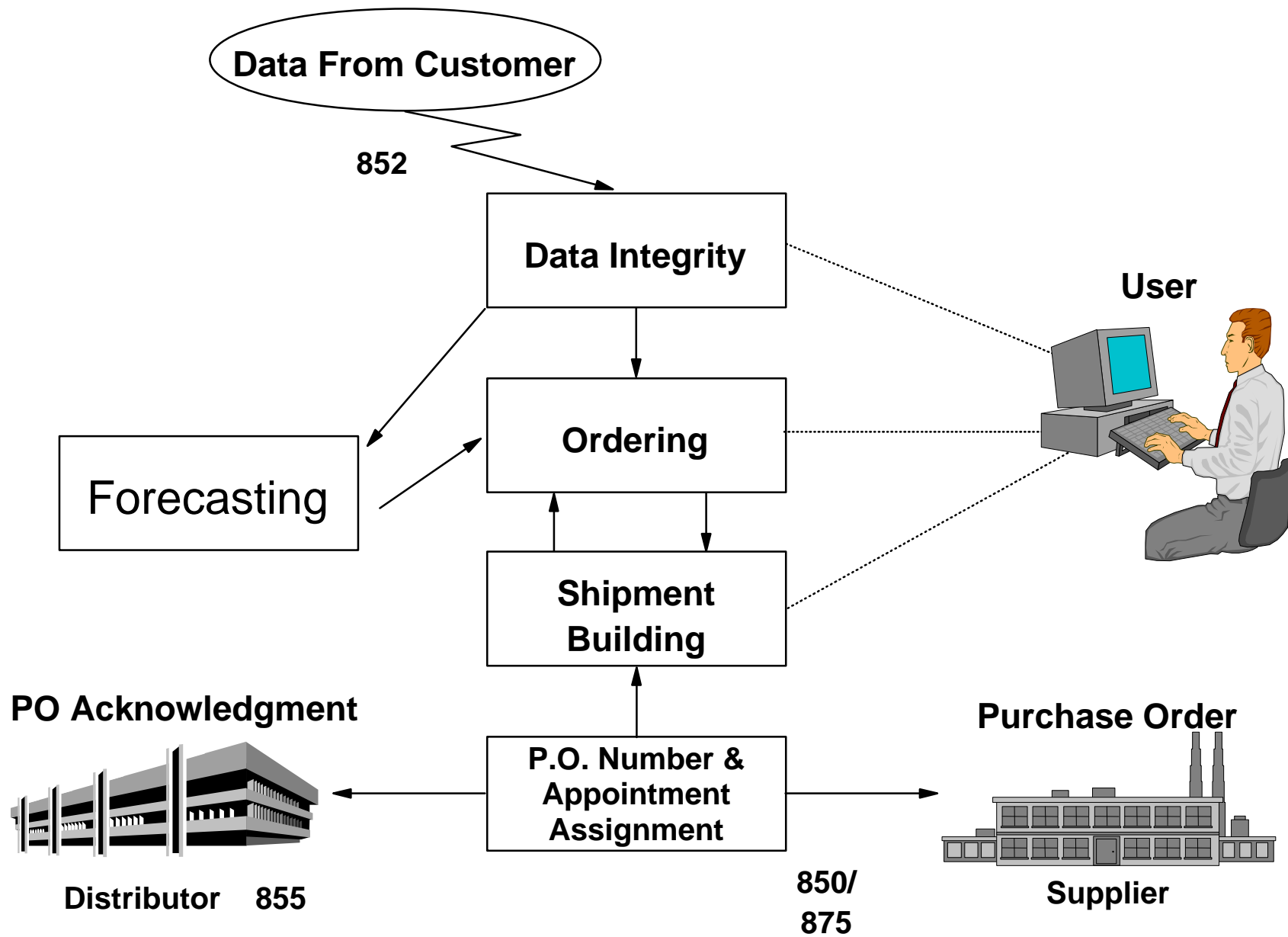



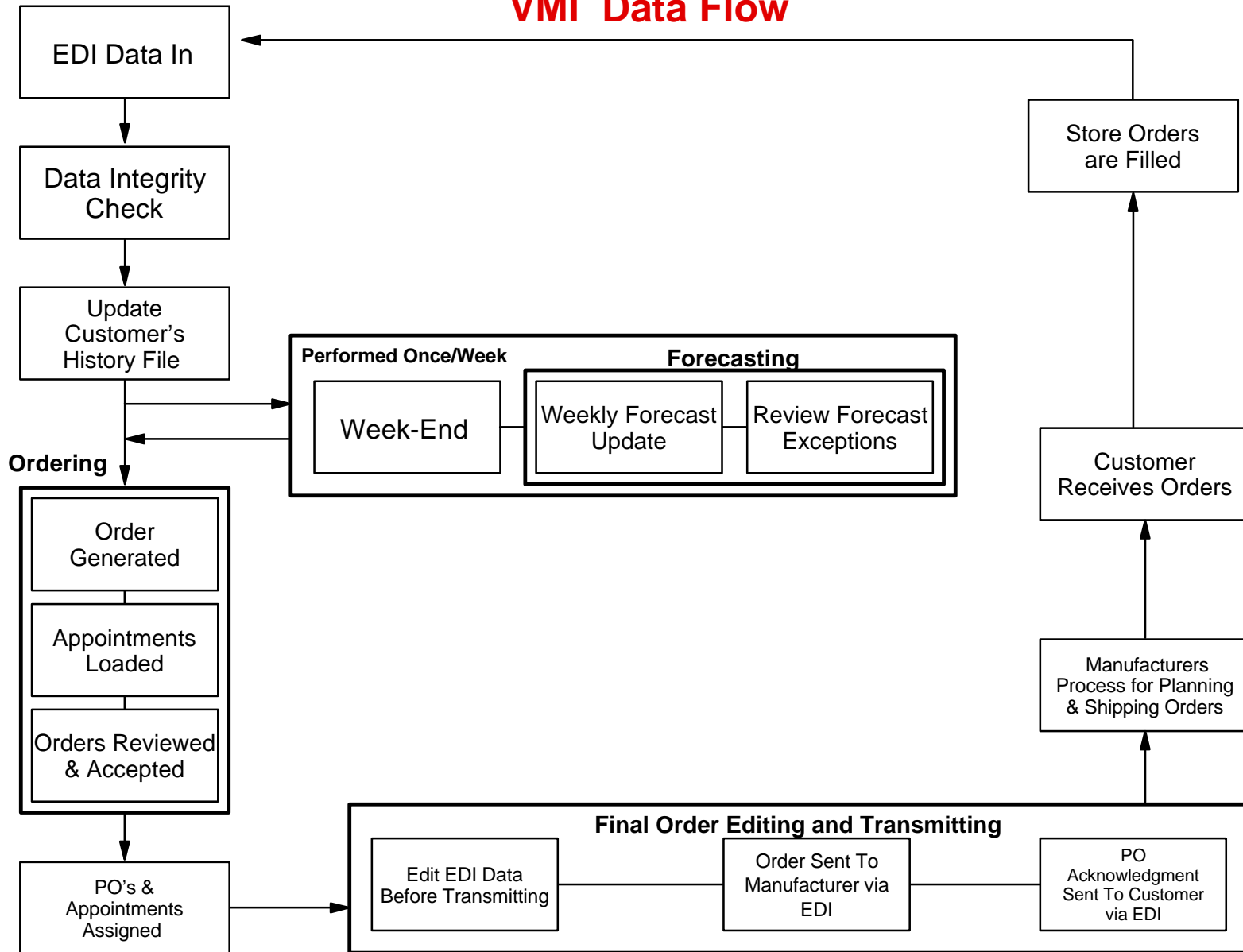







VMI Data Flow



Daily Processing



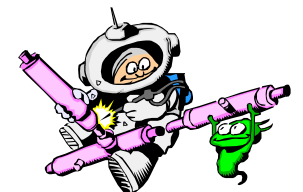

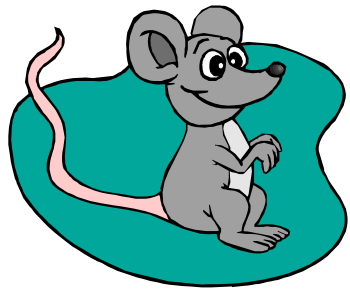

-  Data integrity
-  Update History files
-  Ordering
 -  Automatic order generation
 -  Forecast
 -  Projected Sales
 -  System Calculated
 -  Review and Edit Suggested Order(s)
 -  Automated Truck-Sizing
-  Appointments & Purchase Order Number Generation
-  Final Order Editing and Transmitting



Final Order Editing, Transmitting, and Processing



“Wow,
it uses EDI!?!”

-  Review/Edit EDI Exceptions
-  Pre-EDI Edit
-  Transmit EDI Orders
-  Print EDI Orders
-  Appointment Processing
-  Purchase Order Number Processing
-  Archiving Orders

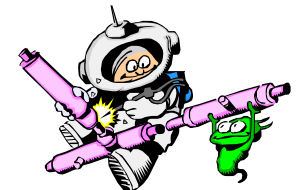

**“So how does DI fit
into this whole
process?”**

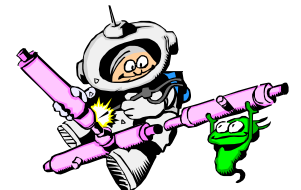

Gateway Architecture

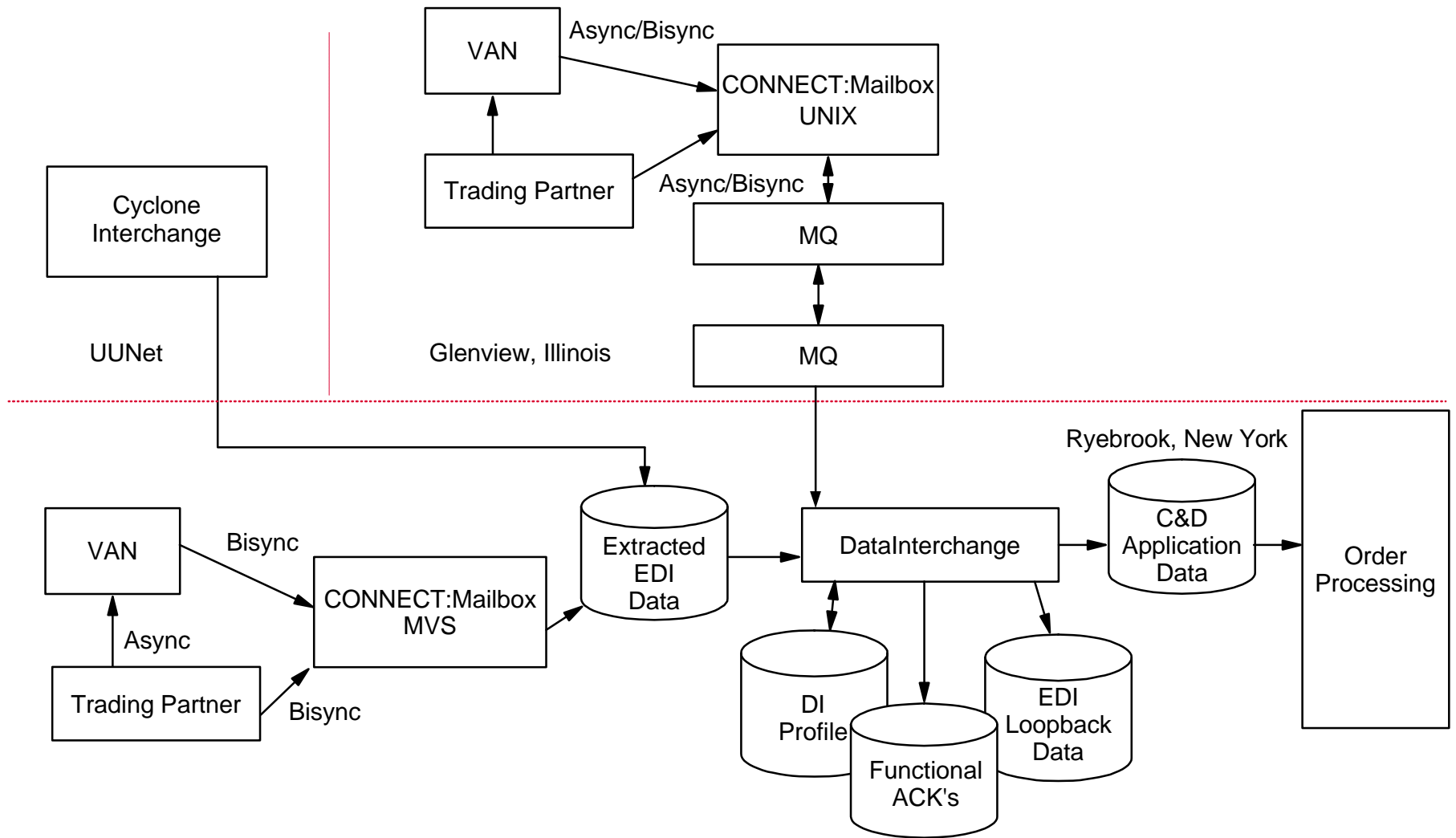

Inbound VMI Orders



Weekly Processing

End-of-week processing closes out the most recent week's collection of customer data

Forecasting

-  Create a Forecast
-  Review Forecast Exceptions
-  Modify a Forecast (if necessary)

Performance measures

Service levels and turns

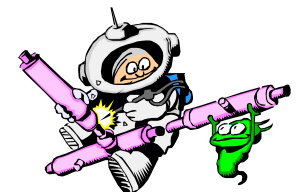

Gateway Architecture Forecasting - Current

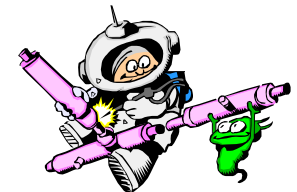
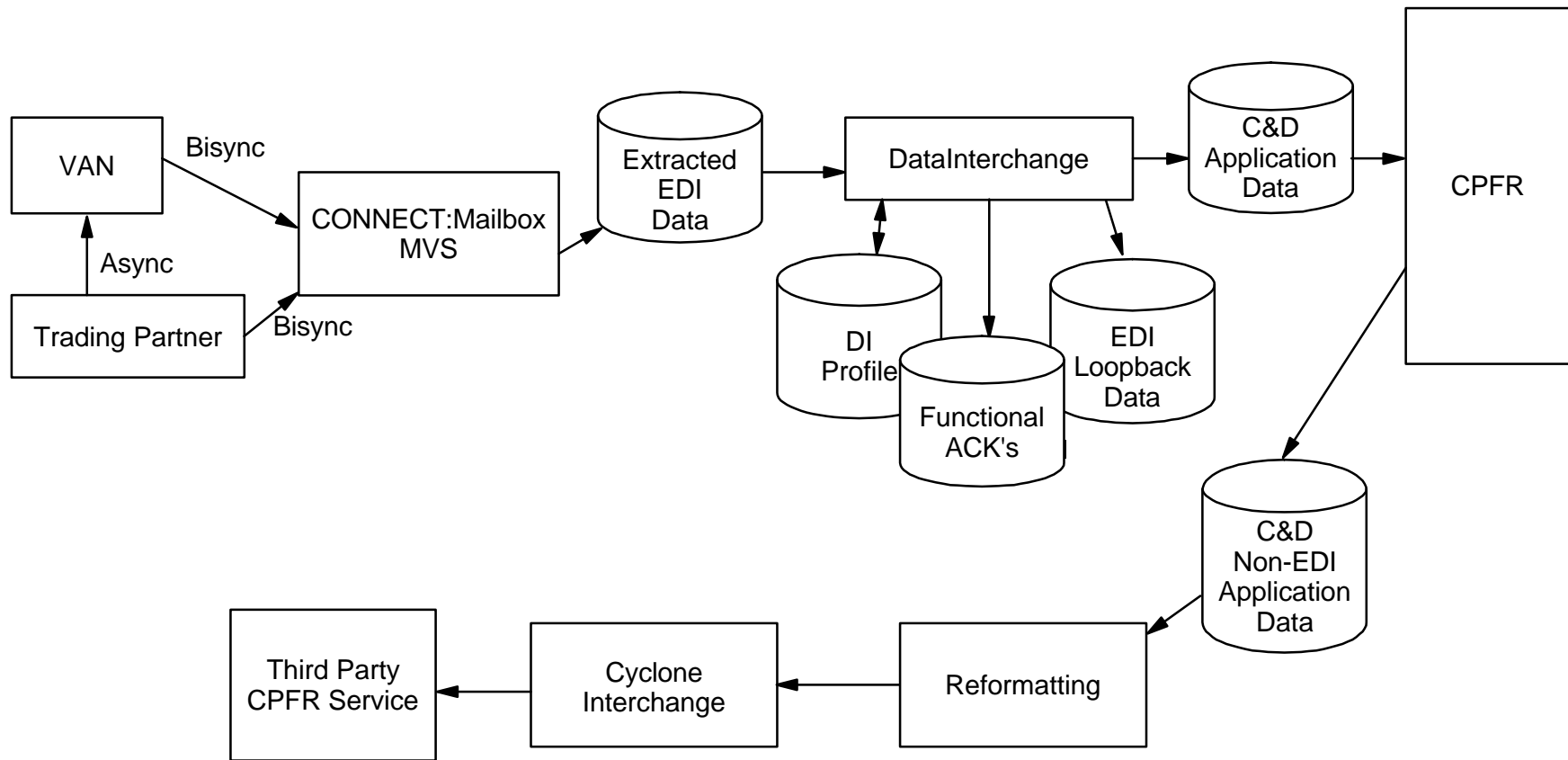

Gateway Architecture Forecasting - Pilot

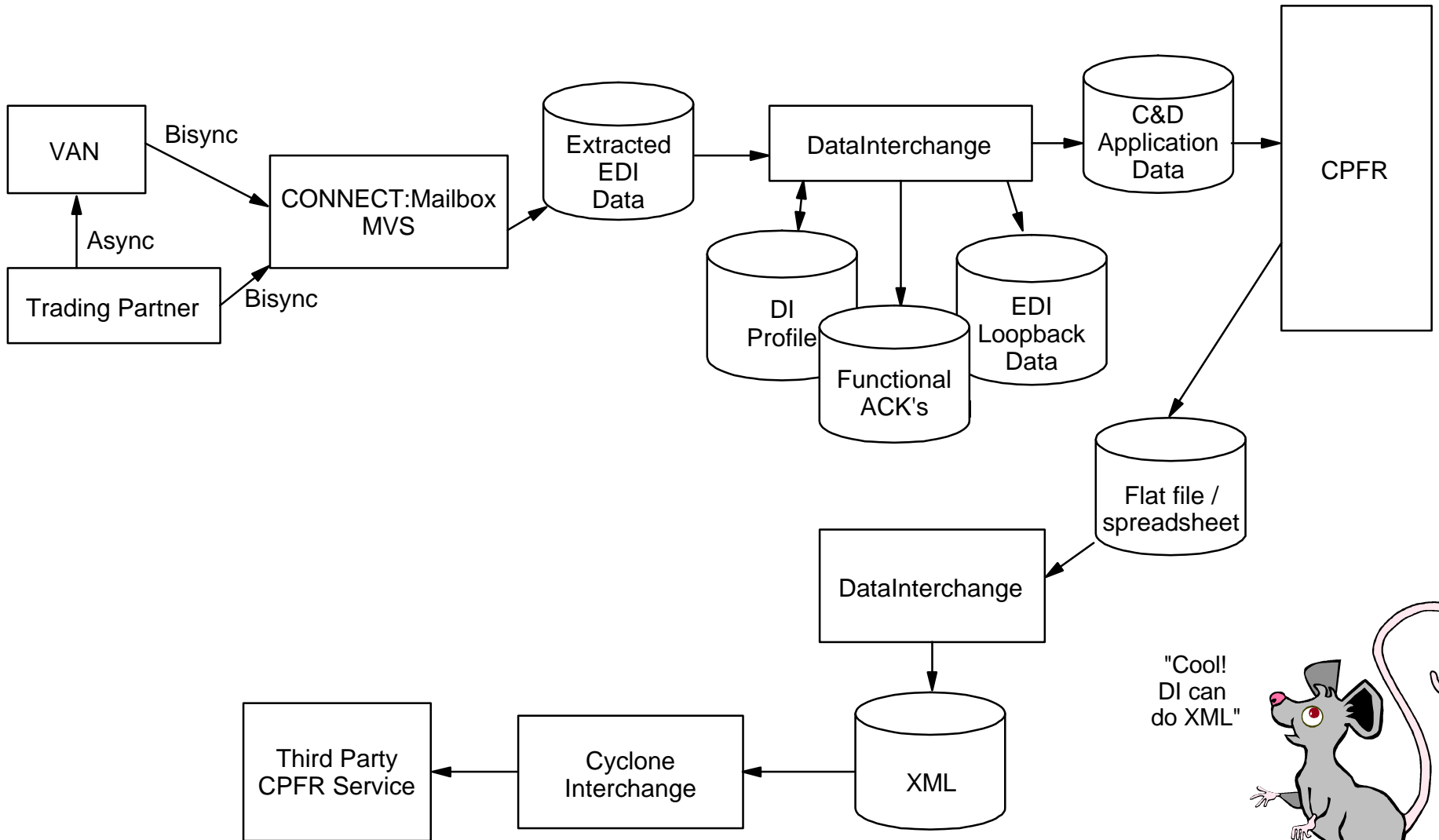

"Cool!
DI can
do XML"



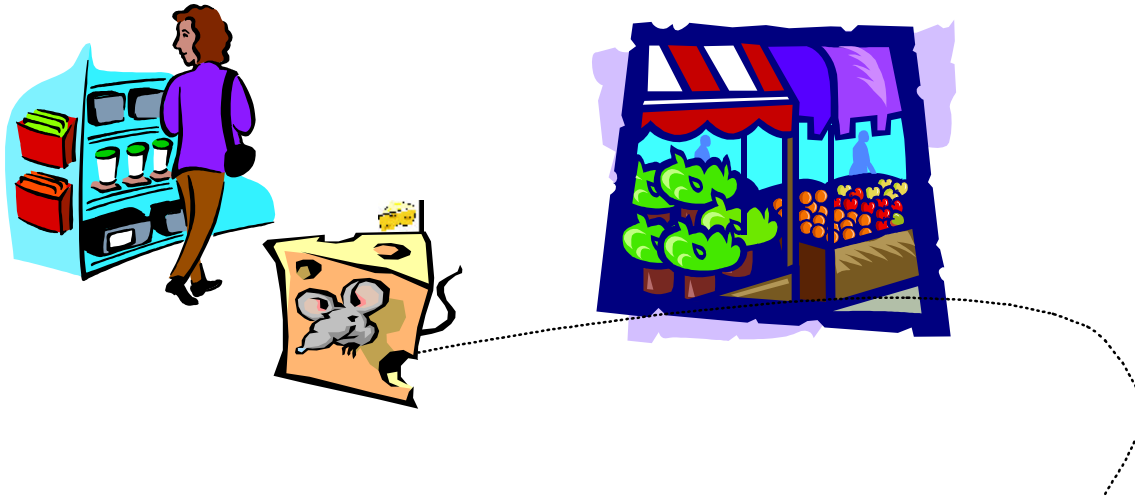

The Mouse gets the cheese



“Thanks to VMI I can be assured that my grocery store will never be without my favorite cheese”

