

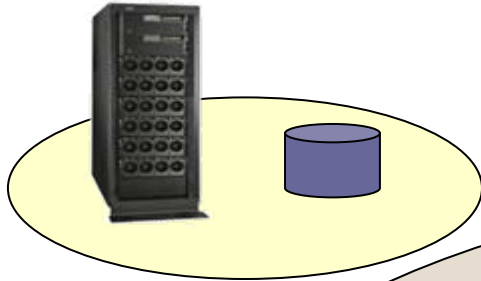

Rules Of Engagement – Capturing Your Business Expertise

Smart Work Solutions Need To Build On Existing Systems



Smart Work Solutions

1. Build on a Strong Foundation
2. Automate Business Processes
3. Capture Business Expertise
4. Connect Everything with an Intelligent Bus
5. React to Business Events in Real Time

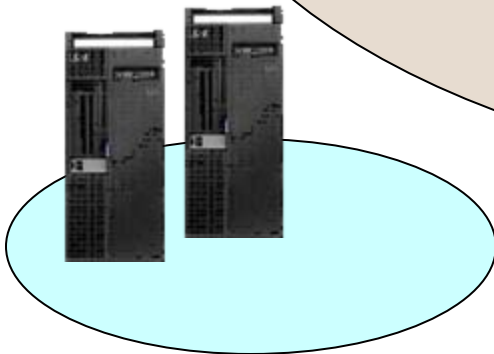

Service Oriented Finance Needs Immediate Changes

We need to make an immediate policy change!



Business Expert

With rules you can make changes quickly without re-programming or re-deploying your process.



IBM

Rules Can Be Used For Two Purposes

- **Add flexibility** by externalizing “switches” in your process
 - ▶ Simple changes to rules cause changes in process behavior
 - Examples: Threshold values, conditional parameters, and calculations
 - ▶ Rules can be changed immediately while the process is running, without re-programming or re-deploying the process
 - ▶ WebSphere Process Server provides this support
- **Capture expert knowledge** to automate what would otherwise be a manual decision
 - ▶ Typically involves the knowledge of many business experts
 - ▶ Typically requires the definition of thousands of rules
 - ▶ Approximates artificial intelligence to make automatic decisions
 - ▶ ILOG JRules provides this support

WebSphere's Service Component Architecture Enables Both Kinds Of Rules

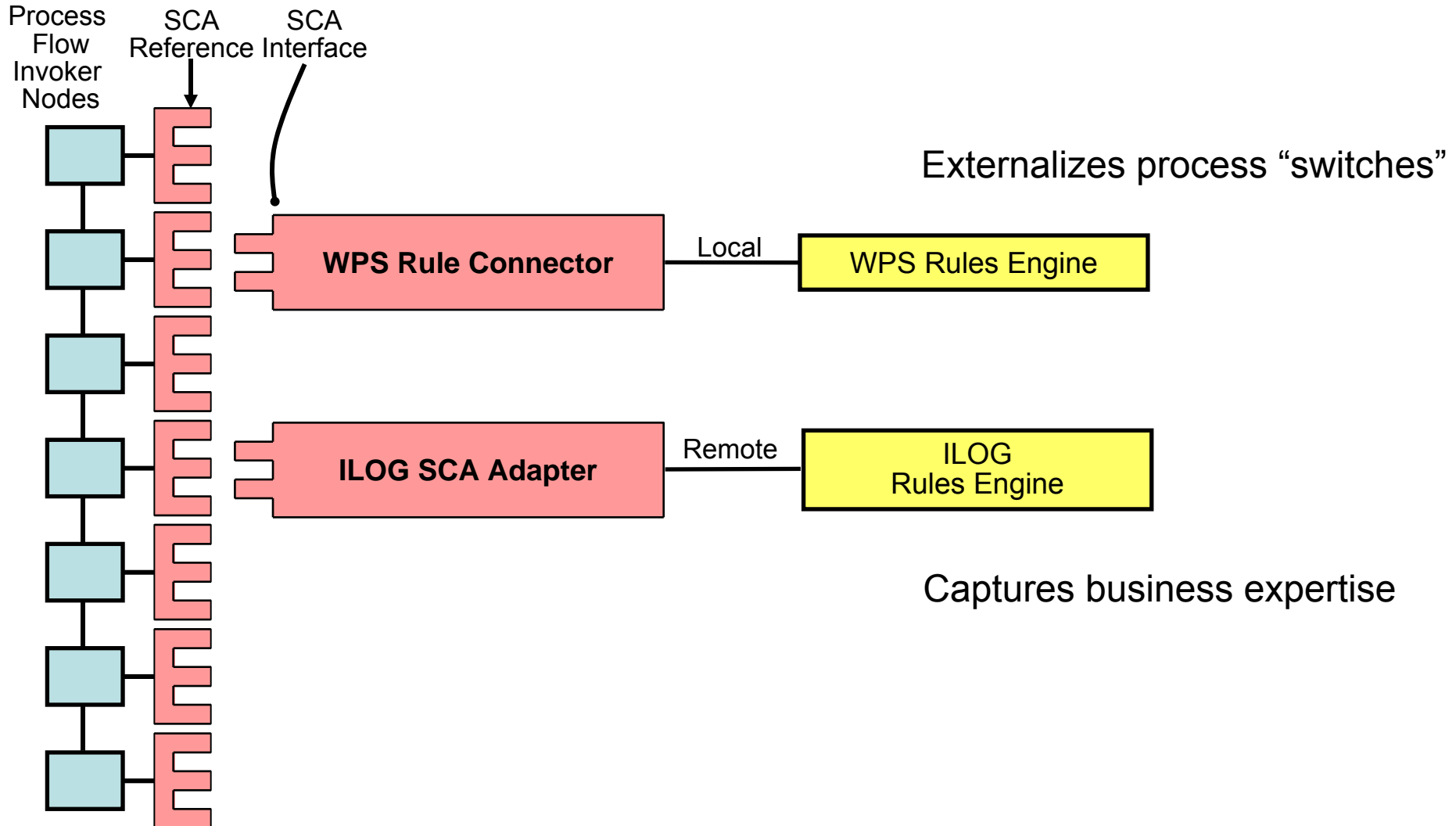

Demo: WebSphere Process Server Rules

We need the flexibility to tighten credit criteria.



Business Expert

Old Rule

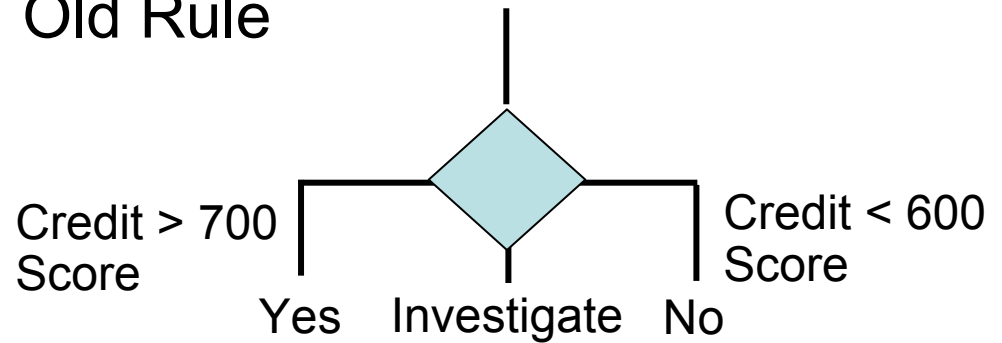

New Rule

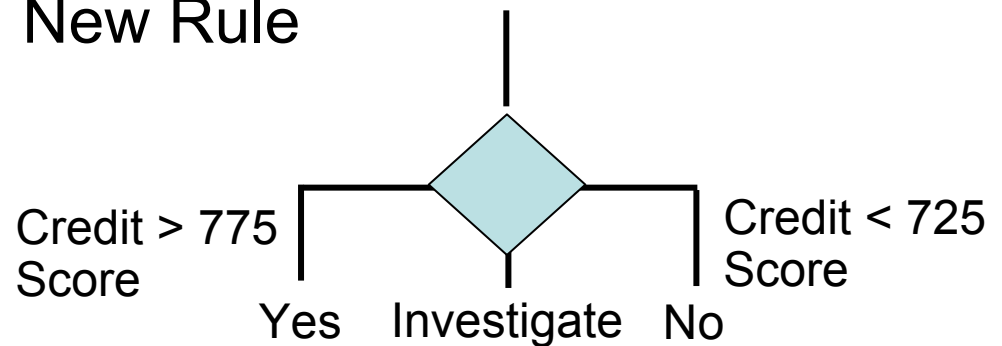

Service Oriented Finance Also Needs To Capture Business Expertise

We need to capture our business expertise in order to price life insurance policies quickly and effectively. Those simple rules are great, but they can't handle this requirement.



Business Expert

With ILOG JRules your teams of experts can create and manage thousands of rules.



IBM

Whose Expertise Do We Need To Capture?

Sub-Level Rules Teams



Higher Level Rules Teams

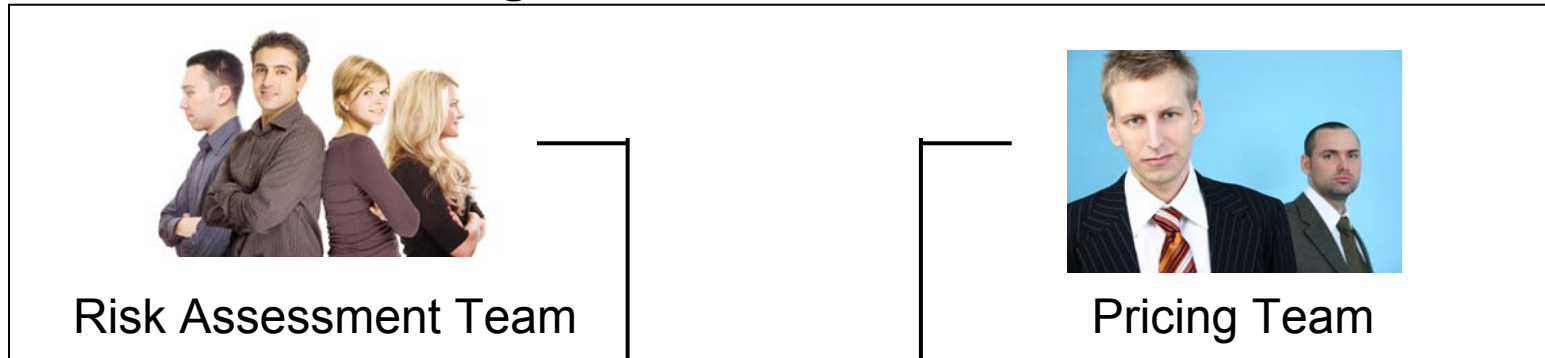

\$ Policy Price

What Rule Sets Do We Need To Calculate The Price Of A Life Insurance Policy?

- Profession
- Hobbies
- Driving record
- Geography

Lifestyle Team

- Medical history
- Family history
- Health status form
- Nurse Visit

Medical Team

- Regular checkups
- Non-smoker
- Gym membership
- Multiple policies

Discount Team

- Term amount
- Variable or flat rate
- Health rating
- Age

Policy Team

- Medical condition
- Lifestyle
- Actuarial tables
- Rate lock-in period

Risk Assessment Team

- Revenue targets
- Competition
- Market share
- Geography

Pricing Team

\$ Policy Price

Example Of The Complexity Of The Medical Team's Rules Sets

Social History *This information is kept strictly confidential. However, you may discuss this portion directly with the doctor if you prefer.*
 Yes, I would prefer to discuss my Social History information directly with my doctor. (Check box)

Do you drive? no yes If yes, do you have visual difficulty when driving? no yes If yes, please describe:

Do you use tobacco products? no yes If yes, type/amount/how long: _____

Do you drink alcohol? no yes If yes, type/amount/how long: _____

Do you use illegal drugs? no yes If yes, type/amount/how long: _____

Have you ever been exposed to or infected with: Gonorrhea Hepatitis HIV Syphilis

Review of Systems
 Do you currently, or have you ever had any problems in the following areas:

SYSTEM	NO	YES	?		NO	YES	?	
CONSTITUTIONAL					EARS, NOSE, MOUTH, THROAT			
Fever, Weight Loss/Gain	<input type="checkbox"/>	<input type="checkbox"/>	<input type="checkbox"/>		Allergies/Hay Fever	<input type="checkbox"/>	<input type="checkbox"/>	<input type="checkbox"/>
INTEGUMENTARY (Skin)	<input type="checkbox"/>	<input type="checkbox"/>	<input type="checkbox"/>		Sinus Congestion	<input type="checkbox"/>	<input type="checkbox"/>	<input type="checkbox"/>
NEUROLOGICAL					Runny Nose	<input type="checkbox"/>	<input type="checkbox"/>	<input type="checkbox"/>
Headaches	<input type="checkbox"/>	<input type="checkbox"/>	<input type="checkbox"/>		Post-Nasal Drip	<input type="checkbox"/>	<input type="checkbox"/>	<input type="checkbox"/>
Migraines	<input type="checkbox"/>	<input type="checkbox"/>	<input type="checkbox"/>		Chronic Cough	<input type="checkbox"/>	<input type="checkbox"/>	<input type="checkbox"/>
Seizures	<input type="checkbox"/>	<input type="checkbox"/>	<input type="checkbox"/>		Dry Throat/Mouth	<input type="checkbox"/>	<input type="checkbox"/>	<input type="checkbox"/>
EYES					RESPIRATORY			
Loss of Vision	<input type="checkbox"/>	<input type="checkbox"/>	<input type="checkbox"/>		Asthma	<input type="checkbox"/>	<input type="checkbox"/>	<input type="checkbox"/>
Blurred Vision	<input type="checkbox"/>	<input type="checkbox"/>	<input type="checkbox"/>		Chronic Bronchitis	<input type="checkbox"/>	<input type="checkbox"/>	<input type="checkbox"/>
Distorted Vision/Halos	<input type="checkbox"/>	<input type="checkbox"/>	<input type="checkbox"/>		Emphysema	<input type="checkbox"/>	<input type="checkbox"/>	<input type="checkbox"/>
Loss of Side Vision	<input type="checkbox"/>	<input type="checkbox"/>	<input type="checkbox"/>		VASCULAR / CARDIOVASCULAR			
Double Vision	<input type="checkbox"/>	<input type="checkbox"/>	<input type="checkbox"/>		Diabetes	<input type="checkbox"/>	<input type="checkbox"/>	<input type="checkbox"/>
Dryness	<input type="checkbox"/>	<input type="checkbox"/>	<input type="checkbox"/>		Heart Pain	<input type="checkbox"/>	<input type="checkbox"/>	<input type="checkbox"/>
Mucous Discharge	<input type="checkbox"/>	<input type="checkbox"/>	<input type="checkbox"/>		High Blood Pressure	<input type="checkbox"/>	<input type="checkbox"/>	<input type="checkbox"/>
Redness	<input type="checkbox"/>	<input type="checkbox"/>	<input type="checkbox"/>		Vascular Disease	<input type="checkbox"/>	<input type="checkbox"/>	<input type="checkbox"/>
Sandy or Gritty Feeling	<input type="checkbox"/>	<input type="checkbox"/>	<input type="checkbox"/>		GASTROINTESTINAL			
Itching	<input type="checkbox"/>	<input type="checkbox"/>	<input type="checkbox"/>		Diarrhea	<input type="checkbox"/>	<input type="checkbox"/>	<input type="checkbox"/>
Burning	<input type="checkbox"/>	<input type="checkbox"/>	<input type="checkbox"/>		Constipation	<input type="checkbox"/>	<input type="checkbox"/>	<input type="checkbox"/>
Foreign Body Sensation	<input type="checkbox"/>	<input type="checkbox"/>	<input type="checkbox"/>		GENITOURINARY			
Excess Tearing/Watering	<input type="checkbox"/>	<input type="checkbox"/>	<input type="checkbox"/>		Genitals/Kidney/Bladder	<input type="checkbox"/>	<input type="checkbox"/>	<input type="checkbox"/>
Glare/Light Sensitivity	<input type="checkbox"/>	<input type="checkbox"/>	<input type="checkbox"/>		BONES / JOINTS / MUSCLES			
Eye Pain or Soreness	<input type="checkbox"/>	<input type="checkbox"/>	<input type="checkbox"/>		Rheumatoid Arthritis	<input type="checkbox"/>	<input type="checkbox"/>	<input type="checkbox"/>
Chronic Infection of Eye or Lid	<input type="checkbox"/>	<input type="checkbox"/>	<input type="checkbox"/>		Muscle Pain	<input type="checkbox"/>	<input type="checkbox"/>	<input type="checkbox"/>
Sties or Chalazion	<input type="checkbox"/>	<input type="checkbox"/>	<input type="checkbox"/>		Joint Pain	<input type="checkbox"/>	<input type="checkbox"/>	<input type="checkbox"/>
Flashes/Floaters in Vision	<input type="checkbox"/>	<input type="checkbox"/>	<input type="checkbox"/>		LYMPHATIC / HEMATOLOGIC			
Tired Eyes	<input type="checkbox"/>	<input type="checkbox"/>	<input type="checkbox"/>		Anemia	<input type="checkbox"/>	<input type="checkbox"/>	<input type="checkbox"/>
ENDOCRINE					Bleeding Problems	<input type="checkbox"/>	<input type="checkbox"/>	<input type="checkbox"/>
Thyroid/Other Glands	<input type="checkbox"/>	<input type="checkbox"/>	<input type="checkbox"/>		ALLERGIC / IMMUNOLOGIC			
					PSYCHIATRIC			

If you answered YES to any of the above or have a condition not listed, please explain & list medications:

 Doctor's Signature

 Date

Rev. 0205 © 2005 PEN Publications 1-800-444-9230

1. Over 350 medical conditions to track
2. Invoke rules for certain combinations of conditions
3. Invoke rules for medical patterns
4. Statistically track all the latest mortality data for certain medical conditions
5. Daily updates with new medical statistics

Demo: ILOG JRules Orchestrates Rule Dependencies

- Each team has a rule project
- ILOG JRules orchestrates rule dependencies across projects and teams
- The orchestration specifies the order in which rule sets are evaluated

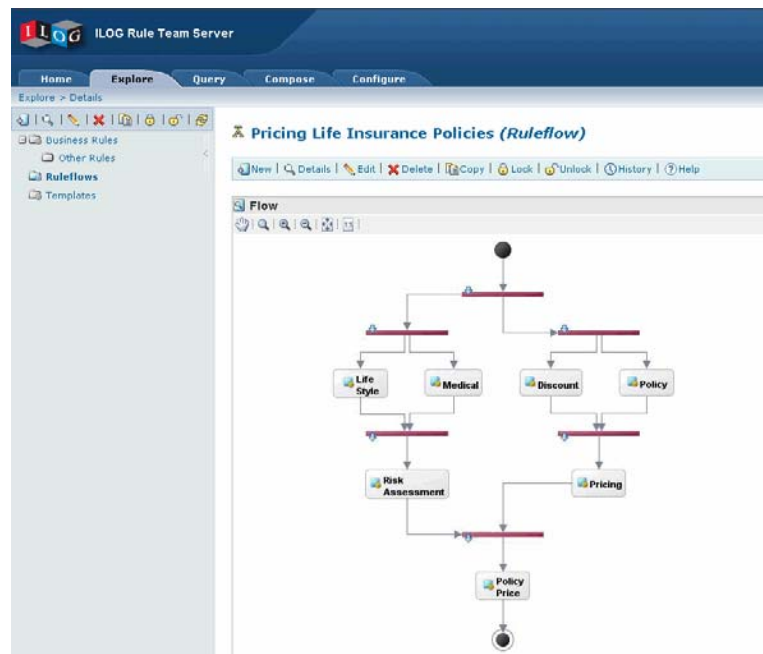

ILOG Captures Expertise As Business Rules For Re-Use In Business Processes

We need to calculate rates for term life insurance, considering multiple factors.

Medical Rule

Pricing Rule



Business Processes invoke business rules

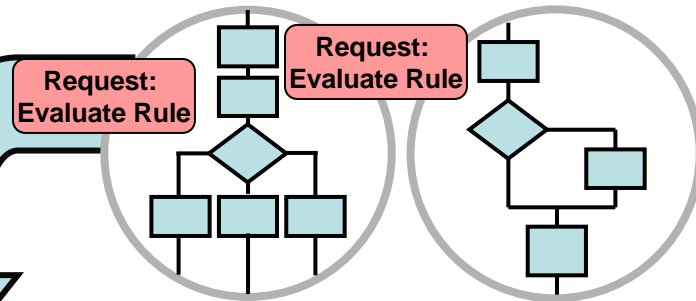

Experts create business rules and save them in the Rules Repository

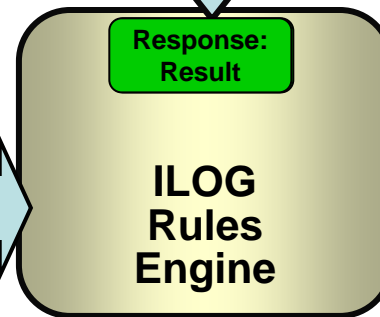
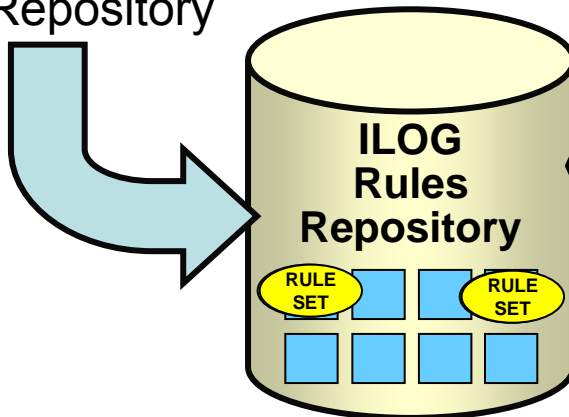

A business process invokes a rule set as a reusable service and the Rules Engine sends the result to the process.

ILOG Repository captures business rules in rule sets

ILOG JRules Is A Business Rules Management System

■ Lifecycle management

- ▶ Create, modify, test, and deploy rules
- ▶ Searching, action, and reporting

■ Governance

- ▶ Project access and permission control
- ▶ Versioning, baseline, and history comparison
- ▶ Quality assurance analysis

Oracle, Microsoft, and JBoss can't do this!

ILOG JRules Allows The Team To Create, Modify, Test, And Deploy Business Rules

I'll set up the environment and define your rule interfaces



Developer

All I have to do is capture my expertise in a business rule!



Business Expert

I'll test your rules to ensure that they do what you say they should



Rule Tester

I'll make sure that your rules don't conflict with others, then deploy them



Administrator

Demo: Creating A Business Rule With ILOG

- ILOG JRules uses a natural language approach, so a developer is not necessary to create a rule

The screenshot displays the ILOG Rule Team Server interface. The main window shows a rule titled "young and healthy at New Branch (Action Rule)". The rule's content is displayed in a text area, showing a natural language-style condition and action:

```
if
  the location name of 'the application' contains "New Branch"
  and the age of the customer of 'the application' is at most 45
  and the medical history of 'the application' is "Normal"
then
  set the min yearly payment of 'the decision' to 500 ;
```

Below the content area, there is a "Properties" tab with the following details:

Property	Value
Name	young and healthy at New Branch
Status	New
Priority	
Locale	English (United States)
Categories	
Template	
Expiration Date	None
Effective Date	None
Active	True
Folder	New Branch
Group	
Created By	rtsAdmin
Last Changed By	rtsConfig
Last Changed On	Jul 6, 2009 12:28:14 PM EDT
Created On	Jun 23, 2009 7:16:34 PM EDT
Type	Action Rule

ILOG JRules Makes It Easy To Search, Act, And Report On Large Rule Sets

- Based on their role and permissions, team members can work with rules throughout their lifecycle:
 - ▶ Create custom queries to easily find rules among thousands in the repository
 - ▶ Create, copy, edit, delete, or move rules using a browser-based user interface
 - ▶ Generate reports on rules that allow business experts and architects see at a glance rule logic, interfaces, and projects

What Is The Importance Of Rule Governance?

- Project access and permission control
 - ▶ Teams have access only to their projects
 - ▶ Only specified roles can change rules
- Versioning, baseline, and history comparison
 - ▶ Experts can create versions of rules
 - ▶ Experts control which versions are in force
- Quality Assurance analysis
 - ▶ Ensure that rules created by different teams do not conflict with each other

Governance Allows Teams To Function Smoothly

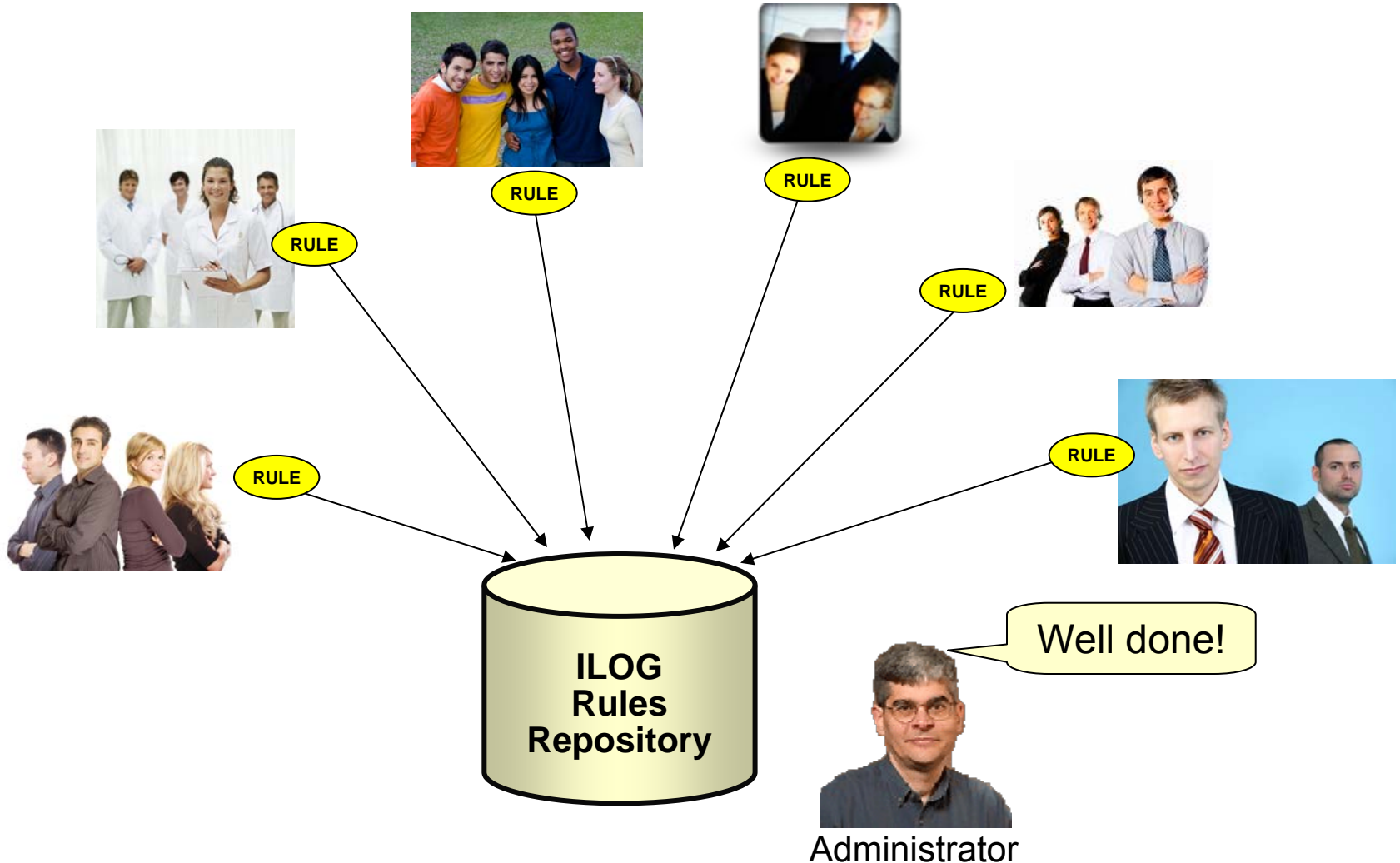

Demo: ILOG JRules Provides Role Separation And Checks To Ensure Rule Quality

- Teams create pricing rules in a single repository
- The administrator runs a quality assurance check to detect the conflict
- The administrator generates a rule report to show the teams where the conflict lies

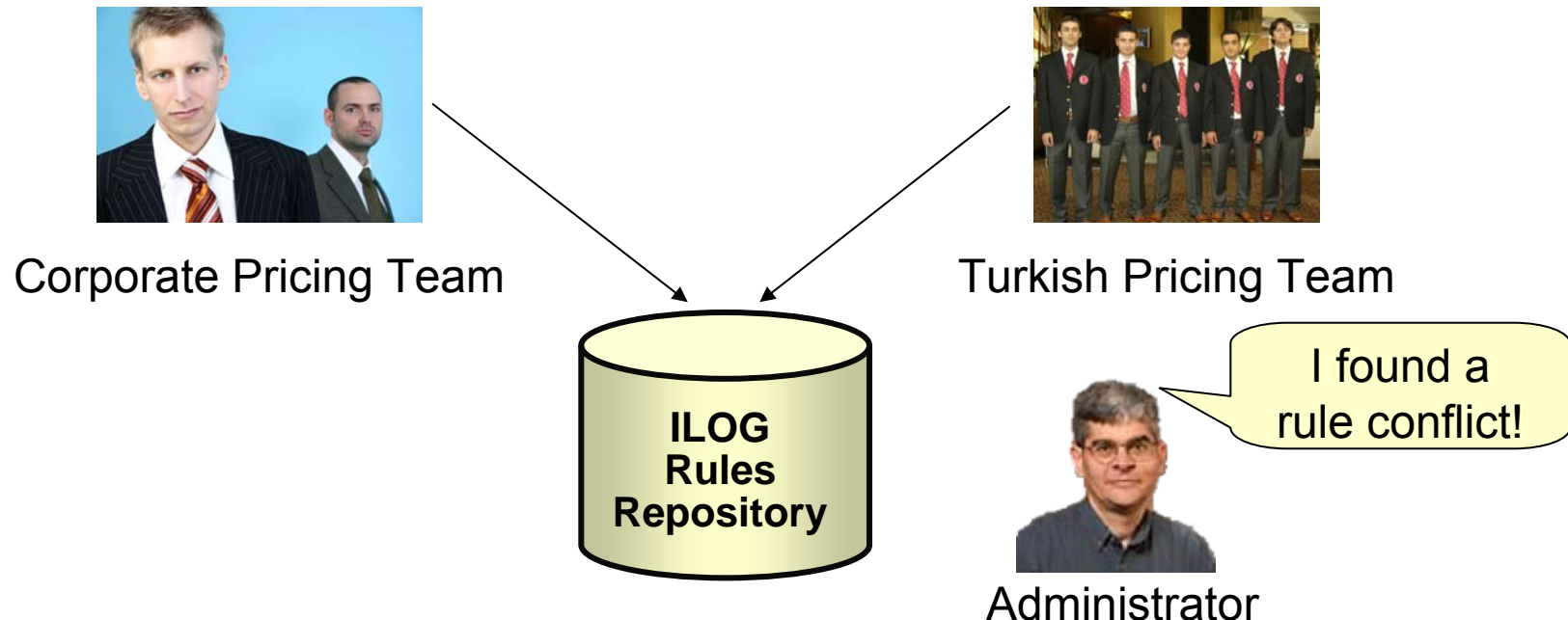



Travelers Insurance Captured Business Expertise With ILOG JRules

The Challenge

- 83% of processes for small commercial policies required intervention by agents to evaluate data and make decisions
- Long processing times due to manual intervention caused partners to request fewer quotes

With ILOG JRules

- Fewer policies need agent intervention because rules allow process decision steps to be automated
- Number of quotes per agent increased 26% due to automated processes
- Currently have 40,000 rules, and are planning to handle 200,000 rules
- Currently averaging 3,000 new / changed rules per month

Summary

- Business rules capture business expertise to automate business process steps
 - ▶ Make the business as strong as your smartest experts
- ILOG JRules can manage thousands of rules developed by teams of business experts
- Business rules can add flexibility by allowing business values to change at runtime, without re-developing and re-deploying the processes in which they are used
- WebSphere Process Server's built-in capability allows developers to create rules that become reusable service components