

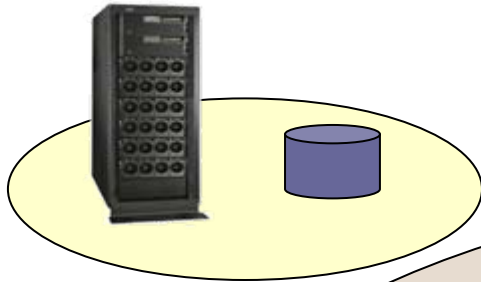

Improving Your Business With Flexible Business Processes

Smart Work Solutions Need To Build On Existing Systems



Smart Work Solutions

- 
1. Build on a Strong Foundation
 2. Automate Business Processes
 3. Capture Business Expertise
 4. Connect Everything with an Intelligent Bus
 5. React to Business Events in Real Time

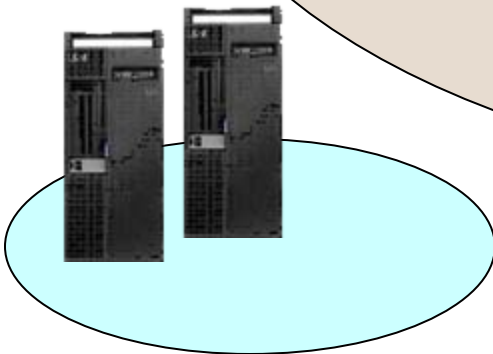

WebSphere Business Processes Are Flexible

Our revenue is down!
My budget was cut. I
need to improve the
efficiency of my loan
application process.



VP Mortgage

WebSphere business processes
are flexible! Let me show you
how quickly you can make
changes to improve your
process.



IBM

Service Oriented Finance Current Manual Home Loan Process

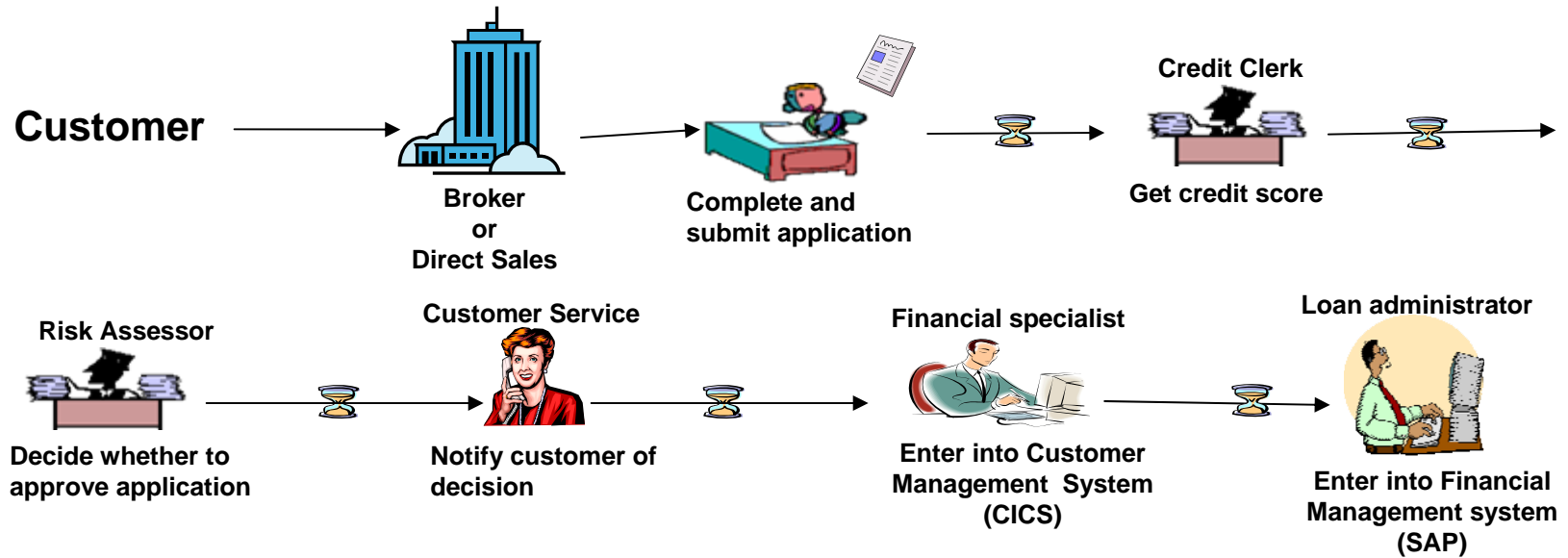

Current Manual process isn't ready for increased business:

- Hard to change or adapt because the process depends on undocumented human practices
- Manual data entry results in errors
- Multiple manual steps makes it difficult to determine status
 - ▶ Don't know where an individual request is
 - ▶ Don't know how smoothly system is working

Business Models Leverage Business Expert Knowledge

- Proposed changes can be simulated and verified ahead of time
- The model captures the business expert's knowledge of the business – the activities that are involved, who performs them, and how much time and money they cost

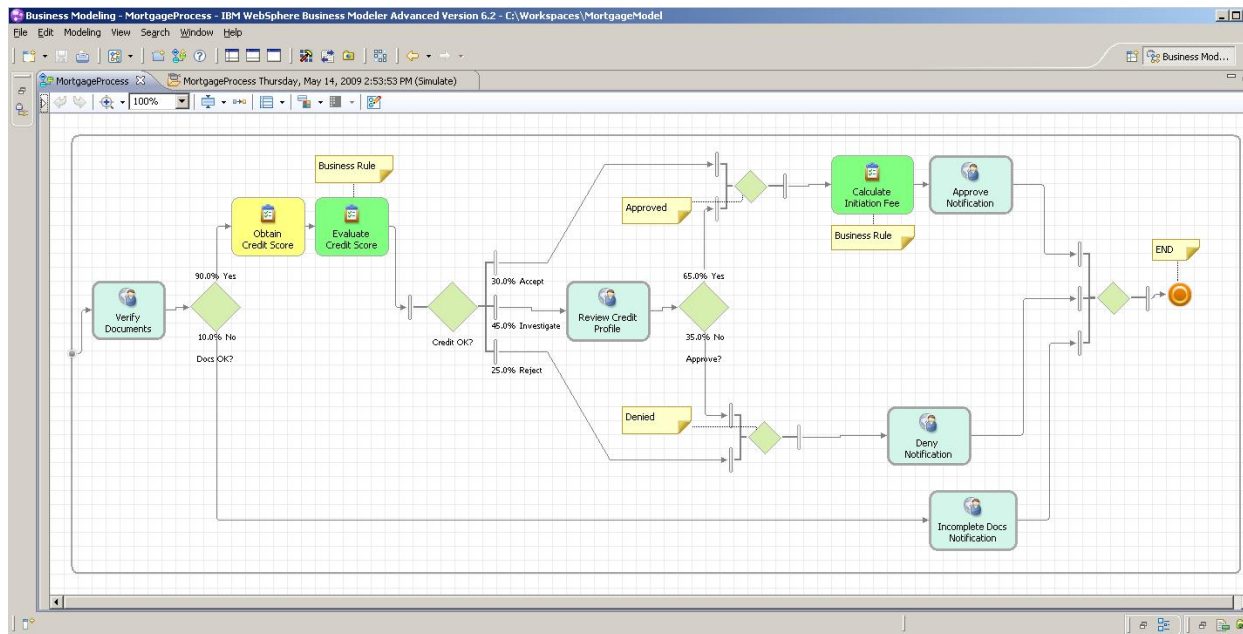

Demo: Proposed Changes Can Be Modeled And Simulated To Ensure Effectiveness

- Objective: Reduce average cost to process each loan application to less than \$10 and reduce average processing time to less than 5 hours
- Proposed change: Replace human activities with automated web services
- Will the proposed change meet the objectives?

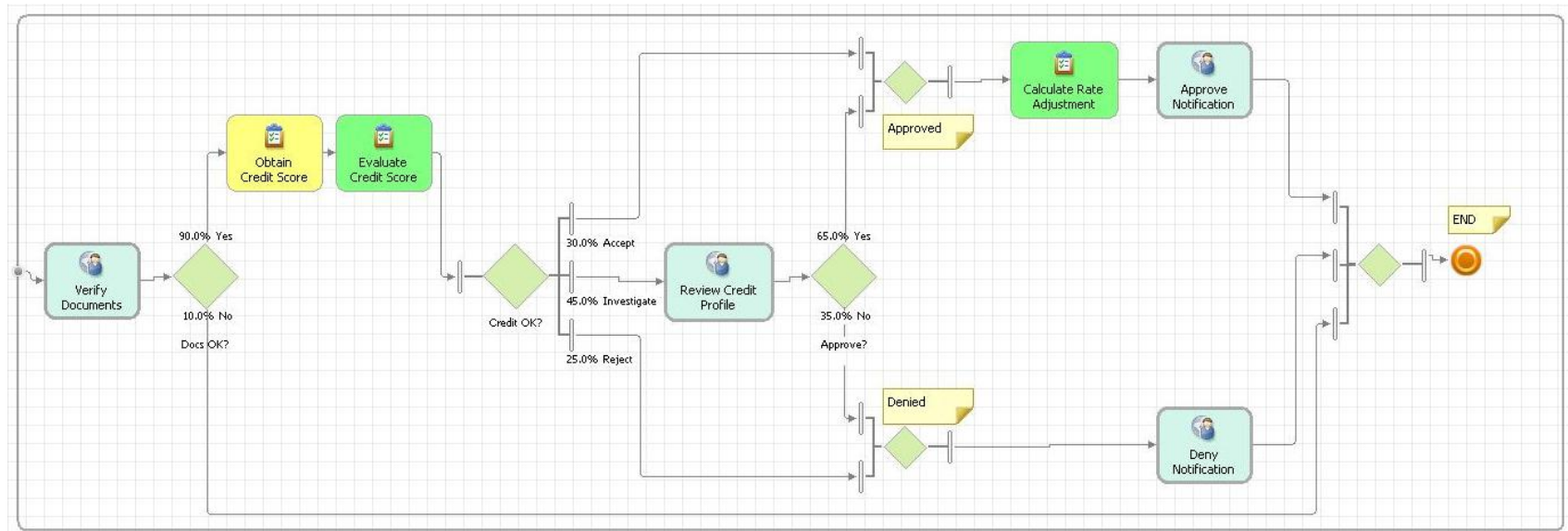

Microsoft Can't Do This

- Microsoft Visio
 - ▶ No resource modeling
 - ▶ No human tasks or roles
 - ▶ No business process simulation
 - ▶ WebSphere Business Modeler imports Visio diagram

- Oracle has two “strategic” BPM products and two modeling methods
 - ▶ Oracle BPEL Process Manager
 - ▶ Third party modeler (Oracle BPA is IDS Scheer's ARIS)
 - ▶ Oracle BPM
 - ▶ Business expert must use developer's tool

Implementing The Changes

- Developers use WebSphere Integration Developer (WID) tool to make the changes
- The WID tool supports a Service Component Architecture (SCA) philosophy
 - ▶ Developers quickly assemble existing SCA components
 - Wiring
 - Data maps
 - ▶ WID tool automatically generates some service components
 - Example: Human tasks
 - ▶ The tool supports development of new service components as well
- Benefits
 - ▶ Easy to make changes

Service Component Architecture

Change a service without changing the process design

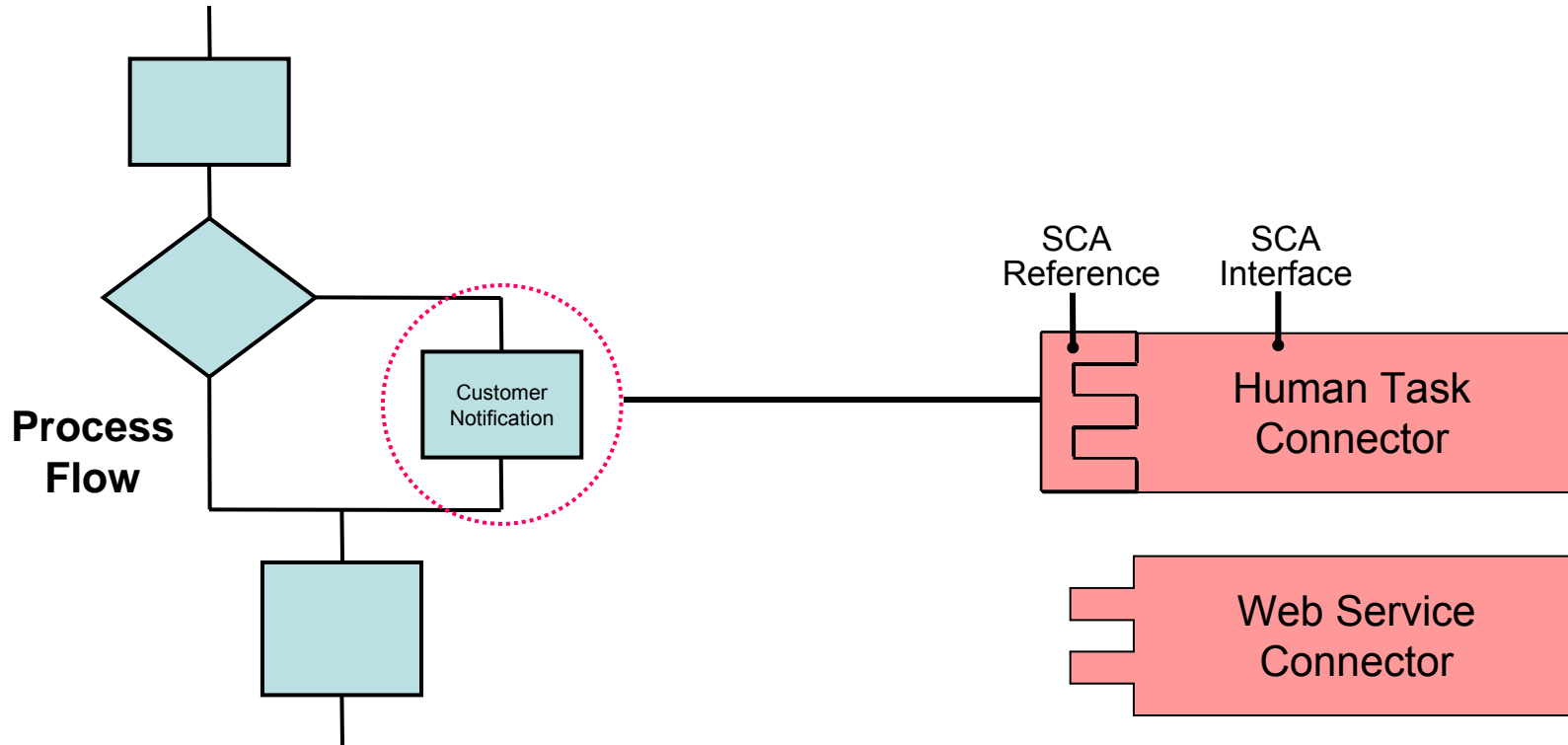

1. Wire new service to existing process step
2. Re-deploy the process

Service Wiring Includes Maps In Order To Handle Differing Data Formats

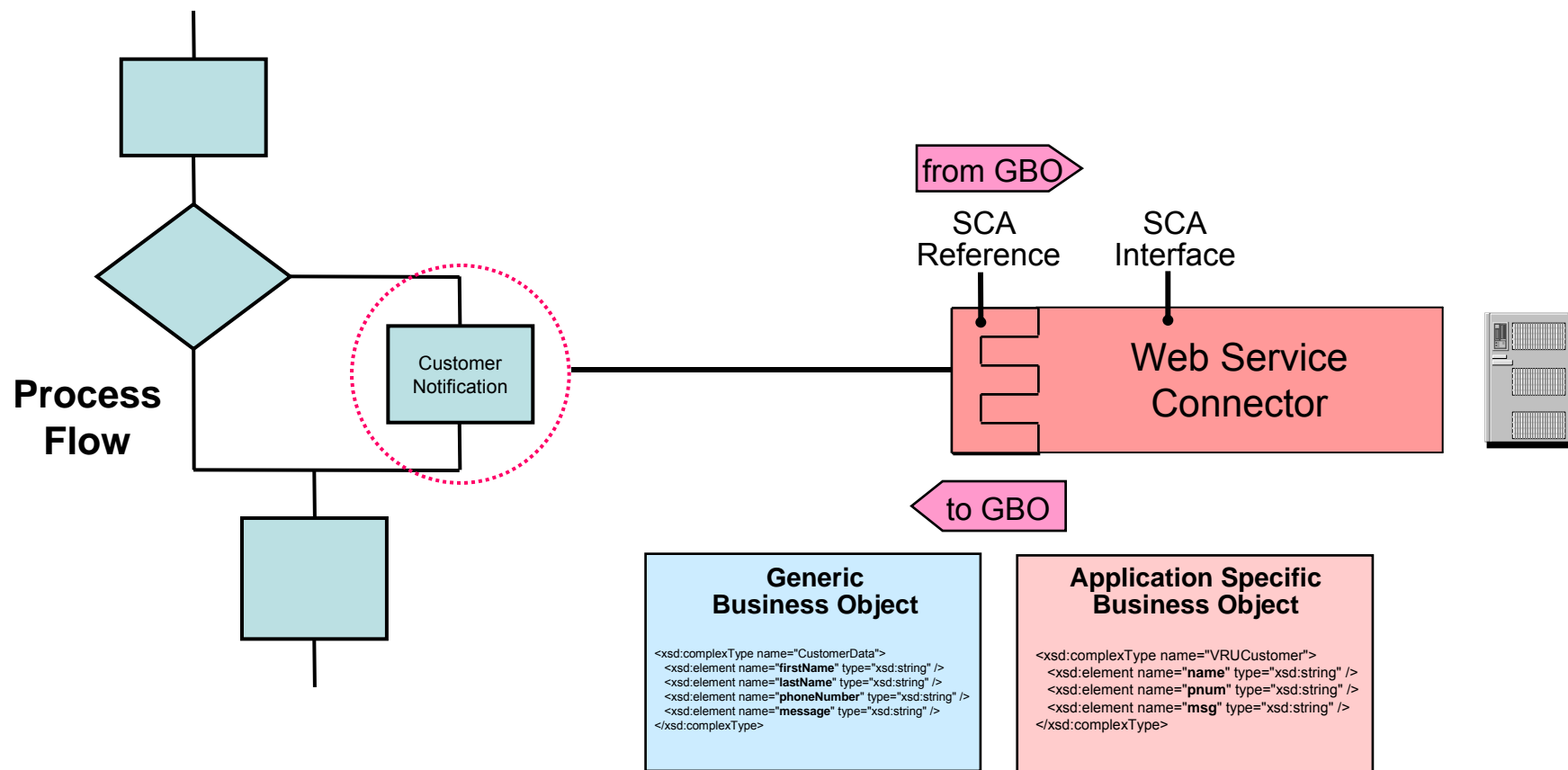

- The Loan Application process uses an application-neutral **Generic Business Object** (GBO) schema to represent its data structure
- Each service has its own **Application Specific Business Objects** (ASBO)
- The web service component uses **maps** to transform data between the two formats (GBO and ASBO)

Demo: Change A Service Without Changing The Process Design

Automate the “Customer Notification” task by replacing the human task with a web service

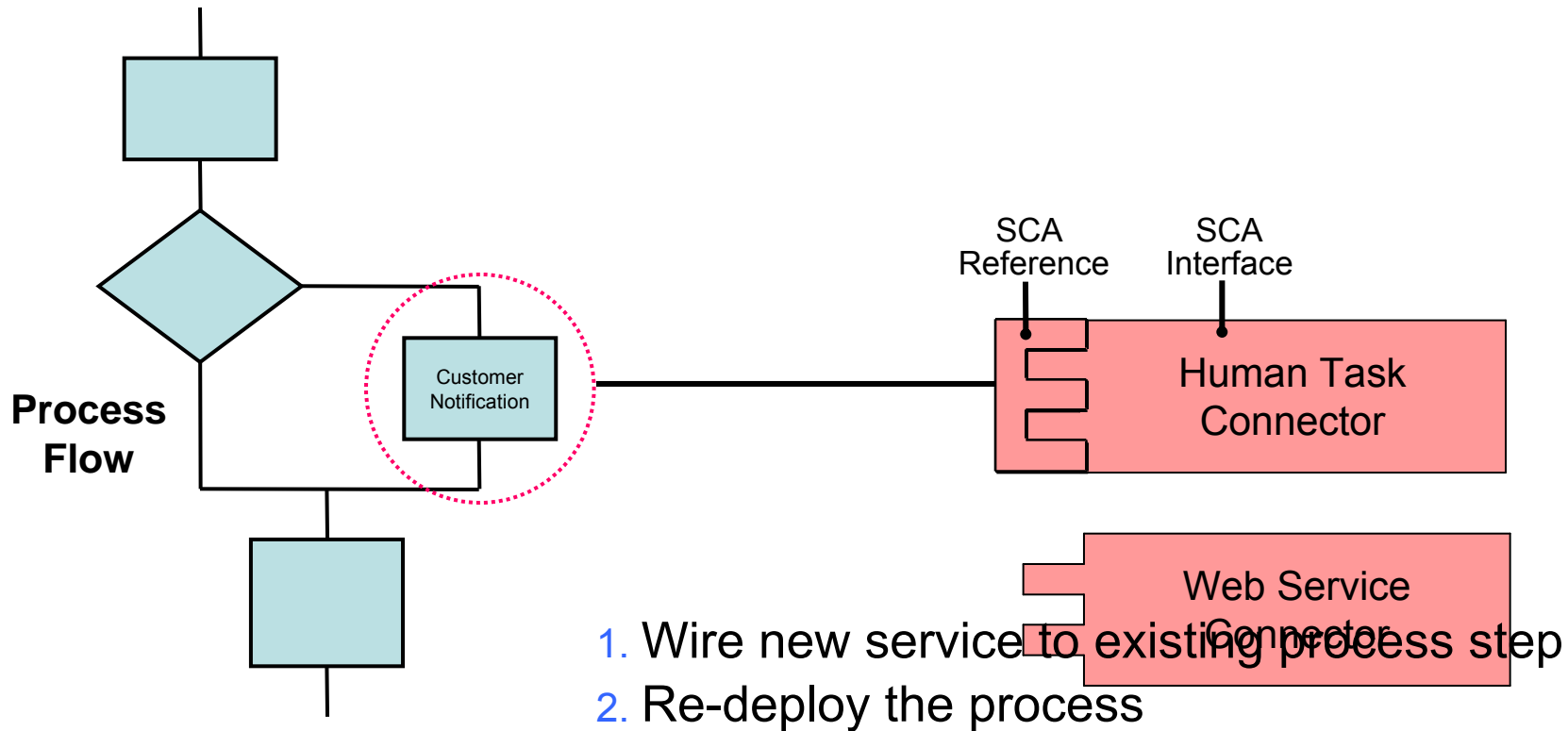
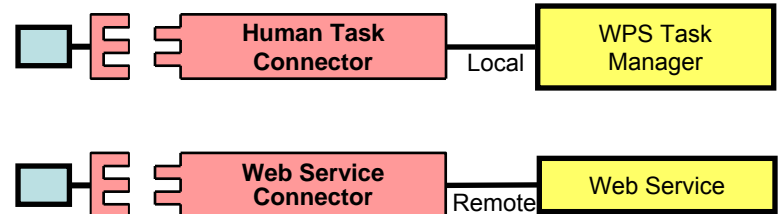

Microsoft BizTalk Is Less Flexible

- BizTalk has no support for Service Component Architecture (SCA)
 - ▶ Calls to different types of endpoints are done differently. Web services, adapters, business rules, and CICS are not accessed in the same way
- No separation between process design and service wiring
 - ▶ Business logic is intermingled with service implementation details
- No generalized data representation
 - ▶ Data structures of the endpoints are embedded in the business logic of the calling application
- Result: changes to service implementation details are hard to make and require changes to the process logic

Demo: It's More Difficult To Change A BizTalk Process

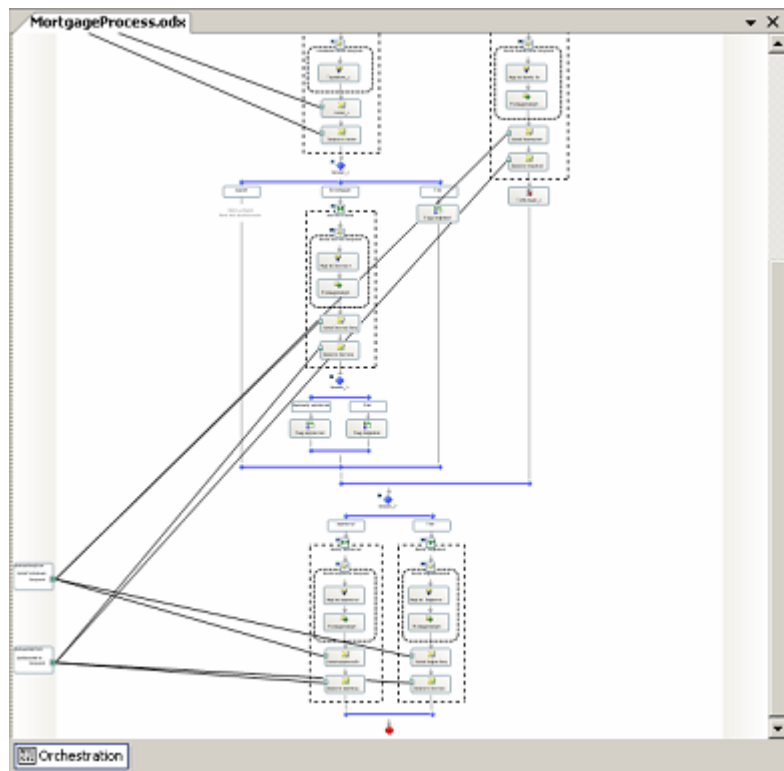

- Changing an endpoint from a human step to a web service requires changes to the process logic
- Change must be repeated for each use of the service
- Process logic is cluttered with implementation details, so the changes cause cascading problems
- No automatic detection of interface discrepancies – developer must handle manually

Oracle Is Less Flexible

- Oracle has two “strategic” BPM products and two developer tools
 - ▶ Oracle BPEL Process Manager
 - July 1 announced SCA support in 11g release
 - 10g required services to be wired within the process

 - ▶ Oracle BPM
 - Does not support SCA
 - Uses proprietary business objects
 - Could use generic business objects, but mapping to application-specific objects is done programmatically (using a proprietary 4GL)
 - Can change a service’s URL, but any other change requires changing the invocation logic

A Benefit Of IBM's Flexible Development – Faster Time To Solution

Total Build, Test and Deploy Time (hh:mm)

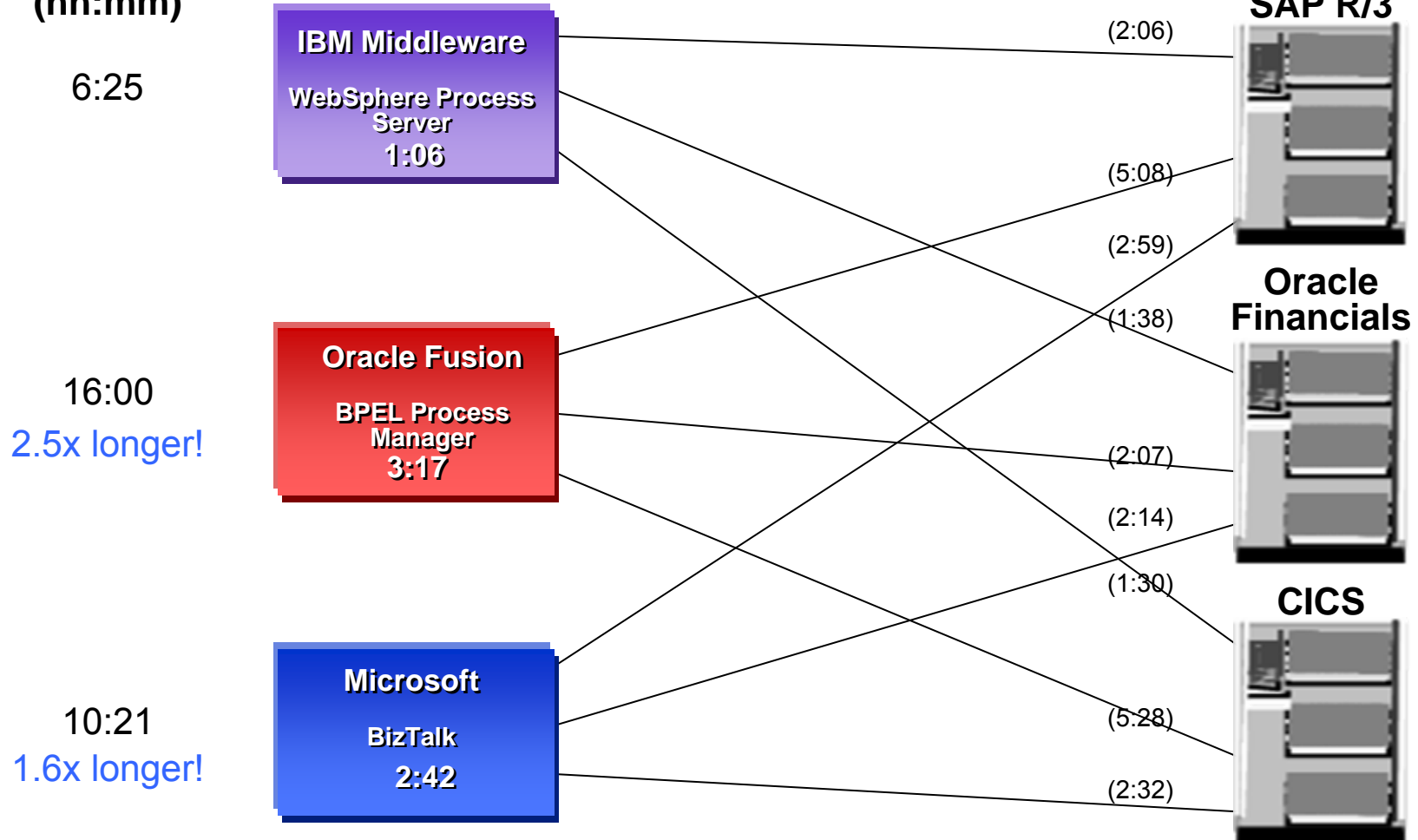

Source: Internal IBM Productivity Comparison Study

WebSphere Process Server Is The Runtime For The New Process

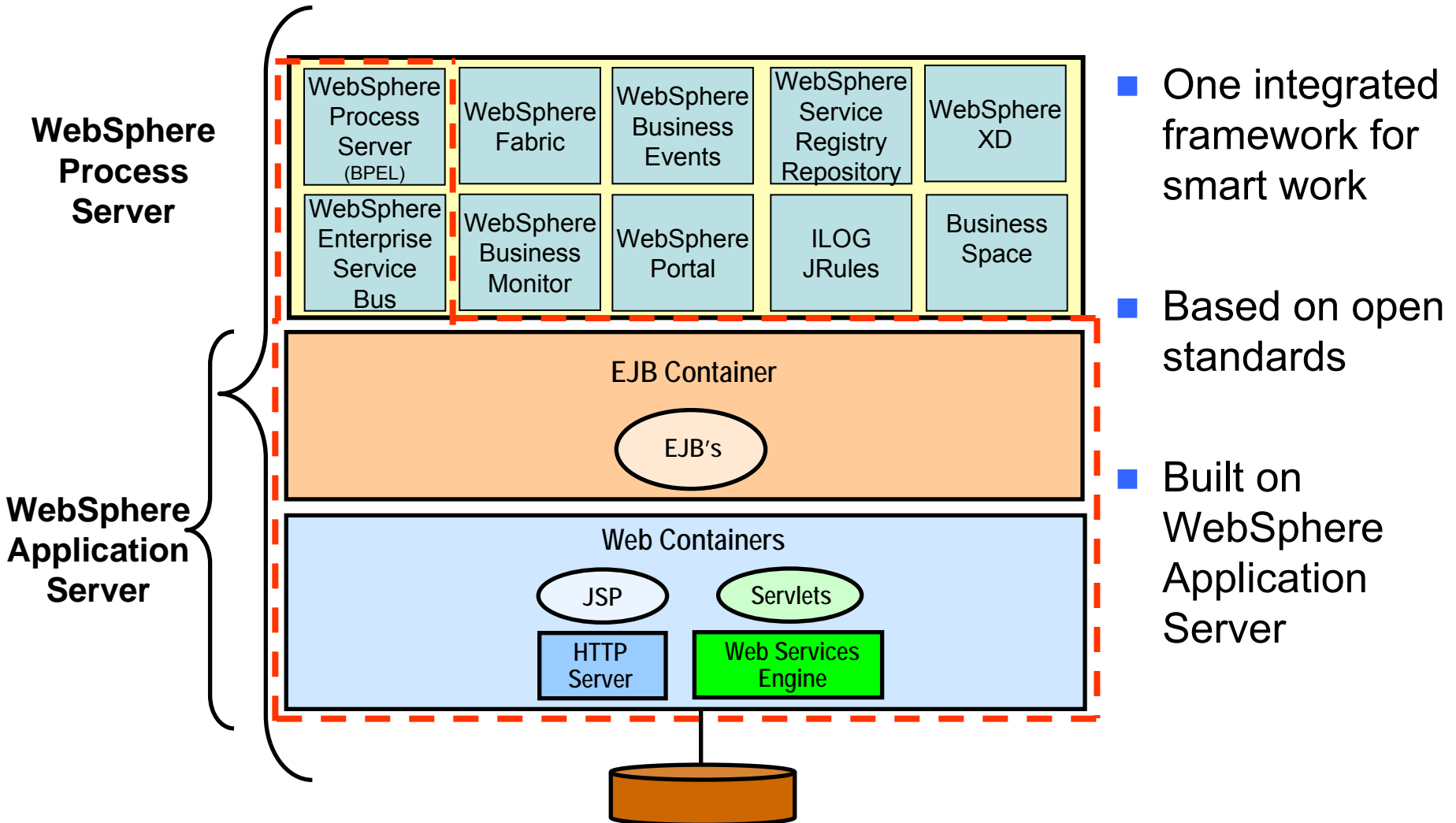

WebSphere Process Server Accommodates A Changing Workforce

- Process tasks are associated with roles, not individuals
- Easily add employees and assign to roles
- Employees use their work list to claim outstanding task for completion
- Managers can re-assign tasks based on workload and staff availability
- Federate repositories to simplify the management of users and roles

Deploy A Common Process To Different Locales

That's great!
We want to use
this process worldwide,
but we need to adapt it
to the requirements in
each country.



Service Oriented Finance
CIO

You can maintain a common
process by dynamically
selecting the services you need



IBM

Service Oriented Finance Has A Challenge Deploying This Process To Different Locations

- Service Oriented Finance needs a different version of a process step to conduct business in each country
- Without a better solution, they will need to customize the entire process for each variation, adding to the development effort and making changes difficult and costly

Process step needs to be adapted to the requirements of each location

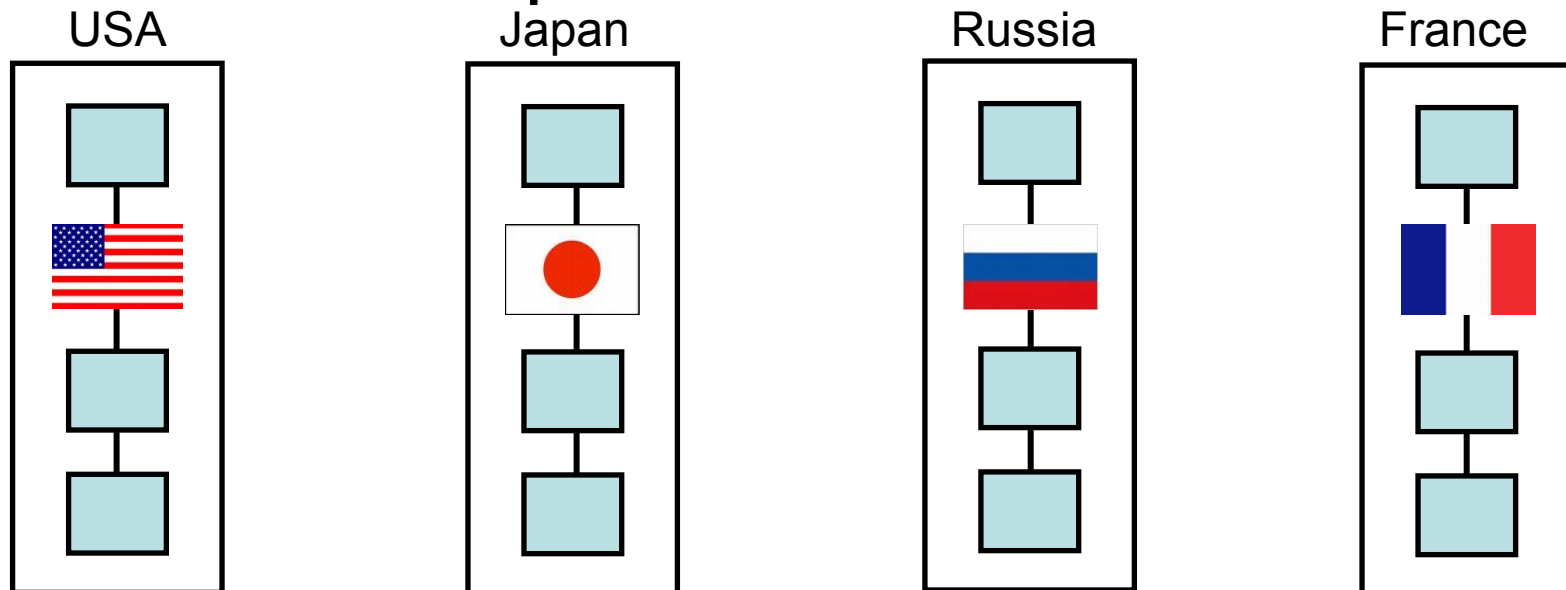

Service Component Architecture And WebSphere Business Services Fabric Can Do This

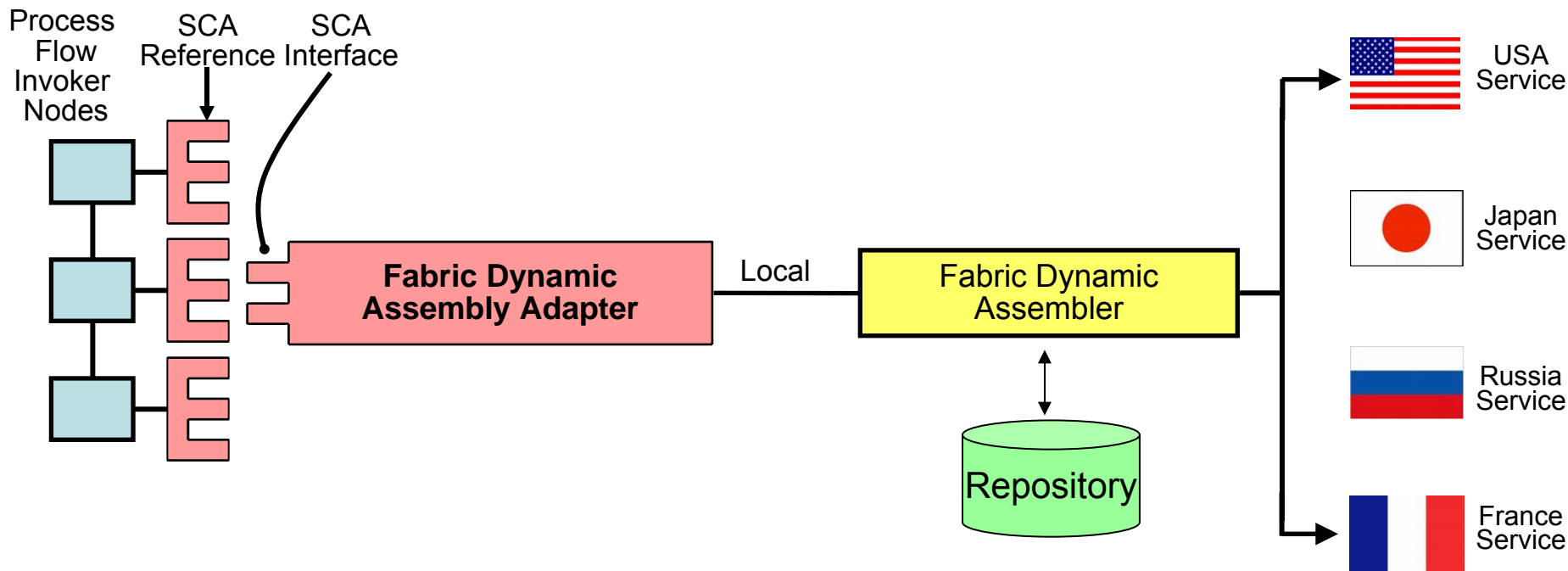

- Fabric Dynamic Assembler makes a decision at runtime about which service to invoke
- Invoked service can be country specific
- Fabric repository maintains lists of possible endpoints
- Policies determine selection of endpoint
- Endpoints and policies can be changed while the processes are running

Demo: Service Oriented Finance Wants To Accept Loan Applications From Customers In Turkey

- One step in the loan application process requires filing the mortgage with the local regulatory agencies
 - ▶ Turkish filing is implemented as a web service
- Loan application processes are operating in the regional headquarters in another country
- Add an endpoint for the Turkish web service and specify the conditions of when to invoke it
- Changes to Fabric can be deployed while the regional processes continue to run

Neither Microsoft Nor Oracle Can Easily Adapt Common Processes To Locales

- Microsoft and Oracle have no dynamic selection of service endpoints
- In BizTalk, developer must write low-level code to specify an endpoint programmatically
- In Oracle, developer must hard-code endpoints into process, organizing them by preference where endpoint selection criteria overlap
- Addition of endpoints or change in selection criteria results in the developer's changing/testing/re-deploying all of the affected processes

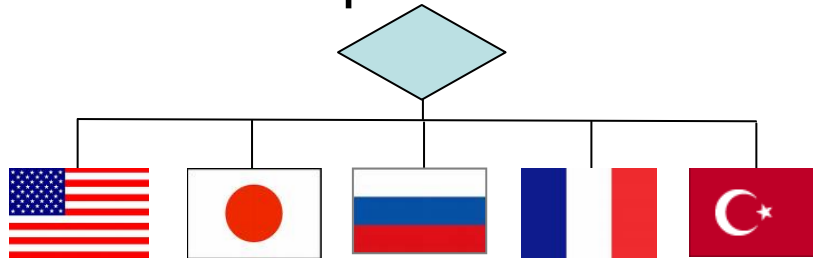

WebSphere Fabric simplifies process creation, deployment, and administration

Business Space Can Also Adapt Employee Dashboards

- **Business Space** provides one web entry point for all employees involved in the process
- Views built with mashup technology allow fast and easy customization for specific roles
- Widgets access runtime environment via REST



Risk Analyst



Project Manager



Business Expert



Process Owner



IT Developer

What Roles Can Be Supported By Business Space?

- Task specific roles
 - ▶ Examples: Risk Assessor, Call Center Representative
- Process Administration
 - ▶ Examples: Enroll employees, re-assign tasks, monitor instances
- Business Process Owner
 - ▶ Examples: Monitor business metrics, receive and investigate alerts, change business rules
- Shared widgets support collaboration amongst the team and deliver supplemental information
- Easy to customize a dashboard for each role

Business Space Is A More Flexible User Interface Framework

- Business Space enables quick and easy creation of role specific user interfaces
 - ▶ Leverage the productivity of Web 2.0 technology
- More flexible than Microsoft BizTalk
 - ▶ Developers must write code to create customized user interfaces
 - ▶ No interfaces to the runtime environment are exposed
 - ▶ Difficult to incorporate collaborative support and supplemental information
- Oracle has two “strategic” BPM products and two user interface technologies
 - ▶ Oracle BPEL Process Manager
 - Requires an additional product (WebCenter)
 - ▶ Oracle BPM
 - No custom, feed, Google Gadget, URL or MS document widgets
 - No REST programming interfaces

Demo: Create A Customized Dashboard For The Risk Analyst

- Use Business Space to create the customized dashboard (mashup)
- Task list
- Customer credit score history



Compliance Officer



Risk Analyst



Summary: Flexible WebSphere Business Processes Reduce Time, Cost, And Risk

- Model and simulate proposed process changes
- Quickly and easily implement process changes
- Adapt common process to different locales
- Quickly deliver customized employee dashboards