



IBM Software Group | IBM SOA Technology Summit

# IBM® WebSphere® Portal: Platform for delivering the front- end of SOA

SOA Summit,  
Paris, June 13<sup>th</sup> 2006

Joel Demay – Pan EMEA Tech Sales  
email:joel.demay@fr.ibm.com



“So you want to increase efficiency and boost productivity. And you want to do it fast. Then you want...”

WebSphere. Portal Version 6.0

**ON** DEMAND BUSINESS™

# Legal Notice

**The information contained in this presentation is provided for information purposes only. While efforts were made to verify the completeness and accuracy of the information contained in this presentation, it is provided “as is” without warranty of any kind, express or implied. In addition, this information is based on IBM’s current product plans and strategy, which are subject to change by IBM without notice. IBM shall not be responsible for any damages arising out of the use of, or otherwise related to, this presentation or any other documentation. Nothing contained in this presentation is intended to, nor shall have the effect of, creating any warranties or representations from IBM (or its suppliers or licensors), or altering the terms and conditions of the applicable license agreement governing the use of IBM software.**

## Trademarks

The following terms are trademarks of the International Business Machines Corporation in the United States, other countries, or both:

WebSphere®, Workplace™, Workplace Client Technology™, Workplace Collaborative Learning™, Workplace Forms™, Workplace Managed Client™, Workplace Messaging®, Workplace Shell®, Workplace Team Collaboration™, Workplace Web Content Management™, Eserver® ibm.com® Domino® Dynamic Workplaces™ DB2® IBM® Lotus Notes® Lotus® Notes® SecureWay® Tivoli®

Microsoft, Windows, Windows NT, and the Windows logo are trademarks of Microsoft Corporation in the United States, other countries, or both.

Java and all Java-based trademarks and logos are trademarks or registered trademarks of Sun Microsystems, Inc. in the United States, other countries, or both.

Other company, product, and service names may be trademarks or service marks of others.

# Portals are being deployed today to achieve business goals

## Portal Principle

- Combines portlets (application user interfaces and/or content) together into one unified presentation
- Delivers a highly personalized experience, considering role, personal settings, and device settings
- Separates site design, site/page assembly/administration, from application design
- Provides application integration, collaboration, single sign-on services and much more

From Prudential's feature-rich Web site, visitors can search for homes on the market, obtain insurance quotes and request an appointment with a licensed financial professional.

# What are the barriers to business flexibility and reuse?

- Lack of business process standards
- Architectural policy limited
- Point application buys to support redundant LOB needs
- Infrastructure built with no roadmap

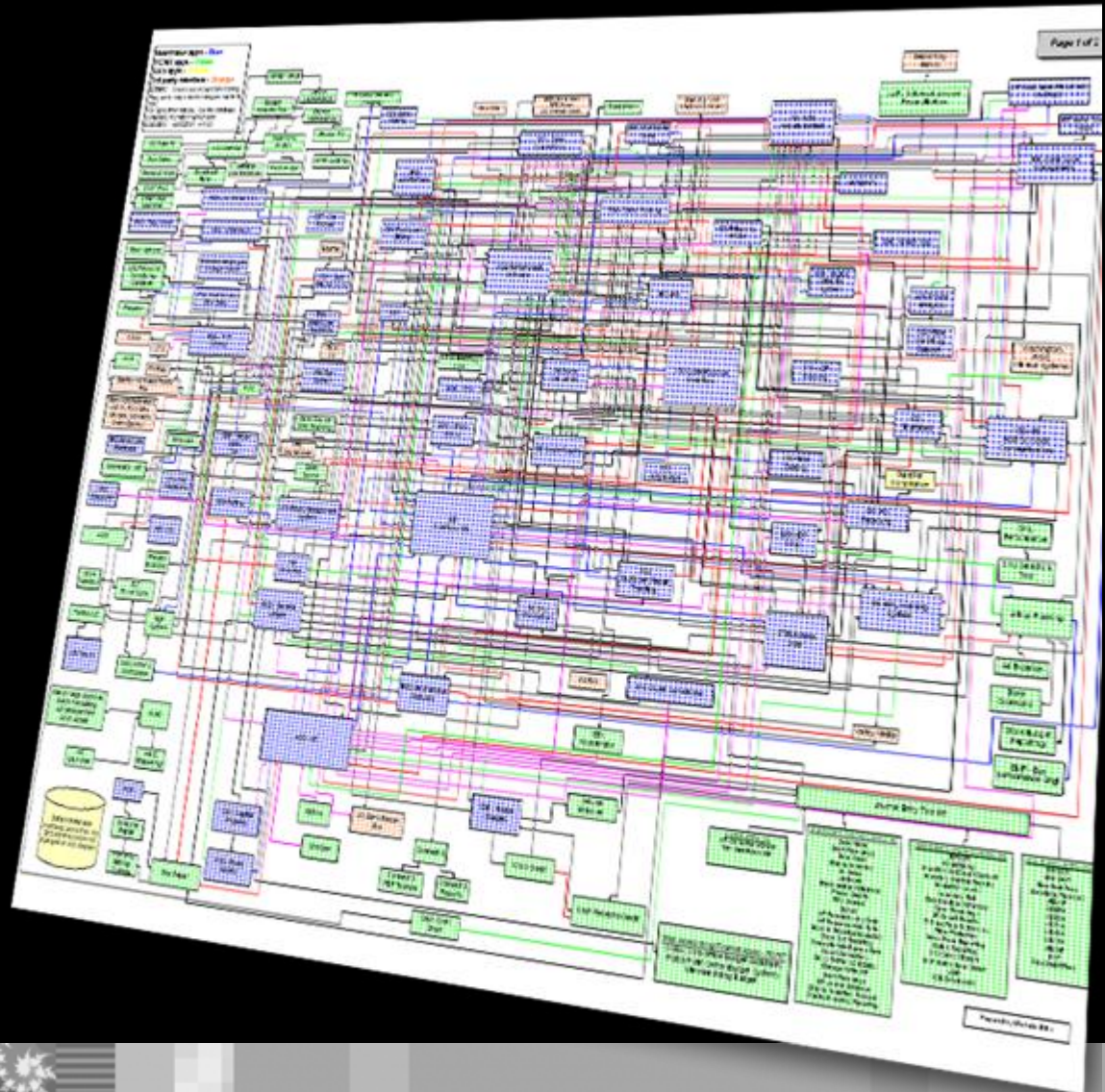

# What is SOA?

## ... a service?

A **repeatable business task** – e.g.,  
check customer credit;  
open new account

## ... service orientation?

A way of integrating your  
**business as linked services**  
and the outcomes that  
they bring

## ... service oriented architecture (SOA)?

An IT **architectural style**  
that supports  
integrating your business  
as linked services

## ... a composite application?

A set of **related & integrated** services that  
support a business  
process built on an SOA

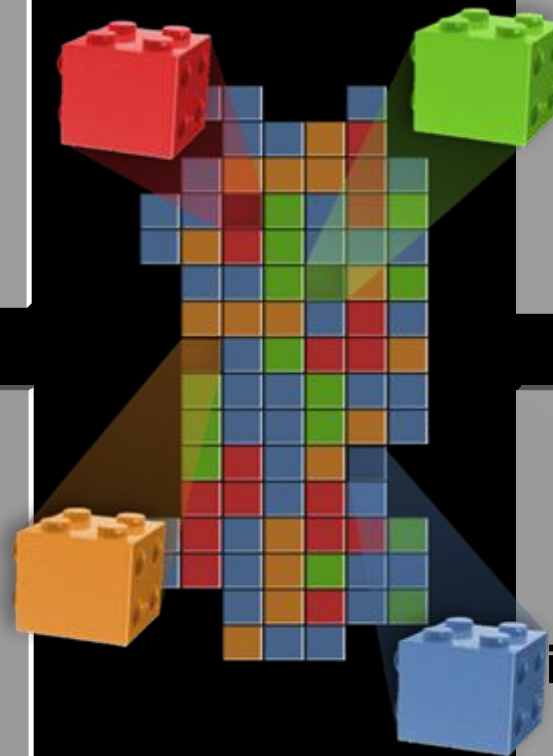

# Service Oriented Architecture

- An architecture that leverages open standards to represent software assets as standards based services independent of the platform they run on: J2EE, .net, Domino, CICS...
- Individual software assets become building blocks that can be reused in developing other applications
- Shifts focus to application assembly rather than implementation details
- Enterprise Service Bus provides messaging, mediation, transformations, pub/sub and other standards based services for enabling communication between these standards based building blocks.
- Business Process Execution Language (BPEL) provides a standards based way to choreograph together a set of web services into a business process.

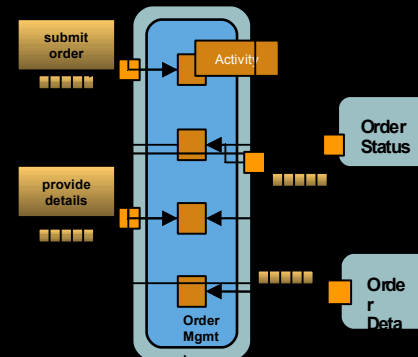
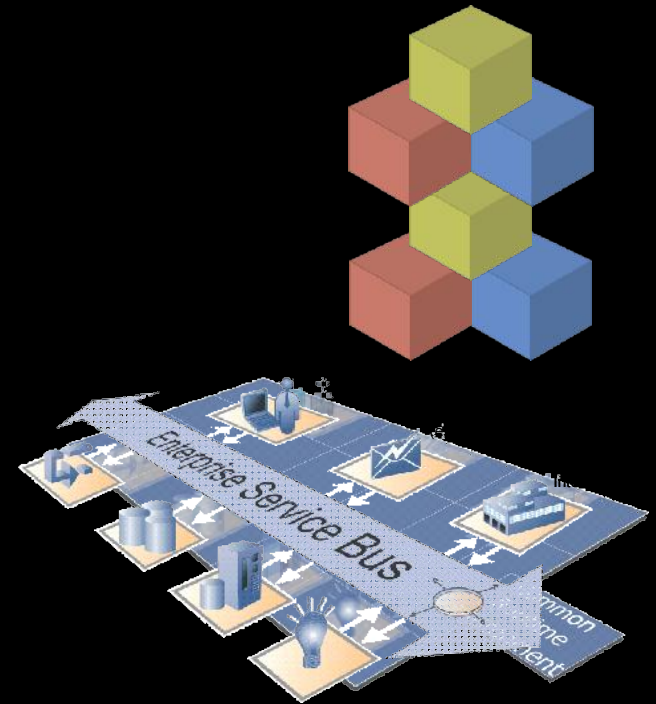

# SOA is important ... this is what businesses are saying...

*“Through 2007, an **enterprise portal** will be the **first major application of SOA concepts** for more than 50 percent of enterprises (0.6 probability).”*

Source: Gene Phifer, Gartner Research, October 2005

**60% of business executives** say IT will be a competitive weapon in the future and **80% say IT is of central importance** to their organization's ability to **adapt to changes**.

Economist Intelligence Unit Survey

**63% respondents** agree SOAs are **driven by the business**, whereas previous IT architectures were driven by IT

Cutter Benchmark Survey

## **Xerox enhances productivity with IBM enterprise service bus solution and SOA**

“With IBM's help we can move forward with a **service oriented architecture** that helps us respond to today's challenges and gives us a flexible architecture to respond to future challenges.”

**Ram Sunkara, Manager, Integration Competency Center, Xerox**

## **New Holland grows higher customer satisfaction with IBM solution**

“We plan to improve our speed to market in terms of developing seamless flows of information to integrate end to end with our business partners. IBM, WebSphere and the **service oriented architecture** will be the key components of our ability to do that.”

**Ted Post, System Integrator, CNH**

# The Top Benefits of Business Flexibility with SOA

## Productivity



*Easier change management*

## Agility and compliance



*Single source of information*

## Collaboration



*Role-based access for all*

## Customer experience



*Tasks provided by others*

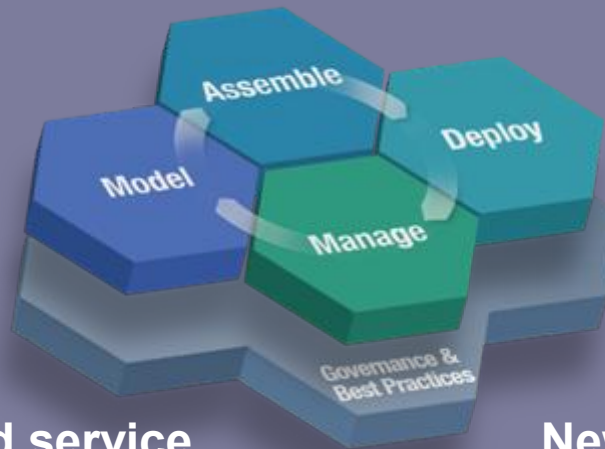

## Responsiveness and service



*Reduce transaction time*

## New opportunities



*Expand access to apps and systems*



# Portal Evolution - User Experience for SOA



- 1 Integration / SSO
- 2 Collaboration
- 3 Composite Apps
- 4 Process Portal
- 5 Federation
- 6 Offline Portal

# Enhancing Productivity through Optimized Interaction and Collaboration

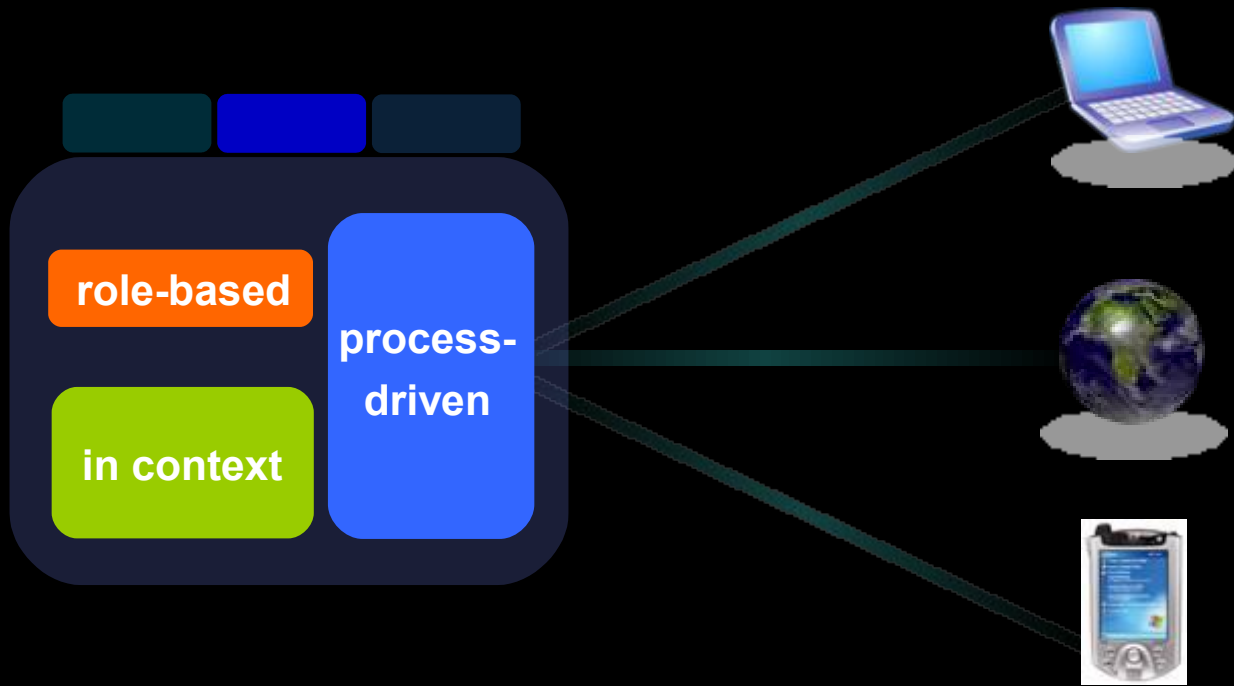

# Composite Applications optimize connections to people, information and processes

- Info from call Router portlet can populate the call center employee's desktop.
- People awareness allows chatting with customer service reps that helped the customer in the past
- People tag can be extended with application specific capabilities such as re-routing the call.
- Productivity can be improved by integrated disparate applications and allowing focus to remain in the app vs. navigating to the buddy list portlet.

The screenshot displays the IBM WebSphere Portal interface for On Demand Corporation. The page is titled "Welcome Cindy!" and includes navigation tabs for "My Work", "Business", and "Documents". The main content area is divided into several portlets:

- Customer Call Router:** Lists active calls, including "Tom Leslie - Call" (checked) and "Bob Smith - Call".
- Customer Profile:** Shows details for Tom Leslie, including Customer ID (000000001), Status (ACTIVE), and Current Balance (102.32).
- Customer Accounts:** Lists accounts with IDs 3145551001 and 3145551002, both with an ACTIVE status.
- Customer Call History:** A table showing call records:
 

CallID	Inquiry	Last Updated	Status	Agent
1	BILLING	null	COMPLETE	Jake Neumann
2	SERVICE	null	COMPLETE	Cindy Neumann
- Customer Call Details:** Provides information for Call ID 2, including Inquiry Type (SERVICE), Call Status (COMPLETE), and Call Teamspace (Create a Team Workspace).
- Special Offers:** Lists offers such as "High Speed Internet Access", "Local Long Distance Bundle", and "Calling Services". A context menu is open over this section, showing options: Chat, Send E-mail, Add to Sametime List..., Reroute Call, and Conference In.
- Customer Call Notes:** A rich text editor area for adding notes to the call, with "Submit" and "Reset" buttons.

The browser's taskbar at the bottom shows several open applications, including Lotus Domino Server, IBM WebSphere Portal, and Microsoft PowerPoint. The system clock indicates the time is 1:06 PM on 11/11/2006.

# A Grocery Store Dashboard

IBM WebSphere Portal - Microsoft Internet Explorer provided by Comcast

File Edit View Favorites Tools Help

Back Forward Stop Home Search Favorites Media Print

Address http://plendv07... wps/myportal/tut/pj.cmd/cs/.ce/7\_0\_A/\_s/7

Welcome Category Manager!

Home Scorecard **Category** Promotions Vendor My Human Resources

Quick View Sales Performance Trade Funds Markdown Analysis Best Ball Out of Stocks

My Portal Edit my profile Log out

Category KPI's

Time: 200426 Category: Categories

	Actual	Target	
Net Sales	\$13.71M	\$13.40M	Current Period
Billing Gross	\$6.54M	\$6.02M	Current Period
Markdowns % Sales	34.09%	29.64%	Current Period
AGP	\$4.70M	\$4.41M	Current Period

Markdowns % Sales Variance by Division

Time: 200426 Category: Categories Show

Map Grid

Portland\_Division: Variance %:-7.80494933 - Actual:25,15493378 - Planned:32,9598312

JavaScript:stateDetail('Portland\_Division','Portland\_Division','red');

#1 – High level view of performance

2 – Choose a category from a dropdown...

#4 –Interact with colleagues ...

#3- Drill down into Portland...

# Drill Down and Take Action

IBM WebSphere Portal - Microsoft Internet Explorer provided by Comcast

File Edit View Favorites Tools Help

Back Forward Home Search Favorites Media Print

Address http://plendv07 wps/myportal/markdownanalysis

### Problem Identification

Show Map Day 3 of 2nd Week PCYCL

### Markdowns by Category

Categories	Variance %				Actual				Planned			
	Markdown % Sales	Sales	Markdown	Units	Markdown % Sales	Sales	Markdown	Units	Markdown % Sales	Sales	Markdown	Units
KLLGG SPECIAL K VANILLA ALMD CRSP CEREAL	0.18%	-16.22%	-15.45%	-15.92%	27.338	6909.98	\$2,600	2,294.00	27.157	8248.14	\$3,075	2,7...
KLLGG PRODUCT 19 CEREAL KLLGG	0.11%	36.31%	37.07%	36.34%	27.944	2557.64	\$992	846.00	27.833	1876.3	\$724	6...

### Root Cause Analysis

#### Actual vs. Suggested Price

Year	Actual Price	Suggested Price
200426	\$3.00	\$3.00

#### Historical Promo Price (for 1 week)

### Action

Action: Please choose an action to resolve the problem.

Update Future Item Forecast

Go

#5 – Identify the problem...

#6 -Perform Root Cause Analysis ...

#7 – Record the recommendation - now usable by others...

# WebSphere Portal momentum

**Magic Quadrant for Horizontal Portal Products, 2005 (4 Years in a Row)**

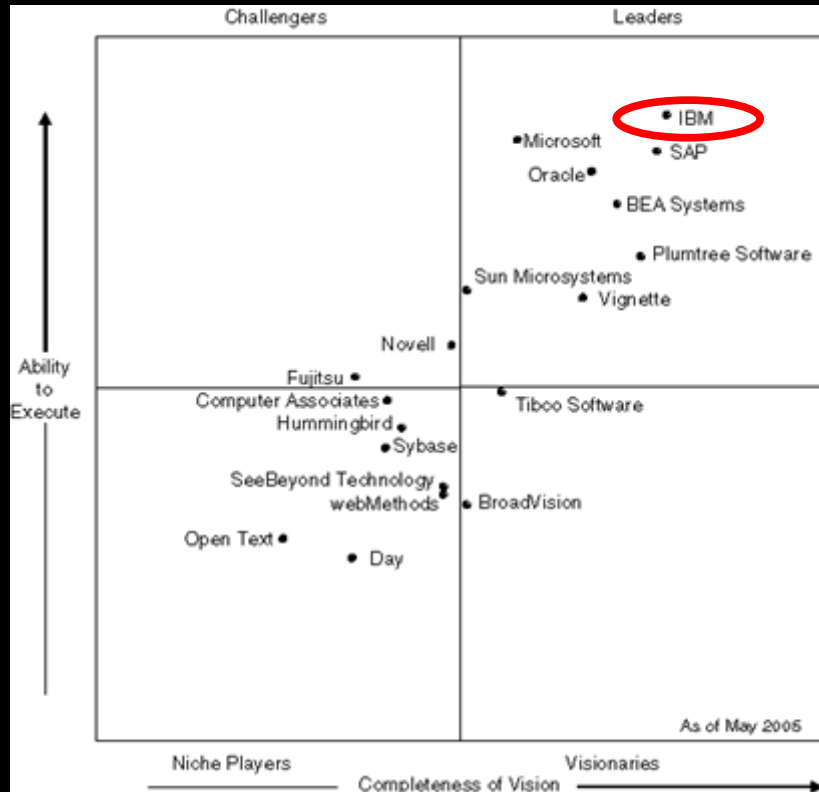

**WebSphere Portal Customer Growth**

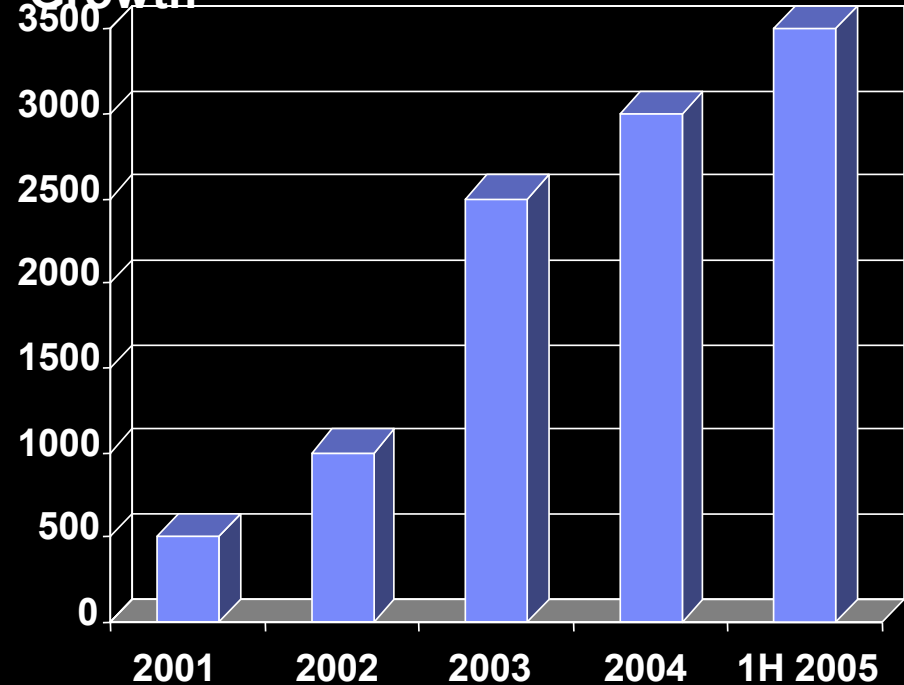

**Market Share Leadership**

- WebSphere Portal Market share = 21.6% (Gartner April 2005)
- WebSphere Portal Market share = 24.8% (IDC June 2005)

May 18 2005 by Gene Phifer, Ray Valdes, David Gootzit, Kim Underwood, Laurie Wurster

# IBM WebSphere Portal Version 6.0

**1**

## **Revolutionized user experience**

*Help increase productivity and revenue with dynamic, contextual experience*

**2**

## **Accelerated SOA**

*Help provide quick ROI from composite applications*

**3**

## **Optimized Administration & Management**

*Help lower total cost of ownership and rock-solid performance*

**4**

## **Orchestrated Workflow, Collaboration, & Forms**

*Powerful composite applications*

# Updated WebSphere Portal 6 interface speeds time to deployment

The screenshot displays the IBM WebSphere Portal 6 interface. On the left, a navigation menu is open, listing various site areas such as Home, News, Administration, Documents, Web Content Management, Personalization, Domino Integration, Templates, Search, Site Map, About, Messaging, Edit My Profile, and Log Out. The main content area features a large banner with the text 'IBM WebSphere Portal' and 'Build it better...faster!', followed by a 'Get Started Now' button. To the right, a 'Product Links' sidebar lists various portal features with icons and brief descriptions. At the bottom, a breadcrumb trail and a quick links bar are visible.

the desired location on the page



# Flyouts for common tasks (Portlets, Contacts, Help,...)

IBM WebSphere Portal provides everything needed to effectively build, customize and manage a portal solution.

In the new release access to these capabilities becomes just easy.

The screenshot displays the IBM WebSphere Portal interface within a Microsoft Internet Explorer browser window. The main content area features a 'Welcome to IBM WebSphere Portal' banner with the tagline 'Delivering power and flexibility... on demand!'. Below this, there are several sections: 'Get Started Now', 'Product Links' (including Administration, News, Documents, Messaging, Domino Integration, Personalization, Templates, Search, and Site Map), and 'What's New?'. On the right side, there are 'Portlets' and a 'Contacts' flyout. The 'Contacts' flyout is highlighted with an orange border and shows a list of contacts under the heading 'I am active'. The list includes names like Alex Song, Amy Travis, Charlie Hill, Chris Paul, Darren Upton, Deane Cheatham, James Thompson, Jenn Giardino, Jeremy Perry, Jessica Peter, Kathy Howard, Kristina McBlain, Laurie Jarzemsky, Lisa Salcedo Eichorn, Maje Zeller, Marty Moore, Meggan Todd, Michael Harris, Nicole Summers, Noy Phimmasorn, Pat Cox, Patrick McGowan, Patrick Noble, Randy Pool, Rob Corell, Roger Dido, Shibata-san, and Tom Spine.

# Portal Document Manager new look and feel

- Look & Feel
  - Native MS Office Icon
  - Icons show document state
- Ease of Use
  - Drag & Drop in the Browser
  - One Click Edit button
  - Search results and file lists paginated for easier navigation
- Admin
  - Multiple file import
  - Customize the “New” Menu
- Performance
  - Improvements via cached rendition rendering
  - Document 1<sup>st</sup> page preview

The screenshot displays the IBM Document Manager interface. At the top, there's a 'Document Manager' header with buttons for 'New', 'Import File', and 'More Actions'. Below this is the 'Marketing Programs' library, which includes a search bar and an 'Advanced' search option. The main area shows a table of documents with columns for Name, Author, and Last Modified. A context menu is open over the 'Design Partners Contacts' document, showing options like Edit, View, Lock, Copy, Move, Delete, and Replace. The bottom of the interface shows 'Hide Folders' and '0 folders, 4 documents'.

Name	Author	Last Modified
<a href="#">Design Partners Program</a>	Palmer Kunkle	7/27/05
<a href="#">Customer Values Program</a>	Rachael Stanley	7/26/05
<a href="#">Design Partners Contacts</a>	Roger Freeman	7/14/05
<a href="#">Promotions</a>	Colin Stafford	5/06/05

# Microsoft Integration

- Microsoft Office Integration
  - Power Point, MS Word & Excel
  - Check in, check out
- Microsoft Windows
  - Drag & Drop
  - Right click support
- Business Value
  - Security-enhanced Storage & File level security
  - Leverage existing MS products (MS Office 97 & Higher)

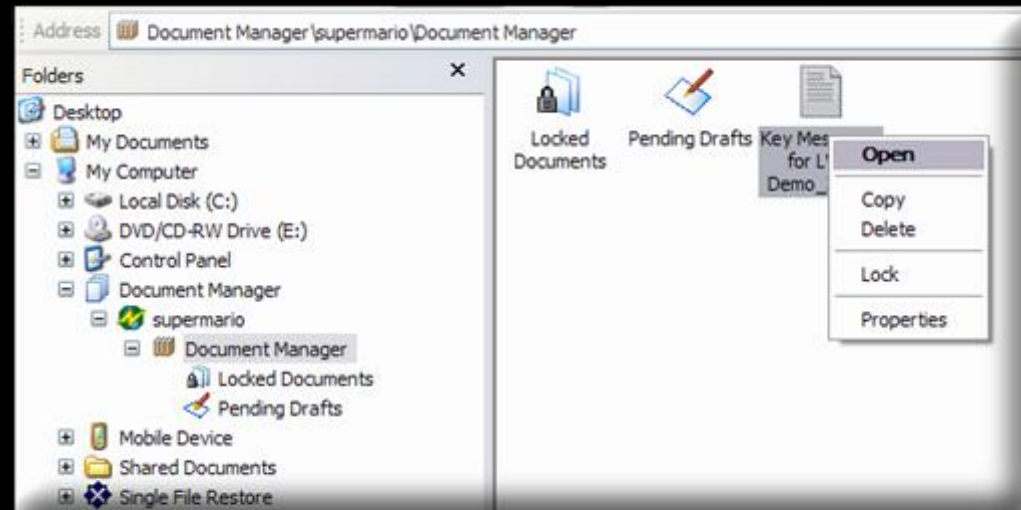
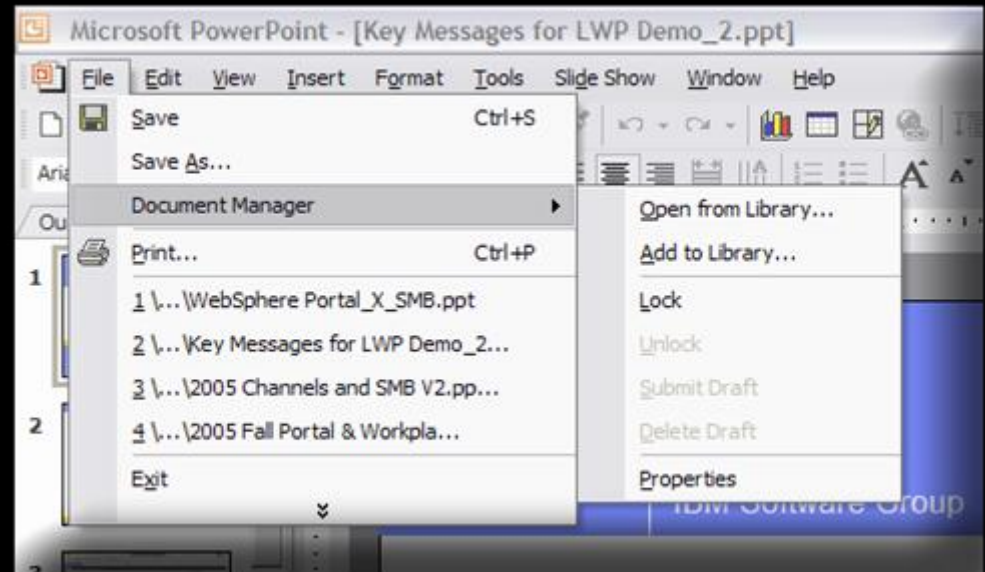

# Improved Search raises productivity

## New Search Enhancements:

- Improved search of Workplace Web Content Management (WCM) author, published and site content
- Search Center improvements
  - UI enhancements, Scope definitions
- Search performance improvements on indexing throughput
- Search and Index API (SI-API) published
- Search Domino and File system content via HTTP
- Improved External Search of Portal Content
  - Enhanced search results from Google and other search engines
  - Site map provides security-rich “outline” of Portal hierarchy for public URL portal content index control

## Welcome to Search Center

Find what you're looking for, anytime, anywhere... it's that easy

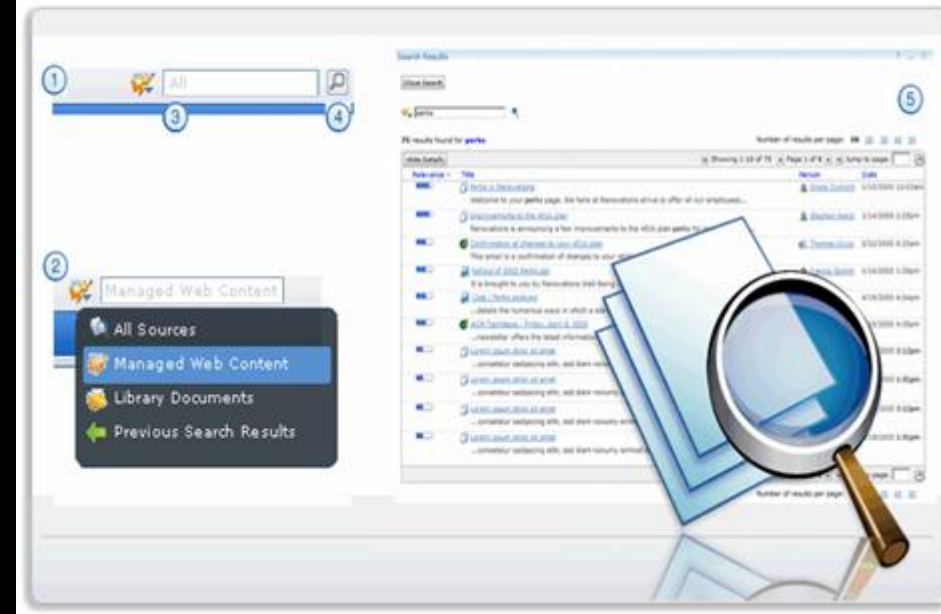

# WebSphere Portal 6 Search Center updates

## Find what you are looking for anytime and anywhere



**Search box in theme, always available at the top of the site.**

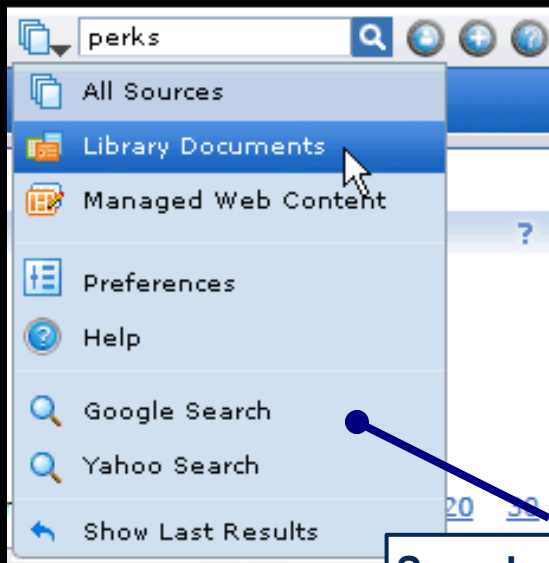

**Search scopes. Search all sources or in more targeted areas. Scopes can be defined by Admin. Add external links.**

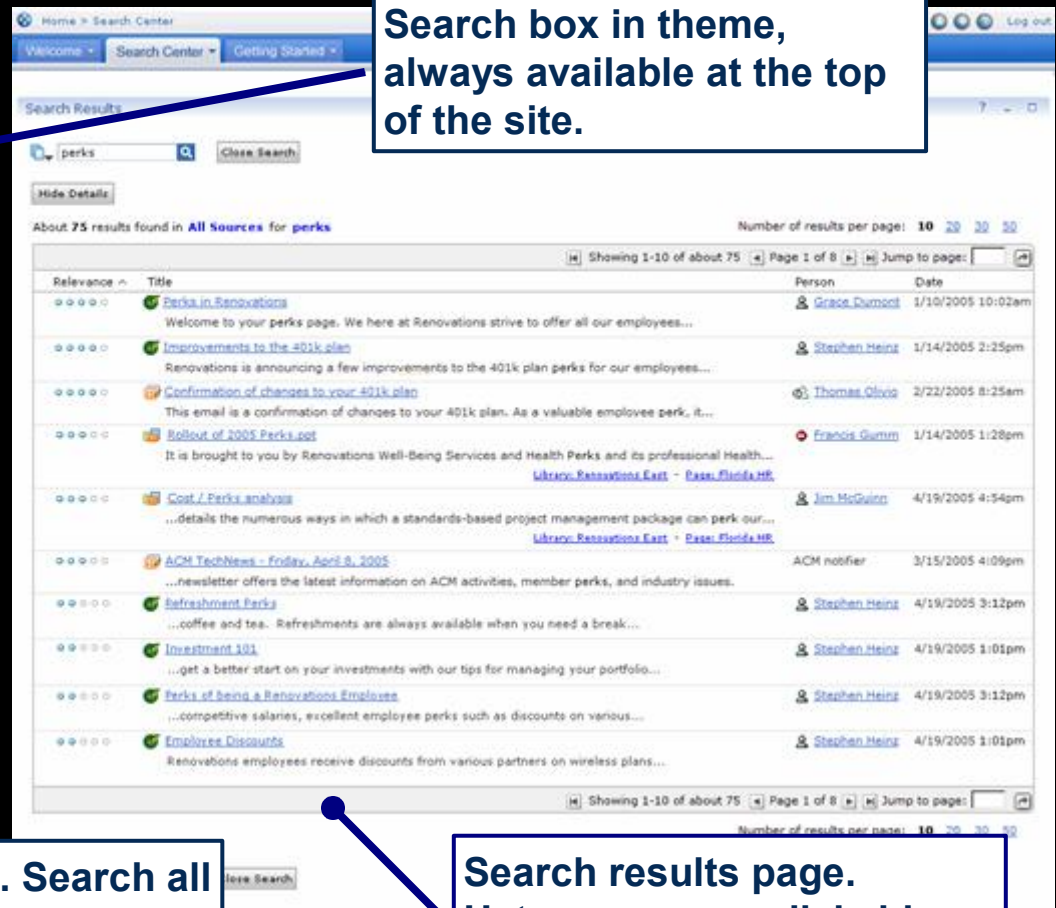

**Search results page. Heterogeneous clickable search results.**

# Manage and Control Public Content indexed by External Search Engines

## News Center Portal

(Hidden) optional Sitemap for the crawler to efficiently crawl all pages

Optional robot directives to not require the crawler to follow links on the portal pages.  
 <META name="robots" value="noindex, follow">

URLs normalized (for a crawler)

The screenshot shows a news portal with various sections. Annotations highlight specific areas: the top navigation bar, a large article about open source, a smaller article about Apple, a 'Daily spotlight' section with four items, a 'Most Popular Stories' list with five items, and an 'Also of interest' section with several links.

# Workplace Web Content Management

## End to End Content Management

Enables non-technical, non-HTML savvy users to create content (news information, announcements) for the Portal (or standard web sites)

With Workplace Web Content Management version 6.0:

- IBM leads the industry with *the most tightly integrated* Portal and Web content management solution on the market today.
- Advanced, rules-based personalization capabilities allow *targeted information to be dynamically delivered* to your employees, customers, suppliers and partners via the WebSphere Portal environment
- Enhanced authoring and administration capabilities so that web content can be created and delivered more effectively *via your WebSphere Portal environment*

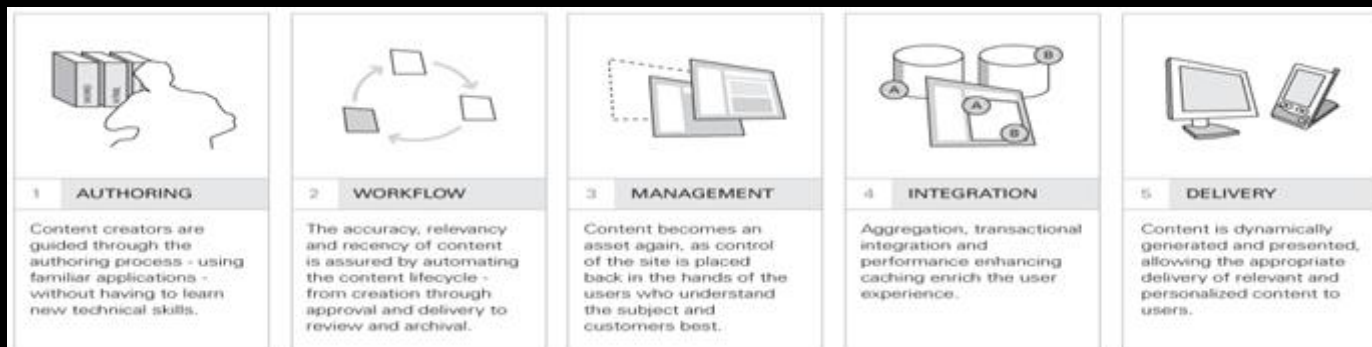

# Web Content Management Usability Improvements

## Improved authoring usability:

Welcome page to help new users get started

**Inline Editing** for infrequent users

User-friendly, simpler **templates** for entering content

Full text, attribute and taxonomy **search** and searches within searches

Simplified process for including **personalization** rules in content and layout

New views allow users to find their content easily

User interface can be customized easily to provide tailored experience

Web Content Management Welcome page content:

**Welcome to Web Content Management**  
Author, edit, and manage content for your site in a few simple steps.

**Get Started Now**

**Need Help?**  
Go to the IBM Information Center. The information center has complete and in-depth product information.

Try IBM developerWorks: developerWorks features articles about various topics related to IBM WebSphere Portal.

**Need Support?**  
IBM Software Support

IBM Newsgroups

**Need More information?**  
Get additional information and product news. Visit the IBM WebSphere Portal home page

**Other Links**  
IBM.com  
IBM Software Home Page  
IBM WebSphere  
IBM Software Support  
WebSphere Portal Zone  
Partner World  
Linux at IBM

1. Templates. Separate content from design by using authoring and presentation templates.

2. Search. Simple and advanced search functionality and the My Items view ensure that you can quickly find and work with Web content.

3. Libraries. Use automatic versioning and new library capabilities to organize content just the way you want.

4. Personalization. Use Web Content Management with Personalization to present the right information to the right people -- where and when they need it.

5. Task bar. Access common tasks quickly from the task bar. Use tabs to work with multiple content items when you create, edit, delete, and preview.

6. Simplified authoring environment. Anyone can quickly and easily create, edit, and publish content on the site.

Web Content Management enables end-to-end content creation, approval, management, retention, and publishing across Internet, intranet, extranet, and site assets. By leveraging content in back-end systems, Web Content Management reduces development and implementation time and ensures "author once, publish everywhere" control.

Home Administration Documents Web Content Messages Site Map



# Other Web Content Management Enhancements

- **Improved Site Scalability**
  - Library Sections can be created and updated separately to support specific site areas, making it easier to keep large, dispersed websites up-to-date
  - WebSphere Clustering Support ensures demand on servers is distributed more effectively
- **Greater “Look and Feel” Flexibility for sophisticated websites**
  - Enhanced Cascading Style Sheets (CSS) support enables designers to not only define the overall look & feel of the site, but also create specific designs for different site areas, user profiles, or individual content items
- **Protection against broken links**
  - New Link Management ensures all internally referenced website links will be up to date (e.g. "live" and not "broken")
- **Simplified Administration**
  - Integrated administration within Portal – no need to learn a different UI or administer from different location
  - Uses Portal’s built-in Java Content Repository
  - Unified access control for users and content objects
  - WebSphere clustering support: Administration of multiple WCM servers as one
  - Simplified cache and logging

# IBM WebSphere Portal Version 6.0

**1**

## **Revolutionized user experience**

*Help increase productivity and revenue with dynamic, contextual experience*

**2**

## **Accelerated SOA**

*Help provide quick ROI from composite applications*

**3**

## **Optimized Administration & Management**

*Help lower total cost of ownership and rock-solid performance*

**4**

## **Orchestrated Workflow, Collaboration, & Forms**

*Powerful composite applications*

# Composite Applications in Portal

**Announcements**

**New Item**

Author: Thomas Stober  
 Created: Dec 6, 2005 7:36 AM  
 Last modified: Dec 6, 2005 7:36 AM

Description: [Rich text editor]

Links: Provide links to useful websites.

FAQs

Members

All users have access as: Contributors. (Public)

Show: All members and groups

Moderators  
Contributors



Community & Roles

**Travel Budget**

Department: Marketing  
 Budget: \$20,000  
 YTD  
 Planned  
 Balance

**Travel Requests**

Help text about travel requests.

Traveler: Mike Morrissey	ID: R09558	Department: Marketing
Trip Name: AAB Conference		Trip Number: TK4950
From: New York		To: Frankfurt
Depart: 07/31/05		Return: 08/04/05
Purpose: Conference		Must be approved by: Amadou Alain

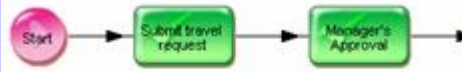

User Interface

Workflow and Dynamic User Interface

Business Components

Content

## Composite Application

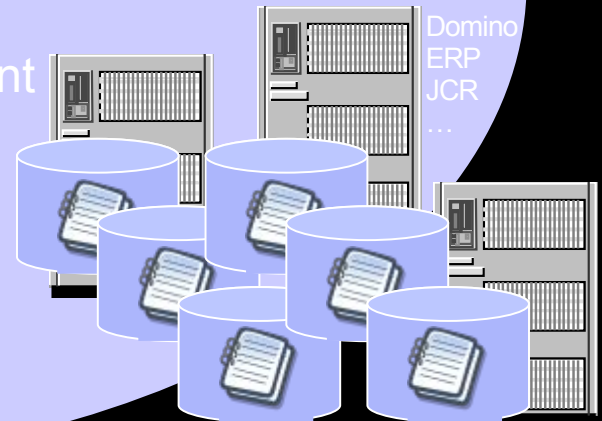
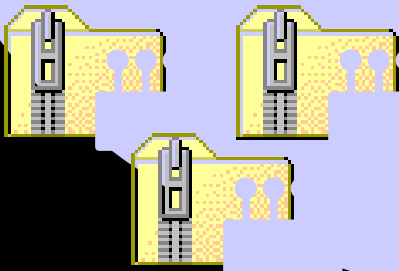

Domino  
ERP  
JCR  
...

# Build Composite Applications Faster with Portal Application Templates

Template based applications allow business users to define these applications once as a template

- Template defines
  - Pages
  - Portlets
  - Wires
  - Role mappings
  - Initial configuration values

*Portal applications can then be instantiated on demand by any authorized user*

Deploy them to different communities with different...

- Look and feel
- Members and Roles
- Other Parameters

*Application owners can then change it to meet new requirements*

IBM WebSphere Portal - Microsoft Internet Explorer

File Edit View Favorites Tools Help

Back Search Favorites Google Search Links Bell

Templates > Template Library >

Welcome Template Library

Application Template Library

The following application template has been created: Test

New... Import...

Show: All application templates

Name	Owner	Category	Modified	
Portal Blank Template	wpsadmin	None	March 21, 2006 4:29:10 PM EST	unlocked
Test	wpsadmin	None	March 22, 2006 8:23:48 PM EST	unlocked

Page 1 of 1

Home Web Content Messaging Site Map

start Microsoft Pow... Internet Explo... Chris Lamb - Inbo... 8:19 PM

# Template Membership and Roles Definition

- Create unique “Roles” for members
  - Build upon template for SOA / Composite application
  
- Business Value
  - Simplified interface to apply “rights” for each of the members
  - Designed for Business person No IT required
  - Create new SOA Composite applications that inherit current membership

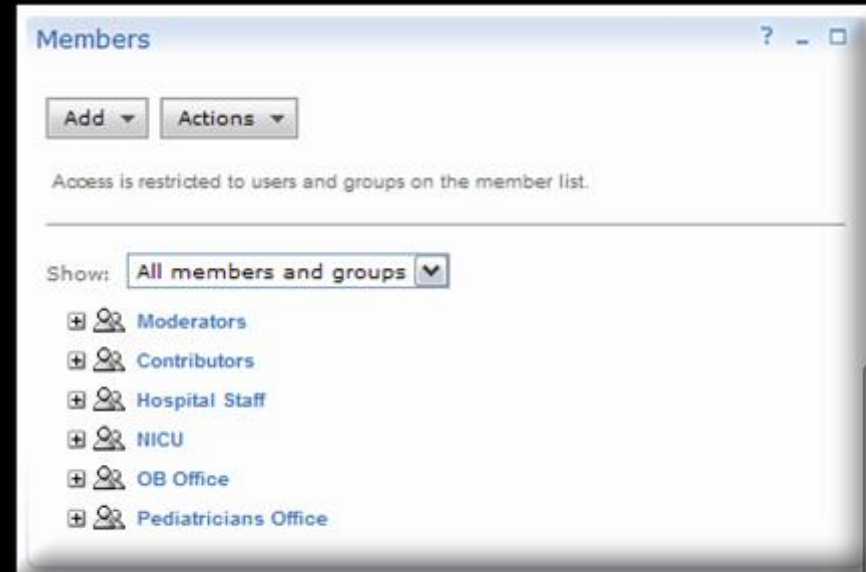

Type	Access	Description
Workplace	Manager	People with this role ca
Page		
Application Component	Administrator	Can read, create and c
Application Component	Manager	Can edit all list items;
Application Component	Manager	Can edit all list items;
Page		
Application Component	Manager	Can edit all list items;
Page		



# RENOVATIONS

Welcome | **WorkCenter** | **Travel** | Career & Life | I am available | ...

US Travel Home Page

**Trip Planning**

Travel Watch

Reimbursements

Corporate Charge Card

Group Meetings

## Travel Requests

Help text about travel requests.

Traveler: Mike Morrissey ID: RO9558

Depart: Market

Trip Name: AAB Conference

Trip Nu: TK4950

From: New York

To: Frankfort

Depart: 07/31/05

Return: 08/04/05

Purpose: Conference

Must be approved by: Amad

### Description:

This conference is important -- most of our biggest customers will be there. Here's the link to the conference website: [www.aab.com/conference2005](http://www.aab.com/conference2005)

### Supporting documents:

Flight: \$425	Rental Car: \$135	Total: \$1,235
Hotel: \$500	Meals: \$175	

### Comments:

Manager can see the information that employee provided for travel request. Contextual collaboration enables IM chat with employee for questions.

Manager can assess available budget from finance data and take approval action.

## Invited People

- Approvers (1)
- Travelers (1)
- Assistant (1)
- Ask the Expert (3)

## Travel Budget

Department:	Marketing
Budget	\$20,000
YTD	10,052
Planned	7,000
Balance	2,948

## Another Useful Tool



# Advanced Personalization speeds application deployment

- Administrators can apply “Personalization rules” to both portlets and portal pages
  - Use of Business logic to provide “dynamic” experience
    - Example: Show HR Benefits Page during enrollment period
- Enhanced personalization rules dialog accessed in context
- Business Value
  - Further map the business requirements to the Portal
    - Example: Marketing campaign

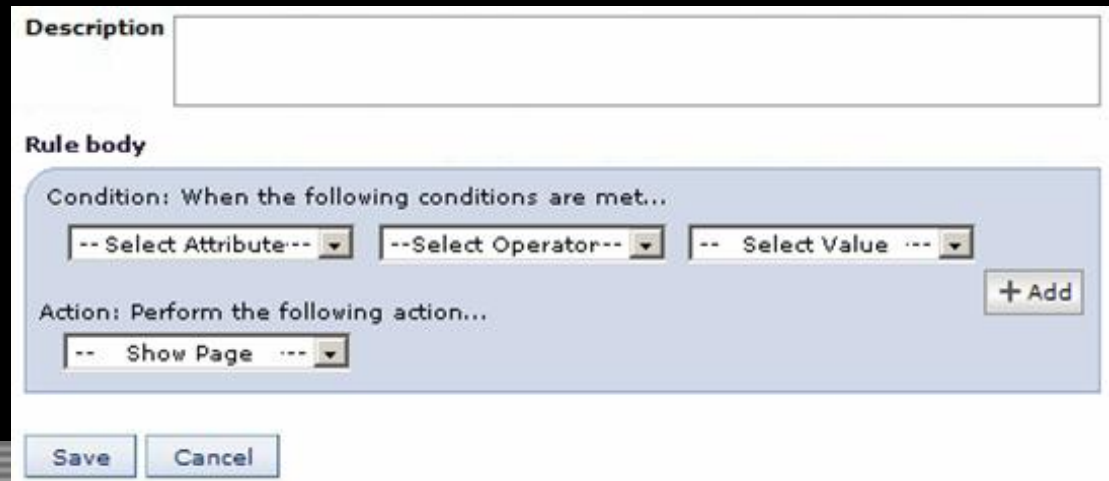
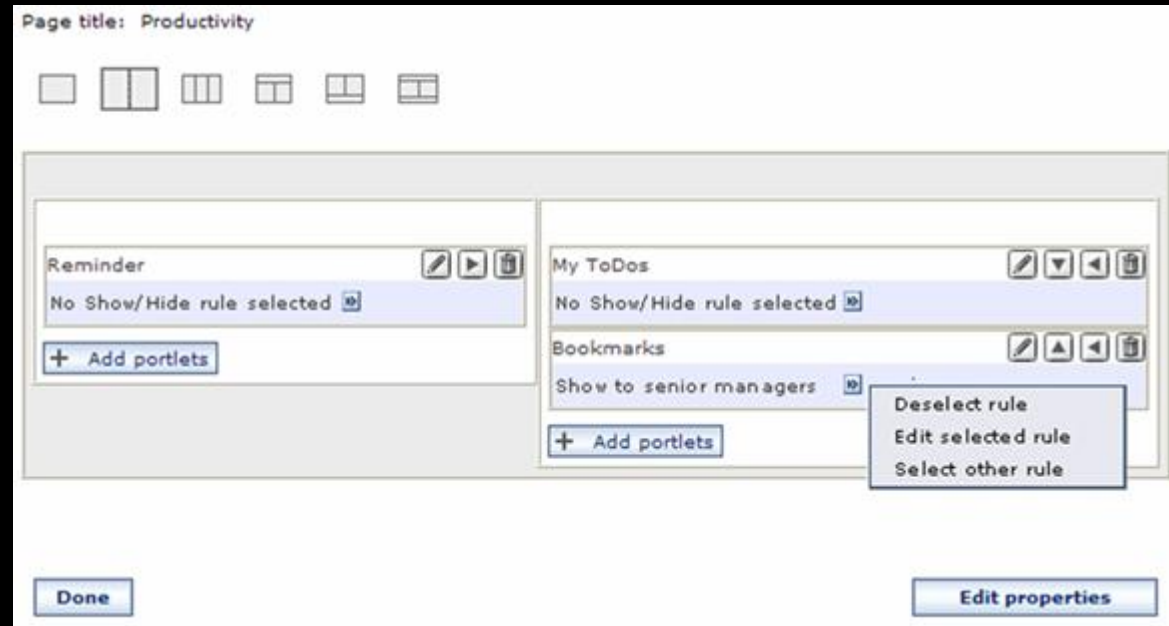

IBM WebSphere Portal - Microsoft Internet Explorer

File Edit View Favorites Tools Help

Back Forward Stop Refresh Home Search Favorites

Address http://9.152.239.54:10038/wps/myportal/!ut/p/c1/04\_5B8K8x

Personalization Picker >

Personalization Picker

**Select Rule**

Select a navigational rule from the list below. Once an item is selected, you will be taken to the previous page. Clicking 'Cancel' will return you to the previous page.

New

Name	For
My time based rule	

Show page or portlet when

- current Date.Time is greater than 05:00:00 PM CET
- Otherwise hide

OK Cancel

Home Administration Documents Web Content Messaging

Improved out of the box usability for rules creation

Back Forward Stop Refresh Home Search Favorites Media XML Bluetooth

Address http://9.152.239.54:10038/wps/myportal/!ut/p/c1/nY\_LCsIwEEW\_pV8wKxCbuLRatZSoDbY23ZQgpRb6cCGCF2-iuBBsF84sD4d7LxRgvzf

Personalization Picker >

businessCategory

Categories

cn

countryName

departmentNumber

description

displayName

employeeNumber

employeeType

First Name

Groups

homePostalAddress

ibm-gender

ibm-hobby

ibm-jobTitle

ibm-personalTitle

ibm-regionalLocale

Keywords

Last name

localityName

manager

o

ou

postalAddress

Personalization Picker

Select Rule - Editing a Rule

View Rule \* Preview Document

My time based rule

Located in Workspace Root

Description MY time based rule

Rule Type Visibility Rule

Visibility rules allow you to control the visibility of a page or portlet based on conditions expressed in this rule. Application values, user attributes, and any other context are available for use in the rule.

Show page or portlet when

current Date.Time is greater than 05:00:00 PM CET

Portal Users

Action Bean

Action Count

Browser Capability

Category Bean

Category Count

Date

Undo

Save Cancel

Home Administration Documents Web Content Messaging

Automatic discovery of Portal user speeds rules identification and targeted, efficient application deployment supporting business goals



# WebSphere Portlet Factory

## Helps Speed SOA Value & Deployment of WebSphere Portal

- **Automation** for multi-page, complex portlets to back end systems including Lotus Domino, SAP, Siebel, JDBC, web services and more, without coding – *speeds development/deployment*
- **Change** simplified for evolving business requirements – *increases efficiency of IT, LOB and users*
- **Reuse** for generation of new portlets from existing portlet models on demand – *serve more business and user requirements for more value*
- **SOA** for integration/delivery of existing applications and portlet interfaces as reusable services – *flexibility for increased productivity and ROI*

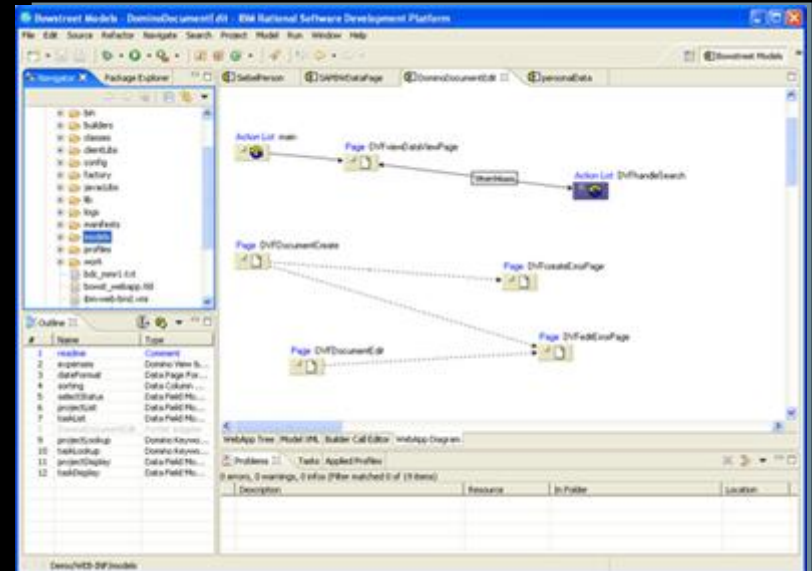

**Using the tool [Portlet Factory] also saved Allmerica \$1 million in development costs, Clifton adds. The technology enabled Allmerica to build the portal in four months, whereas using API technology would have taken about 16 months, he estimates.**

**Mike Clifton, Vice President of IT, Allmerica Insurance**

Source: *Insurance & Technology*, May 2005

<http://www.insurancetech.com/story/showArticle.jhtml?articleID=160906146>

# Multi-page, Complex Portlets without Coding

Developers of all skill levels can rapidly build multi-page, complex portlets (search, create, update, and delete) **without writing any java code.**

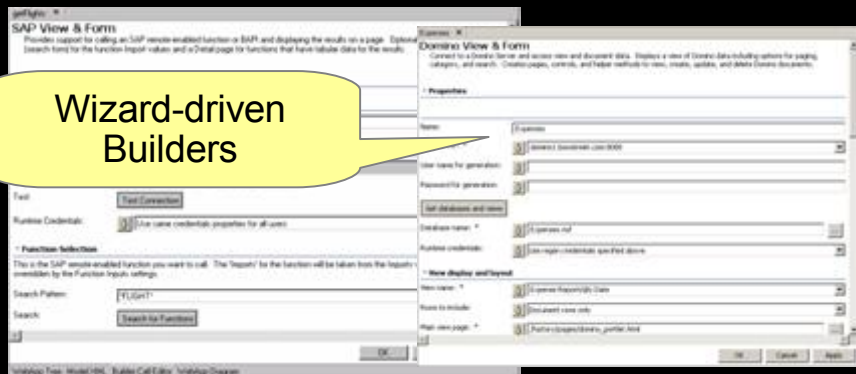

Wizard-driven Builders

```

* Generated Method [_pageDispatcher]
* Generated by builder call [bc21]
public void _pageDispatcher(WebAppAccess webAppAccess)
{
    com.bowstreet.webapp.JSPSupport.dispatch(webAppAccess);
}

/**
* Generated Method [getFlights]
* Generated by builder call [bc21]
public String getFlights()
{
    PagingAssistant asst =
    String img = button + position;
    if ((button.equals("First") || button.equals("Prev")) && !asst.hasPreviousPage())
        img = button + "Disabled";
    if ((button.equals("Next") || button.equals("Last")) && !asst.hasNextPage())
        img = button + "Disabled";
    return webAppAccess.getVariables().getXmlText("getFlights_PagingButtonImages", img);
}
    
```

... generate J2EE-compliant code automatically

## Multi-page Portlet

1 Create new records...

2 ...create a results page...

Owner	Status	Total
	Submitted	188.5
	Submitted	2250
09/08/2004 Edgar Meyer	Bela Fleck Submitted	120
09/08/2004 Jerry Douglas	Bela Fleck Submitted	222.38
09/08/2004 Jerry Douglas		219.35

3 ... create a drill down page...

4 ... build-in support for delete and edit...

Date	Category	Comment	Billable	Amount
05/23/1995	Other/Other	Instrument maintenance		250
05/02/1995	Airfare/Employee Paid	Airfare to Denver		339.45

5 ...and save or cancel changes.

Expense Report 4490-WP for Jerry Douglas (Submitted)

Submitter: Jerry Douglas/Users/Wildmichal  
 Approver: Bela Fleck/Users/Wildmichal  
 Project: Line 44  
 Created: 05/08/2004  
 Description: living in an stage

Report ID: 4490-WP  
 Status: Submitted  
 Task: Tour  
 Modified: 01/24/2005

Date	Category	Comment	Billable	Amount
05/23/1995	Other/Other	Instrument maintenance		223.5
05/02/1995	Airfare/Employee Pa	Airfare to Denver		339.45

# Robust Integration Capabilities Deliver SOA

Pre-built Extensions enable companies to quickly create composite portlets and applications that leverage data and processes from multiple backend systems via SOA.

The screenshot shows the IBM WebSphere Portal interface with several portlets:

- Alerts:** A table listing priority status alerts for sales and news.
- EBITDA:** A bar chart titled "EBITDA in Millions of Dollars" comparing Actual, Forecast, Variance, and Previous values.
- Key Performance Indicators:** A table comparing 2004 and 2005 YTD performance against targets for various financial metrics.
- Top Opportunities:** A table listing the top 10 opportunities by amount, including account, rep, amount, stage, and product.
- Sales Activity:** Three 3D pie charts showing sales qualification, technical qualification, proof, negotiation, and close for inactive, active, and total sales.

Callouts from yellow speech bubbles identify the following components:

- SAP:** Points to the EBITDA chart.
- Web Service:** Points to the Alerts portlet.
- Domino:** Points to the Top Opportunities table.
- SAP and Siebel:** Points to the Key Performance Indicators table.

# Support for Key Portal Standards

The Java Portlet API (JSR 168) defines the API for local portlets, Spec Leads: IBM and Sun see <http://jcp.org/jsr/detail/168.jsp>

WSRP (Web Services for Remote Portlets) deals with visual web services in portals, IBM provides Chairman and Spec Editor, for more information see <http://oasis-open.org/committees/wsrp>

JSR 170 defines a common interface for access to content management systems

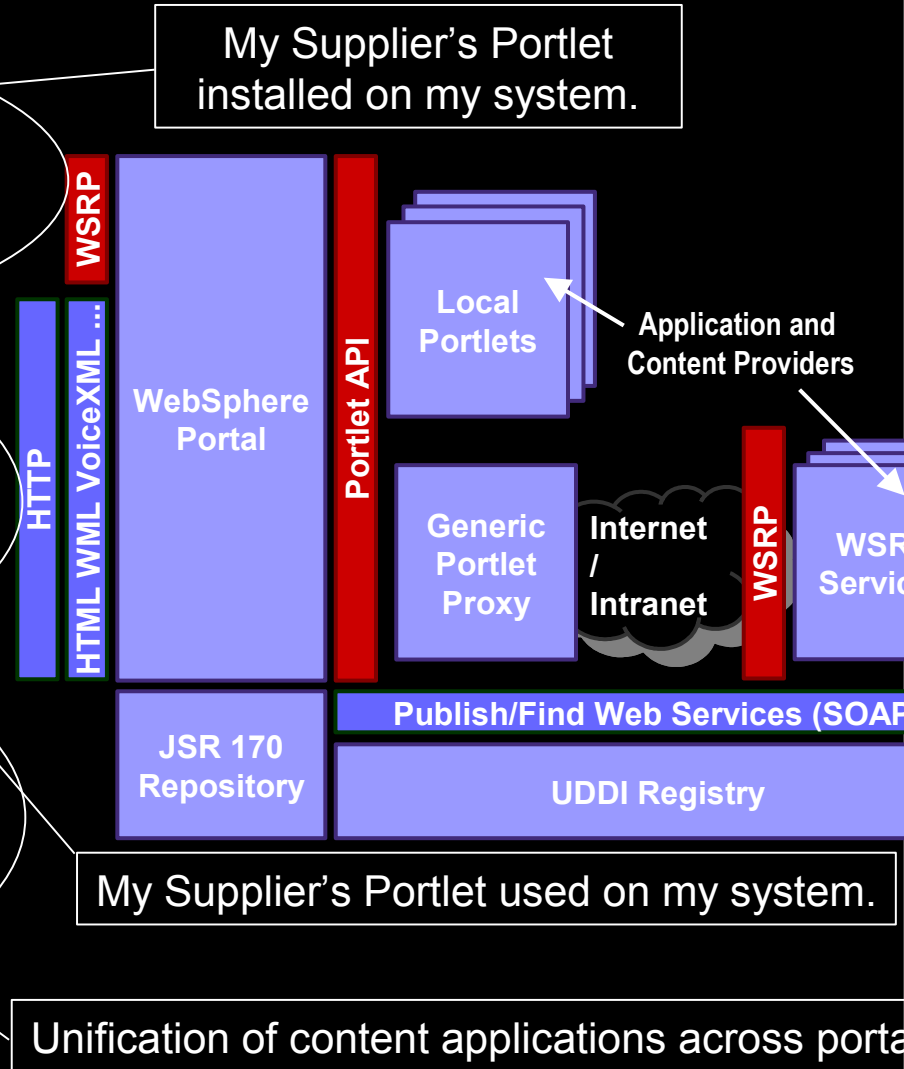

# IBM WebSphere Portal Version 6.0

**1**

## **Revolutionized user experience**

*Help increase productivity and revenue with dynamic, contextual experience*

**2**

## **Accelerated SOA**

*Help provide quick ROI from composite applications*

**3**

## **Optimized Administration & Management**

*Help lower total cost of ownership and rock-solid performance*

**4**

## **Orchestrated Workflow, Collaboration, & Forms**

*Powerful composite applications*

# Policy Based Application Administration

- Improves application deployment and change management
  - Policy is a globally scope set of values for a given group of users
  - For example: maximum document storage used
- Admin interface for setting system wide “policy sets”
  - Default Policy Set
- Easy to use component configurations for different communities.
  - Example: Mail quotas can be defined differently for employees, managers, and executives
- Helps increase reliability

### Workplace Policies

**Edit Properties**  
Set the conditions and actions for the workplace application policy.

\* Name:

Maximum workplace application size:

No limit

Limit  MB

Send warning message at  %

Send warning message when maximum workplace application size is exceeded to:

Administrator

Moderators

Members

Display warning message in Home page of application.

Length of time to keep after no activity:

No limit

Limit maximum days with no activity to  days

Send warning message after  days

Send warning message for maximum days with no activity to:

Administrator

Moderators

Members

# Contextual Menus

## Contextual Admin Menus

- Right admin actions based on the portal object
- Only shows the “actions” allowed by the “Role” & “Person” (Security)
- Visual indicators

## Business Value

- Helps simplify administration
  - results in lower training costs and improved productivity
- Helps speeds deployment & management

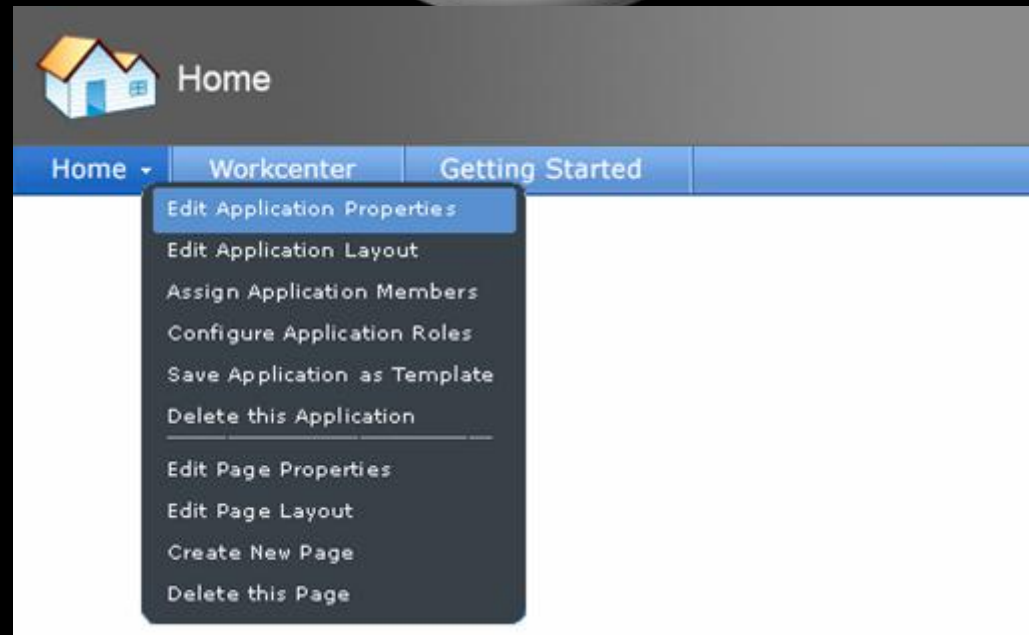

# Multiple LDAP Binding

- Multiple LDAPs
  - Can bind to multiple LDAP directories
- Business Value
  - Flexibility for different customer environments
  - Reduces the need to customize the “Member Manager” or a Tivoli Directory Integrator
  - Reuse Portal deployments both inside & outside firewall Including Virtual Portals

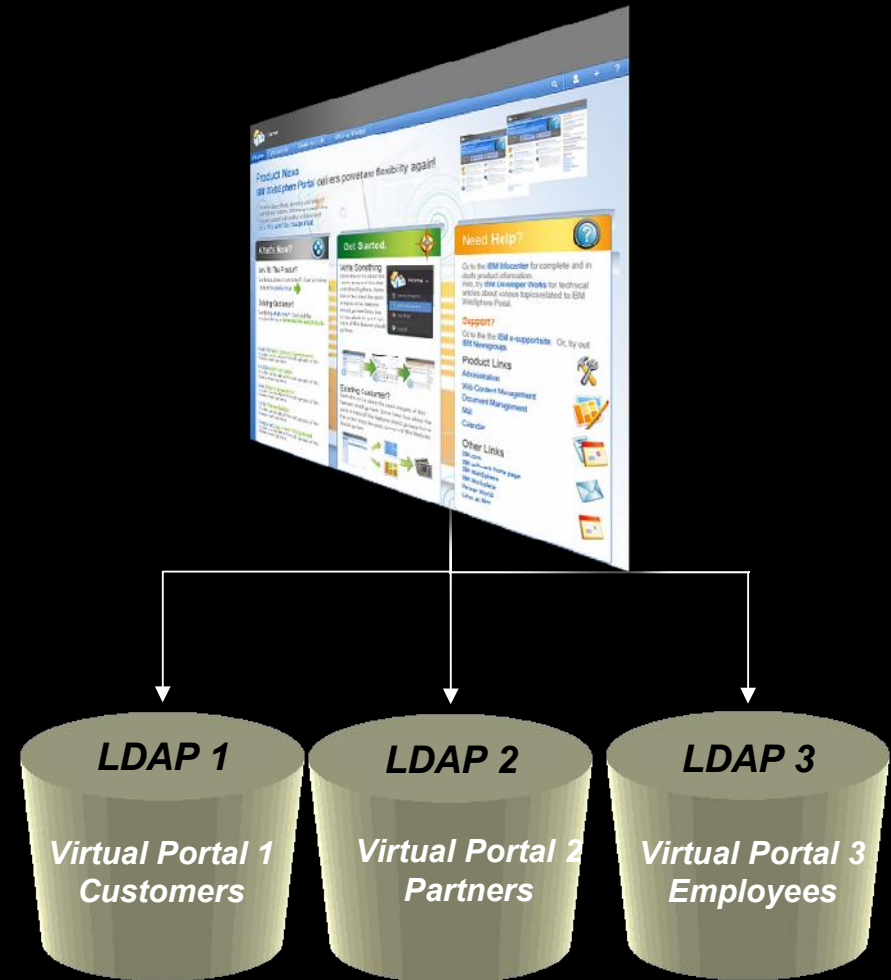



# Portal Data Separation: “Configuration Split”

- Partition Portal configuration data into 4 logical buckets
  - Configuration data: Class files and property files, etc.
  - Release data: portal pages and the portlet instances + default modes & state
  - Customization data: portlet data (user data)
  - Community data: WCM, PDM, application instances
- Business Value
  - Allows for 24/7 maintenance & upgrades & easier back-up & restore
  - Eases management of portal in cluster configurations
  - Enables global deployment (with replicated user data)



# Performance Focus Areas

- Improve computation during request processing
  - Supports Portal sites with over 30000 pages
  - Caching context in session
  - Reuse already computed results and objects
  - Reduce DB calls
  
- Better linear scaling by adding CPUs
  
- Performance Best Practices
  - Provide guidance for design regarding tradeoffs so that customers know what they have to give up in order to scale

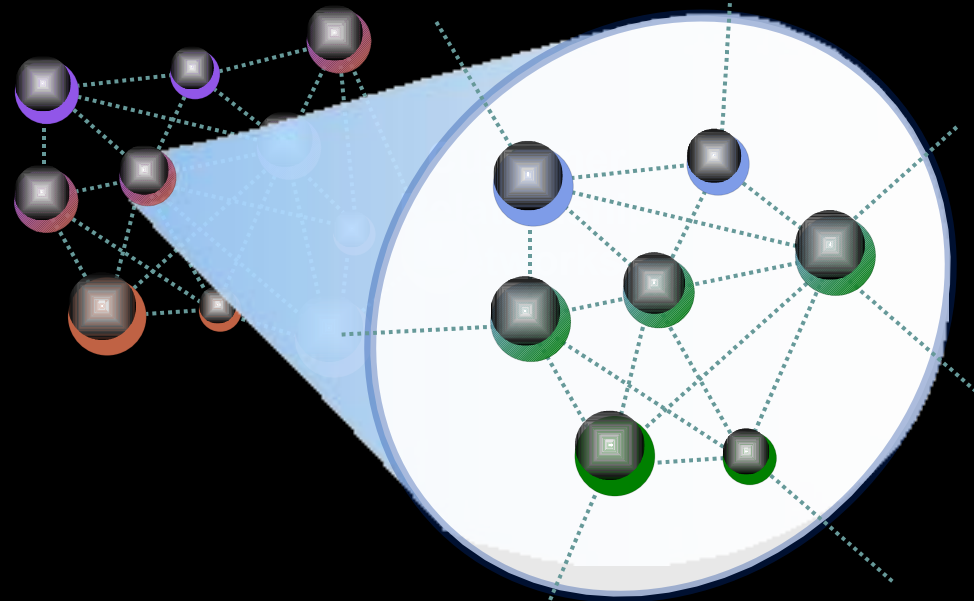

# Domino Configuration Wizard

## Domino and Portal Integration made easy!

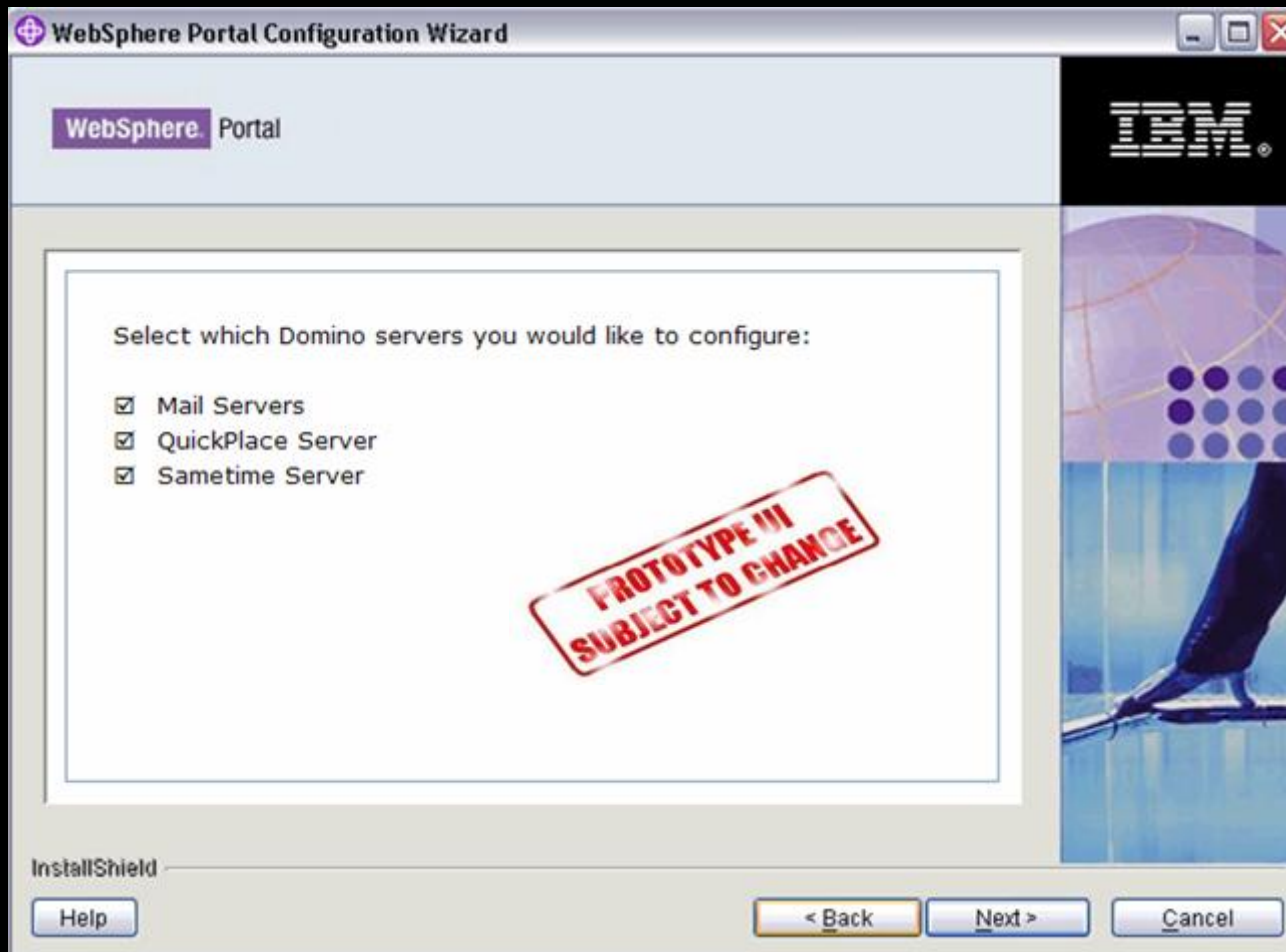

Simplifies  
configuration of  
Portal with Domino

Validation after each  
screen

Delivered via Portal  
Catalog soon after  
WP v6.0!

# IBM WebSphere Portal Version 6.0

**1**

## **Revolutionized user experience**

*Help increase productivity and revenue with dynamic, contextual experience*

**2**

## **Accelerated SOA**

*Help provide quick ROI from composite applications*

**3**

## **Optimized Administration & Management**

*Help lower total cost of ownership and rock-solid performance*

**4**

## **Orchestrated Workflow, Collaboration, & Forms**

*Powerful composite applications*

# Automate departmental tasks with Workflow Builder

- Business User tool for simple workflows
  - Many processes handled via email today
  - Automate best practices or infrequent tasks
  - Example: Bringing new employee on board
- Workflow Binder includes all related documents for a given workflow
- Utilizes Process Choreographer BPEL engine
- Integrated into Portal Composite Application template model
- Business Value
  - Helps reduction of errors
  - Consistently better decisions

Templates > Template Library > All Sources

Welcome Template Library

Application Template Library

New... Import...

Show: All application templates

Name	Owner	Category	Modified	
Bring on board template	vpsadmin	None	20 March 2006 13:54:52 GMT+00:00	unlocked
Customer Request Applic		None	16 March 2006 13:55:22 GMT+00:00	unlocked
Portal Blank Template	found	None	7 March 2006 00:35:21 GMT+00:00	locked
Portal Blank Template fo		None	19 March 2006 15:06:22 GMT+00:00	locked

Page 1 of 1

Home Administration Do ing Site Map

# Example: Process Driven Collaborative Workflow

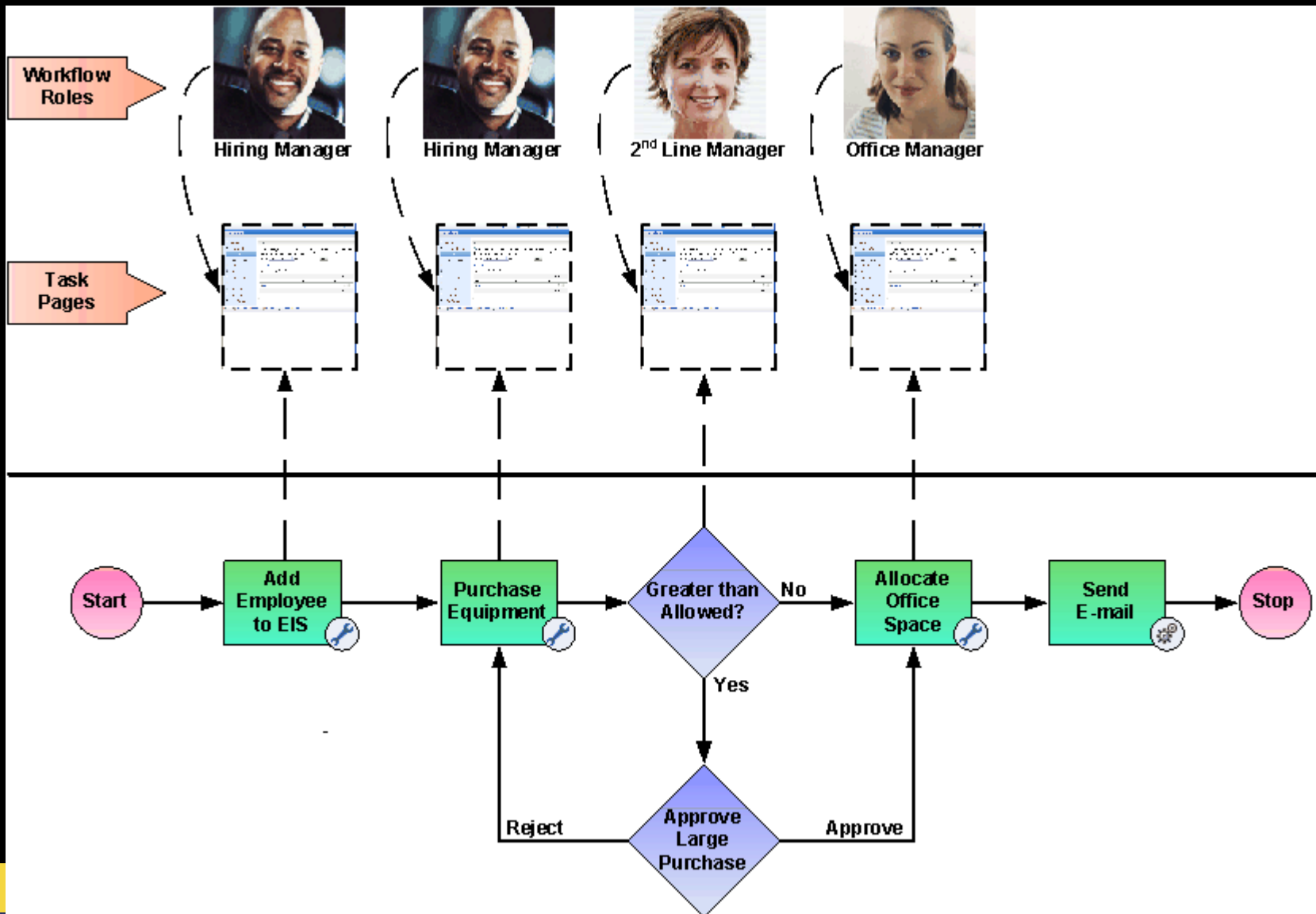

# Common PIM Portlets

Provides basic messaging and calendar capabilities with a native Portal look and feel.

Supports Domino, Exchange, IMAP and POP back ends

New WebSphere Portal 6 features:

- Enhanced UI
  - Mini View Portlets
    - Mail & Calendar
  - Drag & Drop
  - Usability Enhancements
- Exchange Functionality
  - Exchange 2000/2003 calendar support
  - Performance Enhancements
  - Future: Outlook Web Access integration
- Increased Deployability

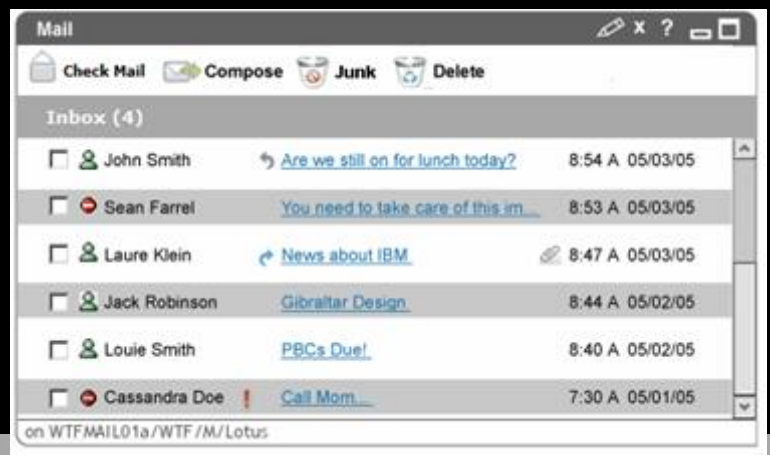
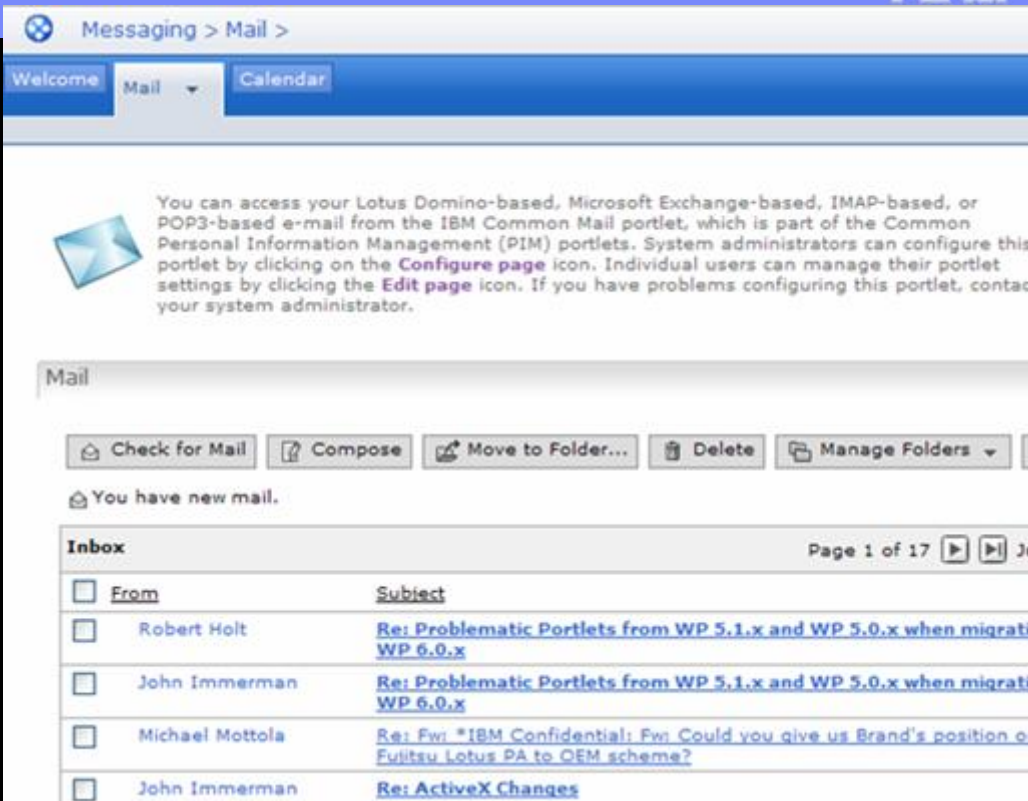

# Domino & Extended Products Portlets (DEPP) Enhancements

- Performance improvements
- Support for Domino 7.0
- Notes View
  - Domino 7, WSRP support , improved UI, presence awareness
- Domino Web Access
  - Domino 7 support, support for Domino redirect db, more features
- Quickplace
  - Domino 7, improved UI, place creation, user tasks list across member places
- Sametime contact list
  - Improved ease of use, sorting

IBM WebSphere Portal - Mozilla Firefox

File Edit View Go Bookmarks Tools Help

http://shimmerportal.notesdev.ibm.com:10038/wps/myportal/tut/p/c1/04





Google Hotmail IBM Internal Help Ho... IBM Standard Softw... BluePages

Home > My Work >

Welcome My Work Getting Started

## My Work

### Quick Links

-  Go to Documents to organize and share documents, enable document-approval workflow, create a folder hierarchy, and more. myWork.webContent = Web Content
-  Go to Messaging to integrate mail and calendar functions from your existing messaging system into your site.
-  Go to Domino Integration to integrate Domino Documents, Sametime, Quickplaces, and more into your site.
-  Go to Personalization to create rules that customize what the site displays to each user.

### My Tasks

[Claim](#) [Cancel Claim](#)

-- Message Detail -- -->

 An error occurred while retrieving the

<input type="checkbox"/>	Task	Created ^

### Reminder

Monday, March 27, 2006

**No reminders found**

### World Clock

Local Time:

Transferring data from shimmerportal.notesdev.ibm.com...



# Workplace Forms Integration with Portal

Workplace Forms Designer

Workplace Forms Viewer

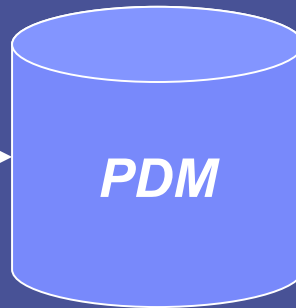

# Viewing a Form within Portal Document Manager

The screenshot displays the IBM Workplace Forms Document Manager interface. On the left, a sidebar shows the document hierarchy under 'Documents' and 'IBM Workplace Forms'. The main area shows the document 'Mortgage Pre-Approval.xfd' with its description, creator (Cindy Neumann), and creation/modification dates (December 2, 2005). Below this is a toolbar with various icons and a zoom level of 100%. The form content includes the IBM logo, the title 'Mortgage Pre-Approval Form', and a 'Steps' sidebar with options like 'Mortgage Requirements', 'Mortgage Details', 'Borrower Personal Data', and 'Co-Borrower'. The 'Mortgage Requirements' section asks for information such as Mortgage Amount, Down Payment, Interest Rate, Payment Frequency, Amortization Period, and Start Date. A 'Mortgage Calculator' window is also visible, with fields for Purchase Price, Down Payment, Interest Rate, Amortization Period, and a 'Calculate' button.

# Extend Composite Applications to Portal-Managed Clients (2H2006)

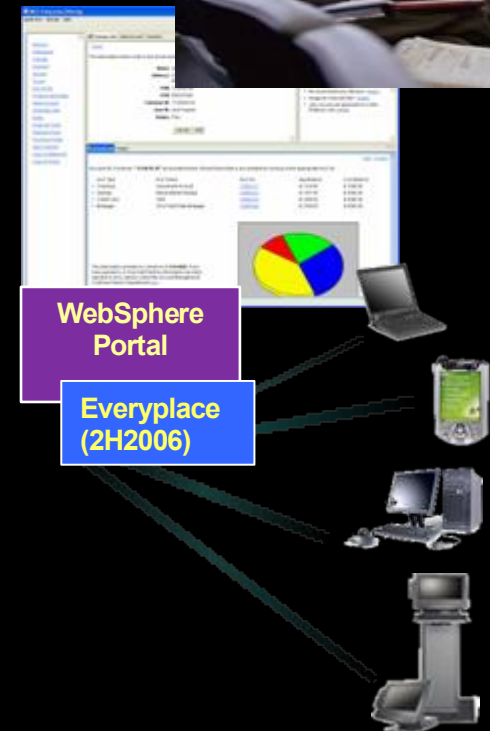

- **Portal applications available on managed clients, whether connected or disconnected**
  - Access to critical applications
  - Where needed... safely and securely
  - Rich client UIs and browser-based UIs
  - Tools to take portlets offline with little effort
- **Enhanced role-based portal administration**
  - Portal admin can remotely deploy managed apps for users, based upon roles
- **Business Value**
  - Help increased user productivity through access to enterprise portals regardless of network availability
  - Help lower TCO through remote deployment and maintenance and reuse of assets and programming skills

# WebSphere Portal is the foundation for building composite applications driving the front end of SOA

**Services**

- Management Dashboards
- Sales Force Automation
- Customer Relation Management
- E-Forms
- Content Management
- Collaboration
- eHR
- Composite products
- Syndicated Rates
- Claims

**Natural, Intuitive, Adaptive User Experience**

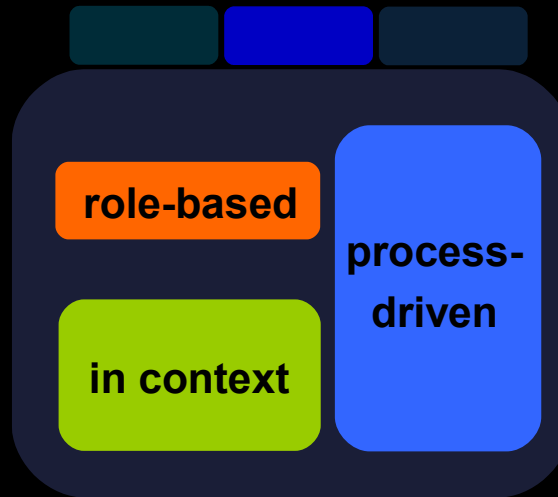

*Composite application or view, that securely assembles and delivers services in the form of portlets in the context of a business process*

# Adding incremental value on top of WebSphere Portal



**Focus**  
Solving a Particular Business problem vs a functional component

**Accelerate**  
A customer's "time to value"

**Benefits**  
"Out of the box" end user product  
  
Maintains flexibility with SOA platform and tools to Extend capabilities

**Business Oriented**  
Focused on emerging business needs

# WebSphere Portal is the foundation for Workplace Composite Applications



IBM Workplace for Business Strategy Execution



IBM Workplace Forms



IBM Workplace Dashboards



IBM Workplace for SAP



IBM Workplace for Business Controls and Reporting

## Natural, Intuitive, Adaptive User Experience

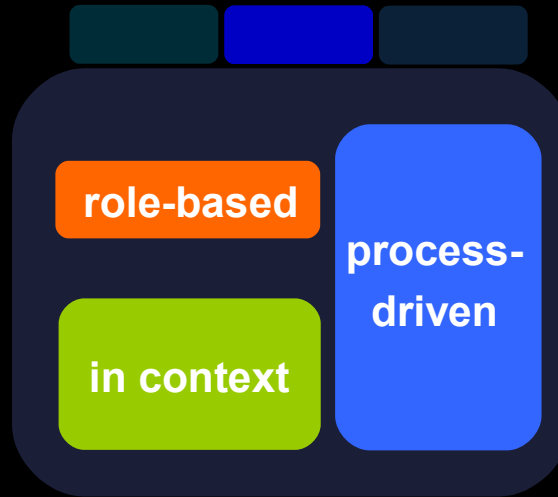

*WebSphere Portal is the platform supporting composite applications that securely deliver information and interaction in the context of business processes*

# IBM WebSphere Portal Version 6.0

*Platform for delivering the front end of SOA*

- **Helps improve efficiency and productivity**
- **Helps accelerate application and content deployment**
- **Delivers responsiveness and reliability at lower cost**

- Software
- IBM Workplace Solutions Catalog
  - IBM Lotus Domino
  - IBM WebSphere Portal
  - IBM Workplace Client Technology
  - IBM Workplace Collaboration Services
  - IBM Workplace Services Express
- On Demand Automation Catalog

IBM Workplace Solutions Catalog >

# IBM WebSphere Portal

The leading enterprise portal for on demand business

Tell us what you think!  
Take our survey.

**Search**

Hot searches: ["Lotus Award"](#), ["Ready for"](#), [Seibel](#), [Citrix](#)

- Industries** Solutions All categories
- [Aerospace & Defense](#)
  - [Automotive](#)
  - [Computer Services](#)
  - [Consumer Packaged Goods](#)
  - [Education](#)
  - [Electronics](#)
  - [Energy & Utilities](#)
  - [Financial Markets](#)
  - [Government](#)
  - [Healthcare](#)
  - [Insurance](#)
  - [Life Sciences](#)
  - [Media & Entertainment](#)
  - [Other Industrial Industries](#)
  - [Professional Services](#)
  - [Retail](#)
  - [Retail Banking](#)
  - [Telecommunications](#)
  - [Travel & Transportation](#)
  - [Wholesale Distribution & Services](#)

- New**
- IBM Workplace for Telecom Contact Centers
  - IBM Workplace for Property and Casualty Underwriting
  - IBM Workplace for Telecom Field Service
  - IBM Workplace for Procurement
  - IBM Workplace for Branch Banking
  - [More...](#)

- Popular**
- WebSphere Portal V5.1 Sample Code
  - IBM Websphere Portal Theme Builder
  - IBM Web Page Portlet V5.0
  - IBM Lotus Notes/Domino and

- Related links**
- Catalog feedback
  - Getting Your Solutions into the Catalog
  - Subscribe to IBM Portal News
  - developerWorks WebSphere Portal Zone
  - WebSphere Portal newsgroup (NNTP)
  - WebSphere Portal newsgroup (Web based)
  - IBM Workplace Resource Center
  - Lotus WorkPlace Forum
  - Business Partner

**Notice** - For non-IBM offerings in this Catalog, you may be directed to a third party website. In such cases, the third parties are responsible for any warranties, support, and licensing terms related to the offering. View the complete [disclaimer](#) and [warning](#).

**IBM Workplace Solutions Catalog** contains solutions for WebSphere Portal and Workplace and other IBM Software Group Offerings

✓ **IBM and Partner Portlets and Technologies** fully supported by IBM or IBM Partner



## Additional Information and Resources

- Websphere Portal and Workplace Catalog:
  - <http://www-3.ibm.com/software/genservers/portal/portlet/catalog>
  
- Webspere Portal Product Information:
  - <http://www-306.ibm.com/software/genservers/portal/enable/>
  
- WebSphere Portal Information Center documentation
  - <http://www-106.ibm.com/developerworks/websphere/zones/portal/proddoc.html>

# Maximizing Your Portal Investment with Education & Training

- **The IBM WebSphere Portal Version 6.0 Curriculum is targeted at a technical audience, which includes scripters, programmers, and system administrators. Courses, available in Q3, are available through select Education Centers for IBM Software (ECIS) business partners.**
- **Looking to become IBM WebSphere Portal Certified?**
  - Check the Lotus Certification homepage at <http://www.lotus.com/certification> to learn more about IBM WebSphere Portal certification.
- **To locate an ECIS partner or learn more about the IBM WebSphere Portal curriculum, visit the Lotus Education homepage at: <http://www.lotus.com/training>.**
- **IBM WebSphere Portal Version 6.0:**
  - Fundamentals
  - Application Development
  - Administration
  - Installation and Deployment
- **IBM WebSphere Portlet Factory 6.0:**
  - Developer Fundamentals
  - Advanced Developer Topics
  - Dashboard Framework Version 2.6
- **IBM Web Content Management**
  - Developing Web Sites Using IBM Web Content Management Version 6.0
- **IBM Workplace Forms Designer**
  - Training for IBM Workplace Forms Version 2.6



धन्यवाद

Hindi

多謝

Traditional Chinese

ขอบพระคุณ

Thai

Спасибо

Russian

Gracias

Spanish

Dziękuję

Polish

Thank You

English

شكراً

Arabic

Obrigado

Brazilian Portuguese

Afrikaans

Siyabonga

Zulu

多谢

Simplified Chinese

Danke

German

Grazie

Italian

Merci

French

நன்றி

Tamil

ありがとうございました

Japanese

감사합니다

Korean





IBM Software Group | IBM SOA Technology Summit

Thank You



“So you want to increase efficiency and boost productivity. And you want to do it fast. Then you want...”

**WebSphere. Portal Version 6.0**

**ON DEMAND BUSINESS™**

© 2006 IBM Corporation