



IBM Software Group

IBM Plataforma Rational Jazz

1 Octubre 2009

Rational. software



@business on demand software

Agenda

- **10.00 – 10.45 - *Introducción estrategia y oferta Jazz.***
- **10.45 – 11.15 - *Demostración de plataforma Jazz.***

Café

- **11.45 – 12.30 - *Mejores prácticas en la implantación de Jazz.***
- **12.30 – 1.15 - *Experiencia de La Caixa en adopción de Jazz.***
- **1.15 – *Preguntas***

Cocktail



¿Qué escuchamos en el mercado en España?

1. **Reducción de costes de desarrollo** es la prioridad número 1.
2. Adopción de modelos offshore o nearshore – **Factorías de Software.**
3. Interés en **mejora de procesos de desarrollo** y adopción de **metodologías ágiles.**
4. Simplificación y **reducción de costes de integración** de herramientas.



¿Qué es Jazz?

Jazz es :

1. La iniciativa de IBM Rational de cara a promover integración de las distintas tareas realizadas en el ciclo de vida del desarrollo
2. La tecnología que la soporta proporcionando un middleware de integración para ello.

Innovación

IBM ha realizado una gran inversión en la creación de esta plataforma de colaboración escalable para equipos de desarrollo.

Evolución

Muchos productos de Rational evolucionarán para soportar la plataforma Jazz, proporcionando capacidades de última generación para el desarrollo de software.

Comunidad

Jazz.net – Un portal abierto para el desarrollo de terceros sobre la plataforma Jazz.

Visión

La visión de IBM es que el futuro del desarrollo de software estará en soportar tipos diversos de equipos y personal con gran dinamismo y que estará distribuido globalmente.



Colaboración (integración) entre herramientas es exponencialmente compleja.

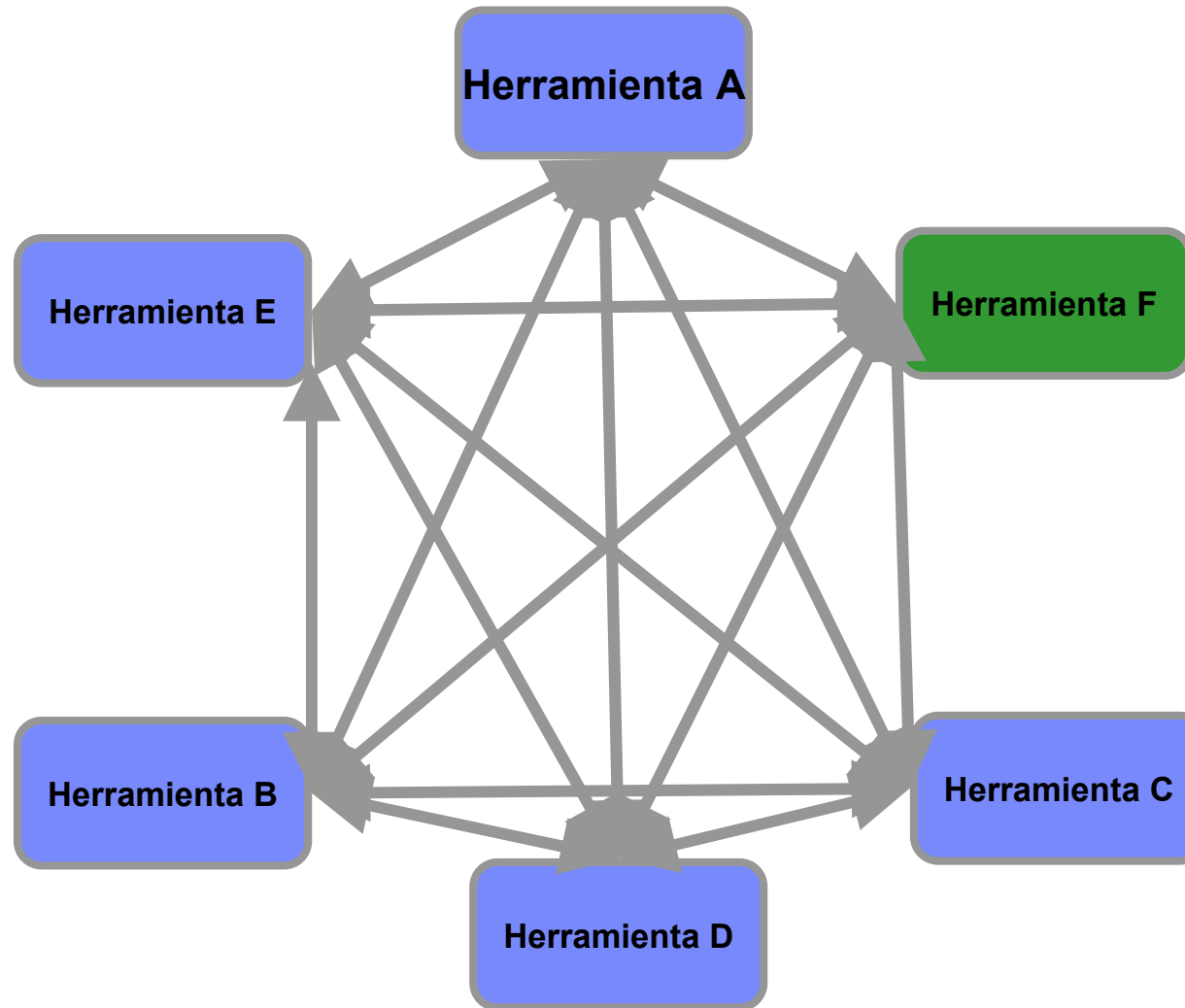

Arquitectura antes de Jazz de las herramientas Rational

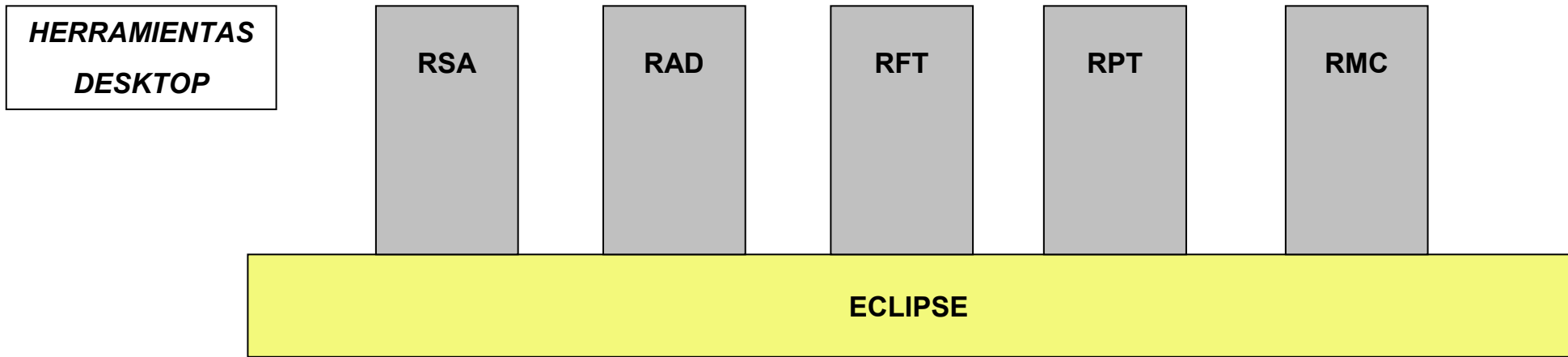

Arquitectura antes de Jazz de las herramientas Rational

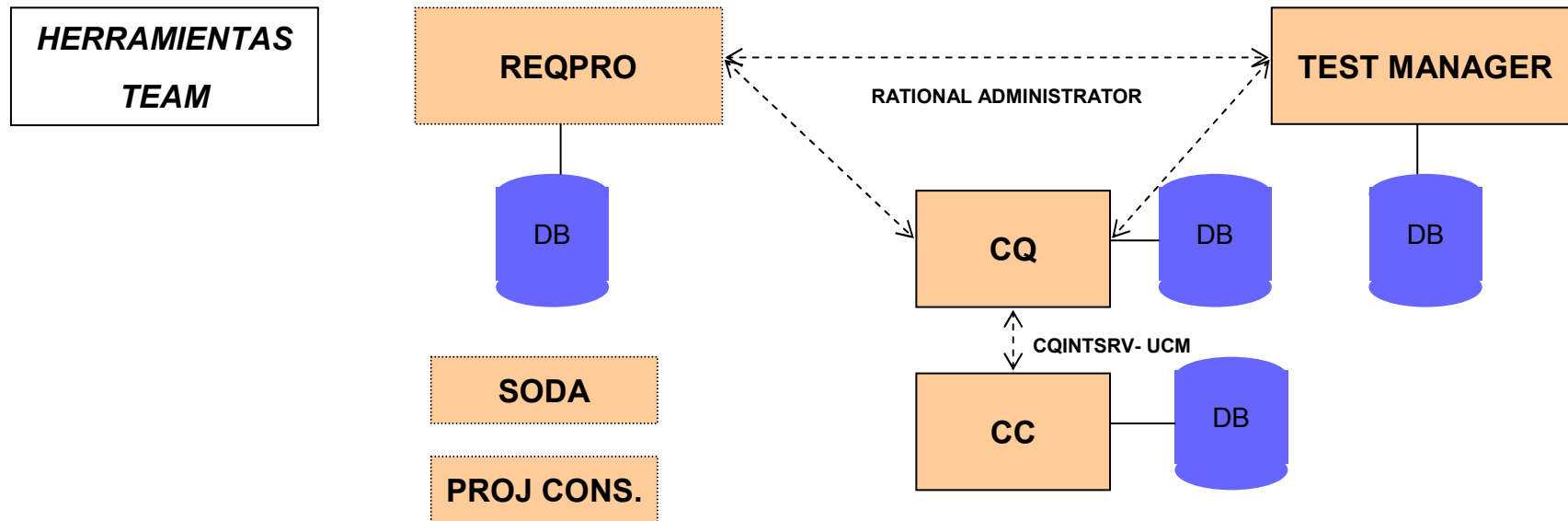
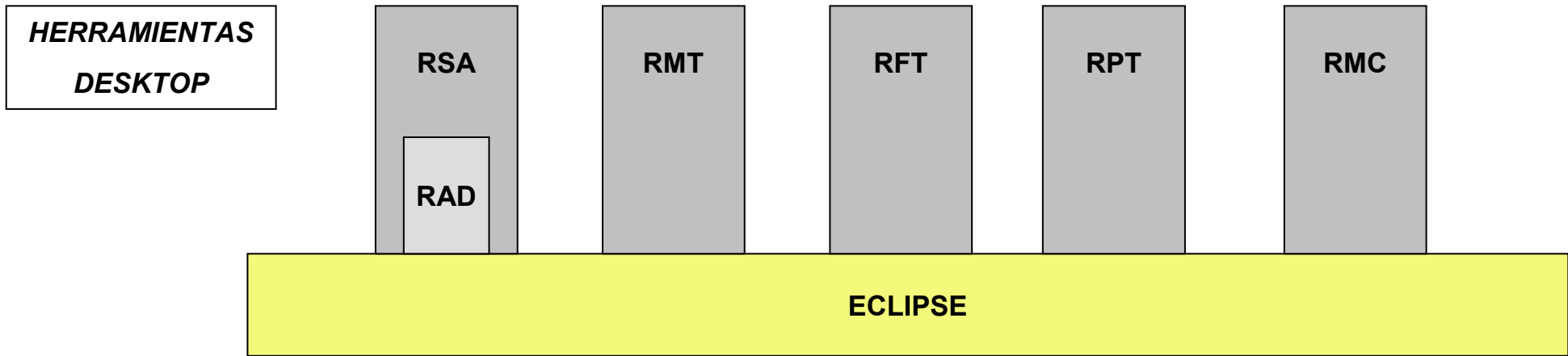

Arquitectura antes de Jazz de las herramientas Rational

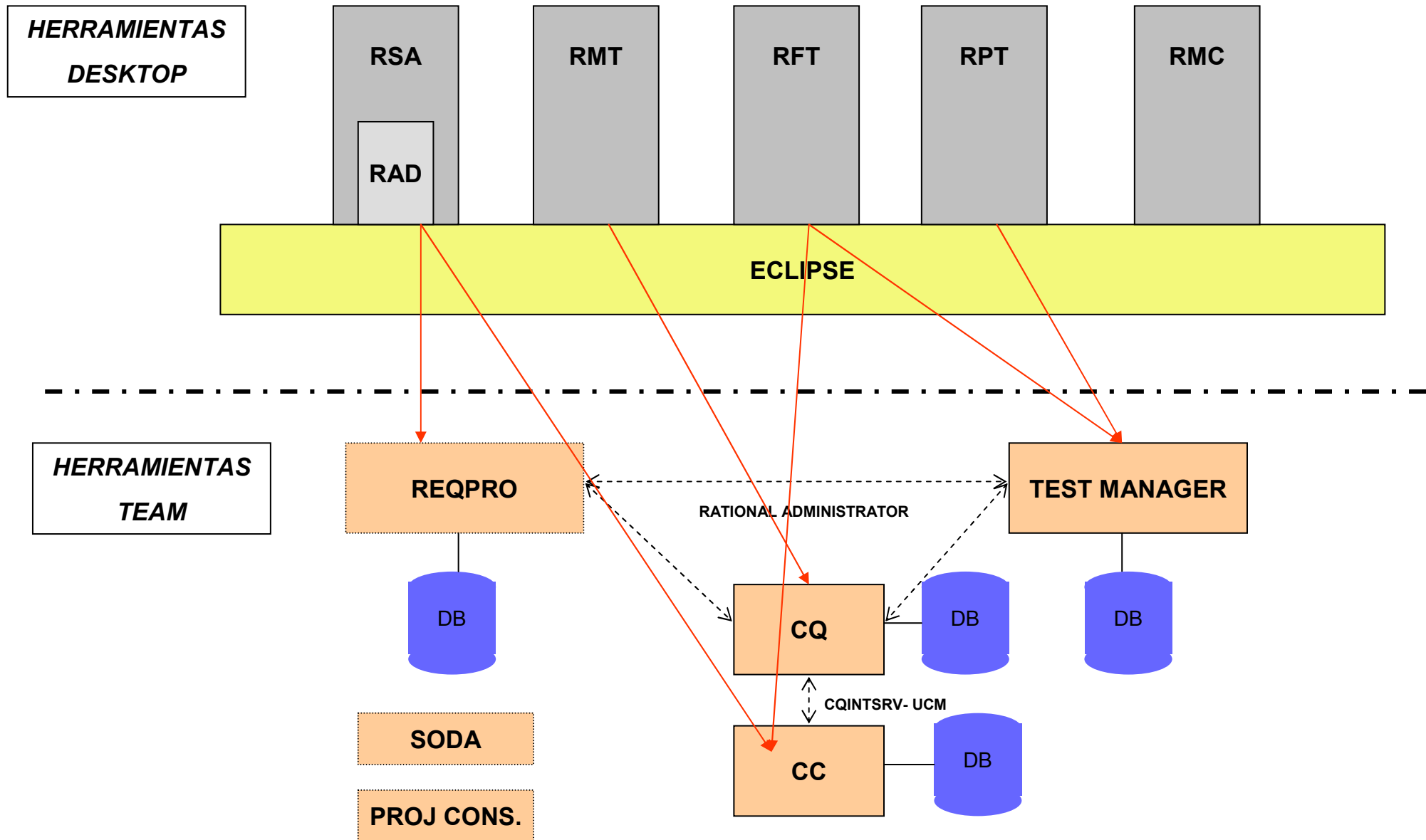

En Jazz la colaboración entre herramientas se realiza a través de servicios proporcionados por un middleware.

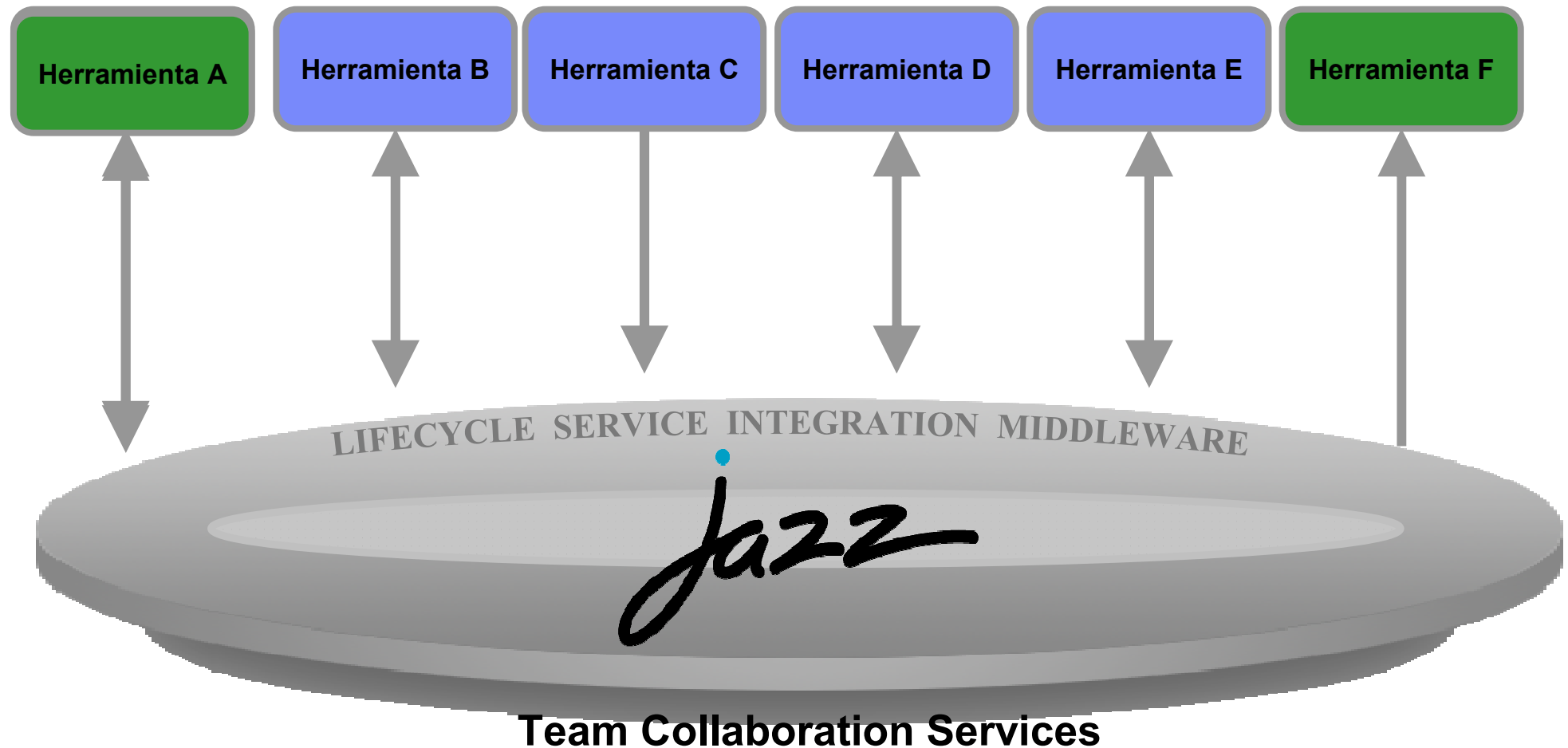

PLATAFORMA JAZZ : JAZZ TEAM SERVER

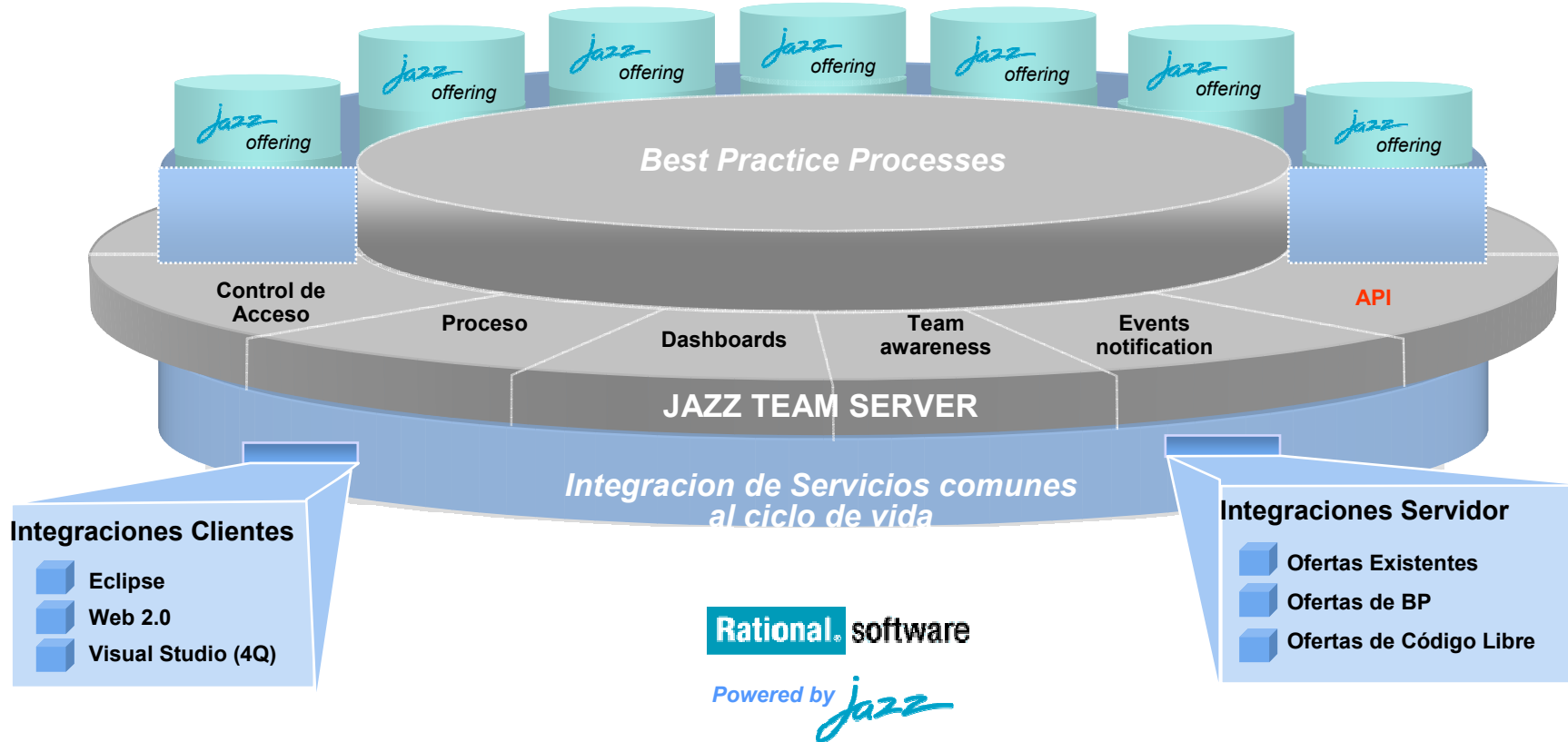

JAZZ es una arquitectura Cliente Servidor

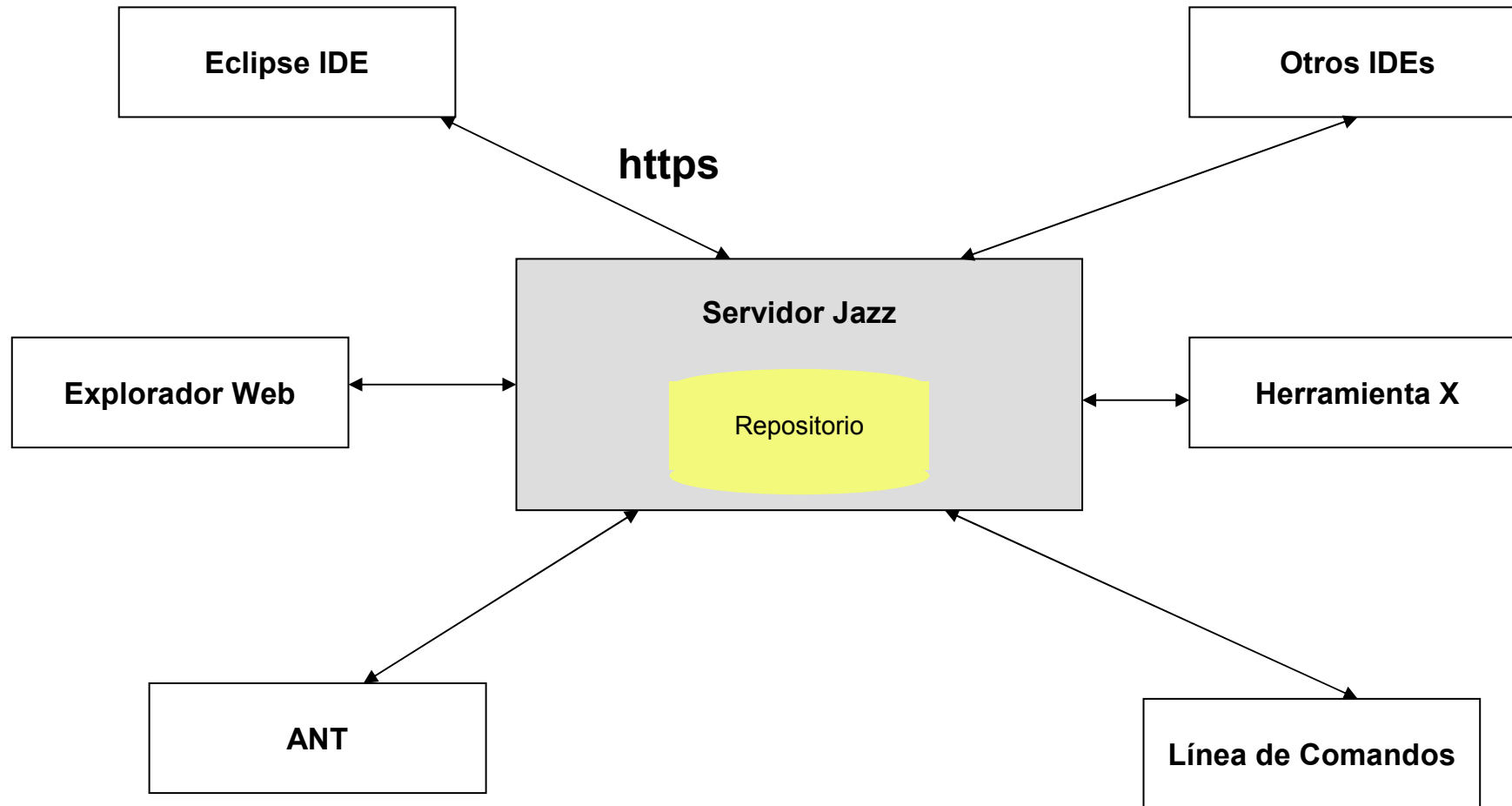

Jazz es una Plataforma Módular : Componente Jazz.

Un componente Jazz proporciona una capacidad relacionada con el ciclo de vida de desarrollo.

ALGUNOS COMPONENTES DE LA PLATAFORMA

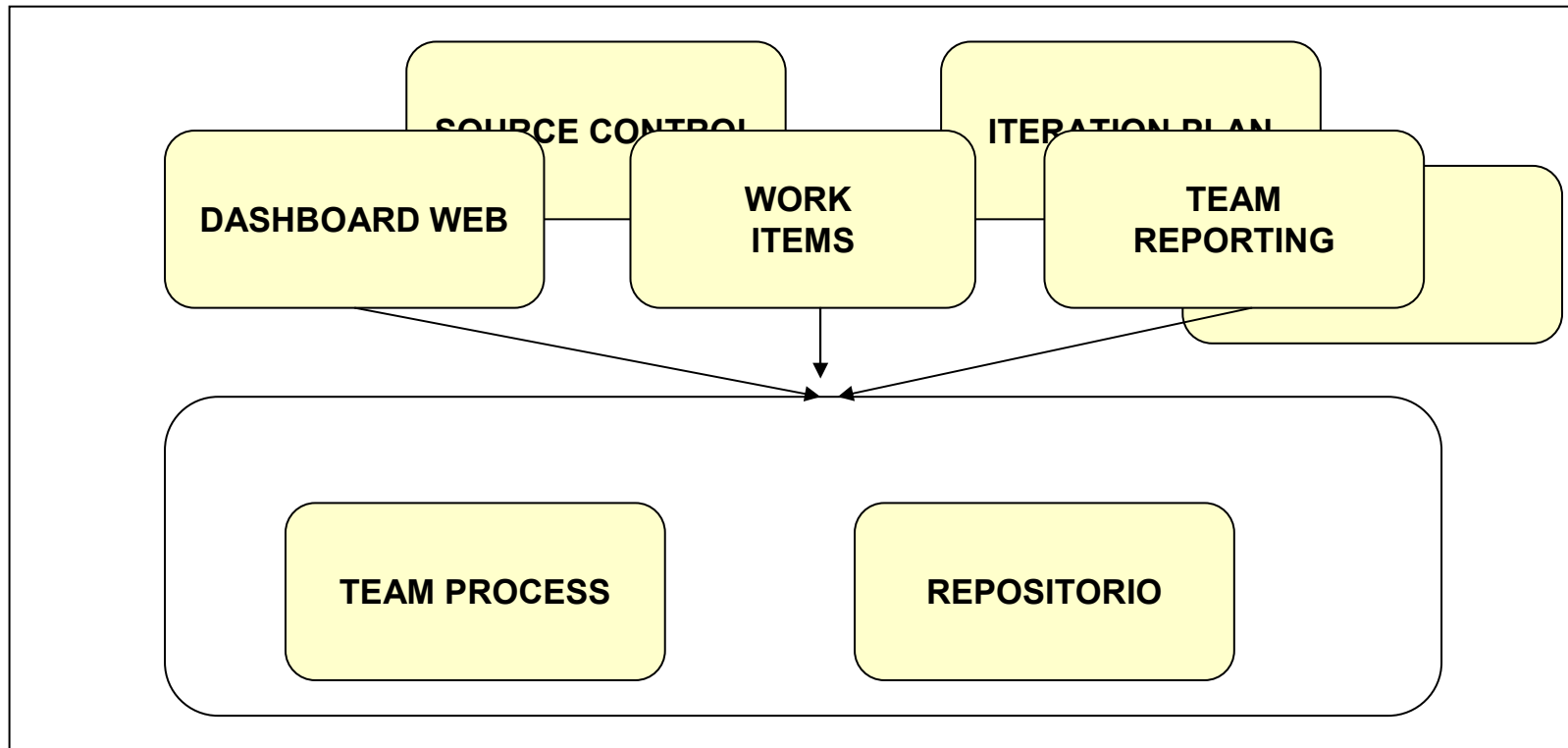

Instalar un componente en el Jazz Server hace que los servicios de dicho componente se encuentren disponibles para su uso.

Instalar el componente en el Jazz Client permite el acceso a los servicios desde el cliente.

Cada producto de Jazz incluye ciertos componentes

COMPONENTES QUE IMPLEMENTA EL QUALITY MANAGER

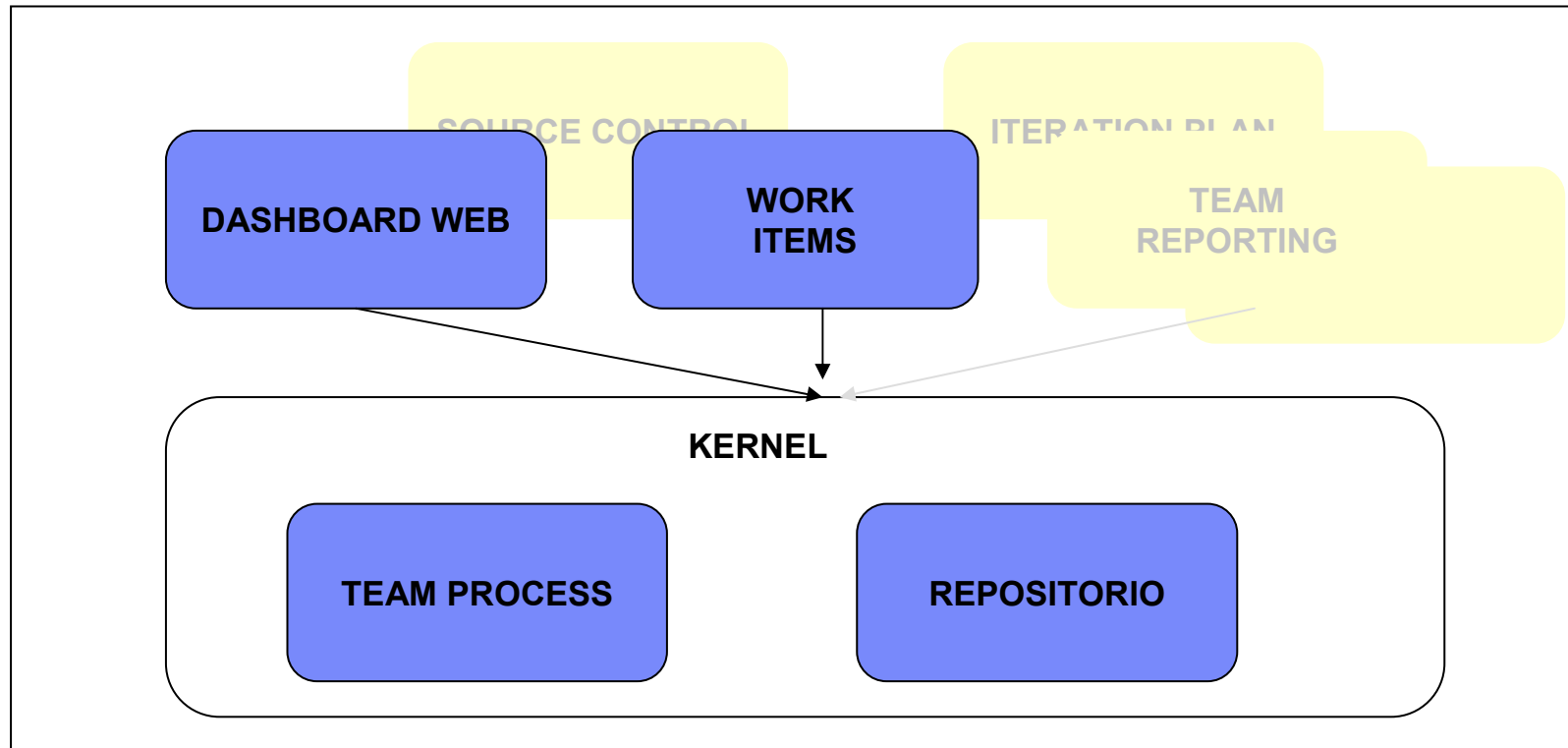

Cada producto de Jazz incluye ciertos componentes

COMPONENTES QUE IMPLEMENTA EL TEAM CONCERT

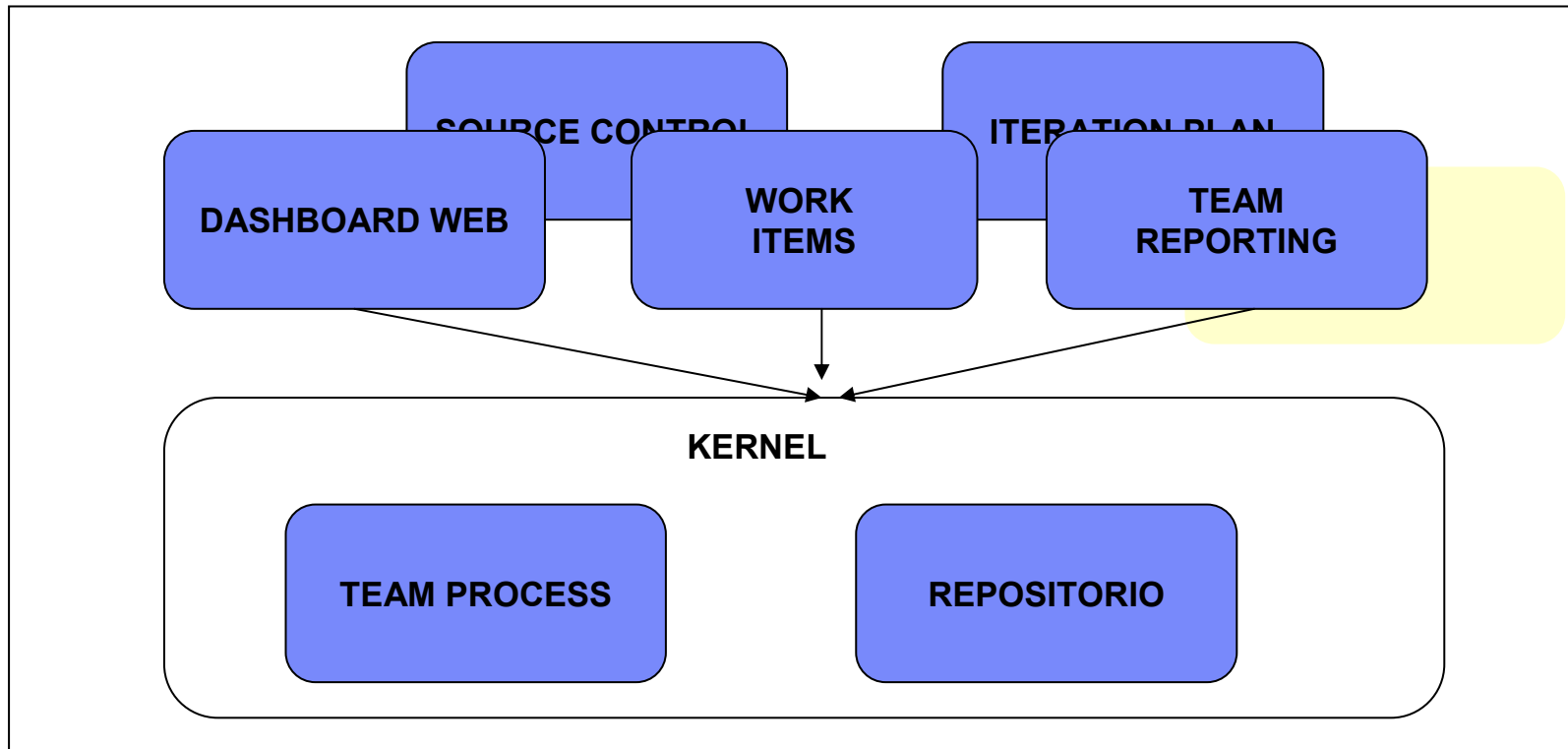

PLATAFORMA JAZZ : JAZZ TEAM SERVER

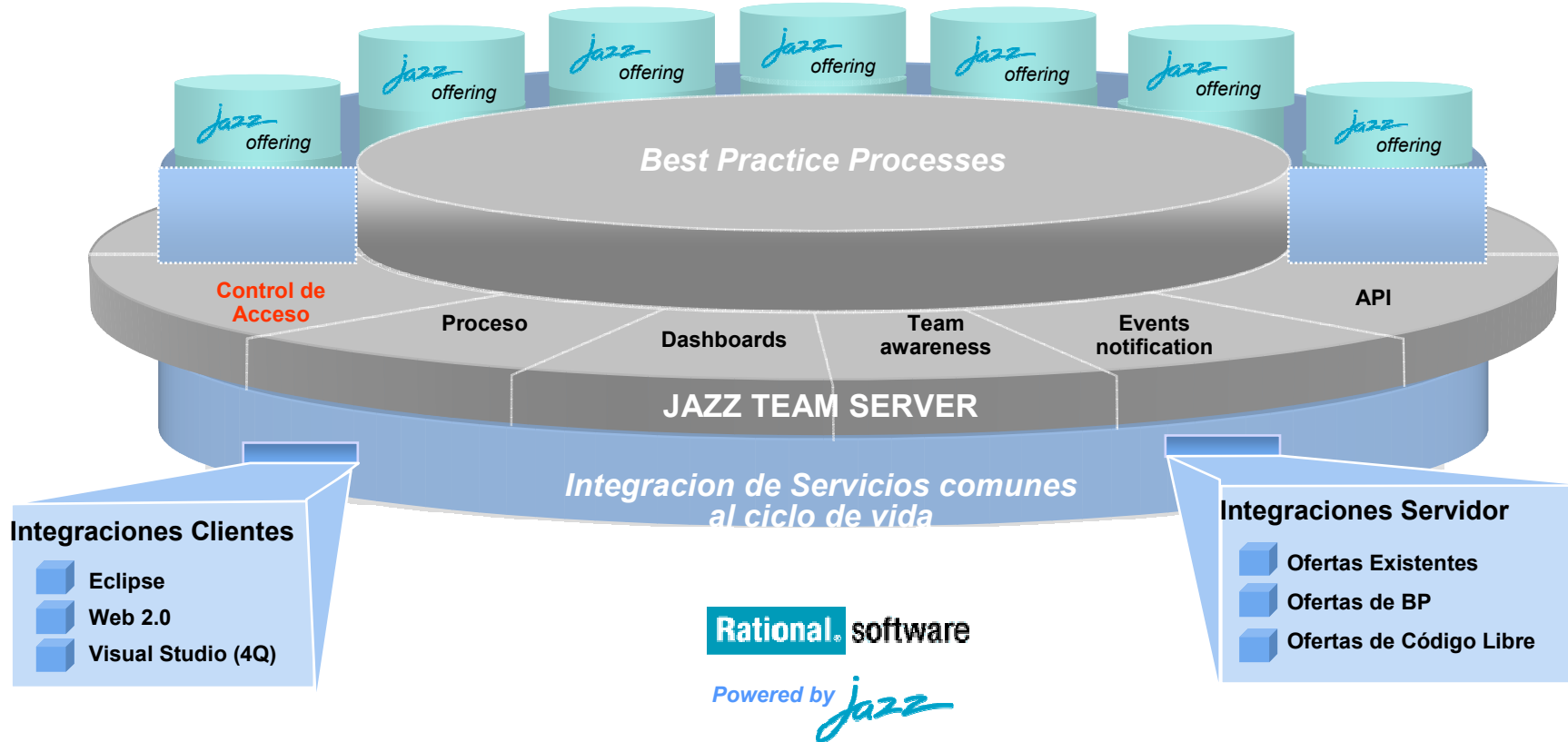

Control de Acceso

- Dos niveles de control de acceso :
 - ▶ Control de Acceso controlado por el servidor de aplicaciones (LDAP)
 - ▶ Control de acceso dentro de la plataforma Jazz.



Niveles organizativos dentro de Jazz

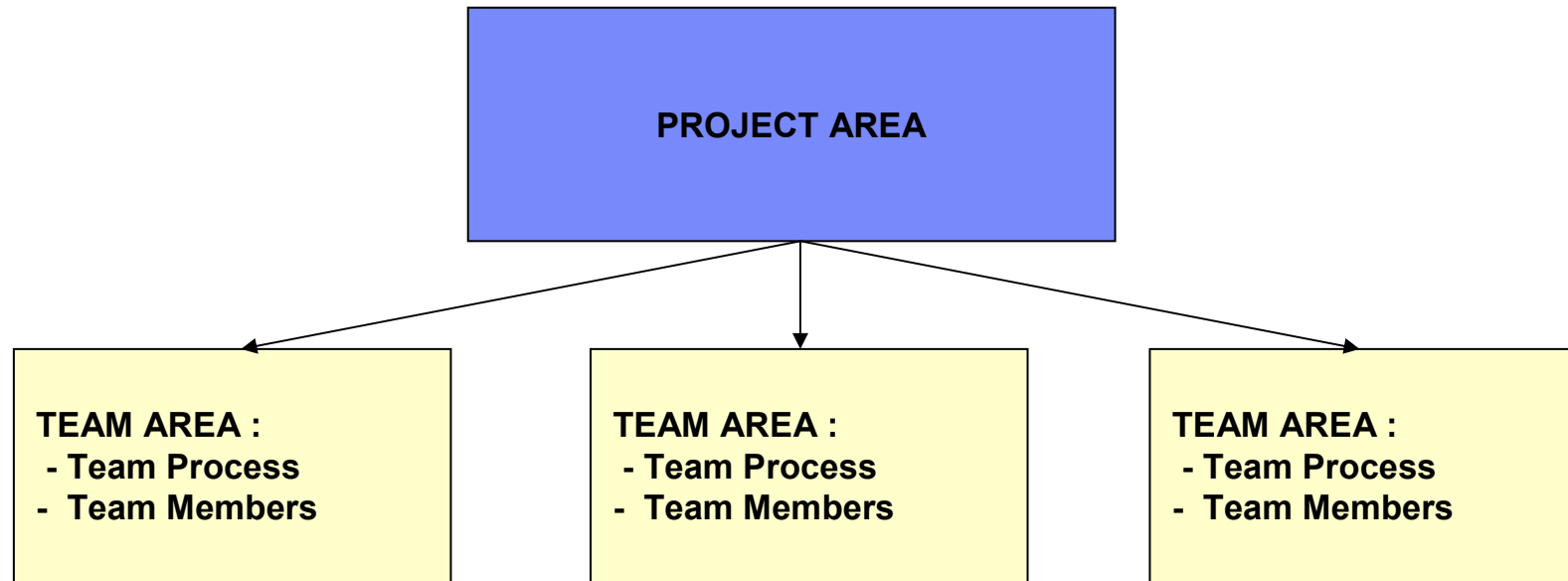

Project Area

The screenshot displays the Rational software interface for configuring a Project Area. On the left, a tree view shows the hierarchy of Team Areas, including Repository Connections, Builds, Build Engines, Plans, Reports, Streams, Work Items, Favorites, Feeds, My Repository Workspaces, My Team Areas, and Work Item History. The main area is titled 'Project Area' and is currently set to 'Squawk'. It is divided into several sections:

- Details:** Contains a 'Summary' field with the text 'Instructional project for user training' and a 'Description' field with the text 'This workshop was created and maintained by the Jazz Jumpstart Team: Jim D'Anjou, Philippe Krief, Paul Vanderlei, Steve Wasleski'.
- Members:** Lists roles and their assignments. It shows a role named 'build' and a user named 'Jery Jazz' with a profile picture. Buttons for 'Add...', 'Create...', 'Remove', and 'Process Roles...' are visible.
- Administrators:** Lists project area administrators. It shows a user with a profile picture. Buttons for 'Add...', 'Create...', and 'Remove' are visible.
- Process Description:** Shows a process flow diagram under the heading 'Eclipse Way Process (In Progress)'. The diagram includes nodes for 'Main Development Line', 'Release 1 [1/15/08 - 12/3]', '1.0 M1 [1/15/08 - 1/2]', '1.0 M2 [1/25/08 - 12/]', 'Development', and 'End Game'. Buttons for 'Edit Properties...', 'Duplicate...', 'Create Line...', 'Create Iteration...', and 'Delete...' are present.

A blue callout box with a pointer to the process flow diagram contains the text: **Definición de planes de iteración**.

Team Areas : Puedo definir control de acceso a nivel de team area.

The screenshot shows the 'Team Area' configuration interface. At the top, there are tabs for 'Squawk', '<untitled>', and 'Core Library'. The main title is 'Team Area' with a dropdown arrow. Below the title, there's a search bar containing 'Core Library' and several links: 'Show in Team Organization', 'Open parent', and 'Open project area'. A 'Save' button is in the top right corner.

The interface is divided into several sections:

- Details:** Contains a 'Summary' text area and a 'Description' text area.
- Members:** Includes a text box with explanatory text: 'Roles determine a user's permissions as well as any preconditions and follow-up actions that are run for team operations. The roles assignments below are also valid in all child team areas. Unless configured otherwise, all users in the repository play the 'default' role.' Below this is a table with columns 'Name' and 'Process Roles', and buttons for 'Add...', 'Create...', 'Remove', and 'Process Roles...'.

Name	Process Roles
<input type="checkbox"/> April Blues	contributor
<input checked="" type="checkbox"/> Jerry Jazz	contributor, teamlead
<input type="checkbox"/> Zara Intern	contributor
- Development Line:** Contains a text box with 'Main Development Line [inherited]' and a 'Browse...' button. Below it, it says 'Process: customized' and 'Description: inherited'.
- Artifacts:** A list of artifact types with expandable icons: Builds, Feeds, Plans, Work Items, Reports, and Streams.
- Administrators:** A section at the bottom left with a dropdown arrow and a small icon.
- Attachments:** A section at the bottom right with a dropdown arrow.

PLATAFORMA JAZZ : JAZZ TEAM SERVER

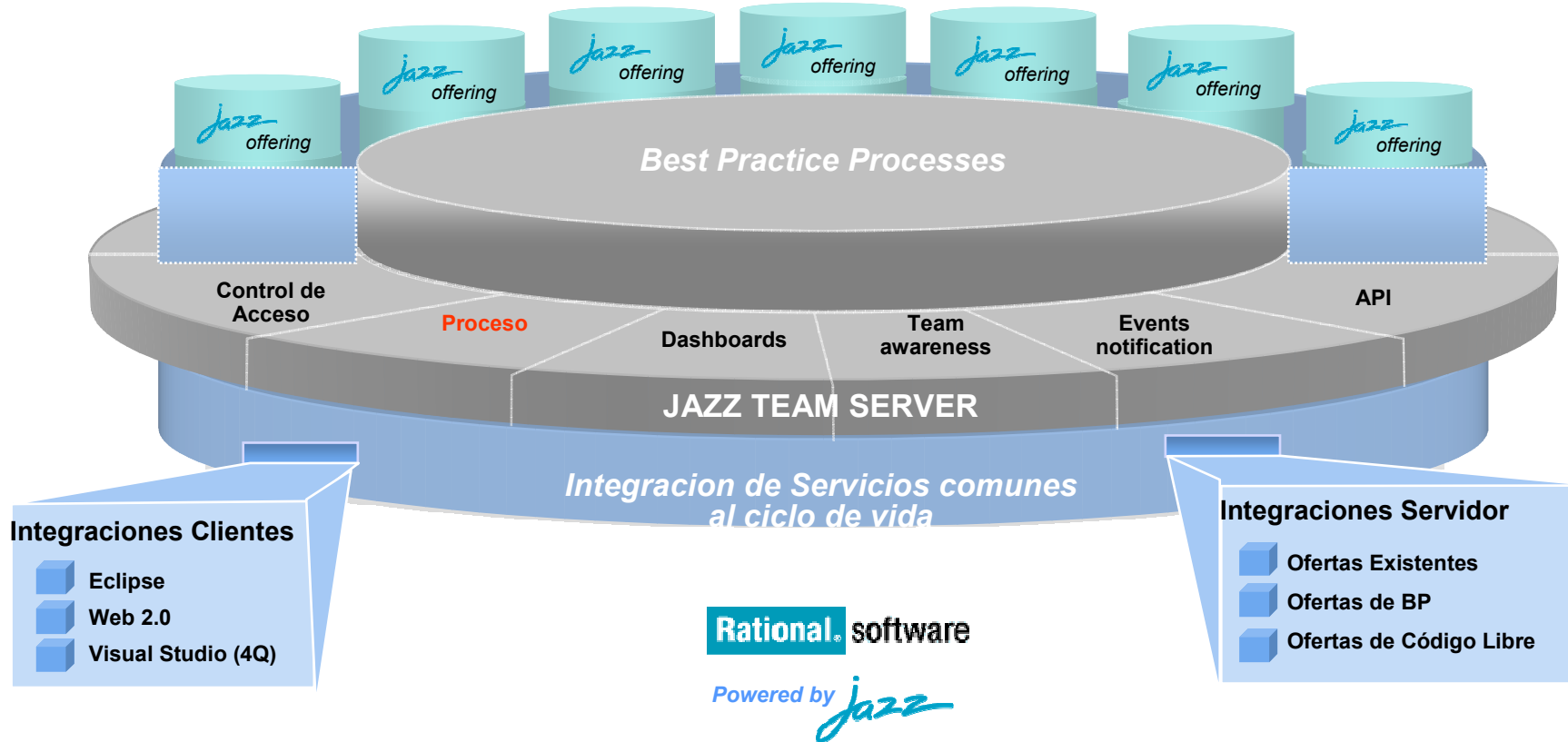

Process Editor

Definición de roles

Control del Comportamiento basandose en Roles.

Modificación de permisos

Definición de proceso en cada línea de desarrollo

Actions	contributor	teamlead	default
Process			
Generate Team Invitation (server)	✗	✗	✓
Save Team Area (server)	✗	✓	✗
<Uncategorized>			
Abandon Build (server)	✓	✓	✗
Cancel Pending Build Request (server)	✓	✓	✗
Control The Build Lifecycle (server)	✗	✓	✗
Create Private Component (server)	✗	✗	✓
Create Repository Workspace (server)	✗	✗	✓
Delete Build Definition (server)	✗	✓	✗
Delete Build Engine (server)	✗	✓	✗
Delete Build Result (server)	✗	✓	✗
Delete Iteration Plan (server)	✗	✓	✗
Delete Query (server)	✓	✗	✗
Deliver (server)	✓	✗	✗
Deploy Report (server)	✓	✗	✗
Deploy Report Template (server)	✓	✗	✗
Display Report (server)	✗	✗	✗
Manage Report Folder (server)	✓	✗	✗
Request Build (server)	✓	✓	✗
Save Build Definition (server)	✗	✓	✗
Save Build Engine (server)	✗	✓	✗
Save Build Result (server)	✓	✗	✗
Save Component (server)	✗	✓	✗
Save Iteration Plan (server)	✓	✗	✗
Save Query (server)	✓	✗	✗

Automatización de proceso y Guías.

■ Team Advisor

- Definición de reglas a ejecutar después de una acción.
- Reglas configurables.
- “Quick Fixes”
- Las reglas pueden ser definidas dinámicamente permitiendo la mejora constante.

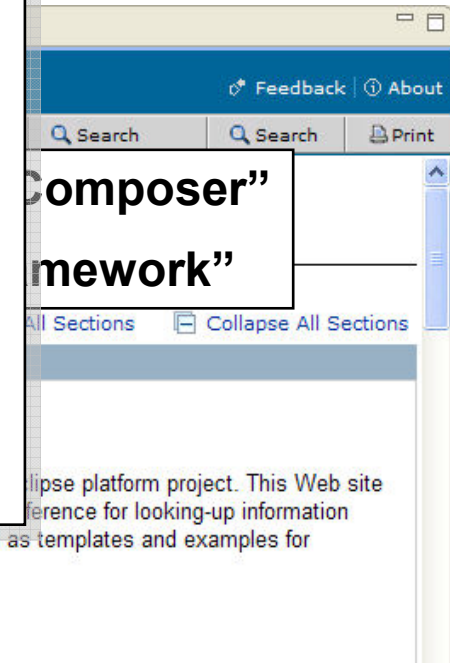

around practices and development methods. It provides check lists for performing tasks as well as templates and examples for artifacts.

Quick Index

Use this Quick

Learning

- The Eclip
- The Eclip
- Basic Gu

Detailed F

Team Advisor

Deliver (1 error) [client] 11:38:49 A

- No Unused Imports
- Clean Workspace
- Descriptive Change Sets
- <No Description>

Change set missing required comment or work item.

Change set missing required comment or work item.

Quick Fix:

- [Associate Existing Work Item](#)
- [Associate New Work Item](#)
- [Associate and Try Again \(experimental\)](#)

PLATAFORMA JAZZ : JAZZ TEAM SERVER

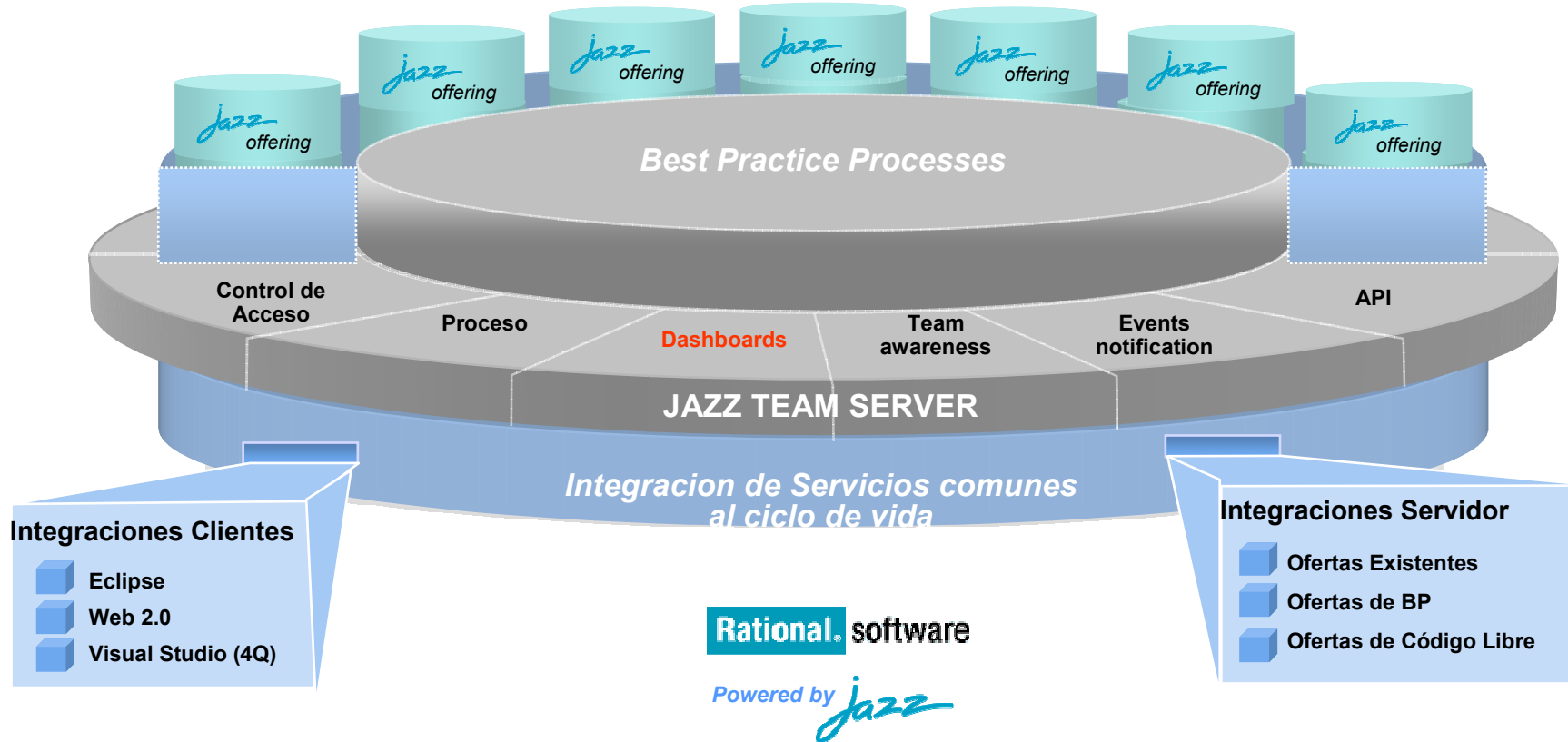

Dashboard

Estado del proyecto en un vistazo

Reports en tiempo real

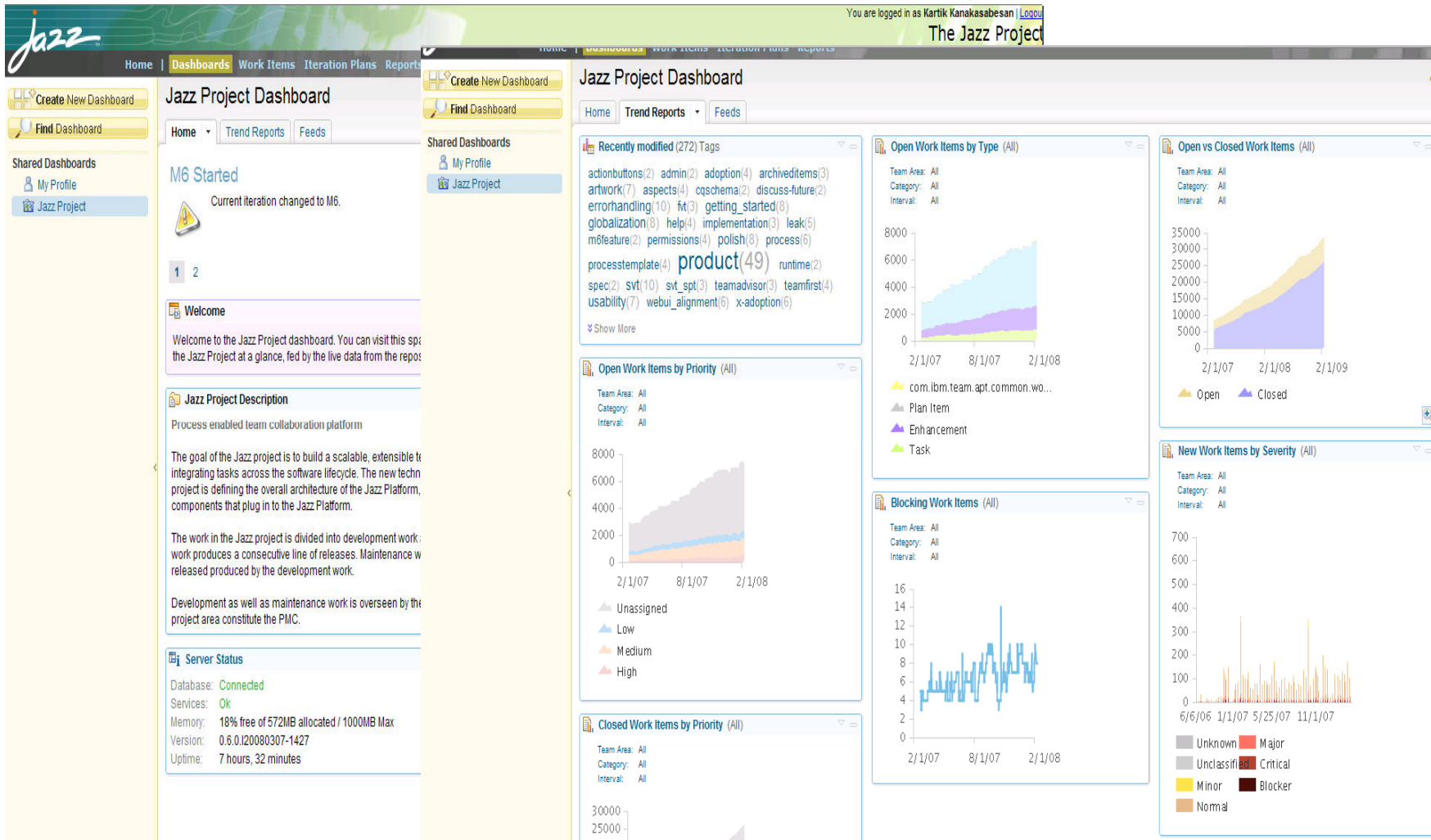

PLATAFORMA JAZZ : JAZZ TEAM SERVER

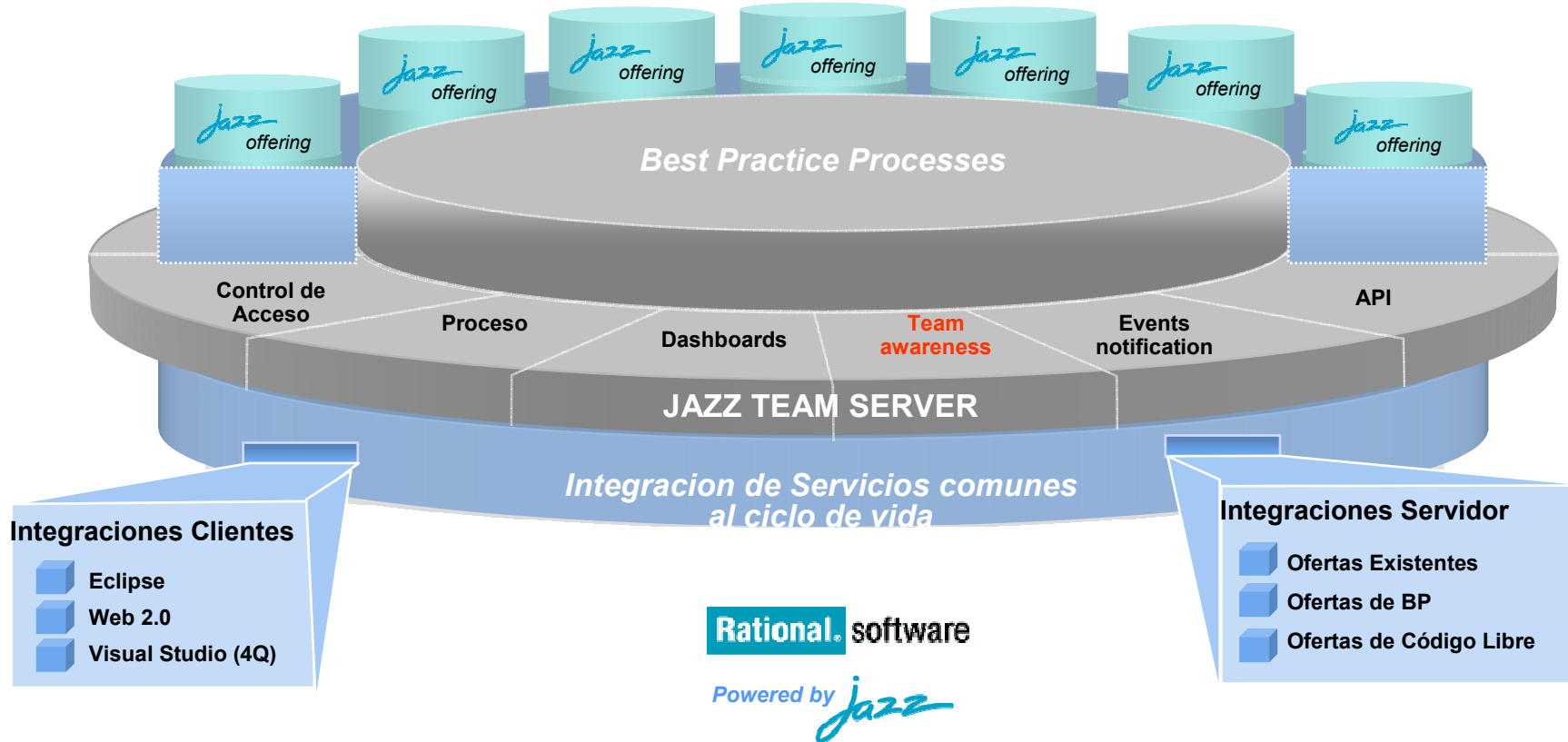

Team Awareness : Qué es lo que pasa en el equipo?

The screenshot displays the IBM Rational software interface, specifically the 'Team' workspace. The main area shows a 'Story 45274' with a progress bar (11% to 89%), creation date (Feb 22, 2008), and owner (Kevin Haaland). A context menu is open over the 'Owned By' field, with 'Chat...' selected. To the right, a chat window titled 'Kevin (K.G.) Haaland' is visible, showing a conversation about the story. The left sidebar contains various team-related views like 'Team Load' and 'My Open Work Items'.

Team Awareness

- Mostrar los miembros del equipo y su estado.
- Mostrar en qué están trabajando.

PLATAFORMA JAZZ : JAZZ TEAM SERVER

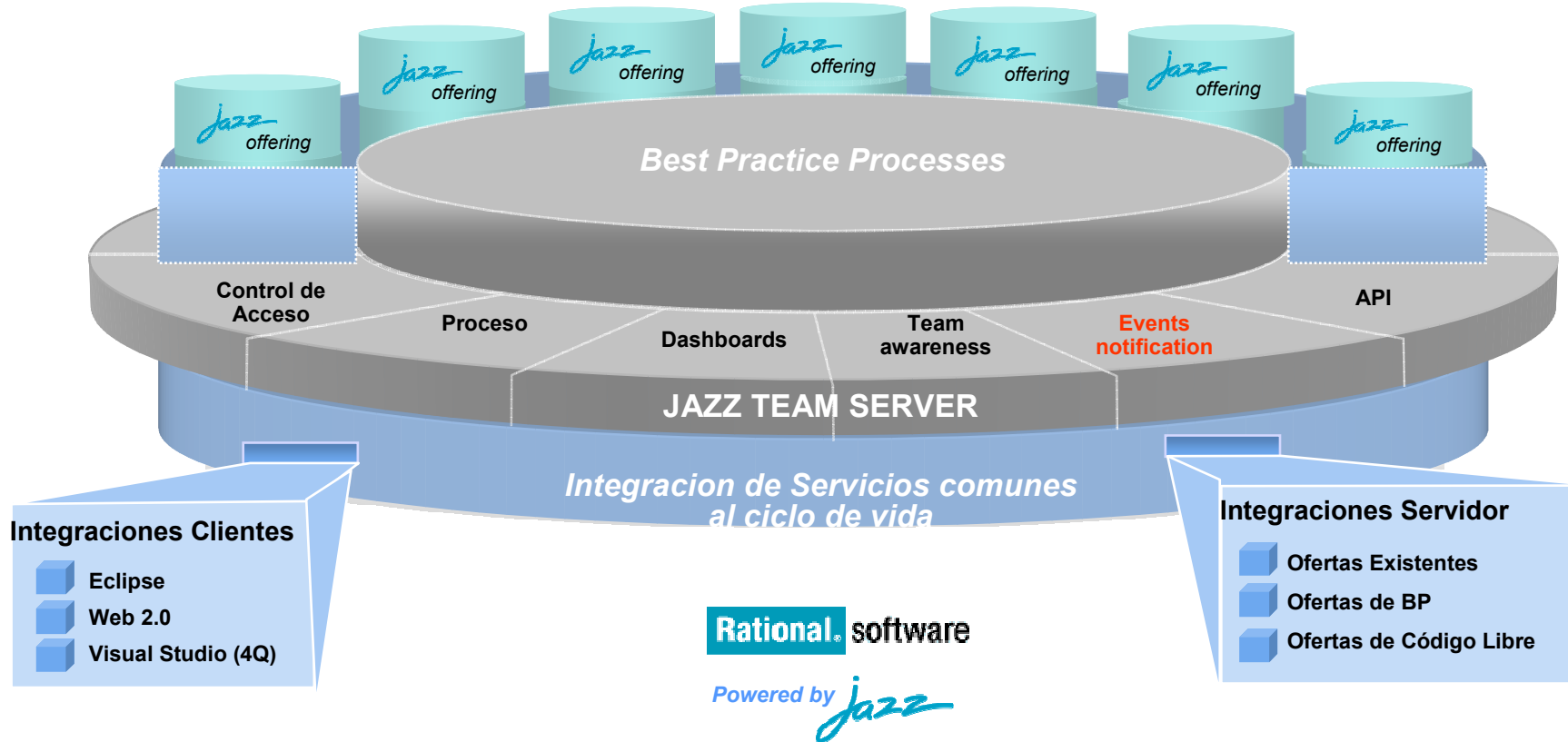

Event notification

1. Jazz registra todos los eventos que van ocurriendo.
2. Los eventos refrescan las vistas dinámicamente .

The screenshot displays the IBM Jazz web interface with several views:

- News (48 unread):** A list of news items including "Gorkem Ercan: Eclipse moment of competitio...", "Litrik De Roy: Dark side of the moon Jun 04", "Nick Boldt: Managing Plugins and Features v...", "Adam Cabler: Anti-Alias bug in 3.3 with GEF", "Birt World: BIRT Release Candidate 0 New a", and "Ian Skerrett: Euronova is a Global Effort Jun 0".
- Team Load:** A section for "Jazz Development, current [0.6 M6]" showing work time left and estimated progress for team members. Two members are shown with "No Work Time Left", "Hours: 0 / 0", and "Estimated: 0%".
- My Open Work Items:** A bar chart titled "By Priority (4:07 PM)" showing 3963 total items. The bars represent: Unassigned (3963), Low (282), Medium (531), and High (111).
- New Incoming Work Items:** A bar chart titled "By Severity (4:05 PM)" showing 3159 total items. The bars represent: Unc... (20), Minor (177), Normal (3159), Major (181), Critical (19), and Blocker (4).
- Event Log:** A list of events titled "Events (113 unread)". The first event is "[9] Outgoing synchronization error (Workt...". Other events include "[4] Improvements to QCert reports (46379)", "[6] Visual Studio .NET integration (26709)", "[8] repotools error - unable to verify or cre", "[3] Scope and planning for VS client (456:", and "[3] Obscure error messages when the serv".

The Event Log section is highlighted with a red border in the original image.



Oferta sobre Jazz : Legacy hacia Jazz y nuevos productos en Jazz

La evolución de la IBM Rational Software Delivery Platform

Ofertas Existentes

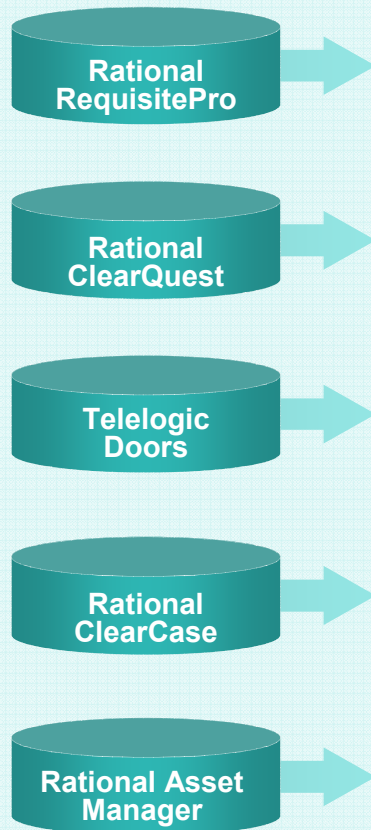

Oferta en Jazz

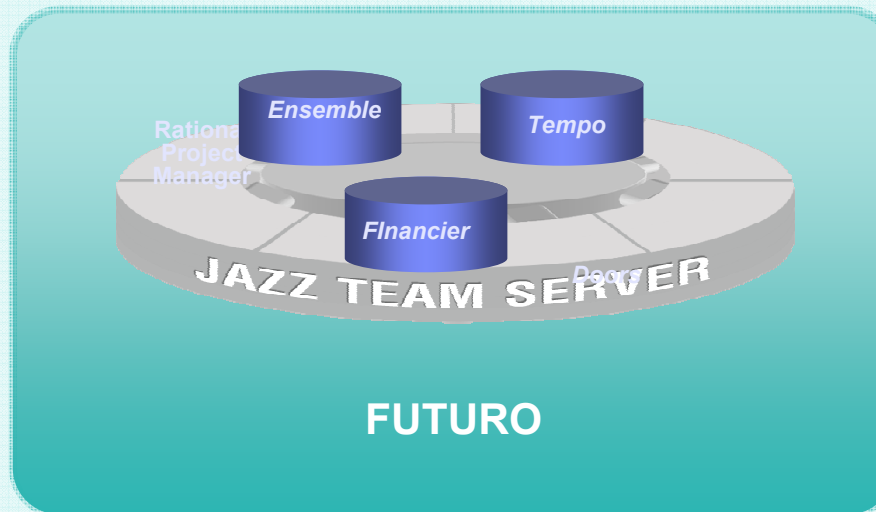
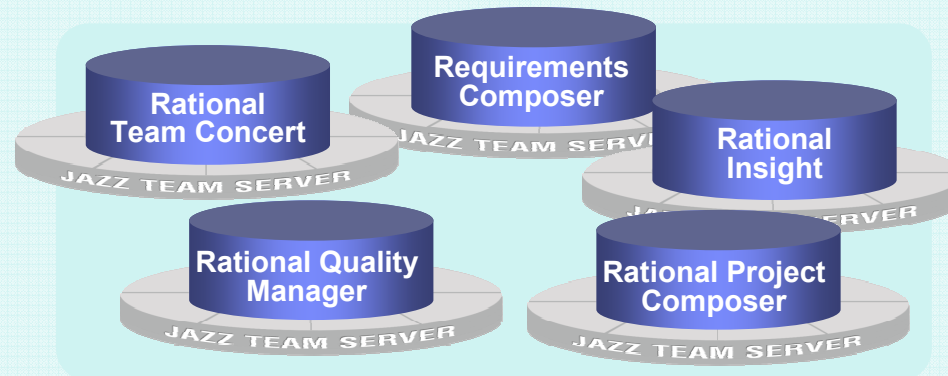

IBM Rational Team Concert

Oferta nueva sobre Jazz.

- Gestión de Configuración
- Gestión de Cambio
- Seguimiento de proyecto
- Gestión de Builds

Open and extensible on



- ✓ Collaborate in context
- ✓ Right-size governance
- ✓ Day one productivity

IBM Rational Team Concert



transparent *integrated presence*
 wikis OPEN real-time
 reporting chat automated hand-offs
 Web 2.0 *custom dashboards*
 automated data gathering **EXTENSIBILITY**
Eclipse plug-ins services architecture
FREEDOM TO CREATE

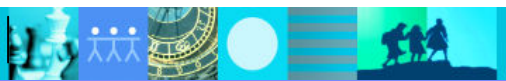

Rational Team Concert

Plan de iteraciones

- Sistema de iteraciones integrado.
- Estimaciones ligadas a los hitos.
- Procesos out of the box

Portal de Proyecto

- Personalización de dashboards
- Métricas y reportes en tiempo real.
- Seguimiento de Proyecto.

SCM

- Gestión de líneas de trabajo paralelas.
- Baselines a nivel componente.
- Identificación de componentes y baselines.

Tareas

- Defectos, peticiones de mejora y conversaciones.
- Consultas y compartición de consultas.
- Soporte para aprobaciones y discusiones.
- ClearQuest connector
- Editor de consultas.

Build

- Trazabilidad con Work item y change set.
- Build servers remotos o locales.
- Soporte para ant y linea de comandos.
- Integración con build forge
- Definición de Builds

Jazz Team Server

- Estructura para los artefactos de proyecto.
- Acceso inmediato a proyectos por miembros, equipos, etc.
- Control de acceso orientado a roles y control de proceso.

- Team advisor para la definición de reglas permitiendo la mejora constante.
- Definición y seguimiento de proceso.
- Colaboración contextual.



Rational Quality Manager

Gestión de la Calidad para la Empresa

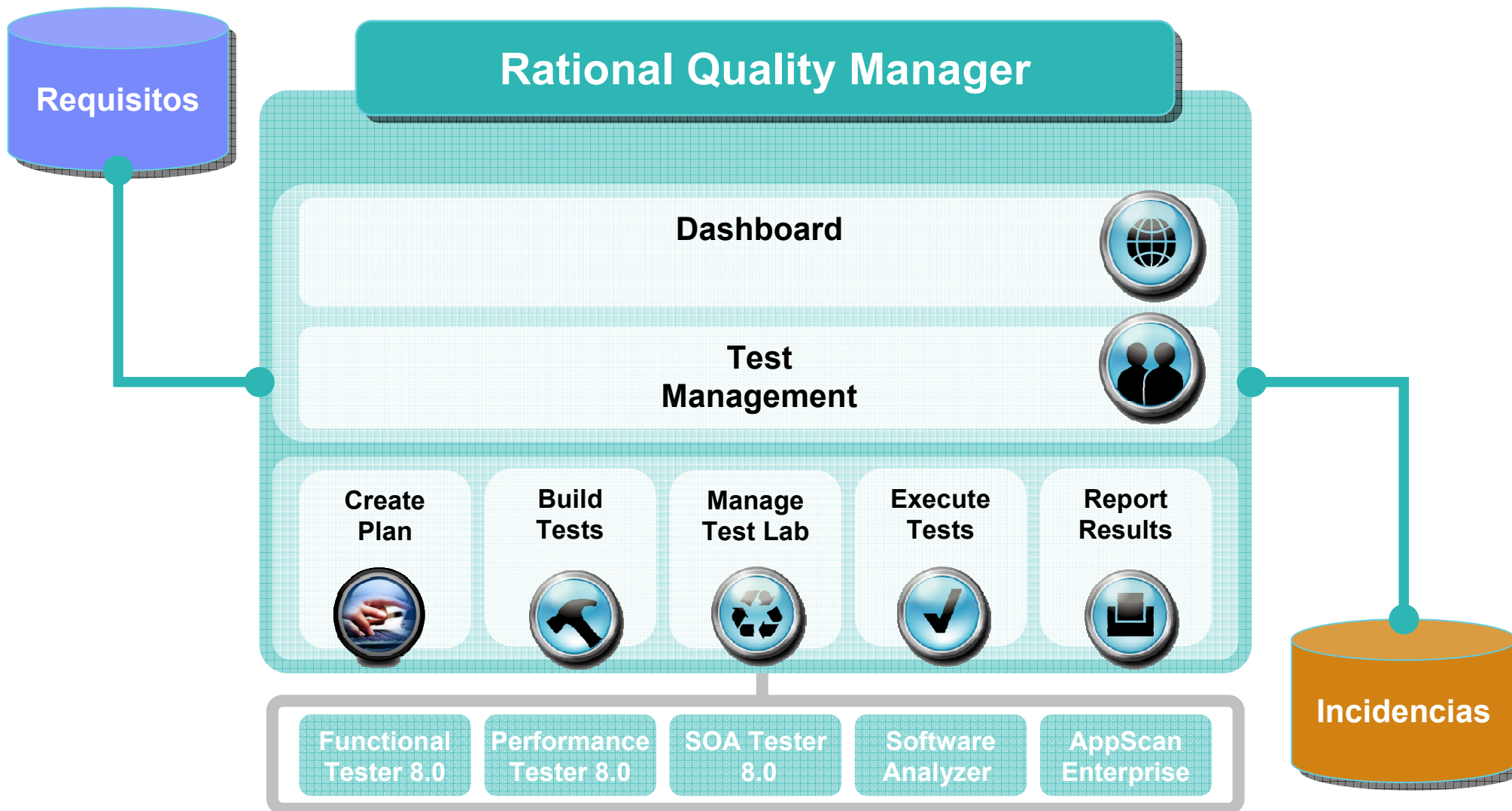

Testing a nivel corporativo.

Desde el test plan hasta los resultados..

Gestión de la Calidad : Quality Manager

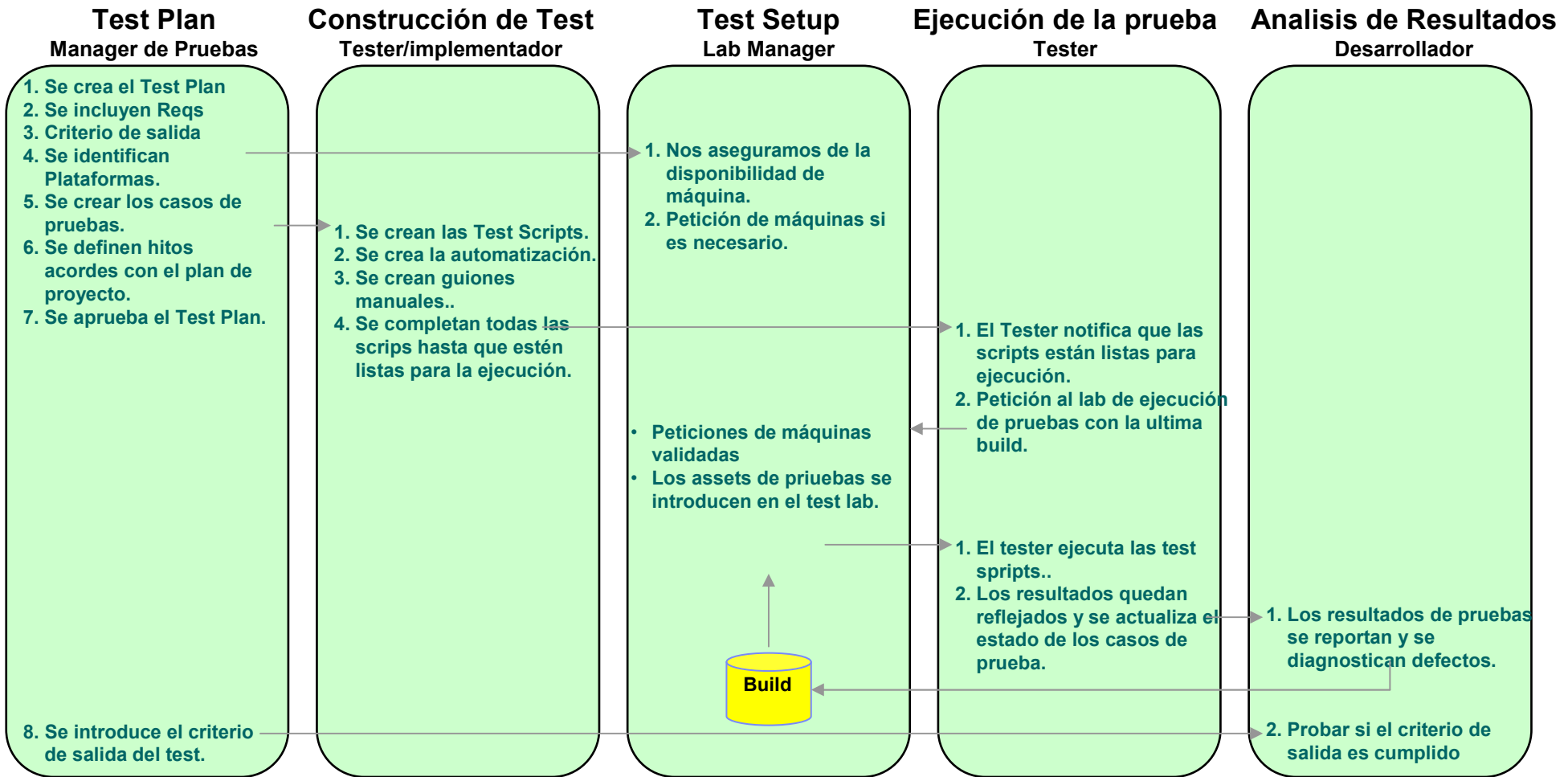

Quality Manager : Interface WEB

Mozilla Firefox
 File Edit View History Bookmarks Tools Help
 Getting Started Latest Headlines
Rational Quality Manager Welcome **Katie** | Project 001 Sign Out
 Home Planning Construction Lab Management Execution Analysis Help
 Configure this page

Katie's Home

My Tasks

Newly Assigned (3 Items)

- Verify Build Verification test
- Review Properties Test Case
- Create GUI Install Test Plan

Today (3 Items)

- Complete Project ABC Test Plan
- Review Properties Test Case
- Complete GUI Install Test Plan

Future (1 Item)

- Review Lab Quality Test

Event Log View all

- Build 0986 has successfully finished 30 min ago
- Machine 0892-x2 has been reserved 1 h 20 min ago
- Build 0985 is ready 5 h ago
- Build 0984 is ready 10 h ago
- Machine 098-Linux has been reserved Yesterday, 10:00 PM
- Build 0983 encountered errors Nov. 12, 1:20 PM
- Build 09261 is ready Nov. 10, 10:00 AM
- Reservation expired for Machine Sierra Nov. 5, 1:00 PM
- Build 98142 encountered errors Nov. 5, 10:00 AM

Team Load

- Katie Testlead** (20 Items Assigned, 10 Complete) **Behind**
- Ted Tester** (13 Items Assigned, 10 Complete) **On Time**
- Terry Tester** (15 Items Assigned, 10 Complete) **Behind**
- Uma Requester** (21 Items Assigned, 16 Complete) **On Time**

Overall Progress

Test Case Points

- Projected Complete
- Projected Attempted
- Actual Complete
- Actual Attempted

Milestone

Project ABC Milestone 4 Start: Nov. 15, 2007 Target End: Dec. 31, 2007 **Behind**

Rational Requirements Composer

Entorno de identificación y construcción de requisitos

Requisitos en texto

Glosarios

Prototipado de GUI

Prototipado de Proceso

Revisión y aprobación vía web

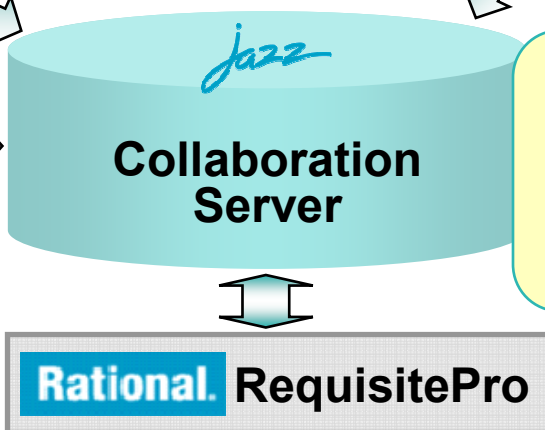

- Compartir trabajo instantaneo.
- Control de acceso.
- Versioneado.
- Revisión y ciclo de Aprobación

Rational Insight

Métricas y Reporting

- Capacidades avanzadas de Business Intelligence en la comunidad de desarrollo de software.
- Información en tiempo real del proceso de desarrollo.
- Acceso y explotación a todo los datos relevantes al desarrollo.

Scorecards & Dashboards

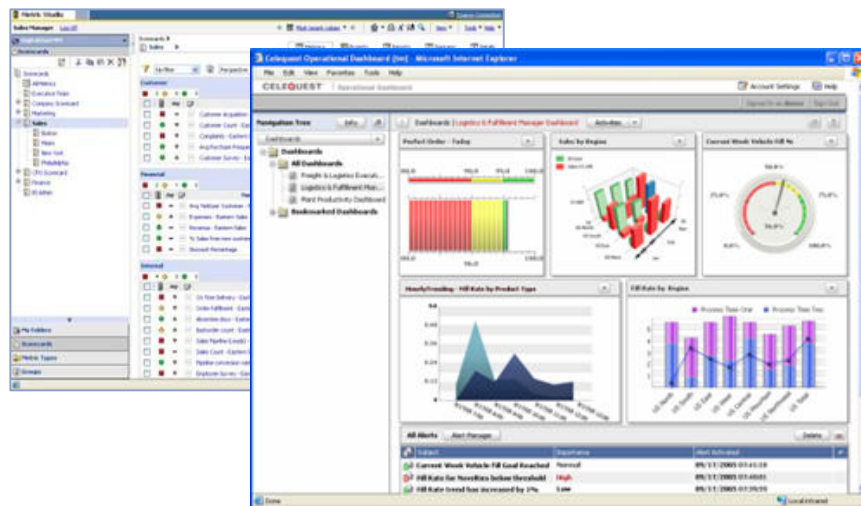

Reporting & Analysis

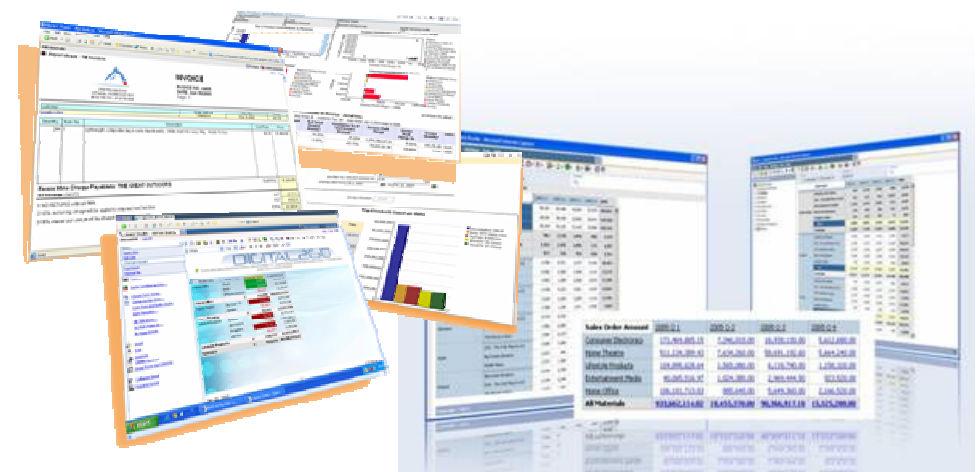

Rational Project Composer : Gestión de Proyecto en Jazz

The screenshot displays the Rational Project Composer web application interface. The browser window title is "EPM - Rational Enterprise Project Management - Mozilla Firefox: IBM Edition". The URL is "https://9.124.18.203:9443/jazz/epmWeb/projects/Tara#action=com.ibm.epm.web.core.viewEPMPage&id=_aH". The application header shows "Rational Focal Point for Project Management" with a trial license expiration of 49 days for user RICHARD KNASTER. The main navigation includes "Main", "Admin", "Reports", "Create View", and "Help".

The interface is divided into several sections:

- Left Sidebar:** Contains a "Create Program" button, a "Work Breakdown" section, and a "Programs and Projects" list with expandable items like "Run the Business", "Grow the Business", "Transform the Business", and various "Program_8" through "Program_28" entries.
- Main Content Area:** Features a "Main" tab with sub-tabs for "General", "Overview", "Schedule", "WBS Details", "Resources", "My Timesheet", "Approver Timesheet", "Risk", and "More". The "Schedule" tab is active, showing a "Schedule Gantt" view with a table and a corresponding Gantt chart.

The "Schedule Gantt" view includes a table with the following data:

Start Date	Finish Date	Duration [d]	Effort [h]
4/11/09	11/30/09	234	3016
6/12/08	5/12/10	700	4008
4/1/09	4/1/09	2	16
12/31/69	12/31/69	0	0
5/26/09	5/26/09	0	0
12/31/69	12/31/69	0	0
12/31/69	12/31/69	0	0
4/21/09	5/5/09	27	216
3/26/09	6/30/09	97	776
4/27/09	5/1/09	5	0
1/1/09	12/31/09	757	6723
5/26/09	5/26/09	0	0
5/1/09	5/29/09	29	32
3/7/09	6/30/09	406	3248
4/6/09	9/30/09	177	944
12/31/69	12/31/69	0	0

The Gantt chart below the table visualizes these tasks as horizontal bars across a timeline from November to May. The "Timescale" is set to "Year".

The Foundation of Collaborative ALM

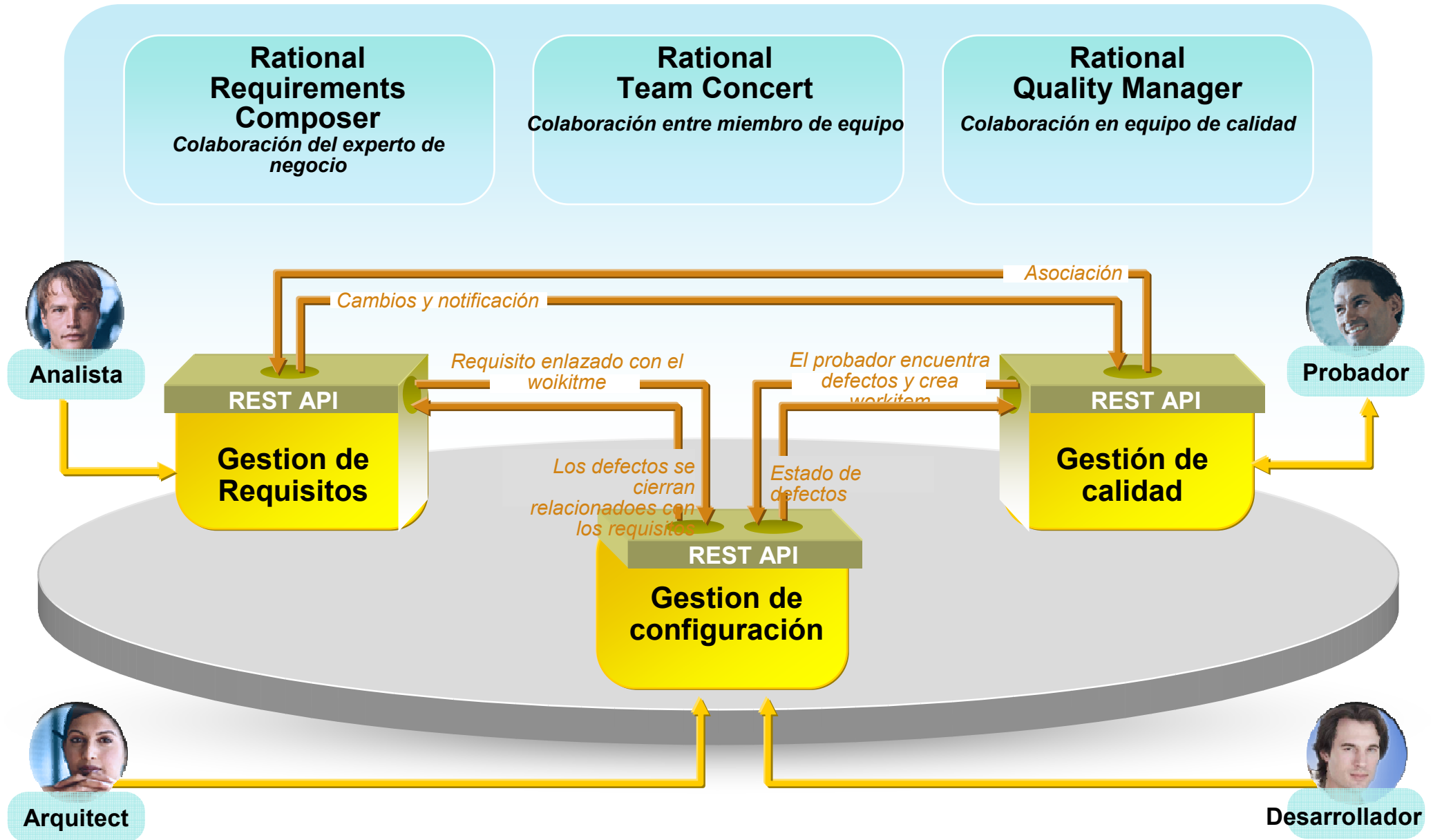

Ventajas y Beneficios Jazz

■ Arquitectura.

- ▶ Habilita trabajo remoto en **centros dispersos geográficamente y en factorías.**
- ▶ **Integración** en una plataforma común.
- ▶ **Extensible y abierta.**

■ Operativa del desarrollo.

- ▶ Entorno **colaborativo** de desarrollo completo y eficiente.
- ▶ Estandarización del proceso de desarrollo. **Adaptación a cualquier metodología.**
- ▶ Reducción de actividades de puesta en marcha de proyectos.

■ Gobierno y métricas.

- ▶ Obtención de un marco de gobierno del desarrollo.
- ▶ Obtención inmediata de **dashboards.**

