

IMS Trends and Directions



IMS - Simply the Best

Bob Gilliam
IMS Product Manager

2002 IMS Technical Conference

35 Years and still leading the industry !!!

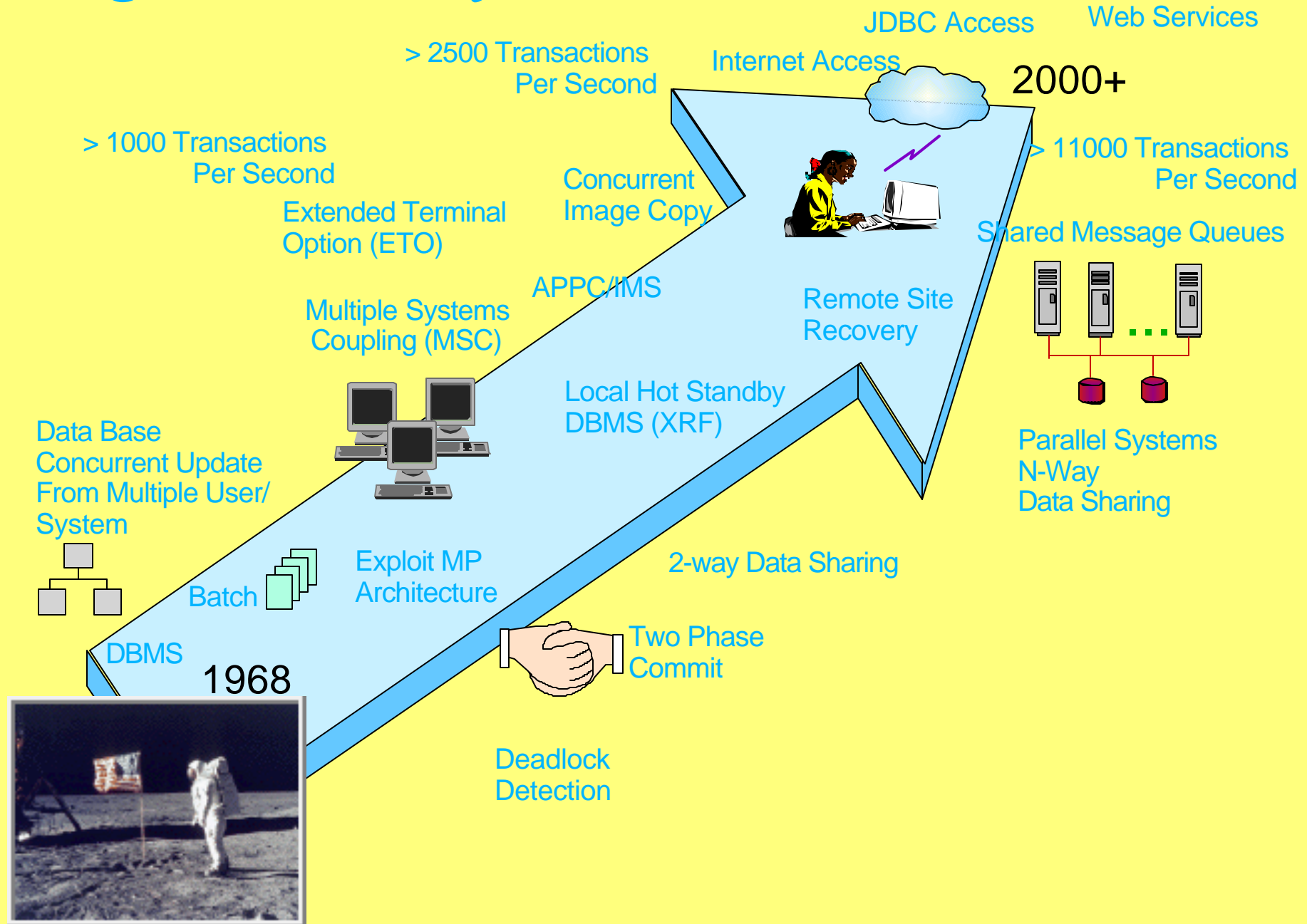



IMS: The World Depends on it

- **2 yr IMS Mips Growth +28%**
- **DM Tools +38% Growth**
- **Greater than 1300 customers in IMS V7 production ***
- **2002 Revenue Growing**
 - Version to version upgrades
 - New license growth

*IMS V7
Fastest in
Customer
Acceptance*

IMS V7 License Growth

*Highest in
Customer
Satisfaction*

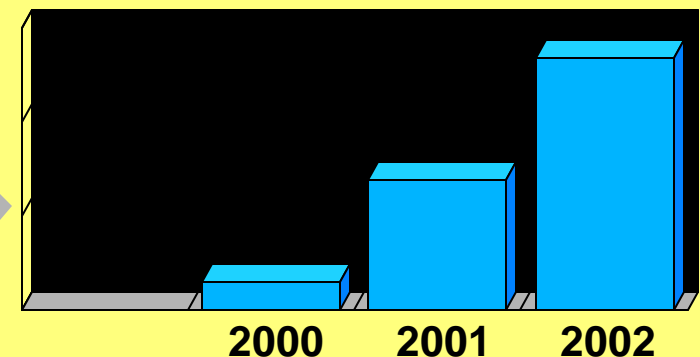

IMS Runs the World...

■ **Most Corporate Data is Managed by IMS**

- **Over 95% of Fortune 1000 Companies use IMS**
- **IMS Manages over 15 Billion GBs of Production Data**
- **\$2.5 Trillion/day transferred through IMS by one customer**

■ **Over 50 Billion Transactions a Day run through IMS**

- **IMS Serves Close to 200 Million Users a Day**
- **Over 100 Million IMS Trans/Day Handled by One Customer**
- **120M IMS Trans/day, 7M per hour handled by one customer**
- **6000 Trans/sec across TCP/IP to single IMS**
- **11,700 Trans/sec (over 1 Billion/day) with IMS Data/Queued sharing on a single processor**

■ ***Gartner Group:*** "A large and loyal IMS installed base. Rock-solid reputation of a transactional workhorse for very large workloads. Successfully proven in large, Web-based applications. IMS is still a viable, even unmatched, platform to implement very large OLTP systems, and, in combination with Web Application Server technology, it can be a foundation for a new generation of Web-based, high-workload applications."

IBM zSeries - Providing Superior Value



- 1/4 Network equipment costs
- 1/20 floor space: 400 Sq Ft vs. 10,000 Sq Ft
- 1/25 energy requirement: \$32/day vs. \$600/day
- Best price for volume Linux Servers: <\$500
- 1/5 the administration costs: <5 people vs>25 people
- Highest average resource utilization: >70% vs<15%
- Many times more secure transactions >3500 vs<200 SSL/sec

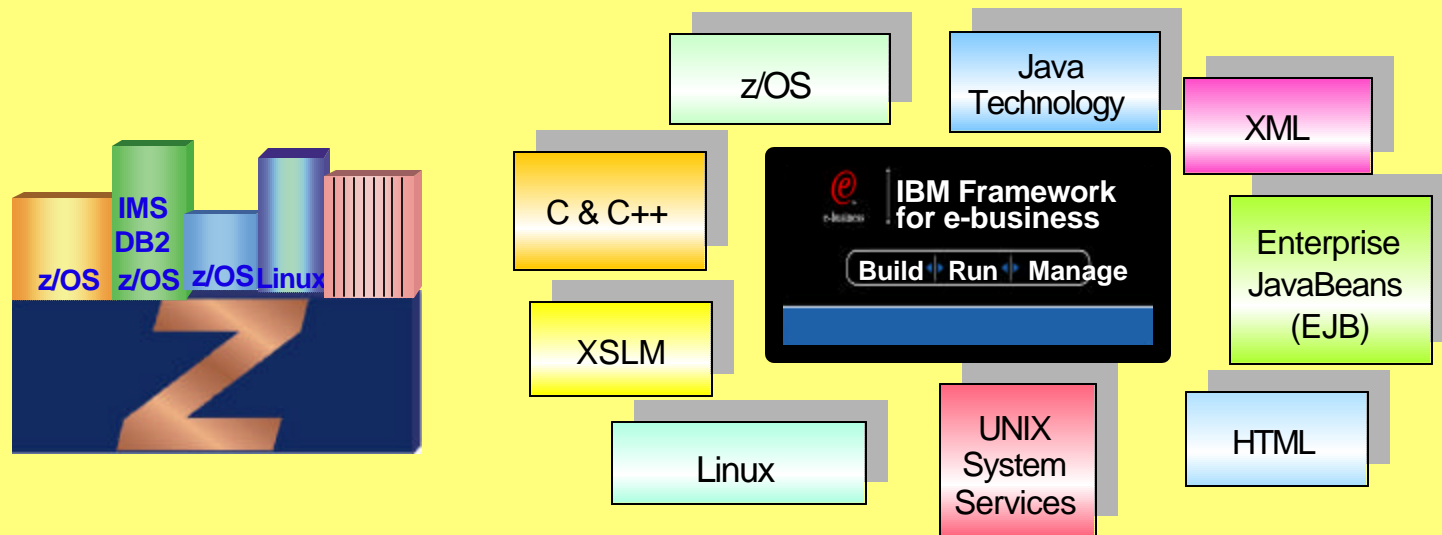

Transforming core business to e-business

IMS for a Highly Secure Environment



- z/OS provides high level Security Standards to measure against
- IMS exploits many of the z/OS security features
- RACF and/or IMS may be used to secure any or all
 - ▶ IMS transactions, databases, commands, terminals, APPC/IMS logical units (LUs), MSC links, control region and dependent regions, program specification blocks, etc.

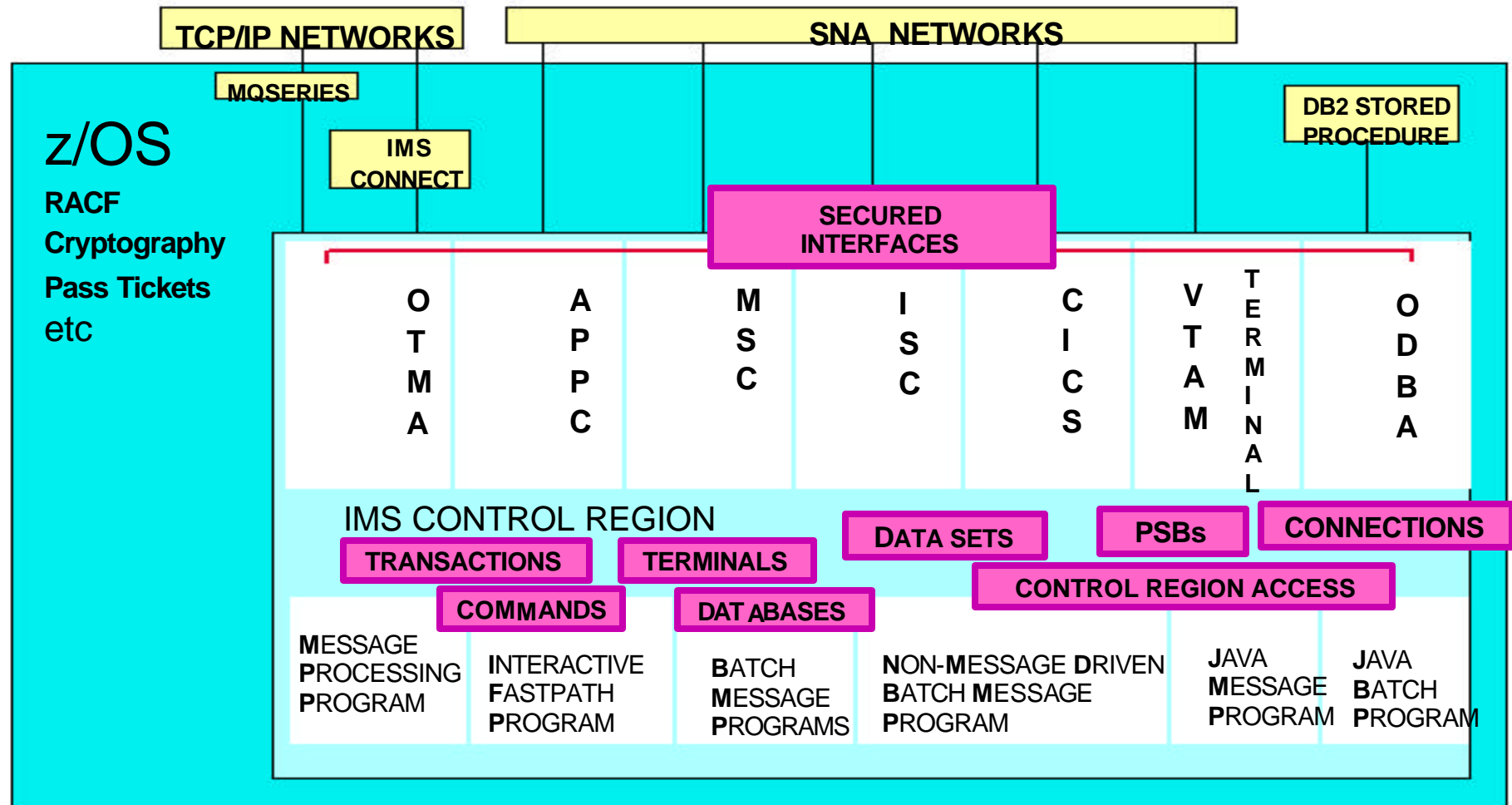

USA

Health Insurance Portability and Accountability Act



- Major Health Insurance Reforms
 - ▶ assuring insurability, coverage
- Strengthens the healthcare system
 - ▶ enhances affordability, combats fraud/abuse, data interchange standards, consumer protection

also:

- Requires **enhanced security and privacy** of individuals' medical information
- Provides for Stiff Civil and Criminal **Penalties for noncompliance**
- Rule Compliance Date: **April 14, 2003** (small plans 2004)

Germany

Bundesdatenschutzgesetz

(Federal Data Protection Act)

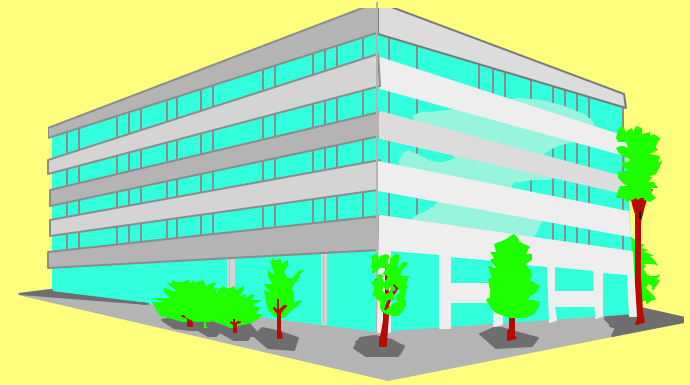

- ***This Act serves to implement directive 95/46/EC of the European Parliament and of the Council of 24 October 1995 on the protection of individuals with regard to the processing of personal data and on the free movement of such data (OJ EC no. L 281, p. 31 ff.).***
 - ***The purpose of this Act is to protect the individual against his right to privacy being impaired through the handling of his personal data.***
- ***This Act shall apply to the collection, processing and use of personal data by (1)Public bodies of the federation, (2)Public bodies of the data protection is not governed by Land legislation (3)private bodies in so far as they process or use data by means of data processing systems or collect data for such systems, process or use data in or from non-automated filing systems or collect data for such systems, except where the collection, processing or use of such data is effected solely for personal or family activities.***

IMS Scaling with SHARK

Performance/Capacity/Availability/Recovery'



Increase in
Bandwidth
Availability

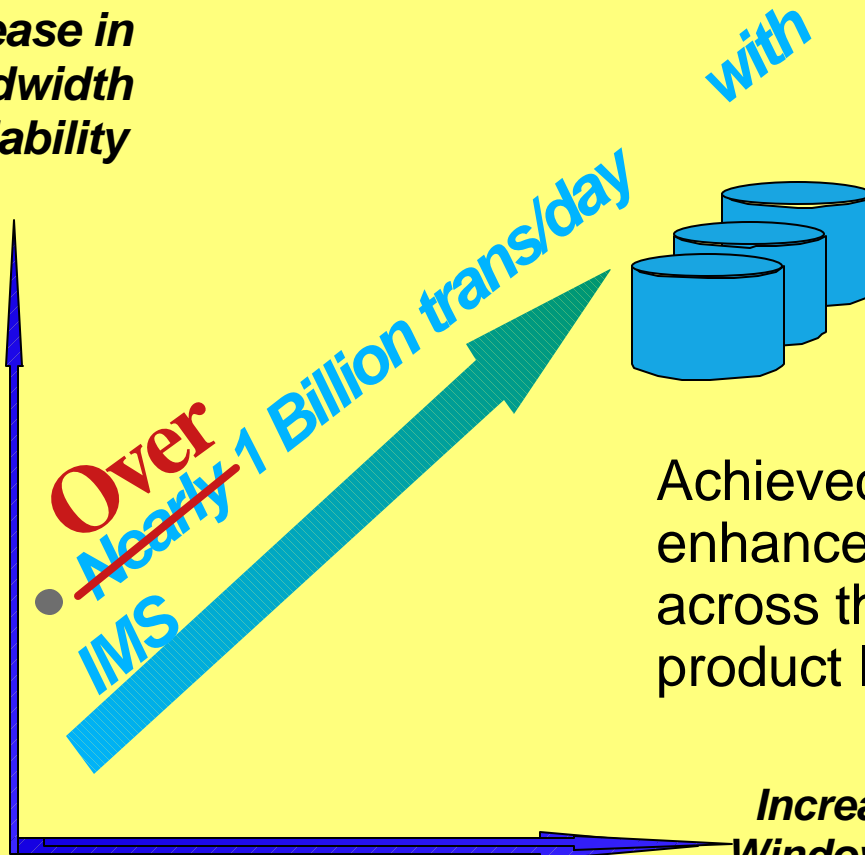

IMS tight integration with
IBM Storage Take advantage
of PAV !!

Achieved thru
enhancements
across the IBM
product line.

Increase in Batch
Window Availability



IMS - Version 7 - 2nd Year CELEBRATION



Ideal for e-business

- ✓ Continuous Availability
- ✓ Systems Management
- ✓ Performance/Capacity
- ✓ Application Development/Connectivity

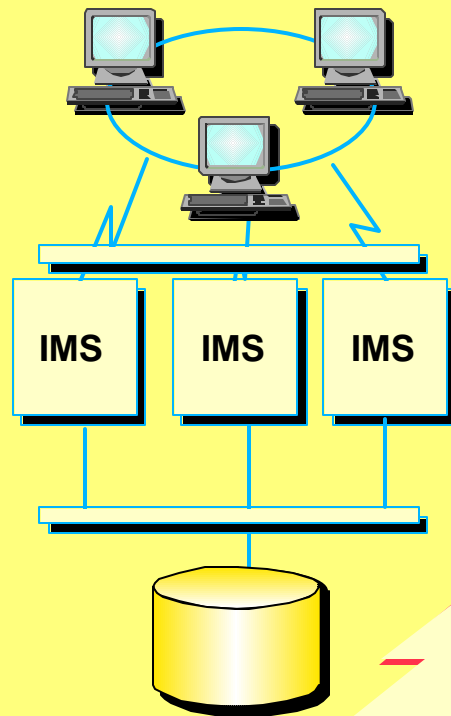

Enhancements

- Extended Large DB support
- Enhanced DB recovery
- Faster Restart with Multinode Persistent Sessions
- Enhanced Systems Mgmt Tools
- Enhanced Connectivity
- IMS Java & XML

Benefits

- ✓ Enable Customer Growth
- ✓ Enhance Workload Balancing
- ✓ Increase Availability; Ease of Use
- ✓ Preserve Current Application Investment
- ✓ Enable New Applications

**Strategic Open Access
S/390 and z/OS
Enterprise Server**

IMS APAR Comparison



First 20 months after GA

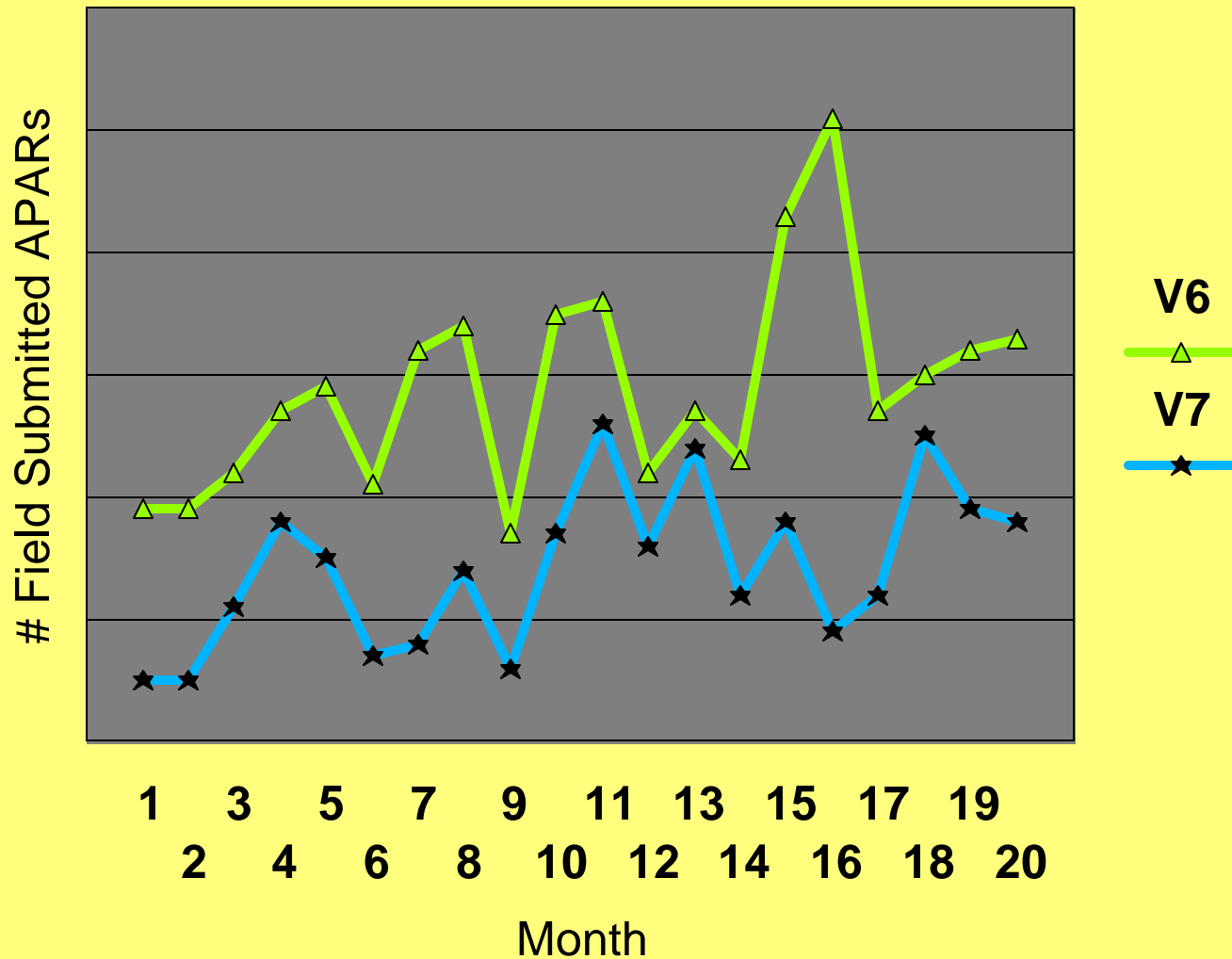

HALDB (High Availability Large Database)



HALDB

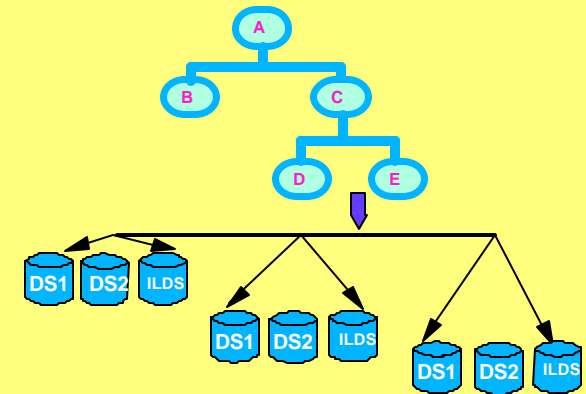

■ Large Database

- Databases are partitioned
 - Up to 1001 partitions per database
 - Partitions have up to 10 data set groups

■ High Availability Database

- Partition independence
 - Allocation, authorization, reorganization, and recovery are by partition
- Self healing pointers
 - Reorganization of partition does not require changes to secondary indexes or logically related databases which point to it
 - Prefix Resolution, Prefix Update, and secondary index rebuilds are eliminated

Up to 10,010 data sets per database!
(Greater than 40 terabytes)

Database Candidates for HALDB



ALL Databases !

- **Very large databases**
 - Approaching 4G (VSAM) or 8G (OSAM) limitations
 - Theoretical limit is now over 40 terabytes
 - Enabled for Data Warehousing
 - unlimited size
 - Foundation for Data Marts (analysis)
 - JDBC access
 - Federation incorporating DL/1 calls

- **Large, Medium and Small databases**
 - Parallel reorganizations
 - Simplified reorganizations
 - Parallel application processing to meet time deadlines (PQ57313)
 - Less frequent reorganizations due to more free space

IMS Java for Integrated e-business Application Development/Connectivity



■ Application programmer productivity

- Java access to IMS input/output message queues
- JDBC to access IMS data
- Uses Visual tools for development

JDBC = Interoperability for Application Developers

■ Enhancements

- New Java Dependent Region support for Persistent Reusable Java Virtual Machine
- JDBC access to IMS DB from CICS/390 Java applications, DB2/390 Stored Procedures, and Websphere applications
- COBOL - Java Interoperability in Java dependent regions

Application Development/Enablement

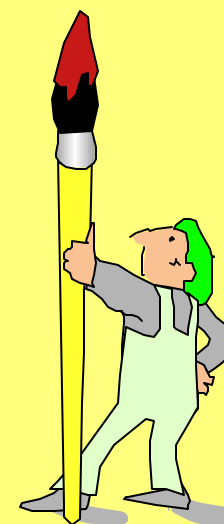
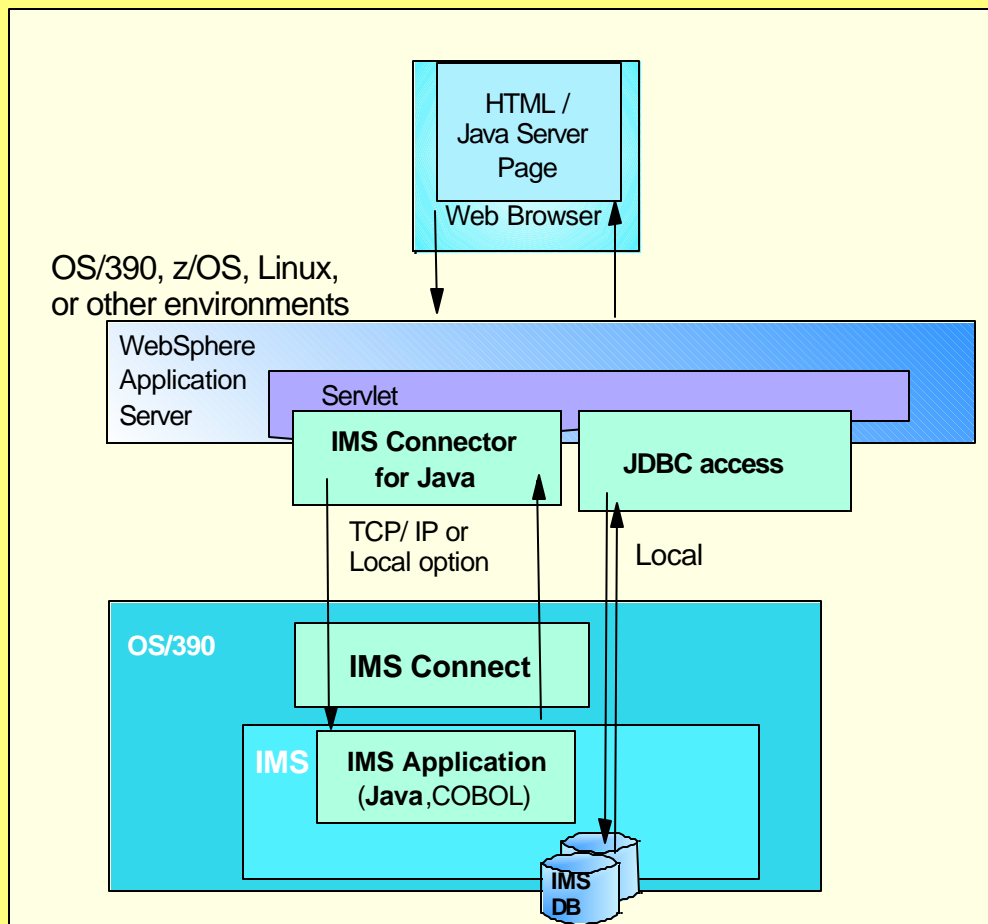

IMS Is Ideal For e-business



- **IMS is ideally suited to be the backbone of your e-business solutions:**
 - **IMS is secure**
 - z/OS and IMS offer significant security options
 - **IMS is scalable with high performance**
 - The Internet can introduce unpredictable volumes
 - IMS already drives the worlds largest workloads
 - **IMS is highly available**
 - The Internet requires 24 x 7 x 365
 - **e-business with IMS offers investment protection**

Linux enabled !!!
... run your e-business applications
on Linux and connect through IMS Connect



Linux for zSeries



IBM @server zSeries

- What is Linux for zSeries?

- Runs native, in an LPAR, or on z/VM
- Not a unique version of Linux or other operating system
- Not a replacement for other IBM zSeries operating systems

- What Linux Brings to zSeries

- Large portfolio of applications, tools and enablers
- The ability to enhance zSeries architecture
- Large number of trained programmers and administrators

- What zSeries Brings to Linux

- Legendary reliability
- Unmatched scalability
- Designed to support multiple, diverse workloads
- Simplified System Management
- Ability to run large numbers of Linux servers on a single zSeries

"Linux has been a huge breath of fresh air for the mainframe. It's now politically correct to be talking about mainframes again in the data center."

David Mastrobattista, Giga Information Group

IBM @server. For the next generation of e-business.

Many Linux Applications for zSeries



Compuware Corporation

Uneclipse Software Systems

SANCHEZ

abas Software

ACTS

LegacyJ

SAP

The Workstation Group

Dimensional INSIGHT

logics SOFTWARE

SecureAgent software

ABK Systeme

Ascential Software

DIGNUS SOLUTIONS OF MERIT

macro 4

SENDMAIL

Bynari

ACUCORP

green light ADVANTAGE

Rational the e-development company

SOLITON ASSOCIATES Enterprise Software Solutions

bmcsoftware

aeonware making e-commerce profitable

ROGUE WAVE SOFTWARE

SOFTWARE AG

Lattwein Computersprachen

BEANS

INNOVATION DATA PROCESSING

RTS

STALKER SOFTWARE INC.

!Candle eBusiness at the speed of light

INTERCOPE

KAI C++

SAIMAAN TIETOTEKNO OY

IBM @server. For the next generation of e-business.

October, 2002 Announcing IMS Version 8 General Availability

Building on the Base Functionality



Ideal for e-business

- ✓ Continuous Availability
- ✓ Systems Management
- ✓ Performance/Capacity
- ✓ Connectivity
- ✓ Application Development

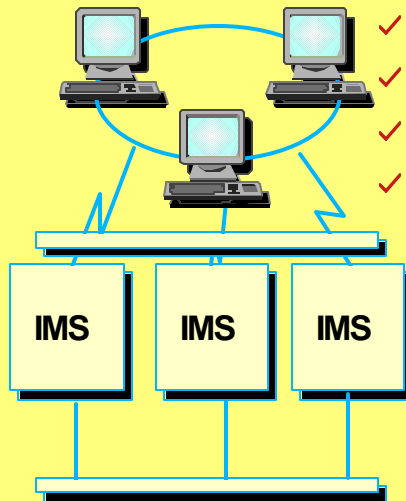

Enhancements

- Sysplex Terminal Management
- Sysplex-wide Resource Mgmt
- Sysplex-wide Operations with Single Point of Control
- Enhanced DB Recovery Ctrl
- Simplified Installation Process
- Enhanced Systems/Data Mgmt Tools
- Enhanced Java and XML

Benefits

- ✓ Enable Customer Growth
- ✓ Enhance Workload Balancing
- ✓ Increase Availability; Ease of Use
- ✓ Preserve Current Application Investment
- ✓ Enable New Applications



**Strategic Open Access
for S/390 and zSeries
Enterprise Servers**

IMS V8 Status

- **General Availability ... 10/02**
- **Release quality excellent**
 - **Tracking better than V7 in internal test stages**
- **IMS Quality Partnership Program (QPP) participants**

- **Europe**

- Banking
- Insurance
- Banking
- Auto Manufacturing
- Banking
- Banking

- **Asia/Pacific**

- IBM High Availability Technical Support Center (HATC)

- **US**

- Aerospace Manufacturing
- Telecommunications
- Telecommunications
- Banking and Brokerage
- Banking

- **Canada**

- Banking
- Banking

IMS V8 - Scheduled 01/28/03 - 01-30/03 (Course U3729)





IMS V7 - V8 SVT Comparison

Field APARs

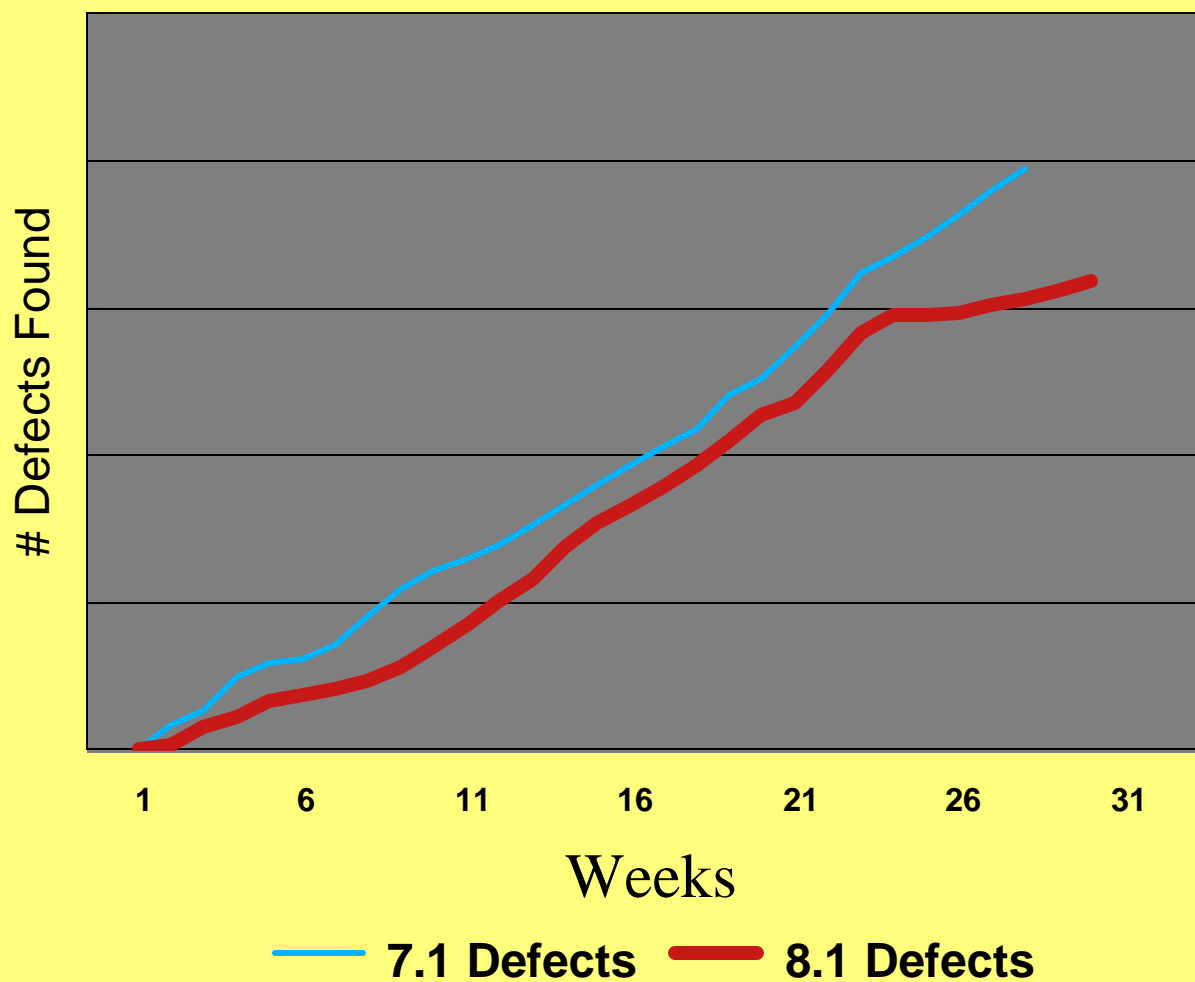

IMS APAR Comparison



First 20 months after GA

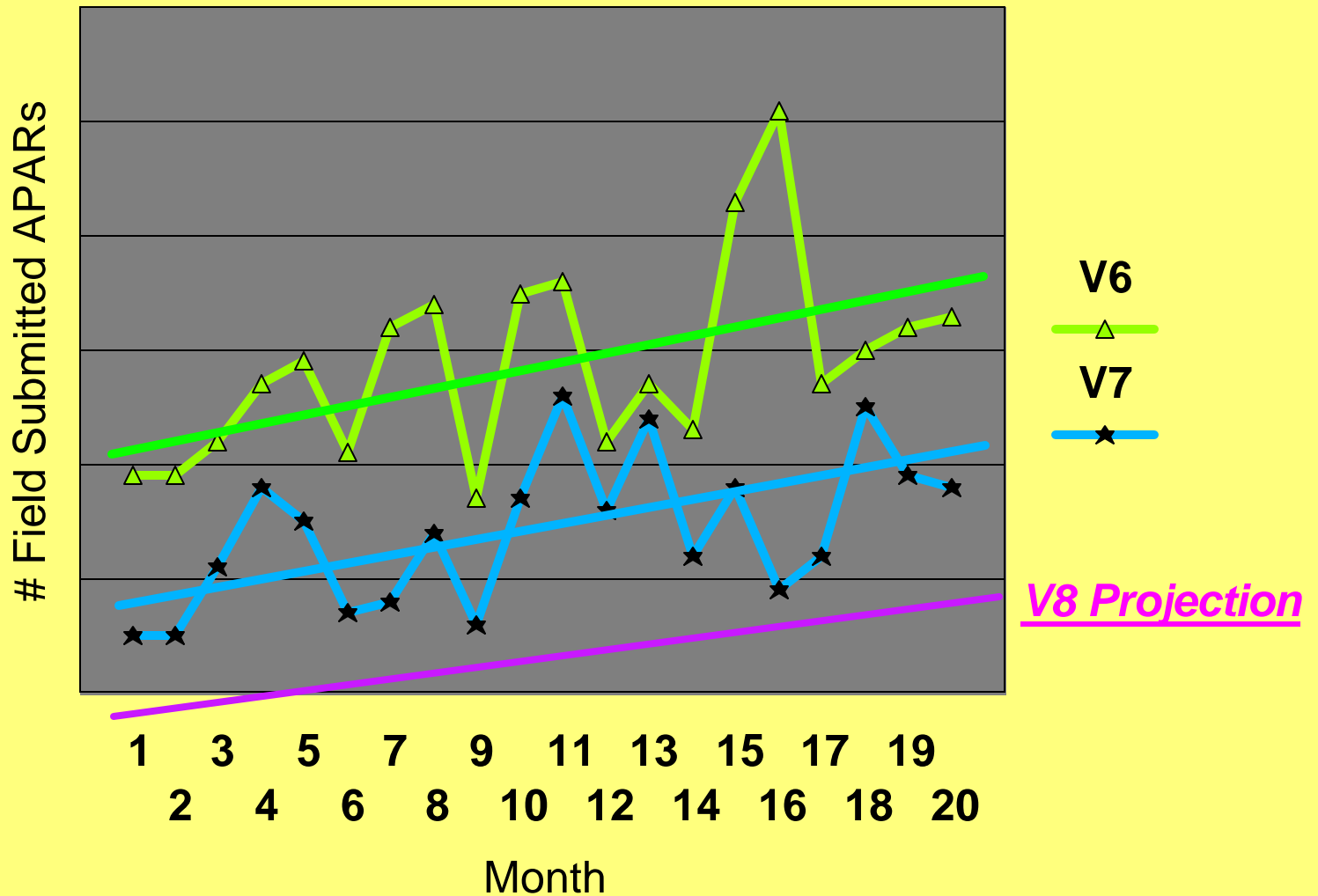

IMS V8 - General Availability



- Information **"Integration"** with New Application Development/Connectivity
 - ✓ Support of Persistent Reuseable JVM for improved tooling
 - ✓ Support for latest JAVA and SQL Standards
 - ✓ Integration with Websphere
 - ✓ Enhanced XML Support of Messages

- **Manageability**
 - ✓ Management View across Sysplex
 - Single Point Of Control (SPOC)
 - DB2 Control Center Integration
 - ✓ Enhanced Recovery
 - ✓ Sysplex Terminal Options



- **Scalability** in Performance/Capacity/Availability/Recovery
 - ✓ Increased performance with Shark DASD
 - MSC throughput
 - OLDS logging
 - ✓ Increasing FastPath Areas from 240 to 2048
 - ✓ CSA reduced usage by almost 50%
 - ✓ Shutdown 20% faster, Startup to ready state over 50% faster

The Big Picture: JDBC Access to IMS Data

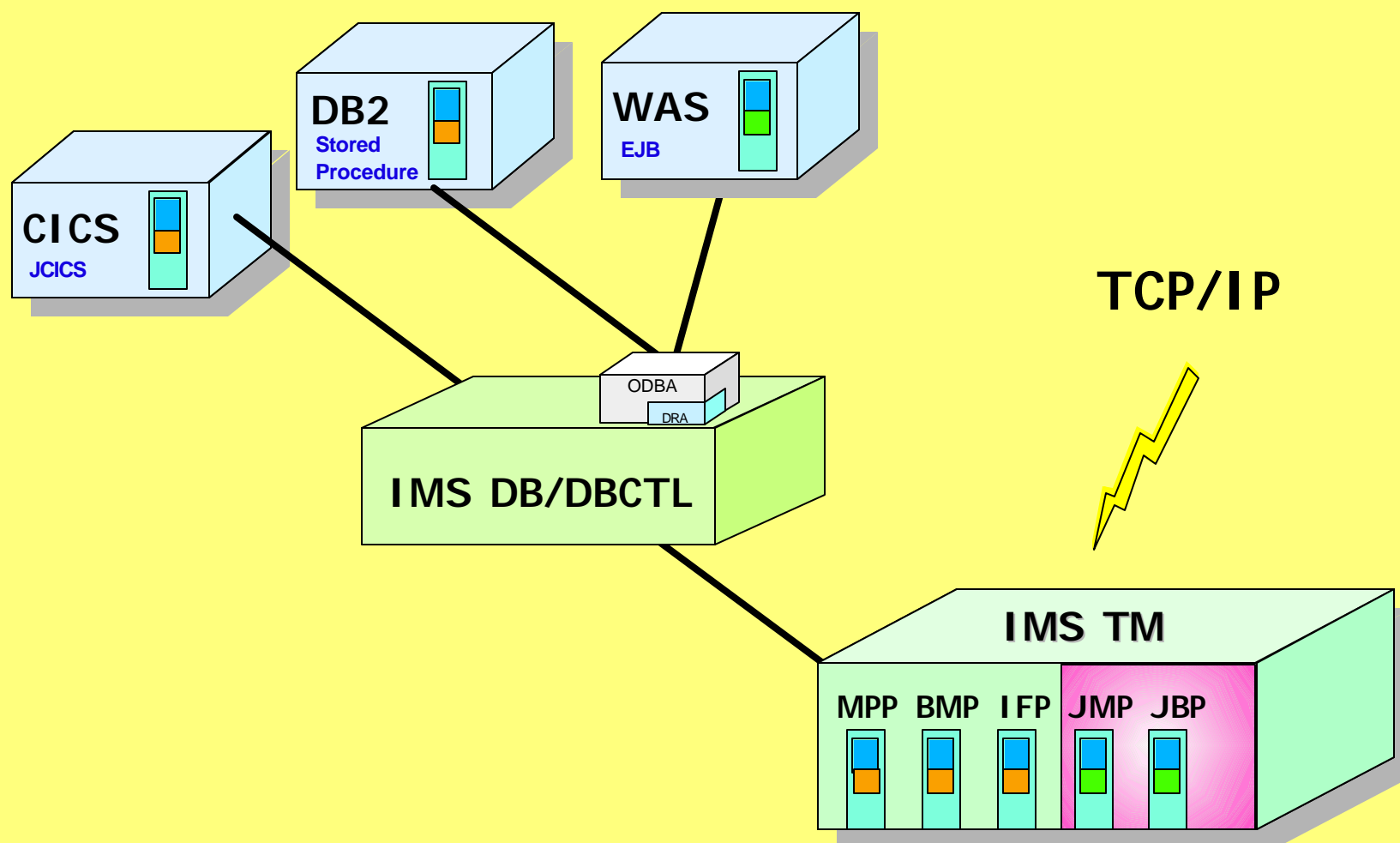

```
"SELECT CheckingAcct.Balance, SavingAcct.Balance,CheckingAcct.Name" +  
"FROM MyBankPCB.Accounts " +  
"WHERE CheckingAcct.Balance > 10000" +  
"AND SavingAcct.Balance > 20000 "
```



INTEGRATION !!!

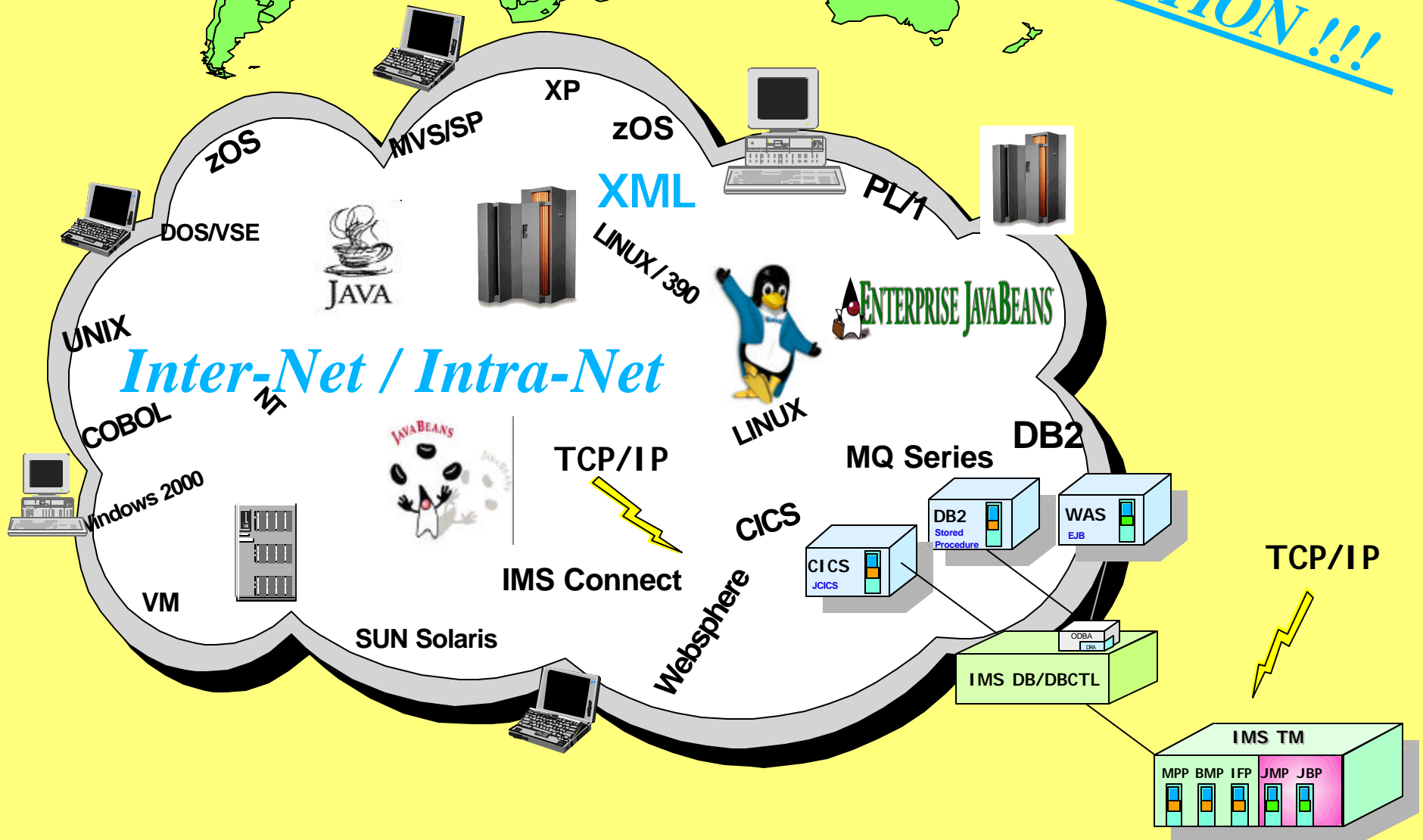
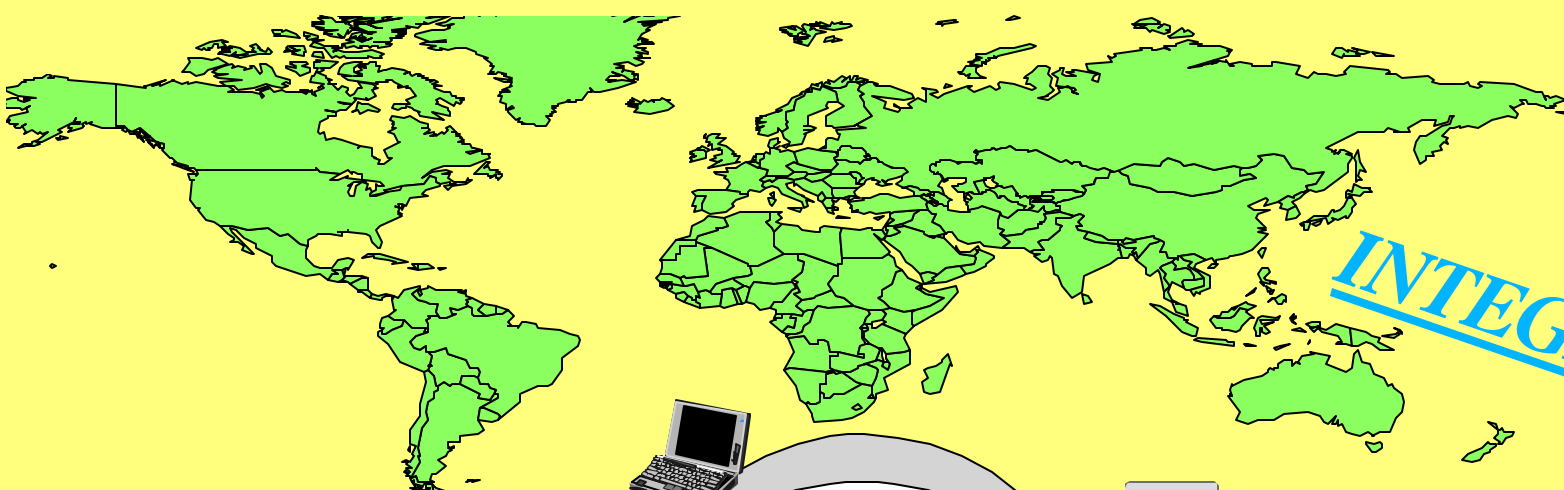

Inter-Net / Intra-Net

TCP/IP

TCP/IP

IMS TM

MPP BMP IFP JMP JBP



IMS XML Integration Demo

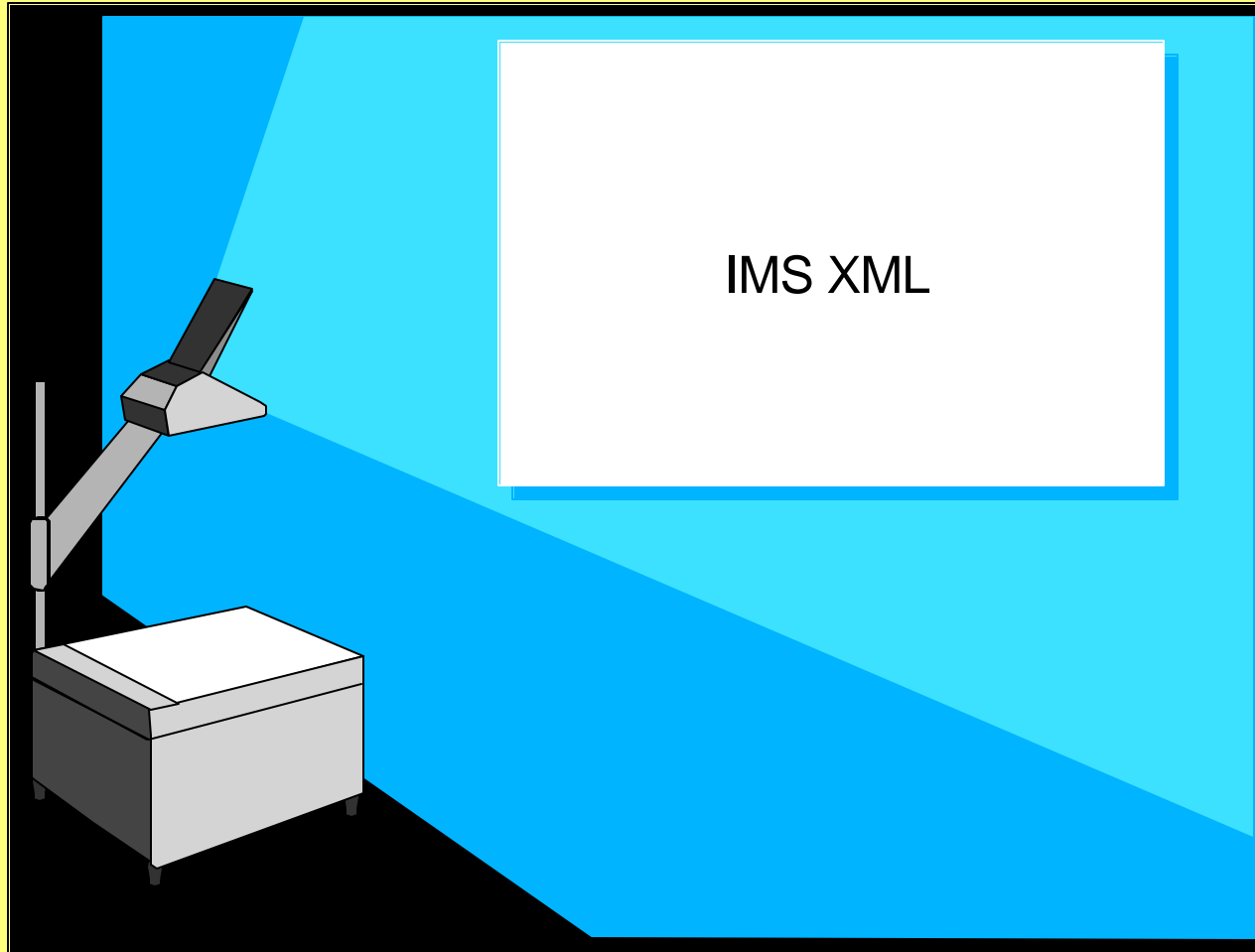

IMS XML Solutions Now and Future



z/OS

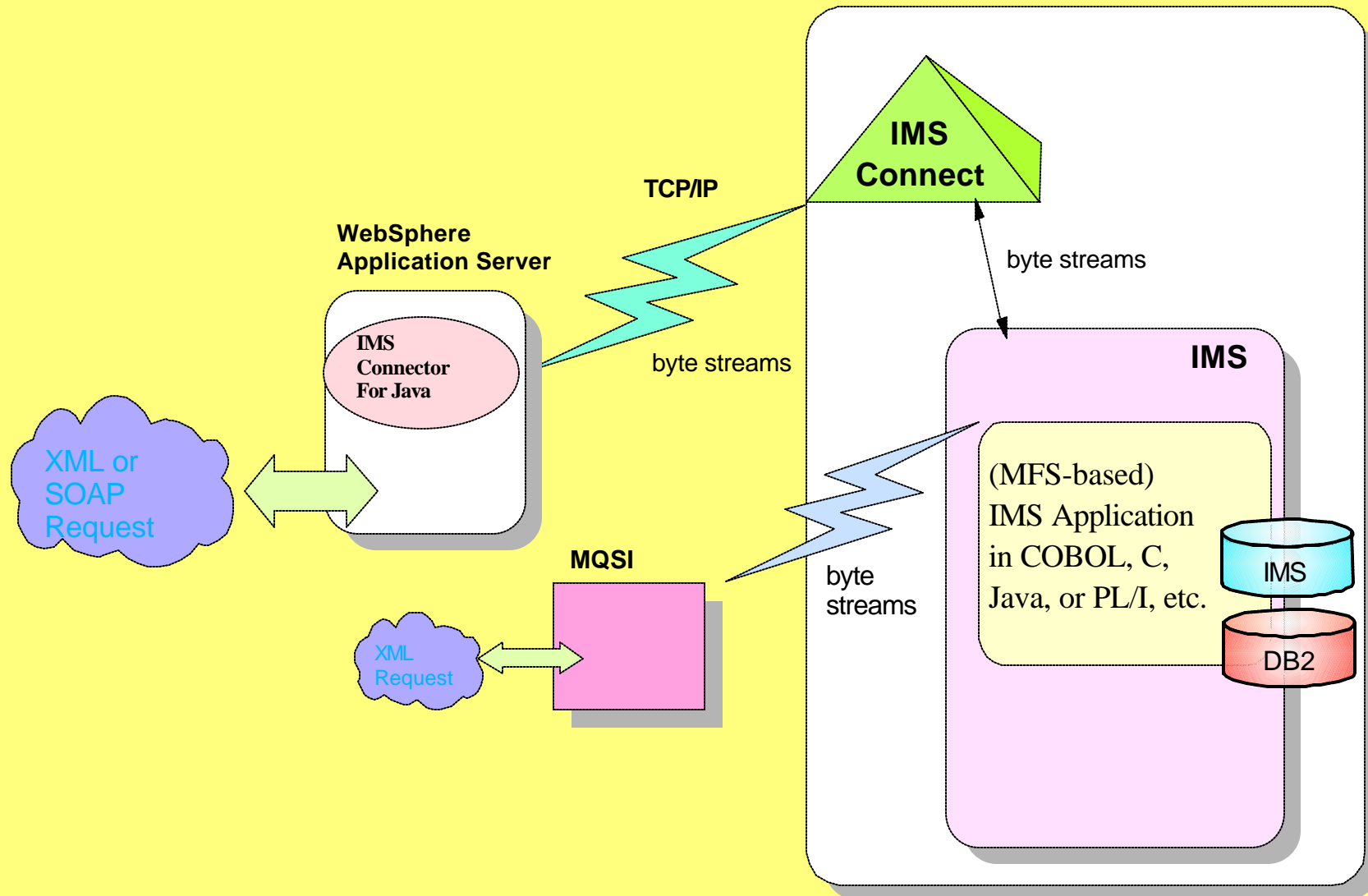

IMS XML Solutions Now and Future



z/OS

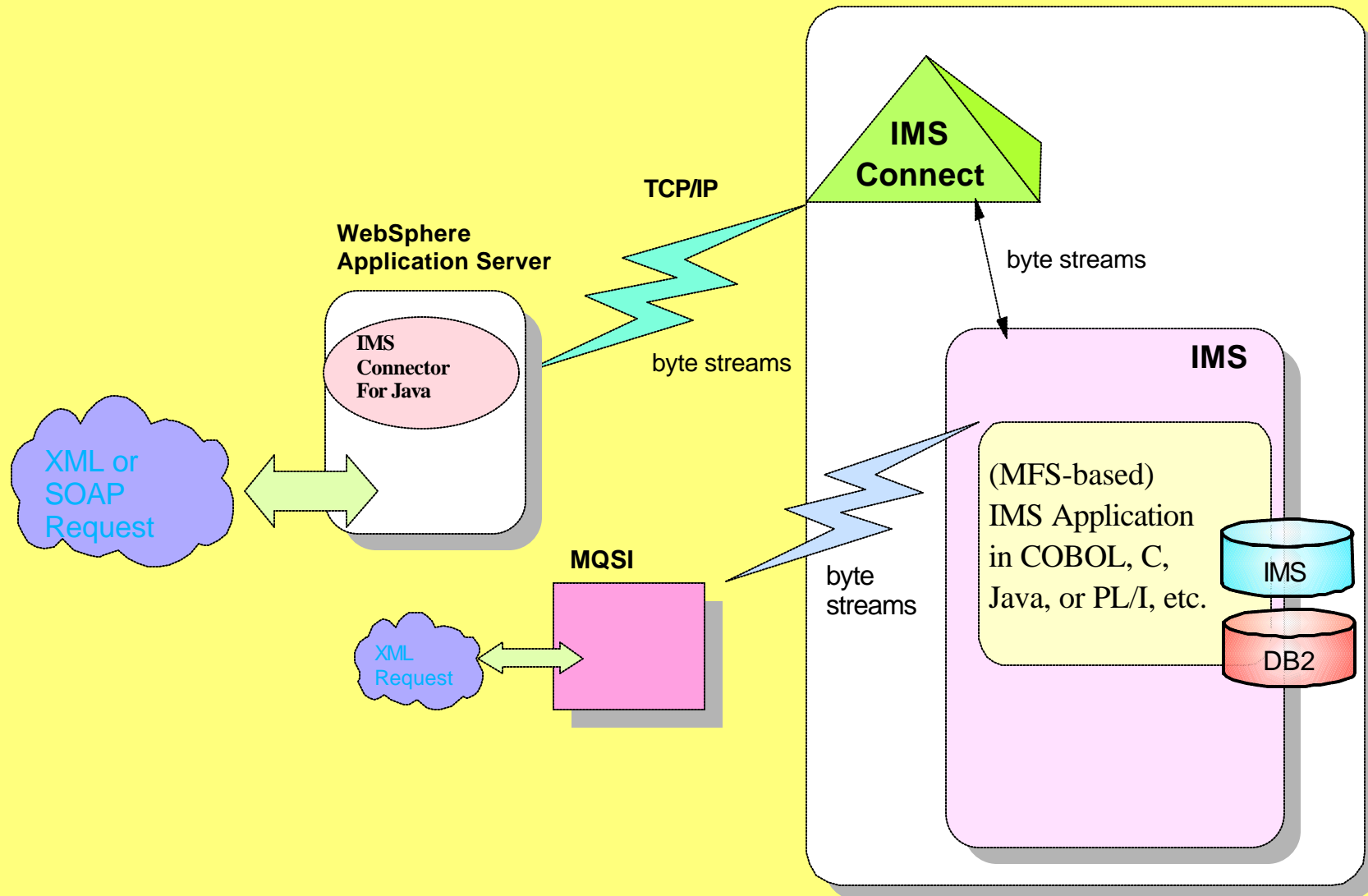

IMS XML Solutions Now and Future



z/OS

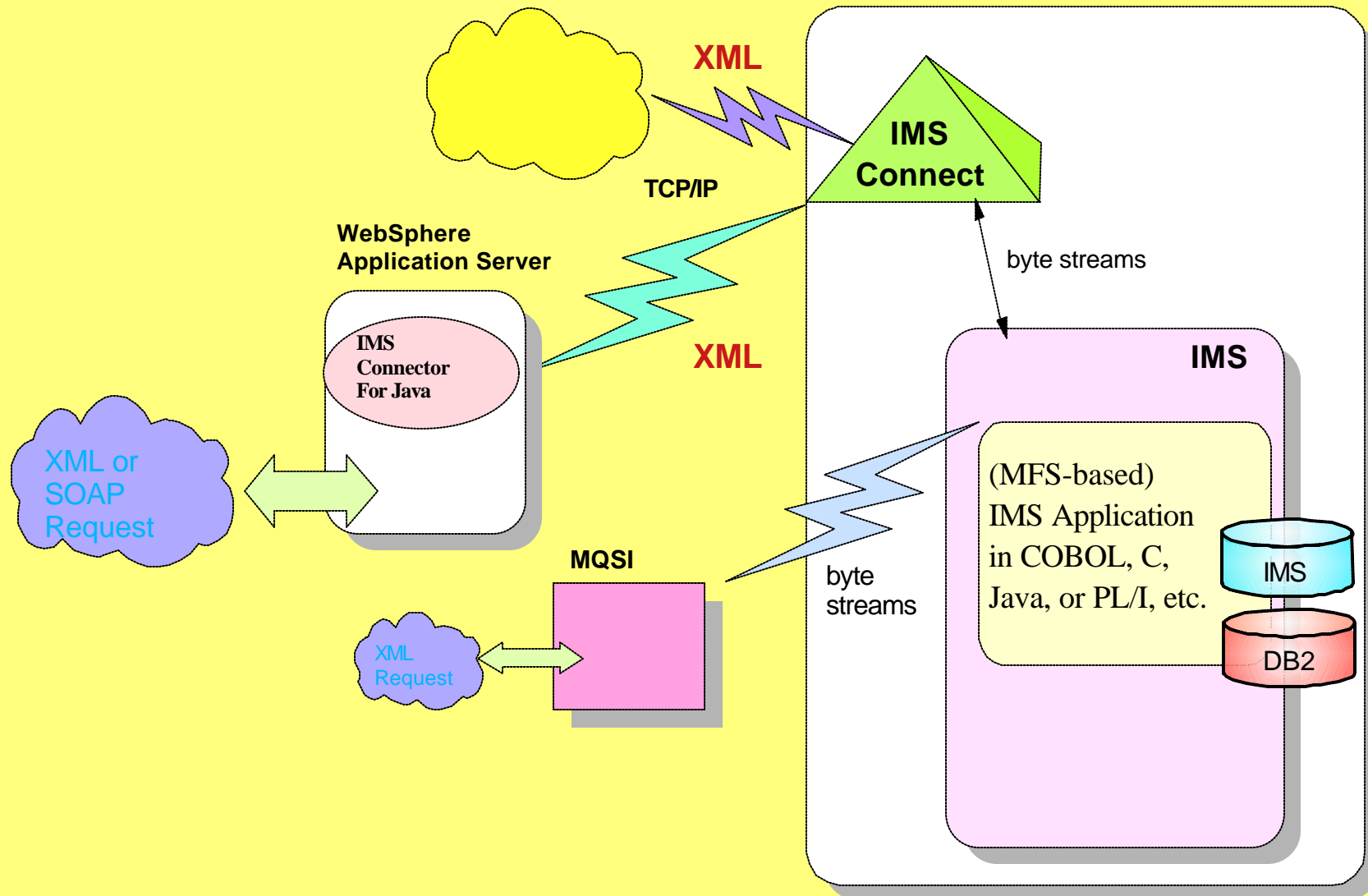

IMS XML Solutions Now and Future



z/OS

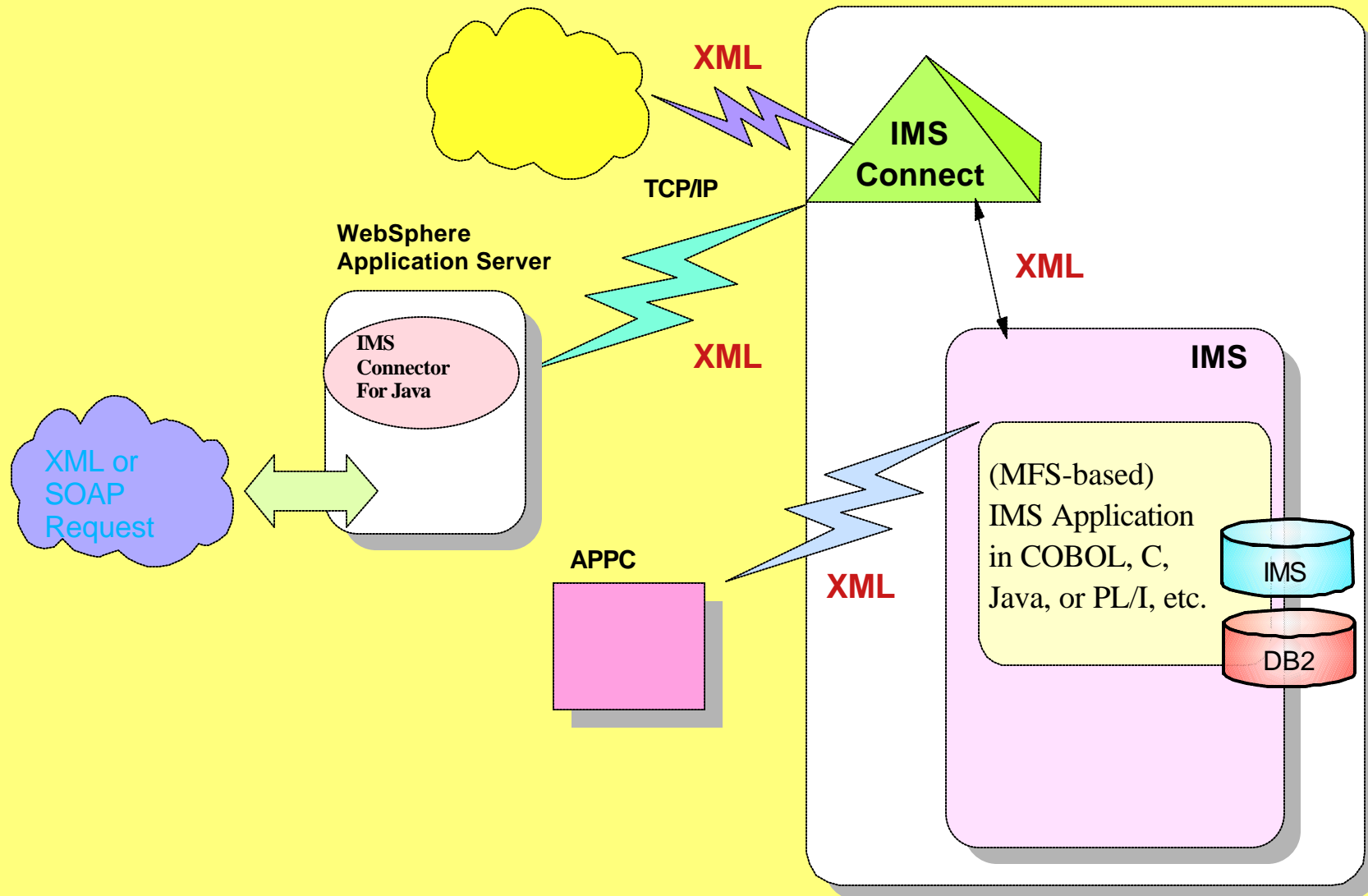

IMS V8 - General Availability



- Information **Integration** with New Application Development/Connectivity

- ✓ Support of Persistent Reuseable JVM for improved tooling
- ✓ Support for latest JAVA and SQL Standards
- ✓ Integration with Websphere
- ✓ Enhanced XML Support of Messages

- **"Manageability"**

- ✓ Management View across Sysplex
 - Single Point Of Control (SPOC)
 - DB2 Control Center Integration
- ✓ Enhanced Recovery
- ✓ Sysplex Terminal Options



- **Scalability** in Performance/Capacity/Availability/Recovery

- ✓ Increased performance with Shark DASD
 - MSC throughput
 - OLDS logging
- ✓ Increasing FastPath Areas from 240 to 2048
- ✓ CSA reduced usage by almost 50%
- ✓ Shutdown 20% faster, Startup to ready state over 50% faster

IMS V8 - General Availability



- Information **Integration** with New Application Development/Connectivity

- ✓ Support of Persistent Reuseable JVM for improved tooling
- ✓ Support for latest JAVA and SQL Standards
- ✓ Integration with Websphere
- ✓ Enhanced XML Support of Messages

- **"Manageability"**

- ✓ Management View across Sysplex
 - Single Point Of Control (SPOC)
 - DB2 Control Center Integration
- ✓ Enhanced Recovery
- ✓ Sysplex Terminal Options



- **Scalability** in Performance/Capacity/Availability/Recovery

- ✓ Increased performance with Shark DASD
 - MSC throughput
 - OLDS logging
- ✓ Increasing FastPath Areas from 240 to 2048
- ✓ CSA reduced usage by almost 50%
- ✓ Shutdown 20% faster, Startup to ready state over 50% faster

IMS V8 - General Availability



- Information **Integration** with New Application Development/Connectivity

- ✓ Support of Persistent Reuseable JVM for improved tooling
- ✓ Support for latest JAVA and SQL Standards
- ✓ Integration with Websphere
- ✓ Enhanced XML Support of Messages

- **Manageability**

- ✓ Management View across Sysplex
 - Single Point Of Control (SPOC)
 - DB2 Control Center Integration
- ✓ Enhanced Recovery
- ✓ Sysplex Terminal Options



- **"Scalability"** in Performance/Capacity/Availability/Recovery

- ✓ Increased performance with Shark DASD
 - MSC throughput
 - OLDS logging
- ✓ Increasing FastPath Areas from 240 to 2048
- ✓ CSA reduced usage by almost 50%
- ✓ Shutdown 20% faster, Startup to ready state over 50% faster

IMS Directions

IMS is Ideal for e-business

- ✓ Continuous Availability
- ✓ Systems Management
- ✓ Performance/Capacity
- ✓ Connectivity
- ✓ Application Development

IBM delivers at web speed...

10/00

IMS V7

- Large DB
- High Avail. DB
- IMS Java
- Rapid Restart

10/02

IMS V8

- Extend DB Connectivity
- Enhance Sysplex Operations
- Simplify Install Process
- Enhance Management Tools

10/04

IMS V9

- Availability - OLR
- Incremental GEN-Less System
- SYSPLEX DB Cmds.

10/06

IMS V10

- Sysplex Enh.
- Logical Front End-Back End Split
- DBRC Parallelism
- Incremental Dynamic Resource Defn.

10/08

IMS V11

- Physical Front End-Back End Split
- Sysplex Enh.

Database

Sysplex

Database & Operations

**Sysplex -
Perf/Optimize
& Availability**

**Sysplex +
Database**

IMS Directions

IMS is Ideal for e-business

- ✓ Continuous Availability
- ✓ Systems Management
- ✓ Performance/Capacity
- ✓ Connectivity
- ✓ Application Development

IBM delivers at web speed...

**Connectivity
Database
Systems**



**Vision
Commitment
Continuous Improvement**



IMS - Simply the Best !!!



Search

[Home](#) | [Products & services](#) | [Support & downloads](#) | [My account](#)

Software > Database and Data Management >

→ [Select a country](#)

All Software Products

IMS Family

[Library](#)

[Success stories](#)

[News](#)

[How to buy](#)

[Events](#)

[Education](#)

[Services](#)

[Support](#)

Related software

[CICS](#)

[DB2](#)

[WebSphere](#)

[WebSphere MQ Family](#)

Related hardware

[Storage systems](#)

[zSeries](#)

Related services

[zSeries Publications](#)

[IBM Learning Services](#)

[Warranty info](#)

IMS Family

IBM's premier transactional and hierarchical database management system for critical on-line operational and e-business applications and data, enabling Information Integration, Management, and Scalability.

Select a Product

Products

•IMS®

IBM's premier transactional and hierarchical database management system for critical on-line operational and e-business applications and data.

•IMS Connect

A must-have tool for any IMS shop embarking on e-business, IMS Connect improves TCP/IP access and enables easier access to IMS applications and data from the internet.

•IMS Connector for Java

IMS Connector for Java, a component of IMS Connect, allows you to rapidly create and run Java applications to access IMS transactions over the internet through IMS Connect.

Tools and components

•Data Management Tools

IBM Data Management tools are specifically designed to enhance the performance of IMS and DB2 in an affordable and easy-to-use manner.

Events

→ [IMS Technical Conference](#)
Sept 30 - Oct 3, 2002
St. Louis, MO

→ [EMEA IMS Technical Symposium](#)
Oct 15-17, 2002
Koenigswinter, Germany

*Featured
Customer*

DB2 Data Management Software

→ [Buy online](#)



Highlights

[Overview](#)

[Presentation/papers](#)

[Redbooks](#)

[New News](#)

Communities

→ [Receive Recent IMS news](#)

→ [IMS Newsletter](#)

→ [IMS User Groups](#)