



IBM Data Management Tools Product Strategies, Portfolio, and Futures August 2002

Dan Wardman, Director Data Management Tools
IBM Silicon Valley Lab

Plans subject to change

IBM Software Group

Agenda

- Data Management Tools Business Overview
- IMS Tools Portfolio
- IMS Tools Sneak Peek
- Summary

Data Management Tools - Business Overview

- Data Management Tools is a unique model in the database tools industry
- Investment increased to support future needs
- Comprehensive solutions now and more coming
- Independent of database server versions (release cycles)
- Multiplatform direction
- Common interfaces
- Cross-tool integration
- Products tested under same configurations and workloads as DB2 and IMS

Data Management Tools - Business Strategy

- Continue to improve and expand portfolio

- Focus
 - ▶ New products
 - ▶ Product enhancements

- Remain flexible and responsive to customers
 - ▶ Adjust plans to accommodate customer requirements as business dictates
 - ▶ Deliver enhancements in expeditious manner

- Ensure satisfaction of existing customers
 - ▶ Service excellence
 - ▶ Responsiveness to new requests

IMS Tools Product Portfolio - September 2002

Database Administration (19)

- ▶ **IMS High Performance Unload 5655-E06**
- ▶ **IMS High Performance Load 5655-E07**
- ▶ **IMS High Performance Prefix Resolution V2 5655-I15**
- ▶ **IMS Index Builder V2.R3 5655-E24**
- ▶ **IMS Parallel Reorganization V2 5655-F74**
- ▶ **IMS High Performance Pointer Checker 5655-E09**
- ▶ **IMS Data Base Repair Facility 5655-E03**
- ▶ **IMS High Performance Sysgen Tool 5655-F43**
- ▶ **IMS Command Control Facility 5655-F40**
- ▶ **IMS ETO Support 5655-E12**
- ▶ **IMS Library Management Utilities 5655-E04**
- ▶ **IMS Advanced ACBGEN 5655-E05**
- ▶ **IMS Sequential Randomizer Generator 5655-E11**
- ▶ **IMS Compression - Extended 5655-E02**
- ▶ **IMS Data Base Control Suite V2R2 5655-F76**
- ▶ **IMS Fast Path Basic Tools 5655-E30**
 - DEDB Unload/Reload
 - DEDB Pointer Checker
 - DEDB Tuning Aid
- ▶ **IMS Fast Path Online Tools V2 5655-F78**
 - Online Pointer Checker
 - Online Data Extract
 - Online Area Extend
- ▶ **IMS High Availability Large Database Conversion Aid 5655-I01**
- ▶ **Batch Backout Manager 5697-H75**

Performance Management (5)

- ▶ **IMS Performance Analyzer V3R2 5655-E15**
- ▶ **IMS Network Compression Facility 5655-E41**
- ▶ **IMS Queue Control Facility V1.2 5697-E99**
- ▶ **IMS Workload Router V2.3 5697-B87**
- ▶ **IMS Buffer Pool Analyzer 5697-H77**

Recovery / Replication (6)

- ▶ **IMS Image Copy Extensions V2R1 5655-J56**
- ▶ **IMS DEDB Fast Recovery V2R2 5655-E32**
- ▶ **Application Rec Tool for IMS & DB2 V1R2 5697-F56**
- ▶ **Online Recovery Service (ORS) 5655-E50**
- ▶ **IMS Data Propagation V3R1 5655-E52**
- ▶ **IMS High Performance Change Accumulation 5655-F59**

Application Management (4)

- ▶ **IMS Connect V1R2 5655-E51**
- ▶ **IMS Message Format Services Reversal Utilities 5655-F45**
- ▶ **IMS Program Restart Facility 5655-E14**
- ▶ **Batch Terminal Simulator V3 5655-J57**

IMS Tools for ...

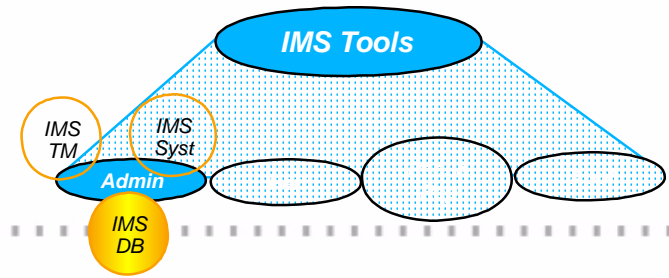

IMS DB Administration

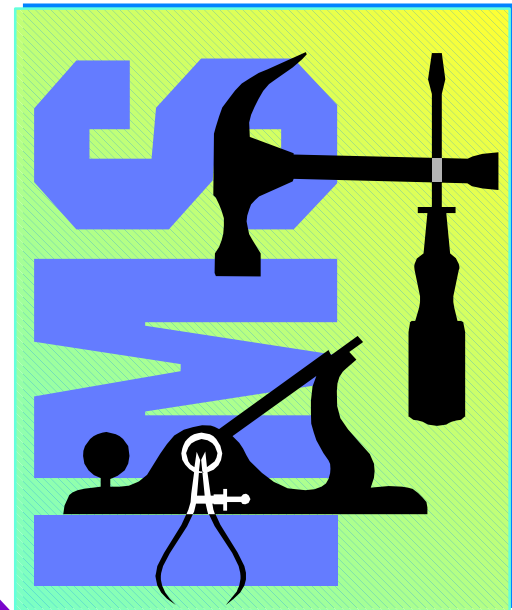

DB Reorganization

- All IMS DB users have a need to reorganize DBs on a regular basis
 - ▶ The pressure for increasing availability creates ever growing demands for fast reorganization utilities

- The products that support reorganization of full function DBs* are
 - ▶ IMS High Performance Unload (5655-E06)
 - ▶ IMS High Performance Load (5655-E07)
 - ▶ IMS High Performance Prefix Resolution (5655-I15)
 - ▶ IMS Index Builder (5655-E24)
 - ▶ IMS Parallel Reorg V2 (5655-F74)

* “Full Function DBs” are HISAM, HDAM, HIDAM, PHDAM, PHIDAM, secondary index and PSIndex

IMS High Performance Unload

V8
Support

- Includes full support for HALDB
 - ▶ unload one, several or all partitions
 - ▶ migration/fallback support
- DB Unload Utilities
 - dynamic allocation of DB datasets
 - option to leave compressed data compressed
 - multiple unload formats
 - can unload broken DBs
 - variety of statistical reports
- Application programming interface
 - ▶ Includes HSSR's API
 - for stand-alone batch programs
 - transparent to programmer
- Sequential Subset Randomizer
 - Randomizing module to enable fast sequential processing of DB subset

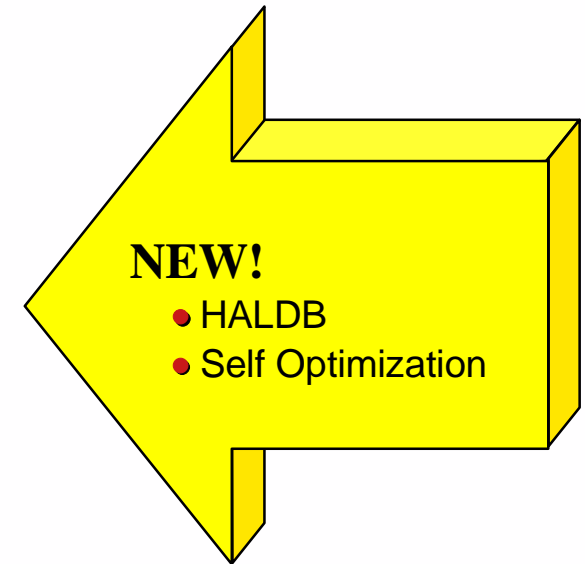

IMS High Performance Load

V8
Support

- DB Load Utility
 - ▶ complements High Performance Unload Utility
 - compressed/uncompressed input in various formats
 - dynamic allocation of DB datasets
 - ▶ supports HDAM, HIDAM, HISAM, SHISAM and HALDB
 - including a high-speed alternative to IMS Partition Initialization Utility
 - and migration reload
 - ▶ can be used to initialize empty DBs
- HDAM /HIDAM PSSR Utility

NEW!

- HALDB
- Self Optimization

Avoids “cascading” on Reload (when too many roots randomise to same block)

High Performance Prefix Resolution



V8
Support

- Performs the same functions as the IMS Prefix Resolution utility (DFSURG10) but with considerably reduced elapsed times.
- Prefix resolution is a required step for resolving pointers for databases containing logical relationships and for creating or recreating secondary indices.
- A data transfer service called HPPRPIPE is used to eliminate the intermediate Work File 2 (WF2) data set, which avoids much of the I/O, tape handling, and DASD requirements often associated with prefix resolution.
 - ▶ does not require the BatchPipes®/MVS™ subsystem.

IMS Index Builder

- Add or Rebuild all or some secondary indexes of an IMS database
 - ▶ Using as input:
 - Output from initial load or reload after a reorg
 - DL/I scan of the IMS database
 - Output from prefix resolution (DFSURIDX)
 - ▶ Supports empty secondary indexes
 - ▶ Easy-to-use one step procedure
 - ▶ Sorts and Loads Multiple Indices in Parallel
- Rebuild HIDAM primary index
- DBRC notification support
- HALDB support for IMS V7
- Separate sort address spaces will be created
- Duplicate Record Processing to Spill File
- Will not terminate if error on one index.
- When building primary index, the index may be empty or not
- Supports building HALDB primary indexes

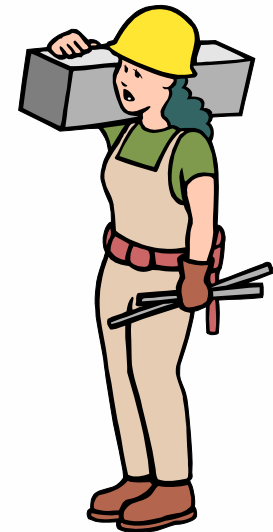

IMS Parallel Reorganization V2

- Replaces IMS Parallel Reorganization V1
 - ▶ Support IMS V6, IMS V7 and IMS V8
- Functional Improvements
 - ▶ Execution of the following utilities in one address space
 - IMS HP Unload
 - IMS HP Load
 - IMS Index Builder
 - ▶ Dynamic allocation of Input and Output database datasets
 - ▶ Full DBRC support, including DBRC notification
 - ▶ Automated name swapping
 - ▶ Automated IMS Command Processing



IMS HALDB Conversion Aid 5655-I01

- An easy-to-use ISPF front-end
 - ▶ HALDB conversion requires a skilled DBA. As these skills are not freely available, this tool supports migration without a skilled DBA.
 - ▶ The conversion process is guided by an ISPF application.
 - It allows you to model the partitions (via ISPF dialog or by standard setup rules).
 - The DBD and DBRC definitions are created.
 - The HALDB partition datasets are allocated.
 - The conversion JCL is created.
 - The conversion process can be monitored.
- Automatic DBD conversion
- Conversion of TEST databases
- Index pointer healing
- Partition modeling tool
- Requires no HALDB experience and little IMS expertise

DB Health Checking

- All IMS DB users have a need to
 - ▶ Check for pointer errors
 - ▶ Repair bad pointers or segment data
 - ▶ Monitor space usage and other aspects that might require DB Reorganization
- New tools for DB Health checking
 - ▶ IMS High Performance Pointer Checker (5655-E09)
 - ▶ IMS DB Repair Facility (5655-E03)

***Include full support
for HALDB***

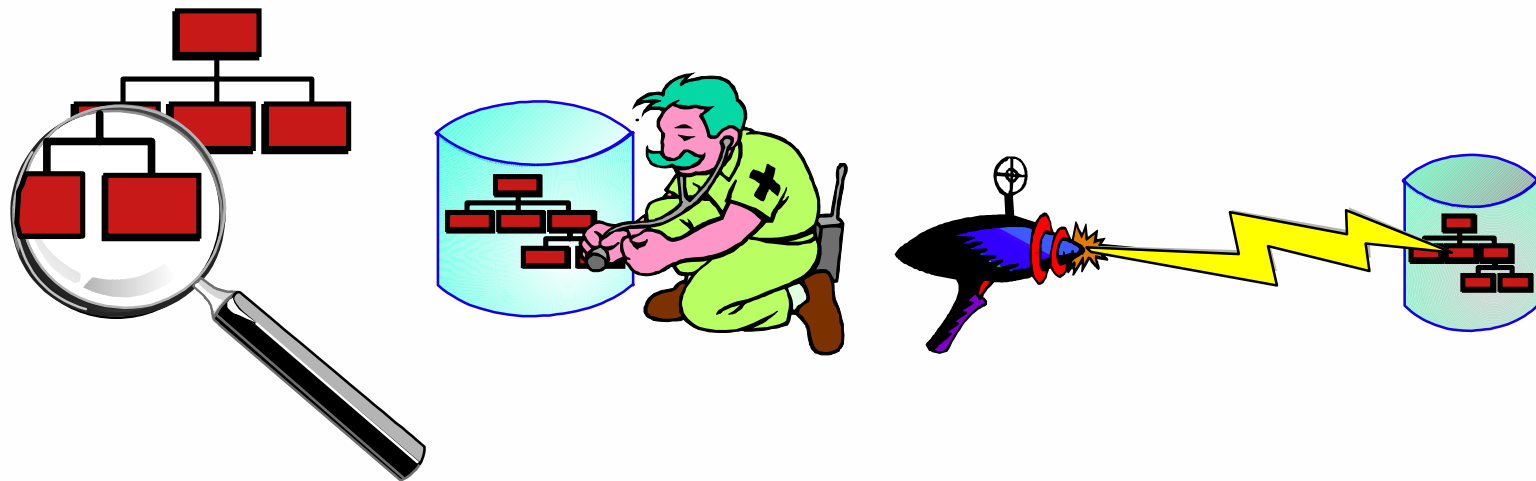

IMS HP Pointer Checker

- Replaces DBT SMU key components (Pointer Checker, Space Monitor)
- Executes on DB or image copy
 - ▶ including H/W Concurrent Copy of IMS V6
- Also includes
 - ▶ HD Tuning Aid,
 - ▶ DB Historical Data Analyzer, and
 - ▶ DB Segment Restructure Utility



Reports include:

- Segment and Pointer Statistics
- Bit Map Displays
- Free Space Maps
- FSE Analysis
- HD Tuning Statistics Report
- DB Record Distribution Statistics Report
- Pointer Validation Reports
- Database Repair Guidelines Report (if necessary)
- Root Allocation Reports (by block and RAP)
- Space Analysis and Data Set Reports (including non-IMS datasets)
 - ▶ includes space exception reports

Space Monitor Exception reporting:

New thresholds can be monitored and reported

- available extents
- CI and CA splits
- used space as % of allocated space
- in last extent (DB or DSet)
- No. of days since last reorg

DB Repair Facility



- Supports All IMS Databases
 - ▶ VSAM , OSAM and Fast Path DEDB DataBases
 - ▶ Full Function
 - ▶ HALDB
- Interactive via an ISPF front-end
- Includes
 - ▶ Pointer navigation
 - ▶ Display RAPs within Block or CI
 - ▶ Display FSEAP and FSE Chain within Block or CI
 - ▶ Backout safety feature
 - ▶ Audit history

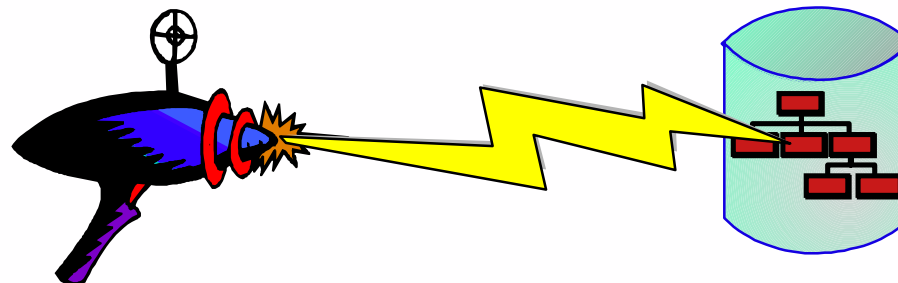

IMS High Perf. Change Accumulation

- New tool
- Functionalities
 - ▶ Parallel execution of multiple IMS CA jobs in a single address space.
 - ▶ Parallel streaming of both input and output data
 - Input data from RLDS's
 - Output data to new CA's datasets
 - Single pass of input/output
 - ▶ ISPF and Batch Interface
 - ▶ Automatic submission
 - ▶ Full DBRC Support

IMS HP CA provides an environment in which multiple CA jobs can be run in parallel, instead of in sequence.

Other DB Administration Tools

- Library Management Utilities 5655-E04

- ▶ DBD/PSB/ACB Mapper
- ▶ DBD/PSB/ACB Compare
- ▶ DBD/PSB and ACB Reversal

V8
Support



V8
Support

- IMS Advanced ACB Generator 5655-E05

- ▶ Replaces "Fast ACBGEN" tool and standard IMS ACBGEN utility
 - Much faster
 - Better reporting (eg. PSB and DBD size distributions)
- ▶ Includes ACBLIB Analysis Utility
 - Verify that all members are at the same IMS level
 - Verify that ACBLIB contains no PSB, no DBD, only ACB
 - Reports

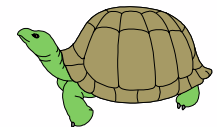

■ cont....

***Include full support
for HALDB***

IMS Data Base Control Suite V2 5655-F76

- Intuitive ISPF Front-end integrates control of DB Administration activities
- Supports Full Function, HALDB, and Fast Path DBs
- Exploits IMS Base Utilities and/or IBM High Performance Tools
- IMS DB Control Suite for z/OS V2.2 highlights are:
 - ▶ Performance improvements during the GENJCL process
 - ▶ The Build process during which JCL skeletons for utilities are built is no longer required
 - ▶ A new Index Recovery function to be used with IMS Index Builder for z/OS
 - ▶ A new Image Copy Recovery function to be used with IMS Image Copy Extension
 - ▶ The ability to generate JCL to execute the IMS Database Image Copy 2 Utility (DFSUDMT0).
 - ▶ ISPF interface to IMS High Performance Change Accumulation Utility
 - ▶ A new user-friendly multifunctional DBRC user interface
 - ▶ A function which allows for migrating from V2R1 Table Library to V2R2 Table Library is provided.
 - ▶ Reduced work data set requirements which result in less storage management overhead



Fast Path Basic Tools 5655-E30

- DEDB Unload/Reload
 - ▶ DB AREA dynamically allocated
 - ▶ Full DBRC interface
 - ▶ Concurrent initialization and reload of Multiple DEDB Area Data Sets (MADS)
 - ▶ Includes support for SDEPs
 - ▶ Allows migration to/from HDAM
 - ▶ Provides an API for reading/writing unload data set
- DEDB Pointer Checker
 - ▶ On area dataset or IC
 - Includes support for Hardware Concurrent Copy (IMS V6)
 - ▶ DBRC interaction and Dynamic Allocation
 - ▶ SDEP space utilization analysis
- DEDB Tuning Aid
 - ▶ For predicting effects of a DB change
 - works as an extension of the pointer checker



Fast Path Online Tools 5655-F78

- DEDB Online Pointer Checker
 - ▶ Online interface to DEDB Pointer Checker and DEDB Tuning Aid
 - ▶ Runs in a Fast Path Utility dependent region
 - ▶ Produces report of pointer errors (choice of fast scan or in-depth analysis)
 - ▶ Optionally creates set of sequential files which are input to DEDB Pointer Checker (or DEDB Tuning Aid) for space usage analysis, etc
 - ▶ Optionally creates a Concurrent Image Copy
- DEDB Online Data Extract
 - ▶ Easy-to-use, flexible tool for extracting data for data reporting and populating test data bases
 - ▶ Uses locking to ensure data consistency
 - ▶ Extraction criteria allows one or more tests of segment data at multiple locations
 - can extract all or subset of each selected segment
- DEDB Online Area Extender
 - ▶ Enables increasing size of SDEP part, IOVF part, or both while Area is online

IMS ETO Support Tool 5655-E12

- The Extended Terminal Option (ETO) of IMS was designed to be easy to implement
 - ▶ But, users discovered application dependencies on terminal related names
- Consequently (and for other reasons) ETO implementation usually requires the use of various ETO Exits
 - ▶ must be written in assembler
- The ETO Support Tool allows you to define your ETO requirements in a DB which is read into in-memory tables
 - ▶ no exits need be coded
 - ▶ DB can be updated via batch or IMS transaction
 - ▶ tables can be dynamically refreshed
- Includes command/keyword security
 - ▶ checking by RACF (or equivalent)
 - ▶ or by ETO Support Tool itself

◆ Supported options include

- ▶ **Auto-sign-on**
- ▶ **Pre-ETO sign-on messages**
- ▶ **Userid suffixing for multiple signons by same user**
- ▶ **Cleanup of IMS Conversations at Sign-off**

IMS Command Control Facility 5655-F40

- Issue commands for IMS TM or IMS DBCTL systems
 - ▶ via a batch utility or from a TSO session via ISPF
- Process IMS commands in all or selected systems of an IMSplex using the batch interface
- Ensure successful processing of database /START, /STOP, /DBR, and /DBD commands
- Synchronize Online Change and database commands across all regions in a Sysplex using the batch command processor
 - ▶ “canned procedures” provided for coordinating online change, and deleting messages on dead letter queue

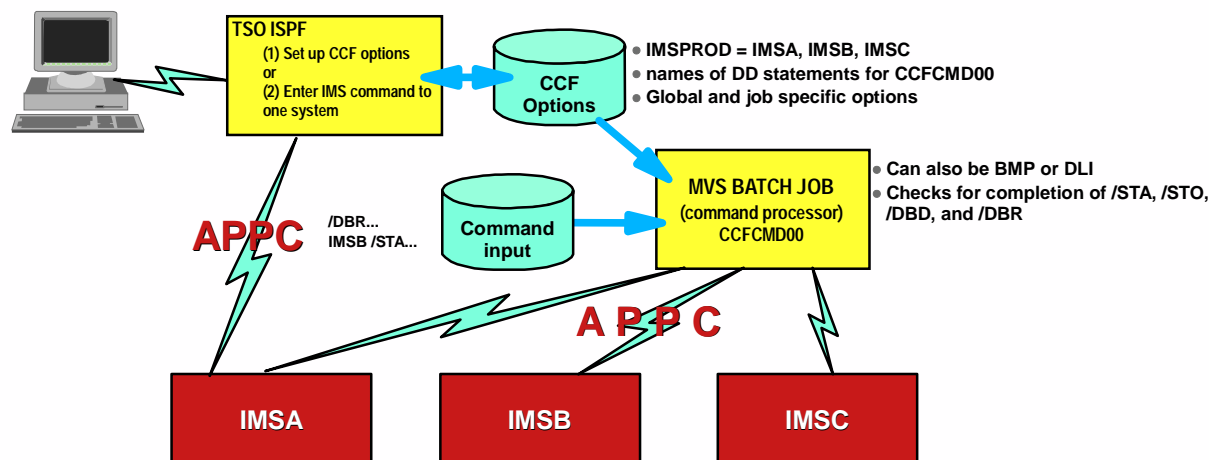

A similar implementation is possible with DBCTL systems, except that CCF uses APPC to communicate with a BMP, which in turn issues ICMD and RCMD commands. However, it is not possible to check for completion of DB commands (using DFS0488I)

IMS Batch Backout Manager 5697-H75

- Automation of the batch backout process after application abends
 - ▶ Dynamically allocates an interim SLDS for Log close
 - ▶ Closes the interim batch SLDS
 - ▶ Dynamically allocates the new batch SLDS for backout
 - ▶ Performs the batch backout
- Additional functions:
 - ▶ Forces allocation of batch SLDS for jobs with no logs allocated (by specific or generic job name)
 - ▶ Forces DBRC=Y (or DBRC=N) for IMS batch systems not generated with DBRC=FORCE

Other DB Administration Tools

- IMS Sequential Randomizer Generator 5655-E11
 - Analyzes DB keys and DB record lengths to produce a sequential randomizer for a DEDB or HDAM DB
 - Enables high performance access of DB with both direct and sequential processing
- IMS Hardware Data Compression - Extended 5655-E02
 - Enhances facilities available in IMS itself
 - Works on Image Copies, High Performance Unload files and IMS Unload files
 - Includes sample Compression Dictionaries
 - Enables effectiveness of existing dictionaries to be assessed
 - Allows monitoring of dictionary effectiveness over time
 - Builds DBD and Reload JCL

IMS Tools for ...

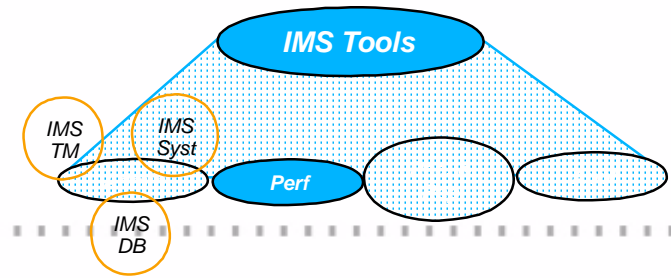

IMS Performance Management

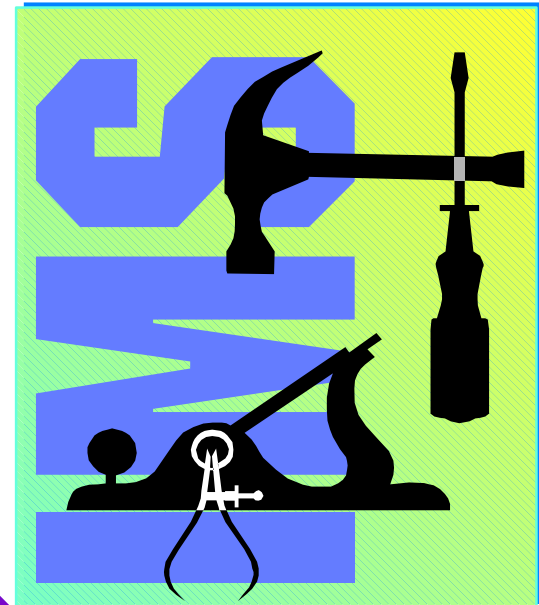

IMS Performance Analyzer V3 5655-E15



- The standard for IMS Resource and performance management
 - ▶ IMS Log and IMS Monitor Analysis Tool
- Supports IMS TM, IMS DBCTL or IMS Batch
- Can use GDDM to graph extracted data or download it to a PC
- In addition, V3.2 provides
 - ▶ Improved Monitor Reporting
 - External Subsystem statistics incorporated into Region and Program reports
 - Alternative sequence of reports by Usage or Delay
 - Enqueue/Dequeue Trace Report enhanced to allow easier identification of conflict candidates
 - ▶ Enhanced Log reporting
 - New Transaction Trace Report to show all log records for selected transactions
 - Transaction Exception Report extended to include report sequencing on additional categories, Message Source, LTERM, VTAM Node, etc.
 - Extract capability extended to more reports
 - ▶ New Log and Monitor reports to "health check" your system
 - ▶ Enhanced DBCTL reporting
 - ▶ Documentation enhanced to include performance troubleshooting and tuning recommendations

User specifies required reports and resources to be reported on, using ISPF

IMS Network Compression Facility

- Replaces and enhances IMS Data Stream Tuner
 - ▶ Support for IMS V6 and IMS V7
- Functionalities
 - ▶ Compression of LU2 (3270) outbound data streams
 - Compression of all repeated characters
 - Elimination of non-display fields
 - ▶ IMS specific (not VTAM) solution
 - ▶ Improvement of the transaction response time to the user
 - ▶ Easy installation
 - ▶ No IMS or MFS changes needed
 - ▶ ISPF Facility
 - Display statistics and options
 - Update currently used options
 - Trace data streams

IMS Queue Control Facility 5697-D69



- Supports both **DASD Queues** and **Shared Queues**
- Traditional Functions
 - ▶ IMS message queue recovery after a cold start
 - ▶ IMS application program recovery
 - ▶ IMS stress, regression and application testing
 - ▶ Port messages to other IMS systems
- Queue Management
 - ▶ "Very Long Message" Detection & Management
 - For Non-Shared Queues, QCF monitors processes that exceed user specified message queue usage and allows these processes to continue, be aborted or be WAITed to prevent exceeding the message queue limits
 - TSO/ISPF interface provides panels to look at and manage tasks (and their messages) that have been WAITed by QCF
 - ▶ General Queue Management (via ISPF or batch, for shared or non-shared queues)
 - look at queue status
 - list, view, copy or move messages off the IMS message queues (while IMS is active)
 - load messages onto the queues



IMS Buffer Pool Analyzer 5697-H77

- Helps you tune your IMS Database Buffer Pools
 - ▶ Gathering component uses GTF for I/O info
 - ▶ Modeling component analyzes GTF data to provide statistical analysis of the impact of changes affecting buffer pools
 - Will additional buffers improve the performance of a given buffer pool ?
 - Will fewer buffers improve the performance of a given buffer pool ?
 - Model buffer pool usage to estimate I/O rates
 - Identifying databases which most heavily use each database sub pool
 - Performing "what if" scenario analysis

IMS Workload Router V2.3 5697-B87

- Non-Sysplex Environment
 - Exploit benefits of MSC for workload distribution
 - Allow transaction affinity routing
- Sysplex Environment
 - Balance transaction workload in Sysplex
 - Allow transaction affinity routing
 - Exploit IMS cloned resource environment
 - Connect two or more Parallel Sysplex
- V 2.3 enhancements
 - IMS Version 8 support
 - Support for greater than 100 links

“Puts comprehensive resource information at your fingertips and helps you spot and resolve potential problems before they become critical”

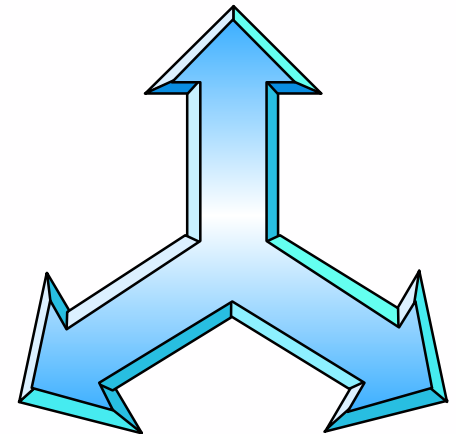

IMS Tools for ...

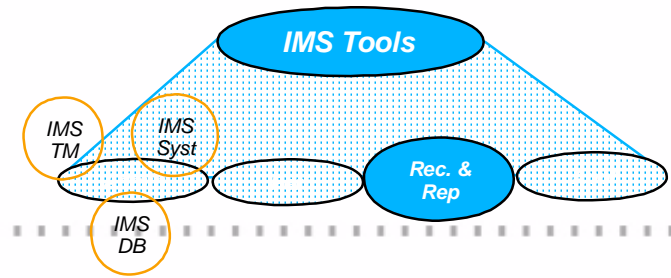

IMS DB Recovery and Replication

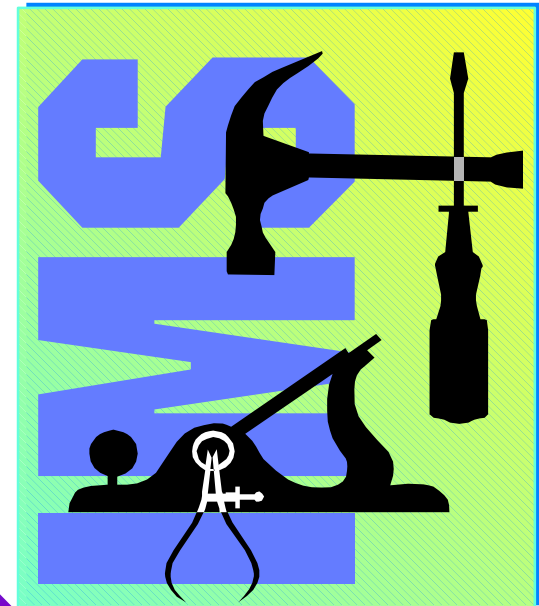

IMS Recovery Related Tools

- Basic IMS Recovery Related Utilities
 - ▶ IMS Image Copy Extensions
 - ▶ IMS DEDB Fast Recovery
- Enhanced Solutions
 - ▶ Application Recovery Tool for IMS and DB2
 - ▶ Online Recovery Service (ORS)
 - ▶ High Performance Change Accumulation



IMS Image Copy Extensions 5655-J56



V8
Support

- High Performance Batch or Concurrent Image Copy
 - ▶ Pointer checking during batch image copy or compressed image copy
 - Pointer Checking requires the use of the High Performance Pointer Checker tool
 - ▶ Stacking of multiple output datasets
 - ▶ Copying of DBRC DBDS and CAGRP Groups
- Can use Dynamic Allocation for all input and output datasets
 - ▶ one set of ICE JCL can be used for all image copies and recoveries
 - ▶ can be used with or in place of DBRC GENJCL facilities
- Enable image copy and hash check in a single step (for full function DBs or DEDBs) (UQ52882)
- New function 'Creation Image Copy' creates copies from:
 - ▶ IMS standard Image copy data set
 - ▶ Image Copy Extensions compressed image copy data set
 - ▶ IMS Online Image Copy data set
 - ▶ IMS Image Copy 2 data set
- Creates up to seven copies from the original data set at one time.

IMS DEDB Fast Recovery 5655-E32

- Avoids full DEDB AREA recoveries during enforced cold start
 - Closes the IMS Online Log
 - Recovers all DEDBs (using the log)
 - Produces status listing of the necessary subsequent system recovery activities
- Ver 2.2 Now supports multiple IMS releases from a single Load Library
- Ver 2.2 Supports IMS Version 8

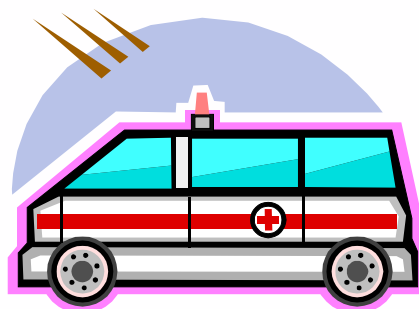

Application Recovery Tool for IMS and DB2 5697-F56

- Primary function is to generate and run all the jobs necessary to recover a set of IMS and/or DB2 databases to a common point of consistency
 - complements IMS Recovery Saver in this respect
 - ▶ Provides a function for creating point of consistency across IMS and DB2
 - called a “Virtual Image Copy”
 - Interacts with online IMS and WAITs for BMPs to complete if updating any DB in set, issues /DBDs and checks for completion, Optional OLDS switch and /STA DBs
 - ▶ Also provides facilities for registering or changing DBRC DB information, taking image copies, performing change accumulation, tidying and reorganizing RECONS
- Enhancements for IMS Applications
 - ▶ Support for HALDB in IMS V7
 - IMS Version 8 support will be added via PTF
 - ▶ Support for IMS SYSPLEX data sharing
- Enhancements for DB2 Applications
 - ▶ Index copies and objects with the DEFINE NO option supported
 - ▶ Parameter list IX has been added to the DRMFIC and DRMRECOV functions

Online Recovery Service (ORS) 5655-E50



- Online Commands used to
 - ▶ Build list of DBs/AREAs to be recovered
 - ▶ Start recovery for a list
- Online IMS is used to recover IMS database data sets
 - ▶ Input data sets read in parallel
 - ▶ DB data sets recovered in parallel
 - ▶ Change accumulation input is optional -- even for a datasharing environment
 - ▶ Time stamp recovery to any time is supported
 - All committed updates prior to this time are recovered. Later updates are discarded.

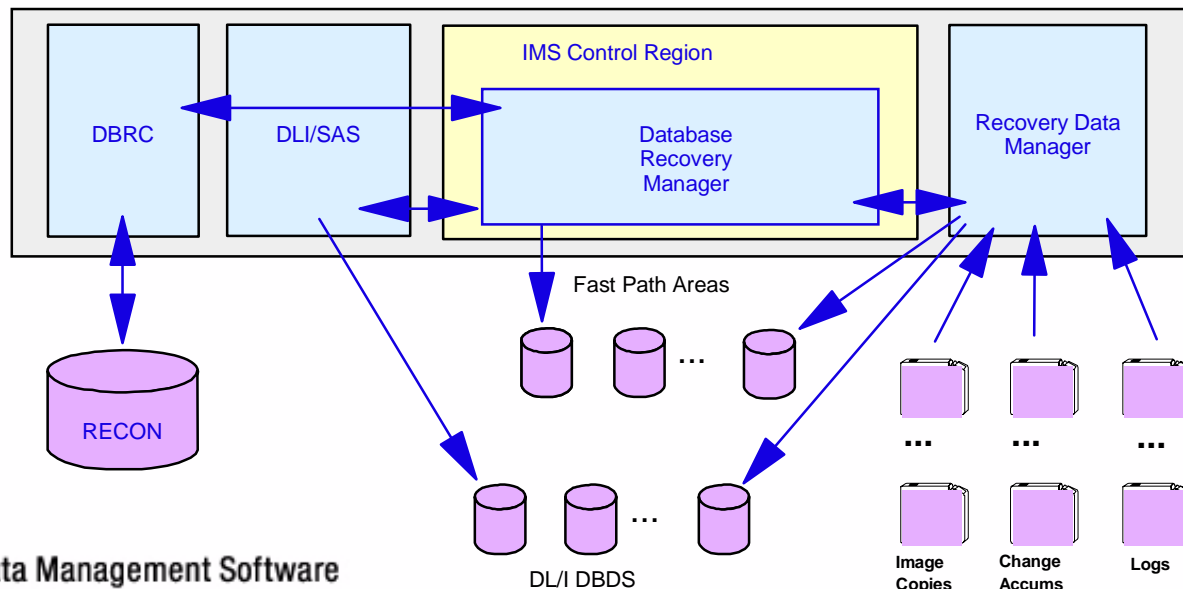

IMS DataPropagator V3 5655-E52

**V8
Support**

- Customer Needs
 - ▶ Decision Support
 - User access to stable data
 - Propagate only the data of interest
 - Exploit relational technology for query
 - ▶ Application coexistence
 - Two masters
 - Data in both systems synchronized
 - ▶ Application Migration
- Functionalities
 - ▶ IMS / DB2 MQSeries-based Data Propagation
 - Near Real-Time Asynchronous Propagation
 - Capture Component
 - Apply Component
 - Event Marker Facility
 - ▶ IMS Log based Asynchronous Propagation
 - ▶ IMS / DB2 Synchronous Propagation
 - ▶ DB2 / IMS Synchronous Propagation

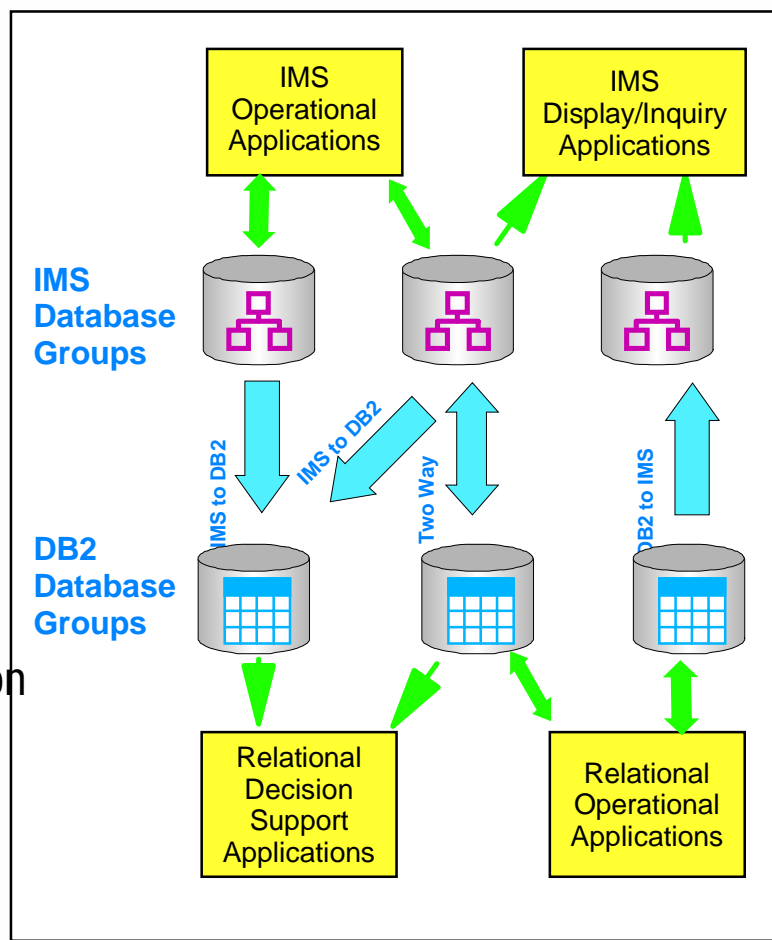

No Change to Existing Applications

IMS HP Change Accumulation 5655-F59

- Replaces the IMS Change Accumulation utility
 - ▶ Parallel execution of multiple IMS CA jobs in a single Job.
 - ▶ Parallel streaming of both input and output data
 - Input data from RLDS's
 - Output data to new CA's datasets
 - ▶ Single pass of input/output
 - ▶ Supports IMS V6 and V7
- ISPF and Batch Interface
 - ▶ Automatic submission

IMS HP CA provides an environment in which multiple CA jobs can be run in parallel, instead of in sequence.

IMS Tools for ...

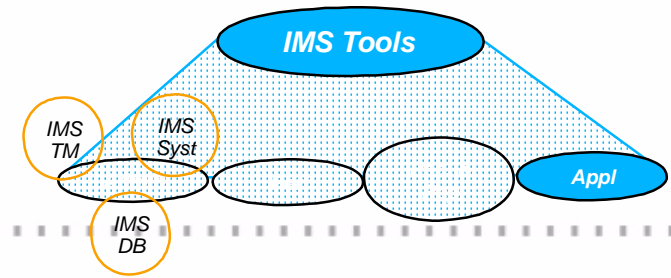

IMS Application Management

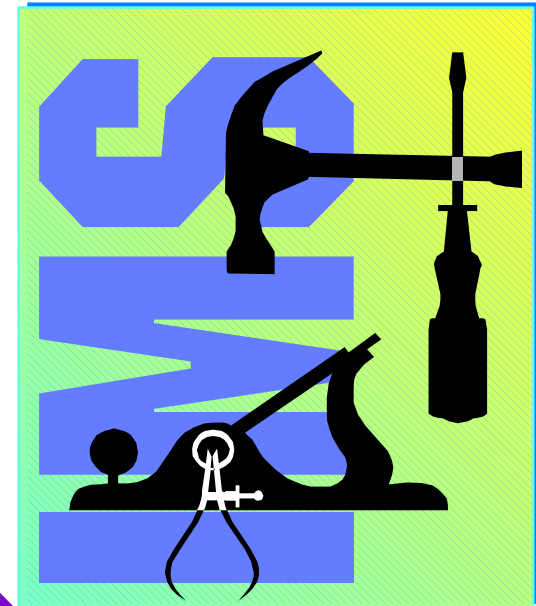

IMS Connect 5655-E51



- IMS Connect Address Space is the interface between TCP/IP and IMS transaction Manager
 - ▶ Replaces and enhances the IMS TOC
- IMS Connect can connect (via XCF) to any IMS systems in the sysplex
- Supports access to IMS by LINUX/390 applications
- The IMS Connector for Java (supplied with VisualAge for Java) enables Java Servlets or Server Pages (running in WebSphere Application Server) to access IMS transactions via IMS Connect

⊕ **IMS Connect has been benchmarked by IBM at 3,400 transactions per second (steady state; 4,000+ tps peak)**

- ★ with single IMS and single IMS Connect address space
- ★ 39% CPU

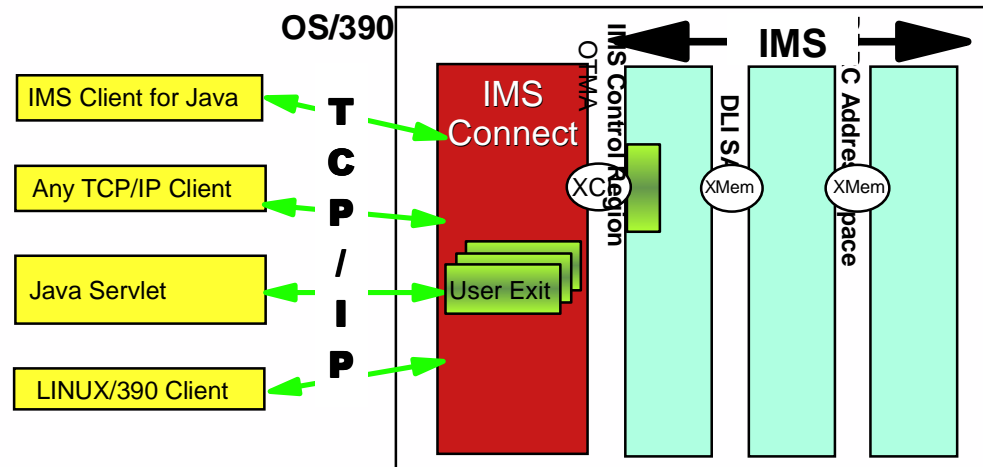

IMS Program Restart Facility 5655-E14

- Enhances IMS Application Extended Checkpoint/Restart facilities
 - ▶ For stand-alone batch and BMP
- Enables restart
 - ▶ on any system in sysplex
 - ▶ without changes to JCL
- Implementation of PRF requires no JCL changes
- Can be used to restart programs that do not abend but which end with a non-zero return code
- Can supply global parameters to all batch/BMP jobs (ie. without JCL changes)
 - eg. LOCKMAX=, DBRC=
- Is especially useful in a datasharing environment to provide JCL parameters
 - IRLM=, IRLMNM=
 - IMSGROUP=groupname + list of IMS ids in group
- Can be used to reduce overhead of applications that are taking too frequent checkpoints



IMS Message Format Services Reversal Utilities

- IMS Message Format Services (MFS) Utilities consists of two utilities
 - ▶ MFS Reversal
 - Convert MFS MID/MOD/DIF/DOF control blocks back into IMS MFS utility control statements
 - It also provides useful summary reports of the IMS FORMAT library, including the relationships among members
 - ▶ MFS Compare
 - The MFS Compare is designed to compare two sets of MFS *source* libraries to quickly highlight differences between them



Batch Terminal Simulator (BTS) V3.1 5655-J57

- V3.1 provides new functions and features
 - ▶ BTS Audit report program provides two functions
 - Generates the BTSIN control statement with the corresponding MFS associated with the MODNAME from IMS transaction log records ('01'X, '03'X)
 - Prints containing screen images of transactions including data, USER/LTERM identification, time stamp by extracting from BTSOUT
 - ▶ Supports JAVA language application under JBP region
 - ▶ Supports DB2 and WebSphere MQ call trace
 - ▶ Supports LU6.2/APPC
 - ▶ Supports /EXIT under LE/370
 - ▶ Supports Multiversion IMS from single BTS loadlib

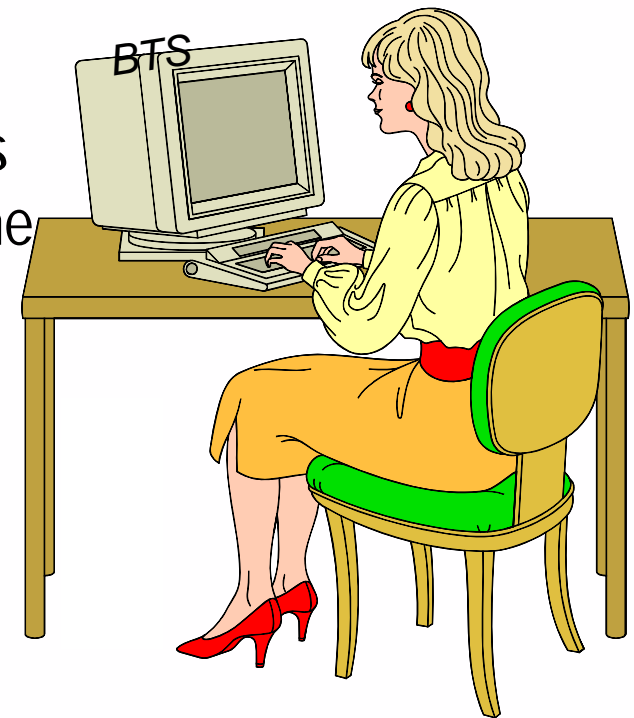

IMS Tools Product Plans - Beyond 2002

- Products 2003
 - ▶ IMS Online Reorganization Facility (new)
 - ▶ IMS Performance Monitor (new)
 - ▶ IMS Library Integrity Utilities (new)
 - ▶ IMS Data Propagator V4
 - ▶ IMS HP Pointer Checker V1.2
 - ▶ IMS Parallel Reorg V2.2
 - ▶ IMS Online Reorganization Facility R2
 - ▶ IMS Queue Control Facility V2
 - ▶ IMS Recovery Facility

- 2003 - Other Activities
 - ▶ IMS Version 9 QPP Support - all products
 - ▶ Look for more new function delivered as PTFs

- Products 2004
 - ▶ IMS Performance Monitor R2 (enhancements)

Product Plans - Beyond 2002

- IMS Online Reorganization Facility
 - ▶ BMP operation
 - ▶ Reorganization to copy
 - ▶ Auto Image Copy
 - ▶ Short outage to swap DBs
- IMS Performance Monitor
 - ▶ ISPF Front-end
 - ▶ Basic monitoring data (will add more later)
 - ▶ GUI front-end (possibly)
- IMS Library Integrity Utilities
 - ▶ Includes all features and function of Library Management Utilities
 - ▶ Includes integrity checker function
 - ▶ Provides consistency checking function
- IMS Data Propagator V4
 - ▶ GUI Front-end
 - ▶ MQSeries asynchronous IMS to IMS replication
 - ▶ IMS data extract support

Product Plans - Beyond 2002

- IMS HP Pointer Checker V1.2
 - ▶ Smaller records and other perf enhancements
 - ▶ Automatic Optimization of read buffer sizes
 - ▶ Work file buffer optimization and VSCR
 - ▶ Direct check - no merge
 - ▶ Use Acplib
- IMS Parallel Reorg V2.2
 - ▶ Integrated Image Copy
- IMS Online Reorganization Facility V1.2
 - ▶ HISAM support
- IMS Queue Control Facility
 - ▶ Extended function

Product Plans - Beyond 2002

- IMS Recovery Facility
 - ▶ Extends ORS
 - ▶ Batch and Online operation
 - ▶ Integrated Image Copy
 - ▶ Recovery Tape Pull list
 - ▶ Find possible recovery points - quiet times
 - ▶ Disaster Recovery
 - ▶ IDCAMS Del/Def
 - ▶ Test Environment data create
 - ▶ Integrated Index Builder in Recovery

IBM IMS Tools for IMS Version 8.1

- 5655-A14 Batch Terminal Simulator V2 + UQ62360
- 5655-E02 Hardware Data Compression Ext V2.2 + UQ59607
- 5655-E03 DB Repair Facility
- 5655-E04 Library Management Utilities + UQ61449
- 5655-E05 Advanced ACB Generator + UQ63355
- 5655-E06 High Performance Unload + UQ63489
- 5655-E07 High Performance Load + UQ63485
- 5655-E09 High Performance Ptr Checker + UQ63507
- 5655-E10 Image Copy Extension + UQ66270
- 5655-E11 IMS Sequential Randomizer Gen.
- 5655-E12 IMS ETO Support V2.2 + UQ65127
- 5655-E14 Program Restart Facility + UQ66680
- 5655-E15 IMS Performance Analyzer V3.1 + UQ62098
- 5655-E24 IMS Index Builder V2R1 + UQ65633
- 5655-E24 IMS Index Builder V2R2

IBM IMS Tools for IMS Version 8.1 (cont)

- 5655-E30 Fast Path Basic Tools V1 R2 + UQ63492
- 5655-E41 Network Compression Facility + UQ64522
- 5655-E50 Online Recovery Service + UQ63821
- 5655-E51 IMS Connect V1 R1
- 5655-E51 IMS Connect V1 R2
- 5655-E52 IMS Data Propagator V3 R1 + UQ64207
- 5655-F40 Command Control Facility + UQ64521
- 5655-F43 HP Sysgen Tools + UQ64518
- 5655-F45 MFS Reversal
- 5655-F59 HP Change Accumulation + UQ66240
- 5655-F74 IMS Parallel Reorganization + UQ68770
- 5655-F76 DB Control Suite V2 R1 + UQ64974
- 5655-F78 IMS Fast Path Online Tools V2 R1 + UQ68420
- 5655-I01 HALDB Conversion Tool
- 5655-I15 High Performance Prefix Resolution V2 R1

IBM IMS Tools for IMS Version 8.1 (cont)

- 5697-E99 IMS Queue Control Facility V1R1 + UQ60536
- 5697-E99 IMS Queue Control Facility V1 R2
- 5697-H75 IMS Batch Backout Manager
- 5655-J57 IMS Batch Terminal Simulator V3 R1
- 5697-H77 IMS Buffer Pool Analyzer
- 5655-F76 IMS Database Control Suite V2 R2
- 5655-E32 IMS DEDB Fast Recovery V2 R2
- 5655-J56 IMS Image Copy Extensions V2 R1
- 5655-E24 IMS Index Builder V2 R3
- 5655-E15 IMS Performance Analyzer V3 R2
- 5697-B87 IMS WorkLoad Router V2 R3

Summary

- **IBM IS IN THE TOOLS BUSINESS**
- We have made significant investments in these products
- We have been delivering new products and features in short order
- We remain flexible and responsive to customer needs
- We have a long term commitment to IMS and IMS tools

Summary

- **Where to find additional IBM Data Management Tools Information**
 - ▶ **Announcements**
 - <http://www-3.ibm.com/software/data/db2imstools/announce.html>
 - ▶ **List of IBM Data Management Tools**
 - <http://www-3.ibm.com/software/data/db2imstools/>
 - ▶ **NEW News**
 - <http://www-3.ibm.com/software/data/db2imstools/news.html>
 - ▶ **E-Mail**
 - ecrohde@us.ibm.com