

DB2 and IMS Technical Conference

5 - 9 March 2001, Hamburg, Germany



IMS: Leading the 21st Century for e-Business and all of your Business Needs



Robert Gilliam
IMS Family Product Manager



www.ibm.com/ims

IMS Customers World-Wide

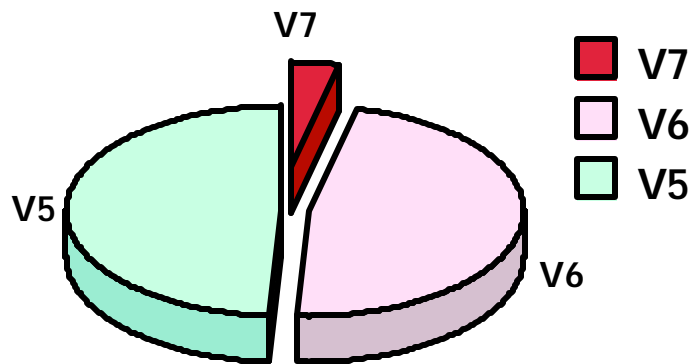
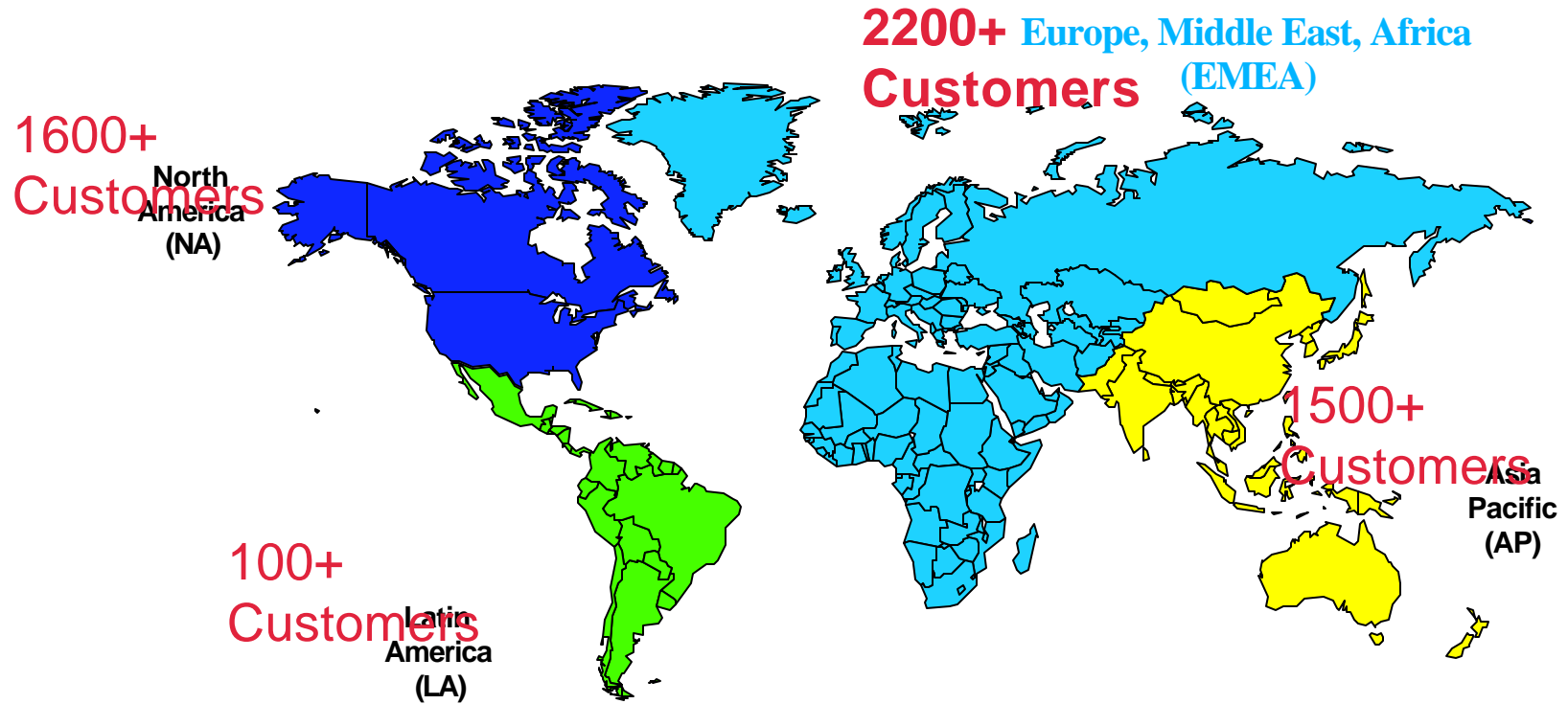

The World Depends on It !!

..shown good base code stability..."
Marge Harvey / Jim Chamberlain
Toronto Dominion Bank

e-business Powered by IMS



...the migration was achieved non-disruptively during our prime shift..."
Juergen Berghaus
GAD

an essential stepping stone to meet the future business and availability challenges at Barclays..."
Aly Bremner
Barclays

"...delivers cost savings and improved availability."
Tucson Medical

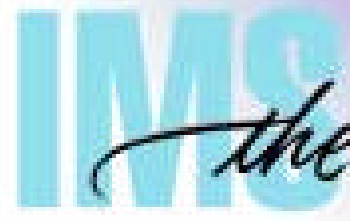

the world depends on it

"...very satisfied with the base functions..."
Stephan Nostadt
Deutsche Telecom

"... a still large and loyal IMS installed base due to the rock solid reputation ..."
Gartner Group report

CUSTOMERS

Service and Services

Application Development & APIs

IMS "Core"

Database & Transaction Management

IMS & DB2 Tools

CUSTOMERS

Service and Services

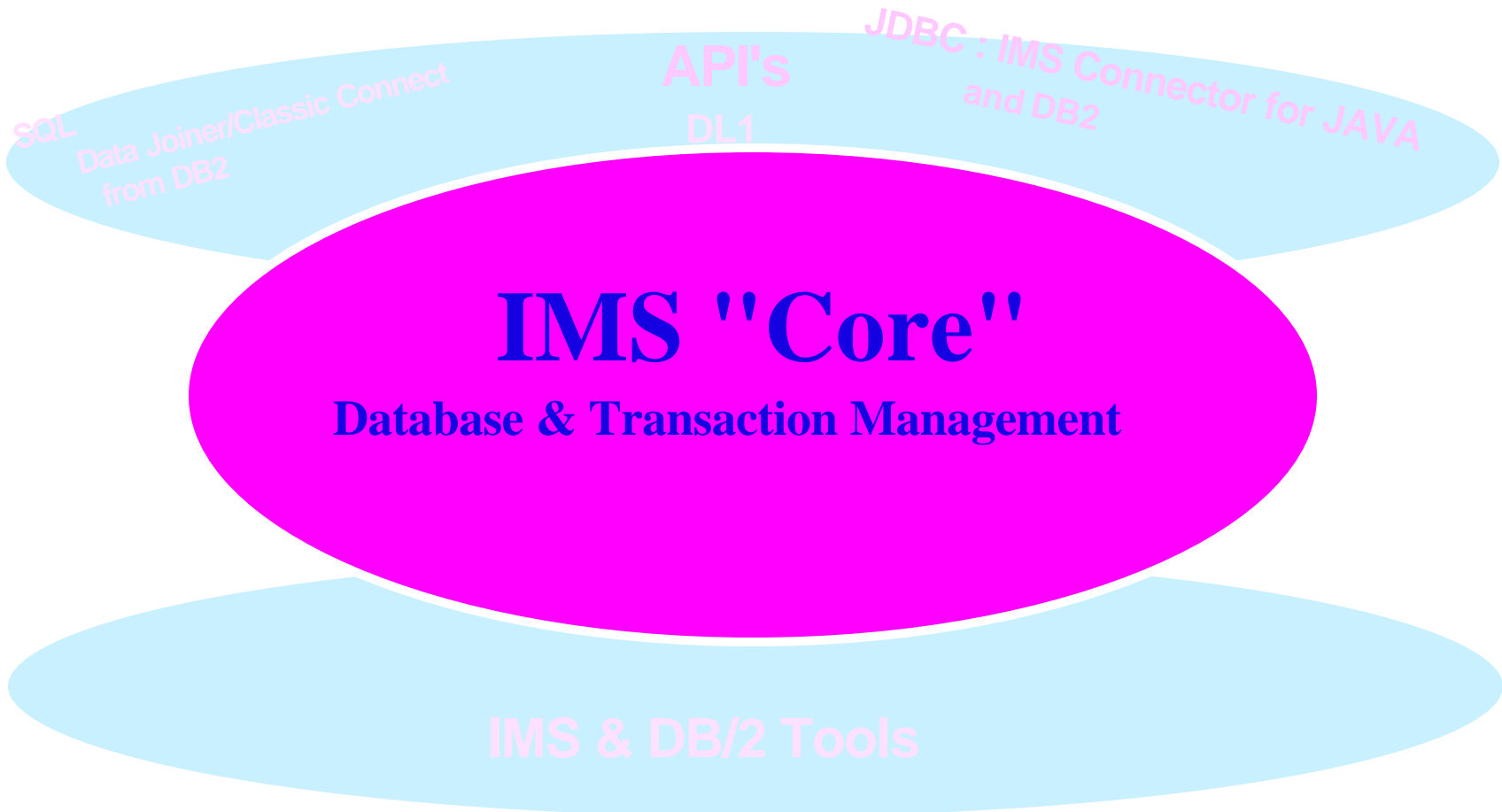

IMS Version 7



Availability

- Rapid Network Reconnect
- Enhanced Shared Queues/FP sharing
- SLUP session status
- RECON Upgrade/Coexistence
- I/O toleration
- Fast Path MADS enhancements

Performance/Capacity

- High Availability Large Database support
- DB Fiber Channel support
- DBRC enhancements
- Large DBRC Recon Record support
- MSC Descriptor Limit
- New Exits
- New execution parameters
- ACBGEN capacity/perf enhancements
- Fast Path Monitor support

Systems Management

- Tivoli Readiness
- ETO Autologon and Printer enhancements
- SHQs Associated Printer support
- RACF PassTicket
- USERID/LTERM clarification
- Deferred ACB open
- MSC exit usability enhancements
- Diagnostics/Serviceability enhancements
- Compatibility enhancements
- Installation enhancements
- Commands enhancements
- Migration
- Additional Operator Information
- Logger enhancements

IMS Version 7e



1) WEB Application Integration

2) Distributed Applications

Linux Enabled

Multi-platform



3) Absolutely NO size limitations

IMS V7 Rapid Network Reconnect *for IMPROVED AVAILABILITY*

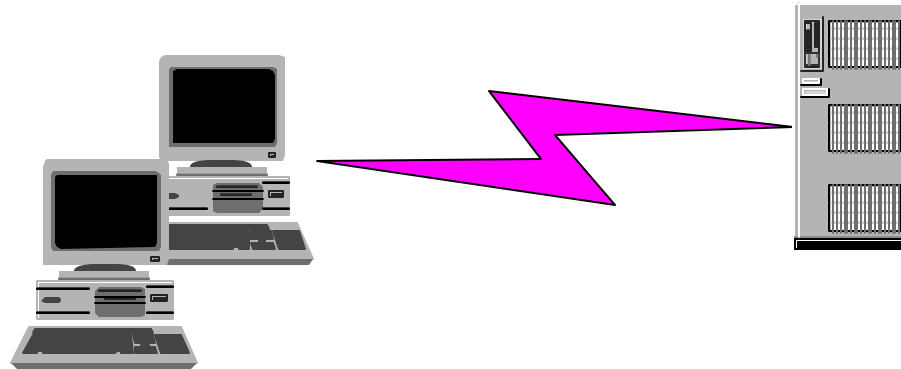

- ✓ Provides reduced network reconnect time after IMS, MVS, or VTAM failure in a sysplex environment
- ✓ Permits IMS TM to automatically reconnect terminal sessions following any kind of IMS failure and subsequent IMS restart

IMS V7 High Availability Large DB Support

for IMPROVED CAPACITY & DATA AVAILABILITY

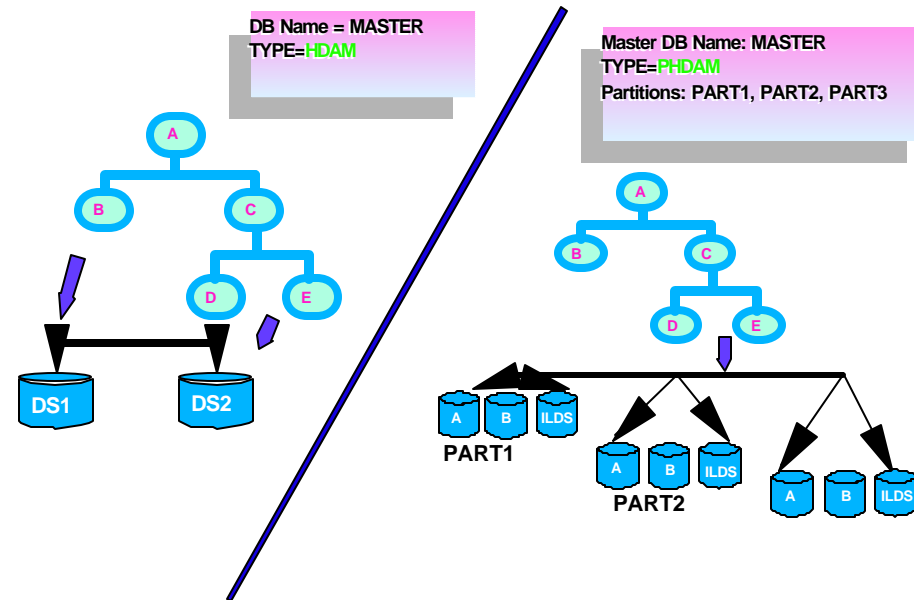

- ✓ Extends IMS Full Function database size
 - ➔ 1001 Partitions x 10 data set groups x 4G = 40 Terabytes
- ✓ Provides data availability through partition independence
- ✓ Provides easier manageability with smaller partitions of the database

CUSTOMERS

Service and Services



IMS Systems/Data Management Tools

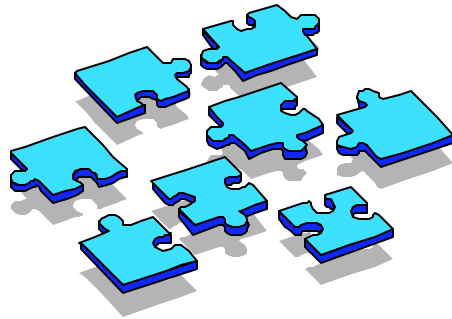

■ Administration

- ▶ IMS High Performance Load
- ▶ IMS High Performance Unload
- ▶ IMS Index Builder
- ▶ IMS Fast Path Basic Tools
- ▶ IMS Fast Path Online Tools
- ▶ IMS ETO Support
- ▶ IMS Library Management
- ▶ IMS Advanced ACB Generator
- ▶ IMS DB Repair Facility
- ▶ IMS HD Compression -Extended
- ▶ IMS High Performance Pointer Checker
- ▶ IMS High Performance Prefix Resolution
- ▶ IMS Sequential Randomizer Generator

■ Application Management

- ▶ IMS Program Restart Facility
- ▶ IMS Connect

■ Database Recovery and Replication Management

- ▶ IMS DEDB Fast Recover
- ▶ IMS Image Copy Extensions
- ▶ IMS Recovery Saver
- ▶ IMS Data Base Recovery Control Facility

■ Database Performance Management

- ▶ IMS Performance Analyzer
- ▶ IMS Queue Control Facility



IMS Online Recovery Service

for IMPROVED AVAILABILITY

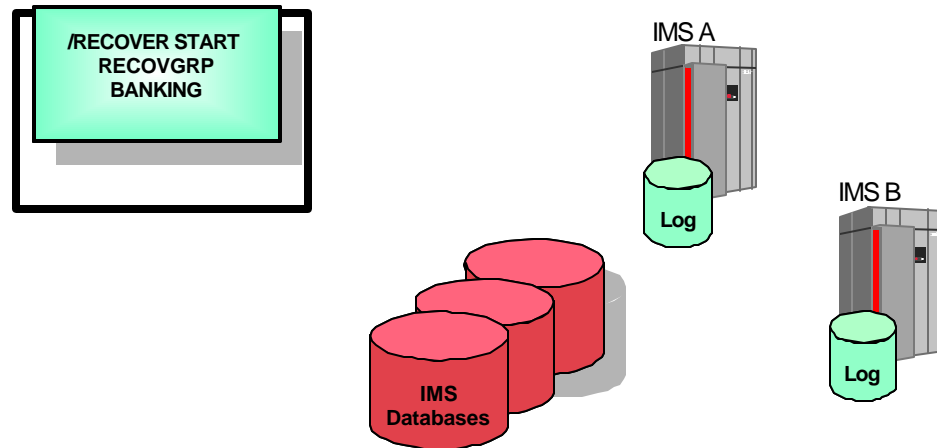

- ✓ **Increased performance in recovery situations**
 - Reduce the time that critical databases are unavailable
- ✓ **Increased flexibility in recovery options**
 - Perform 'logical recoveries' - true **Point-In-Time recovery**
- ✓ **Increased simplicity of the recovery process**
 - IMS manages the recovery

Significant decrease in DB Recovery Times - up to 4 times



IMS Connect

for High Performance access to IMS

- ✓ High performance with persistent sockets
- ✓ Excellent Serviceability with Dump formatting enhancements
- ✓ Manageability with SMP/E installability
- ✓ Unicode Support
- ✓ Local support

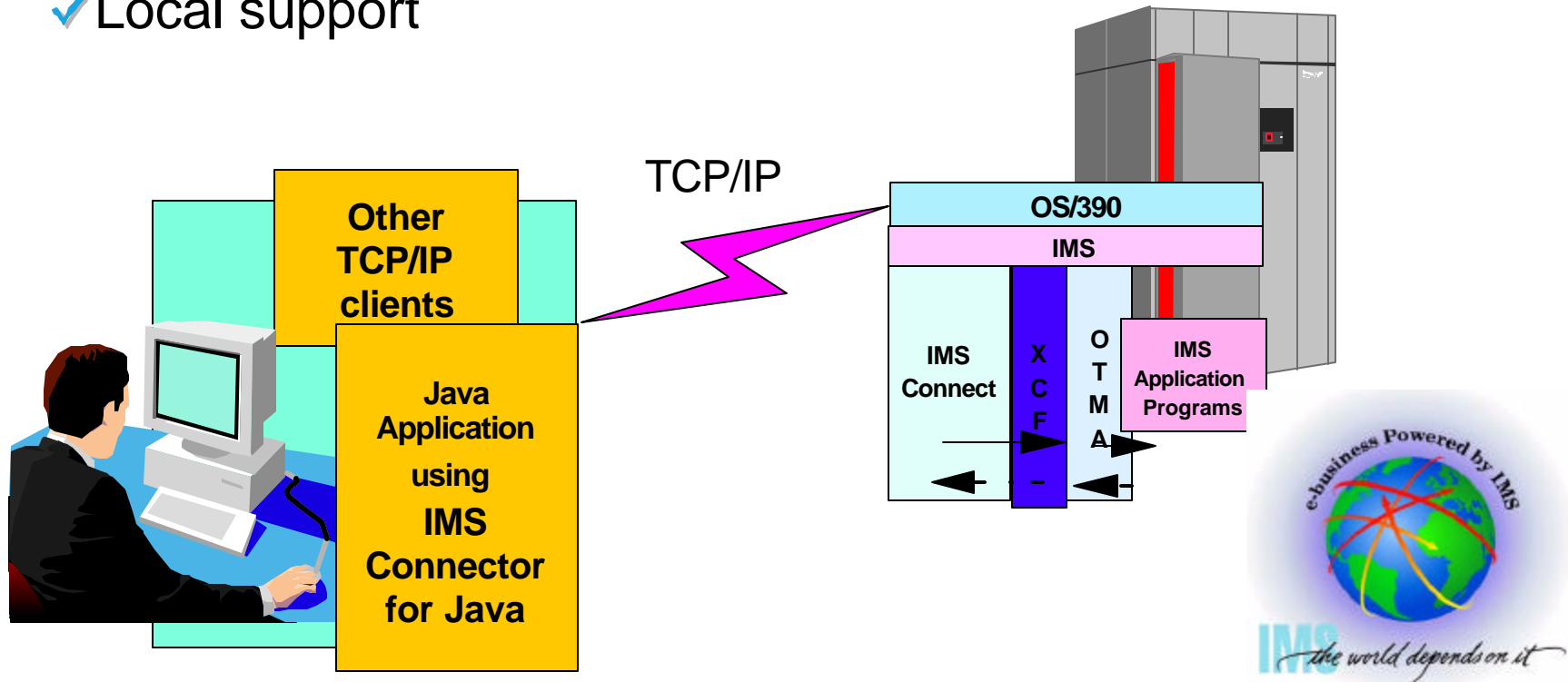

Web-Enablement

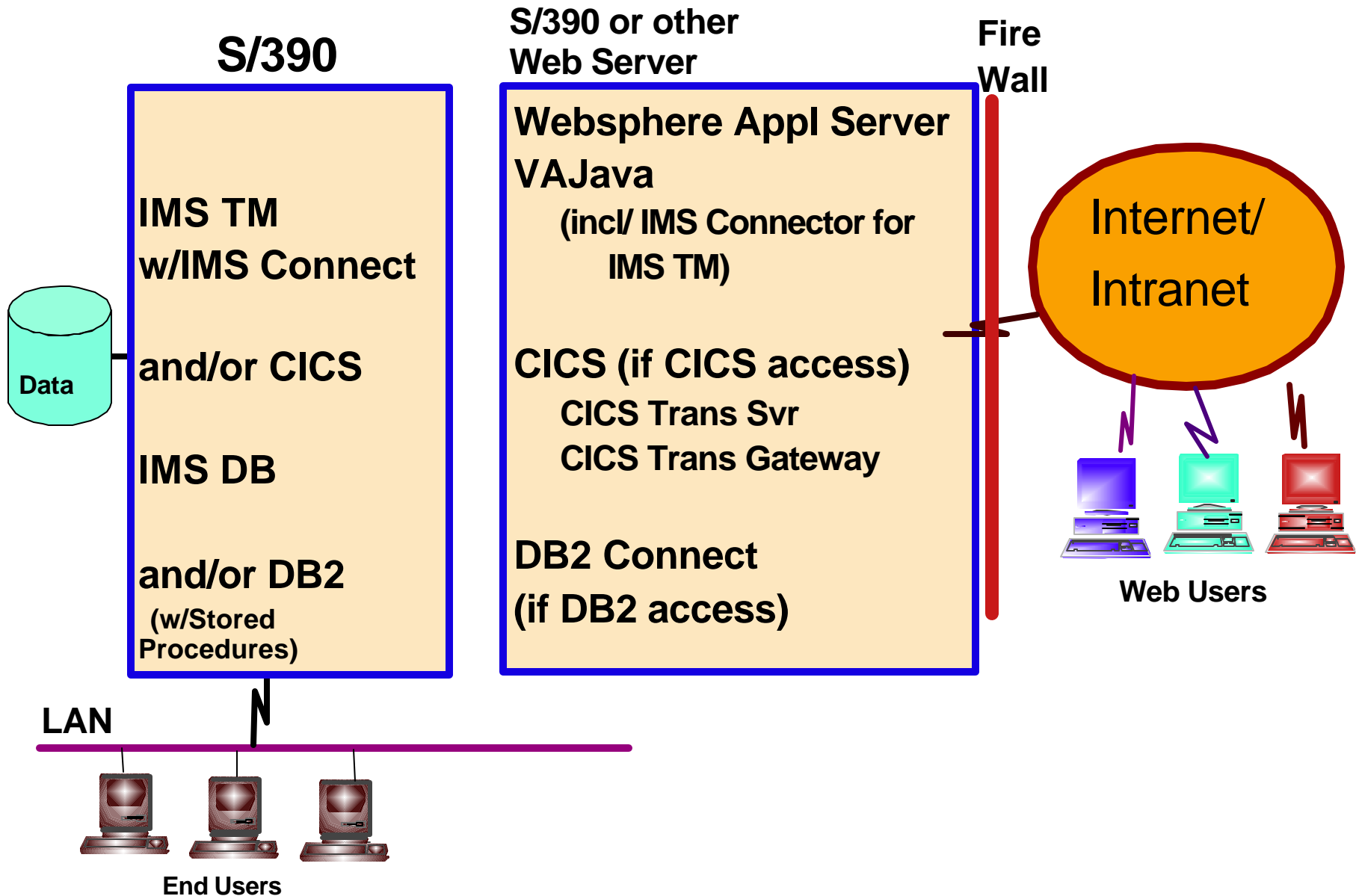

CUSTOMERS

Service and Services

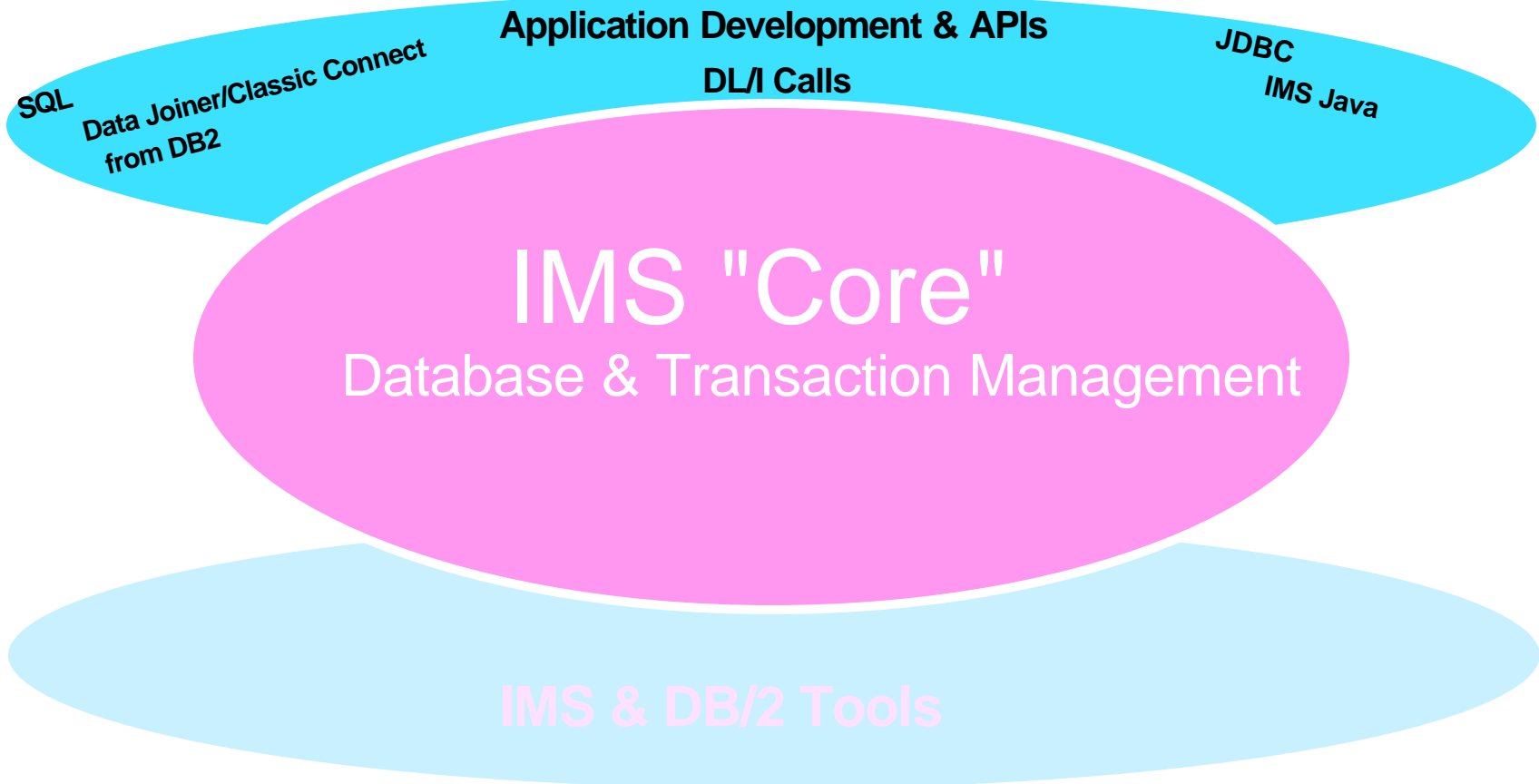

IMS V7 Java for Integrated e-Business *Application Development*



✓ Application programmer productivity

- Skills
 - Java access to IMS input/output message queues
 - JDBC to access IMS DB and DB2 data
 - Expanding for WAS, CICS & DB2 Stored Proc
- Tools
 - Uses VisualAge tools for development

IMS Connector for Java

- Helps customer make the transition to e-business by providing **easy Java access** to IMS transactions
- Create Java applications or servlets that can access existing IMS transactions by using **JAVA beans**
- Provides CCF-compliant **Java Class libraries** which interact with IMS via the IMS Connect on the host
- Provides **Java bean classes** to aid in visually composing applications.
 - ▶ Applications can be easily and rapidly built by 'wiring' the Java beans and components together using the **VisualAge for Java** visual development tool.
- Ships with **Visual Age for Java Enterprise Edition**

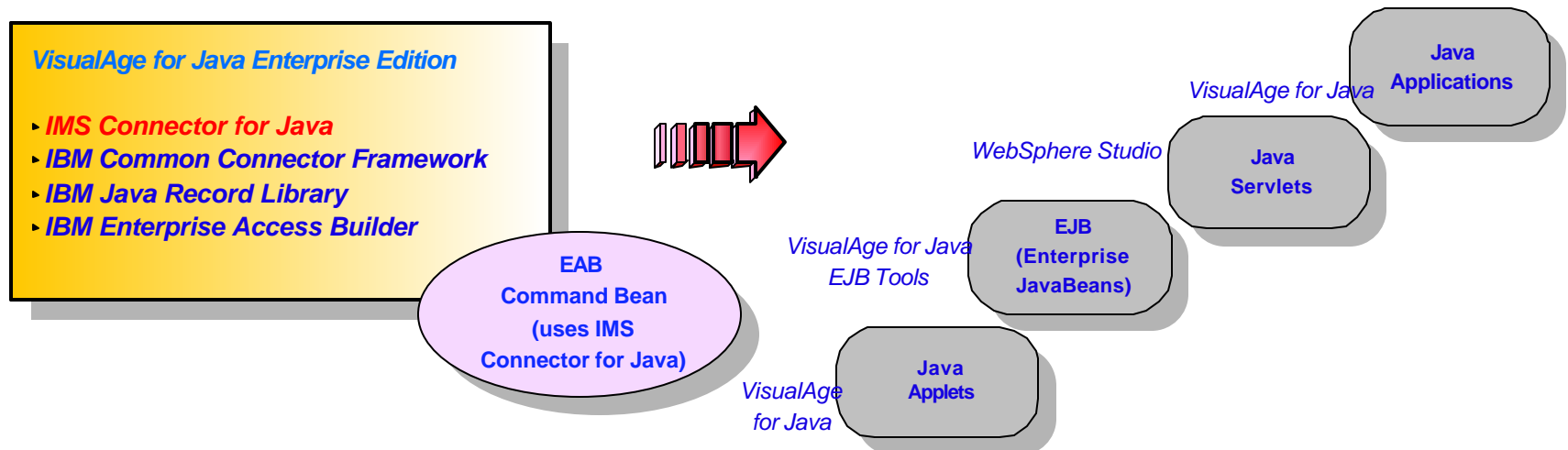

IMS Applications/Data

with Java Applications or Servlets

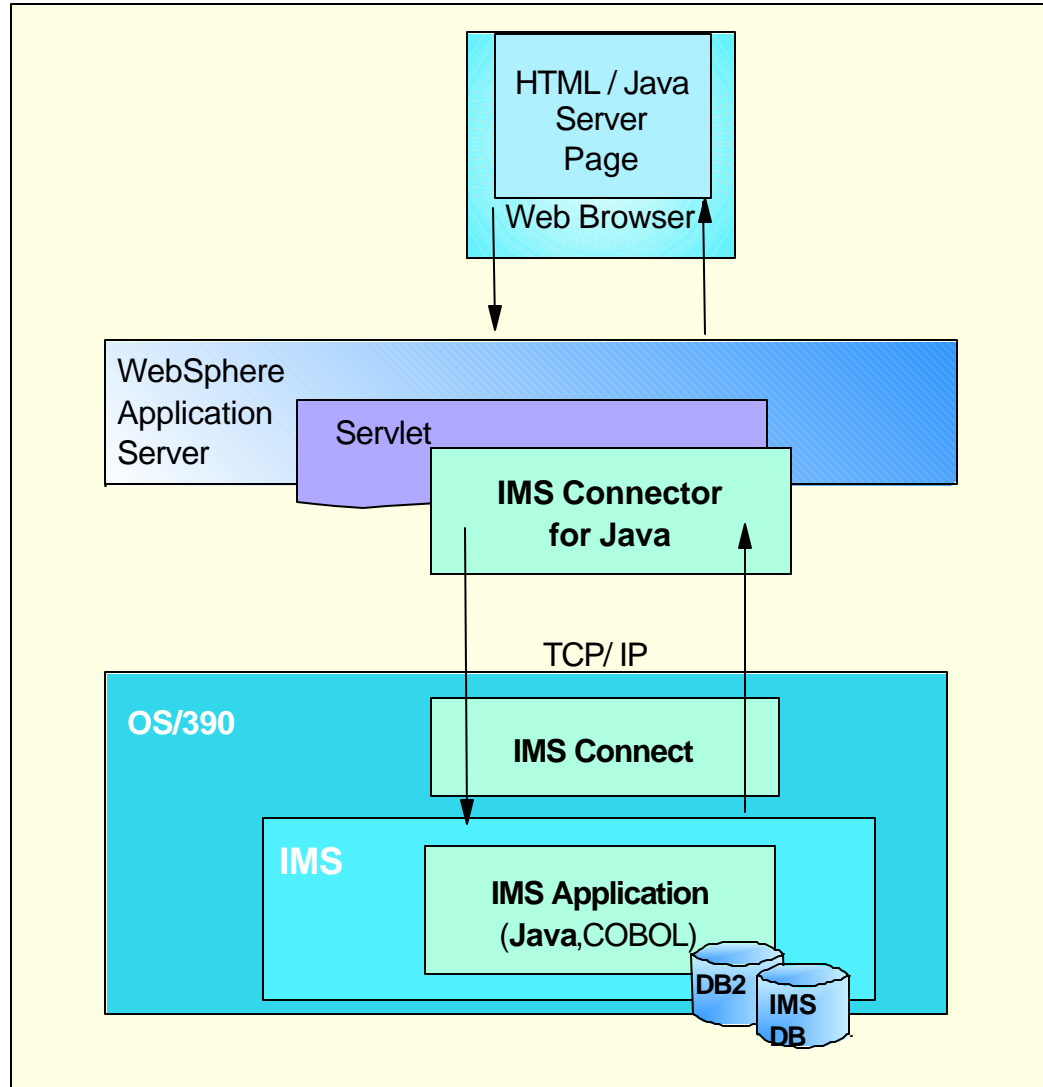

SEE the DEMO in the EXPO Area !!!

IMS Business Model Change

Delivery Cycles

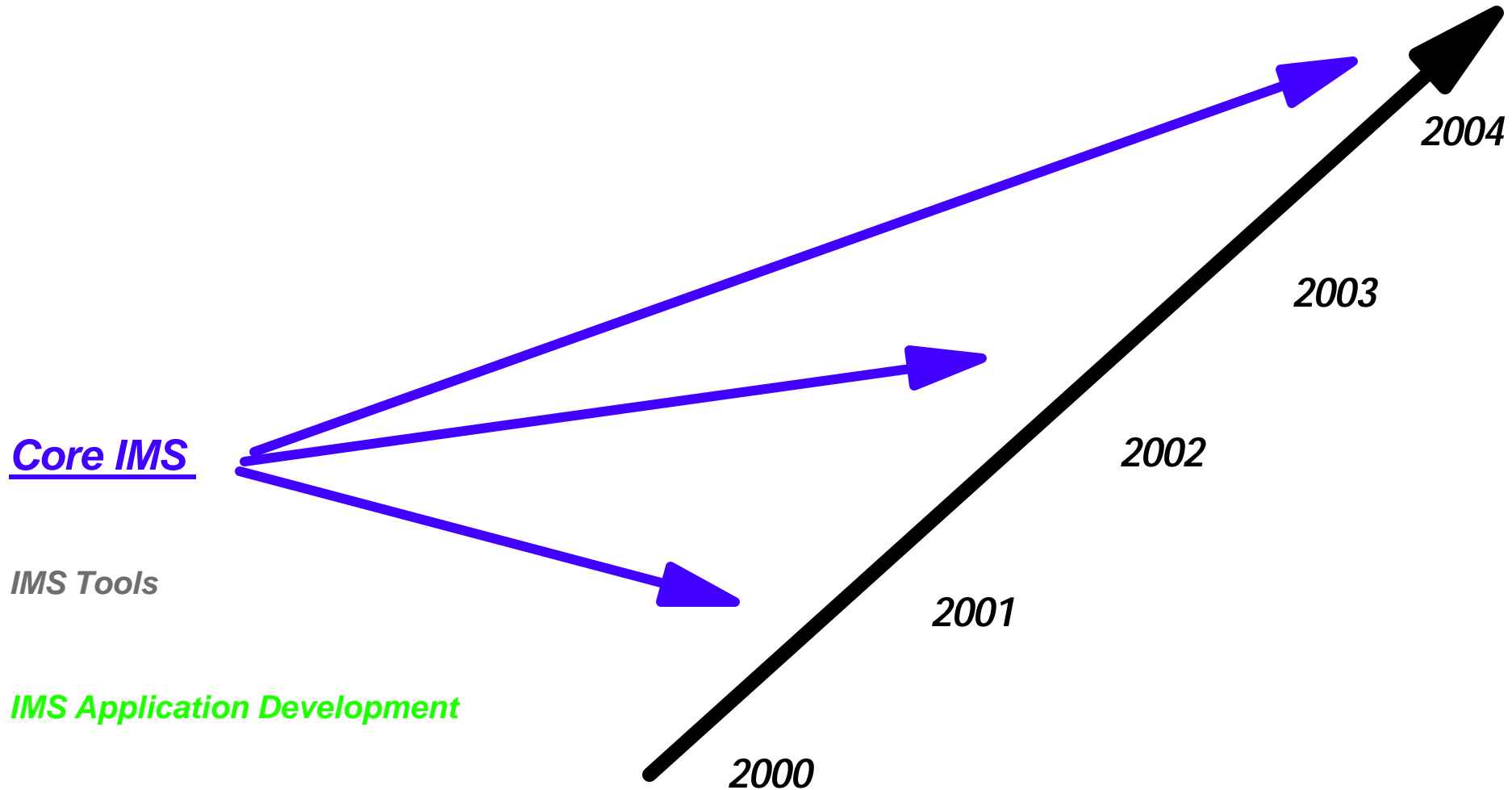

IMS Business Model Change

Delivery Cycles

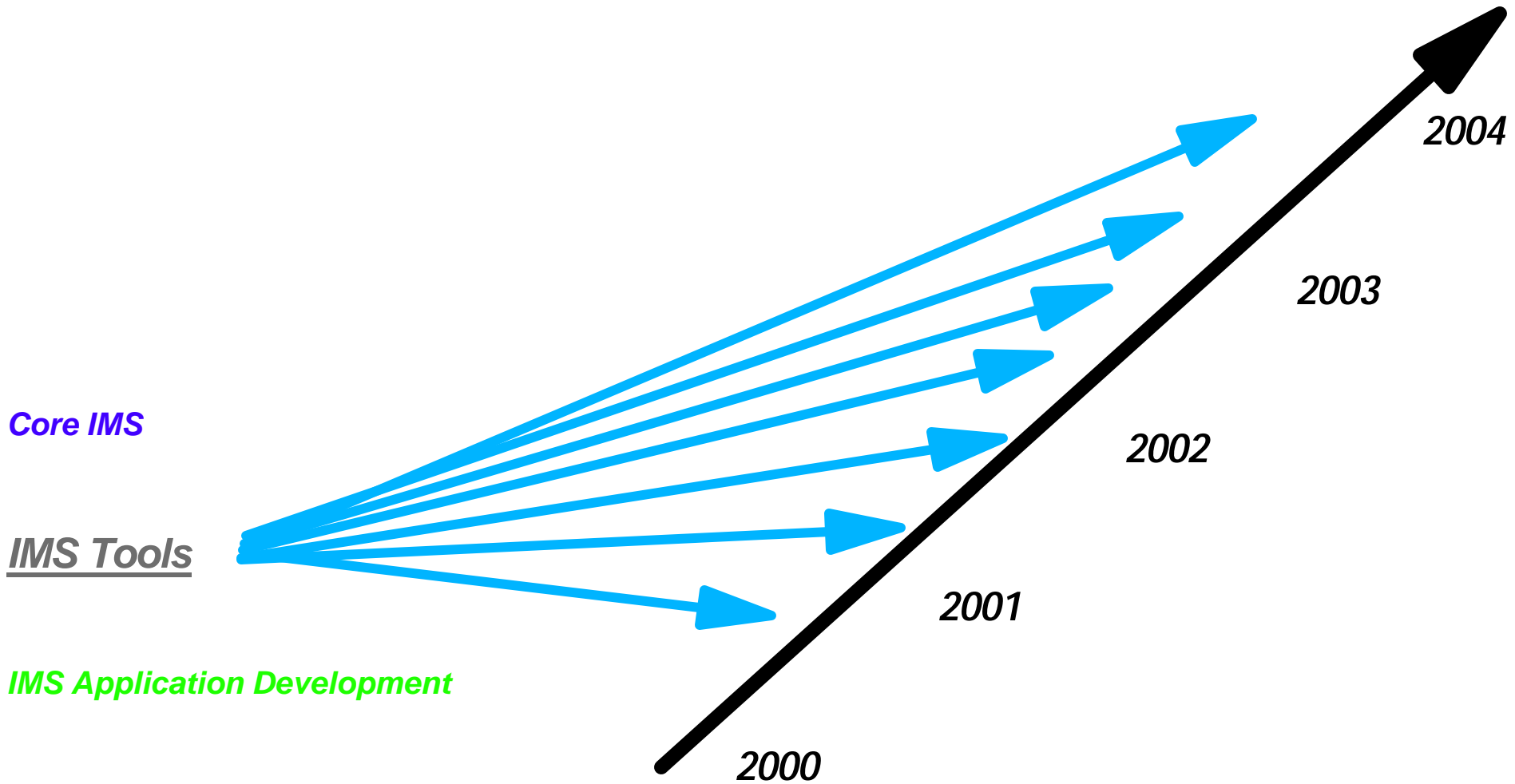

IMS Business Model Change

Delivery Cycles

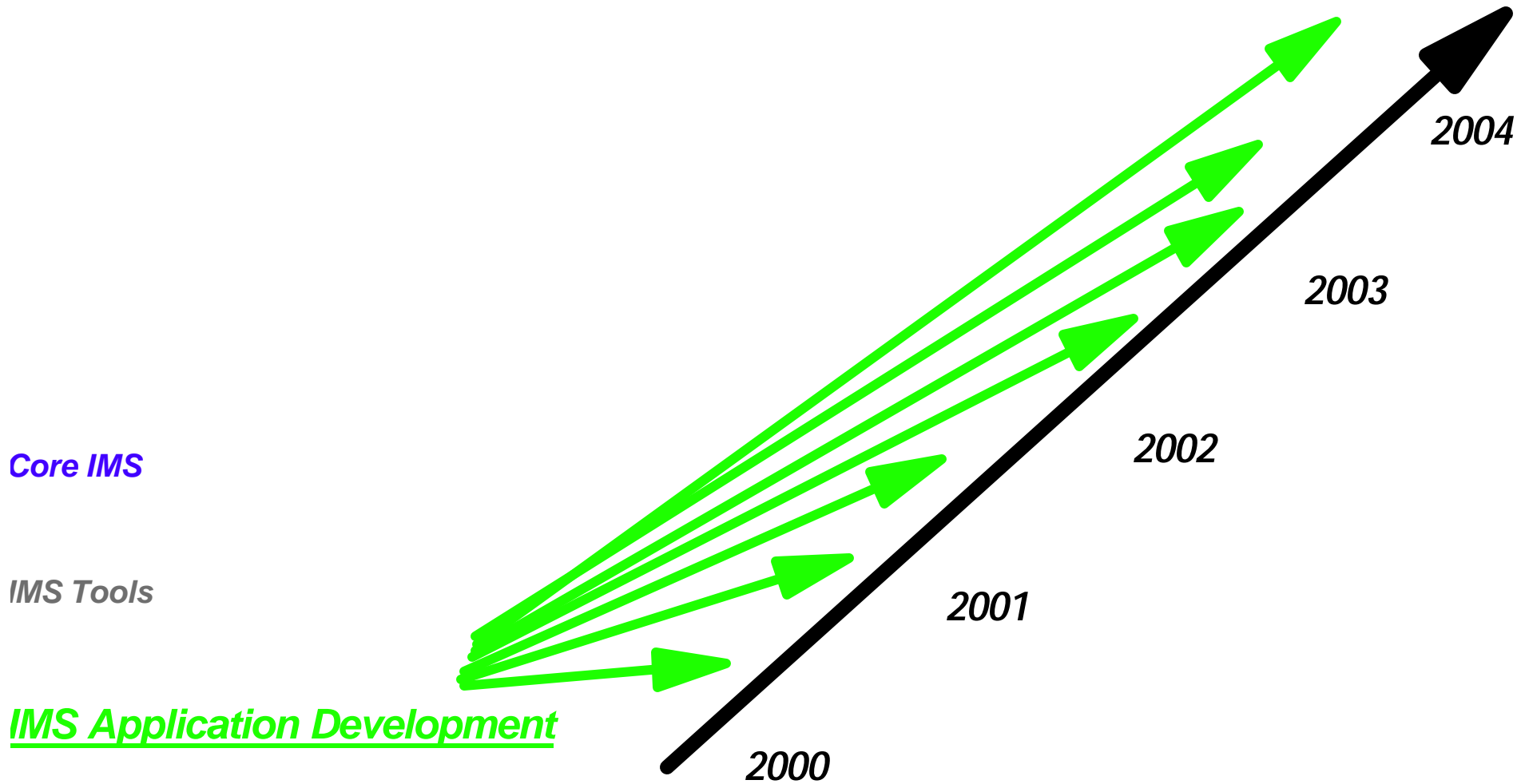

IMS - Now open for e-Business

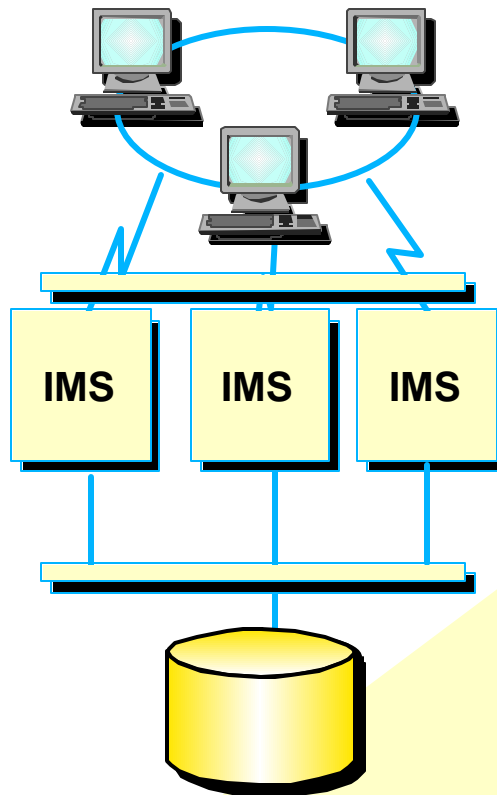

**Strategic Open Access
S/390 Enterprise Server**

Ideal for e-business

- ✓ Continuous Availability
- ✓ Systems Management
- ✓ Performance/Capacity
- ✓ Connectivity
- ✓ Rapid Appl Development

Enhancements

- Extended Large DB support
- Enhanced DB recovery
- Faster Restart with Multinode Persistent Sessions
- Enhanced Systems Mgmt Tools
- Enhanced Connectivity
- IMS Java

Benefits

- ✓ Enable Customer Growth
- ✓ Enhance Workload Balancing
- ✓ Increase Availability; Ease of Use
- ✓ Preserve Current Application Investment
- ✓ Enable New Applications

PMU - French Horse Racing

- **PRIX D'AMERIQUE 2000**
 - ▶ This 79th edition has seen the victory of General du Pommeau driven by Jules Lepennetier at a record speed of 1'12"6.
 - ▶ This 79th edition has seen the victory of the IMS Betting Application which reached 1100 transaction per second during half an hour!
- **IMS Betting Application Design**
 - ▶ 2 IMS subsystems without data sharing
 - designed for 1400 trans/sec
 - ▶ Using IMS Fast Path TM
 - Expedited Message Handler
 - ▶ Using IMS Fast Path DB
 - 3 VSO DEDBs with SDEPs



BETTING
Where to bet
How to bet

INFO
Forthcoming
race meetings
Programme
Results

DISCOVER
A day at the races
Live racing
The horse
French horseracing
institutions



IMS: Ideal for e-Business

- ✓ Handles unpredictable volumes
- ✓ Continuous up time for applications
- ✓ High levels of security
- ✓ End-to-end transaction integrity
- ✓ Real time data currency



e-business with IBM extends the investment



IMS V 7 "Raised the Bar" in the Business of e-Business

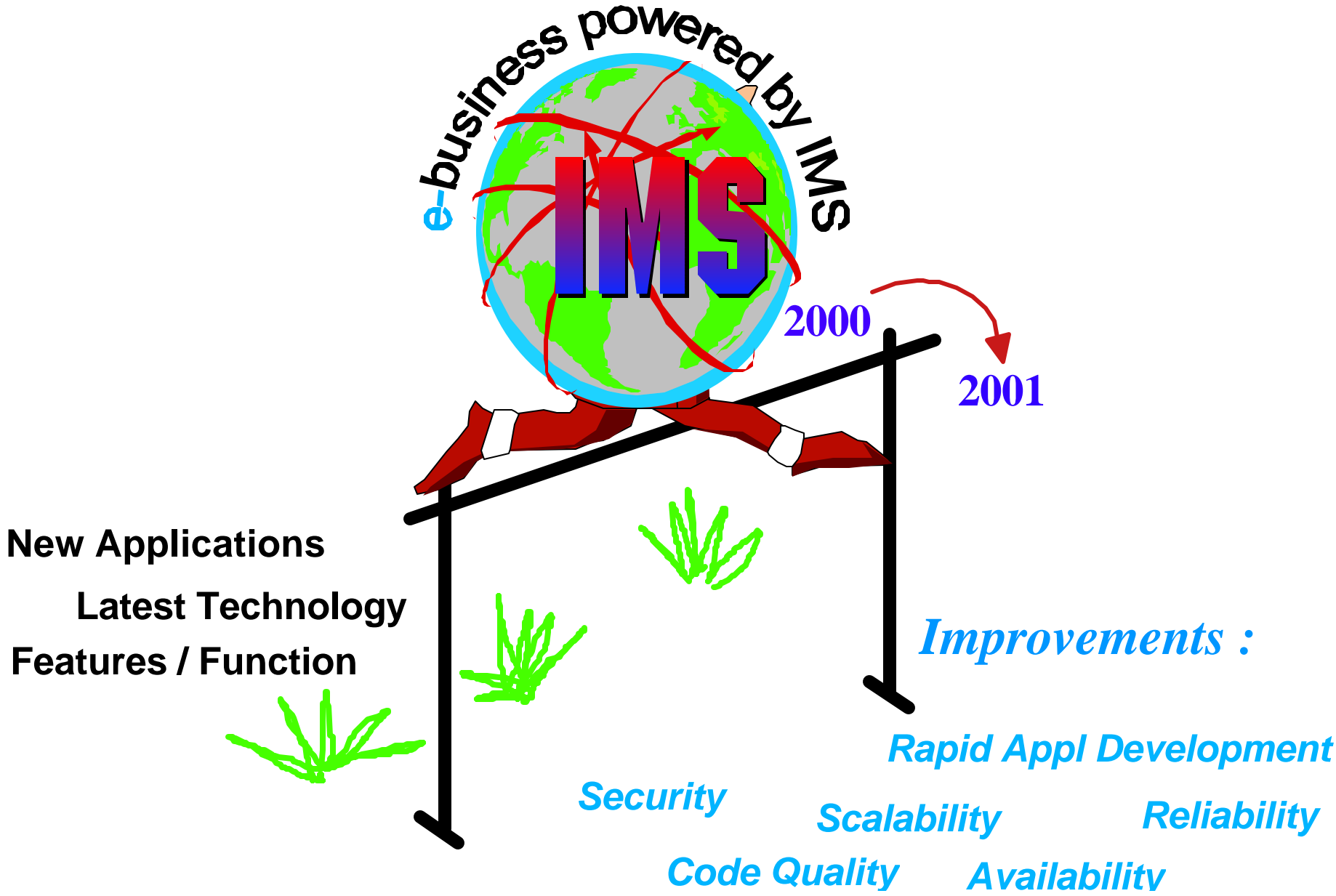



We will continue to "Raise the Bar"

- Technical Innovation
- Driving Standards and Products to the Market

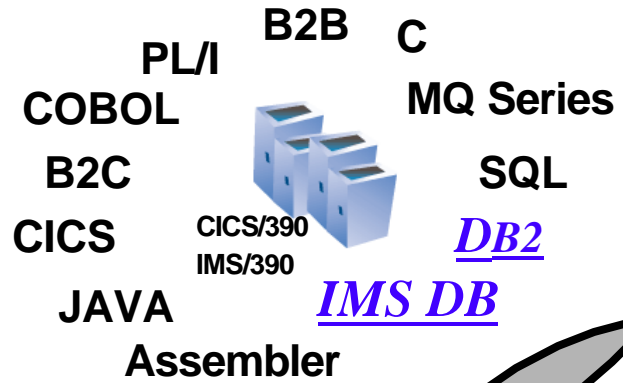

Common Application Metamodel (CAM)

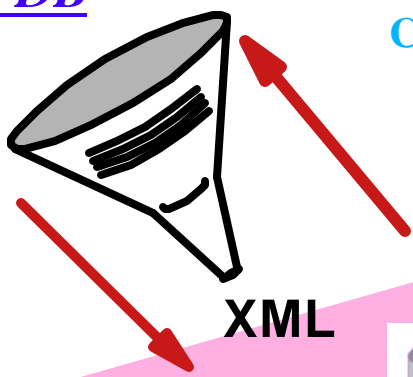

- Supporting SOAP (Simple Object Access Protocol) compliant XML Documents for industry tooling
- Processing XML documents in new/changed IMS COBOL applications (including parser)
- Transforming XML for existing applications using Web Server and/or IMS Connect
- Using XML as an IMS Data Definition Language

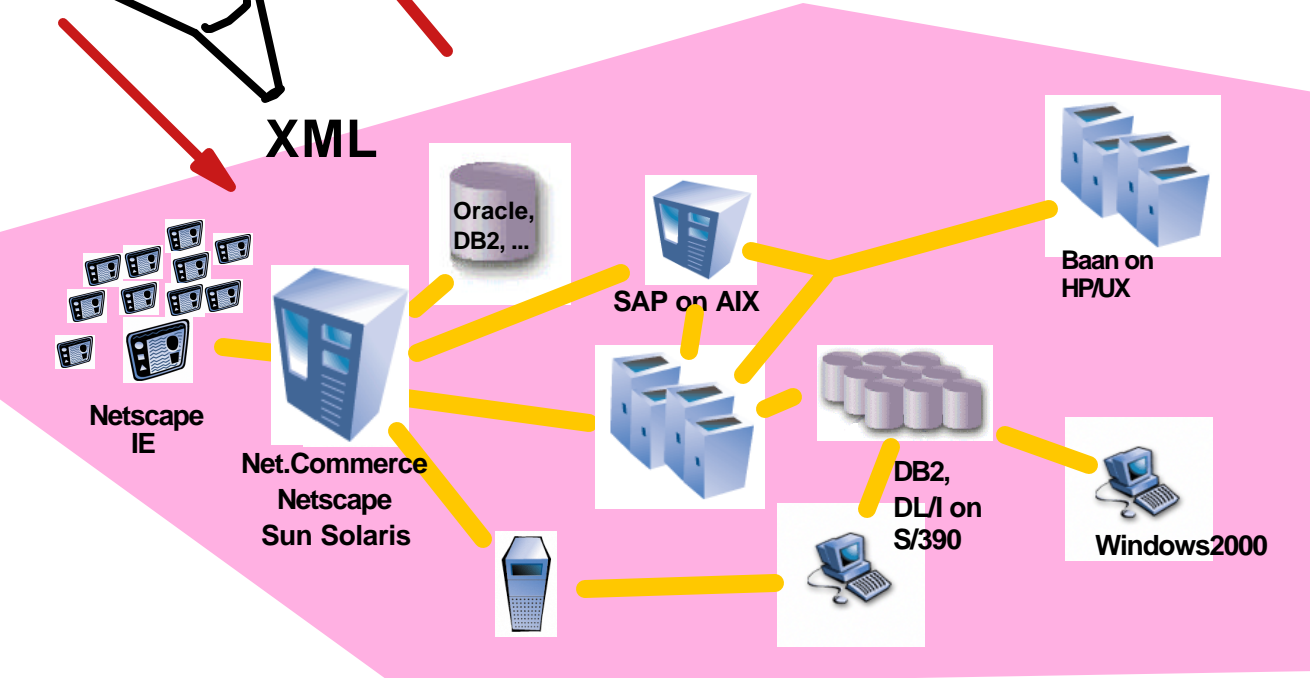



Web Services

- **Web Services are applications that use Internet standards such as XML to expose their features while remaining neutral with respect to any operating system or programming language**
 - ▶ described, published and discovered using open standards
 - ▶ platform and implementation neutral

- **By supporting SOAP, Web sites can become Web services that are accessible programmatically without requiring human intervention**
 - ▶ programmatically connect business processes together

- **Typically transactional, requiring integration with existing systems**

- **CAM provides underpinning for Web services**



Service-Oriented Architecture (SOA)

3 Roles

- Service Provider
- Service Requester
- Service Broker

3 Operations

Publish, Find, Bind

Operations constrained by security and other negotiated or agreed-upon prerequisites

e-business services protocol

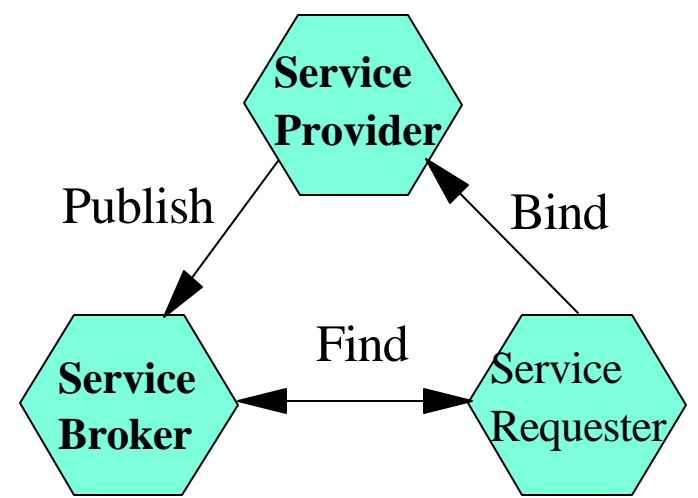

The New zSeries



- IMS V7 provides 64 bit real support in the database and logger
- IMS V5 V6 V7 will run on the z-Series --- faster and better
- IMS is announced as being enabled for License Manager to take advantage of new pricing structure
- **LINUX ENABLED !!!**

zSeries announcement October 2nd

*The first e-business Enterprise Server designed for
the high-performance data and transaction requirements for
next generation e-business*



IBM @-business servers. Technology. Innovation. Magic.

Enterprise Storage Server Performance (with ... IMS V7)

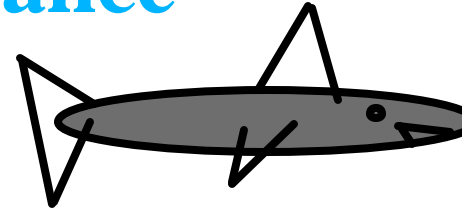

*Increase in
Bandwidth
Availability*

**IMS Serving Mission-critical Applications and Data
Access across the Enterprise and over the
Internet**

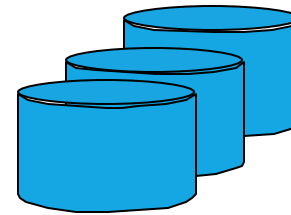

Achieved thru enhancements
across the IBM product line.

*Increase in Batch
Window Availability*



e-Business Development Means "End-to-End"

- e xtend Current Application Investment - Lifeline
- e xtend Availability and Reliability
- e nable new application growth

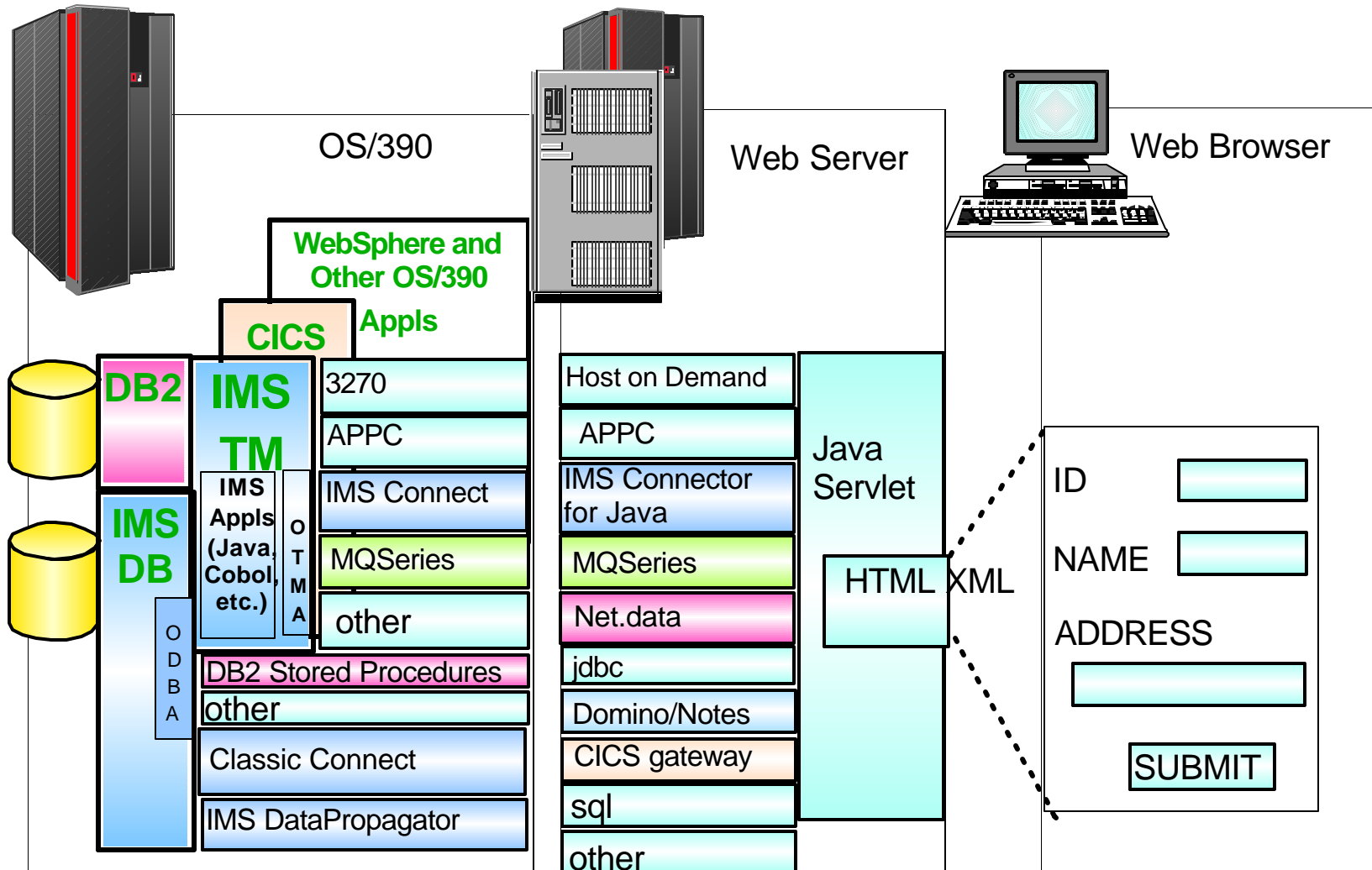

Arizona DMV

Arizona Department of Transportation, Motor Vehicle Division



*"Lose
Some
Wait"*

Challenge: Make vehicle registration fast and efficient for the public and the DMV.

Solution: Joint project with IBM Global Services

Benefits: Online vehicle registration without lines or waiting. IBM Global Services web front - end feeds into DMV's existing IMS.

Boeing Commercial Airplane Group

"The name of the game is just-in-time inventory, not just in case" ..

Darce Lamb, Boeing VP



Build Loyalty Through Customer Service

- Challenge:** Provide company's 500 customers means to locate, order and track shipment of parts
- Solution:** Internet access to Boeing IMS & DB2 mainframe data & hot links to United Parcel Service (UPS)
- Benefits:** Reduced costs to Boeing and customers, improved customer satisfaction

CUSTOMERS

Service and Services

SQL
Data Joiner/Classic Connect
from DB2

Application Development & APIs

DL1 Calls

JDBC : IMS Connector for JAVA
and DB2

IMS "Core"
Database & Transaction Management

IMS & DB/2 Tools

 Search

Home | Products & services | Support & downloads | My account

Select a country

Products > Software > Database and Data Management

Excellent Performance
Lower Computing Cost
System Management
Continuous Availability

IMS

IBM's premier transactional and hierarchical database management system for critical on-line operational and e-business applications and data.

IMS

- How to buy
- Support
- News
- Case studies
- Library
- Services
- Events
- Education

Related links:

- IMS Library
- Feedback

IBM Worldwide

Products

- IMS Version 7
- IMS Version 6
- IMS Version 5
- IMS Connect
- IMS Connector for Java
- Classic Connect
- IMS DataPropagator
- MQSeries
- Systems/Database Mgt. Tools

Info & Services

 IMS Newsletter

Recent News

- IMS V7 Library now available
- IMS V5 Service Discontinuance: 09/30/01
- DB2 & IMS Technical Conference in Hamburg, Germany March 5-9

Would you like to be notified of new IMS news? your email here

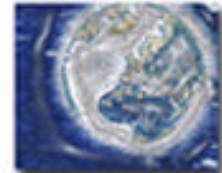

Featured Customer

IMS

Continuous Improvement

IMS Goals

Unlimited Growth

100% Accessable

100% Available

GEN-Less System

Dynamic Install

Latest Technology

IMS Directions...

IMS Today

- HALDB
- Rapid Restart
- Enhanced DB Recovery
- Enhanced Connectivity
- IMS Java Applications

Follow-on Enhancements

- Extend DB Connectivity
- Enhance Sysplex Operations
- Simplify Install Process
- Enhance Mgmt Tools
- Online Reorganization



IBM Data Management Solutions...



*Our business is to help companies
leverage information to gain competitive
advantage.*

Transactions

Business Intelligence

Content Management



Are you
ready for
e-business?



- Thank You for Attending the
EMEA IMS Technical Conference

- Enjoy the Conference

Think IMS for your e-business application

