

CICS® Transaction Server for OS/390®



# CICSplex® SM Concepts and Planning

*Release 3*



CICS® Transaction Server for OS/390®



# CICSplex® SM Concepts and Planning

*Release 3*

**Note!**

Before using this information and the product it supports, be sure to read the general information under "Notices" on page ix.

#### **Fourth Edition, March 1999**

This edition applies to Release 3 of CICS Transaction Server for OS/390, program number 5655-147, and to all subsequent versions, releases and modifications until otherwise indicated in new editions. Information in this edition was previously contained in GC33-0786-02, which is now obsolete. The technical changes for this edition are summarized under "Summary of changes," and are indicated by a vertical bar to the left of the change.

Order publications through your IBM representative or the IBM branch office serving your locality. Publications are not stocked at the address given below.

At the back of this publication is a page titled "Sending your comments to IBM". If you want to make comments, but the methods described are not available to you, please address them to:

IBM United Kingdom Laboratories, Information Development,  
Mail Point 095, Hursley Park, Winchester, Hampshire, England, SO21 2JN.

When you send information to IBM, you grant IBM a nonexclusive right to use or distribute the information in any way it believes appropriate without incurring any obligation to you.

© **Copyright International Business Machines Corporation 1994, 1999. All rights reserved.**

US Government Users Restricted Rights – Use, duplication or disclosure restricted by GSA ADP Schedule Contract with IBM Corp.

---

# Contents

<b>Notices</b> . . . . .	ix
Trademarks . . . . .	x
<b>Preface</b> . . . . .	xi
Who this book is for . . . . .	xi
What you need to know . . . . .	xi
Notes on terminology . . . . .	xi
<b>Bibliography</b> . . . . .	xiii
CICS Transaction Server for OS/390 . . . . .	xiii
CICS books for CICS Transaction Server for OS/390 . . . . .	xiii
CICSplex SM books for CICS Transaction Server for OS/390 . . . . .	xiv
Other CICS books . . . . .	xiv
Determining if a publication is current . . . . .	xiv
<b>Summary of changes</b> . . . . .	xv
New and changed function in CICS Transaction Server for OS/390 Release 3 . . . . .	xv
Dynamic routing . . . . .	xv
CICS business transaction services . . . . .	xvi
Temporary storage queue models . . . . .	xvii
Long temporary storage queue names . . . . .	xvii
Resource Recovery Services (RRS) . . . . .	xviii
Sysplex enqueue models . . . . .	xviii
Support of IIOp inbound to Java applications . . . . .	xviii
Coupling facility data tables . . . . .	xviii
Support for CICS Web enhancements . . . . .	xix
Java Virtual Machine . . . . .	xix
Open Transaction Environment . . . . .	xx
FEPI . . . . .	xx
Support for Tivoli Global Enterprise Manager . . . . .	xx
Changes made to this book for CICS Transaction Server for OS/390 Release 3 . . . . .	xx
<b>Chapter 1. Introducing CICSplex SM</b> . . . . .	1
CICS system connectivity . . . . .	2
Features of CICSplex SM . . . . .	3
Where next? . . . . .	7
<b>Chapter 2. The CICSplex SM environment</b> . . . . .	9
Overview . . . . .	9
The CICSplex . . . . .	10
The managed application system (MAS) . . . . .	11
Local MAS . . . . .	12
Remote MAS . . . . .	12
CICSplex SM address space (CMAS) . . . . .	13
Environment Services System Services (ESSS) . . . . .	14
The coordinating address space (CAS) and the EUI . . . . .	14
The CICSplex SM user interface . . . . .	14
CICSplex SM objects . . . . .	15
The data repository . . . . .	17
The batched repository-update facility . . . . .	17

Support for Tivoli Global Enterprise Manager . . . . .	18
Where next? . . . . .	18
<b>Chapter 3. Designing your CICSplex SM environment . . . . .</b>	<b>19</b>
Designing your CICSplexes . . . . .	19
Identifying your CICS systems and regions . . . . .	19
Which CICS systems can be managed by CICSplex SM? . . . . .	21
How many CICSplexes are there in your enterprise? . . . . .	21
Identifying system groups . . . . .	24
Locating CMASs . . . . .	26
Where to install CMASs . . . . .	26
CMAS-to-CMAS links . . . . .	27
CMAS-to-CMAS links for multiple CICSplexes . . . . .	30
Locating the maintenance point CMAS . . . . .	30
Local or remote MASs . . . . .	32
Locating CASs . . . . .	32
Where CASs are required . . . . .	32
CAS-to-CAS links . . . . .	33
Naming your CICSplex SM entities . . . . .	35
A staged implementation . . . . .	36
Updating the initial design . . . . .	36
Where next? . . . . .	36
<b>Chapter 4. Defining the CICSplex SM configuration and topology . . . . .</b>	<b>37</b>
Defining your CICSplex SM configuration . . . . .	37
Defining CAS-to-CAS links . . . . .	37
Defining the CMAS configuration . . . . .	37
Defining CICSplex topology . . . . .	38
Preparing CICSplex definitions . . . . .	39
Preparing CICS system definitions . . . . .	39
Where next? . . . . .	42
<b>Chapter 5. Managing resources using Business Application Services (BAS) . . . . .</b>	<b>43</b>
What is Business Application Services (BAS)? . . . . .	43
Limitations of RDO . . . . .	43
BAS concepts . . . . .	43
Two forms of BAS . . . . .	45
Advantages of using BAS . . . . .	47
Managing BAS . . . . .	48
Migrating your resource definitions . . . . .	51
Defining resources . . . . .	52
Validating resources . . . . .	52
Defining resource groups . . . . .	53
Using migration form BAS . . . . .	53
Using full-function form BAS . . . . .	54
Using resource assignments . . . . .	54
Using resource descriptions . . . . .	55
Installing applications and resources . . . . .	55
Security considerations . . . . .	56
Planning for BAS . . . . .	56
Implementing BAS . . . . .	57
Creating migration form BAS . . . . .	57
Migrating to the use of resource assignments . . . . .	57

A recommended approach . . . . .	58
Where next? . . . . .	58
<b>Chapter 6. Managing workloads . . . . .</b>	<b>59</b>
What is workload management? . . . . .	59
What is dynamic routing . . . . .	59
Dynamic routing models . . . . .	60
WLM functions . . . . .	62
Advantages of WLM . . . . .	63
Workload balancing . . . . .	63
The queue algorithm . . . . .	64
The goal algorithm . . . . .	64
Workload separation . . . . .	65
Intertransaction affinity . . . . .	65
How intertransaction affinities are honored . . . . .	66
Managing workloads . . . . .	66
Planning for WLM . . . . .	69
Workload balancing or workload separation? . . . . .	70
Identifying the workloads . . . . .	70
Identifying intertransaction affinities . . . . .	71
Implementing WLM . . . . .	71
Identifying dynamic routing candidates . . . . .	71
Implementing workload balancing . . . . .	72
Adding workload separation requirements . . . . .	72
Defining intertransaction affinities . . . . .	73
A recommended approach . . . . .	74
Where next? . . . . .	74
<b>Chapter 7. Exception reporting using real-time analysis (RTA) . . . . .</b>	<b>75</b>
What is real-time analysis? . . . . .	75
Why automate? . . . . .	75
The RTA external notifications . . . . .	76
RTA functions . . . . .	76
Advantages of RTA . . . . .	77
System Availability Monitoring (SAM) . . . . .	77
Customizing the SAM external notifications . . . . .	77
Automation and SAM . . . . .	78
MAS resource monitoring (MRM) . . . . .	78
Automation and MRM . . . . .	79
Analysis point monitoring (APM) . . . . .	80
Managing RTA . . . . .	80
Planning for RTA . . . . .	82
Implementing RTA . . . . .	83
Implementing system availability monitoring (SAM) . . . . .	83
Implementing MAS resource monitoring (MRM) . . . . .	83
Implementing analysis point monitoring (APM) . . . . .	84
A recommended approach . . . . .	84
Where next? . . . . .	85

<b>Chapter 8. Collecting statistics using CICSplex SM monitoring</b>	87
What is monitoring?	87
Monitoring functions	87
Advantages of monitoring	87
Monitoring of resources	88
An interface to NetView RODM	88
The monitor interval	88
The sample interval	89
Managing monitoring functions	89
Planning CICSplex SM monitoring	90
Implementing CICSplex SM monitoring	92
Activating the interface to NetView RODM	93
Using the CICS Monitoring Facility (CMF)	94
A recommended approach	94
Where next?	95
<b>Chapter 9. Planning CICSplex SM installation and setup</b>	97
Software, hardware, and storage requirements	97
Prerequisite software release levels	97
Prerequisite hardware	98
Storage requirements	98
The CICSplex SM product documentation	100
CICSplex SM naming conventions	100
Generic names	102
Security planning	102
Protecting access to CICSplex SM functions and CICS resources	102
Special considerations for BAS	103
CICS command and resource checking	103
Defining time zones	103
An overview of the installation process	104
Installing remote MAS code	104
Preparing to set up a CAS	105
Preparing to set up a CMAS	106
Using the batched repository-update facility	107
Preparing to set up a MAS	107
Preparing a remote MAS	108
Reuse of CICSplex SM object definitions	108
Where next?	109
<b>Chapter 10. The CICSplex SM Starter Set</b>	111
Why is the Starter Set provided?	111
The Starter Set configuration	111
The Starter Set installation requirements	113
CICSplex SM definitions supplied with the Starter Set	114
Sample CAS definitions	115
Sample configuration definitions	115
Sample topology definitions	116
BAS definitions	118
Sample Workload definitions	123
Sample Monitor definitions	125
Sample Analysis definitions	128
The Starter Set naming convention	139
<b>Glossary</b>	141



<b>Index</b> . . . . .	153
<b>Sending your comments to IBM</b> . . . . .	155



---

## Notices

This information was developed for products and services offered in the U.S.A. IBM may not offer the products, services, or features discussed in this document in other countries. Consult your local IBM representative for information on the products and services currently available in your area. Any reference to an IBM product, program, or service is not intended to state or imply that only that IBM product, program, or service may be used. Any functionally equivalent product, program, or service that does not infringe any IBM intellectual property right may be used instead. However, it is the user's responsibility to evaluate and verify the operation of any non-IBM product, program, or service.

IBM may have patents or pending patent applications covering subject matter described in this document. The furnishing of this document does not give you any license to these patents. You can send license inquiries, in writing, to:

IBM Director of Licensing  
IBM Corporation  
North Castle Drive  
Armonk, NY 10504-1785  
U.S.A.

For license inquiries regarding double-byte (DBCS) information, contact the IBM Intellectual Property Department in your country or send inquiries, in writing, to:

IBM World Trade Asia Corporation  
Licensing  
2-31 Roppongi 3-chome, Minato-ku  
Tokyo 106, Japan

**The following paragraph does not apply in the United Kingdom or any other country where such provisions are inconsistent with local law:**

INTERNATIONAL BUSINESS MACHINES CORPORATION PROVIDES THIS PUBLICATION "AS IS" WITHOUT WARRANTY OF ANY KIND, EITHER EXPRESS OR IMPLIED, INCLUDING, BUT NOT LIMITED TO, THE IMPLIED WARRANTIES OF NON-INFRINGEMENT, MERCHANTABILITY, OR FITNESS FOR A PARTICULAR PURPOSE. Some states do not allow disclaimer of express or implied warranties in certain transactions, therefore this statement may not apply to you.

This publication could include technical inaccuracies or typographical errors. Changes are periodically made to the information herein; these changes will be incorporated in new editions of the publication. IBM may make improvements and/or changes in the product(s) and/or the program(s) described in this publication at any time without notice.

Licensees of this program who wish to have information about it for the purpose of enabling: (i) the exchange of information between independently created programs and other programs (including this one) and (ii) the mutual use of the information which has been exchanged, should contact IBM United Kingdom Laboratories, MP151, Hursley Park, Winchester, Hampshire, England, SO21 2JN. Such information may be available, subject to appropriate terms and conditions, including in some cases, payment of a fee.

The licensed program described in this document and all licensed material available for it are provided by IBM under terms of the IBM Customer Agreement, IBM International Programming License Agreement, or any equivalent agreement between us.

---

## Trademarks

The following terms are trademarks of International Business Machines Corporation in the United States, or other countries, or both:

ACF/VTAM	DB2	MVS/XA
AIX	ESA/390	NetView
BookManager	IBM	OS/2
C/370	IBMLink	OS/390
CICS	IMS	OS/400
CICS/400	IMS/ESA	RACF
CICS/ESA	MQ	SP
CICS/MVS	MVS	VSE/ESA
CICS/VSE	MVS/DFP	VTAM
CICSplex	MVS/ESA	

Other company, product, and service names may be trademarks or service marks of others.

---

## Preface

This book provides a general introduction to the CICSplex® System Manager (CICSplex SM) component of CICS® Transaction Server for OS/390® Release 3.

- It describes, at a high level, how CICSplex SM works, and introduces some new concepts (see Chapter 1, “Introducing CICSplex SM” on page 1).
- It introduces the main functions and benefits of CICSplex SM as a CICS system management tool (see Chapter 2, “The CICSplex SM environment” on page 9).
- It explains how to approach the design of a CICSplex SM configuration (Chapter 3, “Designing your CICSplex SM environment” on page 19).
- It describes how to start defining your CICSplex SM environment (see Chapter 4, “Defining the CICSplex SM configuration and topology” on page 37).
- It describes how to plan for use of CICSplex SM's Business Application Services, workload management, real-time analysis, and monitoring functions. See Chapter 5, “Managing resources using Business Application Services (BAS)” on page 43, Chapter 6, “Managing workloads” on page 59, Chapter 7, “Exception reporting using real-time analysis (RTA)” on page 75, and Chapter 8, “Collecting statistics using CICSplex SM monitoring” on page 87, as appropriate.
- It describes how to prepare for the installation of CICSplex SM (see Chapter 9, “Planning CICSplex SM installation and setup” on page 97).
- It describes the CICSplex SM Starter Set (see Chapter 10, “The CICSplex SM Starter Set” on page 111).

---

## Who this book is for

This book is intended for anyone who needs a general introduction to CICSplex SM, and for system designers, planners, and programmers responsible for preparing an enterprise for the introduction of CICSplex SM.

---

## What you need to know

Readers of this book are assumed to be familiar with CICS terminology and operation.

---

## Notes on terminology

Unless otherwise indicated, in the text of this book:

- The term **CICSplex SM** (spelled with an uppercase letter ‘P’) means the IBM CICSplex System Manager element of CICS Transaction Server for OS/390. The term **CICSplex** (spelled with a lowercase letter ‘p’) means the largest set of CICS systems to be managed by CICSplex SM as a single entity.
- The term **CICS system** refers to a single administration unit of CICS on any of the platforms managed by CICSplex SM. On MVS, this term is synonymous with **CICS region**.

- The term **MVS** refers to the MVS/Enterprise Systems Architecture (MVS/ESA™) operating system.
- The term CICS for OS/2 Version 3.0 refers to the CICS for OS/2® Version 3.0 product, which is included as the CICS for OS/2 component of IBM Transaction Server for OS/2 Warp, Version 4.

---

# Bibliography

---

## CICS Transaction Server for OS/390

<i>CICS Transaction Server for OS/390: Planning for Installation</i>	GC33-1789
<i>CICS Transaction Server for OS/390 Release Guide</i>	GC34-5352
<i>CICS Transaction Server for OS/390 Migration Guide</i>	GC34-5353
<i>CICS Transaction Server for OS/390 Installation Guide</i>	GC33-1681
<i>CICS Transaction Server for OS/390 Program Directory</i>	GI10-2506
<i>CICS Transaction Server for OS/390 Licensed Program Specification</i>	GC33-1707

## CICS books for CICS Transaction Server for OS/390

### General

<i>CICS Master Index</i>	SC33-1704
<i>CICS User's Handbook</i>	SX33-6104
<i>CICS Transaction Server for OS/390 Glossary (softcopy only)</i>	GC33-1705

### Administration

<i>CICS System Definition Guide</i>	SC33-1682
<i>CICS Customization Guide</i>	SC33-1683
<i>CICS Resource Definition Guide</i>	SC33-1684
<i>CICS Operations and Utilities Guide</i>	SC33-1685
<i>CICS Supplied Transactions</i>	SC33-1686

### Programming

<i>CICS Application Programming Guide</i>	SC33-1687
<i>CICS Application Programming Reference</i>	SC33-1688
<i>CICS System Programming Reference</i>	SC33-1689
<i>CICS Front End Programming Interface User's Guide</i>	SC33-1692
<i>CICS C++ OO Class Libraries</i>	SC34-5455
<i>CICS Distributed Transaction Programming Guide</i>	SC33-1691
<i>CICS Business Transaction Services</i>	SC34-5268

### Diagnosis

<i>CICS Problem Determination Guide</i>	GC33-1693
<i>CICS Messages and Codes</i>	GC33-1694
<i>CICS Diagnosis Reference</i>	LY33-6088
<i>CICS Data Areas</i>	LY33-6089
<i>CICS Trace Entries</i>	SC34-5446
<i>CICS Supplementary Data Areas</i>	LY33-6090

### Communication

<i>CICS Intercommunication Guide</i>	SC33-1695
<i>CICS Family: Interproduct Communication</i>	SC33-0824
<i>CICS Family: Communicating from CICS on System/390</i>	SC33-1697
<i>CICS External Interfaces Guide</i>	SC33-1944
<i>CICS Internet Guide</i>	SC34-5445

### Special topics

<i>CICS Recovery and Restart Guide</i>	SC33-1698
<i>CICS Performance Guide</i>	SC33-1699
<i>CICS IMS Database Control Guide</i>	SC33-1700
<i>CICS RACF Security Guide</i>	SC33-1701
<i>CICS Shared Data Tables Guide</i>	SC33-1702
<i>CICS Transaction Affinities Utility Guide</i>	SC33-1777
<i>CICS DB2 Guide</i>	SC33-1939

## CICSplex SM books for CICS Transaction Server for OS/390

### General

<i>CICSplex SM Master Index</i>	SC33-1812
<i>CICSplex SM Concepts and Planning</i>	GC33-0786
<i>CICSplex SM User Interface Guide</i>	SC33-0788
<i>CICSplex SM View Commands Reference Summary</i>	SX33-6099

### Administration and Management

<i>CICSplex SM Administration</i>	SC34-5401
<i>CICSplex SM Operations Views Reference</i>	SC33-0789
<i>CICSplex SM Monitor Views Reference</i>	SC34-5402
<i>CICSplex SM Managing Workloads</i>	SC33-1807
<i>CICSplex SM Managing Resource Usage</i>	SC33-1808
<i>CICSplex SM Managing Business Applications</i>	SC33-1809

### Programming

<i>CICSplex SM Application Programming Guide</i>	SC34-5457
<i>CICSplex SM Application Programming Reference</i>	SC34-5458

### Diagnosis

<i>CICSplex SM Resource Tables Reference</i>	SC33-1220
<i>CICSplex SM Messages and Codes</i>	GC33-0790
<i>CICSplex SM Problem Determination</i>	GC33-0791

## Other CICS books

<i>CICS Application Programming Primer (VS COBOL II)</i>	SC33-0674
<i>CICS Application Migration Aid Guide</i>	SC33-0768
<i>CICS Family: API Structure</i>	SC33-1007
<i>CICS Family: Client/Server Programming</i>	SC33-1435
<i>CICS Family: General Information</i>	GC33-0155
<i>CICS 4.1 Sample Applications Guide</i>	SC33-1173
<i>CICS/ESA 3.3 XRF Guide</i>	SC33-0661

If you have any questions about the CICS Transaction Server for OS/390 library, see *CICS Transaction Server for OS/390: Planning for Installation* which discusses both hardcopy and softcopy books and the ways that the books can be ordered.

---

## Determining if a publication is current

IBM regularly updates its publications with new and changed information. When first published, both hardcopy and BookManager softcopy versions of a publication are usually in step. However, due to the time required to print and distribute hardcopy books, the BookManager version is more likely to have had last-minute changes made to it before publication.

Subsequent updates will probably be available in softcopy before they are available in hardcopy. This means that at any time from the availability of a release, softcopy versions should be regarded as the most up-to-date.

For CICS Transaction Server books, these softcopy updates appear regularly on the *Transaction Processing and Data Collection Kit* CD-ROM, SK2T-0730-xx. Each reissue of the collection kit is indicated by an updated order number suffix (the -xx part). For example, collection kit SK2T-0730-06 is more up-to-date than SK2T-0730-05. The collection kit is also clearly dated on the cover.

Updates to the softcopy are clearly marked by revision codes (usually a “#” character) to the left of the changes.



---

## Summary of changes

This book is based on the Release 3 edition of *CICSplex SM Concepts and Planning*, GC33-0786-02. It has been updated to incorporate changes made for CICS Transaction Server for OS/390 Release 3. Changes made since the last edition are indicated by vertical bars to the left of the change.

---

## New and changed function in CICS Transaction Server for OS/390 Release 3

The following additions and changes have been made to the functions of the CICSplex SM component of CICS Transaction Server for OS/390 Release 3.

### Dynamic routing

CICS Transaction Server for OS/390 Release 3 introduces extensions to the CICSplex SM dynamic routing program (called the dynamic *transaction* routing program in previous releases). In addition to dynamic routing of transactions initiated at a terminal, you can now dynamically route:

- Transactions invoked using the EXEC CICS START commands that are associated with a terminal
- Transactions invoked using the EXEC CICS START commands that are not associated with a terminal
- Distributed program links, including:
  - The CICS Web support
  - The CICS Transaction Gateway
  - EXCI calls
  - CICS Client ECI calls
  - Distributed Computing Environment (DCE) remote procedure calls (RPCs)
  - Open Network Computing (ONC) remote procedure calls (RPCs)
  - Internet Inter-Object Request Block Protocol (IIOP)
  - Any function that issues an EXEC CICS LINK PROGRAM request
- Transactions associated with CICS business transaction services (BTS) activities (see “CICS business transaction services” on page xvi)

These new functions allow you to integrate workload management for requests from all these sources and thereby improve performance and workload throughput. You specify which transactions and programs may be dynamically routed, and the CICS regions in which they may be run.

The new dynamic functions are supported by:

- A new workload management view, WLMWAOS, which shows summarized information about all target regions that are associated with a workload that is within the CICSplex identified as the context. WLMWAOS is a summary form of the WLMWAOR view.
- A new workload management view, WLMAWTOS, which shows summarized information about all routing regions that are associated with a workload that is within the CICSplex identified as the context. WLMAWTOS is a summary form of the WLMAWTOR view.

## summary of changes

- A new field, Dynamic, on the BAS PROGDEF view, which specifies whether or not an EXEC CICS LINK to the named program may invoke dynamic routing.
- A new field, Routable, on the BAS TRANDEF view, which specifies whether or not an eligible EXEC CICS START TERMID should be shipped to the terminal-owning region (TOR) for potential dynamic routing.

An overview of dynamic routing is given in “What is workload management?” on page 59. Full details are in given in *CICSplex SM Managing Workloads*.

## CICS business transaction services

CICS business transaction services (BTS) extends the CICS API and provides support services that make it easier to model complex business transactions. Using BTS, each action that makes up the business transaction is implemented as one or more CICS transactions, in the traditional manner. However, a top-level program is used to control the overall progress of the business transaction. The top-level program manages the inter-relationship, ordering parallel execution, commit scope, recovery, and restart of the actions that make up the business transaction. For full details about BTS, see *CICS Business Transaction Services*.

BTS processes are CICSplex-enabled, and take full advantage of CICSplex SM's workload separation and workload balancing functions. The CICS system group within a CICSplex, across which related BTS processes and activities may run, is known as a **BTS-set**. When an activity is attached, WLM routes the activity to the most appropriate region in the CICSplex. You can separate a BTS workload based on **process-type**. Workload management and the CICS Transaction Affinities Utility understand affinities between BTS processes and activities.

CICSplex SM support for BTS is provided by:

- A new BAS resource definition object, PROCDEF, which you use to define BTS process types. All other BTS resources are created dynamically when you specify a name in your application.
- New operations views:
  - PROCTYP, a general view of all installed process types
  - PROCTYPD, a detailed view of a selected process type
  - PROCTYPS, a summary view of all installed process types.
- Workload management changes:
  - A new view, WLMATAFD, which provides a detailed view of the properties of a single active BTS affinity. You can use this view to display the contents of the BTS affinity key in hexadecimal format.
  - The TRANDEF and WLMSPEC views have been enhanced to allow you to specify the BTS BAPPL affinity relation, and the BTS ACTIVITY and PROCESS affinity lifetimes.

## Temporary storage queue models

CICS Transaction Server for OS/390 Release 3 introduces Resource Definition Online (RDO) support for the Temporary Storage Table (TST). For CICSplex SM, support for this function is provided by:

- A new BAS resource definition object TSMDEF, which allows you to specify a temporary storage queue name prefix and associate attributes with that name.
- New operations views:
  - TSMODEL, a general view of all currently available temporary storage queue models.
  - TSMODELD, a detailed view of a temporary storage model.
  - TSMODELS, a summary view of temporary storage models.
  - TSPOOL, a general view of temporary storage shared pools.
  - TSQSHR, a general view of shared temporary storage queues.
  - TSQSHRD, a detailed view of a shared temporary storage queue.
  - TSQSHRS, a summary view of shared temporary storage queues.

The existing temporary storage operations views, TSQ, TSQS, TSQGBL, and TSQGBLS, remain unchanged. However, you can now delete temporary storage queues from the TSQ, TSQSHR and TSQNAME views by entering the command DEL. A new TSQ Deletion Panel asks you to confirm the deletion.

## Long temporary storage queue names

Users have found it difficult to generate temporary storage queue names that are unique. Typically, queue names were generated from the transaction id and the terminal id but unique names could be guaranteed only where the terminal id was unique and the transaction required one queue only. Many users like to have the user id as part of the queue name, so that the queue data is tied to the user rather than the terminal, but then there is no room for the transaction id which is required if properties, for example, recoverability and security, are to be associated with the queue via the temporary storage table (TST).

To provide greater flexibility, the length of temporary storage queue names has been increased to a maximum of 16 characters. For example, users can generate queue names of the form:

XXXXaUUUUUUUU

where:

XXXX is the transaction id.

a is a suffix allowing the transaction or user to have more than one queue.

UUUUUUUU is the user id.

The TST or temporary storage model prefix can then be XXXX or XXXXa.

For CICSplex SM, support for this function is provided by:

- New operations views:

## summary of changes

- TSQNAME, a general view of all non-shared temporary storage queues.
- TSQNAMED, a detailed view of a non-shared temporary storage queue.
- TSQNAMES, a summary view of all non-shared temporary storage queues.

## Resource Recovery Services (RRS)

CICS Transaction Server for OS/390 Release 3 allows the use of Recoverable Resources Management Services (RRMS) facilities in an MVS image.

CICSplex SM supports this function through:

- A new value of WAITRRMS for the Wait Cause field of the UOWORKD view.
- A new Protocol field on the UOWLINKD view, that may take values of RRMS or blank.
- A new RRMS Status field on the CICSRGND view, that may take the values OPEN, CLOSED, or N/A.

## Sysplex enqueue models

CICS Transaction Server for OS/390 Release 3 extends the CICS application programming interface to serialize resources across a set of CICS systems. The set of CICS systems defined as forming the resource set is called the *enqueue scope*. CICSplex SM supports this function through:

- A new BAS resource definition ENQMDEF, which defines a global enqueue model.
- New operations views:
  - ENQMDL, a general view of enqueue models.
  - ENQMDLD, a detailed view of a selected enqueue model.
  - ENQMDLS, a summary view of enqueue models.
- A new field, Enqscope, on the UOWENQ view.

## Support of IIOB inbound to Java applications

CICSplex SM supports IIOB inbound to Java applications through:

- A new BAS resource definition RQMDEF, which defines a CICS request model resource.
- New operations views:
  - RQMODEL, a general view of request models and their associated transactions.
  - RQMODEL, a detailed view of a selected request model.
  - RQMODELS, a summary view of all installed request models.

## Coupling facility data tables

CICS Transaction Server for OS/390 Release 3 introduces support for coupling facility data tables. Part of this function is the implementation of new attributes on the FILE resource definition to specify a coupling facility data table pool to be associated with the file. In support of this function, CICSplex SM support of the file inquiry facility is extended by:

- New operations views:

- CFDTPOOL, a general view of coupling facility data table pools associated with the file.
- CFDTPOOD, a detailed view of a selected coupling facility data table pool.
- CFDTPOOS, a summary view of coupling facility data table pools.
- The existing file operations view, CMDT, and its associated detail view, CMDTD, and summary view, CMDTS, have been amended to reflect support for coupling facility data tables.
- Two new detail views for CMDT:
  - CMDT2, for detailed information relating to a CICS- or user-maintained data table, or a coupling facility data table. You can hyperlink to this view from the Table Info field of the CMDTD view.
  - CMDT3, for statistical information relating to a data table file. You can hyperlink to this view from the Data Set Info field of the CMDT2 view.
- The FILE operations view is amended to reflect support of coupling facility data tables.

## Support for CICS Web enhancements

CICS Transaction Server for OS/390 Release 3 introduces various enhancements to the CICS Web support. Part of this function is the introduction of new CICS RDO resource definitions, HTMLTEMPLATE and TCPIPSERVICE. CICSplex SM supports this function by:

- New BAS views:
  - DOCDEF, which defines document templates.
  - TCPDEF, which defines TCP/IP services.
- New operations views for document templates:
  - DOCTEMP, a general view of document templates.
  - DOCTEMPD, a detailed view of a selected document template.
  - DOCTEMPS, a summary view of document templates.
- New operations views for TCP/IP services:
  - TCPIPS, a general view of TCP/IP services.
  - TCPIPSD, a detailed view of a selected TCP/IP service.
  - TCPIPSS, a summary view of TCP/IP services.

## Java Virtual Machine

CICS Transaction Server for OS/390 Release 3 provides the support required to run a Java transaction under the control of an OS/390 Java Virtual Machine (JVM). CICSplex SM supports this function by:

- Two new fields, JVM and JVMClass, on the BAS PROGDEF view.
- Three new fields, Runtime, JVM Class, and JVM Debug, on the operations PROGRAMD view.
- A new operations view, PROGRAMJ, a detailed view of the JVM Class value for the current program.

## Open Transaction Environment

CICS Transaction Server for OS/390 Release 3 introduces an enhancement to the internal architecture of CICS to enable specified tasks to run under their own task control block. In support of this function, CICSplex SM extends its inquiry function for the following resource types:

- New fields, Force QR and Max open TCBs, added to the CICSRCN2 view.
- A new field, Concurrency, added to the PROGRAMD view.
- Amendments to the PROGRAM view.
- Amendments to the EXITGLUE and EXITTRUE views.
- Amendments to the TASK and TASKD views.

## FEPI

CICS Transaction Server for OS/390 Release 3 introduces changes to the way in which the CICS/ESA Front End Programming Interface (FEPI) is managed using CICSplex SM. The changes are:

- New BAS views:
  - FENODDEF, which defines FEPI nodes
  - FEPOODEF, which defines FEPI pools
  - FEPRODEF, which defines FEPI property sets
  - FETRGDEF, which defines FEPI targets.
- FEPI resources are now installed using these new BAS views; they cannot be installed using the operations views

## Support for Tivoli Global Enterprise Manager

CICS Transaction Server for OS/390 Release 3 provides support for Tivoli Global Enterprise Manager (Tivoli GEM). For users of the Tivoli GEM client, the CICSplex SM Instrumentation feature enables users to view status information for the CMAS environment and the MAS environment of the CICSplex.

---

## Changes made to this book for CICS Transaction Server for OS/390 Release 3

In addition to the changes required by new and changed function, the following changes have been made to this book:

- Information on CICSplex SM functions Business Application Services, workload management, real-time analysis, and monitoring has been removed from Chapter 2, and incorporated in the main chapters on these subjects.

## Chapter 1. Introducing CICSplex SM

The CICSplex System Manager element of CICS Transaction Server for OS/390 Release 3 (CICSplex SM) is a system management tool that enables you to manage multiple CICS systems as if they were a single system. Enterprises in which CICSplex SM may be needed range from those running 10 or 15 CICS systems, to those running two or three hundred (or more) CICS systems: in the latest MVS™ sysplex environment, having such large numbers of CICS systems to support a transaction-processing workload is becoming increasingly common.

CICSplex SM has the following key aspects:

- *CICSplex SM conforms to the IBM strategy for system management:*
  - It provides consistent creation and management of system management data.
  - It is an enterprise-wide system management application.
  - It supports increased automation of system management tasks.
  - It is structured into manager and agent components, has an enterprise information base, a coordination information base, and is based on a data model.
- *CICSplex SM has many reliability, availability, and serviceability (RAS) features.* For example:
  - CICS systems are managed from a separate CICS system, but one with no terminals or user programs. There can be multiple instances of this “managing” system.
  - User access to CICSplex SM functions is provided via a separate address space, of which there can also be multiple instances in an enterprise.
  - System management data is held separately in data-space caches, so that it is unaffected by what happens in both managing and managed CICS systems.
- *CICSplex SM is secure.*

Even though CICSplex SM has the potential to allow access to all of an enterprise's CICS resources from a single session, it ensures that security is not compromised. You can use a SAF-compliant external security manager to prevent unauthorized access to:

- CICSplex SM's own procedures and data
- CICSplex SM's system management functions and the CICS resources they manage

Security checks that are usually performed by CICS/ESA® (that is, CICS command checking and CICS resource checking) are performed instead by CICSplex SM.

Security setup is described for the IBM Resource Access Control Facility (RACF®), and is modeled on the use of RACF security in CICS/ESA. As with CICS/ESA, you can substitute another SAF-compliant external security manager if required.

Chapter 2, “The CICSplex SM environment” on page 9 provides an overview of the basic CICSplex SM features and functions.

---

### CICS system connectivity

This release of CICSplex SM may be used to control CICS systems that are directly connected to it, and indirectly connected through a previous release of CICSplex SM.

For this release of CICSplex SM, the directly-connectable CICS systems are:

- CICS Transaction Server for OS/390 1.3
- CICS Transaction Server for OS/390 1.2
- CICS Transaction Server for OS/390 1.1
- CICS for MVS/ESA 4.1
- CICS Transaction Server for VSE/ESA Release 1
- CICS for VSE/ESA 2.3
- CICS for OS/2 3.1
- CICS for OS/2 3.0

CICS systems that are not directly connectable to this release of CICSplex SM are:

- CICS for MVS/ESA 3.3
- CICS for MVS 2.1.2
- CICS for VSE/ESA 2.2
- CICS/OS2 2.0.1

**Note:** IBM Service no longer supports these CICS release levels.

You can use this release of CICSplex SM to control CICS systems that are connected to, and managed by, your previous release of CICSplex SM. However, if you have any directly-connectable release levels of CICS, as listed above, that are connected to a previous release of CICSplex SM, you are strongly recommended to migrate them to the current release of CICSplex SM, to take full advantage of the enhanced management services. See the *CICS Transaction Server for OS/390 Migration Guide* for information on how to do this.

Table 1 on page 3 shows which CICS systems may be directly connected to which releases of CICSplex SM.



Table 1. Directly-connectable CICS systems by CICSplex SM release

CICS system	CICSplex SM component of CICS TS 1.3	CICSplex SM 1.3	CICSplex SM 1.2
CICS TS 1.3	Yes	No	No
CICS TS 1.2	Yes	Yes	No
CICS TS 1.1	Yes	Yes	Yes
CICS for MVS/ESA 4.1	Yes	Yes	Yes
CICS for MVS/ESA 3.3	No	Yes	Yes
CICS for MVS 2.1.2	No	Yes	Yes
CICS TS for VSE/ESA Rel 1	Yes	No	No
CICS for VSE/ESA 2.3	Yes	Yes	Yes
CICS for VSE/ESA 2.2	No	Yes	Yes
CICS for OS/2 3.1	Yes	No	No
CICS for OS/2 3.0	Yes	Yes	Yes
CICS/OS2 2.0.1	No	Yes	Yes

## Features of CICSplex SM

This section describes briefly the system management functions of CICSplex SM:

- **A real-time, single-system image (SSI)**

CICSplex SM provides a real-time, single-system image (SSI) of all CICS regions and resources that make up your enterprise's transaction processing environment. CICSplex SM creates an inventory of the CICS systems and resources, and maps the relationships between them; this is called the CICSplex SM *topology*. Thus the operator no longer needs to know the location of a resource before working with it. The SSI is provided by the CICSplex SM *operating* function and applies to all CICSplex SM applications: operations, monitoring, real-time analysis (RTA), and workload management (WLM).

- **A single point of control**

The CICSplex SM operator can manage all of the enterprise CICS systems and their resources from a single session. That is, CICSplex SM can provide a *single point of control* for the enterprise, which in turn means that the CICSplex SM operator is able to manage larger and more complex configurations of CICS resources than ever before. Furthermore, you can have *multiple* points of control, so that multiple CICS operators in multiple locations each may have a complete view of the enterprise CICS systems and resources, or a view of those systems and resources that is tailored to their individual requirements. Finally, because the physical location of these points of control is irrelevant, you have total flexibility in appointing control locations.

- **Operations for the entire CICSplex**

From any point of control, the operator can take advantage of the SSI to perform tasks, either across the entire CICSplex or across a selected subset. You can display information about the current status of one or more instances of a CICS resource in an enterprise, and you can also change the status of the resources with a single entry. You can issue an *action command* to affect the status of the displayed resources.

You use the ISPF EUI to issue the commands. The responses are displayed in panels known as *operations views*, that can summarize related facts and provide access, using *hyperlinks* to other, related information. The operations views mirror the functionality currently provided for CICS systems. Operators can therefore work in essentially the same way as they are used to, without any change to their basic approach to daily system activities.

The operations views are described in detail in *CICSplex SM Operations Views Reference*.

- **Management of your business applications**

CICSplex SM enables you to manage your enterprise in terms of your business applications rather than your CICS systems:

- **Business Application Services (BAS)** allows you to manage your resources at the application level, by providing:

- A *single point of definition* for your resources. All the resources for the CICSplex, and the relationships between them, are held in one place, on the CICSplex SM data repository, giving a single-system image for the CICSplex. CICSplex SM produces local and remote instances of a resource from a single definition.
- *Logical scoping*, which enables you to link and manage your resources according to their business relationship, rather than by their physical location in a CICS system.
- If you are running CICS/ESA 4.1 or later, *installation* of those resources, either automatically when the CICS system is started, or dynamically, as required, into a running CICSplex

With previous releases of CICS, resource definition online (RDO) is used for managing resources. RDO is based on a structure in which definitions are tied to a single group, and groups are processed sequentially from a group list. BAS frees resource definitions from association with only one group, which means that a resource definition can be used and reused, and associated with more than one group as needed. BAS enables you to associate your resources according to their use within your enterprise. This in turn means that you can, if you wish, manage individual resources, rather than a group. For example, you could disable all the files associated with your payroll system, without affecting any other files in the CICSplex.

Chapter 6, “Managing workloads” on page 59 gives an overview of BAS. For full details, see *CICSplex SM Managing Business Applications*.

- Support for **CICS business transaction services (BTS)** allows you to manage the business application run-time environment.

CICSplex SM provides management support for BTS by dynamically routing BTS work across a BTS-set, and by monitoring the management of data in a distributed environment.

You do not have to use CICSplex SM workload management to route BTS activities, but using CICSplex SM can offer many benefits:

- Management of distributed data
- Workload separation and balancing functions of workload management
- Customizable dynamic routing program EYU9XLOP

- Reduction in link definitions if you also use BAS
- Cooperation between BAS and BTS in the management of your business environment

For full details, see the *CICS Business Transaction Services* book.

- **Management of your workloads**

CICSplex SM's workload management (WLM) uses the dynamic routing program EYU9XLOP to route eligible work requests from a requesting region to a suitable target region selected at the time the transaction is initiated.

EYU9XLOP handles the dynamic routing of:

- Transactions initiated at a terminal
- Eligible EXEC CICS START requests that are associated with a terminal
- Eligible EXEC CICS START requests that are not associated with a terminal
- Dynamic program link (DPL) requests that are received using:
  - The CICS Web Interface
  - The CICS Gateway for Java
  - External CICS interface (EXCI) client programs
  - Any CICS client workstation products using the External Call Interface (ECI)
  - Distributed Computing Environment (DCE) remote procedure calls (RPCs)
  - Open Network Computing (ONC) RPCs
  - Internet Inter-Object Request Block Protocol (IIOP)
  - Any function that issues an EXEC CICS LINK PROGRAM request
- Transaction associated with CICS business transaction services (BTS) activities

You can customize EYU9XLOP, or write your own program, and use it in conjunction with the CICS-supplied user-replaceable programs DFHDYP and DFHDSRP, to handle your dynamic routing requirements.

More information on dynamic routing and workload management is given in Chapter 6, "Managing workloads" on page 59 . You could also refer to the relevant CICS Transaction Server for OS/390 Release 3 publications.

- **Automated exception reporting for CICS resources**

CICSplex SM's Real-Time Analysis (RTA) function provides automatic, external, notification of conditions in which you have expressed an interest. The notification can take the form of a console message, or of a generic alert to NetView®, or both. Real-time analysis is not concerned solely with commonly recognized error conditions: you can ask to be notified about any aspect of a resource's status.

The RTA functions of CICSplex SM are described in greater detail in Chapter 7, "Exception reporting using real-time analysis (RTA)" on page 75. For full details, see *CICSplex SM Managing Resource Usage*.

- **Monitoring functions for the collection of statistical data for CICS resources**

The CICSplex SM *monitoring* functions support the collection of performance-related data, at user-defined intervals, for named resource instances within a set of CICS systems.

The monitoring functions of CICSplex SM are described in more detail in Chapter 8, “Collecting statistics using CICSplex SM monitoring” on page 87. For full details, see *CICSplex SM Managing Resource Usage*.

- **An application programming interface (API)**

CICSplex SM provides an application programming interface (API) that allows applications to:

- Access information about CICS and CICSplex SM resources. For details of system connectivity, see “CICS system connectivity” on page 2.
- Invoke the services of CICSplex SM.

A command-level interface is available to programs that are written in these languages:

- Assembler
- PL/I
- COBOL
- C™

Programs written in Assembler, PL/I, COBOL, and C are supported in the CICS/ESA, CICS/MVS®, and MVS/ESA Batch, TSO, and NetView environments.

In addition, a REXX run-time interface is available under MVS/ESA Batch, TSO, and NetView.

You can use the CICSplex SM API to write external programs that automate the management of CICSplex SM and CICS resource definitions. Such programs could be used to integrate the CICSplex SM system management functions into your enterprise-wide change management process. For example, you could write an API program to coordinate resource definition changes with database or file updates, or the standard life cycle of an application. For a complete description of the API, see the *CICSplex SM Application Programming Reference* and the *CICSplex SM Application Programming Guide*.

- **Interfaces to automation products such as NetView Resource Object Data Manager (RODM)**

CICSplex SM can record in RODM the status of all known non-transitory CICS resources. The CICS resource status can be displayed using NetView Graphics Resource Monitor Facility, and to be correlated with other resources.

This is an optional function that requires NetView MultiSystem Manager Version 2.

- **Management of the CICSplex SM environment**

You manage the CICSplex SM environment using:

- **CICSplex SM objects**

To define the configuration of your CICS systems to CICSplex SM (and to define your BAS, WLM, RTA, and monitoring requirements) you create *CICSplex SM objects*, and associate them with each other. For each object, and for each association or link between them, a record is created

in a CICSplex SM data repository. CICSplex SM objects are described in “CICSplex SM objects” on page 15.

- **Data repository**

The data repository contains the objects that define the CICSplex SM components, resources, system management requirements, and the relationships between them. The definitions can be created using the EUI views, or the *batched repository-update facility*.

- **The batched repository-update facility**

The batched repository-update facility allows you to create and update large numbers of CICSplex SM and CICS resource definitions by submitting one command that is used as the template for other definitions. The batched repository-update facility is also used for migrating your definitions from one platform to another, and for backing up the data repository. More information is given in “The batched repository-update facility” on page 17. For details, see *CICSplex SM Administration*.

- **Management of time-dependent activity**

Much of CICSplex SM’s activity is time dependent. For example, you can specify on your RTA and monitoring definitions when you want the definition to be active. Also, you may want CICS systems running in the same CICSplex but different time zones to run as if they were in the same time zone. You are able to create time period-definitions that control:

- Exactly when any part of your enterprise is operational, regardless of the local time zone.
- The times you want certain system management functions to be operational.

The international standard for time zones is used, based on Greenwich Mean Time (GMT). You select the time zone in which you want your CICSplex to run. You can then make adjustments, either for locations that have implemented times that are not different from GMT by 60-minute multiples, and for daylight saving.

Details of time-period definition are in *CICSplex SM Administration*.

- **Integration with Tivoli Global Enterprise Manager**

For users of Tivoli GEM, the CICSplex SM Instrumentation feature enables users to view status information for the CMAS and MAS environments of the CICSplex. This can be very helpful in reporting back the status of specific subsets of an enterprise’s applications. For more information see “Support for Tivoli Global Enterprise Manager” on page 18.

---

## Where next?

Chapter 2, “The CICSplex SM environment” on page 9 describes the configuration and topology of CICSplex SM and the system management functions in more detail. Chapter 3, “Designing your CICSplex SM environment” on page 19 starts guiding you through the process of designing your own CICSplex SM environment.

A Starter Set is supplied that contains all you need to get started. See Chapter 10, “The CICSplex SM Starter Set” on page 111 for the details, including the

## where next?

CICSplex SM and CICS resource definitions. You might find it useful to refer to these for examples as you read the following chapters.

---

## Chapter 2. The CICSplex SM environment

This chapter is intended for anyone who needs an overview of CICSplex SM. This chapter looks at the structure of CICSplex SM and at the components that enable CICSplex SM to perform its tasks. This chapter introduces all of the components of CICSplex SM that you need to know about, either because you will have to define them at some stage, or because their very presence or mode of operation will affect the design of your CICSplex SM environment.

Figure 1 on page 11 shows the main components of CICSplex SM and illustrates some of the links between them. The figure is explained in the descriptions of the CICSplex SM components in the remainder of this chapter.

This chapter covers:

- “Overview”
- “The CICSplex” on page 10
- “The managed application system (MAS)” on page 11, including the remote managed application system (remote MAS)
- “CICSplex SM address space (CMAS)” on page 13
- “Environment Services System Services (ESSS)” on page 14
- “The coordinating address space (CAS) and the EUI” on page 14
- “The CICSplex SM user interface” on page 14
- “CICSplex SM objects” on page 15
- “The data repository” on page 17
- “The batched repository-update facility” on page 17
- “Support for Tivoli Global Enterprise Manager” on page 18
- “Where next?” on page 18

---

### Overview

This section gives you a brief overview of the main elements of the CICSplex SM environment. See Figure 1 on page 11.

Each CICS system to be managed by CICSplex SM is called a *managed application system (MAS)*. The MASs are defined and managed as part of a *CICSplex*. Each MAS in a CICSplex is managed by a *CICSplex SM address space (CMAS)*, which is a CICS/ESA 3.3 (or later) system running on an MVS image. (For details of system connectability, see “CICS system connectivity” on page 2.) The MASs in a CICSplex can be managed by several CMASs, but only one is defined as the *maintenance point CMAS* responsible for keeping the data used by each CMAS synchronized. A MAS may be either *local* or *remote*, depending on its communication link with its CMAS. Typically, but not necessarily, a remote MAS runs on a different MVS image to its CMAS, or on a VSE or OS/2 machine.

CMASs communicate across *CMAS-to-CMAS* links, which are typically used for routing management commands and data between CMASs. A *coordinating address space (CAS)* is used to set up the CICSplex SM component topology, and to support the MVS/TSO ISPF end-user interface (EUI) to CICSplex SM.

Resource definition is managed through Business Application Services (BAS). Workload management (WLM), real-time analysis (RTA), and monitoring services

are used to manage the CICSplex SM configuration and gather statistical information.

All CICSplex SM components, resources, system management requirements, and the relationships between them, are held as *objects* (see “CICSplex SM objects” on page 15) in a *data repository* (see “The data repository” on page 17). These objects can be manipulated using the end-user interface views (see “The CICSplex SM user interface” on page 14). The batched repository-update facility (see “The batched repository-update facility” on page 17) is provided for the batched creation of CICSplex SM resource definitions.

---

## The CICSplex

For CICSplex SM's purposes, a *CICSplex* is **any** grouping of CICS systems that you want to manage and manipulate as if they were a single entity. That is, a CICSplex is a management domain, made up of those CICS systems for which you want to establish a single system image (SSI). A CICSplex managed by CICSplex SM could include every CICS system in your enterprise. Alternatively, you could define multiple CICSplexes, each of which would include a logical grouping of CICS systems. For example, a CICSplex could comprise all CICS systems on a particular MVS image, or all CICS systems accessible by a subset of your users, or all CICS systems serving a particular geographical area. Furthermore, the composition of a CICSplex can be altered without affecting the functions of the underlying CICS systems. The CICS systems in a single CICSplex managed by CICSplex SM do not have to be explicitly connected to each other for management purposes.

The most significant facts about a CICSplex managed by CICSplex SM are:

- The CICSplex is the largest unit you can work with. That is, you cannot group CICSplexes and manipulate such a group as a single entity.
- You cannot copy CICSplex SM data from one CICSplex to another. For system management purposes, the CICSplex is “sealed” against other CICSplexes.
- CICSplexes are mutually exclusive, so no CICS system can belong to more than one CICSplex.

CICSplex SM enables you to define subsets of a CICSplex, which are known as *CICS system groups*. CICS system groups are not mutually exclusive, and can reference the same CICSplex SM definitions. Thus, if you decide to include every CICS system in your enterprise in a single CICSplex, there are mechanisms for managing groups of CICS systems within the CICSplex as if each group were a single system.

You can assign an unlimited number of CICS systems and CICS system groups to an existing CICSplex.

Although you can define a CICS system to only one CICSplex, you can assign a CICS system to multiple CICS system groups within the CICSplex. You can also assign the CICS system group to any number of other CICS system groups.



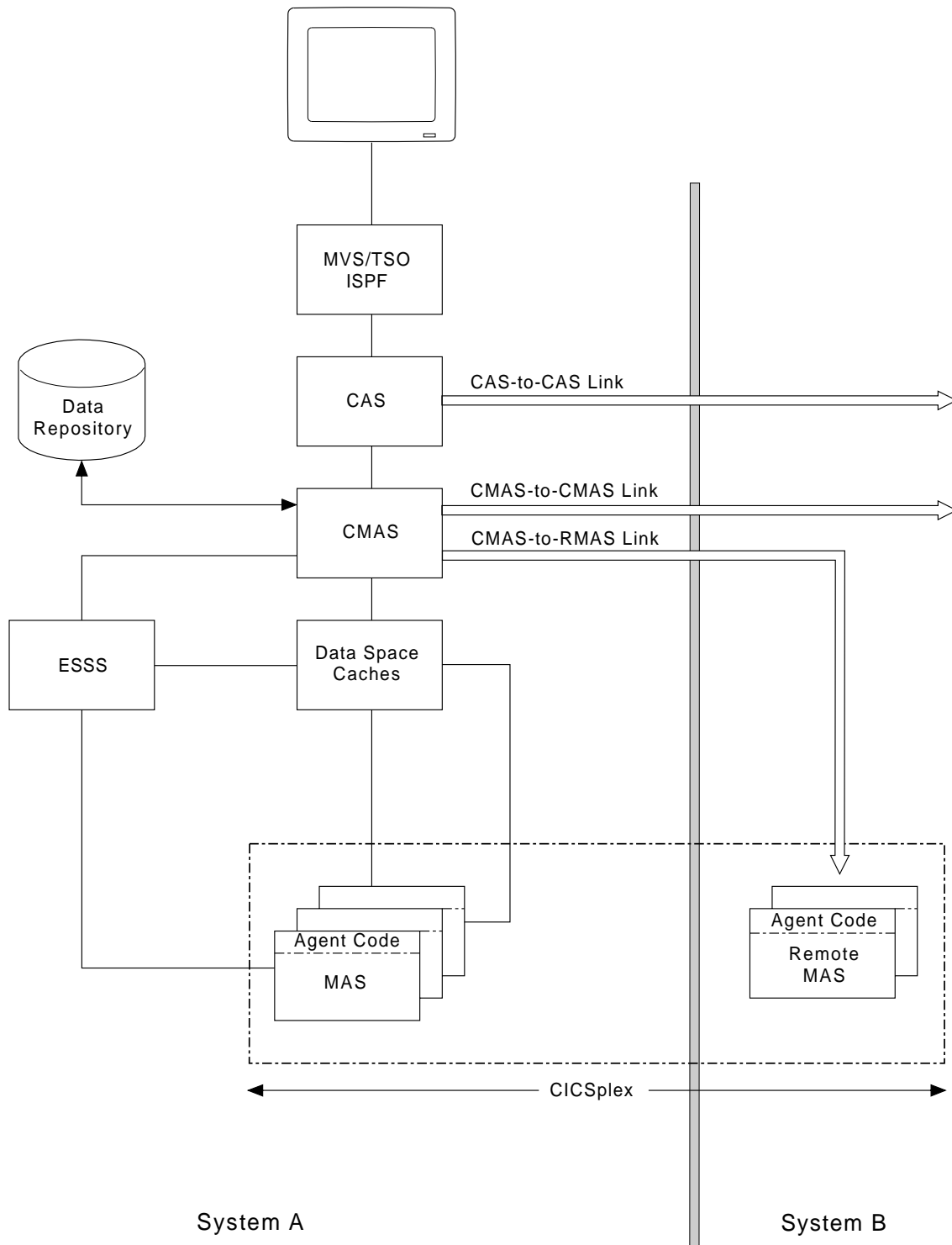

Figure 1. Key components of a CICSPlex SM configuration. Each of these components is described in this chapter.

## The managed application system (MAS)

Each running CICS system that is being managed by CICSPlex SM is known as a *managed application system (MAS)*. CICSPlex SM can manage the systems listed in “CICS system connectivity” on page 2.

If a MAS belongs to a CICS/XRF pair, it must be the active region.



- A remote MAS cannot be a routing region for running workload management. (Workload management is described in Chapter 6, “Managing workloads” on page 59.)
- No CICS Monitoring Facility (CMF) data is collected, which means that less monitor data is available for remote MASs. (Monitoring is described in Chapter 8, “Collecting statistics using CICSplex SM monitoring” on page 87.)

System management data is written to operating system storage by the remote MAS agent code and shipped to the CMAS.

**Note:** CICS/MVS 2.1.2 systems running under MVS/XA, CICS/VSE, and CICS for OS/2 systems, must be managed as remote MASs.

---

## CICSplex SM address space (CMAS)

The *CICSplex SM address space* (CMAS) is the hub of any CICSplex SM configuration, because it is responsible for most of the work involved in managing and reporting on CICS systems and their resources. Every CICSplex is managed by at least one CMAS. The CMAS is responsible for the *single system image (SSI)* that enables the operator to manage a CICSplex as if it were a single CICS system, regardless of the number of CICS systems defined as belonging to the CICSplex, and regardless of their physical location.

The CMAS implements the BAS, WLM, RTA, and monitoring functions of CICSplex SM, and maintains configuration information about the CICSplexes it is managing. It also holds information about its own links with other CMASs. It stores this information in its *data repository*. (See Figure 2 on page 12.)

A CMAS is a full-function, CICS/ESA 3.3 (or later) system. Most CMAS components run as CICS/ESA tasks, and CMAS connections to other components are implemented using CICS intercommunication methods. However, the CMAS does not support user applications or terminals, and its resources should not be considered available for non-CMAS tasks.

A CMAS can be running a lower release of CICS/ESA than its MASs. However, both the CMAS and the MASs must be running the same release of CICSplex SM; for example, a CICSplex SM Release 3 CMAS cannot manage a CICS TS for OS/390 Release 3 MAS.

A CMAS is not part of any CICSplex: a single CMAS can participate in the management of multiple CICSplexes, but belongs to none of them.

If a CICSplex is managed by multiple CMASs:

- The CMASs are connected to each other by *CMAS-to-CMAS* links defined to CICSplex SM. These links ensure that each CMAS can access data held by other CMASs, and a single-system image can be presented to the operators.
- One of the CMASs is designated the *maintenance point* CMAS. That CMAS is responsible for maintaining all the CICSplex SM definitions relating to a CICSplex and keeping all the data repositories in synchronization.

CICSplex SM can issue SNA generic alerts to NetView or populate the NetView RODM data cache with status information for CICS resources, provided that a CMAS is installed on the same MVS image as the NetView instance with which CICSplex SM is working.

---

## Environment Services System Services (ESSS)

*Environment Services System Services* (ESSS) is a limited-function, MVS/ESA system address space that provides MVS services to CICSplex SM components. In particular, ESSS owns all of the MVS/ESA data spaces on an MVS image, so that they can exist independently of CMASs and MASs, yet remain accessible by both. The benefit of this arrangement is that the CICSplex SM data accumulating in the data spaces is not vulnerable to events in the MAS and CMAS components. ESSS also plays a part in some aspects of communication between a CMAS and any NetView instance on the same MVS image as the CMAS.

There is one instance of ESSS on any MVS image on which one or more CMASs is installed. It is created automatically by the first CMAS to start on an MVS image.

---

## The coordinating address space (CAS) and the EUI

The *coordinating address space* (CAS) is an MVS/ESA subsystem whose main function is to support the MVS/TSO ISPF end-user interface (EUI) to CICSplex SM. The CAS is not part of a CICSplex, but belongs to the managing topology of CICSplex SM. (See Figure 2 on page 12.)

---

## The CICSplex SM user interface

The CICSplex SM user interface is an MVS/TSO ISPF EUI supported by the CAS. This ISPF interface is used to set up the CICSplex SM component topology and can be used by operators to manage CICS systems and resources.

CICSplex SM's EUI is used:

- By the CICSplex SM operator, who uses it much as the master-terminal operator uses CEMT and other, CICS-supplied transactions to monitor and control the resources of a single CICS system.
- By the system administrator, who uses the interface to define and maintain the CICSplex SM configuration, and to specify BAS, WLM, RTA, and monitoring requirements.

The general principles of the CICSplex SM user interface are defined in the *CICSplex SM User Interface Guide*.

Information about your enterprise is displayed in formatted displays called *views*. You control the type of information that is displayed, and the format in which it is displayed, using *view commands*. From a view, you use *action commands* to manage the displayed data. Before you enter a view command, you define the CICS systems or resources affected by the command by setting a *context* and a *scope*:

- The *context* is almost always the CICSplex.

**Note:** When you are viewing or updating CMAS configuration data, the context is a CMAS rather than a CICSplex, and any scope value is ignored.

(Remember that the CICSplex is the largest single unit on which any CICSplex SM command can act.)

- The *scope* is always a subset of the context: its purpose is to limit the effects of CICSplex SM commands to particular CICS systems or resources. Indeed, the effects of any command cannot be felt beyond the current scope. The scope can be a single CICS system, a CICS system group (made up of any number of CICS systems in the CICSplex), or a business application (represented by a *resource description*).

You can look at CICS systems or resources anywhere in your enterprise from one point, the single point of control, simply by changing the context and scope.

---

### CICSplex SM objects

To define the configuration of your CICS systems to CICSplex SM, and to define your BAS, WLM, RTA, and monitoring requirements, you create *CICSplex SM objects*, and associate them with each other. For each object, and for each association or link between them, a record is created in a CICSplex SM data repository. Figure 3 on page 16 shows how the CICSplex SM objects relate to each other.

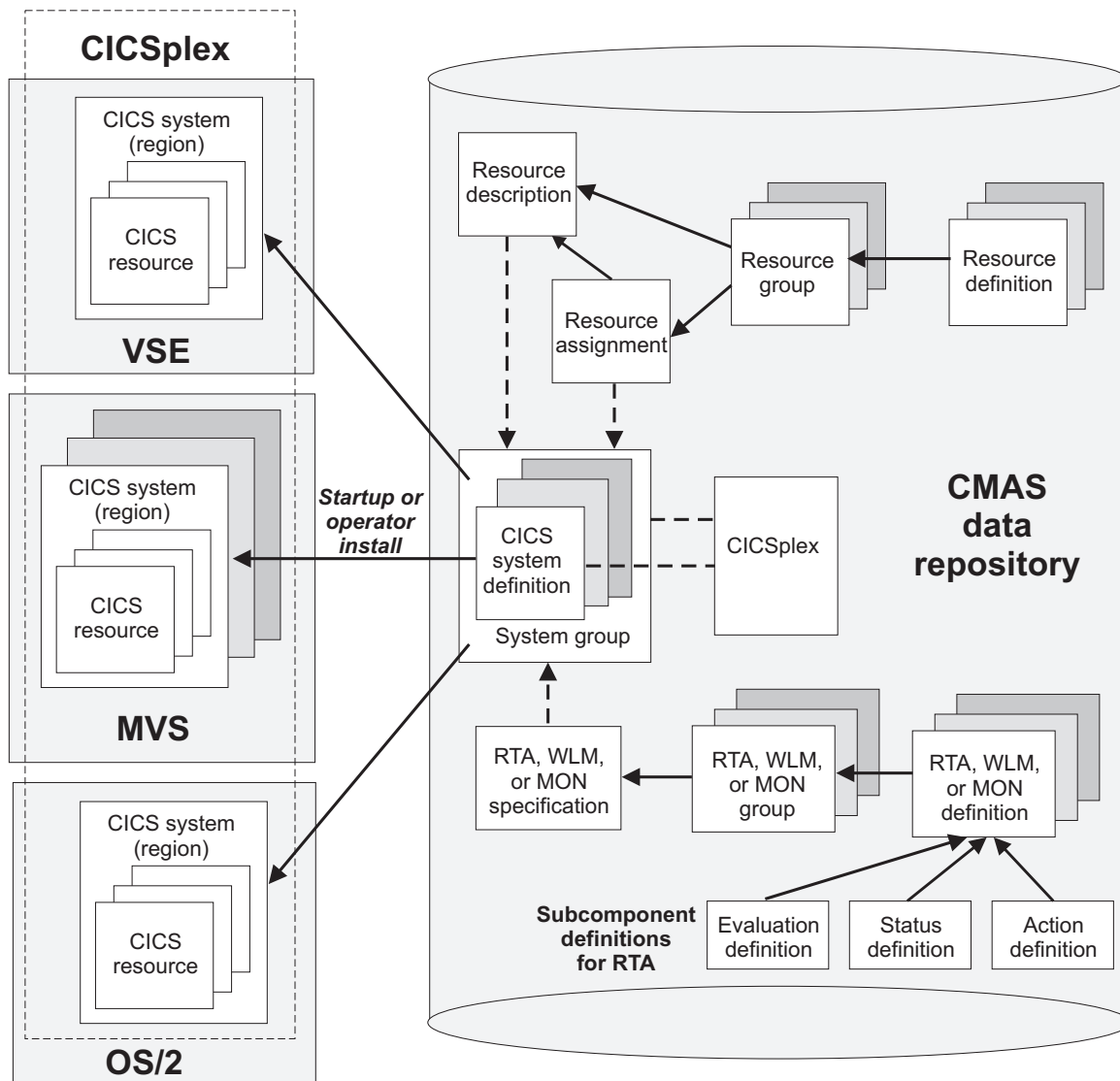

Figure 3. The CICSplex SM object model

These objects can be split into three categories:

1. *CICSplex and CICS system* objects, used for defining the CICSplexes and CICS systems to be managed by CICSplex SM. This includes defining the links between CICS systems and creating CICS system groups. These objects are described in Chapter 3, “Designing your CICSplex SM environment” on page 19; information on defining these objects is in Chapter 4, “Defining the CICSplex SM configuration and topology” on page 37.
2. *BAS* objects, used for logical scoping and managing the CICS resource definition and installation processes. You can look on the objects in this category as defining what resources you want your CICS systems to use. These CICSplex SM objects are described in “Multiple versions of a resource definition” on page 44. Information on defining BAS objects is in “Using full-function form BAS” on page 54.
3. *Operation* objects are those objects used for operating the CICS resources that exist in running CICS systems. You can look on the objects in this category as identifying the resources you want to monitor at run-time, for automated

workload management, automated exception reporting, and collection of statistical data. These CICSplex SM objects are described in “Managing monitoring functions” on page 89, “Managing workloads” on page 66, and “Managing RTA” on page 80.

---

### The data repository

The single-system image of a CICS system or group of CICS systems is provided by the CMAS using the CICSplex SM and resource definitions held on the *data repository*. Each CMAS has its own data repository. The data repository is a VSAM KSDS that is created using a CICSplex SM post-installation job. As with all data sets, you need to take regular backups of each data repository in your environment. Details of creating and managing a data repository are in *CICS Transaction Server for OS/390 Installation Guide*.

CICSplex SM definitions and CICS resource definitions held on the data repository can be managed in the following ways:

- Using the EUI views; see “The CICSplex SM user interface” on page 14
- Using the batched repository-update facility; see “The batched repository-update facility”
- Using the API; see *CICSplex SM Application Programming Reference* and *CICSplex SM Application Programming Guide*.

You can create a visual map of the definitions in your data repository. The map can be of business application services, resource monitoring, real-time analysis, or workload monitoring. You select a starting point for the map, which might be, for example, a CICS system group or an individual resource, and CICSplex SM displays the starting point and all the definitions that either refer to that definition or are referred to by it. You use either the MAP view command or the batched repository-update facility to create a map.

---

### The batched repository-update facility

To help you in the migration of your CICS definitions to CICSplex SM, you can use the EXTRACT command of the CICS DFHCSDUP utility to read CSD records. CICSplex SM provides an exit routine EYU9BCSD that generates, from the DFHCSDUP output, equivalent resource definitions for input to the batched repository-update facility. For more information, see *CICSplex SM Managing Business Applications*.

The batched repository-update facility is also useful for migrating your definitions from one platform to another. You can use it to retrieve existing resource definitions from the CICSplex SM data repository then, after making any required changes to the definitions, input the changes to another batched repository-update facility run that creates resource definitions on the new platform.

For a complete description of the batched repository-update facility, see the *CICSplex SM Administration* book.

---

## Support for Tivoli Global Enterprise Manager

Tivoli GEM provides a consistent systems management view of an enterprise. Most enterprises have a set of business objectives. Those business objectives can be achieved using various business systems. A business system might comprise various hardware and software packages from multiple vendors, as well as user-written applications. One or more of the applications within a business system can make use of various middleware components such as database, messaging services, or a transaction monitor.

If a business system uses the CICS transaction monitor as part of a CICSplex, Tivoli GEM instrumentation is provided for CICSplex SM systems management.

The instrumentation for CICSplex SM provided by Tivoli GEM enables an individual using the Tivoli GEM client to view status information for the CMAS environment and the MAS environment of the CICSplex. The CMAS and MAS environments, when grouped together, form the transaction system component at the middleware layer of a business system.

The instrumentation will always discover the status of the CMAS components without any changes to the existing CICSplex SM environment. This feature provides the immediate benefit of a graphical status display of the CMAS subsystem for the GEM client user.

The instrumentation will also automatically discover the MAS environment within the CICSplex. The instrumentation discovers any MAS which makes use of the RTA MRM and/or SAM functions.

The benefit of discovering only those MASs which use RTA and SAM is that the user has the ability to only have a subset of the CICSplex discovered. This method of discovery can be helpful in reporting a specific subset of MASs, such as those supporting an enterprise's e-mail application, where some of the CICS systems are used as e-mail servers. If the e-mail application had any RTADEFs or STATDEFs analyzing its operation, these would also be discovered and displayed at the client. This would provide the client user at a help desk or operations center with important status indicators for the CICS layer of the e-mail system.

For details of CICSplex SM instrumentation in Tivoli GEM, see the *Tivoli GEM CICSplex SM Instrumentation User's Guide* (GC31-5156).

---

## Where next?

Chapter 1, "Introducing CICSplex SM" on page 1 and this chapter have given you an overview of CICSplex SM and the facilities it offers to help you administer your enterprise. The rest of this book tells you how to design your CICSplex SM environment and how to start planning for and defining those functions you wish to use. The chapters point you to where you can find the details of how to perform the required tasks.



---

## Chapter 3. Designing your CICSplex SM environment

This chapter takes you through the process of identifying the CICSplexes in your enterprise, the CICS systems that will be managed by CICSplex SM (the MASs) and those that will not, and how to identify local and remote MASs.

The chapter covers:

- “Designing your CICSplexes”
- “Locating CMASs” on page 26
- “Locating CASs” on page 32
- “Naming your CICSplex SM entities” on page 35
- “A staged implementation” on page 36
- “Updating the initial design” on page 36
- “Where next?” on page 36

This chapter helps you to design your CICSplex SM environment by giving you guidance on each step of the process. An example is used to illustrate the process.

---

### Designing your CICSplexes

The CICSplex is the largest unit that you can manipulate in your CICSplex SM configuration. A CICSplex is made up of an association of CICS systems and CICS system groups. This section gives guidance on deciding how to group your CICS systems into system groups, and then to identify CICSplexes.

### Identifying your CICS systems and regions

The very first thing you must do when planning to install CICSplex SM is to identify the CICS systems or regions in your enterprise. You may already have a clear picture of the systems you have, and of where they are installed. However, in the larger enterprises, where CICS systems are numbered in the hundreds, it's possible that no one individual has this complete view. Whatever the case, the aim of this exercise is to *document* the current arrangement of your CICS systems in a graphical form. The “map” you produce should be a logical representation of your CICS systems rather than a physical one, so don't worry unduly about recording where particular processors are located, for example. Whether you simply sketch the map on paper or use an on-line graphics tool, be sure to leave plenty of space so that you can update the map with CICSplex SM components as you work through this chapter.

Figure 4 on page 20 shows an example of the type of map you should be aiming to produce.

## identifying CICS systems and regions

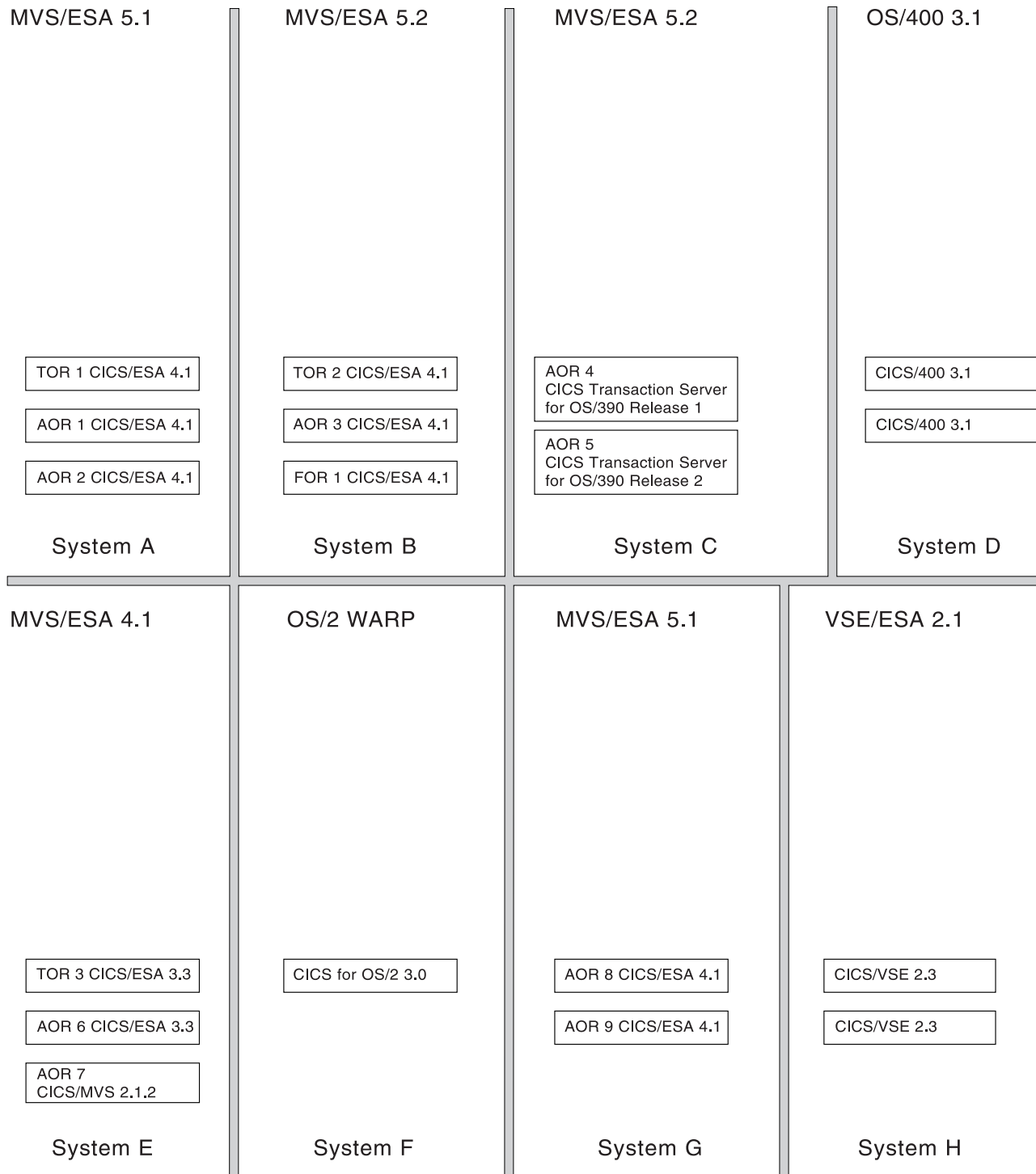

Figure 4. A map of the enterprise CICS systems. This enterprise has 18 CICS systems distributed among MVS/ESA, VSE/ESA, OS/400, and OS/2 WARP environments.

Your initial map of the enterprise CICS systems should include every operating environment in which CICS is installed. It should also show:

- The current version and release of the operating systems being used
- The CICS systems running in each environment, and the CICS platform, version, and release of each one
- The resource-manager role of each CICS system, if applicable

(If you can't get all of this detail on your map, record it separately from the graphical representation of the CICS systems.)

### Which CICS systems can be managed by CICSplex SM?

Next, refine the map by identifying those CICS systems or systems that can and cannot be managed by CICSplex SM. A list of CICS systems that CICSplex SM can manage is given in "CICS system connectivity" on page 2. Any CICS systems that are not directly-connectable to CICS Transaction Server for OS/390 Release 3 and later, as illustrated by System E in the example, will need special consideration when you are locating CMASs (see "Locating CMASs" on page 26).

In the example map shown in Figure 4 on page 20, only the CICS systems running under OS/400 cannot be managed by CICSplex SM. On your own map, choose a convention, such as shading or use of color, for marking CICS systems that cannot be managed by CICSplex SM. However, don't remove them from the map altogether. If you decide to move those systems to a CICS platform or release that CICSplex SM can manage, they can be reinstated easily in the enterprise map.

All the other CICS systems become your MASs. A MAS can be either local (see "Local MAS" on page 12) or remote (see "Remote MAS" on page 12). Whether a MAS is local or remote is decided by how it is connected to its CMAS; this is discussed in "Local or remote MASs" on page 32.

### How many CICSplexes are there in your enterprise?

When you have identified those CICS systems or regions in your enterprise that can be managed by CICSplex SM, your next task is to decide how many CICSplexes you want to define to CICSplex SM, and which of your CICS systems is to belong to each. You can have any number of CICSplexes. For example, you could define:

- One CICSplex for the entire enterprise, or
- One CICSplex for each geographical location, or
- One CICSplex for each business unit within the enterprise, or
- One CICSplex for each existing TOR-AOR-FOR configuration, or
- One CICSplex for each processor, or
- One CICSplex for each operating environment (MVS/ESA, VSE/ESA, and OS/2)

If you do not plan to use workload management facilities, there are no restrictions on how you combine CICS systems and CICS system groups to form a CICSplex. For example, you might associate CICS systems by:

- Geographic area within the CICSplex.
- Function, such as all CICS systems that are application-owning regions (AORs), file-owning regions (FORs), or terminal-owning regions (TORs).

## how many CICSplexes?

- Application, such as the CICS systems serving as AORs, FORs, and TORs that are used by a specific application or group of applications.
- Time period, such as all CICS systems that are normally active during specific hours of the day or night.

If you do plan to use workload management facilities, you must ensure that:

- Each CICS system that is to act as a target for specific workload processing must be in the same CICSplex as the CICS systems acting as routing regions. (The routing regions and target regions associated with a CICSplex can be in the same or different MVS images.)
- CICS systems acting as the routing regions must be at CICS/ESA 4.1 or above and must be locally attached to a CMAS.

If you plan to use the logical scoping, resource management, or installation functions of BAS, you should keep a business application within one CICSplex.

If you plan to use CICS BTS, you should keep a BTS-set with one CICSplex.

The question is, how do you decide what to do? There are no hard-and-fast rules governing the number of CICSplexes you define, but there are some guidelines that will help you select the most suitable configuration for your enterprise. These guidelines are presented in the form of a three-step process:

1. Decide to have a single CICSplex for the entire enterprise
2. Look for reasons why a single CICSplex might not be feasible
3. Confirm your decision

Each of these steps is discussed below.

### **Step 1: decide to have a single CICSplex for the entire enterprise**

This may seem an arbitrary recommendation, but in fact the majority of enterprises will discover that having a single CICSplex best suits their system management goals.

You will remember that the CICSplex is the largest single entity that CICSplex SM can manipulate, and that none of the CICSplex SM definitions or specifications can cross a CICSplex boundary.

Furthermore, CICSplexes are mutually exclusive, so no CICS system can belong to more than one CICSplex. Therefore, having a single CICSplex for the enterprise brings several advantages. For example:

- It provides the greatest opportunity for sharing and reusing BAS, WLM, RTA, and monitoring specifications and definitions.
- It allows you the most flexibility in managing the CICS workload when using the CICSplex SM workload balancing functions.
- Because the SSI operates at the CICSplex level, it gives an SSI of the *enterprise* CICS systems. Also, the CICS operator is able to have a complete view of the enterprise CICS resources from a single CICSplex SM window. (Because any CICSplex SM window can display data from only a single context—that is, a single CICSplex—multiple windows would have to be displayed in a multi-CICSplex environment.)

In summary, having one CICSplex means that there are no system management barriers between one group of the enterprise CICS systems and another.

### **Step 2: look for reasons why a single CICSplex might not be feasible**

The single CICSplex solution is not going to be the best approach in every enterprise, either because its implementation simply isn't possible, or because it doesn't accord with other system management goals.

Firstly, you must ask whether the organization of your enterprise lends itself to a single CICSplex. For example, if you have processors in different geographical locations, are there connections between those processors, or are they managed as separate entities, each with its own workload? If you have these separate units in your enterprise, it's likely that you will need to define multiple CICSplexes, and so manage the enterprise CICS systems as if they belonged to more than one enterprise.

Similarly, is your enterprise organized and run as multiple, separate business units? For example, if you are running a bureau that provides computing services to a variety of customers, the absolute separation of one set of regions from another, even within a single processor, might simplify other processes, such as security management, customer billing, or workload management. If you have similar reasons for wanting to keep the management of some regions entirely separate from the management of others, you should define multiple CICSplexes rather than one.

If you have decided that you need to define more than one CICSplex, for reasons such as those outlined above, it's probably obvious to you already which CICS system or CICS systems should belong to each. If it isn't, you should revisit your decision to have multiple CICSplexes because it suggests that you are trying to erect artificial barriers. And, as a final check, you should ensure that the way you separate the regions is not disruptive to your other system management goals. For example, if you want to use CICSplex SM's WLM functions, both routing regions and the target regions to which they route transactions must belong to the same CICSplex, unless you are planning to customize the supplied dynamic routing program.

### **Step 3: confirm your decision**

When you have decided whether to have one CICSplex or many, check your decision against these other considerations:

- Your CICSplex organization should mirror your enterprise organization: if your enterprise is structured as multiple, independent units, having multiple CICSplexes is probably the better approach; if it's structured as a single entity, the single-CICSplex solution is likely to be the more suitable.
- Does your decision conflict with your enterprise's plans, either for its business or its information systems? For example, if your enterprise currently operates as multiple, separate entities, are there plans to unify them at any stage?
- Is your proposed configuration as simple as it could be? For example, are you planning to define four CICSplexes when two would support your system management goals?

## Identifying system groups

- If you are planning multiple CICSplexes, have you considered whether CICS system groups could be used to achieve your goals? CICS system groups, unlike CICSplexes, are not mutually exclusive. This can be an advantage or a disadvantage, depending on your reasons for having multiple CICSplexes.

Finally, try to remember that you can alter your decision. Ideally, you would discover the best possible configuration at your first attempt. However, if you decide after a while that a different CICSplex configuration would be better, you can make the necessary changes.

Figure 5 on page 25 shows the number of CICSplexes required in the example enterprise.

## Identifying system groups

This section gives some suggested CICS system groups for the example configuration:

### CICSplex 1

- Group 1: TOR 1 and TOR 2
- Group 2: AOR 1 through AOR 5
- Group 3: FOR 1
- Group 4: All CICS systems on System A
- Group 5: All CICS systems on System B
- Group 6: All CICS systems on System C
- Group 7: Group 4 and Group 5
- Group 8: All CICS systems in CICSplex 1

### CICSplex 2

- Group 1: TOR 3
- Group 2: AOR 6 through AOR 9
- Group 3: All CICS for OS/2 systems
- Group 4: All CICS/VSE systems
- Group 5: All CICS systems on System E
- Group 6: All CICS systems on System G
- Group 7: Group 5 and Group 6
- Group 8: All CICS systems in CICSplex 2

Notice that Group 7 in both CICSplexes comprises other groups. Defining groups within groups is very efficient, both for you (because it means less effort) and for CICSplex SM.

Group 8 in both CICSplexes includes the same set of CICS systems as the CICSplex to which it belongs. This is often a useful group to define because the scope value (as specified for a monitor specification, for example) can be a CICS system or a CICS system group name only: it cannot be the name of a CICSplex.

This is merely an initial list of system groups. It is likely to be added to (or altered) when BAS, WLM, RTA, and monitoring requirements are identified.

You can identify one or more subsets of the CICS systems within a CICSplex as a CICS system group, which can be manipulated as a single entity and independently of the rest of CICSplex. For example, if you define a CICSplex made up of TOR, AOR, and FOR CICS systems, you might want to define the AORs as a CICS

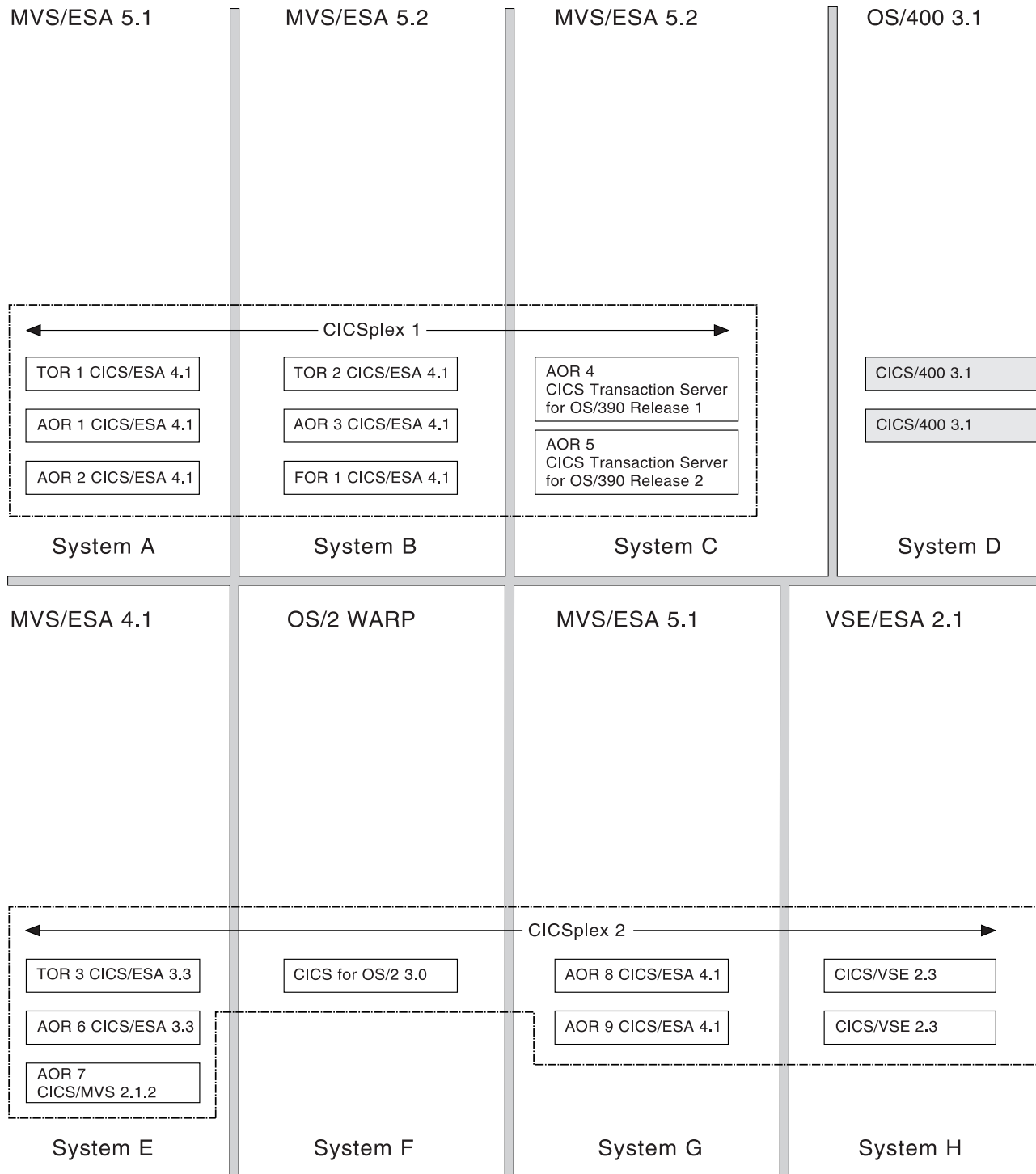

Figure 5. Identifying the CICSplexes. The example enterprise operates as two discrete units: the first three MVS images process a different workload from the remaining two, OS/2 WARP, and VSE/ESA, and there is no sharing of resources between those two groups. Accordingly, the enterprise CICS systems are to be divided between two CICSplexes. CICS systems that cannot be managed by CICSplex SM (the CICS/400 systems, in the example) have been shaded.

system group, so that you can use a single CICSplex SM command to make changes to, or request data from, all CICS systems in that category.

## where to install CMASs

Alternatively, you could define a single group for any of the following:

- Particularly heavily loaded CICS systems
- CICS systems that have different security requirements from the other CICS systems in the CICSplex
- CICS systems in which particular applications run

CICS system groups, unlike CICSplexes, do not have to be mutually exclusive: a CICS system can belong to any number of groups within a CICSplex. However, because the CICS system group is a subset of the CICSplex, a system group cannot cross CICSplex boundaries.

### Groups within groups

You can create CICS system groups from other groups. For example, if you want a single group to contain all AORs and all TORs in CICSplex, you can define its members as:

- The CICS system group comprising all AORs
- The CICS system group comprising all TORs

Any duplication of CICS system names that occurs in this way (for example, if a particular CICS system belongs to more than one constituent group) is accommodated by CICSplex SM. When a CICS system group is the target of a CICSplex SM command, CICS systems appearing in the group more than once are acted on once only.

---

## Locating CMASs

The CMAS is the component of the CICSplex SM topology that is responsible for most of the work involved in managing and reporting on systems and their resources. It is the CMAS that is responsible for presenting the SSI to the operator. Each CICSplex is managed by at least one CMAS. This section gives you guidance on deciding where to put CMASs and how many to have. The location of your CMASs determines whether your MASs are local or remote, and there are additional factors to be considered, as there are some restrictions on the functionality of remote MASs.

## Where to install CMASs

Now that you have decided which CICS systems are to be managed by CICSplex SM, and how they are to be organized into CICSplexes, you should think about where CMASs are required. The some rules and recommendations governing where a CMAS can, and must, be installed are:

- Each CICSplex must be managed by at least one CMAS.
- Each CICSplex must have a maintenance point CMAS.
- A CMAS can participate in the management of multiple CICSplexes.
- The CMAS, which is itself a CICS system, must be a CICS/ESA 4.1 (or later) system. If you are running CICS systems that are not directly-connectable to CICS Transaction Server for OS/390 Release 3, the CMAS must be CICS/ESA 3.3 and later, and appropriate to the level of CICSplex SM that you are running. See “CICS system connectivity” on page 2 and
- If you want CICSplex SM to issue SNA generic alerts to a NetView instance, or if you want CICSplex SM to populate the NetView RODM data cache with



status information for CICS resources, a CMAS must be installed on the same MVS image as the NetView instance.

- It's usual to have one CMAS on each MVS image on which managed CICS systems are running, so that as few CICS systems as possible have to be defined as remote MASs. See "Local or remote MASs" on page 32.
- You can have more than one production CMAS in an MVS image, but it is unlikely to be necessary.

You should also consider the performance implications of your decision. Each CMAS has its space requirements and its own data repository. If you plan to use the ISPF EUI on the image, you will need to install a CAS. For details of estimated space requirements of the CICSplex SM components, see Chapter 9, "Planning CICSplex SM installation and setup" on page 97. Be aware that, if you decide not to install a CMAS on an MVS image on which managed CICS systems are running, those CICS systems must be defined as remote MASs, and that the overheads associated with the management of remote MASs are slightly higher than those associated with local MASs.

If we apply these rules and recommendations to the example enterprise, you can see that:

- You must have at least one CMAS in the enterprise.
- You can't install a CMAS under VSE/ESA or OS/2, because CICS/ESA 4.1 (or later) cannot be installed in those environments.
- NetView is installed on System C; to send SNA alerts to that NetView instance, you must install a CMAS on the same MVS image.

Figure 6 on page 28 shows the example map updated again, this time to show the application of these CMAS rules and recommendations.

## CMAS-to-CMAS links

When a CICSplex crosses multiple MVS images, multiple CMASs are likely to be involved in managing that CICSplex. The CMASs must be connected to each other (using CICS intercommunication methods) so that data relating to the CICS systems belonging to the CICSplex is accessible by all relevant CMASs, and an SSI can be presented to the CICS operator. The minimum requirement is that CMASs managing the same CICSplexes be linked to form an open chain of CMASs, so that each CMAS is linked, if only indirectly, to every other CMAS. Meeting this requirement ensures that there is at least one path from each CMAS to every other CMAS involved in managing the same CICSplex. To achieve the best performance and availability, link every CMAS directly to every other CMAS.

Figure 7 on page 29 illustrates the concept of direct and indirect CMAS-to-CMAS links.

The links between multiple CMASs involved in managing the same CICSplex are responsible for the SSI of the CICS systems or systems that belong to that CICSplex. However, you do have a degree of choice regarding the *number* of links you define. First, here's a reminder of the rules and recommendations concerning CMAS-to-CMAS links:

- To establish an SSI of a CICSplex, the CMASs managing that CICSplex should at the very least be linked to form an open chain.

## CMAS-to-CMAS links

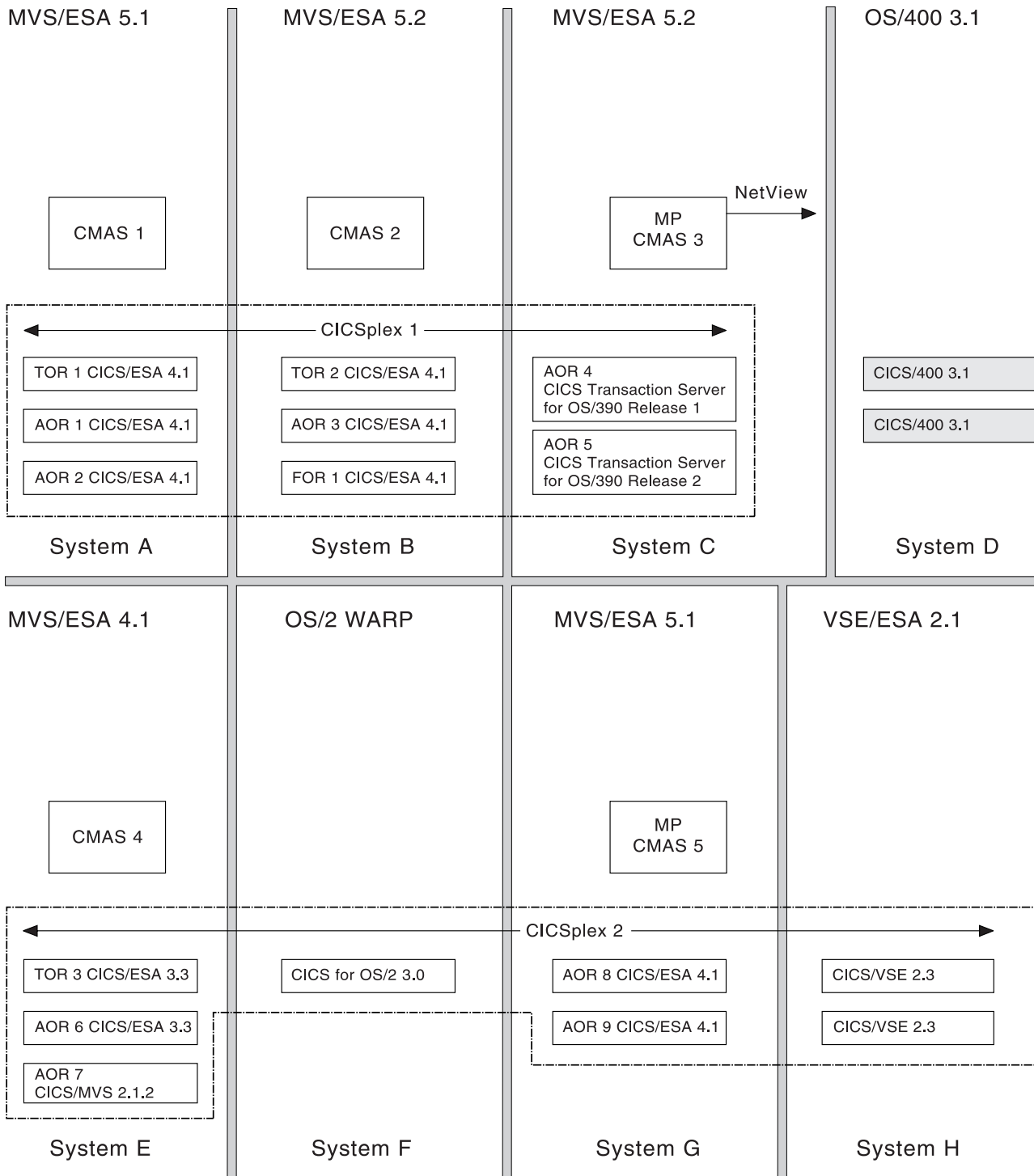

Figure 6. Adding CMASs to the enterprise map. A CMAS has been installed on each MVS image. CMAS 3 can issue SNA generic alerts to the NetView instance on the same MVS image. CMAS 3 is the maintenance point CMAS for CICSplex 1, and CMAS 5 is the maintenance point CMAS for CICSplex 2. (That is, CMAS 3 will be the context CMAS when you define CICSplex 1, and CMAS 5 will be the context CMAS when you define CICSplex 2 to CICSplex SM.)

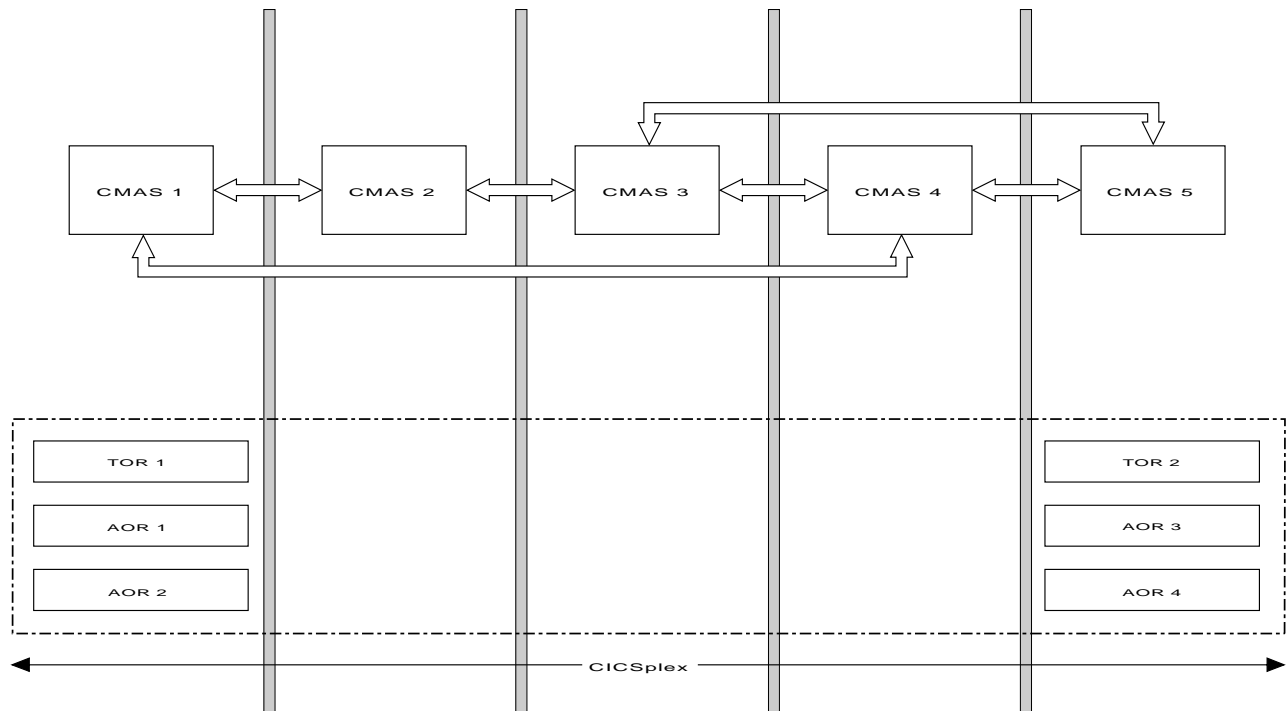

Figure 7. CMAS-to-CMAS links. This CICSplex is made up of six CICS systems, three managed by CMAS1 and three managed by CMAS5. In the absence of a direct link between the two CMASs, CICSplex SM is able to navigate dynamically around its “network” to gather information relevant to the CICSplex. It could go via CMAS4 or, if CMAS4 is unavailable, for example, it could go via CMAS2 and CMAS3. For optimum performance, however, a direct link should be added between CMAS1 and CMAS5.

- The more links you establish, the better the performance. The best performance is achieved when every CMAS is directly connected to every other CMAS involved in the management of a single CICSplex.
- A multiplicity of CMAS-to-CMAS links is also better for availability: if CMAS 1 is at the end of the chain and is connected to CMAS 2 only, the failure of CMAS 2 breaks the chain and leave no connection to CMAS 1.

In the example configuration, full CMAS-to-CMAS connectivity is established for each of the two CICSplexes. That is, for management of CICSplex 1, CMASs 1, 2, and 3 are directly connected to each other; for management of CICSplex 2, CMASs 4 and 5 are directly connected to each other. Thus, eight CMAS-to-CMAS links must be defined:

*CICSplex 1*  
 CMAS1 to CMAS2  
 CMAS1 to CMAS3  
 CMAS2 to CMAS1  
 CMAS2 to CMAS3  
 CMAS3 to CMAS2  
 CMAS3 to CMAS1

*CICSplex 2*  
 CMAS4 to CMAS5  
 CMAS5 to CMAS4

You could have decided not to link CMAS 1 to CMAS 3 directly. This arrangement would have met the minimum CMAS-to-CMAS link requirement (by leaving us with an open chain of CMASs) and would have reduced the number of links to be defined by two. Had you done so, information requested from System C about CICS resources on System A, for example, would be obtained indirectly (via the adjacent CMAS, CMAS 2) rather than directly. Wherever full connectivity is not

established among a group of CMASs, CICSplex SM works out the quickest route to the requested data dynamically.

The performance impact is slightly higher when information is obtained indirectly, but this needs to be set against the overhead of setting up and maintaining the CMAS-to-CMAS links. In fact, even if you had defined one CICSplex rather than two in your example, full connectivity among the CMASs would have been feasible. (That is, you would have needed 20 CMAS-to-CMAS links, because the number of links required is  $n^2 - n$ , where  $n$  is the number of CMASs to be connected.) However, if you had ten CMASs managing a single CICSplex, the number of links required would jump to 90; if you had 15 CMASs, the number would be 210. In summary, you have to decide how many direct links you are prepared to define, and where indirect links can be accommodated, always remembering that the minimum requirement is for an open chain of CMAS-to-CMAS links.

Figure 8 on page 31 shows the CMAS-to-CMAS links in the example configuration.

### CMAS-to-CMAS links for multiple CICSplexes

In our example, there are two CICSplexes. So that the CICSplex SM operator can access CICSplex 2 data from System B, for example, you could establish a link between any one (or more) of the CMASs involved in managing CICSplex 1 and any one (or more) of the CMASs involved in managing CICSplex 2. For example, you could establish a link from CMAS 1 to CMAS 5, thereby forming a chain of all of the enterprise CMASs.

Alternatively, data belonging to one CICSplex can be accessed from an MVS image on which a second CICSplex resides via CAS-to-CAS links. With the configuration you have chosen, CICSplex SM information about an AOR on System E, for example, requested from the CICSplex SM user interface on System A, can be obtained via CAS-to-CAS links rather than CMAS-to-CMAS links. CAS-to-CAS links are discussed in “CAS-to-CAS links” on page 33.

### Locating the maintenance point CMAS

When a single CICSplex is managed by multiple CMASs, one of them is designated the *maintenance point* CMAS. The maintenance point CMAS is responsible for maintaining all CICSplex SM definitions relating to a CICSplex, and for distributing up-to-date information to the other CMASs involved in managing the same CICSplex, so that no data repository is out of step with any other.

The maintenance point CMAS is the CMAS that is the *context* value when the CICSplex is defined to CICSplex SM. (The context is described on page 14.) Each CICSplex can have only one maintenance point CMAS, but a single CMAS can be the maintenance point for more than one CICSplex. If the maintenance point CMAS is unavailable at any time, changes to all CICSplex SM functions except BAS can be made at another CMAS managing the CICSplex. This CMAS becomes the *temporary maintenance point CMAS*. Any changes are temporary.

BAS does not support temporary maintenance point CMASs. The maintenance point CMAS must be available if you are creating or maintaining BAS definitions.

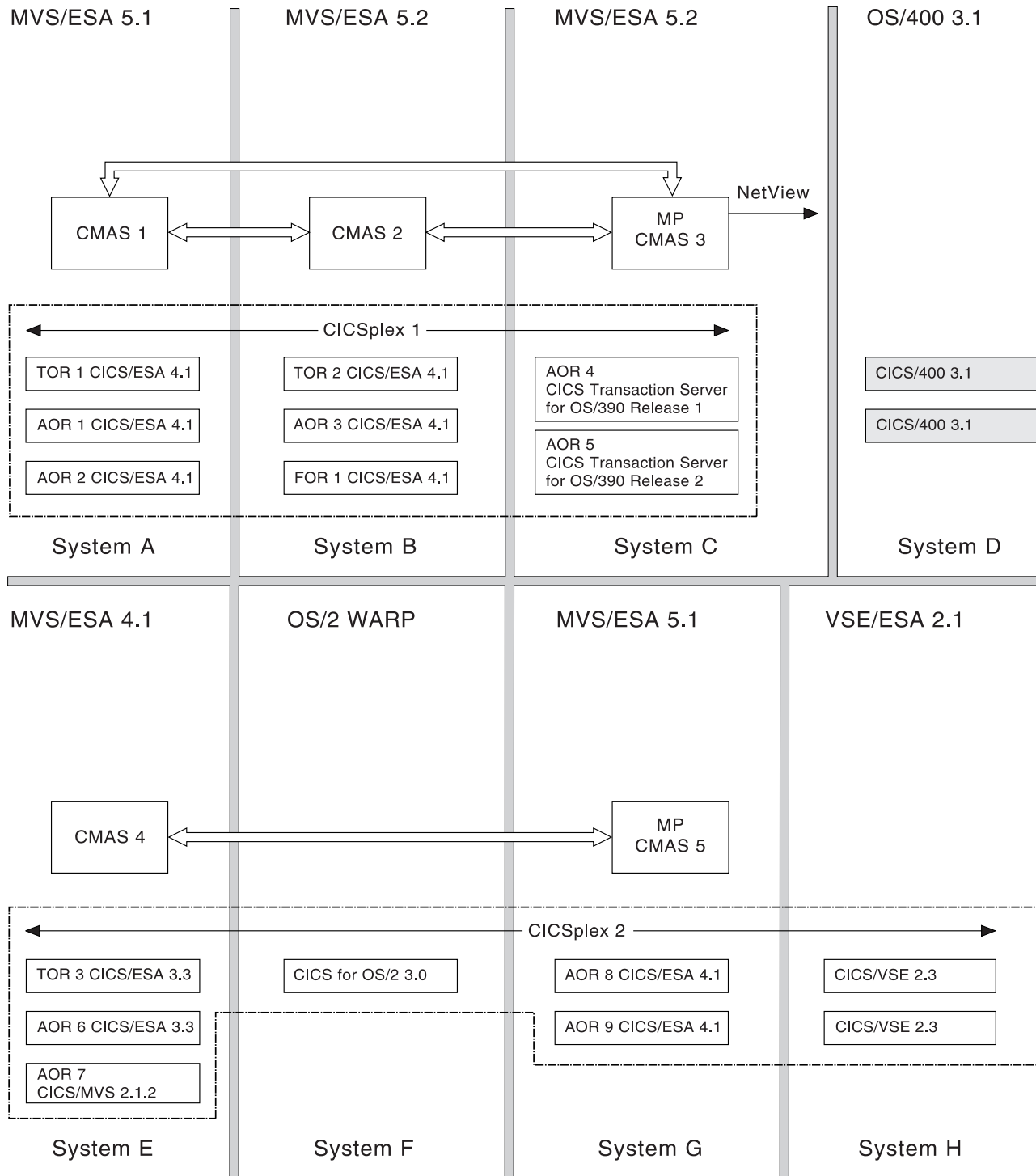

Figure 8. Adding CMAS-to-CMAS links to the example map. Eight links have been defined, giving full connectivity among CMASs managing the same CICSplexes.

## Local or remote MASs

A maintenance point CMAS can also function as a normal (not maintenance point) CMAS for other CICSplexes.

**Note:** CICSplex SM's single point of control means that changes to the maintenance point CMAS can be made from any system on which the CICSplex SM EUI is available.

## Local or remote MASs

There are some restrictions on remote MASs that you need to consider when deciding on the location of CMASs. In particular:

- You cannot obtain detailed CICS Monitoring Facility (CMF) data from a remote MAS.
- Remote MASs use operating-system storage rather than data spaces, which might reduce the storage available to you for user transactions.
- A remote MAS cannot be a routing region for CICSplex SM WLM.

In the example, to a large extent the MASs and remote MASs are already evident. You have identified which CICS systems are to be managed by CICSplex SM, and you have, in deciding where to install CMASs, identified which CICS systems are to be local MASs and which are to be remote MASs. In the example, the remote MASs are those running under VSE/ESA and OS/2, where no CMAS can be installed. You should perhaps consider whether you want to define any CICS system that is running on an MVS image on which a CMAS is to be installed as a remote MAS. You might decide to do this if you want to be able to move the CICS system between MVS images, some of which have a CMAS and some of which do not, for example.

An explicit link must be established from a CMAS to each remote MAS. (A link must also be established from each remote MAS to its CMAS, but in this case the link is not a CICSplex SM entity. Rather, the link is established by the addition of connection and session definitions to the CSD.) Select a CMAS that is participating in the management of the CICSplex to which the remote MASs belong, and mark the link on your map. Each MAS can attach to only one CMAS per execution. For a local MAS, this is usually the CMAS on the same image as the MAS. For a remote MAS, this is the CMAS from which an explicit link has been established to the remote MAS.

---

## Locating CASs

Once you have decided where to install CMASs and how to link them, you can turn your attention to the CASs.

## Where CASs are required

The rules and recommendations on where to locate a CAS are:

- To set up the CICSplex SM component infrastructure, you need a CAS on one of your MVS images. This CAS can be used to support the MVS/TSO ISPF user interface used to set up CICSplex SM.
- There must be one CAS on each MVS image from which you plan to use the MVS/TSO ISPF user interface to CICSplex SM. You cannot access CICSplex SM data *directly* from an MVS image that doesn't have a CAS. For example, CICSplex SM data cannot be accessed from the System B shown in Figure 9, because the image does not have an MVS/TSO ISPF EUI, even

though managed CICS systems (the remote MASs) are running there. This does not mean that the CICSplex SM data cannot be accessed at all, but that it must be accessed from other MVS images.

- You can install a CAS on an MVS image on which there is no CMAS. Provided that the MVS image has the required level of ISPF installed, it can be used as an access point for CICSplex SM data on other MVS images.
- If a CMAS only participates in management of MASs in the CICSplex, and you do not want to set its name as a context (for example, if it is a maintenance point), you do not need a CAS on the same MVS image.
- Although the CAS supports the MVS/TSO ISPF EUI, TSO itself doesn't have to be available on every MVS image on which you have a CAS. The absence of MVS/TSO from a particular image simply means that the user cannot access CICSplex SM data from that image. It can, however, be accessed from other images. Figure 9 illustrates three valid CAS scenarios.

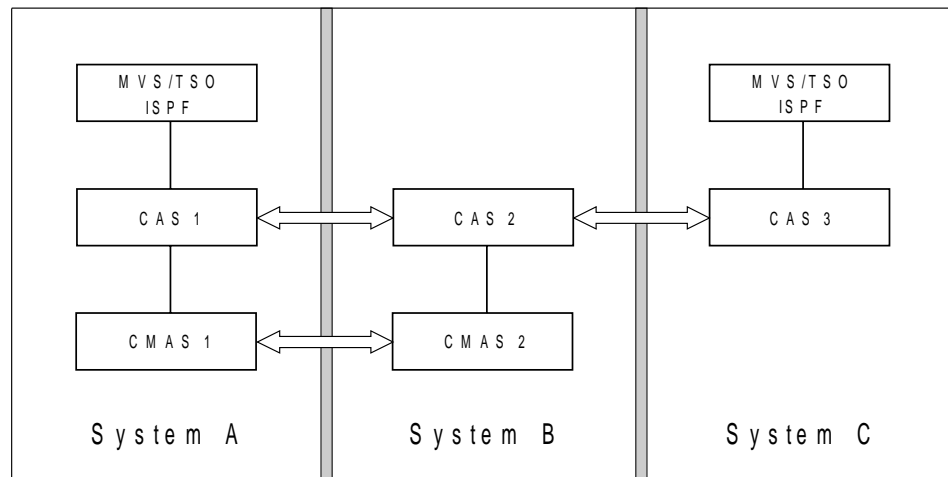

Figure 9. Valid CAS configurations. The most likely configuration is that shown on System A. However, those shown on System B and System C are also valid. CICSplex SM data cannot be accessed from System B because there is no MVS/TSO instance. However, because CAS2 has links to other CASs on MVS images where MVS/TSO is available, the data on System B is accessible from other MVS images. System C has no CMAS, but can still be used as an access point for CICSplex SM data on other MVS images.

It's very easy to update the example map by applying these rules: there are five CMASs, so there must be five CASs, one on each of the MVS images on which a CMAS is installed. Figure 10 on page 34 shows the addition of the CASs, and also of the CMAS-to-remote-MAS links.

## CAS-to-CAS links

If you define no CAS-to-CAS links, the CICSplex SM operator can sign on to CICSplex SM via CAS 1 (or CAS 2, or CAS 3) and still have a complete view of the CICS systems and resources in CICSplex 1 because the CMASs managing CICSplex 1 are linked to each other. The same observation is true of CICSplex 2. For example, a CICSplex SM operator accessing CICSplex SM via CAS 5 can see data for TOR 3 via the links between CMAS 4 and CMAS 5. However, for both performance and availability reasons, it is better to establish links between CASs also.

## local or remote MASs

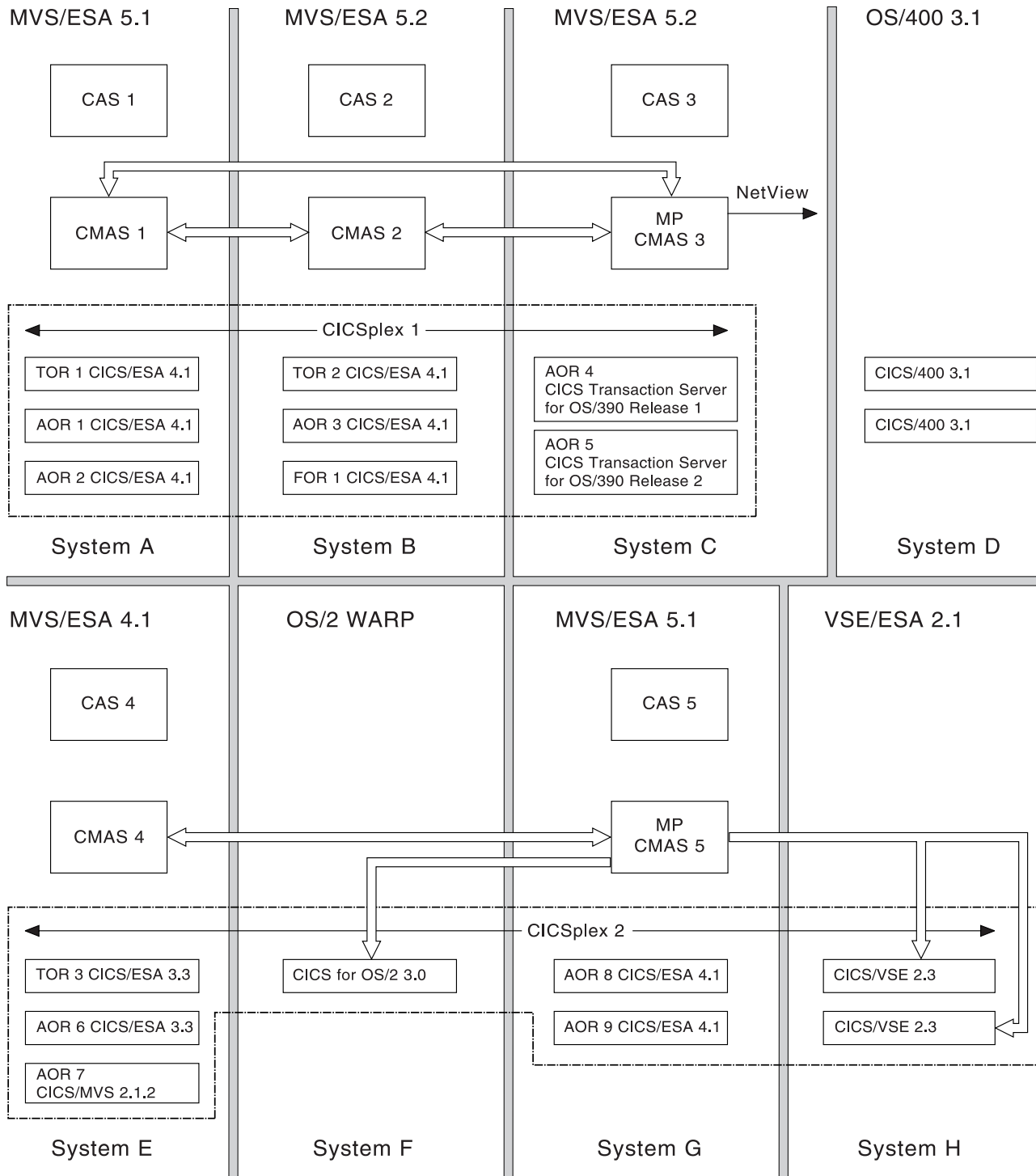

Figure 10. Adding CASs to the example map. A CAS has been added to every MVS image to which a CMAS has been assigned. Also, links from CMAS 5 to the remote MASs running under OS/2 WARP and VSE/ESA have been identified.



A second consideration in the example is the availability of a single point of control for the enterprise. If you add no CAS-to-CAS links, a CICSplex SM operator cannot see CICSplex SM data for CICSplex 2 from MVS image 3, for example. This arrangement might be suitable in some enterprises (indeed, it might be the reason why it was decided to have multiple CICSplexes in the first place). However, if you do want a single point of control for the enterprise and have multiple CICSplexes, CAS-to-CAS links are required.

Thus, CAS-to-CAS links can provide a single point of control for the enterprise by allowing the CICSplex SM operator access to CMASs that may not be even indirectly connected to each other; CMAS-to-CMAS links provide an SSI for all MASs that connect to those CMASs; and CICSplex SM exploits a combination of CAS-to-CAS links and CMAS-to-CMAS links to give the best possible performance.

In the example, few CAS-to-CAS links are essential. If you add two links, one from CAS 1 to CAS 4, and one from CAS 4 to CAS 1, both CAS 1 and CAS 4 can function as a single point of control because each has access to data about CICSplexes 1 and 2. However, for maximum performance and availability, and because the total number of CASs in the enterprise is small, you are going to link every CAS to every other CAS. As with the CMAS-to-CMAS links, the formula for calculating the number of links to be defined is  $n^2 - n$ , where  $n$  is the number of CASs. In the example, there are five CASs, and so 20 links must be defined to establish full connectivity for the enterprise. If you have room on your map, add the CAS-to-CAS links. As the example map is beginning to look crowded, the CAS-to-CAS links are listed separately in Table 2.

*Table 2. CAS-to-CAS links required for full connectivity among the example CASs*

CAS 1 to:	CAS 2 to:	CAS 3 to:	CAS 4 to:	CAS 5 to:
CAS2	CAS1	CAS1	CAS1	CAS1
CAS3	CAS3	CAS2	CAS2	CAS2
CAS4	CAS4	CAS4	CAS3	CAS3
CAS5	CAS5	CAS5	CAS5	CAS4

Full connectivity among the enterprise CASs is recommended for performance and availability reasons. However, it is not essential: if the enterprise CMASs are adequately connected to each other, a single point of control for the enterprise can be established without full connectivity among the CASs.

---

## Naming your CICSplex SM entities

All the entities that you have defined in this chapter, and entered on to your CICSplex SM map, have to be named. You must devise a convention for naming those entities that is both meaningful and extendable. CICSplex SM supports the use of generic names in many of its commands. For example, you can specify that all transactions whose names begin with the letters “DNW” are to be monitored once every 300 seconds. You do not have to name each transaction individually.

The rules governing use of generic names are as follows:

- The asterisk character (\*) can be used in place of one or more characters. It can appear once only in any name, and must appear at the end of any partial

## updating the initial design

string. For example, the string “DNW\*” means all names beginning with the letters DNW.

- The plus sign (+) can replace any single character and can occur in any position in the name. For example, “DNW+++L” means any name of 7 characters starting with the letters DNW and ending with the letter L.

---

## A staged implementation

If you have a very large number of CICS systems, or if you have decided to create multiple CICSplexes, you might want to consider implementing CICSplex SM in stages. You can install CICSplex SM on a subset of your systems and use it to manage a single CICSplex or, if you have defined a single CICSplex for the enterprise, you can use it to manage particular system groups. Additional CICS systems can be added to the configuration gradually.

If you opt for the gradual approach, you will need to revisit your final map of the enterprise CICS systems and identify those you plan to start with. For example, if a staged implementation were adopted for your example map, you could decide to begin by implementing CICSplex 2 only. The CAS-to-CAS links and the CMAS-to-CMAS links would be much reduced in number (two CAS-to-CAS links rather than 20, and two CMAS-to-CMAS links, rather than 12), but the other decisions made about CICSplex 2 are still valid. That is, the same CICS system groups can be defined, and the CAS and CMAS installations are still required.

---

## Updating the initial design

When you have been working with your initial CICSplex SM configuration for a while, it's possible that you will want to do some fine-tuning. For example, it might become apparent that you need some additional CMAS-to-CMAS links, or some extra CICS system group definitions. You will also need to make changes as more CICS systems or regions are created, or if you implement the initial configuration in stages. Whatever the reason for updating the initial design, you are recommended to keep the map of the CICS systems in your enterprise up-to-date, because an accurate map will make it easy for you to maintain the CICSplex SM configuration and topology data.

---

## Where next?

Now that you have a map of your enterprise, you can start the planning for the installation of CICSplex SM and the creation of your proposed configuration. See Chapter 9, “Planning CICSplex SM installation and setup” on page 97 for guidance on planning for the installation of CICSplex SM.

---

## Chapter 4. Defining the CICSplex SM configuration and topology

Once CICSplex SM has been installed, and you have a map of your CICSplex SM environment, you can define the configuration and topology. This chapter covers:

- “Defining your CICSplex SM configuration”
- “Defining CICSplex topology” on page 38
- “Where next?” on page 42.

---

### Defining your CICSplex SM configuration

For your CICSplex SM configuration, you need to define:

- CAS-to-CAS links
- The CMAS configuration

### Defining CAS-to-CAS links

CAS-to-CAS links are defined using the PlexManager service utility. You can use PlexManager also to determine the status of the connections between a CAS and its associated CICSplex SM address spaces (CMASs) and CICSplexes, and to manage the connections between CASs.

Defining CAS-to-CAS links is one step in the process of installing a CAS, which forms part of the setup procedure. This is described in detail in *CICSplex SM Administration*.

### Managing your CAS environment

You can use the following PlexManager views to manage your CAS environment:

<b>CASACT</b>	Manage the activity of your VTAM cross-system communication links.
<b>CASDEF</b>	Create and maintain CAS cross-system communication definitions.
<b>CASDEFD</b>	Display information about a specific CAS definition.
<b>PLEX</b>	Display a list of the available combinations of product and context (or <i>service points</i> ) in one or more systems known to the CAS to which you are currently connected.
<b>PLEXOVER</b>	Display a list, by context, of the available service points known to the CAS to which you are currently connected.
<b>SCREENS</b>	Display a list of user-created screen configurations.

### Defining the CMAS configuration

For each CMAS you have defined, you must provide the following information to CICSplex SM:

- The name of each CICSplex that it is to manage, if it is a maintenance-point CMAS
- Link definitions for each CMAS to which it is connected
- Link definitions for each remote MAS that it is to manage

## defining CICSplex topology

To enter this information, you can use the appropriate CMAS Configuration Administration (ADMCONFIG) views, or the batched repository-update facility.

### Managing the CMAS configuration

You use the following views to manage your CMAS configuration:

- BATCHREP** To create, update, remove, list, or dump one or more definitions from the data repository associated with the local CMAS.
- CMTCMDEF** To display information about the direct LU6.2 and MRO communication links between the local CMAS and any other CMASs.
- CMTPMDEF** To create a CMAS-to-remote MAS link definition for a remote MAS linked to the local CMAS.
- CPLEXDEF** To define a CICSplex to the local CMAS and to administer CICSplex definitions for the local CMAS.
- CPLXCMAS** To administer information about CMASs associated with a CICSplex, where the local CMAS is the maintenance point for that CICSplex.

CICSplex SM also provides the following views that you can use to manage CMAS configuration definitions when the associated CMASs are active.

- CICSPLEX** To display information about the CMASs associated with a CICSplex known to the local CMAS.
- CMAS** To display information about CMASs known to the local CMAS, shut down a CMAS, and alter CMAS component trace settings.
- CMASD** To display information about a specific CMAS known to the local CMAS, shut down a CMAS, and alter CMAS component trace settings.
- CMASPLEX** To display information about the CICSplexes being managed by the local CMAS.
- CMTMMLNK** To display information about all or specific CMASs linked to the local CMAS and to discard a CMAS-to-CMAS link.
- CMTMLND** To display information about the link between a specific CMAS and the local CMAS and to discard the CMAS-to-CMAS link.
- CMTMMLNK** To display information about all or specific MASs linked to the local CMAS and to discard the CMAS-to-MAS link.
- CMTMMLND** To display information about a specific MAS linked to the local CMAS and to discard the CMAS-to-MAS link.

See *CICSplex SM Administration* for details of all these views.

---

## Defining CICSplex topology

When you have identified your CICSplexes and MASs, you need to create the definition objects that will identify them to CICSplex SM. You should be aware that you will not have all the information required at this point; more information will emerge as the design of your CICSplex SM system proceeds.

More information about designing CICSplexes is given in “Designing your CICSplexes” on page 19

## Preparing CICSplex definitions

Each CICSplex must be defined to CICSplex SM by a name that is unique within the enterprise. Naming conventions are given in “Naming your CICSplex SM entities” on page 35. You also should be aware that you will need other information for the CICSplex definition, which will become available as you proceed with the design of your CICSplex SM system. This information includes:

- The name of the CMAS to which the CICSplex is to be defined. (This is the maintenance point CMAS for the CICSplex.)
- The names of any other CMASs that are to participate in management of the CICSplex.
- A time zone for the CICSplex SM monitor function.
- Whether CICS command checking is to be simulated.
- Whether CICS resource checking is to be simulated.

### Managing the CICSplex definitions

A CICSplex is identified to CICSplex SM via the CPLEXDEF view, which is described in *CICSplex SM Administration*.

To enter this information, you can use the appropriate CMAS Configuration Administration (ADMCONFIG) views, or the batched repository-update facility.

When you have created a CICSplex definition, you can associate CICS systems (MASs) and CICS system groups with the CICSplex. See “Preparing CICS system definitions.”

## Preparing CICS system definitions

In order to be managed by CICSplex SM, a CICS system must be associated with a CICSplex that is defined to CICSplex SM. The definition establishing this association also contains information about how the CICS system is to use the BAS, WLM, RTA, and monitoring components of CICSplex SM.

To create CICS system definitions, and to display information about CICS systems defined to a CICSplex, you use the CICSSYS view.

For every CICS system that is to be managed by CICSplex SM, you must gather the following information:

- The name by which this system is to be known to CICSplex SM
- The name of the CICSplex to which the CICS system is to belong
- The APPLID, that is, the VTAM application identifier for the CICS system
- The SYSID, that is, the CICS system identifier

This is sufficient data for adding the MAS definition to the CICSplex SM data repository. If you know that you have special BAS, WLM, RTA, or monitoring requirements for any CICS system, you can enter those at the same time. Alternatively, you can update the CICS system definition later as new requirements become apparent. For example, you might want to collect some of the following

## CICS system link definitions

information, which is optional and can be supplied after the CICS system is defined to CICSplex SM:

- If system availability monitoring (SAM) is to be implemented, the name of the primary CMAS, which is the CMAS to which the CICS system usually connects, and the hours of operation of the CICS system
- Whether CICS command checking is to be simulated
- Whether CICS resource checking is to be simulated
- The time zone of the CICS system, if it is not to be the same as that of its CMAS

To enter this information, you can use the Topology Administration (ADMTOPOL) views, or the batched repository-update facility. Note that the ADMTOPOL views are also used to create time-period definitions.

### Preparing CICS system group definitions

For each CICS system group to be defined to CICSplex SM, you need provide only a name for the group, which may be unique within the CICSplex. The CICS system group must be defined before you can add CICS systems to it. To define a CICS system group, you use the ADMTOPOL views.

Defining CICS system groups, perhaps more than any other part of the design stage, is an iterative process and a cumulative one. It might be obvious to you already that there are natural groupings of CICS systems within your CICSplexes, and that you will want to manipulate each of those groups as a single entity. If this is the case, start to document the groups now. Because groups do not have to be mutually exclusive, and because a CICS system can belong to any number of groups, you can add CICS system group definitions as new requirements emerge.

To create CICS system groups, you use the CICSGRP view.

You can display information about the CICS system groups, and the CICS systems associated with them, that are known to the CICSplex identified as the current context, by using the SYSGRPC view.

### CICS system link definitions

For a CICS system to communicate with another CICS system, the connection between the two systems may be specified by a *link definition*. A link definition is used to automatically create the matching CICS resource definitions (connection and session definitions) required in the two connected CICS systems. These link definitions are used by CICS (not CICSplex SM); for example, for transaction routing between CICS systems.

To create CICS system link definitions, and to display information about those definitions, you use the SYSLINK view.

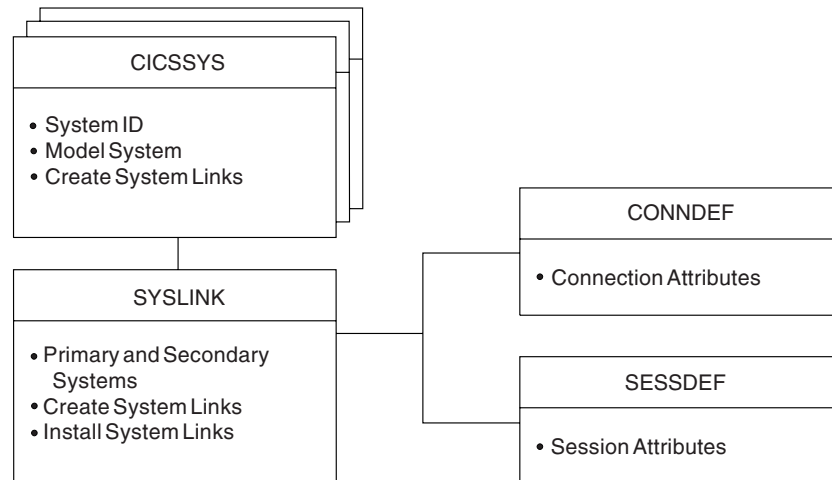

Figure 11. CICS system link definitions

## Managing CICS system definitions

CICS system definitions are managed through the following objects:

<b>CICSGRP</b>	To create and administer CICS system groups within a CICSplex, including adding CICS systems to CICS system groups. This view is described in <i>CICSplex SM Administration</i> .
<b>CONNDEF</b>	To create and administer connection definitions that identify remote systems that a CICS system communicates with using intersystem communication (ISC) or multiple region operation (MRO). This view is described in <i>CICSplex SM Managing Business Applications</i> .
<b>CICSSYS</b>	To create and administer the definition that associates a CICS system with a CICSplex. The definition also contains information about how the CICS system is to use the WLM, real-time analysis, resource monitoring, and business application services components of CICSplex SM. This view is described in <i>CICSplex SM Administration</i> .
<b>PERIODEF</b>	To create and administer time period definitions, which identify specific ranges of hours and minutes to be used with resource monitoring and real-time analysis. This view is described in <i>CICSplex SM Administration</i> .
<b>SESSDEF</b>	To create and administer session definitions that describe the nature of logical links between systems that communicate using intersystem communication (ISC) or multiple region operation (MRO). This view is described in <i>CICSplex SM Managing Business Applications</i> .
<b>SYSGRPC</b>	To monitor information about the CICS system groups, and the CICS systems associated with a CICSplex. This view is described in <i>CICSplex SM Administration</i> .
<b>SYSLINK</b>	To create and administer the links between CICS systems in the CICSplex. This view is described in <i>CICSplex SM Administration</i> .

## where next?

CICSplex SM provides the MAS view that you can use to manage configuration definitions when the associated CICS systems are active.

**MAS** To manage information about active CICS systems known to a CICSplex or connected to the designated CMAS involved in managing the CICSplex.

- Display information about the active CICS systems
- Browse or temporarily update the general, WLM, real-time analysis, resource monitoring, and MAS trace attributes of an active CICS system.
- Stop MAS agent code in an active CICS system.

This view is described in *CICSplex SM Administration*.

**Note:** Using the CICSSYS and PERIODEF views to update definitions affects both a currently running system and the definitions in the data repository. Updates made using the MAS view, however, are not included in the data repository.

---

## Where next?

You have a working CICSplex SM environment, with your configuration and topology defined, and with the links between the entities defined. The entities can communicate with each other and you can run transactions. However, to optimize the operation of your enterprise and to take full advantage of the facilities offered by CICSplex SM, you need to set up your BAS, WLM, RTA, and monitoring requirements. For guidance, go to Chapter 5, “Managing resources using Business Application Services (BAS)” on page 43, Chapter 6, “Managing workloads” on page 59, Chapter 7, “Exception reporting using real-time analysis (RTA)” on page 75, or Chapter 8, “Collecting statistics using CICSplex SM monitoring” on page 87, as appropriate.



---

## Chapter 5. Managing resources using Business Application Services (BAS)

This chapter covers:

- “What is Business Application Services (BAS)?”
- “Managing BAS” on page 48
- “Migrating your resource definitions” on page 51
- “Defining resources” on page 52
- “Using migration form BAS” on page 53
- “Using full-function form BAS” on page 54
- “Installing applications and resources” on page 55
- “Security considerations” on page 56
- “Planning for BAS” on page 56
- “Implementing BAS” on page 57
- “Where next?” on page 58

---

### What is Business Application Services (BAS)?

Business Application Services (BAS) is an alternative to resource definition online (RDO) that enables you to manage CICS resources in terms of the business application to which they belong, rather than their physical location in the CICSplex. A business application can be any set of resources that represent a meaningful entity in your enterprise. Within the application, you can group together resources of a particular type and define the run-time characteristics of that group. At run-time, you can refine the selection of resources to be installed by using a filter expression, and you can change the resource attributes by using an override expression.

### Limitations of RDO

RDO is the traditional CICS method of defining resources to CICS systems. With RDO, resource definitions are tied to a single group and groups that are processed sequentially from a group list. Any duplicate definition found later in the process overrides any earlier one. In addition, the very nature of the definitions that RDO requires and the extent to which they are available to multiple CICS systems can prove limiting. RDO has several disadvantages in a CICSplex SM environment:

- Resources are assigned to groups that are assigned to specified CICS systems.
- Resource definitions have to be duplicated across CICS systems, unless the CSD is shared.
- Each end of every communications link has to be defined explicitly.

### BAS concepts

BAS enables you to view and manage your resources in terms of their use in your business, and independently of their physical location. This section introduces the basic concepts of the BAS function.

### Logical scoping

Once your CICS resources are defined to CICSplex SM, you can monitor and control resources in terms of their participation in a named business application, rather than their physical location in the CICSplex. Logically-related resources can be identified and referred to as a set, regardless of where they actually reside at any given time.

Sets of definitions can be reused and associated with any number of other logical associations of resources that reflect your business needs, rather than your system configuration.

If you set the scope to be your application, any operation or monitoring views will display only those resources that satisfy your selection criteria. This gives you the power to control precisely how those resources are managed.

### Multiple versions of a resource definition

With BAS, you can have multiple versions of the same resource. Each time you create a new definition for the same resource and the same name, BAS allocates a new version number. Note that a new version number is not created if you update the resource. You can specify a specific version of a resource definition by its version number.

Version support allows you to develop resource definitions as your business applications develop. You can then have, for example, a single version of a resource in multiple groups, or multiple versions of the resource throughout the CICSplex. Note that you can install only one version of a resource in a CICS system at one time.

### Centralized resource definition

RDO definitions are held in a CICS System Definition (CSD) file. BAS resources are held on a central data repository that is accessed by all the CICS systems in the CICSplex.

The CICSplex SM data repository (EYUDREP) serves as the central repository for all your CICS resource definitions. This minimizes the number of resource definitions you need for your CICSplex by:

- Providing a single system image approach to defining CICS resources across all supported platforms.
- Producing both local and remote instances of a resource from a single definition.
- Managing multiple versions of a definition. For example, you can have different versions of the resources for an application as it progresses through a number of test phases.
- Generating multiple CICS communication links from a single set of connection and session definitions.

## CICS system links

The traditional method of defining links between CICS systems is to use RDO to define connections and sessions between each CICS system. For each pair of CICS systems, there are four definitions: two connections and two sessions. Each connection and session is unique for a given pair of CICS systems.

With BAS, communications links are created dynamically from model connection and session resource definitions. You define connections and sessions that describe the nature of the link. The BAS system link (SYSLINK) object is used to create the link between two CICS systems, by specifying the connection and session definitions to be used. The connection and session definitions can be used by any number of system link definitions that share the same characteristics. See “Defining CAS-to-CAS links” on page 37 and *CICSplex SM Administration*.

## Distributed resource installation

Resources that are defined to CICSplex SM must still be installed in the appropriate systems, either by CICS or by CICSplex SM. For systems running CICS/ESA 4.1 and later, you can use BAS to install your resources either automatically, at CICS initialization, or dynamically, while a system is running. A single resource can be installed in multiple CICS systems either locally or remotely, as appropriate.

## Two forms of BAS

You can use BAS in two ways:

- Migration form, in which resource groups are associated with resource description. In this form, resource descriptions are similar to group lists. See Figure 12 on page 46 and “Using migration form BAS” on page 53.
- Full-function form, in which resource assignments are used to qualify the contents of resource groups and resource descriptions, and to control the assignment of resources to CICS systems. See Figure 13 on page 47 and “Using full-function form BAS” on page 54.

You can use either or both of these forms, depending on the situation and degree of precision you require.

The simplest form is the migration form using resource descriptions. You create resource definitions and resource groups, and associate them with one or more resource descriptions. It is the resource description that defines the logical scope for the resources. The resources are assigned to specific CICS systems and you therefore still need separate definitions for a resource that is local to one system and remote to another. This approach to BAS is similar to using RDO, in that the resource description is analogous to the group list. You in effect create a version of your CSD on the CICSplex SM data repository. Though this is a good position from which to establish your CICSplex SM resources environment, you cannot take advantage of all the facilities offered by BAS.

To take advantage of the facilities offered by BAS to manage your resources in terms of the business application rather than location, you need to use resource assignments. A resource assignment selects resources of a particular type from a group, and assigns them to the appropriate CICS system. A resource assignment is associated with a resource description. The resource description then no longer

## business application services

functions like a group list, but becomes a user-defined, logical set of resources, such as an application.

Using resource assignments allows you to manage your individual resources and change their attributes for individual systems, or to suit special circumstances. You can:

- Control resources of a given type in a given group.
- Identify resources as either local or remote, and assign them to various CICS systems with a single resource definition.
- Process selected resources from a group by specifying a filter expression.
- Modify resource attributes for a particular use by specifying override expressions.

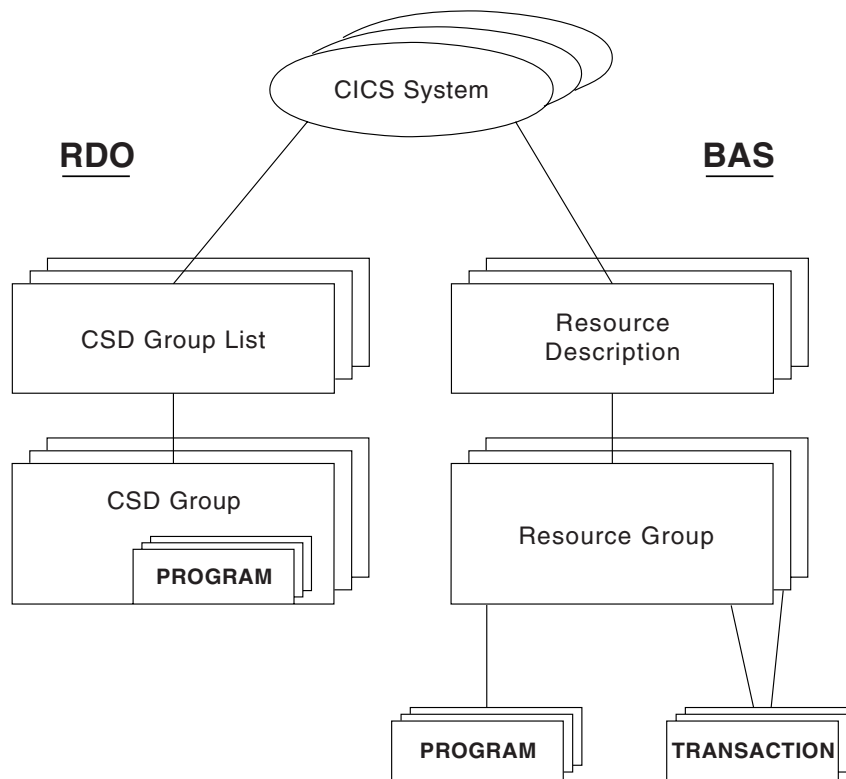

Figure 12. Migration from BAS

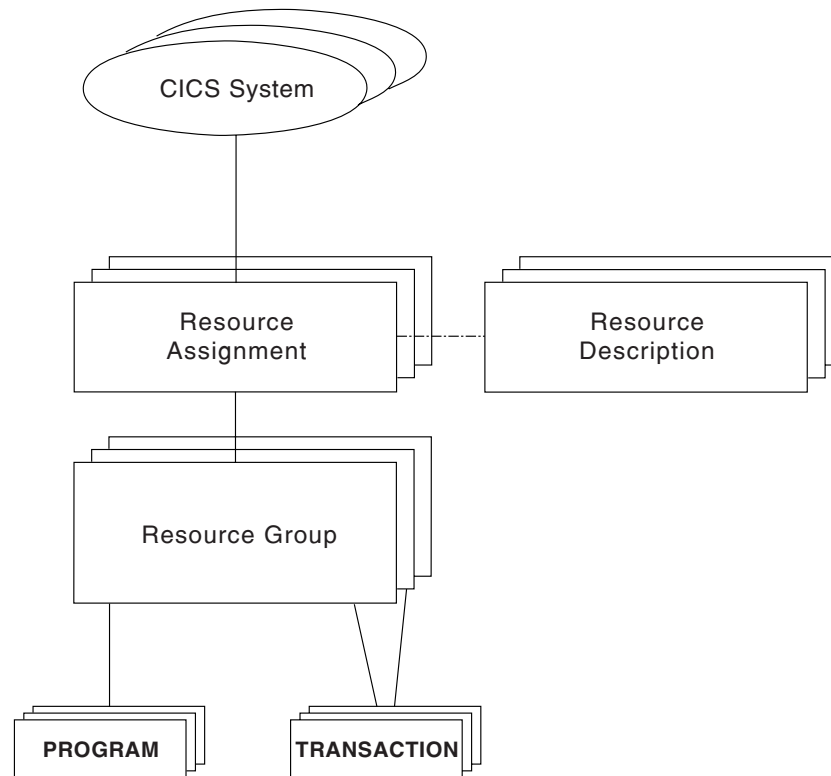

Figure 13. Full-function BAS

## Advantages of using BAS

The BAS approach to the management of resources offers several advantages over RDO:

- A familiar, RDO-like definition process with a choice of interfaces (ISPF, batch or API).
- Logical scoping, that allows you to handle your resources in terms of business application rather than location.
- A common definition repository for all resources in a CICSplex, across all supported CICS platforms.
- A reduction in the number of definitions required, with the ability to reuse definitions and override individual attributes as needed.
- Consistent resource definitions and a great deal of control over the definition process.
- A resource can be added to additional regions simply by adding it to the groups that defines where the application will run.
- Because the application is known to CICSplex SM, commands can be directed to a scope that matches the application, not to an arbitrary group of regions.

## Managing BAS

Your BAS environment is set up and managed using the objects described in Table 3.

Table 3 (Page 1 of 2). Resource administration objects

Object name	Description	Function
RASGNDEF	Resource assignments	<p>A resource assignment describes the characteristics of the selected resource definition type, and how those resources are to be assigned to CICS systems. The assigned resources must all be of one type, for example, files, and must belong to a resource group. A resource can be assigned as both local and remote in one or more CICS systems. Before you can use the resource assignment, you must associate with a resource description; see the REDESC object.</p> <p>This object is also used to identify the attributes to be used in selecting the resources to be assigned and any attribute values to be changed when the resources are assigned.</p>
RASINDSC	Resource assignments in resource description	This view displays information about resource descriptions, and the resource assignments associated with them. This information includes, for each resource, its resource group and any assigned CICS system to CICS system group.
RASPROC	Resource assignment process	This view displays the resources that will be processed when the specified resource assignment is processed. The resources displayed are selected from those in the associated resource group, using any supplied selection criteria.
RDSCPROC	Resource description process	This view displays the resources that will be selected when a specified resource description is processed. The resources can be selected from resource groups that are directly related to the resource description, as in migration form BAS, and from resource assignments, using any selection criteria currently in effect.
REDESC	Resource descriptions	A resource description identifies a set of resource groups, and hence resource definitions. You use this object to specify whether or not you want to use logical scoping for this resource description, and the CICS systems for the associated resource groups.
RESGROUP	Resource groups	This object is used to associate one or more related resource definitions. The resource definitions may be of the same or different types.
RESINDSC	Resource groups in description	This view displays information about existing resource descriptions and the resource groups associated with them.
RESINGRP	Resource definitions in resource group	This view displays information about existing resource groups and the resource definitions associated with them.

<i>Table 3 (Page 2 of 2). Resource administration objects</i>		
<b>Object name</b>	<b>Description</b>	<b>Function</b>
SYSLINK	System links	This view displays information about the links that exist between CICS systems in the CICSplex. The information includes the names of the CICS systems and the names of the connection and session definitions used in defining the link.
SYSRES	CICS system resources	This view displays the resources that will be assigned to a specified CICS system. The resources are selected on the basis of the resource descriptions currently associated with the CICS system.
<i>resDEF</i>	Resource definition	For each resource definition type, there is a resource definition object that defines the attributes for that definition. The available resource types for CICSplex SM are: CONNDEF, DB2CDEF, DB2EDEF, DB2TDEF, DOCDEF, ENQMDEF, FENODDEF, FEPODEF, FEPRODEF, FETRGDEF, FILEDEF, FSEGDEF, JRNLDEF, JRNMDEF, LSRDEF, MAPDEF, PARTDEF, PROCDEF, PROFDEF, PROGDEF, PRTNDEF, RQMDEF, SESSDEF, TCPDEF, TDQDEF, TERMDEF, TRANDEF, TRNCLDEF, TSMDEF, TYPTMDEF

The object models showing the relationships between these objects are shown in Figure 14 on page 50 and Figure 15 on page 51.

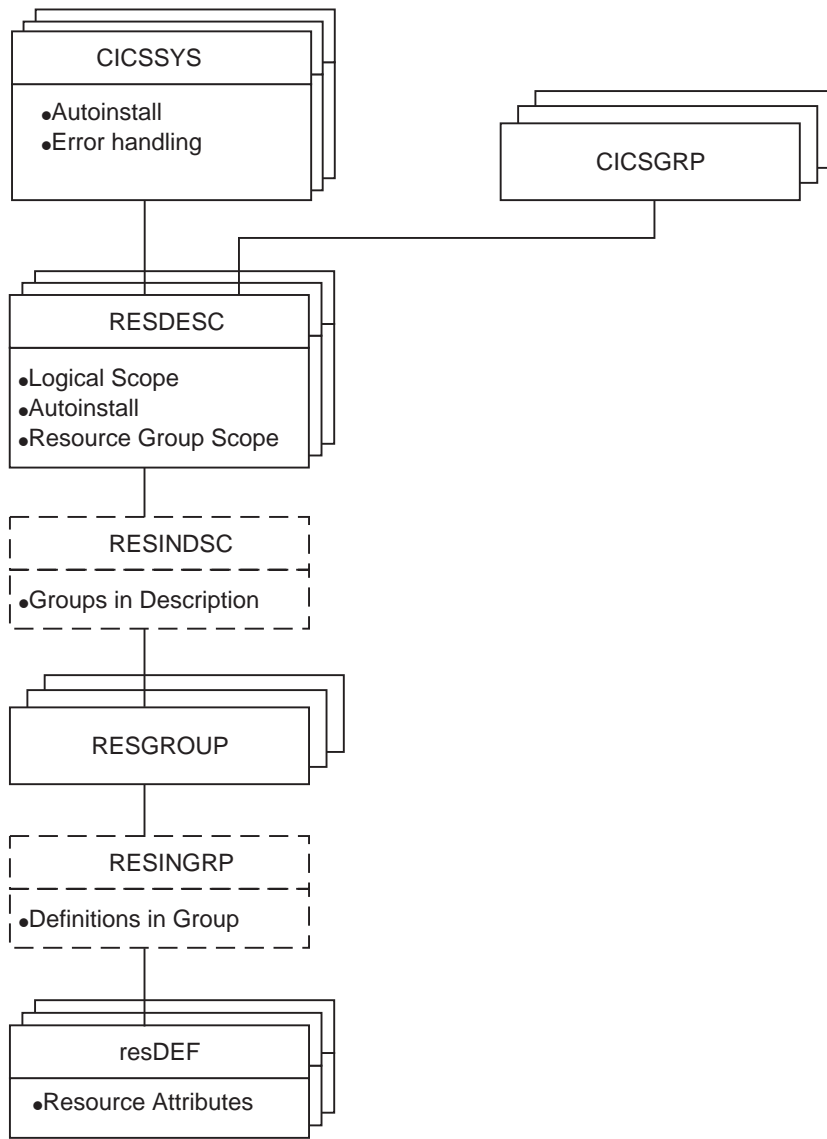

Figure 14. The migration from BAS object model



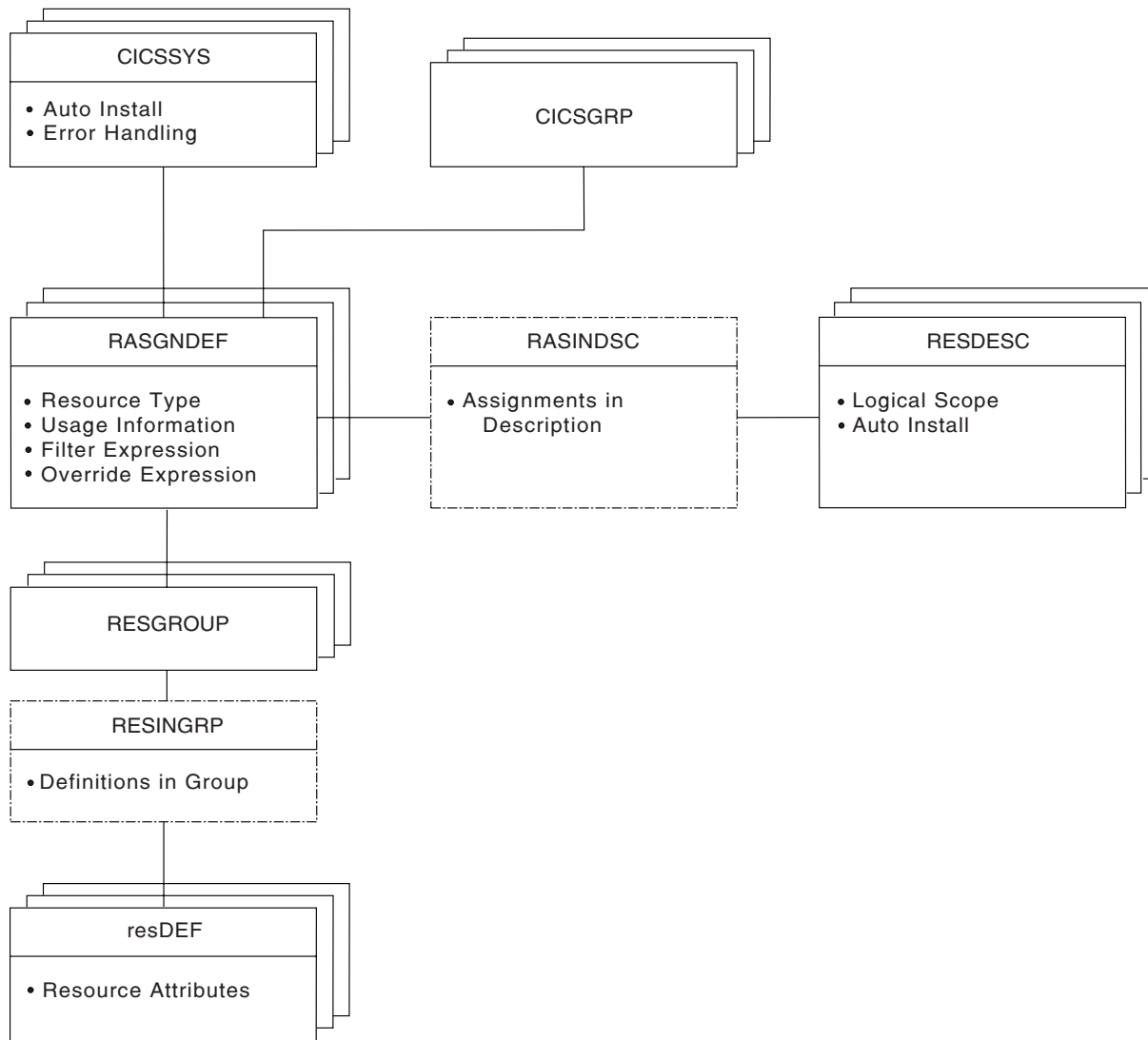

Figure 15. The full-function BAS object model

## Migrating your resource definitions

You do not have to recreate your resource definitions and resource groups in BAS. You can migrate your existing CSD structures.

The process of moving your resource definitions and resource groups from your CSDs to the data repository is:

1. Use the EXTRACT command of the DFHCSDUP utility routine to read the CSD records.
2. Use the CICSplex SM extract routine EYU9BCSD to create batched repository-update facility commands.
3. Input these commands to the batched repository-update facility to create resource definitions and resource groups, and the objects that link them. See *CICSplex SM Administration* for more information of the batched repository-update facility.

This process maintains the relationship between resources and groups. You can migrate all or part of a CSD, or more than one CSD, at any one time. Further information on how to extract CSD records is given in *CICSplex SM Managing Business Applications*. Details on using the batched repository-update facility are in *CICSplex SM Administration*.

---

## Defining resources

BAS enables you to define and maintain your resource definitions by providing a view for each resource type. See Table 3 on page 48.

The definition of resources for CICSplex SM is similar to CICS RDO. To define a resource, you create a *resource definition object*. You describe the attributes of the resource in the definition but you do not need to define every occurrence of every resource; you can use a small number of resource definitions as templates for the creation of large numbers of resource definitions. The resource definitions are stored in the data repository for the CICSplex.

The differences between CICSplex SM resource definition objects and CICS resource definitions are:

- The same resource definition can be used by any CICS system in the CICSplex, across all supported platforms.
- You can define to CICSplex SM all the attributes of each resource, including both local and remote values. CICSplex SM determines the correct subset of attributes to use when the resource definition is assigned to a CICS system.
- You do not need to define every instance of your resources from scratch. You can create a resource definition as a “template” for many resources with similar, even identical, attribute values. You can specify temporary or permanent variations, called *overrides*, for CICSplex SM to create resources with different sets of values.
- You can create multiple versions of the same named resource definition. Each version is effectively a different resource definition, and can be used by different CICS systems or for different system requirements. For example, you might have different resource requirements for development and test systems. See “Validating resources.”

You can create resource definitions in three ways:

- Using the batched repository-update facility (see “The batched repository-update facility” on page 17)
- Using the BAS administration and definition views
- Using the API; see *CICSplex SM Application Programming Guide*.

## Validating resources

BAS performs many of the same resource definitions checks as RDO does. As individual resources are defined and installed, BAS checks:

- Individual attributes of a resource
- Interdependent resources attributes
- Release-specific resource attributes

In addition, BAS checks that each *set* of resources is consistent. Every time you make a change to a resource set, BAS checks that the resource being added or updated is not in conflict with a resource already in the CICS system. For example, you would get an inconsistent set error if you tried to assign different versions of the same resource to the same CICS system, or assign a resource as both local and remote.

BAS also provides a MAP function that allows you to check that your resource associations are what you want. You use this facility to display the structure of your resource associations, starting at any point in hierarchy. Figure 16 shows an example of a resource definition map.

```

----- MAP of RESDESC EYUBAA01 ----- Row 1 of 4
COMMAND ==>                               Scroll ==> PAGE
RESDESC  RASINDSC  RASGNDEF  RESGROUP  RESTYPE  RESDEF
-----
EYUBAD01-+<----->---EYUBAA01---EYUBAG01-+-CONNDEF  +-C001    0
          |                                     +-CONNDEF  +-C002    0
          +-----EYUBAG02-+-SESSDEF  ---S001
                                     +-SESSDEF  ---S002

```

Figure 16. Example of a BAS resource map

## Defining resource groups

A *resource group* is a set of related resource definitions that you want to manage as a unit. Resources groups are defined using the RESGROUP object. The resource definitions in a group may be of the same type or of different types, but usually have something in common. They might be logically related by their use in a given application or communications network, or geographically related by their use at a given site.

There is no real limit to the number or combination of resource definitions that can make up a group. However, only one version of any given resource can be included in a resource group at one time. You have to maintain each version of a resource definition in a different resource group.

## Using migration form BAS

With migration form BAS, your resource groups are associated directly with *resource descriptions*. A resource description specifies whether or not you are using logical scoping, and the CICS systems for the resource groups associated with the resource description. See Figure 14 on page 50.

When you have migrated or defined your resources and resource groups, you need to create resource descriptions to define your applications. Resource descriptions are defined using the RESDESC object. A resource description is directly related to one or more resource groups that are to be managed as an entity. In the migration form BAS model, this relationship can be considered to represent a logical scope, but the resource description is really analogous to a RDO group list, in that all the resources are tied to a given CICS system or CICS system group.

---

## Using full-function form BAS

With full-function BAS, resource groups are not associated directly with resource descriptions. An additional object, the *resource assignment* (RASGNDEF), defines the characteristics and usage of a selected resource type from a resource group. The resource assignment is associated with a resource description, which can then be used to represent a business application. See Figure 15 on page 51

These objects are used to define your resources in terms of their business application.

## Using resource assignments

Power and flexibility in the management of resources is offered by the *resource assignment* (RASGNDEF) object.

**Note:** If you are using the migration form form of BAS, you do not use resource assignments.

Each resource assignment relates to one resource type within a resource group, and it must be associated with a resource description, if it is to be used in logical scoping or automatically installed. Each resource group can be in more than one resource assignment.

You can further refine the selection of resources within the type specified by the resource assignment by using a filter expression, and you can change the resource attributes using an override expression. You can combine in the expression an unlimited number of attribute values, using the logical operators AND, OR, and NOT. When the resource description is specified as the scope, CICSplex SM processes only those resources that meet the specified selection criteria. This gives you a great deal of control over the management of your resources.

Each resource assignment must be added to a resource description, if it is to be installed and used in logical scoping. Creating resource assignments and adding them to a resource description enables you to manage sets of resources with a logical scope that can span many CICS systems. In this case, the resource description becomes, in effect, a user-defined, logical set of resources, such as an application. You might have several different resource descriptions associated with a given CICS system, each one representing a different set of resources.

For example, with a resource assignment, you can:

- Select specific resources from a resource group.
- Identify the CICS systems where local and remote instances of a resource should be assigned.
- Temporarily override the values of specific resource attributes.

The resources selected by a resource assignment cannot be managed independently. The resources must be members of a *resource group* and the resource assignment must be associated with at least one resource description.

## Using resource descriptions

With full-function BAS, a resource description represents an application, that is, a set of logically-related resources that can span more than one CICS system. The resource description thus identifies the *logical scope* of the application.

Each resource group to be used as part of the application must be added to the resource description. You can associate whole resource groups with a resource description to create a larger set of resources (much like a CSD group list). This allows you to manage the resources more efficiently. The set of resources identified in a resource description can be:

- Identified as a logical scope (such as an application) for use in subsequent CICSplex SM requests
- Installed in systems running CICS/ESA 4.1 or later. The resources can be installed either automatically, when the CICS system identifies itself to CICSplex SM as a MAS, or dynamically, while the CICS system is up and running.

The BAS objects that are used for creating and managing these resource associations shown in Figure 14 on page 50 and their functions are summarized in Table 3 on page 48.

---

## Installing applications and resources

Optionally, as an alternative to installing resources from the CSD, you can use BAS to install your resources, from the data repository into CICS systems that are running CICS/ESA 4.1 or later. BAS allows you to install all the resources associated with an application, by installing the resource description, or one resource group. BAS applies any resource assignments you have associated with the application resource description or resource group, and selects the actual resources to be installed on the basis of those criteria. Alternatively, you can install an individual resource into one or more CICS systems, either locally or remotely, as appropriate.

BAS can install resources either automatically at system initialization time or dynamically into an active CICS system. Before installing a resource, CICSplex SM performs checks to determine whether the resource already exists in the CICS system. The normal situation is that if the resource exists, the new resource is considered a duplicate and is not installed. However, when you dynamically install resources, BAS offers the option of bypassing the duplicate resource checking and forcing the unconditional installation of resources.

### Automatic installation

When a CICS system initializes and identifies itself to a CMAS, BAS reviews the resources associated with that system and decides the set of resources to be installed.

### Dynamic installation

You can install resources dynamically into an active CICS system by issuing the INS action command either from the appropriate resource definition view, or from the Resource group (RESGROUP), Resource description (RESDESC), or System link (SYSLINK) view.

---

## Security considerations

Because of the importance of resource definitions to your CICSplex SM environment, you need to consider carefully the implications of allowing users access to certain types of resource or to certain functions. You can allow a user to have access to all resource definition views and their related administration views, or you can restrict access to the definition views for a particular resource type. You can also define the type of access a user has, for example, one user might have read-only access to connection definition (CONNDEF) and session definition (SESSDEF) views, but update access (which permits creation and administration of resources) to all other resource types. You need to make sure that the BAS views are adequately protected, so that unauthorized users cannot create and administer resources.

You should also take care if you are running CICS/ESA 4.1 or later, and are using the EXEC CICS CREATE command to build new resources. Any definition created with the CICSplex as the context is automatically distributed to all CMASs in the CICSplex. Therefore, giving a user authority to create BAS objects is potentially equivalent to giving authority to install resources on any CICS system in the CICSplex. When the CICS system starts, there is no check on who installed the resource in the system.

For details on setting up security for CICSplex SM at your enterprise, see *CICSplex SM Administration*.

---

## Planning for BAS

BAS allows you to create CICSplex SM objects that define your resources and to group them in such a way that you have close control over the running of your applications. You do not have to transfer all your CSD resources to CICSplex SM at the same time, neither do you have to decide at the outset which approach you will use. You can extract the resource definition records from one or more CSDs, or only a subset of records from one CSD. You can move directly to using full-function BAS, or you can use migration form BAS, and gradually move towards full-function BAS. You can use RDO, migration form BAS, and full-function BAS in the same CICSplex.

This section poses some of the questions you might like to consider when you start planning to implement BAS in your enterprise:

- If you are going to use the extract facilities:
  - In what order do you want to extract your CSDs?
  - Do you want all the records from a CSD or a subset?
  - Are you going to extract more than one CSD at a time?
- Are you going to use the migration form approach?
- Are you going to implement full-function BAS? You then need to think about how your business applications use resources and the assignments you need to create.
- Which resources are to be installed automatically and which are to be installed dynamically?
- Where are the resources to be installed?

- Do you need to define manually any resources that are not defined in the CSD?
- What security measures do you need to implement? (See “Security considerations” on page 56).

Two IBM utilities can assist you in the planning and understanding of your application resource flow:

- CICS Interdependencies Utility
- CICS Transaction Affinities Utility.

---

## Implementing BAS

This section describes a route you could take to implement BAS on your CICSplex.

### Creating migration form BAS

The first stage in the process of moving to using BAS is to migrate your resources from CICS to CICSplex SM:

- Move your resource definitions, resource groups, and the relationships between them, from the CSD to the CICSplex SM data repository. This process, which is described in “Migrating your resource definitions” on page 51, gives you an intermediary resource hierarchy that is very like CEDA, in that each resource definition is in a resource group.
- Create definitions and groups for any resources that are not held on the CSD.
- Create applications by associating each resource group with a resource description.

There are no resource assignments and, although you can now run your CICSplex SM system perfectly satisfactorily, you will not be taking advantage of the special functionality offered by BAS.

Once you have extracted your CEDA definitions, you can proceed to migrate your resource definitions to full BAS function, as described in “Migrating to the use of resource assignments.”

### Migrating to the use of resource assignments

You don't have to migrate all your resources to resource assignments at the same time. You can identify certain resources in which you are interested, remove them from direct association with resource definitions, and create resource assignments (using the RASGNDEF object) for them. When you are happy with the resource assignments, you can move on to defining another set of resource definitions.

As you move towards processing your resource definitions more full-functionally, you should remove resource groups from direct association with a resource description and identify them instead in one or more resource assignments.

**Note:** You can use the same resource description to manage both whole resource groups and selected resources identified in resource assignments. As you begin to take advantage of the resource assignment capabilities, you may have to update some of the underlying resource definitions. For example, a resource definition that was previously associated as is with a CICS system

## where next?

might require additional attributes before it can be assigned as both a local and remote resource in different CICS systems.

## A recommended approach

When you decide to implement BAS functions in your enterprise, you should begin by defining the appropriate objects. This section summarizes the preceding sections. You should:

- Extract resource definitions and resource groups from the CSD, as described in “Migrating your resource definitions” on page 51. Alternatively:
  - Use the appropriate resource definition views to create resource definitions.
  - Use the RESGROUP view to create resource groups.
- Use the RASGNDEF view to create resource assignments.
- Use the RESDESC view to create resource descriptions.

Then, to create associations between these objects:

- Use the appropriate resource definition view to add resource definitions to the resource group.
- Use the RESGROUP view to add the resource group to the resource assignments.
- Use the RASGNDEF view to associate the resource assignment with a CICS system or CICS system groups.

You can use the MAP action command to display a visual map of the BAS definitions in your data repository. If you want to see a list of the objects and associations you have already defined, use the RESINGRP view.

CICSplex SM includes a *Starter Set* of CICSplex SM object definitions that illustrates the concepts and components introduced in this chapter. The Starter Set is described in detail in Chapter 10, “The CICSplex SM Starter Set” on page 111.

If you have problems defining any particular object or association, refer to the CICSplex SM Starter Set examples. The Starter Set includes BAS examples that you can use as models for your own objects. You can copy the supplied samples directly into your data repository via the batched repository-update facility. For more information about using the Starter Set as a model see *CICS Transaction Server for OS/390 Installation Guide*. For more information about the batched repository-update facility, see *CICSplex SM Administration*. The Starter Set definitions are listed in Chapter 10, “The CICSplex SM Starter Set” on page 111.

---

## Where next?

Once you have identified your BAS requirements, you need to set up your resources and their associations as described in *CICSplex SM Managing Business Applications*.



## Chapter 6. Managing workloads

This chapter covers:

- “What is workload management?”
- “Workload balancing” on page 63
- “Workload separation” on page 65
- “Intertransaction affinity” on page 65
- “Managing workloads” on page 66
- “Planning for WLM” on page 69
- “Implementing WLM” on page 71
- “Where next?” on page 74

For full details, see *CICSplex SM Managing Workloads*.

---

### What is workload management?

CICSplex SM's workload management (WLM) function provides you with the capability to control where your work requests are run, in order to optimize performance and workload throughput. WLM uses the CICSplex SM dynamic routing program EYU9XLOP to route work requests to the most suitable target region from a predefined set of target regions.

### What is dynamic routing

In a CICSplex or BTS-set, resources such as transactions and programs required in one region may be owned by another. For example, you may have a terminal-owning region (TOR) that requires access to transactions owned by an application-owning region (AOR).

You can specify the location of a resource when you are designing your system so that requests of a specific resource are always routed to the same region. Typically, the location of the resource is specified in the installed resource definition. This is known as *static routing*.

With *dynamic routing*, the location of the resource is decided at run time. In CICSplex SM, the decision on where to run a piece of work, which may be a dynamic transaction, an EXEC CICS START command, a distributed program link request, or a transaction associated with a CICS business transaction services (BTS) activity, is taken by EYU9XLOP, the user-replaceable dynamic routing program (called the dynamic *transaction* routing program in previous releases). The user-replaceable program EYU9XLOP creates the environment necessary for CICSplex SM-based dynamic routing, and sets up the run-time environment.

The dynamic routing program can route:

- Transactions initiated at a terminal
- Eligible EXEC CICS START requests that are associated with a terminal
- Eligible EXEC CICS START requests that are not associated with a terminal
- Dynamic program link (DPL) requests that are received using:
  - The CICS Web Interface
  - The CICS Gateway for Java

## dynamic routing models

- External CICS interface (EXCI) client programs
  - Any CICS client workstation products using the External Call Interface (ECI)
  - Distributed Computing Environment (DCE) remote procedure calls (RPCs)
  - Open Network Computing (ONC) RPCs
  - Internet Inter-Object Request Block Protocol (IIOP)
  - Any function that issues an EXEC CICS LINK PROGRAM request
- CICS business transaction services (BTS) processes and activities

In CICSplex SM, dynamic routing is managed by the Workload Manager component of CICSplex SM.

The CICS regions involved in dynamic routing may act as one or more of the following:

- Requesting region** The CICS region in which the work request originates.
- Routing region** The CICS region in which the decision is taken on where the work will run.
- Target region** The CICS region where the request is actioned.

For *dynamic transaction routing*, the requesting region and the routing region are typically TORs, and the target region is typically an AOR. For *inbound DPL client requests*, the requesting region and the routing region are typically TORs, and the target region is typically an AOR. For *EXEC CICS START commands associated with a terminal*, the requesting region is typically an AOR, the routing region is typically a TOR, and the target region is typically an AOR. For *peer-to-peer DPL requests*, *EXEC CICS START commands that are not associated with a terminal*, and for *CICS business transaction services processes and activities*, the requesting region, routing region, and target region are typically AORs.

## Dynamic routing models

There are two possible dynamic routing models:

- The traditional “hub” model
- The distributed model

### The traditional hub model

The traditional hub model is shown in Figure 17 on page 61. This is the model used for the dynamic routing of transactions, EXEC CICS START commands associated with a terminal, and inbound client DPL requests. The request is initiated in the requesting region, typically a TOR, which also acts as the routing region. The request is routed to a target region, selected from the specified target group, where the program is executed.

The “hub” model is *hierarchical*, in which routing is controlled by one region (the routing region, that is, the TOR). Normally, a routing program runs only in the routing region. This model has the advantage of being relatively simple to implement. For example, compared with the distributed model, there are few inter-region connections to maintain. The disadvantages of the hub model are:

- If you use only one hub to route transactions and program-link requests across your target regions, the hub routing region is a single point-of-failure.
- If you use more than one hub to route transactions and program-link requests across the same set of target regions, you may have problems with distributed

data. For example, if the routing program keeps a count of routed transactions for load balancing purposes, each hub routing region will need access to this data, which may be maintained in a local temporary storage queue.

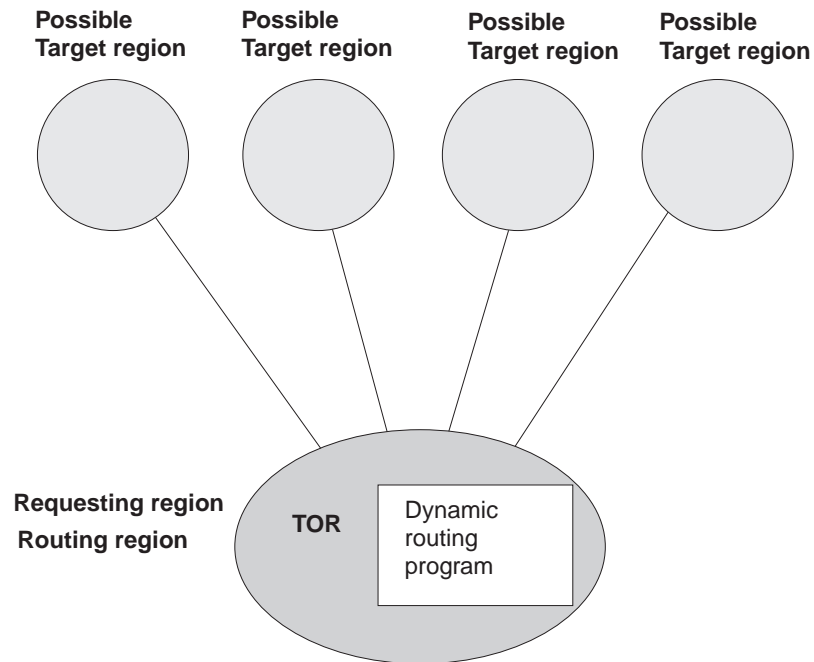

Figure 17. Dynamic routing using a hub routing model

### The distributed model

The distributed model is shown in Figure 18 on page 62. This is the model used for the dynamic routing of EXEC CICS START requests that are not related to a terminal, and BTS activities. Each CICS system in the target group may act as a requesting region, routing region, and target region. A distributed routing program runs in each region.

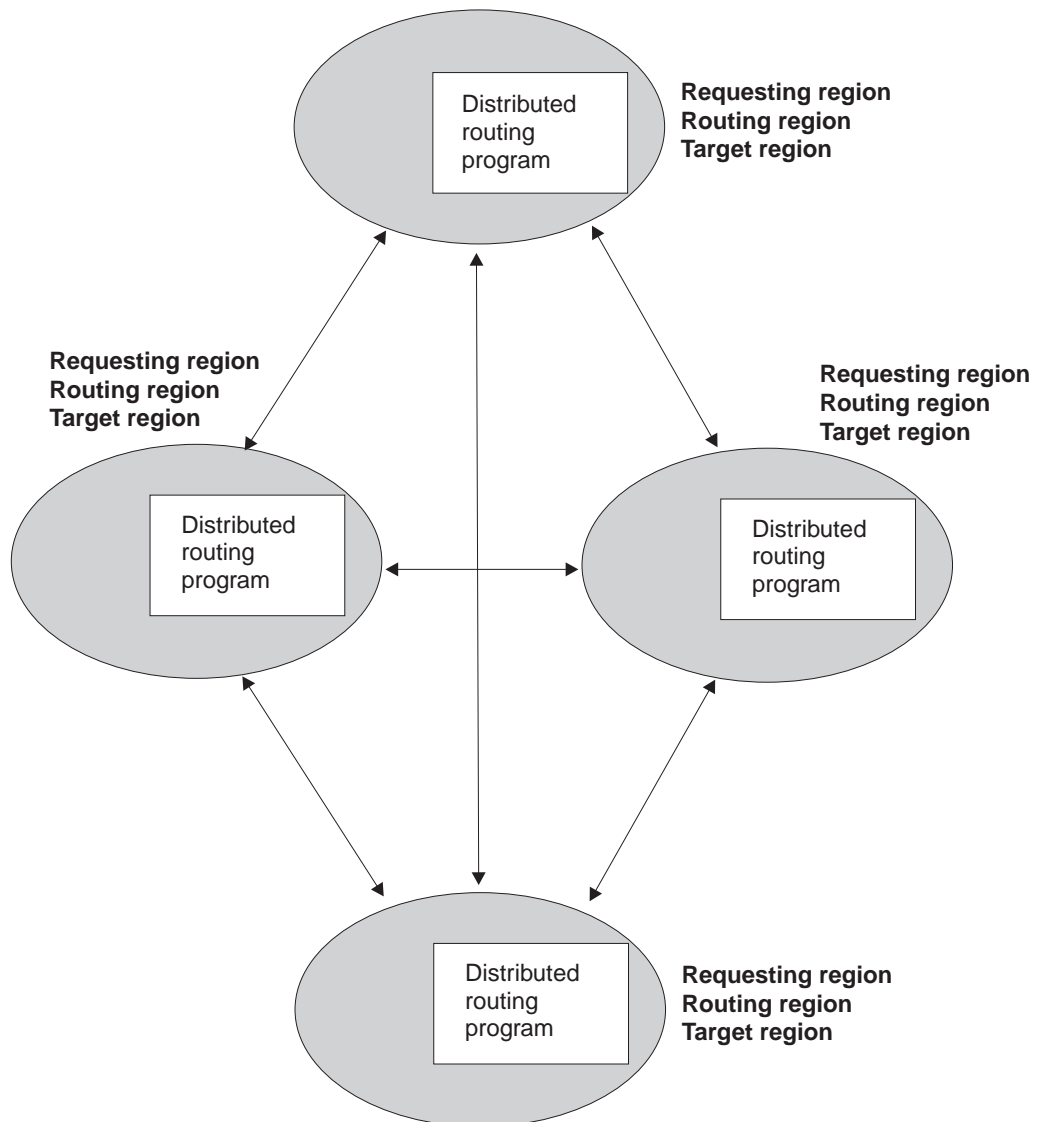

Figure 18. Dynamic routing using a distributed routing model. Note that, for CICSplex SM, the dynamic routing program EYU9XLOP performs also the distributed routing function.

The advantage of the distributed model is that there is no single point of failure.

The disadvantages are:

- Compared with the hub model, there are a great many inter-region connections to maintain.
- You may have problems with distributed data. For example, any data used to make routing decisions must be available to all regions. With CICSplex SM, this problem is solved by the use of data spaces.

## WLM functions

CICSplex SM's dynamic routing program supports:

- *Workload separation*: see page 65
- *Workload balancing*: see page 63
- *Intertransaction affinity*: see page 65

## Advantages of WLM

CICSplex SM's WLM function is of particular benefit in those enterprises that are running CICS/ESA on Parallel Transaction Servers (PTSs), because CICSplex SM can route work throughout the sysplex.

With WLM in your enterprise, you have:

- The ability to route all types of program link request dynamically to improve the performance and reliability of inbound client and peer-to-peer DPLs.
- The ability to route eligible EXEC CICS START commands dynamically to improve the performance and reliability of the applications using these commands.
- The ability to integrate workload balancing for terminal-initiated transactions, non-terminal-initiated transactions, EXCI clients, CICS clients, CICS Web support, CICS Transaction Gateway, IIOF, and started tasks.
- The ability to integrate BTS processes and activities fully into the workload separation and workload balancing functions.
- Optimum performance and response times for a variable and unpredictable workload.
- Work routed away from a failing target region to an active target region.
- Opportunities for increased throughput and improved performance.
- Reduced risk of bottlenecks
- Individual target regions taken out of service without impact to the end-user.
- Less operator intervention.

For full details, see *CICSplex SM Managing Workloads*.

---

## Workload balancing

*Workload balancing* is the routing of transactions or programs among a group of target regions according to the availability and activity levels of those target regions. Workload balancing can be used in addition to, or in place of, workload separation. For example, CICSplex SM can balance the workload among the SALESGRP target regions by selecting, as each transaction is initiated, the target region that is likely to deliver the best performance.

Which target region processes the work is determined wholly by CICSplex SM using one of two algorithms. These are the *queue algorithm* and the *goal algorithm*.

Workload balancing is statistical in nature. Selection of the appropriate target region is based completely on the target region's ability to achieve the expected response time when utilizing the goal algorithm, or balancing the load across a set of target regions when using the queue algorithm. If all the target regions in a set are equally capable of handling the work within the constraints of link type, abend probability, health, normalized load and response time (for goal), then a target region is randomly selected from the resulting set. Therefore, in systems that are lightly loaded, there is no predetermined order in which work is allocated to equally capable target regions, since the target regions are by definition equally capable of achieving the desired effect. This is in contrast to some balancing algorithms that

## workload balancing

use a “round robin” technique, whereby work is allocated to the given set of target regions simply by allocating the next instance to the next target region in the ring.

When selecting a target region, both the queue algorithm and the goal algorithm take into account the way in which a target region is connected to its requesting region. That is, a target region connected to its requesting region via MRO/XCF is preferred to a VTAM-connected target region, when all other considerations are equal.

### The queue algorithm

The queue algorithm causes CICSplex SM to select the target region that:

- Has the shortest queue of work waiting to be processed, relative to the maximum number of tasks permitted in the target region.
- Is the least affected by conditions such as short-on-storage, SYSDUMP, and TRANDUMP.
- Is the least likely to cause the transaction to abend. (For CICS BTS and non-terminal-related EXEC CICS START commands, the target regions must be on the same MVS image as the routing region.) This factor may be taken into account for CICS/ESA 4.1 (and later), and CICS Transaction Server for VSE/ESA Release 1, target regions only.

This algorithm maximizes work throughput and standardizes response times across the CICSplex. The queue algorithm is very robust: it can accommodate differences in processor power; different maximum task values in the target regions; asymmetric target region configurations; and an unpredictable workload.

### The goal algorithm

The goal algorithm causes CICSplex SM to select the target region that:

- Is the least affected by conditions such as short-on-storage, SYSDUMP, and TRANDUMP.
- Is the least likely to cause the transaction to abend. (For CICS BTS and non-terminal-related EXEC CICS START commands, the target regions must be on the same MVS image as the routing region.)
- Is the most likely to enable the transaction to meet average response-time goals set for it (and for other transactions in its class) using the Workload Manager component of MVS/ESA 5.1 (or later).

MVS/ESA 5.1 (or later) is a prerequisite of the goal algorithm. Also, routing regions in a CICSplex using the goal algorithm must be CICS/ESA 4.1 (and later), and CICS Transaction Server for VSE/ESA Release 1, regions.

The goal algorithm works best in environments where, if the CICSplex crosses multiple MVS images:

- A similar number of target regions is on each of those MVS images.
- The number of service classes on each MVS image is similar to the number of target regions on each MVS image.

---

## Workload separation

Workload separation routes work from a requesting region among a set of target regions, but the requirements of users, terminals, the transactions themselves, and their BTS process type, can influence which target region set is used. The routing of particular transactions or programs to a particular group of target regions is based on any combination either of user ID, terminal ID, and transaction group, or of transaction group and process type.

For example, you can specify that:

- Any transaction initiated by users whose user IDs begin with the characters “PAY” must be routed to a target region in CICS system group AORPAY1.
- Any transaction initiated from a terminal whose LU name begins with the characters “NYORK” must be routed to a target region in CICS system group AORNYORK.
- Any transaction belonging to the transaction group ACCOUNTS must be routed to a target region in CICS system group AORACCNT.
- All processes associated with a BTS process type TRAVEL are routed to a target region in one BTS-set, and all processes associated with BTS process-type PAYROLL are routed to another BTS-set.

When the set of target regions has been identified, CICSplex SM uses the selected workload *balancing* algorithm (the queue algorithm or the goal algorithm) to identify a suitable target region from this set.

---

## Intertransaction affinity

An intertransaction affinity is a relationship between transactions, of a specified duration, that requires them to be processed by the same target region. For example, you might have a pseudoconversation made up of three separate transactions, and each transaction passes data to the next transaction in the sequence via a temporary storage queue (which may be shared in the distributed model). You would then specify that all three transactions must be processed by the same target region, and that this affinity lasts for the duration of the pseudoconversation. (If you did not define this affinity to CICSplex SM, each transaction could be routed to a different target region and would therefore be unable to access temporary-storage data left by the previous transaction.) The target region itself is selected by CICSplex SM from the specified target scope.

Workload management and the CICS Transaction Affinities Utility understand affinities between BTS processes and activities. BTS itself does not introduce affinities, and discourages programming techniques that do, but it does handle existing code that may introduce affinities. You should define such affinities to workload management, so that it can make sensible routing decisions. It is particularly important to specify each affinity’s lifetime; failure to do so may restrict unnecessarily workload management’s routing options.

Workload management and the CICS Transaction Affinities Utility do not understand affinities between routable non-terminal-related EXEC CICS START commands, or between DPLs not associated with a user id or a terminal. You should take steps either to remove any affinities from your applications, or to ensure that your applications honor any affinities.

## managing workloads

Note that, if data is passed between transactions via the COMMAREA on the EXEC CICS RETURN command, no such affinity exists: the COMMAREA is passed back to the requesting region, and so can be passed to the target selected to process the next transaction in the sequence. For more information about ways of avoiding or minimizing transaction affinities, see the CICS/ESA publication *Dynamic Transaction Routing in a CICSplex*.

### How intertransaction affinities are honored

When the first transaction from a group of related transactions is started, CICSplex SM selects an appropriate region from the specified target scope. If there is more than one suitable region in the target scope, CICSplex SM selects one using the current workload balancing algorithm. Subsequent transactions in the same group that meet the affinity criteria are directed to the same region as the first transaction. If subsequent transactions do not meet the affinity criteria (for example, if the same pseudoconversation is started from a different user ID), the selection process for a suitable region starts again.

## Managing workloads

Your workload environment is set up and managed using the objects described in Table 4.

Table 4 (Page 1 of 3). Workload management objects

Object name	Description	Function
DTRINGRP	Transactions in transaction groups	This object displays information about the transactions associated with one or more transaction groups.
TRANGRP	Transaction groups	A transaction group is an association of logically similar transactions. The similarity may be based on affinity requirements, common shared processing requirements, or any other user-determined characteristics. The transaction group is included as part of the workload definition, which in turn defines the CICS system group to be used as the target region. Any transaction that is not specifically associated with a transaction group is assigned to the default transaction group.
WLMATAFD	Transaction affinities for an active workload	This object shows a detailed display of the properties of a single active CICS BTS affinity. This is useful when you need to view the contents of the CICS BTS affinity key in hexadecimal format.
WLMATAFF	Transaction affinities for an active workload	This object shows information about the active affinities for a transaction group associated with a workload within the CICSplex identified as the context. An affinity becomes active when the first transaction associated with the transaction group is dynamically routed to a target region.
WLMATAFS	Summary of transaction affinities	This object, which is the summary form of the WLMATAFF object, shows summarized information about the active affinities for a transaction group associated with a workload with the CICSplex identified as the context.



Table 4 (Page 2 of 3). Workload management objects

Object name	Description	Function
WLMATGRP	Transaction groups associated with an active workload	This object shows information about transaction groups associated with a workload that is within the CICSplex identified as the context.
WLMATRAN	Transactions associated with an active workload	This object shows information about all active transactions associated with a workload that is within the CICSplex identified as the context.
WLMAWAOR	Target regions in an active workload	This object shows information about all target regions that are associated with a workload that is within the CICSplex identified as the context.
WLMAWAOS	Target regions in an active workload summary	This object shows summarized information about all target regions that are associated with a workload that is within the CICSplex identified as the context.
WLMAWDEF	Active workload definitions	This object shows information about active workload definitions associated with a workload that is within the CICSplex identified as the context.
WLMAWORD	Details of an active workload	This object shows information about an active workload within the CICSplex identified as the context. A workload is active within a CICSplex as long as: <ul style="list-style-type: none"> <li>• A CICS system that is acting as a routing region or target region, and is participating in the workload, is connected to that CICSplex.</li> <li>• Any transaction causes an affinity lifetime of PERMANENT to be established.</li> </ul>
WLMAWORK	Active workloads	This object shows information about active workloads within the CICSplex identified as the context. A workload is active within a CICSplex as long as: <ul style="list-style-type: none"> <li>• A CICS system that is acting as a routing region or target region, and is participating in the workload, is connected to that CICSplex.</li> <li>• Any transaction causes an affinity lifetime of PERMANENT to be established.</li> </ul>
WLMAWTOR	Routing regions in an active workload	This object shows information about routing regions that are associated with a workload that is within the CICSplex identified as the context.
WLMAWTOS	Routing regions in an active workload	This object shows summarized information about routing regions that are associated with a workload that is within the CICSplex identified as the context.
WLMDEF	Workload definitions	This object identifies which transactions are to be routed to which CICS system group. You identify the transactions by transaction group, and within the group either by LU name and user id, or by process type.
WLMGROUP	Workload groups	This object is used to associate one or more workload definitions.
WLMINGRP	Workload definitions in workload groups	This object displays the names of workload groups and the workload definitions associated with them.
WLMINSPC	Workload groups in workload specifications	This object displays the names of workload specifications and the workload groups associated with them.

## managing workloads

Table 4 (Page 3 of 3). Workload management objects

Object name	Description	Function
WLMSCOPE	Workload specifications assigned a scope	This object displays information about the CICS systems or CICS system groups acting as routing regions that are associated with a named workload specification.
WLMSPEC	Workload specifications	A workload specification identifies a workload and one or more CICS system groups acting as target regions. It also defines the attributes of the default transaction group.

The WLM object model is shown in Figure 19 on page 69.

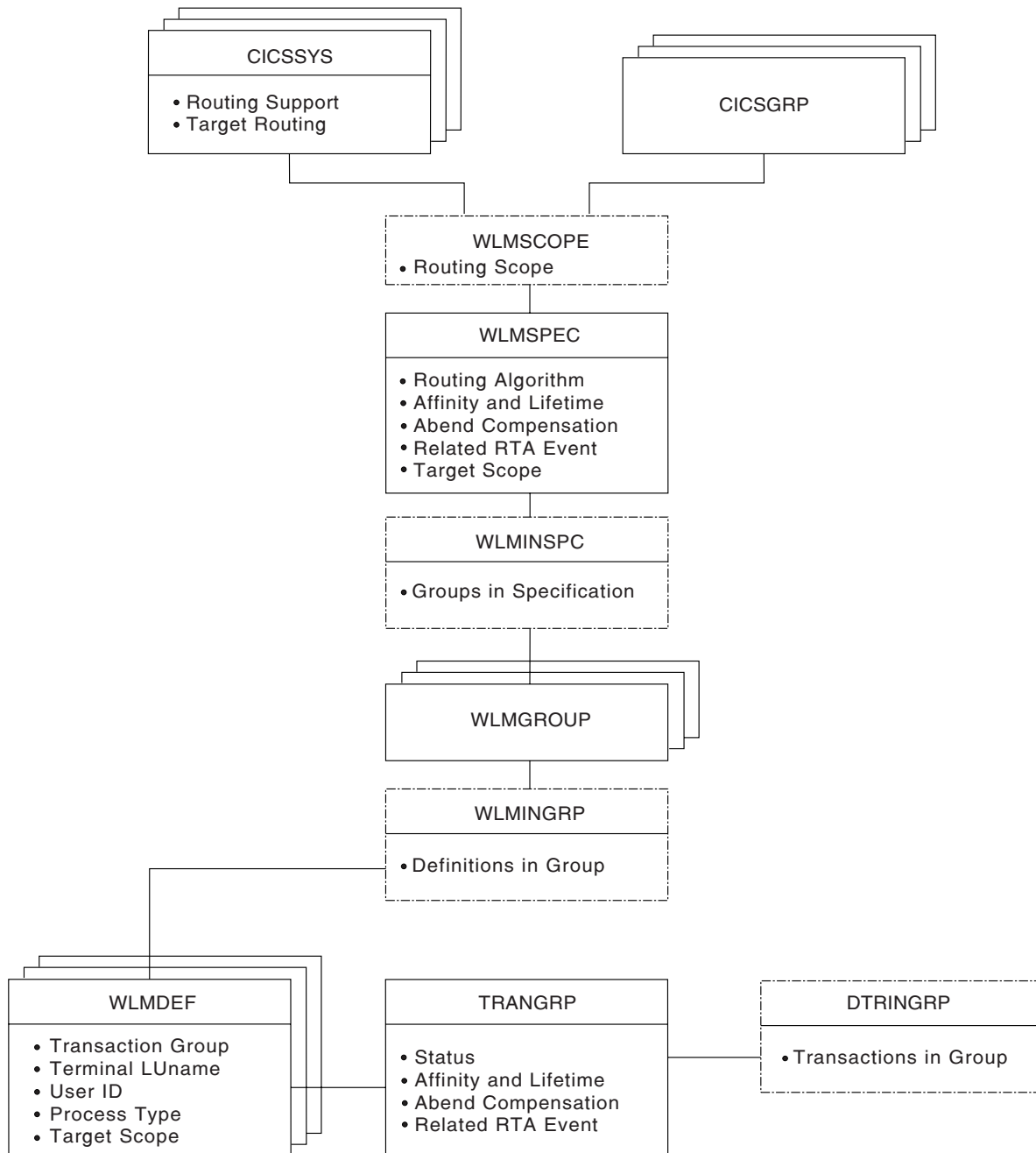

Figure 19. The WLM object model

## Planning for WLM

This section provides some instructions to help you determine the extent to which you can use CICSplex SM's workload management in your enterprise.

## Workload balancing or workload separation?

Workload balancing should be used wherever possible because it makes the best use of the available CICS systems, and provides opportunities for increased throughput and performance.

Workload separation (by process type, user, terminal, and transaction) should be implemented only where strictly necessary, because it prevents full exploitation of CICSplex SM's workload balancing functions. If you have defined more than one CICSplex, and have made the division to reflect use of CICS systems by different groups of users, for example, it's possible that you will be able to use simple workload balancing rather than workload separation within the CICSplex. For example, if you have separated the CICS systems used by group A from the CICS systems used by group B by defining two CICSplexes, then within each CICSplex you can implement workload balancing. If you haven't taken this approach, you might consider it necessary to recognize such groupings by implementing workload separation.

There are two major activities in your planning from WLM:

- Identifying the workloads in your enterprise
- Identifying intertransaction affinities and trying to remove them

## Identifying the workloads

Begin by identifying the workloads processed in your enterprise. These are certain to be apparent in any underlying TOR–AOR–FOR configurations that existed prior to your interest in CICSplex SM. Next, confirm that the current CICSplex SM configuration of CICS systems supports the identified workloads. In particular:

- Routing regions and target regions from a single workload must be in the same CICSplex. That is, the supplied dynamic routing program cannot route transactions beyond the confines of the CICSplex. (It is possible to route transactions outside of the CICSplex by customizing the supplied dynamic routing program. Customization of the supplied dynamic routing program is described in *CICSplex SM Managing Workloads*.)
- A routing region must be:
  - A CICS/ESA 4.1 (and later) region or a CICS Transaction Server for VSE/ESA Release 1 region.
  - A local MAS, that is, the requesting region cannot be running on an MVS image on which there is no CMAS.
  - In only one workload, that is, the routing region can be associated with only one active workload specification at a time.
  - For a BTS transaction, a terminal-related EXEC CICS START command, a non-terminal-related EXEC CICS START command, and a dynamic program link, CICS Transaction Server for OS/390 Release 3 and later.
- A target region can be:
  - For a BTS transaction, a terminal-related EXEC CICS START command, a non-terminal-related EXEC CICS START command, CICS Transaction Server for OS/390 Release 3 and later; otherwise any CICS system managed by CICSplex SM.
  - A local or remote MAS.
  - In multiple workloads.

## Identifying intertransaction affinities

Intertransaction affinities, which require related transactions to be processed by the same target region, prevent optimum workload distribution. In general, they arise either because of the way in which one transaction passes data to another, or because of a requirement to coordinate the processing of two or more transactions. Identifying affinities isn't always easy, but there are some methods you can use. For example, you can review application design documentation or source code; you can run CICS/ESA traces; or you can use the IBM CICS Transaction Affinities Utility MVS/ESA. For a detailed discussion of intertransaction affinities and ways of identifying them, see the CICS/ESA publication *Dynamic Transaction Routing in a CICSplex*.

Having identified any affinities in a workload, you should make every attempt to remove them. If you cannot remove them completely, gauge the duration of the affinity and try to minimize it. You can define an intertransaction affinity to CICSplex SM as lasting:

- While the user's session is active
- For the duration of the terminal session
- While the target region remains active
- While the workload is active
- For the duration of a pseudoconversation
- While the BTS activity is active
- While the BTS process is active

Be aware that CICSplex SM must honor an active affinity: if an affinity is active but the target region becomes unavailable, the transaction isn't routed. In the case of a BTS transaction, BTS will wait for the region to start.

---

## Implementing WLM

What you have to do to use CICSplex SM's workload management functions varies depending on whether you want to implement workload balancing only, or whether you also want to implement some workload separation, and possibly define one or more transaction affinities in the same CICSplex. You are recommended to follow this process:

1. Identify candidates for dynamic routing
2. Implement workload balancing for each workload in the CICSplex where dynamic routing is possible.
3. Add any necessary workload separation requirements.
4. Define any intertransaction affinities.

Each step is described in the remainder of this section.

## Identifying dynamic routing candidates

Not all work requests are candidates for dynamic routing. The conditions that have to apply for a work request to be eligible are listed in the *CICS Intercommunication Guide*.

For details of the EXEC CICS LINK and EXEC CICS START commands, see the *CICS Application Programming Guide* and the *CICS Application Programming Reference* book. For details of the EXEC CICS RUN ASYNCHRONOUS command,

see the *CICS Business Transaction Services* book. For details of resource definition, see either the *CICS Resource Definition Guide* or the *CICSplex SM Managing Business Applications*.

### Implementing workload balancing

To implement workload balancing within a CICSplex, your task is very straightforward:

1. If there is more than one routing region in a single workload, create a CICS system group of those routing regions, using the CICSSYS object.
2. Create a CICS system group of the target regions to which the routing regions can route transactions, using the CICSSYS object. This group could include every CICS system in the CICSplex.
3. Create one workload specification for each workload in the CICSplex, using the WLMSPEC object. In the workload specification, specify the name of the target system group as the target scope value, and identify which algorithm is to be used for workload balancing.
4. Associate the single routing region, or the routing system group, with the workload specification. (Remember that you can have multiple workloads in a single CICSplex, but that a routing region or group of routing regions can belong to only one active workload specification at a time.)

Workload balancing is effective within the workload when a routing region belonging to the workload is next started.

### Adding workload separation requirements

To implement workload separation in the same workload, by any combination either of user id, terminal id, and transaction group, or of process type and transaction group:

1. Create a CICS system group *for each set of target regions*, using the SYSGRP object. For example, if:
  - Transactions initiated by users ABC\* from terminals NETA\* must be routed to target regions 2 through 7and
  - Transactions initiated by users HIJ\* from any terminal must be routed to target regions 5 through 9two target system groups must be defined: one group includes target regions 2 through 7, and one group includes target regions 5 through 9.
2. Define a transaction group, using the TRANGRP object, if workload separation by transaction is to be implemented. For example, if transactions EFG1, EFG2, and EFG3 must be routed to a specific group of target regions, you must define a transaction group to include those transactions.
3. Create one workload definition, using the WLMDEF object, for each user, terminal, and transaction group combination. For the example in item 1 (above):
  - One workload definition would be required for the combination of any transaction, users ABC\*, and terminals NETA\*.

- One workload definition would be required for the combination of any transaction, users HIJ\*, and any terminal.

A third workload definition would be required to support the workload separation by transaction described in item 2 on page 72. In each workload definition, include the name of the appropriate target region system group to which eligible transactions are to be routed.

4. If the workload definitions are to be installed automatically when the first requesting region in the workload starts, you should use the WLMGROUP object to:
  - a. Create a workload group.
  - b. Add the workload definitions to the workload group.
  - c. Associate the workload group with the workload specification.

Automatic installation of the workload definitions is likely to be required, because workload separation is usually a regular and consistent requirement. However, you can also install a workload group or individual workload definitions manually for immediate effect.

## Defining intertransaction affinities

If there is a requirement for multiple transactions in the workload to be processed by the *same* target region:

1. Create a transaction group, using the TRANGRP object, for each set of transactions within the workload that share an affinity. For example, if transactions MNO1, MNO2, and MNO3 must be processed by the same target region (perhaps because they run in sequence and leave data for the next transaction), define a transaction group to include those three transactions specifying the affinity type and its duration.
2. If you want to implement workload separation, create a workload definition for each transaction group and user or terminal pattern, using the WLMDEF object. For example, if the intertransaction affinity described in item 1 (above) applies to any user from terminals NYORK\*, the workload definition must include that information. In addition, the workload definition identifies the set of target regions from which CICSplex SM can select one. This could be every target region in the CICSplex, or some subset of target regions.

Note that you can define an intertransaction affinity to CICSplex SM without also implementing workload separation. In this case, no workload definition is required and CICSplex SM routes the first transaction in the group to a suitable target region from the set identified in the workload specification. Subsequent transactions in the transaction group are routed to the same target region while the affinity is active.

3. If the workload definitions are to be installed automatically when the first routing region in the workload starts, you should use the WLMGROUP object to:
  - a. Create a workload group.
  - b. Add the workload definitions to the workload group.
  - c. Associate the workload group with the workload specification.

You can also install a workload group or individual workload definitions manually for immediate effect.

## where next?

**Note:** It's important that you define routing regions and target regions in groups, to ensure that changes to the composition of those groups are automatically reflected in CICSplex SM's workload management.

## A recommended approach

When you decide to implement WLM functions in your enterprise, you should begin by defining the appropriate objects. You should:

- Use the WLMDEF view to create a workload definition.
- Use the WLMGROUP view to create a workload group.
- Use the WLMSPEC view to create a workload specification.

Then, to create associations between these objects:

- Use the WLMDEF view to add the workload definition to the workload group.
- Use the WLMGROUP view to add the workload group to the workload specification.
- Use the WLMSPEC view to associate the workload specification with a CICS system or CICS system group.

You can use the MAP action command to display a visual map of the WLM definitions in your data repository. If you want to see a list of the objects and associations you have already defined, use the WLMINGRP, WLMINSPC, and WLMSCOPE views.

CICSplex SM includes a *Starter Set* of CICSplex SM object definitions that illustrates the concepts and components introduced in this chapter. The Starter Set is described in detail in Chapter 10, "The CICSplex SM Starter Set" on page 111.

If you have problems defining any particular object or association, refer to the CICSplex SM Starter Set examples. The Starter Set includes many WLM examples that you can use as models for your own objects. You can copy the supplied samples directly into your data repository via the batched repository-update facility. For more information about using the Starter Set as a model and about the batched repository-update facility, see *CICS Transaction Server for OS/390 Installation Guide* and *CICSplex SM Administration*, respectively.

---

## Where next?

Once you have identified your WLM requirements, you should define them to CICSplex SM as described in *CICSplex SM Managing Workloads*.



---

## Chapter 7. Exception reporting using real-time analysis (RTA)

The chapter covers:

- “What is real-time analysis?”
- “System Availability Monitoring (SAM)” on page 77
- “MAS resource monitoring (MRM)” on page 78
- “Analysis point monitoring (APM)” on page 80
- “Managing RTA” on page 80
- “Planning for RTA” on page 82
- “Implementing RTA” on page 83
- “Where next?” on page 85

---

### What is real-time analysis?

CICSplex SM's real-time analysis (RTA) function provides automatic, external, notification of conditions in which you have expressed an interest.

Real-time analysis is not concerned solely with commonly recognized error conditions: you can ask to be notified about any aspect of a resource's status.

For example, if you tell CICSplex SM that all files used by CICS systems AORPAY1 must be in ENABLED status, CICSplex SM sends out warning messages when the status of any of those files is other than ENABLED. However, CICSplex SM isn't restricted to telling you about a problem only after it has occurred. CICSplex SM's real strength lies in its ability to detect *potential* problems with CICS resources. Indeed, CICSplex SM is unrivaled in its ability to detect and warn of the slightest change in the status of a CICS resource. For example, CICSplex SM can tell you that resource contention is growing, or that the dynamic storage area (DSA) free space is falling, or that the number of users of a particular transaction is high: these can all be indicators of future problems that you could avoid by taking preventive action.

The notification can take the form of a console message, or of a generic alert to NetView, or both. The CICSplex SM application programming interface (API) makes it possible for automation products actively to gather status information from CICSplex SM, rather than waiting for CICSplex SM to send out MVS messages and SNA generic alerts.

### Why automate?

The CICSplex SM operator can monitor RTA messages and take appropriate action. For example, the CICSplex SM operator can change the status of a file from DISABLED to ENABLED using the CICSplex SM FILED view. However, this approach is becoming less satisfactory as CICS availability and performance requirements grow. Most enterprises are using more and more CICS systems, often via cloning, to process a growing workload. This factor alone has made the CICSplex SM operator's task more difficult and error prone. At the same time, however, service-level agreements are setting performance and availability targets that are more demanding than ever before. Consequently, the ideal environment is one in which the CICSplex SM operator is presented with problems only in the most exceptional circumstances. Such an environment is now possible, because

most actual and potential problems detected by CICSplex SM can be corrected or prevented by intelligent use of automation products, such as:

- NetView
- Automated Operations Control/MVS (AOC/MVS)
- Automated Operations Control/MVS CICS Automation (AOC/MVS CICS Automation)
- CICSplex SM itself. (Not only does CICSplex SM provide detailed and timely information about CICS resource status to other automation products, it is also capable of correcting many of the problems it detects.)

### The RTA external notifications

An RTA external notification is generated when the status of a CICS resource is not as expected. The notification can take the form of either an *external message* or an *SNA generic alert*, or both.

#### External messages

External messages are MVS/ESA operator messages that are written to the MVS console by default. External messages can also be viewed from the CICSplex SM EVENT view while a condition is active. When a condition has been resolved, it disappears from the EVENT view. (However, external messages written to the EVENT view are also written to the CICSplex SM EYULOG to provide a record of the contents of the EVENT view.) In the EVENT view, external messages are sorted in order of urgency, with the message about the most urgent condition at the top of the list. The urgency of a condition is user-defined.

External messages are issued in pairs: one message is issued at the start of a condition, and another is issued when the condition ends. The messages, which all have the prefix “EYUPN,” are described in the *CICSplex SM Messages and Codes* External messages can be intercepted by automation products, such as NetView, AOC/MVS, and AOC/MVS CICS Automation.

#### SNA generic alerts

CICSplex SM can construct SNA generic alerts and transmit them, via the NetView program-to-program interface (PPI), to NetView for processing. NetView can trap SNA generic alerts in its automation table, which can either take action itself to resolve the problem, or start some automation code from a command list (CLIST) or command processor.

### RTA functions

The RTA functions are:

- System Availability Monitoring (SAM): see “System Availability Monitoring (SAM)” on page 77
- RTA resource monitoring, which includes:
  - MAS resource monitoring (MRM): see “MAS resource monitoring (MRM)” on page 78
  - Analysis point monitoring (APM): see “Analysis point monitoring (APM)” on page 80

## Advantages of RTA

The advantages of using RTA are:

- Actions can be taken within CICS, removing the requirement to use external automation products.
- Potential problems are detected and corrected before they become critical.
- Performance to the end-user is improved by the early detection of bottlenecks that could affect response time.
- The volume of information presented to operators is reduced by filtering out unnecessary messages.

---

## System Availability Monitoring (SAM)

CICSplex SM's system availability monitoring (SAM) function monitors CICS systems during their planned hours of availability. If any of a set of predefined conditions occurs while a CICS system is being monitored, CICSplex SM sends out external notifications at the start of the condition and also when it is resolved. The conditions are:

SAMOPS	The CICS system (CICS/ESA, CICS/MVS, CICS for OS/2, or CICS/VSE) is not available.
SAMSOS	A CICS/ESA dynamic storage area (DSA) is short on storage.
SAMSDM	A CICS/ESA system dump is in progress.
SAMTDM	A CICS/ESA transaction dump is in progress.
SAMMAX	CICS/ESA or CICS/MVS has reached maximum tasks.
SAMSTL	One or more tasks in a CICS/ESA system are stalled because of contention for resources such as DBCTL, DL/I, transient data, files, journals, and temporary storage.

For example, if CICS system AORPAY2 must be active from 0900 hours to 1200 hours and CICSplex SM finds it inactive at 0930 hours, CICSplex SM issues external messages by default. A typical response, from the CICSplex SM operator or from an automation product, would be to try to restart the CICS system, or perhaps to start another.

## Customizing the SAM external notifications

When any of the SAM conditions occurs, CICSplex SM issues an external message by default. Each of the SAM conditions has a default severity and priority value that determines the position of the external message, relative to other external messages, in the EVENT view. For example, the SAMTDM condition has a severity of HW (High Warning) and a priority of 128, whereas the SAMSOS condition has a severity of HS (High Severe) and a priority of 255 (the highest priority), so SAMSOS precedes SAMTDM in the EVENT view.

You can customize the default SAM notifications for any CICS system by creating a CICSplex SM *action definition*. Using an action definition, you can change:

- The type of notification that is issued for a SAM condition. For example, you could specify that, for a particular CICS system, the SAMSOS condition will cause an SNA generic alert to be sent to NetView (so that NetView can take

## MAS resource monitoring

corrective action), and that no external message is to appear in the EVENT view.

- The severity value and the priority value of a SAM condition. For example, you could specify that the SAMTDM condition must have a severity of LW (Low Warning) in a particular CICS system, and that the SAMSOS condition must have a priority of 128.

You can also use the action definition to request that CICS/ESA 4.1 (or later) systems affected by a condition are to be cancelled and restarted using the MVS/ESA 5.2 automatic restart manager (ARM). This might be a suitable automation action for the SAMOPS condition, for example.

The default severity and priority values of the SAM conditions, and instructions for changing them using a CICSplex SM action definition, are included in *CICSplex SM Managing Resource Usage*.

## Automation and SAM

An automation product, such as AOC/MVS or NetView, can intercept SAM notifications and take corrective action, such as starting up or shutting down a CICS system, disabling a transaction, or requesting a dump. For example, if a CICS system becomes unavailable, one of the automation products could attempt to restart the system, or perhaps start another.

However, most of the SAM notifications relate to actual problems that are already having an effect on users, so your scope for preventive action is small. Consequently, the best automation option for most SAM conditions is usually to request a dump, which can provide more information about a problem and its causes.

---

## MAS resource monitoring (MRM)

Using CICSplex SM's MAS resource monitoring (MRM) function, you can monitor the status of *any* specific or generic CICS resource, and be informed when its status deviates from a specified norm. (SAM, by contrast, is the monitoring and evaluation of a "default" resource, the CICS system itself. Although you can tailor the type of notification you receive from SAM, the condition that triggers the notification is defined by CICSplex SM.) Using MRM, you can select both the resource status you are interested in and the type of external notification it generates. Here are some examples of the ways in which MRM can be used:

- You can use MRM to inform you of changes in the absolute status of a resource. For example, if the status of an LU6.2 connection is ever RELEASED at a time when you have specified it must be ACQUIRED, external notifications can be issued so that the CICSplex SM operator or an automation product can attempt to reacquire the connection. MRM can warn you of changes in the absolute status of many resources. For example, you can ask to be informed when a journal is CLOSED, when a transient data queue is DISABLED, when a FEPI node or a terminal is OUTSERVICE, when a transaction is DISABLED, and so on.
- In addition to monitoring absolute status values of CICS resources, CICSplex SM can provide information about subtle changes in a resource status, such as degradations in the response time of a transaction, or increases in the number of users of a program, or changes in the number of DB2 threads

in a CICS system. These are all examples of trends in resource behavior that might be indicators of incipient problems.

- Using MRM, you can specify complex conditions. For example, you can ask for an external notification to be issued when the number of users of a particular transaction reaches a specified level *and* the dynamic storage area (DSA) free size is falling. Only when both conditions are true is the notification issued. Conditions can be of any complexity.
- MRM even supports the monitoring of non-CICS resources, such as DB2, and of other members of the CICS family, such as CICS/400, by invoking user-written programs called *status probes*.

As its name suggests, MAS resource monitoring operates at the CICS system level. That is, if a resource's status changes in two regions, two sets of external notifications are issued, one for each region.

## Automation and MRM

MRM offers great scope for automation of CICS resource management, because it can alert you to both actual and potential problems. In alerting you to actual problems, MRM provides you with an opportunity to take *remedial* action; in alerting you to potential problems, MRM provides you with an opportunity to take *preventive* action. Furthermore, an automated response is possible to all MRM-detected problems.

When changes in the absolute status of a resource occur (for example, when a file that should be ENABLED becomes DISABLED, or when a connection that should be INSERVICE goes OUTSERVICE), remedial action is usually required. CICSplex SM itself can correct the status of such resources automatically, as can any of the automation products, such as NetView or AOC/MVS CICS Automation.

When more subtle changes in a resource's status occur, an automation product such as NetView can tailor its response to the severity of the problem. For example, CICSplex SM could monitor the DSA free size in a CICS system every five seconds. If CICSplex SM finds the DSA free size to be:

- Between 86KB and 100KB 4 times in succession, it issues an SNA generic alert to NetView with a severity of LW (low warning)
- Between 71KB and 85KB three times in succession, it issues an SNA generic alert to NetView with a severity of LS (low severe)
- 70KB or less twice in succession, it issues an SNA generic alert with a severity of VLS (very low severe).

In response to any of these alerts, the NetView automation table could issue an MVS modify command to the affected region to increase the DSA size dynamically, thereby preventing a short-on-storage condition (the SAMSOS condition, in fact) from occurring. The amount by which the DSA is increased in each case could vary according to the severity attached to the SNA generic alert by CICSplex SM.

## Analysis point monitoring (APM)

CICSplex SM's analysis point monitoring (APM) function is the same as its MRM function, except that when resources are monitored in multiple CICS systems (a CICS system group or an entire CICSplex), the occurrence of the same problem in any number of those CICS systems can result in one external notification rather than several. APM is especially useful in environments that use cloned AORs, where regions are identical and one notification is sufficient to alert you to a general problem. APM does not support the use of status probes for monitoring non-CICS resources. In all other respects, however, APM offers the same opportunities as MRM for early detection of potential problems, and for an automated response in such situations.

## Managing RTA

RTA is set up and managed using the objects described in Table 5.

<i>Table 5 (Page 1 of 2). Real-time analysis objects</i>		
<b>Object name</b>	<b>Description</b>	<b>Function</b>
APACTV	Analysis definitions associated with an analysis point specification	This object shown information about analysis definitions associated with an analysis point specification.
ACTNDEF	Action definitions	An action definition designates the type of external notification that is to occur when the condition or conditions identified in an analysis definition are true.
APCMAS	Analysis point specification and CMAS association	This object shows the relationship between analysis point specifications and CMASs. During real-time analysis initialization, the association between analysis point specifications and CMASs is used to determine which specification should be installed within the CMAS in which real-time analysis is activated.
APSPEC	Analysis point specifications	This object shows information about analysis point specifications. An analysis point specification identifies one or more CMASs that are to be responsible for analyzing CICS systems within the CICSplex identified as the context.
EVALDEF	Evaluation definition	This object shows information about evaluation definitions. An evaluation definition identifies the resources in one or more CICS systems that are to be sampled and evaluated. When the result of the evaluation is true, an associated analysis definition is used to determine if a notifiable condition has occurred.
EVENT	Changes in the status of a CICSplex or one of its CICS systems	This object shows information about outstanding changes in the status of a CICSplex or one of its CICS systems.
EVENTDTL	Evaluation definitions associated with analysis definitions	This object shows information about evaluation definitions associated with an analysis definition that has caused an event to be generated.
RTAACTV	Analysis and status definitions	This object shows information about analysis and status definitions installed in CICS systems known to the CICSplex identified as the current context.

*Table 5 (Page 2 of 2). Real-time analysis objects*

<b>Object name</b>	<b>Description</b>	<b>Function</b>
RTADEF	Analysis definitions	An analysis definition identifies the evaluations to be performed on a periodic basis and the actions to be taken should a notifiable condition occur.
RTAGROUP	Analysis groups	An analysis group is used to associate one or more related analysis definitions, status definitions, or both.
RTAINAPS	Analysis groups in analysis point specifications	This object displays the names of analysis groups associated with analysis point specifications.
RTAINGRP	Analysis and status definitions in analysis groups	This object displays the names of analysis groups and the analysis and status definitions associated with them.
RTAINSPC	Analysis groups in analysis specifications	This object shows the names of analysis specifications and the analysis groups associated with them.
RTASCOPE	Analysis specifications assigned a scope	This object shows information about the CICS systems or CICS system groups that are associated with an analysis specification.
RTASPEC	Analysis specifications	An analysis specification identifies the default control attributes that are used for system availability monitoring and provides an anchor for all analysis definitions and status definitions associated with a CICS system.
STATDEF	Status definitions	A status definition identifies a user-program that is to be called by CICSplex SM at specific intervals.

The RTA object model is shown in Figure 20 on page 82.

## planning for RTA

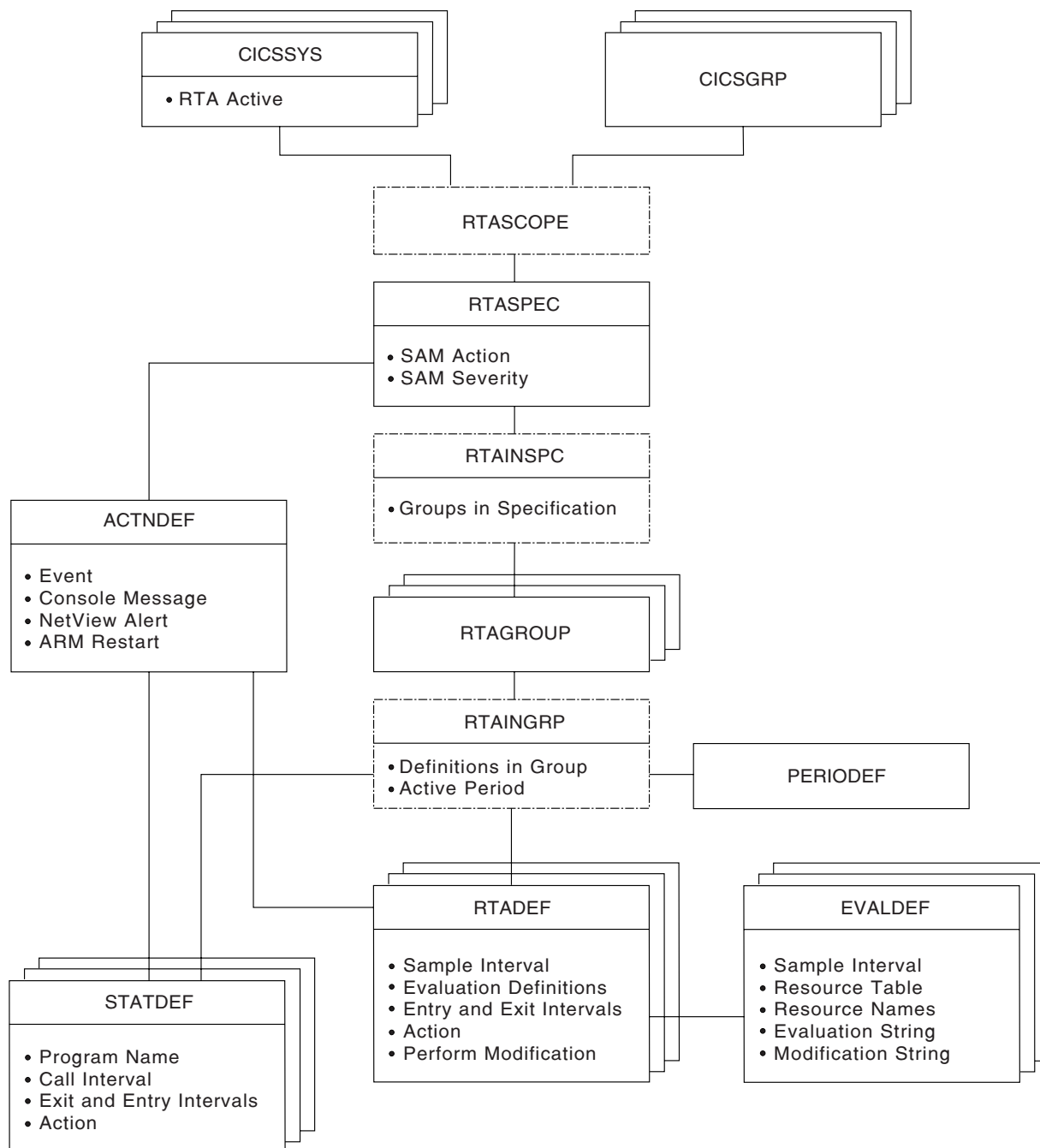

Figure 20. The real-time analysis object model

## Planning for RTA

When you are planning to implement RTA, you might consider the following points:

- You will probably want to use SAM, because not only is it very easy to implement (see “Implementing system availability monitoring (SAM)” on page 83) but you will need to be aware when any of your CICS systems are not active when they should be. You need to:
  - Decide whether you want to customize any of the default conditions



- Identify the primary CMAS for each CICS system
  - To use MRM and APM, you need to identify:
    - The resources you are interested in
    - The point at which their status becomes of interest to you
    - How you want to be notified of an interesting status
    - The interval at which you require resource evaluations
    - The interval at which you require data analysis
    - The primary CMAS
- Note:** For APM only, you may also specify one or more secondary CMASs.

---

## Implementing RTA

Real-time analysis should be implemented gradually and in response to an established need for the resultant information, especially if you are not planning to automate your responses to exception conditions. You are recommended to begin by implementing SAM, and to implement MRM after having analyzed records, such as problem logs, that give you some indication of where MRM would be useful.

## Implementing system availability monitoring (SAM)

You are recommended to implement SAM as follows:

1. Create time-period definitions (PERIODEFs) for the expected availability times of each CICS system to be managed by CICSplex SM. For example, if seven of your CICS systems should be active from 0800 hours through 1900 hours, create one time-period definition for that part of the day.
2. When you define each CICS system to CICSplex SM, supply the name of the time-period definition that defines the system's hours of availability.

These two actions are sufficient to activate SAM and to cause the default external notifications to be generated when a noteworthy condition occurs. As you can see, you can implement SAM as soon as CICSplex SM is installed in your enterprise, and with very little additional effort. You are recommended to continue using SAM with the default notifications, at least until you have had an opportunity to see the default notifications of all SAM conditions. If you decide to customize any of the notifications, start by creating an action definition for one of the SAM conditions and apply it to a single CICS system to test the effects. When you are happy with the change, apply it to other SAM conditions and other CICS systems, as appropriate.

The overheads associated with SAM are not high, so you can activate it throughout the enterprise CICSplexes without affecting the general performance of CICSplex SM or the CICS systems it manages.

## Implementing MAS resource monitoring (MRM)

You should start by implementing MRM on a system-by-system basis. Select a single resource type, such as connections or files, in a single CICS system, and create these CICSplex SM objects:

- An *evaluation definition*, to identify the instances of the resource you are interested in, the frequency with which CICSplex SM is to evaluate the resource status, how CICSplex SM is to interpret its findings, and the severity to be assigned to a true condition

## a recommended approach

- An *analysis definition*, to identify the frequency with which CICSplex SM is to analyze the results and the point at which an external notification should be issued
- An *action definition*, to identify the type of external notification to be issued

The interval between resource evaluations (as specified in the evaluation definition) and the intervals at which data is to be analyzed (as specified in the analysis definition) should be intelligently matched (and ideally the same). In particular, do not analyze the data more frequently than it is evaluated. Also, resource evaluations should be performed as infrequently as possible while still providing useful data: the more frequently data is collected, the greater the cost of its collection.

Begin by installing the analysis definition manually in the active CICS system. When you are satisfied that MAS resource monitoring is working as you expected, consider whether automatic installation of the analysis definition would be useful. If it would, add the analysis definition to an analysis group, and associate the analysis group with an analysis specification. At this point, decide whether to monitor additional resources in the same CICS system. To extend MAS resource monitoring to other resources, an additional evaluation definition would be required, an additional analysis definition might be required, but the original action definition could probably be reused.

## Implementing analysis point monitoring (APM)

When you are happy with the MAS resource monitoring results, progress to analysis point monitoring (APM), which is applied to a logical grouping of CICS systems. You should consider which CICSplexes are affected by your analysis point monitoring requirements, and identify the CMASs involved in management of those CICSplexes. As most of the CICSplex SM definitions required for MAS resource monitoring can be reused for analysis point monitoring, the cost of staging the implementation in this way is not high. For example, a single action definition is likely to be usable by multiple analysis definitions. However, for analysis point monitoring you must create at least one analysis point specification. As in the case of MAS resource monitoring, you should start analysis point monitoring with simple definitions, and move gradually to using more complex definitions.

## A recommended approach

When you decide to implement RTA functions in your enterprise, you should begin by defining the appropriate objects. You should:

- Use the RTADEF view to create an analysis definition.
- Use the EVALDEF and ACTNDEF views to create the required subcomponents of an analysis definition.
- Use the RTAGROUP view to create an analysis group.
- Use the RTASPEC view to create an analysis specification.

Then, to create associations between these objects:

- Use the RTADEF view to add the analysis definition to the analysis group.
- Use the RTAGROUP view to add the analysis group to the analysis specification.

- Use the RTASPEC view to associate the analysis specification with a CICS system or CICS system group.

You can use the MAP action command to display a visual map of the real-time analysis definitions in your data repository. If you want to see a list of the objects and associations you have already defined, use the RTAINGRP, RTAINSPC, and RTASCOPE views.

CICSplex SM includes a *Starter Set* of CICSplex SM object definitions that illustrates the concepts and components introduced in this chapter. The Starter Set is described in detail in Chapter 10, “The CICSplex SM Starter Set” on page 111.

If you have problems defining any particular object or association, refer to the CICSplex SM Starter Set examples. The Starter Set includes many real-time analysis examples that you can use as models for your own objects. You can copy the supplied samples directly into your data repository via the batched repository-update facility. For more information about using the Starter Set as a model and about the batched repository-update facility, see *CICS Transaction Server for OS/390 Installation Guide* and *CICSplex SM Administration*, respectively.

---

## Where next?

Once you have identified your RTA requirements, you should define them to CICSplex SM as described in *CICSplex SM Managing Resource Usage*.

**where next?**

---

## Chapter 8. Collecting statistics using CICSplex SM monitoring

This chapter covers:

- “What is monitoring?”
- “Monitoring of resources” on page 88
- “An interface to NetView RODM” on page 88
- “The monitor interval” on page 88
- “The sample interval” on page 89
- “Managing monitoring functions” on page 89
- “Planning CICSplex SM monitoring” on page 90
- “Implementing CICSplex SM monitoring” on page 92
- “Where next?” on page 95

---

### What is monitoring?

CICSplex SM *monitoring* supports the collection of performance-related data, at user-defined intervals, for named resource instances within a set of CICS systems. At user-defined intervals, monitoring gathers status information and statistics for selected resources, wherever they exist in the CICSplex, and makes them available at any point of control. CICSplex SM gathers information using standard CICS interfaces (EXEC CICS INQUIRE, EXEC CICS COLLECT STATISTICS) and can be used instead of the CICS Monitoring Facility (CMF). If CMF is running, CICSplex SM exploits the information provided. Monitoring need not be specified for resources being overseen by real time analysis (see “Implementing RTA” on page 83), as these are monitored separately.

**Note:** CICSplex SM monitoring is not supported in CICS for OS/2 systems.

### Monitoring functions

The CICSplex SM monitoring functions are:

- Monitoring of resources: see “Monitoring of resources” on page 88
- An interface to NetView RODM: see “An interface to NetView RODM” on page 88
- Monitoring interval: see “The monitor interval” on page 88
- Sampling interval: see “The sample interval” on page 89

### Advantages of monitoring

CICSplex SM monitoring offers the following advantages:

- Summary and detailed information on resources is readily available, enabling you to provide an improved help-desk service.
- System availability and performance are improved by allowing operators to be more effective in investigating problems and seeking out bottlenecks.

---

### Monitoring of resources

CICSplex SM's monitor functions can monitor the performance of these CICS resources at specified intervals:

- CICS systems
- Connections
- DB2 threads
- FEPI connections
- Files and data tables
- CICS journals
- Programs
- Temporary storage
- Terminals
- Transactions
- Transient data queues

The data collected by this monitoring activity is either the type of data that is collected by the CICS command EXEC CICS COLLECT STATISTICS, or is *derived* from such data, that is, CICSplex SM calculates rates, totals, averages, and percentages from the raw statistics data. For local MASs only, CICSplex SM can also obtain some detailed monitoring data via the CICS monitoring facility (CMF).

---

### An interface to NetView RODM

CICSplex SM can supply information about the operational status of CICS resources to the NetView RODM data cache. The NetView operator is able to view such information using the NetView Network Graphical Manager Facility (NGMF), which presents information about resources in a graphical form.

The resource data that CICSplex SM supplies to NetView RODM is obtained via CICSplex SM's monitor functions. That is, you activate monitoring of those CICS resources whose status is to be reported to NetView RODM. CICSplex SM supplies a subset of its monitor data to NetView. In particular, for each resource instance for which RODM data is required, CICSplex SM provides:

- The resource name.
- Information that enables RODM to categorize the state of the resource. This information, which varies depending on the resource type, is described in *CICSplex SM Managing Resource Usage*.
- The status of the resource during the most recent sample interval.

---

### The monitor interval

When you monitor the activity of a particular resource, you are usually interested in its performance over a specific period of time. Therefore, when you define a CICSplex to CICSplex SM (using the CPLEXDEF view described in *CICSplex SM Administration*), you specify a *monitor interval* for the CICSplex. The monitor interval is a period of time, at the end of which counters holding derived monitoring data are reset to zero. For example, if you set the monitor interval to 60 minutes, counters are incremented for 60 minutes, then are reset to zero and the accumulation of monitoring data starts again. This sequence is repeated while monitoring is active. The interval is specified in minutes (15 through 1440), and

defaults to 480 minutes (8 hours). Values derived by CICSplex SM during the monitor interval are prefixed with the letters “MI” in relevant views.

## The sample interval

For each type of resource you monitor (such as files or connections), you specify a *sample interval*. The sample interval governs the frequency with which CICSplex SM collects performance-related data for selected instances of that resource type. For example, you can specify a sample interval of 300 seconds for files used in a particular group of CICS systems. Values derived by CICSplex SM during the latest sample interval are prefixed with the letters “CS” in relevant views. Thus, the CS values allow you to identify rapid rates of change, whereas the MI values are more useful in identifying longer-term trends.

## Managing monitoring functions

The monitoring functions are set up and managed using the objects described in Table 6.

<i>Table 6. Monitoring objects</i>		
<b>Object name</b>	<b>Description</b>	<b>Function</b>
MONACTV	Monitor definitions installed in CICS systems	This object shows information about monitor definitions installed in CICS systems known to the CICSplex identified as the current context.
MONDEF	Monitor definitions	A monitor definition qualifies a resource type identified in a monitor specification by indicating the occurrences of the resource that are to be included in or excluded from monitoring. A monitor definition also identifies which resources are to be reported to RODM when the RODM interface is activated.
MONGROUP	Monitor groups	A monitor group is used to associate one or more related monitor definitions.
MONINGRP	Monitor definitions in monitor groups	This object displays the names of monitor groups, the monitor definitions associated with them, and the time period during which the monitor definitions are to be active.
MONINSPC	Monitor groups in monitor specifications	This object displays the names of monitor specifications and the monitor groups associated with them.
MONSCOPE	Monitor specifications assigned a scope	This object displays information about the CICS systems or CICS system groups that are associated with a monitor specification.
MONSPEC	Monitor specifications	A monitor specification identifies one or more resource types that are to be monitored by CICSplex SM.

The monitoring object model is shown in Figure 21 on page 90.

## planning CICSplex SM monitoring

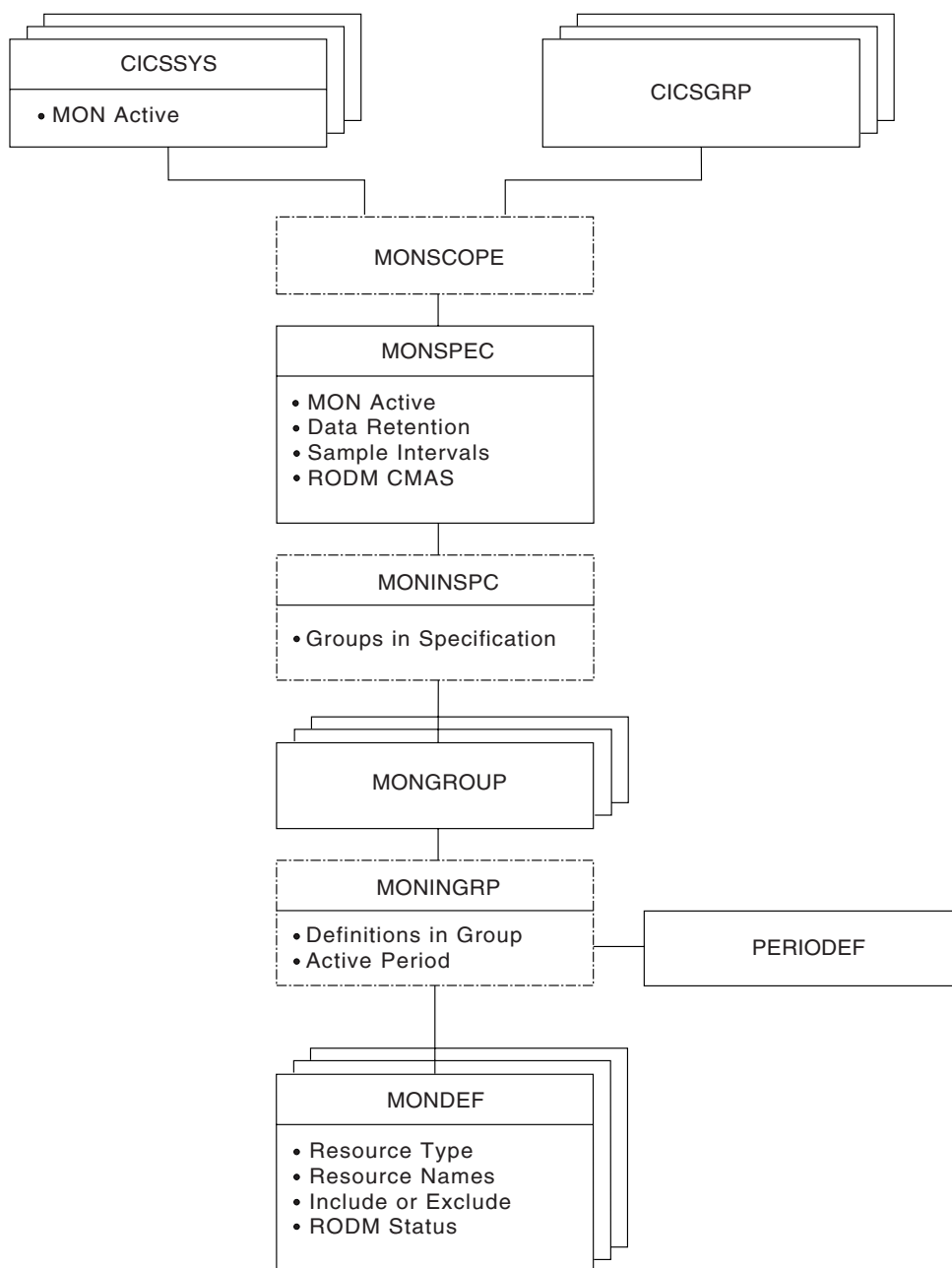

Figure 21. The resource monitoring object model

---

## Planning CICSplex SM monitoring

This section provides some recommendations that will help you plan how to make the best use of CICSplex SM's monitoring functions in your enterprise.

### Always have a use for the monitor data you request

Each resource class with a sample interval greater than zero has a CICS task in each MAS (that is, in each managed CICS system) for which monitoring is required. So, for example, if you activate monitoring of transactions in every CICS system in a CICSplex, each MAS is supporting a CICS task to monitor transactions at the specified interval. Also, remote MASs have to transmit monitor data over an MRO or ISC link, and CMAS processing is required to maintain the monitor-data



cache. You can see that general and unrestricted monitoring would very quickly become an unacceptable overhead. Therefore, do not activate monitoring for any CICS system nor for any CICS resource class without being aware of why you want the data.

### **Identify resources as specifically as possible**

CICSplex SM monitoring is a specialized function that provides detailed usage and performance data. In general, it will be most useful to you for short-term trend analysis, in anticipating future problems, or dealing with actual problems. For example:

- Resources that are limited in quantity can be candidates for monitoring if their use levels are high, because the monitor data will help you to decide whether to increase quantities of the resource.
- Resources for which there is contention are also good candidates. Such data can help you to assess the impact of contention on throughput.

However, you should give some thought to understanding which resources are of greatest interest to you. For example, are you really interested in CICS/ESA supplied resources? Often it's tempting to supply an asterisk (\*) as the resource name, which effectively means any instance of the specified resource. If you really aren't interested in every occurrence, use generic name patterns. For example, you can ask for monitoring of all transactions beginning "PAY" by specifying the resource name "PAY\*." Similarly, resources whose status is being reported to NetView RODM should be identified as fully as possible, so that NetView NGMF displays that are constructed using CICSplex SM-supplied data can be as meaningful as possible.

### **Specify as long a sample interval as you can**

The shorter the sample interval you specify for a resource class, the greater the cost of gathering the monitoring data. For example, if you set the sample interval to one second for every resource, no other CICSplex SM work is going to get done at all. Therefore, always specify the longest possible sample interval at which you can obtain useful data. To determine exactly what this interval should be, you must apply what you already know about any particular resource instance. In general, the sample interval should reflect the probable level of use of the resource: if you find that successive sampling of a resource is not showing significant changes, you should increase the sample interval. The sample interval should also have some relationship to the frequency with which the CICSplex SM or NetView operator will be looking at the monitor data.

### **Specify as long a monitor interval as you can**

The monitor interval determines the frequency with which counters holding accumulated monitor data are reset to zero. You should set it to a value that is significant in your enterprise, so that the information you get from it is also significant. For example, the interval could be a shift duration, or some other time during which a particular workload is being processed.

You are recommended not to make the interval too short, not only because CICSplex SM's overheads grow as the monitor interval

## implementing CICSplex SM monitoring.

reduces, but also because too short an interval is unlikely to provide you with useful statistics.

### **Do not define more monitor specifications than you really need**

Avoid having too many monitor specifications, not only because of the extra work involved in creating them and associating them with CICS systems, but also because a CICS system can belong to only one monitor specification at a time. The more monitor specifications you define, the smaller the opportunity for establishing a general-purpose monitoring policy.

### **Specify a suitable retention period**

You don't have to specify a retention period. However, the retention period defaults to zero minutes, and so as soon as monitoring stops for any CICS system, that system's monitor data is lost. If some unexpected event occurs, the data could be invaluable, so setting the retention period greater than zero is advisable. Note, however, that if a CICS system stops, monitor data is lost when you restart the system regardless of any retention period you may have specified. In this case, it's important to look at the monitor data before you restart the CICS system.

You can set the retention period to any value between 1 and 1440 minutes (24 hours). You can specify a retention period on the monitor specification, in which case that period applies to every CICS system associated with the monitor specification. Alternatively, you can specify a retention period in the CICSplex SM CICS system definition.

### **Decide when to activate monitor definitions**

When you add a monitor definition to a monitor group, you can specify the part of the day during which it is to be active. You should make considered use of this feature. For example, you probably will not want monitoring active overnight, or during any period when general use is low and no one is around to view the data, so ensure that monitor definitions are not in effect at those times. Also, if you're monitoring resources for which there is contention, think about when this contention occurs. Is it constant, or does it occur only between 0900 and 1100 hours? If the latter, limit your monitoring to that period.

---

## Implementing CICSplex SM monitoring

Possibly the best way to implement CICSplex SM monitoring is to start with no monitoring at all, and to implement it piecemeal for particular CICS systems and CICS resource instances. That is:

1. Create a monitor specification, and associate it with every CICS system in the CICSplex. However, ensure that every sample interval remains at its default value of zero, and that monitor status remains set to "OFF". This is because the one thing you must have in place before you can gather any monitoring data is a monitor specification. If you follow these instructions, monitoring will be enabled, but not *activated*.
2. When you decide to monitor a particular resource instance, as used by one of the CICS systems in the CICSplex, you must:
  - a. Update the CICS system definition to switch monitoring on, and to specify a sample interval for the resource. You make this change to an active CICS

system (using the TOPOLOGY MAS view), and it applies for the current execution of the CICS system only.

- b. Create a monitor definition to name the resource instance, and install it manually in the CICS system.
3. Repeat this piecemeal approach to monitoring until it becomes apparent that you have some regular requirements. At that point, consider installing the monitor definitions automatically (and for every execution of the CICS system) by adding the monitor definitions to a monitor group, and associating the monitor group with the monitor specification. You can make the sample interval and monitor status permanent by setting them either in the monitor specification—in which case, they apply to all CICS systems associated with the monitor specification and for which an appropriate monitor definition has been provided—or in the CICS system definition, in which case they affect no other CICS system.

You can refine your approach to monitoring gradually, by creating additional monitor specifications for the CICSplex, for example, and by using timed monitor definitions, which are installed automatically for a specified duration. Remember that:

- Although you can make changes to a monitor specification while it is in use, the effect of those changes is not felt until the CICS system is next started. Note, however, that you can use the MAS view to change monitoring values for an active CICS system.
- A CICS system can be associated with only one monitor specification at a time.
- You can associate a monitor specification with a CICS system that is already running, but the effect of that new association is not felt until the CICS system is next started.

Aim to ensure that any monitor specifications and monitor definitions you provide support the normal situation, and that CICS system overrides are used for the exceptions.

## Activating the interface to NetView RODM

To activate the interface between CICSplex SM and RODM, you must:

- Update the CICSplex SM CMAS definition to identify the RODM subsystem with which the CMAS is to communicate. The CMAS must be on the same MVS image as the NetView instance.
- Update the CICSplex SM definitions of those CICSplexes whose resources are to be reported to RODM.
- Update or create monitor definitions to set the RODM Status flag to YES and to identify resource instances.
- Update or create monitor specifications to set the sample interval for each resource type and to identify the CMAS communicating with RODM.

Instructions for all of these tasks are provided in *CICSplex SM Administration*.

## a recommended approach

### Using the CICS Monitoring Facility (CMF)

Some classes of monitoring data—in particular, the detailed task-related data that is displayed in the TASKD and MLOCTRAD views—cannot be collected unless CICS performance class data monitoring is active in the monitored CICS system. You can activate performance class data monitoring for an active system using the CICSplex SM operations functions or the CEMT SET MONITOR transaction. Alternatively, you can activate performance class data monitoring permanently via CICS SIT parameters. Note that performance class data cannot be gathered for remote MASs.

CMF data is usually written to an SMF data set. However, if you prefer, you can collect CMF data for use by CICSplex SM without having it written to an SMF data set.

More information about the CICS SIT parameters and about suppressing the output of CMF data to an SMF data set is provided in *CICS Transaction Server for OS/390 Installation Guide*. For more information about CMF, see the *CICS/ESA Performance Guide*.

### A recommended approach

When you decide to implement MON functions in your enterprise, you should begin by defining the appropriate objects. You should:

- Use the MONDEF view to create an analysis definition.
- Use the MONGROUP view to create an analysis group.
- Use the MONSPEC view to create an analysis specification.

Then, to create associations between these objects:

- Use the MONDEF view to add the analysis definition to the analysis group.
- Use the MONGROUP view to add the analysis group to the analysis specification.
- Use the MONSPEC view to associate the analysis specification with a CICS system or CICS system group.

You can use the MAP action command to display a visual map of the MON definitions in your data repository. If you want to see a list of the objects and associations you have already defined, use the MONINGRP, MONINSPC, and MONSCOPE views.

CICSplex SM includes a *Starter Set* of CICSplex SM object definitions that illustrates the concepts and components introduced in this chapter. The Starter Set is described in detail in Chapter 10, “The CICSplex SM Starter Set” on page 111.

If you have problems defining any particular object or association, refer to the CICSplex SM Starter Set examples. The Starter Set includes many resource monitoring examples that you can use as models for your own objects. You can copy the supplied samples directly into your data repository via the batched repository-update facility. For more information about using the Starter Set as a model and about the batched repository-update facility, see *CICS Transaction Server for OS/390 Installation Guide* and *CICSplex SM Administration*, respectively.

---

## Where next?

Once you have identified your monitoring requirements, you should define them to CICSplex SM as described in *CICSplex SM Managing Resource Usage*.

**where next?**

---

## Chapter 9. Planning CICSplex SM installation and setup

This chapter provides information to help you to prepare for the installation of CICSplex SM in your existing MVS/ESA, VSE/ESA, and CICS for OS/2 environments. In particular, it describes:

- “Software, hardware, and storage requirements”
- “The CICSplex SM product documentation” on page 100
- “CICSplex SM naming conventions” on page 100
- “Security planning” on page 102
- “Defining time zones” on page 103
- “An overview of the installation process” on page 104
- “Preparing to set up a CAS” on page 105
- “Preparing to set up a CMAS” on page 106
- “Preparing to set up a MAS” on page 107
- “Reuse of CICSplex SM object definitions” on page 108
- “Where next?” on page 109

Instructions on installing CICSplex SM are given in *CICS Transaction Server for OS/390 Installation Guide*.

---

### Software, hardware, and storage requirements

This information is provided so that your enterprise can prepare an environment in which CICSplex SM can be successfully installed and operated. Note that this information is provided for guidance only, and that the *CICS Transaction Server for OS/390 Program Directory* provides the most up-to-date information.

### Prerequisite software release levels

The following products are either required in the environments in which CICSplex SM is installed, or may be installed in support of specific CICSplex SM functions but are not mandatory.

*Release levels are minimum levels only: later levels (if any) can be used.*

- CICS Transaction Server for OS/390 Version 1 Release 1 or later
- ACF/VTAM Version 3 Release 4 Modification 1 is required with CICS/ESA 4.1
- CICS/ESA Version 4 Release 1 or later
- CICS/ESA Version 4 Release 1 is required in the terminal-owning region (TOR) if the goal algorithm is to be used for workload management
- CICS for OS/2 Version 3 can be managed by CICSplex SM
- CICS/VSE Version 2.3 or later can be managed by CICSplex SM
- CICS Transaction Affinities Utility MVS/ESA Release 1 can be used if you need assistance in identifying intertransaction affinities
- ISPF Version 3 Release 3 is required to support the CICSplex SM end-user interface
- MVS/DFP Version 3 Release 1 is required
- MVS/ESA:

## software, hardware, and storage requirements

- MVS/ESA Version 5 Release 1 is required if the goal algorithm is to be used for WLM
- MVS/ESA Version 5 Release 2 is required if the MVS/ESA automatic restart manager (ARM) function is required
- NetView:
  - CICSPlex SM can send generic alerts to NetView Version 2 Release 3, or later
  - NetView Version 2 Release 4 is required if the interface between CICSPlex SM and the NetView Resource Object Data Manager (RODM) (RODM) is to be used
  - NetView MultiSystem Manager (MSM) Version 2 Release 1 is required if the interface between CICSPlex SM and RODM is to be used
- RACF Version 2 Release 1 or equivalent external security manager is required
- TSO/E Version 2 Release 1 is required for support of ISPF

The CICSPlex SM application programming interface (API) can be used in applications written in the following languages:

- Assembler
- PL/I
- COBOL
- C
- REXX (MVS Batch, TSO, and NetView)

## Prerequisite hardware

CICSPlex SM runs on any ESA/390-capable or ESA/370-capable processor.

CICS for VSE/ESA managed systems are supported on processors running VSE/ESA 1.4 (or later).

CICS Transaction Server for VSE/ESA managed systems are supported on processors running VSE/ESA 2.4.

Single-user and multi-user CICS for OS/2 managed systems are supported on workstations running OS/2 Version 2 or OS/2 WARP.

## Storage requirements

Table 7 shows minimum storage requirements for CICSPlex SM on an MVS image on which a CMAS and one or more MASs are defined. Table 8 on page 100 shows minimum storage requirements for CICSPlex SM on an MVS image on which one or more remote MASs only are defined.

<i>Table 7 (Page 1 of 2). Storage requirements for target libraries for CMAS and local MAS</i>						
<b>Library name</b>	<b>DSORG</b>	<b>RECFM</b>	<b>LRECL</b>	<b>Block Size</b>	<b>No. of blocks</b>	<b>No. of DIR blocks</b>
SEYUCMOD	PO	U	0	6144	630	92
SEYUINST	PO	FB	80	6160	87	6



<i>Table 7 (Page 2 of 2). Storage requirements for target libraries for CMAS and local MAS</i>						
<b>Library name</b>	<b>DSORG</b>	<b>RECFM</b>	<b>LRECL</b>	<b>Block Size</b>	<b>No. of blocks</b>	<b>No. of DIR blocks</b>
SEYUADEF	PO	FB	80	6160	207	32
SEYUCLIB	PO	FB	80	6160	87	4
SEYUMLIB	PO	FB	80	6160	37	8
SEYUPLIB	PO	FB	80	6160	415	49
SEYUTLIB	PO	FB	80	6160	14	1
SEYUVDEF	PO	FB	80	6160	798	78
SEYUSAMP	PO	FB	80	6160	33	7
SEYUPARM	PO	FB	80	6160	6	2
SEYUMAC	PO	FB	80	6160	204	24
SEYUPROC	PO	FB	80	6160	6	1
SEYUC370	PO	FB	80	6160	216	24
SEYUCOB	PO	FB	80	6160	264	24
SEYUPL1	PO	FB	80	6160	264	24
SEYUOS2	PO	FB	80	6160	1200	20
SEYUJCL	PO	FB	80	6160	96	18
SEYUDEF	PO	FB	80	6160	117	10
SEYULINK	PO	U	0	6144	6	1
SEYUAUTH	PO	U	0	6144	3831	143
SEYULOAD	PO	U	0	6144	1890	15
SEYULPA	PO	U	0	6144	0	0

## CICSplex SM naming conventions

*Table 8. Storage requirements for target libraries for remote MVS MAS*

Library name	DSORG	RECFM	LRECL	Block Size	No. of blocks	No. of DIR blocks
SEYUINST	PO	FB	80	6160	87	6
SEYUSAMP	PO	FB	80	6160	12	4
SEYUPARM	PO	FB	80	6160	3	1
SEYUMAC	PO	FB	80	6160	192	22
SEYUJCL	PO	FB	80	6160	96	18
SEYUDEF	PO	FB	80	6160	117	10
SEYUC370	PO	FB	80	6160	198	21
SEYUCOB	PO	FB	80	6160	250	21
SEYUPLI	PO	FB	80	6160	250	21
SEYUOS2	PO	FB	80	6160	1200	20
SEYUAUTH	PO	U	0	6144	219	2
SEYULOAD	PO	U	0	6144	1860	14
SEYULPA	PO	U	0	6144	0	0

CICS/VSE remote MASs require 5100 blocks in a library whose block size is 1024 bytes.

### **Workstation storage requirements for CICS for OS/2**

You will require suitable hardware for running CICS for OS/2 Version 3, or later release if required.

---

## **The CICSplex SM product documentation**

In addition to the supplied *CICS Transaction Server for OS/390 Program Directory*, which contains detailed installation instructions, the CICSplex SM library contains several publications to help you with the setup and day-to-day administration of CICSplex SM. For details of these and other related publications, together with their order numbers, see page xiii.

With the exception of the *CICSplex SM View Commands Reference Summary*, all CICSplex SM publications are available as on-line books, for use with the BookManager/READ products, on the CD-ROM *Transaction Processing and Data*, SK2T-0730.

---

## **CICSplex SM naming conventions**

For its configuration and for its operation, CICSplex SM requires a variety of entities to be defined. You must devise a convention for naming those entities that is both meaningful and extendable.

The rules governing the naming of CICSplex SM elements are as follows:

- Each element name can be up to 8 characters.
- The element name must begin with an alphabetic (or national) character, and must have no embedded blanks. Subsequent characters can be alphabetic or numeric.
- Names of CICSplexes and of CMASs must be unique within the enterprise.
- Names of CICS systems and CICS system groups must be unique within the CICSplex.
- All other names must be unique for their type within the CICSplex.

The entity types, for each instance of which a name is required, are:

- CICSplex SM components and CICSplex entities
  - CAS, CMAS, CICSplex, MAS (CICS system), CICS system group, and time-period definition.
- BAS entities
  - Resource assignments, resource descriptions, resource definitions, and resource groups.

Application resource definitions are:

- DB2 transactions, files, map sets, OS/2 file key segments, partition sets, programs, transient data queues, transactions, CICS BTS process types, document templates, FEPI nodes, FEPI pools, FEPI property sets, FEPI targets, file and key file segment definitions, IIOPI request models, map sets, sysplex enqueue models, TCP/IP services, temporary storage models

Region resource definitions are:

- DB2 entries, journals, journal models (CICS Transaction Server for OS/390 Version 1 or later), local shared resource (LSR) pools, profiles, temporary storage queue models, transaction classes, terminals, typeterms

System–system connectivity resource definitions are:

- Connections, DB2 connections, partners, sessions

- Monitor entities
  - Monitor definition, monitor group, and monitor specification
- Analysis entities
  - Analysis definition, analysis group, analysis point specification, analysis specification, action definition, evaluation definition, and status definition
- Workload management entities
  - Transaction group, workload definition, workload group, and workload specification.

Ensure that any convention you select can accommodate all of these entity types. A naming convention, for use generally in CICS environments, is described in the CICS/ESA publication *Dynamic Transaction Routing in a CICSplex*. For an example, see “The Starter Set naming convention” on page 139.

### Generic names

CICSplex SM supports the use of generic names in many of its commands. For example, you can specify that all transactions whose names begin with the letters “DNW” are to be monitored once every 300 seconds. You do not have to name each transaction individually.

The rules governing use of generic names are as follows:

- The asterisk character (\*) can be used in place of one or more characters. It can appear once only in any name, and must appear at the end of any partial string. For example, the string “DNW\*” means all names beginning with the letters DNW.
- The plus sign (+) can replace any single character and can occur in any position in the name. For example, “DNW+++L” means any name of 7 characters starting with the letters DNW and ending with the letter L.

---

### Security planning

CICSplex SM uses a SAF-compliant external security manager, such as RACF:

- To prevent unauthorized access to CICSplex SM functions and CICS resources
- To control the simulation of CICS command checking and CICS resource checking

In both cases, security checking is handled by the CMASs managing the CICS systems that are the target of any request to access a resource. For example, if a CICSplex is managed by two CMASs, and a request is made to access a resource in all CICS systems belonging to that CICSplex, the security check is performed in both CMASs.

To activate security checking, you must modify the JCL used to start the CMAS or its managed CICS systems. If security checking is switched off for the CICS system, no checking occurs, regardless of the CMAS setting. However, if security checking is switched off for the CMAS but switched on for the CICS system, the CICS system is not able to connect to the CMAS.

You should begin by deciding how much security checking you need. In particular, identify those users who need access to CICSplex SM, and ensure that an individual user has the same user ID across all systems on which a CMAS is installed. The user ID against which the security check is performed is the signed-on TSO user ID. Consider also the type of security checking you want to implement.

### Protecting access to CICSplex SM functions and CICS resources

To prevent unauthorized access, you create security profiles for combinations of CICSplex SM functions and CICS resources that are to be protected. A table of valid combinations is provided in *CICS RACF Security Guide*.

In most cases, the security provided by these CICSplex SM security profiles is adequate.

An external security manager should also be used to protect CICSplex SM's own libraries and procedures. Full details of how to protect CICSplex SM's libraries and procedures are provided in *CICS RACF Security Guide*.

## Special considerations for BAS

You should be aware of the need to take special care in the protection of the BAS views, so that unauthorized users cannot create and administer resources. The equivalent in RDO terms is leaving your CSD unprotected.

You should also take care if you are using the EXEC CICS CREATE command to build new resources. Any definition created with the CICSplex as the context is automatically distributed to all CMASs in the CICSplex. Therefore, giving a user authority to create BAS objects is equivalent to giving authority to install resources on any CICS system in the CICSplex. When the CICS system starts, there is no check on who installed the resource in the system.

## CICS command and resource checking

CICS/ESA command and resource checking is simulated by CICSplex SM in the CMASs to which a request is directed. This allows you to protect CICS systems that do not support your external security manager. It also allows for a level of consolidation of your security checking. Determine where CICS resource and command checking is in effect, and decide whether it needs to be retained along with CICSplex SM's other security checking.

---

## Defining time zones

Much of CICSplex SM's activity is time dependent. For example, you can specify that a monitor definition or an analysis definition is to be active during a particular time period. CICSplex SM does not require every MAS in a single CICSplex to be running in the same time zone, and so must be able to accommodate any time-zone differences between entities. Therefore:

- Whenever you create a time-period definition (using the CICSplex SM PERIODEF view), you must specify a time zone in the definition. For example, you could create a time-period definition called "MORNING" for the hours 0800 through 1159 *Eastern standard time*.
- You must specify a time zone for each CMAS in its data-repository initialization job, EYU9XDUT. A permanent change to the CMAS time-zone value can be made, even while the CMAS is running, via the CICSplex SM user interface.
- A time zone must be established for each managed CICS system. When you define a CICS system to CICSplex SM, you can specify the time zone in which the system is running. Alternatively, if you don't specify a time zone in the CICS system definition, the CICS system is assumed to be running in the time zone that is the default for the CMAS to which it connects. You are recommended to allow the time zone of a managed CICS system to default to that of its CMAS. The time zone of a managed CICS system can be altered subsequently while the CICS system is running. Any change made in this way lasts for the lifetime of the CICS system, or until it is next changed, whichever is sooner.
- A time zone must be specified for every CICSplex when it is first defined. This time zone is used by the CICSplex SM monitor function to determine the

## an overview of the installation process

actual time at which the monitor interval for the CICSplex expires. The CICSplex time zone can be altered via the CICSplex SM end-user interface.

Time zones are specified using single-character codes in the range B through Z. For example, code “S” represents Mountain Standard Time, code “T” represents Central Standard Time, and code “C” represents Eastern Europe time. A complete list of the codes can be found in *CICSplex SM Administration*. CICSplex SM allows offsets (known as “time zone adjustments”) in the range 0 through 59 minutes to be specified to accommodate regions that are not running in the standard time zones. Also, daylight saving time can be specified.

Because multiple CICSplex SM entities require a time zone to be specified, there is obvious potential for “conflicting” time-zones to be specified. For example, it is quite possible that a CMAS and a MAS in the same CICSplex could be in different time zones. CICSplex SM always honors the time zone of the MAS. For example, if:

- The time-period definition time zone is S

and

- The CMAS time zone is B

and

- The MAS time zone is C

time zone C is used by the MAS, and the CMAS makes any necessary adjustments between time zones B, C, and S to ensure that the time zone is honored.

---

## An overview of the installation process

For information about installation see, in the first instance, *CICS Transaction Server for OS/390 Program Directory*. For information about post-installation and IVPs see *CICS Transaction Server for OS/390 Installation Guide*.

### Installing remote MAS code

#### Under VSE/ESA

You are recommended to install the CICSplex SM VSE agent code using the VSE dialogs, as described in the *VSE Installation and Service* book. Alternatively, you can use the VSE Maintain System History Program (MSHP).

#### Under OS/2

You install the CICSplex SM OS/2 Feature using IBM Software Installer for OS/2 (Software Installer/2), which is supplied with the CICSplex SM product code. You begin by downloading Software Installer/2 from MVS/ESA to the workstation, then use it to install the CICSplex SM agent code under CICS for OS/2. Instructions are provided in *CICS Transaction Server for OS/390 Installation Guide*.

---

## Preparing to set up a CAS

To set up a CAS, you need to:

### Decide how to start the CAS

The installation process for CICSplex SM creates some skeleton start-up JCL that can be used to create and initialize the CAS. Each CAS requires a unique, four-character subsystem ID that must be included in the CAS start-up JCL.

A CAS can be started:

- At MVS IPL time
- From the system console
- As a batch job

Although you have this choice, you are strongly recommended to start each CAS in your enterprise at MVS IPL time, because it avoids the sequencing problems that occur when components are started in an unexpected order. Also, you should consider CICSplex SM to be an essential part of your environment, much as VTAM and JES are considered today.

### Provide CAS VTAM definitions

If your system “map” shows more than one CAS, you need to define some links between those CASs. For this, each CAS must have a VTAM application definition. Also, each CAS can be defined as a cross-domain resource, which allows it to be referenced across a link. Details of these requirements can be found in *CICS Transaction Server for OS/390 Installation Guide*

### Decide how the CICSplex SM EUI is to be accessed

There are two ways of starting the CICSplex SM EUI:

1. You can start CICSplex SM as an application from an ISPF menu, which requires you to make some permanent changes to your existing ISPF environment. In particular, you must add some CICSplex SM libraries to the signon procedure, and update an appropriate ISPF menu to include CICSplex SM as an option. This is the recommended way of starting CICSplex SM.
2. You can start CICSplex SM from the TSO READY prompt by running the sample REXX EXEC that was created by the installation process. This requires no permanent changes to the current environment, but is a less efficient way of starting CICSplex SM. One reason for this relative inefficiency is that the current dataset allocation has to be saved, the required CICSplex SM libraries must be allocated, and the original data set allocation must be restored when the user has finished using CICSplex SM. This approach is not recommended for regular use of CICSplex SM, though it is a useful installation aid.

---

### Preparing to set up a CMAS

The CMAS, which is a CICS/ESA 4.1 (or later) system, provides most of the functions of CICSplex SM. To set up a CMAS, you need to:

#### **Add CICS resource definitions for the CMAS**

Because the CMAS is a CICS system, it requires resource definitions to be created. These definitions are provided with CICSplex SM and can be applied using the resource definition utility, DFHCSDUP. The resources include:

- CICSplex SM resource groups
- A file definition for the data repository
- CMAS program definitions
- CMAS transaction definitions
- CMAS group list
- DCT definitions for EYUPARM and EYULOG
- JCT entry for CMAS journal records

No tailoring of these resources is required or expected. However, you are required to make some changes to the tables DFHDCT, DFHPLT, DFHSRT, and DFHJCT. These changes are detailed in *CICSplex SM Managing Workloads*.

#### **Define common data spaces**

In each MVS/ESA environment in which a CMAS is to be installed, a minimum of five common data spaces (and a maximum of 45) is required. You are recommended to begin by defining 10 common data spaces, and to add more if necessary. Also, module EYU9XESS, which establishes the ESSS subsystem, must be in the link list.

#### **Provide CMAS VTAM definitions**

If you are defining multiple CMASs, CMAS-to-CMAS links require each CMAS to have a VTAM application definition.

Full details of necessary changes to the MVS/ESA and VTAM environments are provided in *CICS Transaction Server for OS/390 Installation Guide*.

#### **Create the CMAS data repository**

Each CMAS requires a data repository, which can be created using the sample JCL created during the installation process. The data repository must be initialized before it can be used.

#### **Decide how to start the CMAS**

Like the CAS, the CMAS can be started at MVS IPL time, as a started task, or as a batch job. You are recommended to start the CMAS at MVS IPL time, so that it is part of the MVS/ESA start-up procedure and treated as a permanent part of the environment. This is much more efficient than starting and stopping the CMAS throughout the day. It also ensures that the CMAS is active before any MAS attempts to connect to it. A sample start-up procedure for the CMAS is generated during the installation process.



## Using the batched repository-update facility

CICSplex SM supplies a batched repository-update facility that you can use to make bulk changes to a CMAS's data repository. As input to this facility, which is invoked from the CICSplex SM BATCHREP view, you supply a sequential data set of commands that are to be applied to the data repository. Valid commands are:

CONTEXT	which identifies whether subsequent commands relate to the CMAS whose repository is being updated, or to a CICSplex that it maintains.
CREATE	which adds a new record to the data repository.
UPDATE	which alters an existing record in the data repository.
REMOVE	which deletes an existing record from the data repository.
LIST	which creates a list of all records in the data repository.
DUMP	which creates a list of all records in the data repository and prefaces each entry in the list with a Create command. The output from the Dump command can therefore be used as input to a different CMAS data repository.
MAPLEFT	which displays a map of definitions in the data repository to the left of the starting point.
MAPRIGHT	which displays a map of definitions in the data repository to the right of the starting point.

For example, a typical command file for input to the batched repository-update facility would contain a Context command, followed by multiple Create commands. An example command file is supplied with the CICSplex SM Starter Set. Detailed information about the batched repository-update facility is supplied in *CICSplex SM Administration*.

---

## Preparing to set up a MAS

This section introduces the actions you need to undertake when you set up a MAS. Full details are given in *CICS Transaction Server for OS/390 Installation Guide*. You need to:

### Define CICSplex SM's resources to the CMAS

The CICSplex SM code, for MASs and remote MASs, is a CICS application, so you must define CICSplex SM's resources to the managed CICS system. Resource definitions, and instructions for their application, are supplied for all CICS environments (CICS Transaction Server for OS/390, CICS/ESA, CICS Transaction Server for VSE/ESA, CICS/VSE, and CICS for OS/2).

### Define the CICS system to CICSplex SM

Use the CICSSYS view.

### Modify the MAS's startup JCL

The startup JCL (JCS for CICS/VSE systems; CICSENV.COMD for CICS for OS/2 systems) must refer to the appropriate CICSplex SM data sets and include the required CICS SIT parameters are included.

### Ensure that the CMAS is started before the MAS

If the MAS is active before the CMAS, the MAS-attach process waits until the CMAS is started. This means that no CICSplex SM function is

## reuse of CICSplex SM object definitions

available to the CICS system until the CMAS is available. (However, CICSplex SM's WLM functions are available in these circumstances if the workload has been activated.) Delays in the MAS-attach process do not affect the functions of the CICS system itself.

## Preparing a remote MAS

For remote MASs only, some additional preparation is required to enable communication between the remote MAS and the CMAS to which it connects:

- Review the remote MAS's VTAM definitions (or Communication Manager/2 definitions in the CICS for OS/2 environment), and update them if necessary.
- Add connection and session definitions for the target CMAS to the remote MAS's CSD.
- Create a CICSplex SM link definition using the CMTPMDEF view.

Instructions for all environments are provided in *CICS Transaction Server for OS/390 Installation Guide*.

---

## Reuse of CICSplex SM object definitions

CICS does not provide identical support for resources and functions across all of its platforms or releases. For example, a resource, such as FEPI, that is supported in the CICS/ESA environment might not be supported on other platforms, such as CICS/VSE. Similarly, the amount or type of data available for a resource can vary among CICS platforms and releases. For example, monitor data is not available for any CICS for OS/2 resource. These variations in support pose a special challenge to CICSplex SM, which offers a SSI of multiple and varied CICS systems.

Here are some examples that illustrate how CICSplex SM handles variations in support for resources and functions throughout a CICSplex that includes CICS/ESA, CICS/VSE, and CICS for OS/2 systems.

- **Example 1: monitoring of transient data queues**

You create a monitor definition for transient data queues, add it to a monitor group, and associate the monitor group with a monitor specification. The scope of the monitor specification is every CICS system in the CICSplex. As each CICS system starts, CICSplex SM determines whether it can install the monitor definition in that system. It cannot install the monitor definition in CICS for OS/2 systems, because the monitor function isn't supported in that environment. Instead, CICSplex SM issues a message to inform you that the monitor definition could not be installed. Both the monitor function and transient data queue resources are supported under CICS/ESA and CICS/VSE, so CICSplex SM installs the monitor definition in those environments and monitoring begins.

- **Example 2: RTA of monitored programs**

You create an evaluation definition and name MPROGRAM (monitored programs) as the resource to be evaluated by CICSplex SM's RTA function. The evaluation definition is named in an analysis definition, which is linked, via an analysis group, to an analysis specification. The scope of the analysis specification is every CICS system in the CICSplex. As in example 1, CICSplex SM cannot install the definition in the CICS for OS/2 systems, because monitored resources are not supported in that environment. Instead,

CICSplex SM issues a message to inform you that the analysis definition could not be installed. The analysis definition is installed in the CICS/ESA and CICS/VSE systems. If an analysis definition names multiple evaluation definitions, CICSplex SM installs those that are supported in the target environment.

- **Example 3: reporting transaction status to NetView RODM.**

You create a monitor definition for transactions, and set the RODM Status field to YES so that the NetView RODM database will be populated with status information about transactions. RODM is supported in all managed CICS systems, so CICSplex SM is able to install the monitor definition throughout the CICSplex. Note that, if a single monitor definition requests both RODM and CICSplex SM monitoring of a resource in the CICS for OS/2 environment, CICSplex SM honors the RODM request: CICSplex SM does not reject the whole monitor definition, but issues a message to inform you that monitoring is not supported.

In summary, if you request a function that isn't available in a particular CICS environment, CICSplex SM issues a warning message. You do not have to respond to the message and, more importantly, you do not have to take variations in support into account when creating CICSplex SM object definitions: you should always consider CICSplex SM object definitions to be reusable.

---

## Where next?

At this point, you are ready to install CICSplex SM and run the JCL to install your CASs, CMASs, and MASs. You now need to define the objects that will allow these entities to communicate with CICSplex SM and each other. *CICSplex SM Administration* gives you guidance on defining the CICSplex SM configuration and topology.



---

## Chapter 10. The CICSplex SM Starter Set

The CICSplex SM Starter Set is primarily a set of samples—sample JCL, sample CICSplex SM topology definitions, and sample specifications for business application services, workload management, real-time analysis, and monitoring—based on an authentic configuration of nine CICS regions across three MVS/ESA images. This chapter covers:

- “Why is the Starter Set provided?”
- “The Starter Set configuration”
- “CICSplex SM definitions supplied with the Starter Set” on page 114
- “The Starter Set naming convention” on page 139

---

### Why is the Starter Set provided?

The CICSplex SM Starter Set is provided to give you:

- Samples (of both CICSplex SM definitions and JCL) that you can copy and adapt for your own environment. For example, there are more than 100 monitoring and RTA samples that you can use as a basis for your own definitions.
- An understanding of what’s involved in setting up a CICSplex SM configuration.
- An opportunity to use the batched repository-update facility with sample data.
- A system that will allow you to familiarize yourself with the CICSplex SM user interface before you start to use it in earnest.
- A system on which you can learn how CICSplex SM is used as a system-management tool.

It is not intended that you should use the Starter Set as an initial configuration to build on by replacing its data with your own. There is nothing to stop you doing this, of course, but, as the Starter Set configuration is unlikely to resemble your own to any significant extent, the benefits would be few. Also, if you update the Starter Set definitions with your own data, you will effectively lose the Starter Set. New users of CICSplex SM would not have the opportunity to learn from the Starter Set, and examples from the Starter Set, which are used throughout the CICSplex SM documentation, would be less valid. Therefore, you are recommended to retain the Starter Set as a separate, sample configuration to which you can refer at any time, but to copy anything (such as JCL or CICSplex SM definitions) that you want to adapt for local use.

---

### The Starter Set configuration

The Starter Set contains examples of configuration relationships and of BAS, WLM, RTA, and monitoring specifications and definitions. You can use these examples to model your own definitions.

## the Starter Set configuration

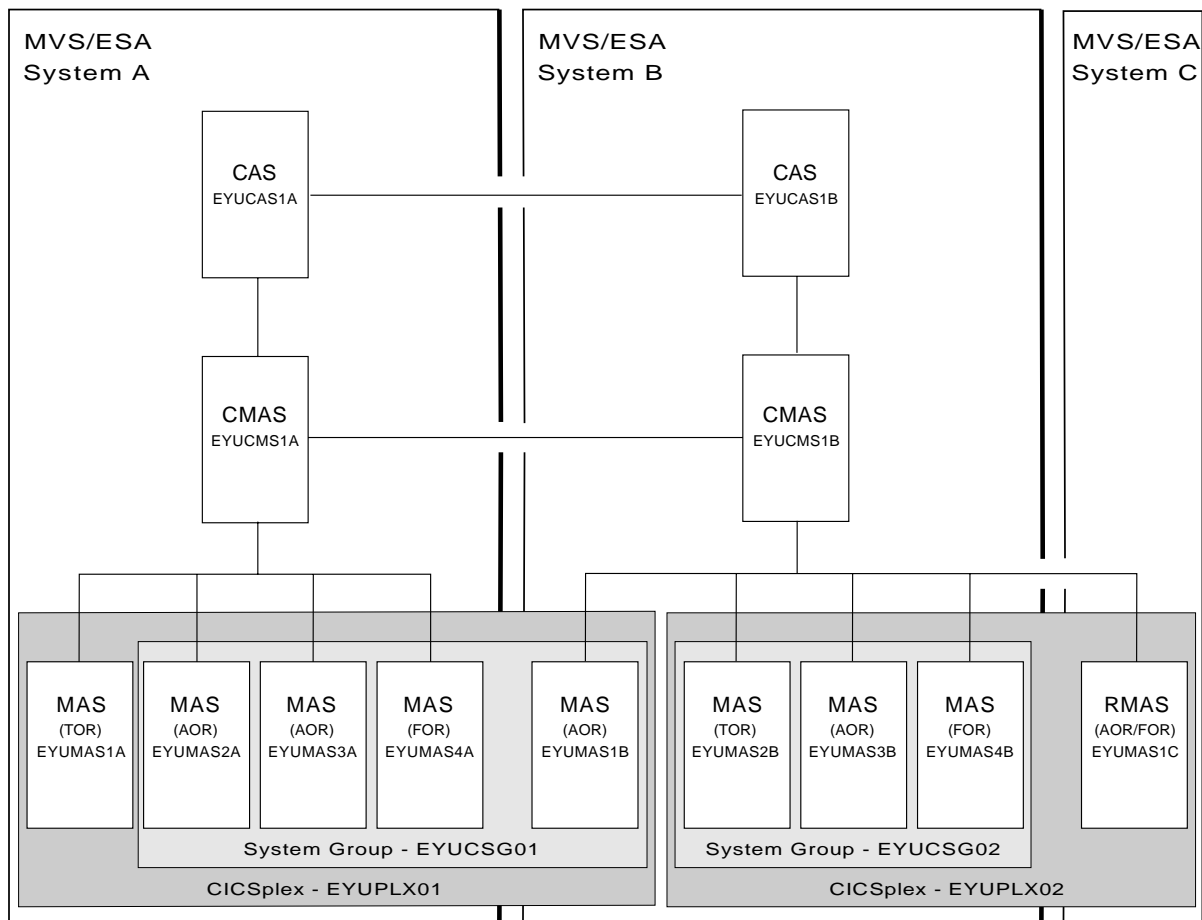

Figure 22. The Starter Set configuration. The Starter Set provides a small but comprehensive set of CICSplex SM components on which you can model your own CICSplex SM environment.

Figure 22 shows the main components of the CICSplex SM Starter Set configuration, which consists of:

- Two CICSplexes, EYUPLX01 and EYUPLX02, which straddle three MVS images. Neither CICSplex is confined to a single MVS image. The Starter Set has two CICSplexes rather than one because a configuration of multiple CICSplexes allows all of CICSplex SM's features to be demonstrated.
- Two CASs, one on system A and one on system B. Either CAS can function as a single point of control for all of the Starter Set MASs and their resources.
- Two CMASs, one on system A and one on system B. EYUCMS1A is the maintenance point CMAS for EYUPLX01, and EYUCMS1B is the maintenance point CMAS for EYUPLX02. The CMASs are connected to each other so that the CICSplex SM data maintained by one CMAS is visible to the other. This ensures a single-system image for the CICSplex SM user. Each CMAS has a data repository. (Data repositories are not shown in Figure 22.)
- Two CICS system group definitions, EYUCSG01 and EYUCSG02, that include a subset of the MASs in each CICSplex. The Starter Set includes nine CICS system group definitions (EYUCSG01 through EYUCSG09), which are described in Table 12 on page 116 and in Table 15 on page 117.

- EYUMAS1C is a remote MAS. (Remember that a remote MAS is one that is explicitly connected to its CMAS via CICS MRO or ISC, and is typically on a different MVS image from the CMAS to which it is connected.) EYUMAS1C is remote because no CMAS is installed on system C.

### The Starter Set installation requirements

The Starter Set is supplied in two samples libraries that are installed automatically when CICSplex SM itself is installed.

**Note:** The storage requirements of the Starter Set are defined in Table 7 on page 98 and Table 8 on page 100.

The two libraries, whose default names are CICSTS13.CPSM.SEYUJCL and CICSTS13.CPSM.SEYUDEF, are described in the remainder of this section.

#### Starter Set library CICSTS13.CPSM.SEYUJCL

The samples library CICSTS13.CPSM.SEYUJCL contains sample JCL for creating and running the Starter Set CASs, CMASs, and MASs. It also includes JCL for creating the CMAS data repositories.

This JCL has been provided chiefly so that you don't have to create it yourself before you can use the Starter Set. However, you might also find it useful to refer to when you are creating JCL for your own CICSplex SM environment (for which you are recommended to use the skeleton JCL supplied with CICSplex SM).

CICSTS13.CPSM.SEYUJCL also includes sample JCL for deleting the Starter Set components from an MVS image.

#### Starter Set library CICSTS13.CPSM.SEYUDEF

The samples library CICSTS13.CPSM.SEYUDEF contains an assortment of sample definitions required to establish not only the Starter Set itself, but also the environment in which it can be used. (The data required to set up the environment is mostly of a routine nature, and is supplied primarily so that you don't have to define it yourself. However, as with the Starter Set JCL, you might find these samples to be a useful checklist or aid when you are making these changes in a real CICSplex SM environment.)

Definitions in CICSTS13.CPSM.SEYUDEF include:

- CICSplex SM definitions (for example, monitor specifications, time-period definitions, analysis definitions, CICS system group definitions, and workload definitions) for each of the two CICSplexes. These definitions are described beginning on page 114.
- VTAM definitions.
- Examples of changes to be made to the ISPF logon procedure and a sample initial menu.
- Updates for CICS tables (including the DCT, PLT, SRT, and JCT).
- Additions to the CSDs for CMAS and MAS operation.
- Group-list definitions to identify the resources used by each MAS.
- Start-up parameters (EYUPARMs) for CMASs and MASs.

### Configuring part of the Starter Set

The Starter Set configuration of nine CICS systems distributed across three MVS images was designed to demonstrate all of CICSplex SM's facilities. However, not having this exact environment doesn't mean that you can't use at least a part of the Starter Set. As an alternative to configuring the whole Starter Set in three MVS images, you can configure:

- The system A components only, on a single MVS image
- The system B components only, on a single MVS image
- The components of CICSplex EYUPLX01 (the system A and system B components of the Starter Set) on two MVS images
- The components of CICSplex EYUPLX02 (the system B and system C components of the Starter Set) on two MVS images

How to configure the Starter Set is described in *CICS Transaction Server for OS/390 Installation Guide*.

### The Starter Set and the IVPs

Configuration of the Starter Set is not essential. However, part of the Starter Set constitutes the CICSplex SM MVS/ESA installation verification procedures (IVPs): if you run an IVP on an MVS image (as you are recommended to do), you will, during the IVP, perform most of the configuration tasks required to make the Starter Set usable. The IVPs ensure that:

- CICSplex SM has been installed successfully from the distribution tape
- All components of CICSplex SM are accessible
- Any MVS system tuning for CICSplex SM has been successful
- You are able to use the product

There are two IVPs, which are referred to as IVP1 and IVP2. IVP1 is run on the first (or only) MVS image on which CICSplex SM is installed and uses the system A components of the Starter Set. IVP2 is run on the second and subsequent MVS images on which CICSplex SM is installed. It uses both the system A and system B components of the Starter Set, and tests communication between CASs and CMASs. The IVPs are described in detail in *CICS Transaction Server for OS/390 Installation Guide*.

---

## CICSplex SM definitions supplied with the Starter Set

The Starter Set includes many sample definitions for each of the CICSplex SM functions. That is, the Starter Set includes:

- CAS definitions, for CASs EYUCAS1A and EYUCAS1B
- Configuration definitions, for CMASs EYUCMS1A and EYUCMS1B and for CICSplexes EYUPLX01 and EYUPLX02
- Topology definitions, for the nine CICS systems in the Starter Set, for CICS system groups, and for time-period definitions
- BAS definitions, including resource definitions, resource groups, resource assignments, resource descriptions, and communication links for sample applications
- Workload definitions, including workload specifications, workload definitions, workload groups, and transaction groups



- Monitor definitions, including monitor specifications, monitor definitions, and monitor groups
- Analysis definitions, including analysis point specifications, analysis specifications, analysis groups, analysis definitions, evaluation definitions, action definitions, and status definitions

You add some of these definitions to the CMAS data repository interactively when you follow the instructions for configuring the Starter Set in *CICS Transaction Server for OS/390 Installation Guide*. However, you add most of them to the CMAS data repository using the CICSplex SM batched repository-update facility. A brief description of all of the Starter Set definitions is supplied in Table 9 through Table 56 on page 137. For a more detailed understanding of these definitions, you are recommended to study the definitions as supplied in CICSSTS13.CPSM.SEYUDEF.

## Sample CAS definitions

Table 9 lists the Starter Set CAS definitions that you create interactively using the CICSplex SM CAS functions. There are also links between the CASs—from EYUCAS1A to EYUCAS1B, and from EYUCAS1B to EYUCAS1A—but such links are not separate entities in the CICSplex SM environment.

<i>Table 9. Starter Set CAS definitions</i>		
Type	Name	Description
CAS	EYUCAS1A	System A CAS
CAS	EYUCAS1B	System B CAS

## Sample configuration definitions

Table 10 lists the Starter Set configuration definitions you create using the CICSplex SM Configuration functions.

<i>Table 10. Starter Set configuration definitions</i>		
Type	Name	Description
CMAS	EYUCMS1A	System A CMAS
CMAS	EYUCMS1B	System B CMAS
CICSplex	EYUPLX01	CICSplex comprising all CICS systems (MASs) on system A and and EYUMAS1B on system B
CICSplex	EYUPLX02	CICSplex comprising EYUMAS2B, EYUMAS3B, and EYUMAS4B on system B, and EYUMAS1C on system C

The configuration definitions also include these links:

- From EYUCMS1A to EYUCMS1B
- From EYUCMS1B to EYUCMS1A
- From EYUCMS1B to EYUMAS1C

As in the case of the CAS-to-CAS links, CMAS-to-CMAS links and CMAS-to-remote-MAS links are not separate CICSplex SM entities.

## Sample topology definitions

The Starter Set topology definitions include CICS system definitions, CICS system group definitions, and time-period definitions.

### Topology definitions for EYUPLX01

Table 11 through Table 13 list the Starter Set topology definitions created with EYUPLX01 as the context. Figure 23 on page 118 shows a Starter Set topology view.

<i>Table 11. CICS system definitions for EYUPLX01</i>		
<b>Name</b>	<b>Belongs to</b>	<b>Description</b>
EYUMAS1A	N/A	A test CICS Transaction Server for OS/390 Release 3 TOR on system A; its hours of availability are as defined by time-period definition EYUPDF01
EYUMAS2A	EYUCSG01 EYUCSG04	A test CICS Transaction Server for OS/390 Release 3 AOR on system A; its hours of availability are as defined by time-period definition EYUPDF01
EYUMAS3A	EYUCSG01 EYUCSG04	A test CICS Transaction Server for OS/390 Release 3 AOR on system A; its hours of availability are as defined by time-period definition EYUPDF01
EYUMAS4A	EYUCSG01	A test CICS Transaction Server for OS/390 Release 3 FOR on system A; its hours of availability are as defined by time-period definition EYUPDF01
EYUMAS1B	EYUCSG05	A test CICS Transaction Server for OS/390 Release 3 AOR on system B; its hours of availability are as defined by time-period definition EYUPDF01

<i>Table 12. CICS system group definitions for EYUPLX01</i>		
<b>Name</b>	<b>Belongs to</b>	<b>Description</b>
EYUCSG01	N/A	AORs and FORs in EYUPLX01
EYUCSG03	N/A	All AORs in EYUPLX01
EYUCSG04	EYUCSG03	System A AORs in EYUPLX01
EYUCSG05	EYUCSG03	System B AORs in EYUPLX01

<i>Table 13. Time-period definitions for EYUPLX01</i>		
<b>Name</b>	<b>Belongs to</b>	<b>Description</b>
EYUPDF01	N/A	08:00 to 17:00 local time
EYUPDF02	N/A	17:01 to 21:00 local time
EYUPDF03	N/A	11:45 to 13:15 local time
EYUPDF04	N/A	07:55 to 08:00 local time

## Topology definitions for EYUPLX02

Table 14 through Table 16 list the Starter Set topology definitions created with EYUPLX02 as the context.

*Table 14. CICS system definitions for EYUPLX02*

Name	Belongs to	Description
EYUMAS2B	EYUCSG02	A production CICS Transaction Server for OS/390 Release 3 TOR on system B; its hours of availability are as defined by time-period definition EYUPDF02
EYUMAS3B	EYUCSG02 EYUCSG07	A production CICS Transaction Server for OS/390 Release 3 AOR on system B; its hours of availability are as defined by time-period definition EYUPDF03
EYUMAS4B	EYUCSG02 EYUCSG09	A production CICS Transaction Server for OS/390 Release 3 FOR on system B; its hours of availability are as defined by time-period definition EYUPDF04
EYUMAS1C	EYUCSG08 EYUCSG09	A production CICS Transaction Server for OS/390 Release 3 region that is both FOR and AOR on system B; its hours of availability are as defined by time-period definition EYUPDF04

*Table 15. CICS system group definitions for EYUPLX02*

Name	Belongs to	Description
EYUCSG02	N/A	All TORs, AORs and FORs on system B
EYUCSG06	N/A	All AORs in EYUPLX02
EYUCSG07	EYUCSG06	System B AORs in EYUPLX02
EYUCSG08	EYUCSG06	System C AORs in EYUPLX02
EYUCSG09	N/A	All FORs in EYUPLX02

*Table 16. Time-period definitions for EYUPLX02*

Name	Belongs to	Description
EYUPDF01	N/A	08:00 to 17:00 local time
EYUPDF02	N/A	05:00 to 01:00 local time
EYUPDF03	N/A	03:00 to 01:00 local time
EYUPDF04	N/A	07:00 to 05:00 local time

```

26MAR1999 21:16:27 ----- INFORMATION DISPLAY -----
COMMAND ==>
CURR WIN ==> 1
W1 =SYSGRPC=====EYUPLX01=EYUPLX01=26MAR1999==21:16:27=CPSM=====10==
CMD Group    Member    Member
--- Name---- Name---- Type----
EYUCSG01    EYUMAS1B  CICSSYS
EYUCSG01    EYUMAS2A  CICSSYS
EYUCSG01    EYUMAS3A  CICSSYS
EYUCSG01    EYUMAS4A  CICSSYS
EYUCSG02    EYUMAS2A  CICSSYS
EYUCSG03    EYUCSG04  SYSGROUP
EYUCSG03    EYUCSG05  SYSGROUP
EYUCSG04    EYUMAS2A  CICSSYS
EYUCSG04    EYUMAS3A  CICSSYS
EYUCSG05    EYUMAS1B  CICSSYS
    
```

Figure 23. A Starter Set topology view. CICSplex SM view SYSGRPC lists the CICS systems in a specified scope. This example lists the CICS system groups in EYUPLX01, and identifies the CICS systems and CICS system groups that belong to those four groups.

## BAS definitions

The Starter Set BAS definitions include resource definitions, communication links, resource groups, resource assignments, and resource descriptions.

### BAS definitions for EYUPLX01

Table 17 through Table 23 on page 120 list the Starter Set BAS definitions created with EYUPLX01 as the context. Figure 24 on page 122 shows a Starter Set BAS view (RASGNDEF) that shows the characteristics of the sample resource assignments used to assign selected resource definitions to CICS systems. For each resource assignment, the resource definitions to be assigned are of a single resource type and are associated with a resource group. Figure 25 on page 122 shows the RASINDSC view that lists the resource descriptions with which the resource assignments are associated.

Table 17 (Page 1 of 2). Communication resource definitions for EYUPLX01		
Name	Associated with	Description
C002		Defines connection characteristics of MRO connections.
S0002	C002	Defines session characteristics of MRO connections with the connection characteristics of C002.
EYUMAS1A	EYUMAS2A	Defines the MRO communication link between EYUMAS1A and EYUMAS2A using the characteristics of connection definition C002 and session definition S0002.
EYUEMAS1A	EYUMAS3A	Defines the MRO communication link between EYUMAS1A and EYUMAS3A using the characteristics of connection definition C002 and session definition S0002.

*Table 17 (Page 2 of 2). Communication resource definitions for EYUPLX01*

Name	Associated with	Description
EYUMAS4A	EYUMAS2A	Defines the MRO communication link between EYUMAS4A and EYUMAS2A using the characteristics of connection definition C002 and session definition S0002.
EYUMAS4A	EYUMAS3A	Defines the MRO communication link between EYUMAS4A and EYUMAS3A using the characteristics of connection definition C002 and session definition S0002.

*Table 18. Resource group and resource definitions for CPUONLY application*

Name	Belongs to	Description
EYUBAG02	N/A	Identifies the resource group for the CPU-only application.
ET01	EYUBAG02	Transaction definition (for SSET) that calls the EYUPR001 program.
ET02	EYUBAG02	Transaction definition (for SSET) that calls the EYUPR002 program.
EYUPR001	EYUBAG02	Program definition (for SSET) called by transaction ET01.
EYUPR002	EYUBAG02	Program definition (for SSET) called by transaction ET02.

*Table 19. Resource assignment for CPUONLY application*

Name	Belongs to	Description
EYUBAA04	N/A	Resource assignment to allocate transaction definitions from resource group EYUBAG02 as remote to target CICS system EYUMAS1A and local to related CICS systems (AORs) in CICS system group EYUCSG03.
EYUBAA05	N/A	Resource assignment to allocate program definitions from resource group EYUBAG02 as local to target CICS systems (AORs) in CICS system group EYUCSG03.

*Table 20. Resource description for CPUONLY application*

Name	Belongs to	Description
EYUBAD02	CPUONLY	Resource description that sets the logical scope for the CPU-only application.

*Table 21 (Page 1 of 2). Resource group and resource definitions for autoinstall programs*

Name	Belongs to	Description
EYUBAG05	N/A	Identifies the resource group for the autoinstall programs.

<i>Table 21 (Page 2 of 2). Resource group and resource definitions for autoinstall programs</i>		
<b>Name</b>	<b>Belongs to</b>	<b>Description</b>
EYUPAUTO	EYUBAG05	Program definition for autoinstall program EYUPAUTO.
EYUPAUT2	EYUBAG05	Program definition for autoinstall program EYUPAUT2.

<i>Table 22. Resource assignment for autoinstall programs</i>		
<b>Name</b>	<b>Belongs to</b>	<b>Description</b>
EYUBAA12	N/A	Resource assignment to allocate program definitions from resource group EYUBAG05 as local to target CICS systems (AORs) in CICS system group EYUCSG01.

<i>Table 23. Resource description for autoinstall programs</i>		
<b>Name</b>	<b>Belongs to</b>	<b>Description</b>
EYUBAD05	COMMON	Resource description that sets the logical scope for the autoinstall programs and other common resources.

## **BAS definitions for EYUPLX02**

Table 24 through Table 26 on page 121 list the Starter Set BAS definitions created with EYUPLX02 as the context.

<i>Table 24. Resource group and resource definitions for File04 application</i>		
<b>Name</b>	<b>Belongs to</b>	<b>Description</b>
EYUBAG04	N/A	Identifies the resource group for the File04 application.
ET04	EYUBAG04	Transaction definition for ET04 transaction that calls the program EYUPR004.
EYUPR004	EYUBAG04	Program definition for EYUPR004 program called by the ET04 transaction.
EYUFIL04	EYUBAG04	File definition for EYUFIL04 file.

<i>Table 25. Resource assignment for File04 application</i>		
<b>Name</b>	<b>Belongs to</b>	<b>Description</b>
EYUBAA09	N/A	Resource assignment to allocate transaction definition ET04 from the resource group EYUBAG04 as remote to target CICS system EYUMAS3B.
EYUBAA10	N/A	Resource assignment to allocate program definition EYUPR004 from the resource group EYUBAG04 as remote to target CICS system EYUMAS3B.
EYUBAA11	EYUBAG04	Resource assignment to allocate file definition for EYUFIL04 file from the resource group EYUBAG04 as remote to target CICS system EYUMAS3B.

*Table 26. Resource description for CPUONLY application*

Name	Belongs to	Description
EYUBAD04		Resource description that sets the logical scope for the CPUONLY application.

### BAS definitions for common terminals and typeterms

Table 27 through Table 28 list the Starter Set BAS definitions created with EYUPLX02 as the context.

*Table 27. Resource group and resource description for terminals and typeterms*

Name	Belongs to	Description
EYUBAG06	COMMON	Resource group for common terminal and typeterm definitions.
CONSL000	EYUBAG06	Typeterm definition for consoles.
MRDTYPE	EYUBAG06	Typeterm definition for IBM Personal Computer 3270 simulator.
TCSN3277	EYUBAG06	Typeterm definition for 3277 terminal.
TYPEFEPI	EYUBAG06	Typeterm definition for LUTYPE terminal used for FEPI.
327R	EYUBAG06	Typeterm definition for 3270 terminal.
CN00	EYUBAG06	Terminal definition for console CN00 associated with typeterm CONSL000.
CN01	EYUBAG06	Terminal definition for console CN01 associated with typeterm CONSL000. <b>Note:</b> Identical terminal definitions are provided for consoles CN02 through CN22.
FEPI	EYUBAG06	Terminal definition for autoinstall model FEPI with typeterm TYPEFEPI.
MRD	EYUBAG06	Terminal definition for autoinstall model MRD3270 with typeterm MRDTYPE.
TCSN	EYUBAG06	Terminal definition for autoinstall model TCSN3277 with typeterm TCSN3277.
3277	EYUBAG06	Terminal definition for autoinstall model ATRMODEL with typeterm 327R.
FREE	EYUBAG06	Transaction definition for transaction used to free the keyboard of remote terminals. Associated with program FREEKB.
FREEKB	EYUBAG06	Program definition for program used to free the keyboard of remote terminals. Associated with transaction FREE.

*Table 28 (Page 1 of 2). Resource assignment for terminals and typeterms*

Name	Belongs to	Description
EYUBAA13	N/A	Resource assignment to allocate terminal definitions from resource group EYUBAG06 as local to target CICS systems in CICS system group EYUCSG01.

## CICSplex SM definitions supplied with the Starter Set

Table 28 (Page 2 of 2). Resource assignment for terminals and typeterms

Name	Belongs to	Description
EYUBAA14	N/A	Resource assignment to allocate typeterm definitions from resource group EYUBAG06 as local to target CICS systems in CICS system group EYUCSG01.
EYUBAA15	N/A	Resource assignment to allocate program definitions from resource group EYUBAG06 as local to target CICS systems in CICS system group EYUCSG01.
EYUBAA16	N/A	Resource assignment to allocate transaction definitions from resource group EYUBAG06 as local to target CICS systems in CICS system group EYUCSG01.

```

26MAR1999 19:33:51 ----- INFORMATION DISPLAY -----
COMMAND ==>                                     SCROLL ==> PAGE
CURR WIN ==> 1           ALT WIN ==>
W1 =RASGNDEF=====EYUPLX01=EYUPLX01=26MAR1999==19:33:51=CPSM=====9===
CMD Name      ResGroup ResType  Target  Usage  Related  Description
-----
EYUBAA03 EYUBAG01 FILEDEF  EYUCSG03 REMOTE EYUMAS4A SSET - Allocate the Fil
EYUBAA04 EYUBAG02 TRANDEF  EYUMAS1A REMOTE EYUCSG03 SSET - Allocate the Tra
EYUBAA05 EYUBAG02 PROGDEF  EYUCSG03 LOCAL          SSET - Allocate the Pro
EYUBAA12 EYUBAG05 PROGDEF  EYUCSG01 LOCAL          SSET - Autoinst Program
EYUBAA13 EYUBAG06 TERMDEF  EYUCSG01 LOCAL
EYUBAA14 EYUBAG06 TYPTMDEF EYUCSG01 LOCAL
EYUBAA15 EYUBAG06 PROGDEF  EYUCSG01 LOCAL
EYUBAA16 EYUBAG06 TRANDEF  EYUCSG01 LOCAL
EYUBAA17 EYUBAG06 TSMDEF   EYUCSG01 LOCAL          TSMdel definition assign
  
```

Figure 24. A Starter Set BAS view. CICSplex SM view RASGNDEF shows the characteristics of the sample resource assignments used to assign selected resource definitions to CICS systems. For each resource assignment, the resource definitions to be assigned are of a single resource type and are associated with a resource group. A resource assignment must be associated with at least one resource description (RESDESC) before any assignment can begin, as shown in Figure 25 (RASINDSC view).

```

26MAR1999 19:34:15 ----- INFORMATION DISPLAY -----
COMMAND ==>                                     SCROLL ==> PAGE
CURR WIN ==> 1           ALT WIN ==>
=W1 =RASINDSC=====EYUPLX01=EYUPLX01=26MAR1999==19:34:15=CPSM=====7===
CMD Name      Assign  ResGroup Target  Related  Description
-----
EYUBAD02 EYUBAA04
EYUBAD02 EYUBAA05
EYUBAD05 EYUBAA12
EYUBAD05 EYUBAA13
EYUBAD05 EYUBAA14
EYUBAD05 EYUBAA15
EYUBAD05 EYUBAA16
  
```

Figure 25. A Starter Set BAS view. CICSplex SM view RASINDSC lists the sample resource assignments and their associated resource descriptions.



## Sample Workload definitions

The Starter Set Workload definitions include workload specifications, workload definitions, workload groups, and transaction groups.

### Workload definitions for EYUPLX01

Table 29 through Table 32 list the Starter Set WLM definitions created with EYUPLX01 as the context. Figure 26 on page 124 shows a Starter Set WLM view.

Table 29. Workload specifications for EYUPLX01

Name	Belongs to	Description
EYUWLS01	EYUMAS1A	Establishes workload balancing in EYUPLX01 and is associated with requesting region EYUMAS1A

Table 30. Workload definitions for EYUPLX01

Name	Belongs to	Description
EYUWLD01	EYUWLG01	Workload separation for transaction group EYUTRG01; the target scope is any target region on system A
EYUWLD05	EYUWLG04	Workload separation for transaction group EYUTRG05; the target scope is any target region in CICSplex EYUPLX01
EYUWLD06	EYUWLG05	Workload separation for transaction group EYUTRG06; the target scope is EYUMAS1B

Table 31. Workload groups for EYUPLX01

Name	Belongs to	Description
EYUWLG01	EYUWLS01	For automatic installation of workload definition EYUWLD01
EYUWLG04	EYUWLS01	For automatic installation of workload definition EYUWLD05
EYUWLG05	EYUWLS01	For automatic installation of workload definition EYUWLD06

Table 32. Transaction groups for EYUPLX01

Name	Belongs to	Description
EYUTRG01	EYUWLD01	Contains transaction ETVP
EYUTRG05	EYUWLD05	Contains transactions ETD1, ETD2, and ETD3
EYUTRG06	EYUWLD06	Contains transactions ETL1 and ETL2. ETL1 and ETL2 constitute a pseudoconversation transaction and must be processed by the same target region

### Workload definitions for EYUPLX02

Table 33 through Table 36 list the Starter Set WLM definitions created with EYUPLX02 as the context.

<i>Table 33. Workload specifications for EYUPLX02</i>		
Name	Belongs to	Description
EYUWLS02	EYUMAS2B	Establishes workload balancing in EYUPLX02 and is associated with target region EYUMAS2B

<i>Table 34. Workload definitions for EYUPLX02</i>		
Name	Belongs to	Description
EYUWLD02	EYUWLG02	Workload separation for transaction group EYUTRG02
EYUWLD03	EYUWLG03	Workload separation for transaction group EYUTRG03
EYUWLD04	EYUWLG02	Workload separation for transaction group EYUTRG04

<i>Table 35. Workload groups for EYUPLX02</i>		
Name	Belongs to	Description
EYUWLG02	EYUWLS02	For automatic installation of workload definition EYUWLD02
EYUWLG03	EYUWLS02	For automatic installation of workload definition EYUWLD03

<i>Table 36. Transaction groups for EYUPLX02</i>		
Name	Belongs to	Description
EYUTRG02	EYUWLD02	Contains transaction ETVP
EYUTRG03	EYUWLD03	Contains transactions ETL1, ETL2, ETL3, and ETL4
EYUTRG04	EYUWLD04	Contains transactions ETA1, ETA2, ETA3, and ETA4

```

26MAR1999 22:03:16 ----- INFORMATION DISPLAY -----
COMMAND ==>
CURR WIN ==> 1
>W1 =WLMSPEC=====EYUPLX01=EYUPLX01=26MAR1999==22:03:16=CPSM=====1===
CMD Name      Affinity Affinity Target  Cre Match  Event      Description
---          -
----- Relation Lifetime Scope--- Aff Key--- Name-----
      EYUWLS01                      EYUCSG03  USERID      SSet - Basic worklo
    
```

Figure 26. A Starter Set workload management view. This example shows the WLMSPEC view, which is displaying the workload specifications for CICSplex EYUPLX01.

## Sample Monitor definitions

The Starter Set Monitor definitions include monitor specifications, monitor definitions, and monitor groups.

### Monitor definitions for EYUPLX01

Table 37 on page 126 through Table 39 on page 126 list the Starter Set MON definitions created with EYUPLX01 as the context.

Figure 27 on page 128 shows a Starter Set MON view.

<i>Table 37. Monitor specifications for EYUPLX01</i>		
<b>Name</b>	<b>Belongs to</b>	<b>Description</b>
EYUMOS01	N/A	Establishes MON for EYUMAS1A
EYUMOS02	N/A	Establishes MON for CICS system group EYUCSG03 (EYUMAS2A, EYUMAS3A, and EYUMAS1B)
EYUMOS03	N/A	Establishes MON for EYUMAS4A

<i>Table 38. Monitor definitions for EYUPLX01</i>		
<b>Name</b>	<b>Belongs to</b>	<b>Description</b>
EYUMOD01	EYUMOG01	Monitor definition for all connections
EYUMOD02	EYUMOG02	Monitor definition for all transactions whose names begin "CO"
EYUMOD03	EYUMOG02	Monitor definition for all transient data queues whose names begin "CO"
EYUMOD04	EYUMOG02	Monitor definition for all transient data queues whose names begin "EQ"
EYUMOD05	EYUMOG02	Monitor definition for the DFHCSD file
EYUMOD06	EYUMOG02	Monitor definition for all journals
EYUMOD07	EYUMOG03	Monitor definition for all terminals whose lunames begin "SP"
EYUMOD08	EYUMOG03	Monitor definition for the CEMT transaction
EYUMOD09	EYUMOG04	Monitor definition for all files whose names begin "EYUF"
EYUMOD10	EYUMOG05	Monitor definition for all transactions whose names begin "ET"
EYUMOD11	EYUMOG06	Monitor definition for all programs whose names begin "EYU"

<i>Table 39 (Page 1 of 2). Monitor groups for EYUPLX01</i>		
<b>Name</b>	<b>Belongs to</b>	<b>Description</b>
EYUMOG01	EYUMOS01 EYUMOS02 EYUMOS03	For automatic installation of monitor definition EYUMOD01
EYUMOG02	EYUMOS01 EYUMOS02 EYUMOS03	For automatic installation of monitor definitions EYUMOD02, EYUMOD03, EYUMOD04, and EYUMOD05, and EYUMOD06
EYUMOG03	EYUMOS01	For automatic installation of monitor definitions EYUMOD07 and EYUMOD08
EYUMOG04	EYUMOS01 EYUMOS02 EYUMOS03	For automatic installation of monitor definition EYUMOD09
EYUMOG05	EYUMOS01 EYUMOS02	For automatic installation of monitor definition EYUMOD10

*Table 39 (Page 2 of 2). Monitor groups for EYUPLX01*

Name	Belongs to	Description
EYUMOG06	EYUMOS02	For automatic installation of monitor definition EYUMOD11

### Monitor definitions for EYUPLX02

Table 40 through Table 42 list the Starter Set MON definitions created with EYUPLX02 as the context.

*Table 40. Monitor specifications for EYUPLX02*

Name	Belongs to	Description
EYUMOS01	EYUMAS2B	Establishes MON for EYUMAS2B
EYUMOS02	EYUCSG07 EYUCSG08	Establishes MON for EYUMAS3B and EYUMAS1C
EYUMOS03	EYUMAS4B	Establishes MON for EYUMAS4B

*Table 41. Monitor definitions for EYUPLX02*

Name	Belongs to	Description
EYUMOD01	EYUMOG01	Monitor definition for all connections, except the connection to remote MAS EYUMAS1C
EYUMOD02	EYUMOG01	Monitor definition for all transient data queues
EYUMOD03	EYUMOG01	Monitor definition for all journals
EYUMOD04	EYUMOG05	Monitor definition for the connection to the remote MAS
EYUMOD05	EYUMOG02	Monitor definition for all transactions whose names begin "ET"
EYUMOD06	EYUMOG03	Monitor definition for all programs whose names begin "EYUPR"
EYUMOD07	EYUMOG04	Monitor definition for all files whose names begin "EYUF"

*Table 42. Monitor groups for EYUPLX02*

Name	Belongs to	Description
EYUMOG01	EYUMOS01 EYUMOS02 EYUMOS03	For automatic installation of monitor definitions EYUMOD01, EYUMOD02, and EYUMOD03
EYUMOG02	EYUMOS01 EYUMOS02	For automatic installation of monitor definition EUMOD05
EYUMOG03	EYUMOS02	For automatic installation of monitor definition EYUMOD06
EYUMOG04	EYUMOS02 EYUMOS03	For automatic installation of monitor definition EYUMOD07
EYUMOG05	EYUMOS01	For automatic installation of monitor definition EYUMOD04

```

26MAR1999 19:33:23 ----- INFORMATION DISPLAY -----
COMMAND ==>
CURR WIN ==> 1
W1 =MONDEF=====EYUPLX01=EYUPLX01=26MAR1999==19:33:23=CPSM=====11===
CMD Def      Resource Resource Include RODM Monitor Definition
--- Name---- Name---- Type--- Data--- Pop- Description-----
EYUMOD01 *      MCONN  YES    YES  SSet - All Connections
EYUMOD02 CO*    MTRAN  YES    NO   SSet - All CO* Transactions
EYUMOD03 CO*    MTDQS  YES    NO   SSet - TDQs CO*
EYUMOD04 EQ*    MTDQS  NO     YES  SSet - TDQs EQ*
EYUMOD05 DFHCSD  MFILE  YES    YES  SSet - DFHCSD Files
EYUMOD06 *      MJRNL  YES    YES  SSet - All Journals
EYUMOD07 SP*    MTERM  YES    YES  SSet - All SP* Terminals
EYUMOD08 CEMT    MTRAN  YES    YES  SSet - CEMT Transaction
EYUMOD09 EYUF*   MFILE  YES    YES  SSet - EYUF* files
EYUMOD10 ET*    MTRAN  YES    YES  SSet - ET* Transations
EYUMOD11 EYU*    MPROG  YES    YES  SSet - EYU* Programs
    
```

Figure 27. A Starter Set monitoring view. The MONDEF view displays all monitor definitions for CICSplex EYUPLX01.

## Sample Analysis definitions

The Starter Set analysis definitions include: analysis point specifications; analysis specifications; analysis groups; analysis definitions; evaluation definitions; action definitions; and status definitions.

### Analysis definitions for EYUPLX01

Table 43 through Table 48 on page 130 list the Starter Set RTA definitions created with EYUPLX01 as the context. Figure 28 on page 130 shows a Starter Set RTA view.

*Table 43. Analysis point specifications for EYUPLX01*

Name	Belongs to	Description
EYURAP01	EYUPLX01	EYUCMS1A is the CMAS responsible for the analysis definitions in analysis group EYURTG02 within EYUPLX01
EYURAPLC	EYUPLX01	EYUCMS1A is the CMAS responsible for the analysis definitions in analysis group EYURTG01 within EYUPLX01

*Table 44. Analysis specifications for EYUPLX01*

Name	Belongs to	Description
EYURTS01	EYUMAS1A	For TOR EYUMAS1A
EYURTS03	EYUMAS4A	For FOR EYUMAS4A

*Table 45 (Page 1 of 2). Analysis groups for EYUPLX01*

Name	Belongs to	Description
EYURTG01	EYURTS03	For automatic installation of analysis definitions EYURTD16 and EYURTD17

*Table 45 (Page 2 of 2). Analysis groups for EYUPLX01*

Name	Belongs to	Description
EYURTG02	EYURAP01	For automatic installation of analysis definitions EYURTD01, EYURTD02, EYURTD19, EYURTD20, EYURTD21, and EYURTD22
EYURTG07	EYURTS01	For automatic installation of analysis definition EYURTD18

*Table 46. Analysis definitions for EYUPLX01*

Name	Belongs to	Description
EYURTD01	EYURTG02	Evaluation definition EYURTE01 activates action definition EYURTA01
EYURTD02	EYURTG02	Evaluation definition EYURTE02 activates action definition EYURTA02
EYURTD16	EYURTG01	Evaluation definition EYURTE16 activates action definition EYURTA16
EYURTD17	EYURTG01	Evaluation definition EYURTE17 activates action definition EYURTA17
EYURTD18	EYURTG07	Evaluation definition EYURTE18 activates action definition EYURTA18
EYURTD19	EYURTG02	Evaluation definition EYURTE19 activates action definition EYURTA19
EYURTD20	EYURTG02	Evaluation definition EYURTE20 activates action definition EYURTA20
EYURTD21	EYURTG02	Evaluation definition EYURTE21 activates action definition EYURTA21
EYURTD22	EYURTG02	Evaluation definition EYURTE22 activates action definition EYURTA22

*Table 47. Evaluation definitions for EYUPLX01*

Name	Belongs to	Description
EYURTE01	EYURTD01	Notify when any connection is not ACQUIRED
EYURTE02	EYURTD02	Notify when any DFHCSD file is not ENABLED
EYURTE16	EYURTD16	Notify when any file requires Emptying
EYURTE17	EYURTD17	Notify when the maximum number of DBCTL threads is active
EYURTE18	EYURTD18	Notify when the dynamic transaction routing program is not EYU9XLOP
EYURTE19	EYURTD19	Notify when monitoring is not active in a CICS system
EYURTE20	EYURTD20	Notify when the percentage of free space in the DSA drops to a specified threshold
EYURTE21	EYURTD21	Notify when the number of outstanding event notifications reaches a specified threshold
EYURTE22	EYURTD22	Notify when TRANDUMP dump suppression reaches a specified threshold

*Table 48. Action definitions for EYUPLX01*

Name	Belongs to	Description
EYURTA01	EYURTD01	Generate event notification and external message when a connection is unavailable
EYURTA02	EYURTD02	Generate event notification and external message when a file is unavailable
EYURTA16	EYURTD16	Generate event notification and external message when a file requires Emptying
EYURTA17	EYURTD17	Generate event notification and external message when the maximum number of DBCTL threads is active
EYURTA18	EYURTD18	Generate event notification and external message when the dynamic transaction routing program is not EYU9XLOP
EYURTA19	EYURTD19	Generate event notification and external message when monitoring is not active in a CICS system
EYURTA20	EYURTD20	Generate event notification and external message when the percentage of free space in the DSA drops to a specified threshold
EYURTA21	EYURTD21	Generate event notification and external message when a specified number of outstanding event notifications is reached
EYURTA22	EYURTD22	Generate event notification and external message when a specified number of dumps is being suppressed by TRANDUMP suppression

```

26MAR1999 21:02:56 ----- INFORMATION DISPLAY -----
COMMAND ==>
CURR WIN ==> 1
W1 =RTAGROUP=====EYUPLX01=EYUPLX01=26MAR1999==21:02:56=CPSM=====4===
CMD Analysis Description
--- Group--- -----
EYURTGLC SSet - License
EYURTG01 SSet - FOR related definitions
EYURTG02 SSet - Plex wide definitions
EYURTG07 SSet - TOR related definitions
    
```

Figure 28. A Starter Set RTA view. This example shows the RTAGROUP view, which is displaying the analysis groups in EYUPLX01.

### Analysis definitions for EYUPLX02

Table 49 on page 131 through Table 56 on page 137 list the Starter Set RTA definitions created with EYUPLX02 as the context.



*Table 49. Analysis point specifications for EYUPLX02*

Name	Belongs to	Description
EYURAP02	EYUPLX02	EYUCMS1B is the CMAS responsible for the analysis definitions in analysis group EYURTG04 within EYUPLX02
EYURAP03	EYUCSG07	EYUCMS1B is the CMAS responsible for the analysis definitions in analysis group EYURTG05 within CICS system group EYUCSG07
EYURAP04	EYUCSG08	EYUCMS1B is the CMAS responsible for the analysis definitions in analysis group EYURTG05 within CICS system group EYUCSG08

*Table 50. Primary CMAS associations for EYUPLX02*

Name	Belongs to	Description
N/A	N/A	RTA primary CMAS association between EYURAP02 and EYUCMS1B
N/A	N/A	RTA primary CMAS association between EYURAP03 and EYUCMS1B
N/A	N/A	RTA primary CMAS association between EYURAP04 and EYUCMS1B

*Table 51. Analysis specifications for EYUPLX02*

Name	Belongs to	Description
EYURTS02	EYUMAS2B	For TOR EYUMAS2B

*Table 52. Analysis groups for EYUPLX02*

Name	Belongs to	Description
EYURTG03	EYURTS02	For automatic installation of analysis definition EYURTD03 during period defined by EYUPDF01
EYURTG04	EYURAP02	For automatic installation of analysis definitions EYURTD04 (during period defined by EYUPDF01), EYURTD10, EYURTD23, EYURTD24, EYURTD25
EYURTG05	EYURAP03 EYURAP04	For automatic installation of analysis definition EYURTD09
EYURTG06	EYURTS02	For automatic installation of analysis definition EYURTD05 during period defined by EYUPDF01
EYURTG08	EYURTS02	For automatic installation of status definition EYURST03
EYURTG09	EYURTS02	For automatic installation of status definition EYURST04
EYURTG10	EYURTS02	For automatic installation of status definition EYURST06

## CICSPlex SM definitions supplied with the Starter Set

*Table 53 (Page 1 of 2). Analysis definitions for EYUPLX02*

<b>Name</b>	<b>Belongs to</b>	<b>Description</b>
EYURTD03	EYURTG03	Evaluation definition EYURTE03 activates action definition EYURTA03
EYURTD04	EYURTG04	Evaluation definition EYURTE04 activates action definition EYURTA04
EYURTD05	EYURTG06	Evaluation definitions EYURTE05 and EYURTE06 (combined) activate action definition EYURTA05
EYURTD06	N/A	Status definition EYURST03 or EYURST04 activates action definition EYURTA06
EYURTD08	N/A	Status definition EYURST06 activates action definition EYURTA08
EYURTD09	EYURTG05	Evaluation definitions EYURTE10, EYURTE11, EYURTE12, EYURTE13, or EYURTE14 activate action definition EYURTA09
EYURTD10	EYURTG04	Evaluation definition EYURTE15 activates action definition EYURTA10
EYURTD23	EYURTG04	Evaluation definition EYURTE23 activates action definition EYURTA23
EYURTD24	EYURTG04	Evaluation definition EYURTE24 activates action definition EYURTA24
EYURTD25	EYURTG04	Evaluation definition EYURTE25 activates action definition EYURTA25
EYURTD26	N/A	Evaluation definition EYURTE26 activates action definition EYURTA26
EYURTD27	N/A	Evaluation definition EYURTE27 activates action definition EYURTA27
EYURTD28	N/A	Evaluation definition EYURTE28 activates action definition EYURTA28
EYURTD29	N/A	Evaluation definition EYURTE29 activates action definition EYURTA29
EYURTD30	N/A	Evaluation definition EYURTE30 activates action definition EYURTA30
EYURTD31	N/A	Evaluation definition EYURTE31 activates action definition EYURTA31
EYURTD32	N/A	Evaluation definition EYURTE32 activates action definition EYURTA32
EYURTD33	N/A	Evaluation definition EYURTE33 activates action definition EYURTA33
EYURTD34	N/A	Evaluation definition EYURTE34 activates action definition EYURTA34
EYURTD35	N/A	Evaluation definition EYURTE35 activates action definition EYURTA35
EYURTD36	N/A	Evaluation definition EYURTE36 activates action definition EYURTA36
EYURTD37	N/A	Evaluation definition EYURTE37 activates action definition EYURTA37

*Table 53 (Page 2 of 2). Analysis definitions for EYUPLX02*

<b>Name</b>	<b>Belongs to</b>	<b>Description</b>
EYURTD38	N/A	Evaluation definition EYURTE38 activates action definition EYURTA38
EYURTD39	N/A	Evaluation definition EYURTE39 activates action definition EYURTA39
EYURTD40	N/A	Evaluation definition EYURTE40 activates action definition EYURTA40
EYURTD41	N/A	Evaluation definition EYURTE41 activates action definition EYURTA41
EYURTD42	N/A	Evaluation definition EYURTE42 activates action definition EYURTA42
EYURTD43	N/A	Evaluation definition EYURTE43 activates action definition EYURTA43
EYURTD44	N/A	Evaluation definition EYURTE44 activates action definition EYURTA44
EYURTD45	N/A	Evaluation definition EYURTE45 activates action definition EYURTA45
EYURTD46	N/A	Evaluation definition EYURTE46 activates action definition EYURTA46
EYURTD47	N/A	Evaluation definition EYURTE47 activates action definition EYURTA47
EYURTD48	N/A	Evaluation definition EYURTE48 activates action definition EYURTA48
EYURTD49	N/A	Evaluation definition EYURTE49 activates action definition EYURTA49
EYURTD50	N/A	Evaluation definition EYURTE50 activates action definition EYURTA50
EYURTD52	N/A	Evaluation definitions EYURTE51 and EYURTE52 activate action definition EYURTA52
EYURTD53	N/A	Evaluation definition EYURTE53 activates action definition EYURTA53

*Table 54 (Page 1 of 3). Evaluation definitions for EYUPLX02*

<b>Name</b>	<b>Belongs to</b>	<b>Description</b>
EYURTE03	EYURTD03	Trigger when the connection to a remote MAS is unavailable
EYURTE04	EYURTD04	Trigger when the response time of ET* transactions is > 2 seconds
EYURTE05	EYURTD05	Trigger when primary connection is not available
EYURTE06	EYURTD05	Trigger when secondary connection is not available
EYURTE10	EYURTD09	Trigger when programs in an application are not ENABLED
EYURTE11	EYURTD09	Trigger when ENABLED files in an application are not OPEN
EYURTE12	EYURTD09	Trigger when files in an application are not ENABLED

*Table 54 (Page 2 of 3). Evaluation definitions for EYUPLX02*

<b>Name</b>	<b>Belongs to</b>	<b>Description</b>
EYURTE13	EYURTD09	Trigger when a DB2 database in an application is not ACTIVE
EYURTE14	EYURTD09	Trigger when local transactions in an application are not ENABLED
EYURTE15	EYURTD10	Trigger when the number of priority 1 events reaches specified thresholds
EYURTE23	EYURTD23	Trigger when a remote Q output rate grows
EYURTE24	EYURTD24	Trigger when special terminals become unavailable
EYURTE25	EYURTD25	Trigger when a program use count exceeds specified levels
EYURTE26	EYURTD26	Trigger when CICS CPU usage reaches a specified threshold
EYURTE27	EYURTD27	Trigger when the largest DSA free size reduces to a specified threshold
EYURTE28	EYURTD28	Trigger when the number of transaction dumps reach a specified threshold
EYURTE29	EYURTD29	Trigger when the number of active LSRPOOL strings reaches a specified threshold
EYURTE30	EYURTD30	Trigger when the number of LSRPOOL waits reaches a specified threshold
EYURTE31	EYURTD31	Trigger when the number of current file string waits reaches a specified threshold
EYURTE32	EYURTD32	Trigger when the number of storage violations for all transactions reaches a specified threshold
EYURTE33	EYURTD33	Trigger when the number of storage violations for all terminals reaches a specified threshold
EYURTE34	EYURTD34	Trigger when the number of items on a transient data queue reaches a specified threshold
EYURTE35	EYURTD35	Trigger when the number of current transient data strings reaches a specified threshold
EYURTE36	EYURTD36	Trigger when the number of transient data string waits reaches a specified threshold
EYURTE37	EYURTD37	Trigger when the number of auxiliary temporary storage queue items reaches a specified threshold
EYURTE38	EYURTD38	Trigger when the number of current temporary storage strings reaches a specified threshold
EYURTE39	EYURTD39	Trigger when the number of temporary storage string waits reaches a specified threshold
EYURTE40	EYURTD40	Trigger when the number of storage violations for a transaction reaches a specified threshold
EYURTE41	EYURTD41	Trigger when the number of storage violations for a terminal reaches a specified threshold
EYURTE42	EYURTD42	Trigger when the page-in rate for CICS reaches a specified threshold

*Table 54 (Page 3 of 3). Evaluation definitions for EYUPLX02*

Name	Belongs to	Description
EYURTE43	EYURTD43	Trigger when the number of MRO links in use reaches a specified threshold
EYURTE44	EYURTD44	Trigger when the number of ISC links in use reaches a specified threshold
EYURTE45	EYURTD45	Trigger when the total of system dumps reaches a specified threshold
EYURTE46	EYURTD46	Trigger when use of the DSA above the 16M line reaches a specified threshold
EYURTE47	EYURTD47	Trigger when use of the DSA below the 16M line reaches a specified threshold
EYURTE48	EYURTD48	Trigger when the number of I/O requests for a CICS system reaches a specified threshold
EYURTE49	EYURTD49	Trigger when the DBCTL attachment interface is inactive
EYURTE50	EYURTD50	Trigger when the DB2 attachment interface is inactive
EYURTE51	EYURTD51	Trigger when the DB2 attachment interface is active (for use with CICS shutdown)
EYURTE52	EYURTD52	Trigger when CICS is in shutdown stage
EYURTE53	EYURTD53	Trigger when the number of DB2 threads in use reaches a specified threshold

*Table 55 (Page 1 of 3). Action definitions for EYUPLX02*

Name	Belongs to	Description
EYURTA03	EYURTD03	Generate event notification and external message to warn that a remote MAS connection is unavailable
EYURTA04	EYURTD04	Generate event notification and external message to indicate the response time is too high for ET* transactions
EYURTA05	EYURTD05	Generate event notification and external message to indicate primary and secondary connections to a region are unavailable
EYURTA06	EYURTD06	Generate event notification and external message to indicate a Client/Server connection is unavailable
EYURTA07	EYURTD07	Generate event notification and external message to warn that a VSE connection is unavailable
EYURTA08	EYURTD08	Generate event notification and external message to indicate that DB2 is not correctly initialized
EYURTA09	EYURTD09	Generate event notification and external message to indicate a total application is unavailable
EYURTA10	EYURTD10	Generate event notification and external message to indicate the number of priority 1 events is high
EYURTA23	EYURTD23	Generate event notification and external message to indicate a remote queue output level is high

*Table 55 (Page 2 of 3). Action definitions for EYUPLX02*

<b>Name</b>	<b>Belongs to</b>	<b>Description</b>
EYURTA24	EYURTD24	Generate event notification and external message to indicate specially designated terminals are unavailable
EYURTA25	EYURTD25	Generate event notification and external message to indicate a program use count is high
EYURTA26	EYURTD26	Generate event notification and external message when CICS CPU usage reaches a specified threshold
EYURTA27	EYURTD27	Generate event notification and external message when the largest DSA free size reduces to a specified threshold
EYURTA28	EYURTD28	Generate event notification and external message when the number of transaction dumps reaches a specified threshold
EYURTA29	EYURTD29	Generate event notification and external message when the number of active LSRPOOL strings reaches a specified threshold
EYURTA30	EYURTD30	Generate event notification and external message when the number of LSRPOOL waits reaches a specified threshold
EYURTA31	EYURTD31	Generate event notification and external message when the number of current file string waits reaches a specified threshold
EYURTA32	EYURTD32	Generate event notification and external message when the number of storage violations for all transactions reaches a specified threshold
EYURTA33	EYURTD33	Generate event notification and external message when the number of storage violations for all terminals reaches a specified threshold
EYURTA34	EYURTD34	Generate event notification and external message when the number of items on a transient data queue reaches a specified threshold
EYURTA35	EYURTD35	Generate event notification and external message when the number of current transient data strings reaches a specified threshold
EYURTA36	EYURTD36	Generate event notification and external message when the number of transient data string waits reaches a specified threshold
EYURTA37	EYURTD37	Generate event notification and external message when the number of auxiliary temporary storage queue items reaches a specified threshold
EYURTA38	EYURTD38	Generate event notification and external message when the number of active temporary storage strings reaches a specified threshold
EYURTA39	EYURTD39	Generate event notification and external message when the number of temporary storage string waits reaches a specified threshold

*Table 55 (Page 3 of 3). Action definitions for EYUPLX02*

Name	Belongs to	Description
EYURTA40	EYURTD40	Generate event notification and external message when the number of storage violations for a transaction reaches a specified threshold
EYURTA41	EYURTD41	Generate event notification and external message when the number of storage violations for a terminal reaches a specified threshold
EYURTA42	EYURTD42	Generate event notification and external message when the page-in rate for CICS reaches a specified threshold
EYURTA43	EYURTD43	Generate event notification and external message when the number of MRO links in use reaches a specified threshold
EYURTA44	EYURTD44	Generate event notification and external message when the number of ISC links in use reaches a specified threshold
EYURTA45	EYURTD45	Generate event notification and external message when the total of system dumps reaches a specified threshold
EYURTA46	EYURTD46	Generate event notification and external message when use of the DSA above the 16M line reaches a specified threshold
EYURTA47	EYURTD47	Generate event notification and external message when use of the DSA below the 16M line reaches a specified threshold
EYURTA48	EYURTD48	Generate event notification and external message when the number of I/O requests for a CICS system reaches a specified threshold
EYURTA49	EYURTD49	Generate event notification and external message when the DBCTL attachment interface is inactive
EYURTA50	EYURTD50	Generate event notification and external message when the DB2 attachment interface is inactive
EYURTA52	EYURTD52	Generate event notification and external message when CICS is in shutdown stage
EYURTA53	EYURTD53	Generate event notification and external message when the number of DB2 threads in use reaches a specified threshold
EYURTA6K	EYURTD6K	Generate event notification and external message when a client/server probe has been triggered
EYURTA4P	EYURTD4P	Generate event notification and external message when a CICS/400 probe has been triggered
EYURTADB	EYURTDDB	Generate event notification and external message when a DB2 Application status probe has been triggered

*Table 56 (Page 1 of 2). Status definitions for EYUPLX02*

Name	Belongs to	Description
EYURST03	EYURTG08	Trigger when Client/Server probe returns true token

## CICSplex SM definitions supplied with the Starter Set

<i>Table 56 (Page 2 of 2). Status definitions for EYUPLX02</i>		
<b>Name</b>	<b>Belongs to</b>	<b>Description</b>
EYURST04	EYURTG09	Trigger when CICS/400 probe returns true token
EYURST06	EYURTG10	Trigger when DB2 Application status probe returns true token



The status definitions supplied with the Starter Set are triggered by CICS programs known as *status probes*. These programs are shipped in source format in data set CICSTS13.CPSM.SEYUDEF. You are recommended to read the commented source files before using any of these programs. The status probe programs and the definitions that use them are:

Status Probe	Status Definition	Environment
EYUPRB60	EYURST03	IBM CICS for AIX
EYUPRB6B	EYURST03	IBM CICS for AIX
EYUPRB40	EYURST04	IBM CICS for OS/400
EYUPRB4B	EYURST04	IBM CICS for OS/400
EYUPRBDB	EYURST06	DB2

Two sample JCL members have been added to data set CICSTS13.CPSM.SEYUJCL to create the RTA status probe load modules: member EYUJPRDA creates the load module for status probe EYUPRBDB; member EYUJPRBA creates the load modules for all status probes except EYUPRBDB.

## The Starter Set naming convention

All of the supplied Starter Set components follow a naming convention that allows you both to identify the contents of a particular dataset member and to differentiate the Starter Set from “live” CICSplex SM data.

The 8-character names of all Starter Set components comprise:

- A 3-character product symbol, “EYU”.
- A 3-character resource-type identifier. For example, the characters “RTS” identify an analysis specification, and the characters “PDF” identify a time-period definition.
- A 2-character, site-specific indicator. Typically, this identifies the system on which the component is installed. For example, EYUCAS1A is CAS number 1 on System A, and EYUMAS4B is MAS number 4 on System B.

Thus, the Starter Set naming convention is as follows:

Naming convention	CICSplex SM resource type
EYUBAAxx	resource assignment
EYUBADxx	resource description
EYUBAGxx	resource group
EYUCASxx	CAS
EYUCMSxx	CMAS
EYUCSGxx	CICS system group
EYUMASxx	MAS
EYUMODxx	Monitor definition
EYUMOGxx	Monitor group
EYUMOSxx	Monitor specification
EYUPDFxx	Time-period definition
EYUPLXxx	CICSplex
EYURAPxx	Analysis point specification
EYURSTxx	Status definition
EYURTAxx	Action definition

## the Starter Set naming convention

EYURTDxx	Analysis definition
EYURTExx	Evaluation definition
EYURTGxx	Analysis group
EYURTSxx	Analysis specification
EYUTRGxx	Transaction group
EYUWLDxx	Workload definition
EYUWLGxx	Workload group
EYUWLSxx	Workload specification

It is most important that you define an appropriate naming convention for your own CICSplex SM environment. How to approach this is described in Chapter 9, “Planning CICSplex SM installation and setup” on page 97.

---

# Glossary

This glossary defines CICSplex SM terms and abbreviations used in this book with other than their everyday meaning. Terms that are defined in the *IBM Dictionary of Computing*, New York: McGraw-Hill, 1994, are not defined here unless CICSplex SM usage is different from the meaning given there.

If you cannot find the definition you need, refer to the *Dictionary of Computing* or the *CICSplex SM Master Index*, SC33-1812.

## A

**action command.** A CICSplex SM command that affects one or more of the resources represented in a view. Action commands can be issued from either the COMMAND field in the control area of the information display panel or the line command field in a displayed view. Valid action commands are listed with the description of each view. See also *overtyping field*.

**action definition (ACTNDEF).** In real-time analysis, a definition of the type of external notification that is to be issued when the conditions identified in an analysis definition are true.

**activity.** See *BTS activity*.

**adjacent CMAS.** A CICSplex SM address space (CMAS) that is connected to the local CMAS via a direct CMAS-to-CMAS link. Contrast with *indirect CMAS*. See also *local CMAS*.

**alter expression.** A character string that defines the changes to be made to a resource attribute. An alter expression is made up of one or more attribute expressions.

**alternate window.** A window to which the results of a hyperlink can be directed. By default, the results of a hyperlink are displayed in the same window from which the hyperlink is initiated. Contrast with *current window*.

**alternate window (ALT WIN) field.** In the control area of an information display panel, the field in which you can specify an alternate window to receive the results of a hyperlink.

**analysis definition.** In real-time analysis, a definition of the evaluations to be performed on specified CICS resources, the intervals at which those evaluations are to be performed, and the actions to be taken when a notifiable condition occurs.

**analysis group.** In real-time analysis, a group of one or more analysis definitions, status definitions, or both.

Analysis definitions and status definitions must belong to an analysis group if they are to be installed automatically in a CICS system when that system starts.

**analysis point monitoring (APM).** In real-time analysis, resource monitoring across multiple CICS systems within a CICSplex that results in a single notification of a condition, rather than one notification for each system. Contrast with *MAS resource monitoring*.

**analysis point specification.** In real-time analysis, a specification that identifies the CMASs that are to be responsible for analysis point monitoring.

**analysis specification.** In real-time analysis, a specification that establishes system availability monitoring or MAS resource monitoring within a group of CICS systems.

**AOR.** Application-owning region.

**API.** Application programming interface

**APM.** Analysis point monitoring.

**application-owning region (AOR).** In a CICSplex configuration, a CICS region devoted to running applications. For dynamic routing, the terms *requesting region*, *routing region*, and *target region* are used instead of AOR to signify the role of the region in the dynamic routing request.

**ARM.** Automatic restart manager.

**ASU.** Automatic screen update.

**attribute.** See *resource attribute*, *resource table attribute*.

**attribute expression.** A reference to a resource table attribute and, in some cases, its value. Attribute expressions are used to build filter expressions, modification expressions, and order expressions.

**attribute value.** The data currently associated with a resource table attribute. For example, the file attribute OPENSTATUS might have a value of CLOSED.

**automatic restart manager (ARM).** A recovery function of MVS/ESA 5.2 that provides improved availability for batch jobs and started tasks by restarting them automatically if they end unexpectedly. The affected batch job or started task can be restarted on the same system or on a different one, if the system itself has failed.

**automatic screen update (ASU).** A CICSplex SM facility that automatically updates the data in all unlocked windows at user-defined intervals. See also *automatic screen update interval*.

**automatic screen update interval.** The time interval between one automatic screen update and the next. This interval can be set in the CICSplex SM user profile or when the ASU facility is turned on. See also *automatic screen update (ASU)*.

## B

**BAS.** Business Application Services

**batched repository-update facility.** A CICSplex SM facility, invoked from the CICSplex SM end user interface, for the bulk application of CICSplex SM definitions to a CMAS data repository.

**BTS.** CICS business transaction services

**BTS activity.** One part of a process managed by CICS BTS. Typically, an activity is part of a *business transaction*.

**BTS process.** A collection of more than one CICS BTS *activities*. Typically, a process is an instance of a *business transaction*.

**BTS set.** See CICS system group

**business application.** Any set of CICS resources that represent a meaningful entity to an enterprise or a user (such as, Payroll).

**Business Application Services (BAS).** The component of CICSplex SM that provides the ability to define and manage business applications in terms of their CICS resources and associated CICS systems. BAS provides a central definition repository for CICS systems, complete with installation facilities and the ability to restrict a CICSplex SM request to those resources defined as being part of the business application. See also *business application, scope*.

**business transaction.** A self-contained business function, for example, the booking of an airline ticket.

## C

**CAS.** Coordinating address space.

**CBIPO.** Custom-built installation process offering.

**CBPDO.** Custom-built product delivery offering.

**CEDA.** A CICS transaction that defines resources online. Using CEDA, you can update both the CICS

system definition data set (CSD) and the running CICS system.

**CICS Business Transaction Services (BTS).** A CICS domain that supports an application programming interface (API) and services that simplify the development of *business transactions*.

**CICS system.** The entire collection of hardware and software required by CICS. In CICSplex SM topology, a definition referring to a CICS system that is to be managed by CICSplex SM. See also *CICSplex, CICS system group*.

**CICS system group.** A set of CICS systems within a CICSplex that can be managed as a single entity. In CICSplex SM topology, the user-defined name, description, and content information for a CICS system group. A CICS system group can be made up of CICS systems or other CICS system groups. In CICS business transaction services (BTS), a BTS set, that is the set of CICS regions across which BTS processes and activities may execute. See also *CICSplex, CICS system*.

**CICSplex.** A CICS complex. A CICSplex consists of two or more CICS regions that are linked using CICS intercommunication facilities. The links can be either intersystem communication (ISC) or interregion communication (IRC) links, but within a CICSplex are more commonly IRC. Typically, a CICSplex has at least one terminal-owning region (TOR), more than one application-owning region (AOR), and may have one or more regions that own the resources being accessed by the AORs. In CICSplex SM, a management domain. The largest set of CICS regions, or CICS systems, to be manipulated by CICSplex SM as a single entity. CICS systems in a CICSplex being managed by CICSplex SM do not need to be connected to each other. See also *CICS system, CICS system group*.

**CICSplex SM.** IBM CICSplex System Manager.

**CICSplex SM address space (CMAS).** A CICSplex SM component that is responsible for managing CICSplexes. A CMAS provides the single-system image for a CICSplex by serving as the interface to other CICSplexes and external programs. There must be at least one CMAS in each MVS image on which you are running CICSplex SM. A single CMAS can manage CICS systems within one or more CICSplexes. See also *coordinating address space (CAS), managed application system (MAS)*.

**CICSplex SM token.** Unique, 4-byte values that CICSplex SM assigns to various elements in the API environment. Token values are used by CICSplex SM to correlate the results of certain API operations with subsequent requests.

**client program.** In dynamic routing, the application program, running in the *requesting region*, that issues a remote link request.

**CMAS.** CICSplex SM address space.

**CMAS link.** A communications link between one CICSplex SM address space (CMAS) and another CMAS or a remote managed application system (remote MAS). CMAS links are defined when CICSplex SM is configured.

**CODB.** A CICSplex SM transaction for interactive, system-level debugging of CMASs and of CICS/ESA, CICS/MVS, and CICS/VSE MASs. CODB must be used only at the request of customer support personnel.

**COD0.** A CICSplex SM transaction for interactive, method-level debugging of CMASs and of CICS/ESA, CICS/MVS, CICS/VSE, and CICS for OS/2 MASs. COD0 must be used only at the request of customer support personnel.

**COLU.** A CICSplex SM transaction for generating reports about CMAS and local MAS components. COLU must be used only at the request of customer support personnel.

**COMMAND field.** In the control area of an information display panel, the field that accepts CICSplex SM, ISPF, and TSO commands. Contrast with *option field*.

**command-level interface.** A CICSplex SM API interface that uses the CICS translator to translate EXEC CPSM statements into an appropriate sequence of instructions in the source language.

**Common Services.** A component of CICSplex SM that provides commonly requested services (such as GETMAIN, FREEMAIN, POST, and WAIT processing) to other CICSplex SM components.

**communication area (COMMAREA).** A CICS area that is used to pass data between tasks that communicate with a given terminal. The area can also be used to pass data between programs within a task.

**Communications.** A component of CICSplex SM that provides all services for implementing CMAS-to-CMAS and CMAS-to-MAS communication.

**context.** A named part of the CICSplex SM environment that is currently being acted upon by CICSplex SM. For configuration tasks, the context is a CICSplex SM address space (CMAS); for all other tasks, it is a CICSplex. See also *scope*.

**control area.** The top three lines of an information display panel, containing the panel title, the screen update time, the short message area, the COMMAND

and SCROLL fields, and the current window (CUR WIN) and alternate window (ALT WIN) fields.

**coordinating address space (CAS).** An MVS subsystem that provides ISPF end-user access to the CICSplex to be accessed. See also *CICSplex SM address space, managed application system (MAS)*.

**coordinating address space subsystem ID.** Identifies the coordinating address space (CAS) which can be up to 4 characters, to be connected to when issuing CICSplex SM requests. The name of the CAS is installation-dependent, and is defined in the CICSplex SM user profile.

**cross-system coupling facility (XCF).** XCF is a component of MVS that provides functions to support cooperation between authorized programs running within a sysplex.

**current window.** The window to which the results of all commands issued in the COMMAND field are directed, unless otherwise requested. Contrast with *alternate window*.

**current window (CUR WIN) field.** In the control area of an information display panel, the field that contains the window number of the current window. You can change the number in this field to establish a new current window.

**custom-built installation process offering (CBIPO).** A product that simplifies the ordering, installation, and service of MVS system control programs and licensed programs by providing them with current updates and corrections to the software that is already integrated.

**custom-built product delivery offering (CBPDO).** A customized package of both products and service, or of service only, for MVS system control programs and licensed programs.

## D

**Data Cache Manager.** A component of CICSplex SM that manages logical cache storage for use by other CICSplex SM components.

**data repository.** In CICSplex SM, the VSAM data set that stores administrative data, such as topology and monitor definitions, for a CICSplex SM address space (CMAS).

**Data Repository.** A component of CICSplex SM that provides methods for creating, accessing, updating, and deleting data in the CICSplex SM data repository. See also *Managed Object Services*.

**Database Control (DBCTL).** An IMS/ESA facility providing an interface between CICS/ESA and IMS/ESA

that allows access to IMS DL/I full-function databases and to data-entry databases (DEDBs) from one or more CICS/ESA systems.

**Database 2 (DB2).** An IBM licensed program. DB2 is a full-function relational database management system that presents a data structure as a table consisting of a number of rows (or records) and a number of columns.

**DBCTL.** Database Control.

**DB2.** Database 2.

**derived field.** On a monitor view, a field whose value does not come directly from CICS or CICSplex SM data, but is calculated based on the values in other fields. See also *derived value*.

**derived value.** A rate, average, or percentage that results from CICSplex SM processing of CICS statistics.

**display area.** On an information display panel, the area where windows can be opened to display data. The display area appears below the control area. The bottom two lines of the display area can be used to display the PF key assignments in effect for a CICSplex SM session.

**display attributes.** A CICSplex SM user profile option that controls the appearance of the window information line, field headings, and threshold values in a view.

**display command.** A CICSplex SM command that extends the ISPF interface to create and control a multiwindow environment.

**distributed program link (DPL).** Function of CICS intersystem communication that enables CICS to ship LINK requests between CICS regions.

**distributed routing program (DSRTPGM).** A CICS-supplied user-replaceable program that can be used to dynamically route:

- CICS BTS processes and activities
- Transactions started by non-terminal related EXEC CICS START commands

**DPL.** Distributed program link.

**DTR.** Dynamic transaction routing.

**dynamic routing.** The automatic routing of a transaction or program, at the time it is initiated, from a requesting region to a suitable target region. Routing terminal data to an alternative transaction at the time the transaction is invoked. To do this, CICS allows the

dynamic routing program to intercept the terminal data and redirect it to any system and transaction it chooses. See also dynamic routing program (EYU9XLOP)

**dynamic routing program (EYU9XLOP).** A user-replaceable CICS program that selects dynamically both the system to which a routing request is to be sent and the transaction's remote name. The alternative to using this program is to make these selections when a remote transaction is defined to CICS (static routing). See also *static routing*

**dynamic transaction routing (DTR).** The automatic routing of a transaction, at the time it is initiated, from a transaction-owning region (TOR) to a suitable application-owning region (AOR).

## E

**Environment Services System Services (ESSS).** A component of CICSplex SM that implements the formal MVS/ESA subsystem functions required by the product. ESSS provides cross-memory services, data space management, connection services, and lock management. An ESSS system address space is created at CICSplex SM initialization and remains in the MVS image for the life of the IPL.

**ESSS.** Environment Services System Services.

**evaluation definition.** In real-time analysis, a definition of the resources that are to be sampled. When the result of an evaluation is true, an associated analysis definition is used to determine whether a notifiable condition has occurred.

**event.** A significant occurrence within the CICSplex or system for which the user has requested notification. For example, the end of processing, a subsystem failure, or any unusual condition in the system could be defined by a user as an event.

**event notification.** A CICSplex SM notification of a significant occurrence within a CICSplex or CICS system.

**extended diagnostic mode (XDM).** A CICSplex SM online internal diagnostic facility. XDM provides no information about resources managed by CICSplex SM, and should be turned on only at the request of IBM customer support personnel. XDM can be turned on and off in the CICSplex SM user profile.

**external notification.** In RTA, an event notification, generic alert, or operator message issued when a notifiable condition occurs.

## F

**file-owning region.** In a CICSplex configuration, a CICS system devoted to managing CICS file access.

**filter expression.** A character string that consists of logical expressions to be used in filtering resource table records. A filter expression is made up of one or more attribute expressions.

**FOR.** File-owning region.

**form.** The way in which data obtained from a query is presented in a view. See also *query*, *view*.

## G

**generic alert.** A Systems Network Architecture (SNA) Network Management Vector that enables a product to signal a problem to the network. CICSplex SM uses generic alerts as part of its interface to NetView.

**GMFHS.** Graphic Monitor Facility host subsystem.

**goal algorithm.** In CICSplex SM's workload balancing, an algorithm used to select an AOR to process a dynamic transaction. Using the goal algorithm, CICSplex SM selects the AOR that is the least affected by conditions such as short-on-storage, SYSDUMP, and TRANDUMP; is the least likely to cause the transaction to abend; and is most likely to enable the transaction to meet response-time goals set for it using the Workload Manager component of MVS/ESA SP 5.1. Contrast with *queue algorithm*.

**Graphic Monitor Facility host subsystem.** A NetView feature that manages configuration and status updates for non-SNA resources.

## H

**hyperlink.** A direct connection between the data in one CICSplex SM view and a view containing related information. For example, from a view that lists multiple CICS resources, there may be a hyperlink to a detailed view for one of the resources. To use a hyperlink, place the cursor in the data portion of a hyperlink field and press Enter.

**hyperlink field.** On a CICSplex SM view, a field for which a hyperlink is defined. The headings of hyperlink

fields are shown in high intensity or color, depending on the terminal type.

## I

**IBM CICSplex System Manager for MVS/ESA (CICSplex SM).** An IBM CICS system-management product that provides a single-system image and a single point of control for one or more CICSplexes that can be installed on heterogeneous operating systems.

**indirect CMAS.** A CICSplex SM address space (CMAS) that the local CMAS can communicate with via an adjacent CMAS. There is no direct CMAS-to-CMAS link between the local CMAS and an indirect CMAS. Contrast with *adjacent CMAS*. See also *local CMAS*.

**information display panel.** The panel that supports the CICSplex SM window environment. It consists of a control area and a display area. CICSplex SM views are displayed in windows within the display area of this panel.

**information display parameters.** A CICSplex SM user profile option that defines the initial screen configuration, how frequently the screen will be updated by ASU, and how long a window will wait for command processing to complete before timing out.

**installation verification procedure (IVP).** A procedure distributed with a system that tests the newly generated system to verify that the basic facilities of the system are functioning correctly.

**interregion communication.** Synonym for *multiregion operation*.

**intersystem communication (ISC).** Communication between separate systems by means of SNA networking facilities or by means of the application-to-application facilities of an SNA access method.

**intertransaction affinity.** A relationship between CICS transactions, usually the result of the ways in which information is passed between those transactions, that requires them to execute in the same CICS region. Intertransaction affinity imposes restrictions on the dynamic routing of transactions.

**IRC.** Interregion communication.

**ISC.** Intersystem communication.

**IVP.** Installation verification procedure.

## K

**Kernel Linkage.** A component of CICSplex SM that is responsible for building data structures and managing the interfaces between the other CICSplex SM components. The environment built by Kernel Linkage is known as the method call environment.

## L

**line command field.** In a CICSplex SM view, the 3 character field, to the left of the data, that accepts action commands.

**local CMAS.** The CICSplex SM address space (CMAS) that a user identifies as the current context when performing CMAS configuration tasks.

**local MAS.** A managed application system (MAS) that resides in the same MVS image as the CICSplex SM address space (CMAS) that controls it and that uses the Environment Services System Services (ESSS) to communicate with the CMAS.

**logical scope.** A set of logically related CICS resources that are identified in a CICSplex SM resource description. A logical scope can be used to qualify the context of a CICSplex SM request.

## M

**maintenance point.** A CICSplex SM address space (CMAS) that is responsible for maintaining CICSplex SM definitions in its data repository and distributing them to other CMASs involved in the management of a CICSplex. See also *data repository*.

**Major object descriptor block (MODB).** In CICSplex SM, a control structure built by Kernel Linkage during initialization of a CICSplex SM component that contains a directory of all methods that make up that component. The structure of the MODB is the same for all components.

**Major object environment block (MOEB).** In CICSplex SM, a control structure built by Kernel Linkage during initialization of a CICSplex SM component and pointed to by the MODB. The MOEB stores information critical to a CICSplex SM component and anchors data used by the component. The structure of the MOEB is unique to the component it supports.

**MAL.** Message argument list.

**managed application system (MAS).** A CICS system that is being managed by CICSplex SM. See *local MAS*, *remote MAS*.

**managed object.** A CICSplex SM-managed CICS resource or a CICSplex SM definition represented by a resource table. A view is based on a single managed object.

**Managed Object Services.** A subcomponent of the Data Repository component of CICSplex SM that translates a request for data (from real-time analysis, for example) into the method calls required to obtain the data.

**MAS.** Managed application system.

**MAS agent.** A CICSplex SM component that acts within a CICS system to provide monitoring and data collection for the CICSplex SM address space (CMAS). The level of service provided by a MAS agent depends on the level of CICS the system is running under and whether it is a local or remote MAS. See also *CICSplex SM address space (CMAS)*, *local MAS*, *remote MAS*.

**MAS resource monitoring (MRM).** In real-time analysis, resource monitoring at the CICS system level; it results in one notification of a condition for each system in which it occurs. If the same condition occurs in three CICS systems where MAS resource monitoring is active, three notifications are issued. Contrast with *analysis point monitoring*.

**Message argument list (MAL).** In CICSplex SM, a data structure passed between methods using Kernel Linkage method call services.

**message line.** On an information display panel, the line in the control area where a long message appears when the HELP command is issued in response to a short message. The message line temporarily overlays the CURR WIN and ALT WIN fields.

**Message Services.** A component of CICSplex SM that provides services for building and issuing MVS/ESA console messages to other CICSplex SM components.

**meta-data.** Internal data that describes the structure and characteristics of CICSplex SM managed objects.

**method.** (Action.) An application programming interface (API) instruction that resolves into an EXEC CICS command, issued against one or more resources in one or more CICS systems, within the current context and scope.

**method.** In CICSplex SM, one of the programs that make up a CICSplex SM component. See also *message argument list (MAL)*.

**mirror transaction.** CICS transaction that recreates a request that is function shipped from one system to another, issues the request on the second system, and passes the acquired data back to the first system.



**MODB.** Major object descriptor block.

**modification expression.** A character string that defines the changes to be made to a resource attribute. A modification expression is made up of one or more attribute expressions.

**MOEB.** Major object environment block.

**monitor definition.** A user-defined statement of the specific resource occurrences (such as the program named PAYROLL) to be monitored by CICSplex SM. A monitor definition can either be linked to a monitor specification as part of a monitor group or be installed directly into an active CICS system. See also *monitor group*, *monitor specification*.

**monitor group.** A user-defined set of CICSplex SM monitor definitions that can either be linked to a monitor specification for automatic installation or be installed directly into an active CICS system. See also *monitor definition*, *monitor specification*.

**monitor interval.** The number of minutes that are to elapse before the statistics counters containing accumulated resource monitoring data are automatically reset. This value is part of a CICSplex definition and affects all of the CICS systems and CICS system groups associated with that CICSplex. See also *period definition*, *sample interval*.

**monitor specification.** A user-defined statement of the types of resources (such as programs) to be monitored by CICSplex SM and how often data should be collected. A monitor specification is associated with a CICS system and is automatically installed each time the CICS system starts up. See also *monitor definition*, *monitor group*.

**Monitoring Services.** A component of CICSplex SM that is responsible for monitoring resources within a CICS system and making the collected data available to other CICSplex SM components.

**MRM.** MAS resource monitoring.

**MRO.** Multiregion operation.

**MSM.** MultiSystem Manager.

**multiregion operation (MRO).** Communication between CICS systems without the use of SNA network facilities. Synonymous with *interregion communication*.

**MultiSystem Manager.** An object-oriented, graphical systems management application that runs under NetView for MVS.

**MVS image.** A single instance of the MVS operating system.

**MVS system.** An MVS image together with its associated hardware.

## N

**NetView.** An IBM network management product that can provide rapid notification of events and automated operations. CICSplex SM can be set up to send generic alerts to NetView as part of its event processing capabilities.

**NetView Graphic Monitor Facility (NGMF).** A function of the NetView program that provides the network operator with a graphic topological presentation of a network controlled by the NetView program and that allows the operator to manage the network interactively.

**NetView program.** An IBM licensed program used to monitor and manage a network and to diagnose network problems.

**NGMF.** NetView Graphic Monitor Facility.

**notification.** A message that is generated asynchronously by a CICSplex SM managed object to describe an event related to the object.

## O

**option field.** On a CICSplex SM menu, the field in which you can specify an option number or letter. Contrast with *command field*.

**order expression.** A character string that defines either the attributes to be used in sorting resource table records, or the attributes to be included in a resource table view. An order expression is made up of one or more attribute expressions.

**override expression.** A character string that defines the changes to be made to a resource attribute. An override expression is made up of one or more attribute expressions.

**overtyping field.** On a CICSplex SM view, a field containing a value that can be changed by typing a new value directly into the field. Values that can be overtyped are shown in high intensity or color, depending on the terminal type. Acceptable values for overtyping fields are listed with the description of each view. See also *action command*.

## P

**parameter expression.** A character string that defines the parameters required for an action to complete or a definition to be processed.

**parameter repository.** In CICSplex SM, a data set that stores cross-system communication definitions that allow one coordinating address space (CAS) to communicate with other CASs.

**period definition.** A user-defined range of hours and minutes and the time zone to which that range applies. A period definition is used to indicate when an action, such as resource monitoring, is to occur. See also *monitor interval*, *sample interval*.

**PlexManager.** A service utility that can be used to manage the communication connections between multiple coordinating address spaces (CASs) and between a CAS and its associated CICSplex SM address spaces (CMASs) and CICSplexes.

**process.** See *BTS process*

**processing thread.** A connection between an application program and the CICSplex SM API. A program can establish multiple processing threads, but each one is considered a unique API user; no resources can be shared across the boundary of a thread.

**pseudoconversation.** A CICS application designed to appear to the user as a continuous conversation, but that consists internally of multiple separate tasks.

## Q

**query.** A request for specific data that is generated by a view command. See also *form*, *view*.

**queue algorithm.** In CICSplex SM's workload balancing, an algorithm used to select an AOR to process a dynamic transaction. Using the queue algorithm, CICSplex SM selects the AOR that has the shortest queue of transactions (normalized to MAXTASKs) waiting to be processed; is the least affected by conditions such as short-on-storage, SYSDUMP, and TRANDUMP; and is the least likely to cause the transaction to abend. Contrast with *goal algorithm*.

**Queue Manager.** A component of CICSplex SM that creates and manages queues of data in a cache that is shared by a CMAS and its local MASs.

## R

**RACF.** Resource Access Control Facility.

**real-time analysis (RTA).** A component of CICSplex SM that is responsible for monitoring the status of a CICS system or resource against its desired status, and issuing one or more external notifications when deviations occur.

**record pointer.** An internal indicator of the next resource table record to be processed in a result set.

**related scope.** A CICS system where resources defined to CICSplex SM as remote should be assigned and, optionally, installed as local resources. See also *target scope*.

**remote MAS.** A managed application system (MAS) that uses MRO or LU 6.2 to communicate with the CICSplex SM address space (CMAS) that controls it. A remote MAS may or may not reside in the same MVS image as the CMAS that controls it.

**requesting region.** The region in which a dynamic routing request originates. For dynamic transaction routing and inbound client dynamic program link requests, this is typically a TOR; for dynamic START requests and peer-to-peer dynamic program link requests, this is typically an AOR.

**resource.** Any physical or logical item in a CICS system, such as a transient data queue, a buffer pool, a file, a program, or a transaction.

**Resource Access Control Facility (RACF).** An IBM licensed program that provides for access control by identifying and verifying the users to the system, authorizing access to protected resources, logging any detected unauthorized attempts to enter the system, and logging the detected accesses to protected resources.

**resource assignment.** A user-defined statement that selects resource definitions to be assigned to CICS systems and, optionally, specifies resource attributes to override those definitions. A resource assignment applies to a single resource type and must be associated with a resource description. See also *resource definition*, *resource description*.

**resource attribute.** A characteristic of a CICS resource, such as the size of a buffer pool.

**resource definition.** In CICSplex SM, a user-defined statement of the physical and operational characteristics of a CICS resource. Resource definitions can be associated with resource descriptions as part of a resource group. See also *resource description*, *resource group*.

**resource description.** A user-defined set of CICSplex SM resource definitions that can be automatically installed in CICS systems and named as a logical scope for CICSplex SM requests. Resource descriptions represent the largest set of CICS resources that can be managed by CICSplex SM as a single entity. A resource description can be associated with one or more resource assignments. See also *logical scope*, *resource assignment*, *resource definition*.

**resource group.** A user-defined set of CICSplex SM resource definitions. A resource group can be associated with resource descriptions either directly or by means of resource assignments. See also *resource assignment*, *resource definition*, *resource description*.

**Resource Object Data Manager (RODM).** A component of the NetView program that operates as a cache manager and that supports automation applications. RODM provides an in-memory cache for maintaining real-time data in an address space that is accessible by multiple applications.

**resource table.** The external representation of a CICSplex SM managed object. A resource table defines all the attributes, or characteristics, of a managed object.

**resource table attribute.** A characteristic of a CICSplex SM managed object, as represented by a field in a resource table.

**resource type.** A group of related resources, such as files.

**result set.** A logical group of resource table records that can be accessed, reviewed, and manipulated by an API program.

**retention period.** For a monitored CICS system, the period of time for which monitor data is retained after the system becomes inactive. If a system is being monitored, becomes inactive, and remains inactive beyond the specified retention period, the monitor data is discarded. If the system becomes active before the retention period expires, the monitor data gathered before the system became inactive is retained, and monitoring continues.

**RODM.** Resource Object Data Manager.

**routing region.** The region in which the decision is made as to which is the most suitable target region for a dynamic routing request. For dynamic transaction routing, dynamic terminal-related START requests, and inbound client dynamic program link requests, this is typically a TOR; for non-terminal-related START requests, dynamic peer-to-peer program link requests, and CICS BTS activities, this is typically an AOR.

**RTA.** real-time analysis.

**run-time Interface.** A CICSplex SM API interface that accepts commands in the form of text strings and generates the appropriate API calls. The run-time interface supports programs written as REXX EXECs.

## S

**SAM.** System availability monitoring.

**sample interval.** The duration, in seconds, between occurrences of data collection for a specific resource type. See also *monitor interval*, *period definition*, *resource type*.

**scope.** A named part of the CICSplex SM environment that qualifies the context of a CICSplex SM request. The scope can be the CICSplex itself, a CICS system, a CICS system group, or any set of CICS resources that are defined as a logical scope in a CICSplex SM resource description. For configuration tasks, where the context is a CICSplex SM address space (CMAS), the scope is ignored. When you are applying security, scope must be a single CICS system or CICSplex. It cannot be a CICS system group or any combination of individual CICSplexes or CICS systems. See also *context*, *logical scope*.

**screen configuration.** A user-defined, named layout of windows and the context, scope, view, and sort order associated with each. The initial configuration to be displayed when CICSplex SM is accessed can be identified on the user profile.

**screen repository.** In CICSplex SM, a data set that stores screen configuration definitions created by the SAVESCR display command. See also *screen configuration*.

**selection list.** In CICSplex SM, a data set that stores cross-system communication definitions that allow one coordinating address space (CAS) to communicate with other CASs.

**selection list.** A list of named items, such as views or screen configurations, from which one can be selected.

**server program.** In dynamic routing, the application program specified on the link request, and which is executed in the *target region*.

**service point.** One of the combinations of products and contexts that is known to the coordinating address space (CAS) to which you are connected. See also *context*.

**session control parameters.** A CICSplex SM user profile option that sets the coordinating address space (CAS) subsystem ID used for accessing CICSplex SM

views and controls the extended diagnostic mode (XDM).

**short message area.** In the control area of an information display panel, that part of the title line that displays short messages.

**single point of control.** The ability to access and manage all CICS systems and their resources in a CICSplex from a single terminal or user session.

**single system image.** The collection and presentation of data about multiple CICS systems as though they were a single CICS system. In CICSplex SM, the single-system image is provided by the CICSplex SM address space (CMAS).

**specification.** See *analysis specification, monitor specification, workload specification*.

**Starter Set.** A part of CICSplex SM comprising sample CICSplex SM definitions and sample JCL. The Starter Set samples may be used as supplied for educational purposes. They may also be copied and adapted for the customer environment.

**static routing.** Non-dynamic routing. The routing request is routed to a predetermined system. Static transaction routing occurs when NO is specified in the Dynamic field in either the transaction definition or the program definition. In both cases, the request is routed to the system named in the Remote Sysid field.

**status definition.** In real-time analysis, a definition of a user-written program to be invoked at specified intervals to evaluate the status of a non-CICS resource.

**summarized result set.** A special type of result set that is produced by grouping, or summarizing, the resource table records in a result set. See also *result set*.

**summary expression.** A character string that consists of one or more summary options and the resource table attributes to which they apply. See also *summary option*.

**summary option.** A value that indicates how the attribute values in a resource table are to be summarized.

**sysplex.** A set of MVS systems communicating and cooperating with each other through specific multisystem hardware components and software services to process customer workloads.

**system availability monitoring (SAM).** In real-time analysis, the monitoring of CICS systems to determine whether: they are active during their defined hours of operation; they are experiencing a short-on-storage, SYSDUMP, TRANDUMP, MAXTASK, or STALL

condition. If a CICS system becomes inactive or one of the specified conditions occurs, an external notification is issued.

**system image.** The representation of a program and its related data as it exists in main storage.

## T

**target region.** The region selected from a set of target regions as the most suitable region in which to execute the work request. For all dynamic routing requests, this is typically an AOR.

**target scope.** A CICS system or CICS system group where resources defined to CICSplex SM should be assigned and, optionally, installed. See also *related scope*.

**temporary maintenance point.** A CICSplex SM address space (CMAS) that serves as the maintenance point when the identified maintenance point is unavailable. See also *maintenance point*.

**terminal-owning region.** In a CICSplex configuration, a CICS region devoted to managing the terminal network. For dynamic routing, the terms *requesting region* and *routing region* are used instead of TOR to signify the role of the region in the dynamic routing request.

**thread.** See *processing thread*.

**time-period definition.** A user-defined range of hours and minutes, and the time zone to which that range applies. A time-period definition is used to indicate when an action, such as resource monitoring, is to occur.

**token.** See *CICSplex SM token, user token*.

**topology.** An inventory of CICS and CICSplex SM resources, and a map of their relationships. CICSplex SM supports the definition of resource and system topology.

**topology definition.** A named subset of CICS and CICSplex SM resources. Topology definitions are user-created and can include CICSplexes, CICS systems, and CICS system groups.

**Topology Services.** A component of CICSplex SM that is responsible for maintaining topology information about CICSplexes and resources, and making it available to other CICSplex SM components.

**TOR.** Terminal-owning region.

**Trace Services.** A component of CICSplex SM that provides other CICSplex SM components with the

ability to write trace records to the CICS trace table and trace data sets. Trace Services also writes trace records created by a MAS to the trace table and data set of the managing CMAS.

**transaction group.** A user-defined, named set of transactions that determines the scope of workload balancing and the affinity relationships between transactions.

## U

**user token.** Unique, 1- to 4-byte values that an API user can assign to asynchronous requests. User token values are not used by CICSplex SM; they are simply held until the request is complete and then returned to the user.

## V

**view.** In the CICSplex SM API, a temporary, customized form of a resource table. A view can consist of some or all of the resource table attributes in any order. In the CICSplex SM ISPF end-user interface, a formatted display of selected data about CICS resources or CICSplex SM definitions. The data in a view is obtained from a query and can be presented in one or more forms. The data can be limited to a subset of CICSplex resources or definitions by establishing a context and scope.

**view command.** A CICSplex SM command that displays a view in a window of the display area. The name of the view displayed matches the name of the view command. See also *view*.

## W

**window.** In CICSplex SM, a subdivision of the display area. The results of any CICSplex SM view or display command are directed to a single window, which is the current window by default. Contrast with *view*. See also *current window*, *alternate window*.

**window identifier.** On a window information line, the field that identifies the window. A window identifier consists of a one-character status code and a number in the range 1 through 20.

**window information line.** The top line of each window in the display area. It includes the window identifier, the name of the view displayed in the window, the context and scope in effect, the date and time when the view was last refreshed, and the product name.

**window number.** A number assigned by CICSplex SM to a window when it is opened. The window number is the second part of the window identifier on the window information line.

**window status code.** A one-character code that indicates whether a window is ready to receive commands, is busy processing commands, is not to be updated, or contains no data. It also indicates when an error has occurred in a window. The window status code is the first character of the window identifier on the window information line.

**WLM.** Workload Manager.

**workload.** The total number of transactions that a given CICSplex is intended to process in a specific period. For example, a workload could be expressed as a number of transactions per hour, or per day. In CICSplex SM, a named set of transactions and CICS systems, acting as requesting regions, routing regions, and target regions that form a single, dynamic entity.

**workload balancing.** The technique of balancing a workload across multiple target regions that are capable of processing the work.

**workload definition.** A user-defined statement of the transaction groups associated with a CICS system that is an AOR. A workload definition can either be linked to a workload specification as part of a workload group or be installed directly into an active workload. See also *workload group*, *workload specification*.

**workload group.** A user-defined set of CICSplex SM workload definitions that can either be linked to a workload specification for automatic installation or be installed directly into an active workload. See also *workload definition*, *workload specification*.

**Workload Manager (WLM).** A component of CICSplex SM that is responsible for managing the transaction workload in a CICSplex through the use of dynamic transaction routing.

**workload separation.** The technique of separating a workload into discrete parts, and allocating specific transactions to specific AORs.

**workload specification.** A user-defined statement that identifies a workload and a set of CICS systems acting as AORs. A workload specification also provides default management criteria for transactions that are not defined to CICSplex SM. It is associated with a CICS system that is a TOR and is automatically installed each time the CICS system starts up. See also *workload definition*, *workload group*.

## **X**

**XCF.** Cross-system coupling facility of MVS/ESA.

**XDM.** Extended diagnostic mode

# Index

## A

abend compensation 64  
 ACTDEF view 80  
 action command 3, 98  
 ADMCONFIG view 38, 39  
 administering CAS-to-CAS links 37  
 administering the CMAS configuration 38  
 administering the topology of a CICSplex 37  
 ADMTOPOL view 40  
 affinity, intertransaction 62, 65  
 agent code, MAS 12  
 analysis definition 81  
     Starter Set 128  
 analysis group 81  
 analysis point monitoring (APM)  
     automation and 75  
     description of 80  
     implementing 84  
 analysis specification 81  
 AOC CICS Automation 76  
 APCMAS view 80  
 application programming interface (API) 6  
 APSPEC view 80  
 automatic installation  
     of a monitor definition 93  
     of a workload definition 73  
     of an analysis definition 84  
     of resources 55

## B

batched repository-update facility 7  
     description of 7, 17, 107  
     EXTRACT routine 17, 57  
     Starter Set use of 111  
 BATCHREP view 38, 107  
 Business Application Services (BAS)  
     creating resource definitions 52  
     definition of 4  
     description of 43  
     EXTRACT routine 57  
     functions 43  
     objects 16  
     resource installation 43  
     resource versions 44  
     security, special considerations 103  
     Starter Set samples 118

## C

CAS-to-CAS links 37

CASACT view 37  
 CASDEF view 37  
 CASDEFD view 37  
 CICS business transaction services (BTS) 4  
 CICS Monitoring Facility (CMF) 87, 88, 94  
 CICS system 19  
 CICS system group 10, 24  
     defining 40  
     identifying 40  
     Starter Set examples 112  
     using instead of CICSplexes 24  
 CICS system objects 16, 19  
 CICSGRP view 41  
 CICSplex  
     definition of 10  
     definitions 39  
     identifying 21  
     when to have more than one 23  
 CICSplex SM address space (CMAS)  
     administering 38  
     configuration 38  
     context for CICSplex SM commands 14  
     data repository 106  
     defining 38  
     definitions 37  
     links to other CMASs 27  
     maintenance point 30  
     NetView 13  
     performance considerations 27  
     preparing to set up 106  
     RODM 13  
     scope for CICSplex SM commands 14  
     use of ESSS 14  
     where to install 26  
 CICSplex SM object model, recommended usage  
     business application services 58  
     monitoring 94  
     real-time analysis 84  
     workload management 74  
 CICSplex SM, introduction to 1  
 CICSplex objects 16  
 CICSplex topology  
     administering 37  
     defining 37  
 CICSplex view 38  
 CICSsys view 41  
 CMAS view 38  
 CMASD view 38  
 CMASPLEX view 38  
 CMTCMDEF view 38  
 CMTCMLND view 38

## index

CMTMMLNK view 38  
CMTPMDEF view 38  
CMTPMLND view 38  
CMTPMLNK view 38  
command checking, CICS 103  
configuration 111  
    CMAS 38  
configuration definitions  
    Starter Set 115  
CONNDEF view 41, 49  
context for CICSplex SM commands 14  
coordinating address space (CAS)  
    defining 37  
    description of 14  
    installing 32  
    links to other CASs 33  
    preparing to set up 105  
    single point of control 33  
    Starter Set definitions 115  
    where to define 32  
copying definitions between CMASs 107  
CPLEXDEF view 38, 39  
CPLXCMAS view 38  
creating resource definitions 52

## D

data repository 7, 17, 106  
DB2CDEF view 49  
DB2EDEF view 49  
DB2TDEF view 49  
defining CAS-to-CAS links 37  
defining the CMAS configuration 37, 38  
defining the topology of a CICSplex 37, 39  
derived MONITOR data 88  
distributed model, dynamic routing 61  
distributed program link (DPL) 59  
documentation, CICSplex SM 100  
DTRINGRP view 66  
dynamic installation of resources 55  
dynamic routing 5, 59, 71  
    distributed program links 59  
    models 60  
    program, EYU9XLOP 59  
    START commands 59  
    transactions 59  
dynamic transaction routing 59

## E

entity types 101  
Environment Services System Services (ESSS) 12, 14  
EVALDEF view 80  
external messages, RTA 76  
external notifications, RTA 76

EXTRACT routine 17, 57  
EYU9XLOP 59

## F

FENODDEF view 49  
FEPOODEF view 49  
FEPRODEF view 49  
FETRGDEF view 49  
FILEDEF view 49  
FSEGDEF view 49  
functions of CICSplex SM 1

## G

generic alert, SNA  
    CMAS considerations 26  
generic names 35, 102  
goal algorithm 64, 97, 98  
group, CICS system 24, 40, 76

## H

hardware requirements 97  
hardware, prerequisite 98  
HTMLDEF view 49  
hub model, dynamic routing 60

## I

inconsistent set 53  
installation of resources  
    automatic 55  
    dynamic 55  
installation planning 97  
Installation Verification Procedures (IVPs) 114  
Interactive System Productivity Facility (ISPF)  
    and CAS 14  
    using with a CAS 33  
intertransaction affinity 62  
    defining to CICSplex SM 65  
    identifying 71

## J

Job Control Language (JCL)  
    supplied with the Starter Set 113  
JRNLDEF view 49  
JRNMDEF view 49

## L

links, communication  
    CAS-to-CAS 33  
    CMAS-to-CMAS 27  
    CMAS-to-remote MAS 12, 32



local MAS 12  
LSRDEF view 49

## M

maintenance point CMAS 30  
managed application system (MAS)  
  definition 11  
  identifying 32  
  local 12  
  preparing to set up 108  
  remote 12  
MAP command 17  
map of CICS systems, producing 19  
MAPDEF view 49  
MAS agent code 12  
MAS resource monitoring (MRM)  
  automation and 79  
  description of 78  
  implementing 83  
MAS view 42  
models, dynamic routing 60  
MONDEF view 89  
MONGROUP view 89  
MONINGRP view 89  
MONINSPC view 89  
monitor definition 89  
  Starter Set 125  
monitor group 89  
monitor interval 88, 91  
monitor specification 89  
monitoring  
  CICS Monitoring Facility (CMF) 94  
  definition of 6  
  introduction to 87  
  monitor interval 88, 91  
  NetView RODM interface 88  
  sample interval 89, 91  
  Starter Set samples 125  
MONSCOPE view 89  
MONSPEC view 89

## N

naming convention  
  CICSplex SM entities 35, 100  
  Starter Set 35, 100, 139  
NetView 13, 26, 88  
notifications, external, RTA 76

## O

operating objects 16  
operations views 4

## P

PARTDEF view 49  
performance considerations  
  CMAS 27  
  CMAS-to-CMAS links 29  
  of CICSplex SM monitoring 90  
PERIODEF view 41, 83, 103  
PLEX view 37  
PLEXOVER view 37  
prerequisite hardware 98  
prerequisite software 97  
PROCDEF view 49  
PROFDEF view 49  
PROGDEF view 49

## Q

queue algorithm 64

## R

RACF (Resource Access Control Facility) 1  
RASGNDEF view 48  
RASINDSC view 48  
RASPROC view 48  
RDSCPROC view 48  
real-time analysis (RTA) 6  
  analysis point monitoring (APM) 80, 84  
  AOC CICS Automation 76  
  definition of 5  
  external messages 76  
  implementing 83  
  introduction to 75  
  MAS resource monitoring (MRM) 78, 83  
  planning 82  
  SNA generic alert 76  
  Starter Set samples 128  
  system availability monitoring (SAM) 77, 83  
remote MAS  
  definition of 12  
  identifying 32  
  setting up 108  
  Starter Set sample 113  
RESDESC view 48  
RESGROUP view 48  
RESINDSC view 48  
RESINGRP view 48  
resource assignment  
  migrating toward using 57  
resource checking 52, 103  
Resource Object Data Manager (RODM)  
  activating the interface to 93  
  SNA generic alerts to 13  
  software release level 98

- resource versions 44
- resources
  - automatic installation of 55
  - dynamic installation of 55
- retention period
  - monitoring 92
- RQMDEF view 49
- RTADEF view 81
- RTAGROUP view 81
- RTAINAPS view 81
- RTAINGRP view 81
- RTAINSPC view 81
- RTASCOPE view 81
- RTASPEC view 81

## S

- sample interval
  - monitoring 89, 91
- samples, Starter Set 111
- scope for CICSplex SM commands 14
- SCREENS view 37
- security
  - BAS 56, 103
  - planning 102
  - RACF 1
- SESRES view 49
- SESSDEF view 41, 49
- simulating CICS security 103
- single point of control
  - definition of 3
  - role of CAS in providing 33
- single-system image (SSI)
  - definition of 3
  - role of CMAS in providing 13
- SNA generic alert 76
  - CMAS considerations 13, 26
- Software Installer for OS/2 104
- software requirements 97
- software, prerequisite 97
- staged implementation 36
- Starter Set
  - BAS samples 118
  - CAS definitions 115
  - configuration samples 115
  - definitions, supplied 114
  - installation requirements 113
  - JCL, supplied 113
  - monitoring samples 125
  - naming convention 139
  - purpose of 111
  - RTA samples 128
  - structure of 111
  - topology samples 116, 117
  - workload management samples 123

- starting CICSplex SM 105
- STATDEF view 81
- storage requirements 98
  - CMAS 98, 99
  - MAS 98, 99
  - remote MAS 100
  - workstation 100
- SYSGRPC view 41
- SYSLINK view 41, 49
- system availability monitoring (SAM)
  - See also* real-time analysis (RTA)
  - automation and 78
  - customizing external notifications 77
  - description of 77
  - implementing 83
- system group 24

## T

- TCPDEF view 49
- TDQDEF view 49
- TERMDEF view 49
- time zone 7, 103
- Tivoli Global Enterprise Manager
  - support for 18
- topology 3
  - administration 40
- topology definitions
  - Starter Set 116, 117
- TRANDEF view 49
- TRANGRP view 66
- TRNCLDEF view 49
- TSMDEF view 49
- TYPTMDEF view 49

## U

- unauthorized access to CICSplex SM, preventing 102
- updating the configuration 36

## V

- validating resources 52
- view
  - ACTDEF 80
  - ADMCONFIG 38
  - ADMTOPOL 40
  - APCMAS 80
  - APSPEC 80
  - BATCHREP 107
  - CASACT 37
  - CASDEF 37
  - CASDEFD 37
  - CICSGRP 41
  - CICSPLEX 38
  - CICSSYS 41

view (continued)

CMAS 38  
CMASD 38  
CMASPLEX 38  
CMTCMDEF 38  
CMTCMLND 38  
CMTCMLNK 38  
CMTPMDEF 38  
CMTPMLND 38  
CMTPMLNK 38  
CONNDEF 41, 49  
CPLEXDEF 38  
CPLXCMAS 38  
DB2CDEF 49  
DB2EDEF 49  
DB2TDEF 49  
DTRINGRP 66  
EVALDEF 80  
FENODDEF 49  
FEPOODEF 49  
FEPRODEF 49  
FETRGDEF 49  
FILEDEF 49  
FSEGDEF 49  
HTMLDEF 49  
JRNLDEF 49  
JRNMDEF 49  
LSRDEF 49  
MAPDEF 49  
MAS 42  
MONDEF 89  
MONGROUP 89  
MONINGRP 89  
MONINSPC 89  
MONSCOPE 89  
MONSPEC 89  
PARTDEF 49  
PERIODEF 41, 83, 103  
PLEX 37  
PLEXOVER 37  
PROCDEF 49  
PROFDEF 49  
PROGDEF 49  
PRTNDEF 49  
RASGNDEF 48  
RASINDSC 48  
RASPROC 48  
RDSCPROC 48  
RESDASC 48  
RESGROUP 48  
RESINDSC 48  
RESINGRP 48  
RQMDEF 49  
RTADEF 81  
RTAGROUP 81  
RTAINAPS 81

view (continued)

RTAINGRP 81  
RTAINSPC 81  
RTASCOPE 81  
RTASPEC 81  
SCREENS 37  
SESRES 49  
SESSDEF 41, 49  
STATDEF 81  
SYSGRPC 41  
SYSLINK 41, 49  
TCPDEF 49  
TDQDEF 49  
TERMDEF 49  
TRANDEF 49  
TRANGRP 66  
TRNCLDEF 49  
TSMDEF 49  
TYPTMDEF 49  
WLMDEF 67  
WLMGROUP 67  
WLMINGRP 67  
WLMINSPC 67  
WLMSCOPE 68  
WLMSPEC 68

## W

WLMDEF view 67  
WLMGROUP view 67  
WLMINGRP view 67  
WLMINSPC view 67  
WLMSCOPE view 68  
WLMSPEC view 68  
workload definition 67  
    Starter Set 123  
workload functions of CICSplex SM 59  
workload group 67  
workload management (WLM)  
    definition of 5  
    intertransaction affinity 62, 65  
    introduction to 59  
    Starter Set samples 123  
    workload balancing 63, 71  
        abend compensation 64  
        goal algorithm 64  
        queue algorithm 64  
    workload separation 65, 72  
workload specification 68



---

## Sending your comments to IBM

If you especially like or dislike anything about this book, please use one of the methods listed below to send your comments to IBM.

Feel free to comment on what you regard as specific errors or omissions, and on the accuracy, organization, subject matter, or completeness of this book.

Please limit your comments to the information in this book and the way in which the information is presented.

To request additional publications, or to ask questions or make comments about the functions of IBM products or systems, you should talk to your IBM representative or to your IBM authorized remarketer.

When you send comments to IBM, you grant IBM a nonexclusive right to use or distribute your comments in any way it believes appropriate, without incurring any obligation to you.

You can send your comments to IBM in any of the following ways:

- By mail, to this address:
  - Information Development Department (MP095)
  - IBM United Kingdom Laboratories
  - Hursley Park
  - WINCHESTER,
  - Hampshire
  - SO21 2JN
  - United Kingdom
- By fax:
  - From outside the U.K., after your international access code use 44–1962–870229
  - From within the U.K., use 01962–870229
- Electronically, use the appropriate network ID:
  - IBM Mail Exchange: GBIBM2Q9 at IBMMAIL
  - IBMLink™: HURSLEY(IDRCF)
  - Internet: idrcf@hursley.ibm.com

Whichever you use, ensure that you include:

- The publication number and title
- The topic to which your comment applies
- Your name and address/telephone number/fax number/network ID.



Program Number: 5655-147



Printed in the United States of America  
on recycled paper containing 10%  
recovered post-consumer fiber.

GC33-0786-03



*Spine information:*



CICS Transaction Server for OS/390

CICSplex® SM Concepts and Planning

*Release 3*