

CICS Explorer



Learning about the CICS Explorer

Using CICS Explorer plug-ins for
tools integration

Exploiting the CICS Explorer with
usage scenarios

Chris Rayns	Chris Phillips
Chris Baker	Kat Sharp
Diana Blair	Peter Siddell
Edoardo Comar	Colin Stone
Stewart Francis	Satish Tanna
Em James	Joe Winchester
	Will Yates



International Technical Support Organization

CICS Explorer

December 2009

Note: Before using this information and the product it supports, read the information in “Notices” on page ix.

First Edition (December 2009)

This edition applies to Version 4, Release 1, of CICS Transaction Server.

© Copyright International Business Machines Corporation 2009. All rights reserved.

Note to U.S. Government Users Restricted Rights -- Use, duplication or disclosure restricted by GSA ADP Schedule Contract with IBM Corp.

Contents

Notices	ix
Trademarks	x
Preface	xi
The team who wrote this book	xi
Become a published author	xiv
Comments welcome	xiv
Part 1. CICS Explorer introduction	1
Chapter 1. CICS Explorer introduction	3
1.1 Overview	4
1.2 Base Explorer capabilities	5
1.3 Plug-ins and RCP	9
1.3.1 Eclipse concepts	9
Chapter 2. Getting started with CICS Explorer	19
2.1 Using CICS Explorer with CICS TS 4.1	20
2.2 CICS Explorer can operate in two different ways	20
2.2.1 CICS Explorer directly with CICS	20
2.2.2 CICS Explorer directly with CICSplex SM	21
2.3 Setting up single server access	22
2.4 Updating an existing CICSplex SM setup for CICS Explorer	24
2.5 Setting up CICSplex SM for CICS Explorer	25
2.5.1 The basics of setting up CICSplex SM for CICS Explorer	25
2.5.2 Changing a System into a CMAS	27
2.5.3 Changing a system into a WUI server	33
2.5.4 Creating a CICSplex to manage your systems	38
2.5.5 Modifying your existing CICS system JCL	39
2.5.6 Conclusion	40
Chapter 3. Implementing IBM CICS Explorer	43
3.1 Installing CICS Explorer	44
3.1.1 Installing CICS Explorer locally	44
3.1.2 Installing CICS Explorer remotely	46
3.2 CICS Explorer security	47
3.2.1 Using HTTP Basic Authentication	48
3.2.2 Using SSL	48
3.3 Updating the CICS Explorer	49

3.3.1	Updating from the Internet	49
3.3.2	Updating from an archive file	51
3.3.3	Updating automatically	51
3.4	Enterprise deployment	53
3.4.1	Providing local mirrors.	53
3.4.2	Pre-installation customization	53
3.5	Plug-ins	55
Chapter 4. CICS Explorer base familiarization		59
4.1	Perspectives	60
4.2	Connections	60
4.2.1	Connection Manager.	60
4.2.2	Connections Preference page.	62
4.2.3	CICS Explorer connectivity	64
4.3	Views.	66
4.3.1	The CICSplex Explorer view	66
4.3.2	The CICSplex Repositories view.	67
4.3.3	CICS Object Table views	68
4.4	The Resources View	70
4.4.1	Properties View	77
4.4.2	Status bar and error log	77
4.5	Editors	78
4.6	Creating new definitions	85
Chapter 5. CICS Explorer IA plug-in familiarization		89
5.1	CICS IA introduction	90
5.2	What can CICS IA do for you?	91
5.2.1	CICS IA highlights.	91
5.2.2	What questions does CICS IA answer?	92
5.3	What is CICS IA?	92
5.4	CICS IA plug-in overview	95
5.5	Toolbar searches and queries.	96
5.5.1	Toolbar searches	96
5.5.2	Queries	97
5.6	Programs and Transactions windows	98
5.6.1	Searching programs and transactions	99
5.7	Regions window	100
5.8	Properties window	102
5.9	Supplied queries with CICS IA plug-in	103
5.10	Creating your own queries in the CICS IA plug-in.	109
5.10.1	Adding filters to the query	112
5.10.2	Modifying an existing query.	114
5.10.3	Saving your queries in folders.	116

5.10.4	Creating a query folder	116
5.11	Analyzing query and search results	117
5.12	Comparing query and search results	119
Chapter 6. CICS Explorer CM plug-in familiarization		123
6.1	Introduction	124
6.2	CICS CM plug-in overview	124
6.2.1	Setting up the CICS CM plug-in	124
6.3	CM perspective overview	126
6.4	Configurations view	127
6.5	Lists View	129
6.6	Groups View	130
6.7	Definitional Views	132
6.8	Creating, editing, and deleting a resource definition	133
6.8.1	Creating resources	133
6.8.2	Editing a resource	134
6.8.3	Deleting a resource	136
6.8.4	Installing a resource	136
6.9	Adding and removing from groups	136
6.10	History	136
6.10.1	CICS CM journal	136
6.10.2	History View	137
6.11	Searches and the search view	140
6.11.1	Specific searches	141
6.11.2	Using the search dialog	141
6.11.3	Search results view	144
6.12	Cleaning up	145
Chapter 7. CICS Explorer PA plug-in familiarization		147
7.1	Overview of CICS PA	148
7.1.1	Runtime product	148
7.1.2	The plug-in	148
7.2	The PA Explorer environment	149
7.3	PA views and editors in detail	151
7.3.1	The Project Explorer	151
7.3.2	The Sheet View	153
7.3.3	Pie chart view	155
7.3.4	Bar charts	156
7.3.5	Timeline charts	158
7.3.6	Properties View	161
7.3.7	Integrating with other plug-ins	162
7.4	CSV data extraction process	163
7.4.1	Server process	163

7.4.2 Plug-in process	164
7.5 Database extraction process	165
7.5.1 Server process	165
7.5.2 Plug-in process	165
Chapter 8. CICS Explorer troubleshooting	171
8.1 Workspace and logs	172
8.1.1 Capturing trace data	172
8.1.2 Tracing options	173
8.1.3 The Error Log View	174
8.1.4 Viewing the error log in an external application	175
8.2 Preparing error data for IBM service	177
8.2.1 Collecting error data when the CICS Explorer is not usable.	177
8.2.2 Searching for IBM MustGather information	178
8.3 Plug-in specific issues	179
8.3.1 Performance Analyzer	179
8.3.2 CSV file size and CICS Explorer runtime memory	179
Part 2. CICS Explorer scenarios	181
Chapter 9. CICS Explorer - MQ application migration	183
9.1 Identifying MQ Applications	184
9.2 Obtaining more information about the MAIL transaction	187
9.3 Locating the MQ Application in CICS CM	192
9.4 Looking at performance data for the MAIL transaction	195
9.4.1 Performance data for MAIL on CICS TS V3.1	195
9.4.2 Performance data for MAIL on CICS TS V4.1	199
9.5 Can we make the MAIL transaction threadsafe	202
9.6 Using CICS PA to analyze the (threadsafe) MAIL application	211
Chapter 10. CICS Explorer clean up scenario	215
10.1 Orphaned resources	216
10.2 Duplicate resources	223
Chapter 11. CICS Explorer performance scenario	227
11.1 Resolving system performance problems	228
11.2 Drilling down into transaction detail	232
Chapter 12. CICSplex SM enablement using the CICS Explorer	243
12.1 Overview of transaction affinities	244
12.1.1 Inter-transaction affinity	244
12.1.2 Transaction-system affinity	245
12.1.3 Affinity relations	245
12.1.4 Affinity lifetimes	246

12.2	Running CICS Interdependency Analyzer for affinities	247
12.3	Loading the DB2 database with the collected affinity data	248
12.4	Using the CICS IA plug-in to identify affinities	252
12.5	Workload management considerations	258
12.6	Creating the definitions for workload management	259
12.7	Migrating the definitions using CICS Configuration Manager	261
Chapter 13. CICS Explorer resource manipulation scenarios		265
13.1	Resource locking scenarios	266
13.1.1	VSAM record locking	266
13.2	Resource state manipulation	270
13.3	Discarding resources	277
Related publications		289
	IBM Redbooks	289
	Other publications	289
	Online resources	289
	How to get Redbooks	290
	Help from IBM	290

Notices

This information was developed for products and services offered in the U.S.A.

IBM may not offer the products, services, or features discussed in this document in other countries. Consult your local IBM representative for information on the products and services currently available in your area. Any reference to an IBM product, program, or service is not intended to state or imply that only that IBM product, program, or service may be used. Any functionally equivalent product, program, or service that does not infringe any IBM intellectual property right may be used instead. However, it is the user's responsibility to evaluate and verify the operation of any non-IBM product, program, or service.

IBM may have patents or pending patent applications covering subject matter described in this document. The furnishing of this document does not give you any license to these patents. You can send license inquiries, in writing, to:
IBM Director of Licensing, IBM Corporation, North Castle Drive, Armonk, NY 10504-1785 U.S.A.

The following paragraph does not apply to the United Kingdom or any other country where such provisions are inconsistent with local law: INTERNATIONAL BUSINESS MACHINES CORPORATION PROVIDES THIS PUBLICATION "AS IS" WITHOUT WARRANTY OF ANY KIND, EITHER EXPRESS OR IMPLIED, INCLUDING, BUT NOT LIMITED TO, THE IMPLIED WARRANTIES OF NON-INFRINGEMENT, MERCHANTABILITY OR FITNESS FOR A PARTICULAR PURPOSE. Some states do not allow disclaimer of express or implied warranties in certain transactions, therefore, this statement may not apply to you.

This information could include technical inaccuracies or typographical errors. Changes are periodically made to the information herein; these changes will be incorporated in new editions of the publication. IBM may make improvements and/or changes in the product(s) and/or the program(s) described in this publication at any time without notice.

Any references in this information to non-IBM Web sites are provided for convenience only and do not in any manner serve as an endorsement of those Web sites. The materials at those Web sites are not part of the materials for this IBM product and use of those Web sites is at your own risk.

IBM may use or distribute any of the information you supply in any way it believes appropriate without incurring any obligation to you.

Information concerning non-IBM products was obtained from the suppliers of those products, their published announcements or other publicly available sources. IBM has not tested those products and cannot confirm the accuracy of performance, compatibility or any other claims related to non-IBM products. Questions on the capabilities of non-IBM products should be addressed to the suppliers of those products.

This information contains examples of data and reports used in daily business operations. To illustrate them as completely as possible, the examples include the names of individuals, companies, brands, and products. All of these names are fictitious and any similarity to the names and addresses used by an actual business enterprise is entirely coincidental.

COPYRIGHT LICENSE:

This information contains sample application programs in source language, which illustrate programming techniques on various operating platforms. You may copy, modify, and distribute these sample programs in any form without payment to IBM, for the purposes of developing, using, marketing or distributing application programs conforming to the application programming interface for the operating platform for which the sample programs are written. These examples have not been thoroughly tested under all conditions. IBM, therefore, cannot guarantee or imply reliability, serviceability, or function of these programs.

Trademarks

IBM, the IBM logo, and [ibm.com](http://www.ibm.com) are trademarks or registered trademarks of International Business Machines Corporation in the United States, other countries, or both. These and other IBM trademarked terms are marked on their first occurrence in this information with the appropriate symbol (® or ™), indicating US registered or common law trademarks owned by IBM at the time this information was published. Such trademarks may also be registered or common law trademarks in other countries. A current list of IBM trademarks is available on the Web at <http://www.ibm.com/legal/copytrade.shtml>

The following terms are trademarks of the International Business Machines Corporation in the United States, other countries, or both:

CICS Explorer™
CICSplex®
CICS®
DB2®
IBM®

IMS™
OS/390®
Rational®
Redbooks®
Redbooks (logo) ®

System z®
VTAM®
WebSphere®
z/OS®

The following terms are trademarks of other companies:

Java, and all Java-based trademarks are trademarks of Sun Microsystems, Inc. in the United States, other countries, or both.

Microsoft, Windows, and the Windows logo are trademarks of Microsoft Corporation in the United States, other countries, or both.

Linux is a trademark of Linus Torvalds in the United States, other countries, or both.

Other company, product, or service names may be trademarks or service marks of others.

Preface

IBM® Customer Information Control System (CICS®) Explorer™ is the new face of CICS Integration point for CICS tooling with rich CICS views, data, and methods.

Are you looking for new ways to accelerate the transfer of knowledge, skills, and best practices to the next generation of technical staff and experts? Do you need to maintain productivity and protect service-levels? CICS Explorer and System z® lead the way to platform simplification.

IBM CICS Explorer™ has a common, intuitive, Eclipse-based™ environment for architects, developers, administrators, system programmers, and operators. The task-oriented views provide integrated access to a broad range of data and control capabilities, and it also has powerful, context-sensitive resource editors. Integration point for CICS TS, CICS Tools, CICS TG, PD Tools, and Rational® Tools are extensible by independent software vendors (ISV), system integrators (SI), and customers who use our Software Development Kit.

In this IBM Redbooks publication, we focus on the new CICS Explorer. The first part of the book is an overview of the CICS Explorer along with all of the CICS Tools' plug-ins. In the second part of the book, we focus on different scenarios in which you can use the CICS Explorer with the CICS Tools plug-ins to resolve different problems.

The team who wrote this book

This book was produced by a team of specialists from around the world working at the International Technical Support Organization, Hursley Center.

Chris Rayns is an IT Specialist and the CICS project leader at the International Technical Support Organization, Poughkeepsie Center. He writes extensively about all areas of CICS. Before joining the ITSO, Chris worked in IBM Global Services in the United Kingdom as a CICS IT Specialist.

Chris Baker is a Senior Software Engineer in the CICS Development group at the IBM Hursley Laboratory. He has over 25 years of experience on the CICS product and has design and development responsibilities for the Monitoring and Statistics components of CICS Transaction Server for z/OS® and also the CICS Performance Analyzer for z/OS product. He is a regular speaker at IBM and user group technical conferences.

Diana Blair is a Technical Sales Specialist for CICS Tools in the U.S.A. She has a broad range of CICS experience to include, applications development and design, systems programming, product development, and most recently specializing in CICS Tools. She created educational material for CICS Interdependency Analyzer and developed a threadsafe seminar that is delivered to customers who are interested in saving CPU resources.

Edoardo Comar is a Senior Developer for IBM UK. He has 13 years of experience of software development using Java. He has a degree in Electrical Engineering from the University of Trieste, Italy. His areas of expertise include Eclipse development and automated testing.

Stewart Francis is a software developer for CICS Explorer, based in Hursley, England. He has a degree in Natural Science from the University of Cambridge, and has worked for IBM for three years. His area of expertise is Java™.

Em James is a Technical Specialist for CICS Tools, working at IBM Hursley Labs in the United Kingdom (UK). He has 18 years of experience working with CICS as both an Application Programmer and a Systems Programmer. He most recently worked as the Lead Developer on the CICS IA product. He has a degree in Computer Science from Loughborough University.

Chris Phillips is a Software Engineer for IBM UK. He has two years of experience working in CICS as a Test Engineer. He has a degree in Computer Science from the University of Southampton. His areas of expertise include graphical testing of Eclipse applications and regression test automation.

Kat Sharp is a CICS Explorer developer for CICS Tools, working at IBM Hursley Labs in the United Kingdom. She has three years of experience of software development using Java. She has a degree in Computer Science from Edinburgh University. Her area of expertise is Eclipse development.

Peter Siddell is a CICS Tools Technical Specialist based in the IBM Hursley laboratory in the UK. He has over 30 years of experience in IT with over 20 years spent on CICS. His areas of expertise include CICS systems programming and technical support for z/OS products. He delivers education on CICS and CICSplex/sm and presents regularly at worldwide conferences on the CICS Tools Portfolio.

Colin Stone is a Senior IT Specialist working in the CICS Explorer development team at IBM Hursley Labs in the United Kingdom. He has over 20 years of wide-ranging software development experience. He most recently developed the Performance Analyzer Explorer plug-in. He has a degree in Mechanical Engineering from Aston University in Birmingham.

Satish Tanna is a Senior IT Specialist and Technical Specialist for CICS Tools. Satish has worked with CICS TS, CICSplex® SM and CICS Tools in various roles during the last 18 years. These roles included work on performance analysis and capacity planning for CICSplex SM and CICS TS and a number of years in services working with CICS customers on projects, such as Web enablement, performance and capacity planning, and CICSplex SM implementation. Satish's latest role is Technical Specialist for CICS Tools. In this role he supports IBM pre-sales Technical Support Specialists and CICS customers on architecture and implementation of CICSplex SM and CICS Tools. Satish also works with CICS Tools vendors to develop plans for future releases and enhancements to the CICS Tools portfolio of products.

Joe Winchester is a Software Developer. His background before joining CICS was with a number of the IBM tooling products, which includes the Visual Age product line, WebSphere® Studio, and Eclipse where he was the Technical Lead for the Visual Editor project. Joe joined CICS to help bring some of these skills to CICS tooling. He initially worked on creating an Interdependency Analyzer Eclipse-rich client platform before working on a project to create a unified Eclipse systems management product that could host plug-ins for tools, which is now known as the CICS Explorer. He speaks on the CICS Explorer regularly at conferences and together with the development team is keen to drive user productivity forward by creating a single platform from which as many tasks and scenarios can be performed in an integrated and seamless fashion.

Will Yates is a Software Engineer specializing in System Test for CICS Transaction Server. He has knowledge in many areas of CICS, but his main focus is on enterprise modernization. He has a first class honors degree from the University of Portsmouth.

Thanks to the following people for their contributions to this project:

Richard M Conway
International Technical Support Organization, Hursley Center

John Knutson, System z Product Marketing Manager - CICS Tools
IBM Hursley

Sue Wyatt, CICS Tools Development Manager
IBM Hursley

Nick Bishop, Technical Writer Information Developer
IBM Hursley

Daniel Donnelly, ILOG Synergies team
IBM Hursley

Grant Shayler, CICS Tools Strategy and Planning
IBM Hursley

Become a published author

Join us for a two- to six-week residency program! Help write a book dealing with specific products or solutions, while getting hands-on experience with leading-edge technologies. You will have the opportunity to team with IBM technical professionals, Business Partners, and Clients.

Your efforts will help increase product acceptance and customer satisfaction. As a bonus, you will develop a network of contacts in IBM development labs, and increase your productivity and marketability.

Find out more about the residency program, browse the residency index, and apply online at:

ibm.com/redbooks/residencies.html

Comments welcome

Your comments are important to us!

We want our books to be as helpful as possible. Send us your comments about this book or other IBM Redbooks® publications in one of the following ways:

- ▶ Use the online **Contact us** review Redbooks form found at:

ibm.com/redbooks

- ▶ Send your comments in an e-mail to:

redbooks@us.ibm.com

- ▶ Mail your comments to:

IBM Corporation, International Technical Support Organization
Dept. HYTD Mail Station P099
2455 South Road
Poughkeepsie, NY 12601-5400



Part 1

CICS Explorer introduction

In this part of the book, we look at the new CICS Explorer and introduce the following CICS Tools plug-ins.

- ▶ CICS Explorer IA plug in
- ▶ CICS Explorer CM plug-in
- ▶ CICS Explorer PA plug-in



CICS Explorer introduction

In this chapter, we introduce the new Customer Information Control System (CICS) Explorer by giving you an overview before we introduce more basic capabilities.

1.1 Overview

As a newcomer into a CICS environment or as an experienced user moving roles, CICS System Management can be a daunting challenge. Prior to the CICS Explorer, to perform each task could require the use of different disconnected interfaces. These applications were often ISPF-based panels and written to do a specific function, each of which required custom knowledge to operate. If the completion of a specific task crossed application boundaries, you had to switch back and forth between the applications, which each had its own commands and user interface.

As well as basic CICS System Management, the definition and operation of regions and their installed resources, a typical CICS shop uses a number of tools, either obtained from IBM, third-party vendors, or developed in-house. These tools might have their own interfaces and way of presenting or manipulating the CICS runtime.

Providing an integration platform so that all of the tools and applications that a user needs to perform a business task work together coherently in an integrated environment was one of the driving forces behind the creation of the CICS Explorer. The benefit of CICS Explorer is to help new users become familiar with the platform, to present a single and re-usable way of accessing and manipulating CICS to promote consistency, and to allow tools that are built by IBM, vendors, and customers alike to be able to extend and enhance in a unified way. Each tool must introduce its own value to CICS management without having to reinvent or redefine the interface to the base platform itself.

As a system management tool the CICS Explorer is designed to be a scalable and intuitive way to manage a single CICS region, a collection of regions within a CICSplex, or a collection of CICSplexes. Experienced system programmers can quickly identify and tune their systems while newer users can be guided through the intuitive interface to learn how to perform standard tasks. By having a consolidated approach to system management, the number of interfaces that are required by CICS system administrators to learn to become effective is reduced, which helps to make the effort of attracting and training new developers and system programmers easier and less expensive.

The CICS Explorer is based on the Eclipse Rich Client Platform (RCP). Eclipse RCP is a cross platform framework for building and deploying PC desktop applications. One of the features of Eclipse that makes it a good choice of technology for the CICS Explorer is its plug-in architecture, which allows different components to be added that can extend and complement each other. A number of plug-ins exist that can be integrated into Eclipse environments, such as workflow, messaging clients, or development tools. One of these products is IBM

Rational Developer for Z, which is an integrated development environment for the System z platform that allows the creation of programs that access the CICS API to perform transaction processing. By both products sharing Eclipse as their common base technology, the CICS Explorer integrates within IBM Rational Developer for System z version (version 7.5 or higher) to provide system administrative capabilities to CICS application developers.

The CICS Explorer can be extended by plug-in providers using the Explorer API / SDK. Using the Explorer API / SDK customers can develop their own dedicated plug-ins to satisfy requirements particular to them. Using this framework maintains the consistency of the interface and integrates with the rest of the functionality that is provided in the Explorer and is the mechanism by which IBM and vendors provide plug-ins for their value-add tools.

Figure 1-1 shows how CICS Explorer and Eclipse RCP platform fit together.

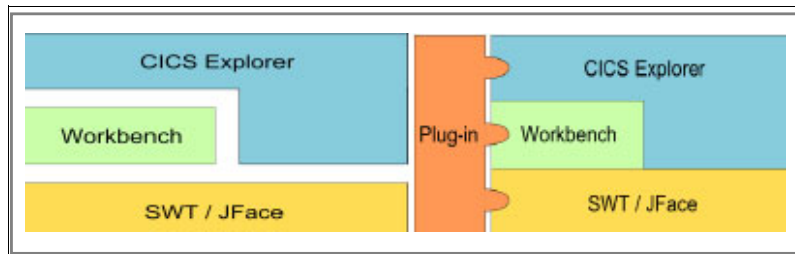

Figure 1-1 CICS Explorer + Eclipse RCP

At this point the CICS Explorer is not a full-functional replacement for the CICSplex System Manager Web User Interface. Users who are comfortable with the Web user interface (WUI), or the more traditional CEMT and CEDA commands in CICS, can enjoy using them as before with the CICS Explorer providing a rich way to administer and perform operational tasks on CICS systems in a fashion that allows extension and customization by tools and third-party plug-ins.

1.2 Base Explorer capabilities

The CICS Explorer provides a base set of CICSplex SM functions to manage CICS regions, resources, and definitions. It also provides a platform on which future CICS tools that are integrated in the Eclipse RCP can perform tasks and present the information in a common way.

CICS Explorer connects to either a CICSplex SM WUI server or a single CICS region. The functions that are available depend on which version of CICS Transaction Server for z/OS you use.

Figure 1-2 shows the different set ups.

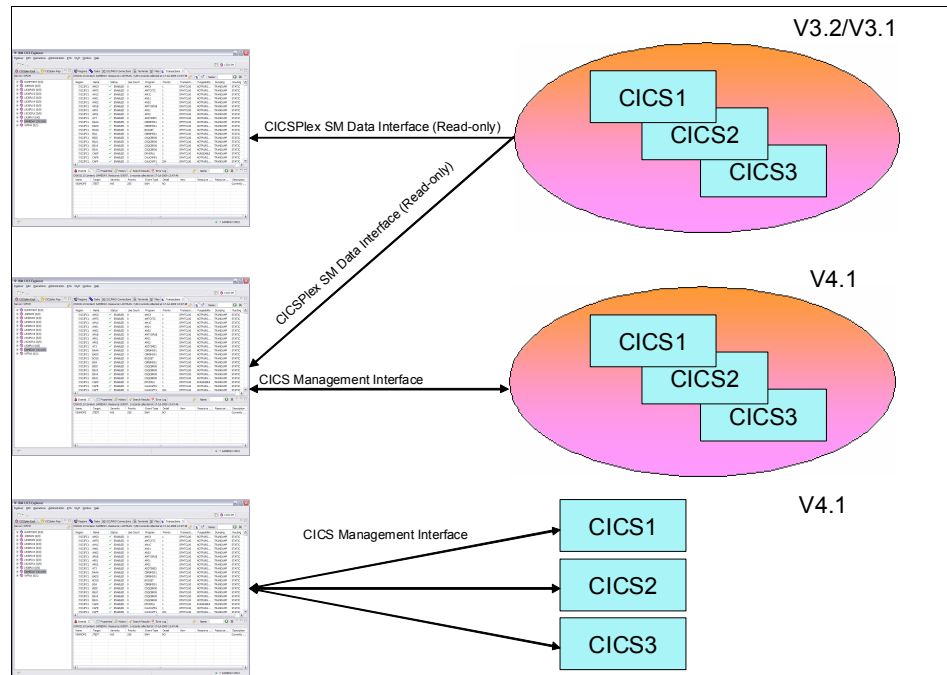

Figure 1-2 Different CICS setups

When connected to a CICSplex SM WUI server, CICS Explorer operations views provide a single-system image of all of the CICS resources within a CICSplex. When the CICS Explorer is connected to a CICS Transaction Server for z/OS Version 3 system, you can only browse the resources. However, when the CICS Explorer is connected to a CICS Transaction Server for z/OS version 4 CICSplex SM WUI or a single CICS region, you can perform the following actions on operational resources:

- ▶ Enable and disable resources
- ▶ Open and close resources
- ▶ Acquire and release resources
- ▶ Place resources in and out of service
- ▶ Purge tasks that are associated with a resource
- ▶ Discard resource definitions from a CICS system where they are installed

The CICS Explorer displays details of the CICS and CICSplex SM resource definitions, and when the CICS Explorer is connected to a CICS Transaction Server for z/OS version 4 CICSplex SM WUI, you can use the administration views and the resource editor to perform the following actions:

- ▶ Create and update resource definitions
- ▶ Install or remove resource definitions

Administration operations are not supported in a single CICS region in the CICS Explorer version 1.0.

Table 1-1 to Table 1-3 on page 8 shows exactly what can you do with the Explorer, given a particular set up and CICS version.

Table 1-1 Capabilities - CICSplex SM CICS version 4.1

	Example	Views	Actions
Operations	Regions	Large subset (40+)	<ul style="list-style-type: none"> ▶ Enable ▶ Disable ▶ Discard
Administration (CSD Post-GA)	Transaction Definitions	All Basic	<ul style="list-style-type: none"> ▶ Create ▶ Update ▶ Install ▶ Delete ▶ Add/Remove
Topology	CICSplex	Subset	No
RTA Events	RTA Outstanding Events	Small subset	No
WLM	Active Workloads	Small subset	No
Monitoring	Active Monitor Specifications	N/A	N/A

Table 1-2 Capabilities - CICSplex SM CICS version 3

	Example	Views	Actions
Operations	Regions	Large subset (40+)	No
Administration CICSplex SM Only	Transaction Definitions	All Basic	No

	Example	Views	Actions
Topology	CICSplex	Subset	No
RTA Events	RTA Outstanding Events	Small subset	No
WLM	Active Workloads	Small subset	No
Monitoring	Active Monitor Specifications	N/A	N/A

Table 1-3 Capabilities - CICS Single Server CICS version 4.1

	Example	Views	Actions
Operations	Regions	Large subset (40+)	<ul style="list-style-type: none"> ▶ Enable ▶ Disable ▶ Discard
Administration (CSD Post-GA)	Transaction Definitions	All Basic	<ul style="list-style-type: none"> ▶ Create ▶ Update ▶ Install ▶ Delete ▶ Add/Remove
Topology	CICSplex	Subset	N/A
RTA Events	N/A	N/A	N/A
WLM	N/A	N/A	N/A
Monitoring	N/A	N/A	N/A

The CICS Explorer also displays Events and Active Workloads in a CICSplex or single region and Properties for CICSplex SM Objects.

In addition, using the CICS Explorer you can define connections to multiple systems; however, only one connection can be active at a time.

The CICS Explorer shows the CICSplexes, CICS systems, and regions for your current connection, the different system and resource groups, and their related resources. Using the CICS Explorer you can navigate to resources by selecting a context, and then resources are displayed in different tabular views depending on their type. You can customize the attributes that display, enable filtering on attributes, select resources, and perform any appropriate actions.

The CICS Explorer uses rich editors to display resource definition attributes in one or more pages. To simplify the update process for less-experienced CICS users, attributes are logically grouped together, and each attribute has more detail provided. Every attribute benefits from field-level verification, where the entry is validated in real time. Errors are identified by the Error icon, which identifies the field in error and the page on which the field appears. Additionally, the embedded help system can provide assistance for the entire editor or for a specific field, which allows you to quickly get the information that you require.

To facilitate the move to CICS Explorer for experienced CICS users, one page in the rich editor, the Attributes page, displays the attributes in tabular form, grouped together in the same way that they appear in CEDA or in the CICSplex SM WUI. For users on a CICS Version 3, system resource definitions are also displayed in this way; however, you cannot edit them.

The CICS Explorer has an embedded help system to provide context and more detailed help for the resources and help about using the CICS Explorer and the basic Eclipse functions. More detailed help for CICS and CICSplex SM is at the CICS Transaction Server for z/OS Information Center.

1.3 Plug-ins and RCP

The CICS Explorer is an Eclipse RCP-based GUI application that runs on the Microsoft® Windows® and Linux® operating systems. The user interface to the applications is through the workspace, which is a graphical multi-window environment that is built into Eclipse. The Eclipse platform is structured as subsystems that are implemented in one or more plug-ins. The subsystems are built on top of a small runtime engine.

The workspace is a single window that consists of views and perspectives, and can contain other elements, such as editors, menus, and the help system.

The CICS Explorer uses a subset of the Eclipse plug-ins to build its workspace. The CICS Explorer runs completely standalone, and no prior installation of Eclipse is required; however, it is necessary to understand some of the concepts from Eclipse to make full use of all that the Explorer offers.

1.3.1 Eclipse concepts

In this section, we discuss the concepts of Eclipse.

Perspectives overview

A perspective is a layout of one or more views in the workspace. You can define your own perspectives to suit your particular needs.

You can tailor a perspective by adding new views, removing existing views, moving views around, or changing the size of views. When you close CICS Explorer, any changes that you made to the perspective are saved, and the next time that CICS Explorer starts, your tailored perspective is displayed. This tailoring feature allows you to create a view of CICS that contains the set of resources that makes the most sense for a particular role and its tasks in your CICS environment.

You can restore the default perspective at any time by going to the main workspace menu bar and clicking **Window** → **Reset** → **Perspective**.

You can create and save multiple perspectives, for example, you might want to set up one perspective that only shows the administration views and one perspective that only shows the operation views. For further information about using perspectives, see the related links.

When you save a perspective, you save only the layout of the views and editors in the workspace. If you change the width of a column in a view, that change is applied to that column in every perspective that contains the view. Any filter attributes that you set are retained when you switch to another perspective or view because a perspective is a definition of which views should be shown and their relative position, not their contents. The content is a property of the view that crosses perspective boundaries. The ability to create multiple instances of the same view with different filter or layout criteria might be included in a future release of the CICS Explorer, but it is not currently supported.

The CICS Explorer comes with two built-in perspectives:

- ▶ System Management

The System Management perspective is the first perspective that is presented when the Welcome page closes on first startup of the CICS Explorer. It contains information about the currently connected CICS systems, which includes the active regions, the running tasks, and so forth. If there is no active CICS system connection, all of the views in the perspective are empty.

- ▶ Resource

The Resource perspective is the same perspective that is included with most Eclipse-based products and shows a set of files that are locally held on your computer file system. These files can be any file that you import into your Eclipse environment. In the CICS Explorer, the Resource perspective presents and allows manipulation of content that is typically destined for

deployment into an HFS folder that is associated with a CICS resource definition.

Views overview

Each perspective contains one or more views. A view is a visual component and provides a way to navigate the information in your workspace.

The CICS Explorer uses some views that are provided with Eclipse itself, such as the Properties View, which shows attributes for a CICS resource or repository definition, and the Package view, which shows contents of a project for use in a CICS bundle. As well as using these existing Eclipse views, the CICS Explorer has a number of CICS-specific views that are arranged into a number of high-level conceptual categories. Views that display similar information are grouped together into *tab groups*. Each tab group is contained within a *pane* in the workspace window.

Figure 1-3 provides an example of the Views.

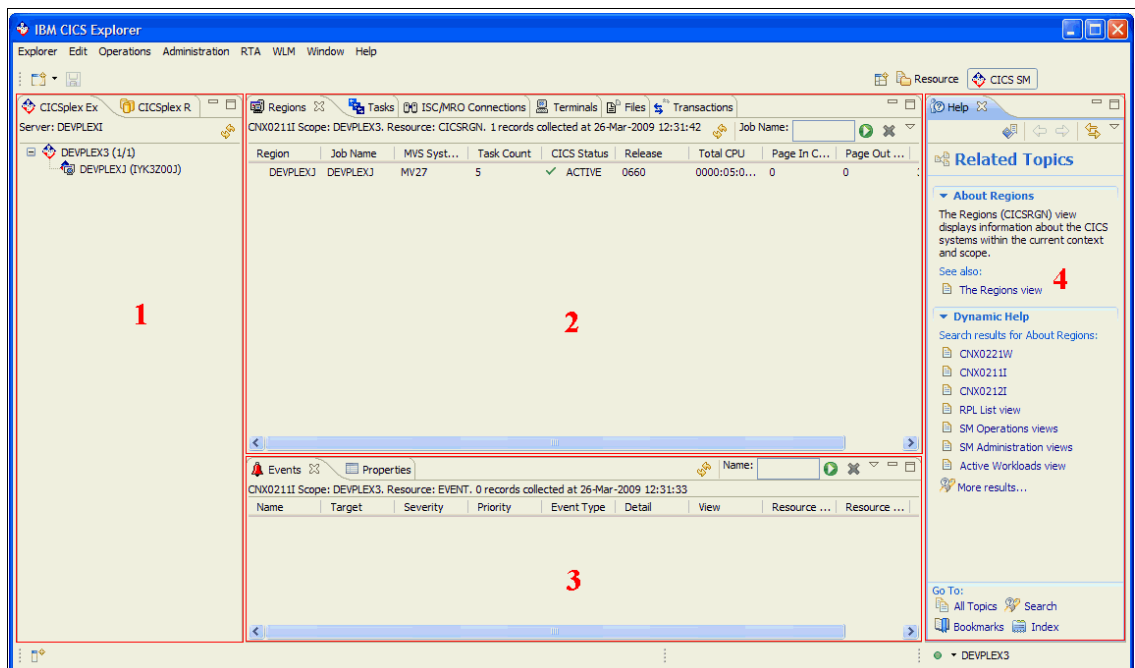

Figure 1-3 Views overview

Navigation: Tab Group 1

Using the CICSplex and CICSplex Repositories view you can see a list of CICSplexes and active regions or CICSplex repositories and defined definitional or system groups.

Resources: Tab Group 2

CICS Resources are divided into two categories:

- ▶ Administration

Administrative resources are those that reside in a repository, such as a CSD or CICSplex SM data repository (also known as BAS) and Transaction Definition or File Definition. Each CICS resource has a specific view.

- ▶ Operational

Operational resources represent live CICS resources that are installed into an active CICS region, such as tasks, programs, or files.

If the view that shows a particular resource is not present in the perspective, open it by clicking **Window** → **Show View** and searching for the view by name. Alternately, use the pull-down menu **Administration** or **Operational**, and locate the appropriate view by resource name. In a CICS view, the pop-up menu shows a list of tasks that can be taken against the selected resource(s), one of which is open that activates an editor. We cover this topic more in “Editors overview” on page 13.

The content of the resources views is scoped by the selected entry in one of the navigational views where appropriate. This scope is illustrated by the Tasks view, which shows all tasks for the selected sysplex, if one is selected in the CICSplex view. The Tasks view shows all tasks for the selected region if one is selected; likewise, for a view that shows CICS definitions, such as File Definitions, the scope of this is either all definitions for the selected CICSplex’s repository or for the selected resource definition group.

Extended: Tab Group 3

Using the CICS Explorer you can view additional details, such as CICS Plex SM system events or Real Time Analysis views. These details are arranged in the System Manager perspective at the bottom and are typically not scoped by the navigational views. This group also includes the Properties View, which shows all available attributes for a CICS resource.

Help: Tab group 4

You can open the help view in the perspective using function key 1 to show information from the documentation that is provided with the CICS Explorer.

Each view has a title, which is displayed in a tab at the top of the view. Where multiple views are present in a view set, they are stacked one behind the other. To activate a view, click its tab to bring the view to the front of the stack. The tab is highlighted, which indicates the active view.

All views, with the exception of the CICSplex Explorer view, can be removed from view or moved to a different tab group, and each tab group can be sized or repositioned in the workspace. The CICSplex Explorer view is a special view that you cannot close or move.

You can restore the default tab group arrangement (perspective) at any time by going to the main workspace menu bar and clicking **Window** → **Reset Perspective**.

Editors overview

An editor opens in a separate tab group called the **editor area**, which is positioned to the right of the tabular views. The editor area shares many features with the other tab groups, but it does have some limitations that we identify later in this topic.

You open an editor from a resource definition view by right-clicking a resource, and then clicking **Open**. Figure 1-4 on page 14 shows the editor area, which is the active view.

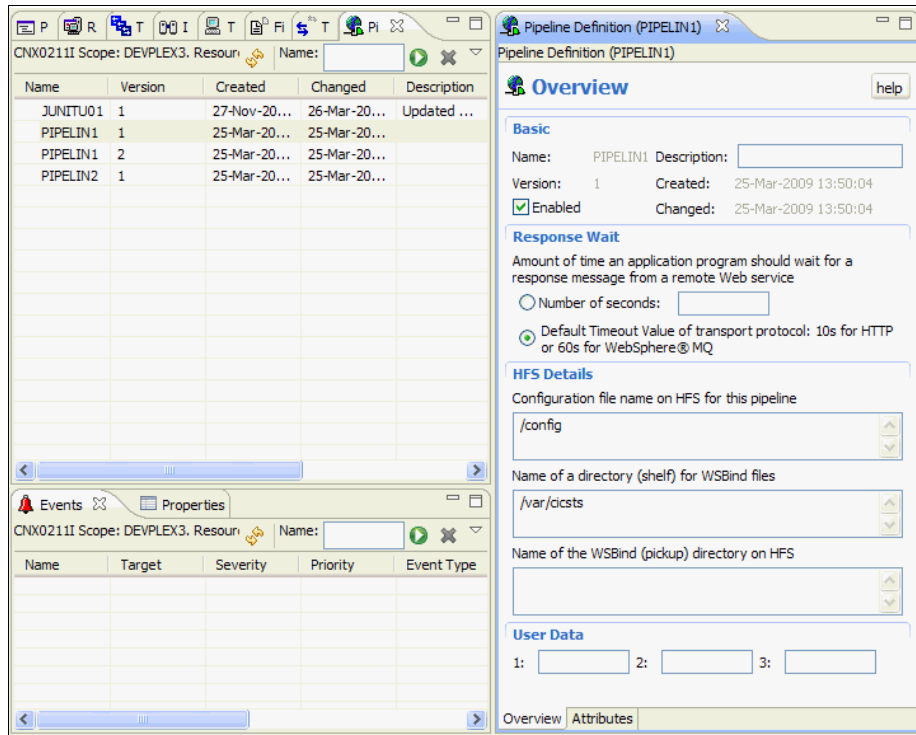

Figure 1-4 Editors

The editor area appears to the right of the views. Each editor for a CICS resource has a tab that is labelled Attributes. Under the Attributes tab is a list of attributes that are arranged in a tree, which is designed to be familiar to users who are comfortable with CEDA or CEMT categorization. For some definitions there are additional tabs, such as the Overview tab for the pipeline definition, which arranges the information using rich controls to add description and grouping to help identify and explain the attributes and their contents. If the current connection is to a CICS Management Client Interface or CMCI connection, you can make changes to the definition through the editor and save the changes to update the CICS resource or definition. If the current connection is to a CICS Plex System Manager connection, the editor only allows viewing of the resource's attributes.

Note: CMCI Connections are only available to regions running CICS Transaction Server Version 4.1.

You can minimize, maximize, or resize the editor area, but there are some limitations on moving the editor area and the editor.

You change the size of the editor area in the same way that you size the other tab groups, but the editor area cannot be moved in the same way that you move the other tab groups. To reposition the editor area in the workspace, move the other tab groups around the editor area, for example, to reposition the editor area more to the middle of the workspace, drag the tabular views tab group, and drop it at the right side of the editor group, as shown in Figure 1-5.

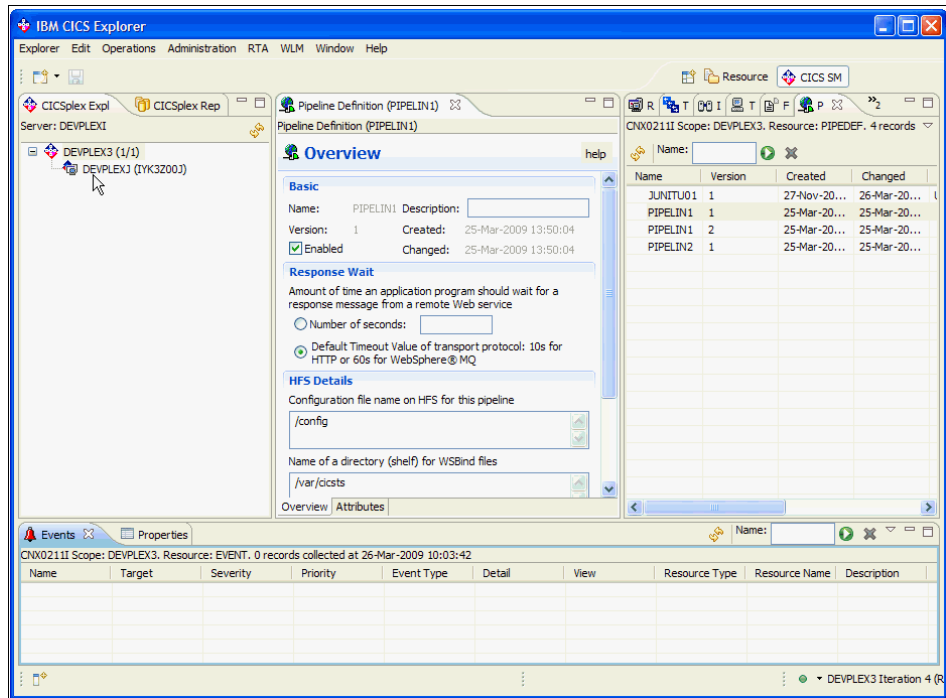

Figure 1-5 Editor, changing the size

If you open more than one instance of the editor, you can move the views around in the editor area, for example, you can position them one above the other or side-by-side, as shown in Figure 1-6 on page 16, but you cannot move the editor instances into a different tab group.

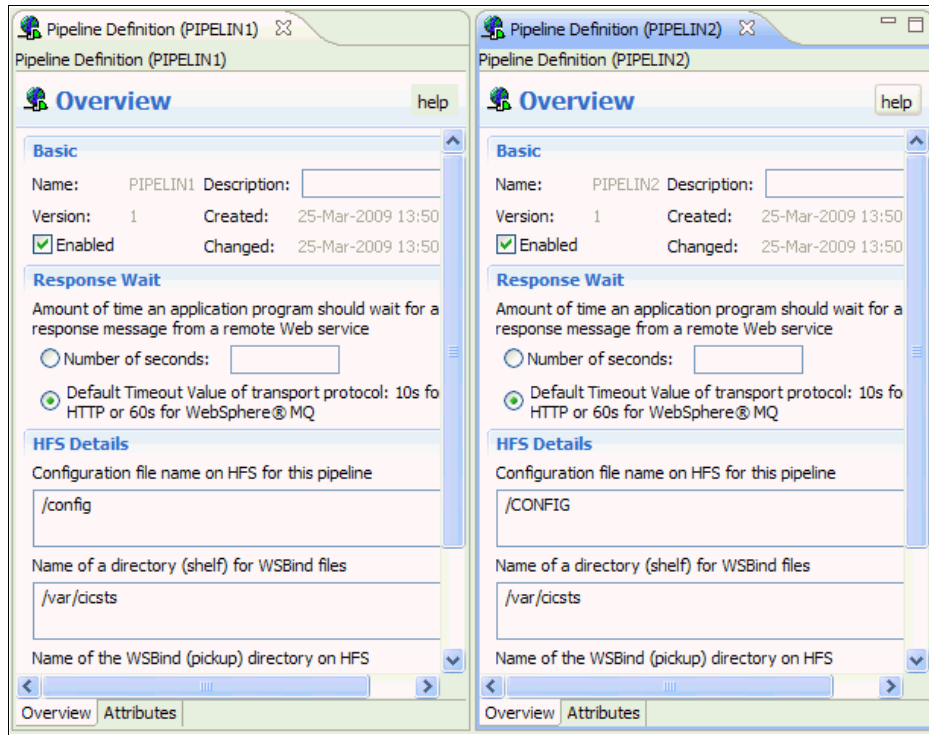

Figure 1-6 Moving the views around

If you reset the perspective, the perspective is restored to the default layout; however, any open editors are unchanged and remain in the workspace. Similarly, if you change to another perspective, any open editors remain visible in the new perspective.

Embedded help system

Using the embedded help system you can browse, search, and print system documentation. The help system also provides a context-sensitive help, which you can access by pressing the 'F1' hotkey (Windows) or CNTRL-F1 (Linux). This help system gives an overview of the resource with which you are working and a text search capability for finding the information that you need, by keyword. The help is displayed either in a Help view in the workspace, in a separate Help Contents window, or in an external browser window.

The CICS Explorer includes detailed help information for CICS resources and their attributes that is sensitive to where it is activated from. In the Properties View or the attributes tab of an editor, when an individual attribute is selected and F1 pressed to activate help, the help contents shown are specific to the selected

attribute. In some views, such as the customize columns dialog for a CICS resource view or a CICS definition creation wizard, activating help opens the help contents in the active window, again showing contents that are applicable to the selected or currently focused attribute.



Getting started with CICS Explorer

In this chapter, we show the steps that are required to implement CICS Explorer for those who use both the single system set up or for who plan to use CICSplex SM to enable you to take advantage of CICS Explorer.

2.1 Using CICS Explorer with CICS TS 4.1

CICS TS 4.1 introduces a new facility called the CICS Management Client Interface (CMCI). This new interface is exploited by CICS Explorer to provide Create / Read / Update / Delete capabilities.

In this section, we tell you how to use CICS Explorer with CICS TS 4.1.

2.2 CICS Explorer can operate in two different ways

CICS Explorer operates in two different ways:

- ▶ Directly with CICS
- ▶ Directly with CICSplex SM

2.2.1 CICS Explorer directly with CICS

Small-scale users can directly exploit CICS Explorer individual CICS regions, which provides access to basic operational capabilities and resources definitions through the CSD, as shown in Figure 2-1 on page 21. Small enterprises can therefore benefit from a modern management interface and integration into the CICS tools. Exploitation is a matter of minutes requiring minimal setup, with CMCI initializing the first time a request is made to the region. All that is required to gain access is a TCP/IP Service definition and the addition of the appropriate Library.

This type of usage scenario is described as a System Managed Single Server or SMSS. This term is also sometimes referred to as Single Server.

CICS Explorer lets you work with the resources on just this Single system. The SMSS capabilities of CICS cannot be used if the CICS is managed by CICSplex SM.

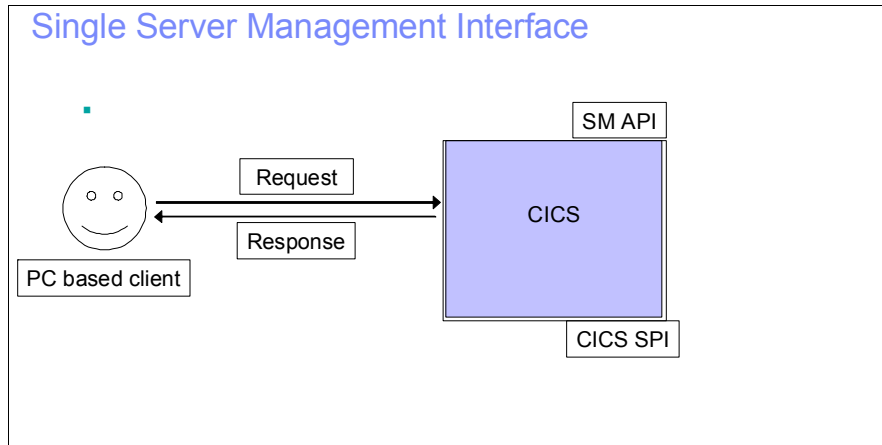

Figure 2-1 Directly with CICS

If you have few multiple CICS, each system requires a TCP/IP Connection and you need to connect CICS Explorer to each CICS in turn to work with it.

2.2.2 CICS Explorer directly with CICSplex SM

For those who exploit the extensive capabilities that CICSplex SM provides, you can use CICS Explorer to access the CICSplex SM environment, as shown in Figure 2-2 on page 22. In contrast to the previous support pack edition, this interface now gives you the ability to take actions on resources. Establishing access is again a simple set of actions, even for a first time CICSplex SM user. For existing CICSplex SM users, access is virtually immediate.

If the system is managed by CICSplex SM, you cannot use the CICS SMSS / Single Server capabilities.

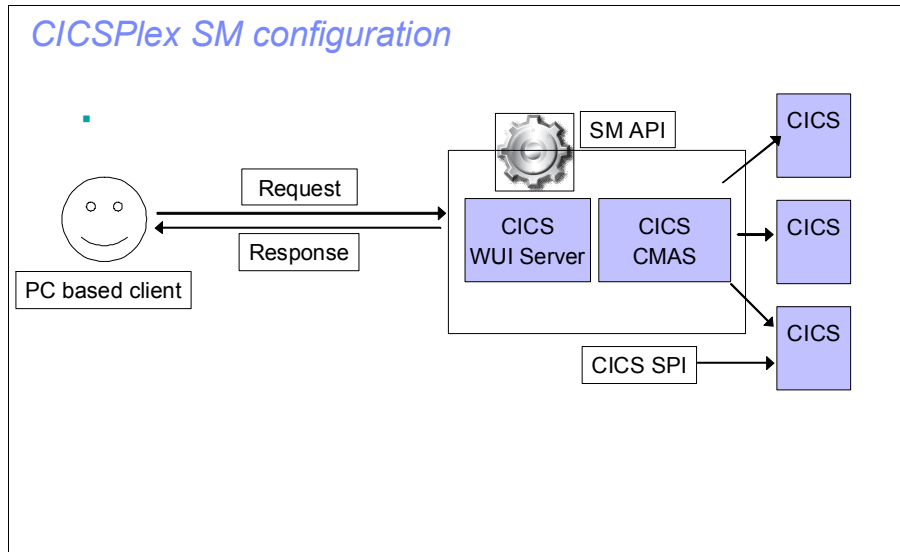

Figure 2-2 CICSplex SM configuration

As users migrate to the advanced facilities of CICSplex SM, the CICS Explorer experience expands into this new set of capabilities, thus eliminating the relearning curve that is often experienced when introducing new management capabilities.

2.3 Setting up single server access

To set up a single server access:

1. Copy the IBM supplied group DFH\$WU to a user defined group. You need one group for each CICS system you want to manage.
2. In your user defined group, update TCPIPService definition DFH\$WUTC and the Portnumber (each CICS requires a unique value for the TCP/IP Stack being used), and if the CICS is running with security (SEC=YES in the SIT), change Authenticate to Basic.
3. Install the user defined group (URIMAP definition DFH\$WUUR is installed alongside the DFH\$WUTC.TCPIPService).
4. Add the CICSTS SEYULOAD dataset to the CICS DFHRPL concatenation and the CICS TS SEYUAUTH dataset to the STEPLIB concatenation in the CICS JCL. (Make sure that the CICS TS SEYUAUTH dataset is APF authorized).

Figure 2-3 on page 24 shows the Explorer connection to a single server. The Connection type to specify is CICS Management Interface. The Server address to use is the IP address of the TCP/IP stack that the CICS will use, and the Portnumber corresponds to the port number that is specified on the DFH£WUTC tcpip service that you installed.

The interface initializes when the CICS region receives the first request. Example 2-1 shows a JCL that needs updating, and Example 2-2 shows an updated JCL.

Example 2-1 Update the CICS JCL(before update)

```
//CICS EXEC PGM=DFHSIP,REGION=240M,  
// PARM=('SIT=6$',  
// 'START=AUTO,SI')  
//SYSIN DD *  
GRPLIST=(DFHLIST,userlist1,userlist2),  
APPLID=CICSHTH1,  
.END  
//STEPLIB DD DSN=CICSTS41.CICS.SDFHAUTH,DISP=SHR  
// DD DSN=CICSTS41.CICS.SDFJAUTH,DISP=SHR  
//DFHRPL DD DSN=CICSTS41.CICS.SDFHLOAD,DISP=SHR  
// DD DSN=your.prog.library,DISP=SHR  
// DD DSN=your.table.library,DISP=SHR  
//DFHCSD DD DSN=CICSTS41.CICS.DFHCSD,DISP=SHR  
...
```

Example 2-2 Updated JCL

```
//CICS EXEC PGM=DFHSIP,REGION=0K,  
// PARM=('SIT=6$',  
// 'START=AUTO,SI')  
//SYSIN DD *  
GRPLIST=(DFHLIST,userlist1,userlist2),  
APPLID=CICSHTH1,  
.END  
//STEPLIB DD DSN=CICSTS41.CPSM.SEYUAUTH,DISP=SHR  
// DD DSN=CICSTS41.CICS.SDFHAUTH,DISP=SHR  
// DD DSN=CICSTS41.CICS.SDFJAUTH,DISP=SHR  
//DFHRPL DD DSN=CICSTS41.CPSM.SEYULOAD.DISP=SHR  
// DD DSN=CICSTS41.CICS.SDFHLOAD,DISP=SHR  
// DD DSN=your.prog.library,DISP=SHR  
// DD DSN=your.table.library,DISP=SHR  
//DFHCSD DD DSN=CICSTS41.CICS.DFHCSD,DISP=SHR
```

Connecting Explorer to Single Server CMCI

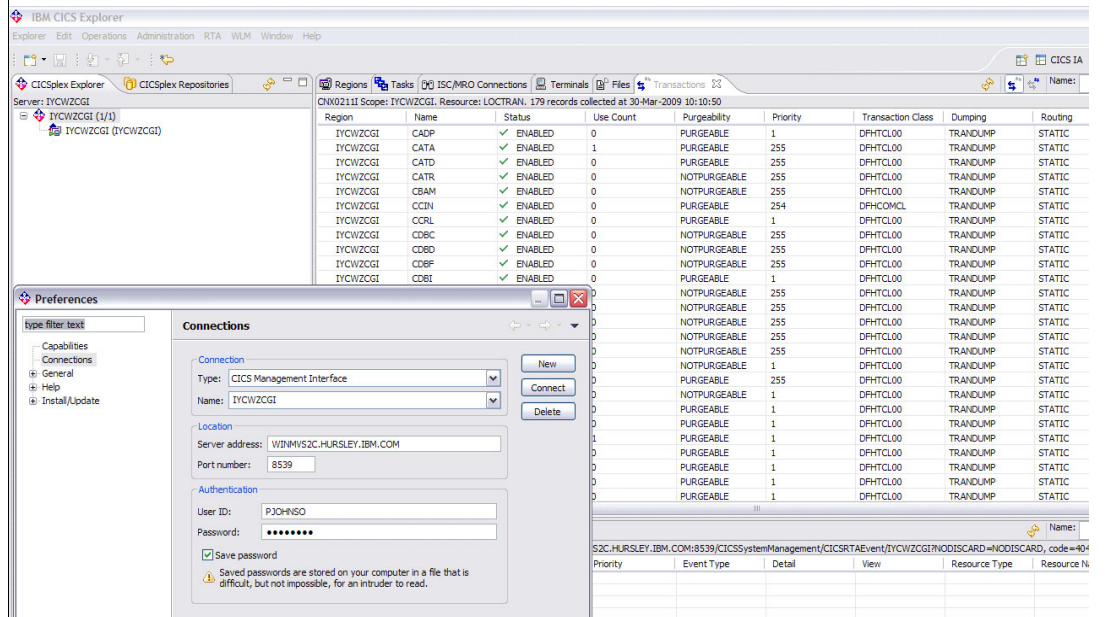

Figure 2-3 Explorer connecting to a single server

2.4 Updating an existing CICSplex SM setup for CICS Explorer

If you are already a CICSplex SM user, to enable the CICS Management Client interface in your CICSplex SM Web User Interface (WUI) server, update your WUI system parameters to include the new CMCIPORT parameter. The value specified is a TCP/IP port number that should be used for the CMCI. Each WUI server that is to provide CMCI support needs a unique (per TCP/IP Stack) port number for the CMCIPORT.

Example 2-3 shows a WUI System Parameter file that needs updating, and Example 2-4 on page 25 shows an updated parameter file.

Example 2-3 Update the WUI System Parameters (before update)

```
//EYUWUI DD *
TCPHOSTNAME(MYHOST.EXAMPLE.COM)
TCPIPPORT(60666)
```



```
DEFAULTCONTEXT(MYPLEX)
DEFAULTSCOPE(MYSCOPE)
DEFAULTCMASCTXT(MYCMAS)
AUTOIMPORTDSN(CTS41.CPSM.SEYUVIEW)
AUTOIMPORTMEM(EYUEA*)
//
```

Example 2-4 Updated System Parameters

```
//EYUWUI DD *
TCPIPHOSTNAME(MYHOST.EXAMPLE.COM)
TCPIPPORT(60666)
CMCIPOPORT(50666)
DEFAULTCONTEXT(MYPLEX)
DEFAULTSCOPE(MYSCOPE)
DEFAULTCMASCTXT(MYCMAS)
AUTOIMPORTDSN(CTS41.CPSM.SEYUVIEW)
AUTOIMPORTMEM(EYUEA*)
//
```

In the CICS Explorer connection dialog, specify a connection type of CICS Management Interface, Server address is set to the WUI TCPIPHOSTNAME parameter, and the Port number matches the newly specified CMCIPOPORT parameter.

2.5 Setting up CICSplex SM for CICS Explorer

In this section, we describe the steps that are required to set up CICSplex SM to take advantage of CICS Explorer.

2.5.1 The basics of setting up CICSplex SM for CICS Explorer

To set up CICSplex SM, you need two new CICS systems. In this document, we turn one of these systems into a CMAS and the second into a WUI server.

A CMAS is a CICS system that manages a CICSplex. It is a dedicated system; therefore, no other workloads should run inside it.

A CICSplex is simply a set of CICS systems that CICSplex SM manages. You might have a number of CICSplexes in your enterprise, but an individual CICS system can only belong (be managed by) to one CICSplex.

A WUI server is a CICS system that acts as a Web server for the Web User Interface into CICSplex SM. If you use the CICS Explorer with CICS TS 4.1 the Explorer uses this to acquire information about your CICS systems and resources. This is a dedicated system, so no other workloads should run inside it.

As a first step, create two new CICS systems. Figure 2-4 shows an example of our environment. The assumptions that we made are:

- ▶ CICS systems are on a single LPAR
- ▶ CICSplex SM Libraries are downloaded
- ▶ You have JCL for existing CICS regions

Figure 2-5 on page 27 shows our environment plus WUI and CMAS regions.

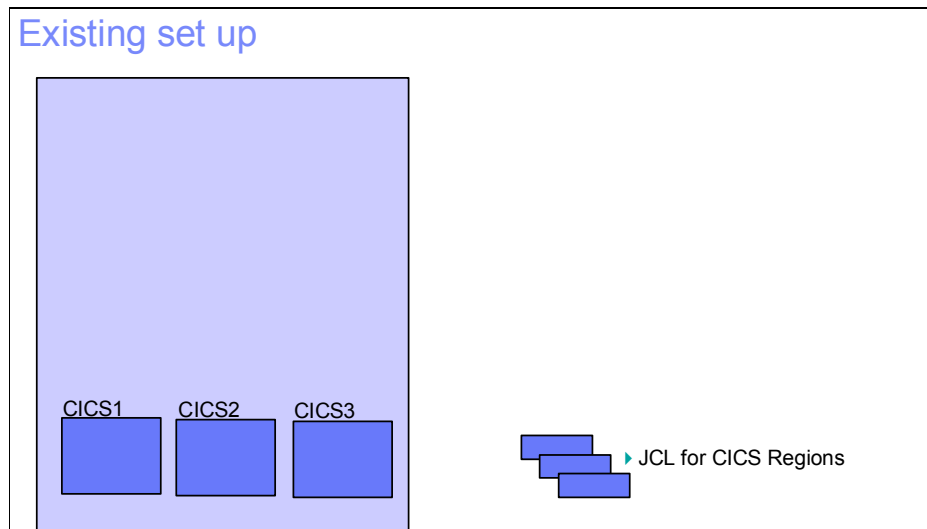

Figure 2-4 Example of existing setup

Create two new CICS regions (CMAS and WUI Server)

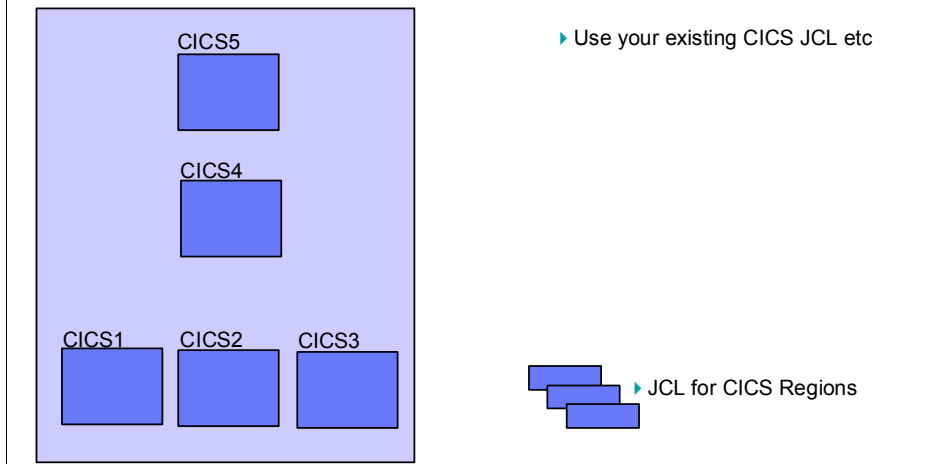

Figure 2-5 Existing setup plus WUI and CMAS regions

2.5.2 Changing a System into a CMAS

Figure 2-6 shows an example of creating a CMAS Repository.

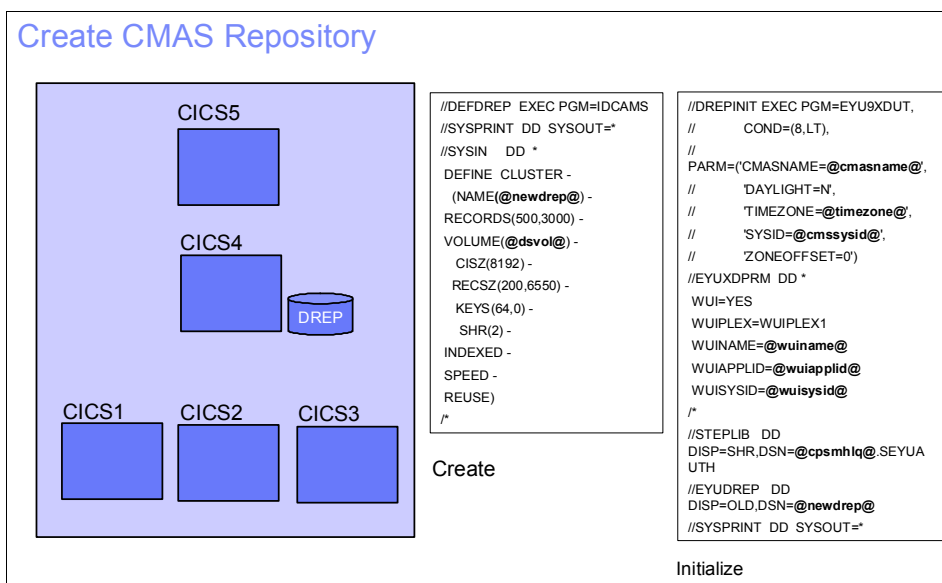

Figure 2-6 Create CMAS repository

Creating a data repository

To change one of your systems into a CMAS you must first create and initialize a data repository. A data repository is simply a VSAM file that CICSplex SM uses to store definitions, which is a bit like a CICS CSD. Example 2-5 shows sample syntax for creating a data repository, and Example 2-6 provides sample JCL syntax to initialize the repository.

Example 2-5 Create the CMAS repository

```
//DEFDREP EXEC PGM=IDCAMS
//SYSPRINT DD SYSOUT=*
//SYSIN DD *
DEFINE CLUSTER -
  (NAME(@newdrep@) -
  RECORDS(500,3000) -
  VOLUME(@dsvo1@) -
  CISZ(8192) -
  RECSZ(200,6550) -
  KEYS(64,0) -
  SHR(2) -
  INDEXED -
  SPEED -
  REUSE)
/*
```

Example 2-6 Initialize the repository

```
//DREPINIT EXEC PGM=EYU9XDUT,
//          COND=(8,LT),
//          PARM=('CMASNAME=@cmasname@',
//              'DAYLIGHT=N',
//              'TIMEZONE=@timezone@',
//              'SYSID=@cmssysid@',
//              'ZONEOFFSET=0')
//EYUXDPRM DD *
WUI=YES
WUIPLEX=WUIPLEX1
WUINAME=@wuiiname@
WUIAPPLID=@wuiapplid@
WUISYSID=@wuisysid@
/*
//STEPLIB DD DISP=SHR,DSN=@cpsmh1q@.SEYUAUTH
//EYUDREP DD DISP=OLD,DSN=@newdrep@
//SYSPRINT DD SYSOUT=*
```

There are two variables that you must specify in the JCL for creating the repository (Example 2-3):

- ▶ The dataset name (@newrep@) that you want the repository to have (make a note of this name, you will need it later)
- ▶ The volume (@dsvol@) that you want the dataset created on

Initializing the data repository

Next, we must initialize the data repository. Initializing the repository loads it with some definitions that are needed for the CICSplex to work. Example 2-4 on page 25 contains some sample JCL to initialize the data repository.

There are a number of variables that you must set in the JCL. Let us start with the simplest:

1. Where @cpsmhlq@ appears, enter in the High Level Qualifier for the release of CICS TS that you are working on, for example:
CTS410.CPSM.SEYUAUTH.
2. Populate @newdrep@, which this is the name that you gave to your Data Repository when you created it with IDCAMS, shown in Example 2-3.
3. Populate the @cmasname@ variable. This entry is simply a name that CICSplex SM uses to identify the CMAS. You can use up to eight characters (A-Z and 0-9) for the name. You might want to use the APPLID of the system as a name for simplicity. Make a note of the CMAS name because you will need it later.
4. Set @timezone@ to the letter A to use your local timezone.
5. Set @cmssysid@, which is the system ID of the CICS system that you are turning into a CMAS.
 - a. Find the SYSIDNT SIT parameter in your CICS JCL, and copy its value into this variable. If you do not have a SYSIDNT SIT parameter, create a four character identifier. The last four characters of the system's APPLID can be used for this. The value must be unique.

The next set of variables are used to help define a CICSplex for your WUI server and to tell the CMAS a bit about the CICS system that you are using as a WUI server:

- ▶ @wuiapplid@ is the APPLID of the CICS system that you are turning into a WUI server. *This is not the same system that you are turning into a CMAS.* In your CICS JCL, find the APPLID SIT parameter, and copy its value into the @wuiapplid@ variable.
- ▶ @wuisysid@ is the system ID of the CICS system that you are turning into a WUI server. *This is not the same system that you are turning into a CMAS.* In

your CICS JCL, find the SYSIDNT SIT parameter, and copy its value into the @wuisysid@ variable. If you do not have a SYSIDNT SIT parameter, you must create a four character identifier. The last four characters of the system's APPLID can be used for this. This value must be unique.

- ▶ @wuiname@ is simply a name that CICSplex SM uses to identify the WUI server. You can use up to eight characters (A-Z and 0-9) for the name. You can use the APPLID of the system as a name. Make a note of the name because you will need it later.

Note: that there is also a parameter called WUIPLEX that, in this example, was set to WUIPLEX1 is because the WUI is managed inside of its own CICSplex. For this exercise, it is not important to understand why this is the case, so it is fine to just use the WUIPLEX1 value.

Both the data repository creation and initialization can be JOBSTEPS inside a single JOB.

When the JCL is submitted, you should get a return code of 0, which means that your data repository data set is created and initialized.

Modifying the CICS JCL

Now we must modify the JCL of the CICS system that we are turning into a CMAS. Example 2-7 shows a CMAS JCL before modification. Example 2-8 on page 31 shows the JCL after modification.

Example 2-7 Update CMAS JCL(before)

```
//CICS EXEC PGM=DFHSIP,REGION=240M,
//          PARM=('SIT=6$',
//          'START=AUTO,SI')
//SYSIN DD *
GRPLIST=(DFHLIST,userlist1,userlist2),
APPLID=CICSHTH1,
.END
//STEPLIB DD DSN=CICSTS41.CICS.SDFHAUTH,DISP=SHR
//          DD DSN=CICSTS41.CICS.SDFJAUTH,DISP=SHR
//DFHRPL DD DSN=CICSTS41.CICS.SDFHLOAD,DISP=SHR
//          DD DSN=your.prog.library,DISP=SHR
//          DD DSN=your.table.library,DISP=SHR
//DFHCSD DD DSN=CICSTS41.CICS.DFHCSD,DISP=SHR
...
```

Example 2-8 Update CMAS JCL(after)

```
//CICS EXEC PGM=EYU9XECS,REGION=OK,
//          PARM=('SIT=6$',
//          'START=AUTO,SI')
//SYSIN DD *
GRPLIST=(DFHLIST,userlist1,userlist2),
APPLID=CICSHTH1,
MXT=300,
CPSMCONN=CMAS,
EDSALIMIT=100M,
ICVR=20000,
SEC=NO,          You can switch it on later
SPOOL=YES,
.END
//STEPLIB DD DSN=@cpsmhlq@.SEYUAUTH,DISP=SHR
//          DD DSN=CICSTS41.CICS.SDFHAUTH,DISP=SHR
//          DD DSN=CICSTS41.CICS.SDFJAUTH,DISP=SHR
//DFHRPL DD DSN=@cpsmhlq@.SEYULOAD,DISP=SHR
//          DD DSN=CICSTS41.CICS.SDFHLOAD,DISP=SHR
//          DD DSN=your.prog.library,DISP=SHR
//          DD DSN=your.table.library,DISP=SHR
//DFHCSD DD DSN=CICSTS41.CICS.DFHCSD,DISP=SHR
//EYUDREP DD DISP=SHR,DSN=@newdrep@
//EYUPARM DD *
NAME(@cmasname@)
SEC(NO)
/*
```

To modify the JCL:

1. In the JOBSTEP for the CICS system, change the program from DFHSIP to EYU9XECS. Also, add REGION=OK to this line.
2. Add the following dataset to your STEPLIB (as before, the variables used depend of the release of CICS TS that you are using):
@cpsmhlq@.SEYUAUTH
3. Add the following dataset to DFHRPL:
@cpsmhlq@.SEYULOAD
4. Add the following SIT parameter:
CPSMCONN=CMAS

5. Add or change the MXT SIT parameter, which is the minimum MAXTASKs value for a CMAS. (For a basic set up, 300 is an appropriate value):

```
MXT=300
```

6. Change the EDSALIMIT SIT parameter, which is the minimum DSA size for a CMAS. (For a basic set up this is an appropriate value):

```
EDSALIMIT=100M
```

7. Add or change the ICVR SIT parameter:

```
ICVR=20000
```

8. Add or change the SEC SIT parameter. Initially we will run with security off. You can run with security on at a later date:

```
SEC=NO
```

9. Add or change the SPOOL SIT parameter:

```
SPOOL=YES
```

10. Change the START SIT parameter:

```
START=AUTO
```

Note you might want to force a COLD/INITIAL start on the first startup, but an AUTO restart is fine after that.

11. Add the following DD card to the JCL, where @newdrep@ is the name of the Data Repository that you created earlier:

```
//EYUDREP DD DISP=SHR,DSN=@newdrep@
```

12. Add the following DD card:

```
//EYUPARM DD *  
    NAME(@cmasname@)  
    SEC(NO)  
/*
```

Note the example here assumes that the IBM supplied SIT 6\$ is used. If you use an installation defined SIT, you might need to modify other values that not shown here; otherwise, incorrect results can occur.

Example 2-8 on page 31 is an example of all of these changes. You are now ready to start your CMAS.

Starting the CMAS

Submit the JCL you just modified. If the CMAS starts successfully, in the logs, you should see the following messages:

EYUXL0007I IYK3ZDD1 CMAS Phase III initialization complete.

EYUXL0007I IYK3ZDD1 CMAS Phase IV initialization complete.

EYUXL0010I IYK3ZDD1 CMAS initialization complete.

If CMAS initialization does not complete, go back and make sure that all of the names, APPLIDs, and system IDs that you defined are correct.

2.5.3 Changing a system into a WUI server

The first step to creating a WUI server is to create a WUI repository, as shown in Figure 2-7.

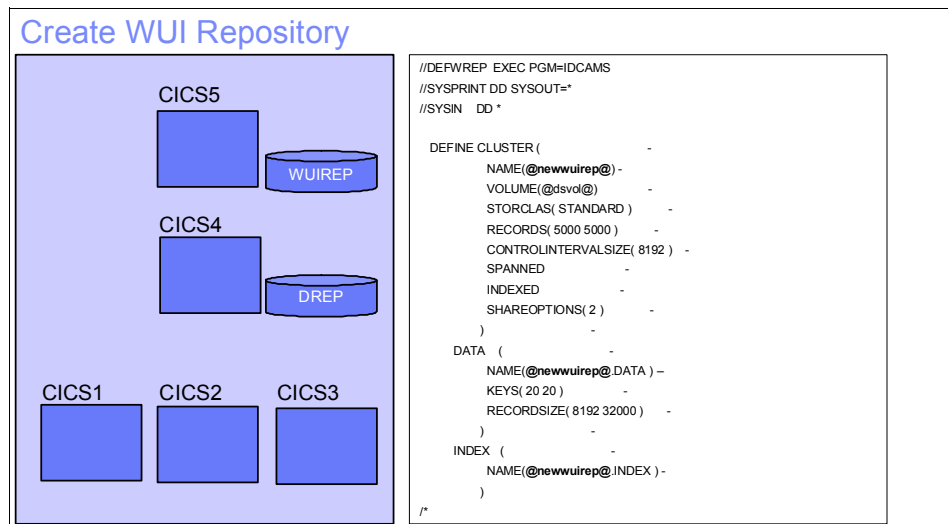

Figure 2-7 Create a WUI Repository

The WUI repository is simply a VSAM dataset that holds all of the Views and Menus that the WUI serves to a browser. Example 2-9 contains some sample JCL to create a WUI repository.

Example 2-9 Create WUI repository

```
//DEFWREP EXEC PGM=IDCAMS
//SYSPRINT DD SYSOUT=*
//SYSIN DD *
```

```
DEFINE CLUSTER (
  NAME(@newwuirep@) -
```

```

                                VOLUME(@dsvo1@)           -
                                STORCLAS( STANDARD )      -
                                RECORDS( 5000 5000 )      -
                                CONTROLINTERVALSIZE( 8192 ) -
                                SPANNED                   -
                                INDEXED                   -
                                SHAREOPTIONS( 2 )         -
                                )                          -
DATA      (                                                 -
                                NAME(@newwuirep@.DATA ) -
                                KEYS( 20 20 )           -
                                RECORDSIZE( 8192 32000 ) -
                                )                          -
INDEX     (                                                 -
                                NAME(@newwuirep@.INDEX ) -
                                )                          -
/*

```

@newwuirep@ is the dataset name that you want the WUI repository to have.

We are now ready to modify our CICS system's JCL to turn it into a WUI server.

Modifying the CICS JCL

Example 2-10 shows the changes to make to CICS JCL to make it a WUI server.

Example 2-10 Change CICS JCL to make it a WUI

```

//CICS   EXEC PGM=DFHSIP,REGION=0K,
//          PARM=('SIT=6$',
//          'START=AUTO,SI')
//SYSIN   DD *
GRPLIST=(DFHLIST,userlist1,userlist2),
APPLID=CICSHTH1,
CPSMCONN=WUI
INITPARM=(EYU9VWAN='ENU1',EYU9VKEC='ENU'),
EDSALIM=100M,
MXT=120,
TCPIP=YES,
SEC=NO,           You can switch it on later
.END
/*
//STEPLIB DD DSN=@cpsmhlq@.SEYUAUTH,DISP=SHR
//          DD DSN=CICSTS41.CICS.SDFHAUTH,DISP=SHR

```

```

//          DD DSN=CICSTS41.CICS.SDFJAUTH,DISP=SHR
//DFHRPL   DD DSN=@cpsmhlq@.SEYULOAD.DISP=SHR
//          DD DSN=CICSTS41.CICS.SDFHLOAD,DISP=SHR
//          DD DSN=your.prog.library,DISP=SHR
//          DD DSN=your.table.library,DISP=SHR
//DFHCSD   DD DSN=CICSTS41.CICS.DFHCSD,DISP=SHR

//EYUWREP DD DISP=SHR,DSN=@newdrep@
//EYUPARM DD *
NAME(@wuiname@)
CICSPLEX(WUIPLEX1)
CMASYSID(@cmassysid@)
SEC(NO)
/*
//EYUWUI DD *
TCPIPHOSTNAME(@hostname@)
TCPIPPORT(@portnumber@)
DEFAULTCONXT(@mainlex@)
DEFAULTSCOPE(@mainplex@)
DEFAULTCMASCTXT(@cmasname@)
AUTOIMPORTDSN(@cpsmhlq@.SEYUVIEW)
AUTOIMPORTMEM(EYUEA*)
CMPIPORT=@portnumber@
/*

```

Now we must modify the JCL of the CICS system that we are turning into a WUI server:

1. Add the following dataset to your STEPLIB (as before, the variables that are used depend on the release of CICS TS that you are using):

```
@cpsmhlq@.SEYUAUTH
```

2. Add the following dataset to DFHRPL:

```
@cpsmhlq@.SEYULOAD
```

3. Add the following SIT parameter:

```
INITPARM=(EYU9VWAN='ENU1',EYU9VKEC='ENU')
```

4. Make sure that the TCP SIT parameter is set to YES and that the CICS system is capable of running as a Web server.

5. Add the following DD card:

```
//EYUPARM DD *
NAME(@wuiname@)
```

CICSPLEX(WUIPLEX1)
CMASSYSID(@cmssysid@)
SEC(NO)

Note: @wuiName@ MUST match the WUI name you specified when creating the CMAS Data Repository. @cmssysid@ MUST match the system ID of the CMAS NOT the WUI server system ID.

```
//EYUWUI DD *  
TCPIPHOSTNAME(@hostname@)  
TCPIPPORT(@portnumber@)  
DEFAULTCMASCTXT(@cmasname@)  
DEFAULTCONTEXT(@mainplex@)  
DEFAULTSCOPE(@mainplex@)  
AUTOIMPORTDSN(@cpsmhlq@.SEYUVIEW)  
AUTOIMPORTMEM(EYUEA*)  
CMPIPORT(@cmciportnumber@)
```

- ▶ @hostname@ is the TCP/IP host name for the IP stack that CICS will be using. This value is also used when configuring the connection to this WUI server in CICS Explorer.
- ▶ @portnumber@ is a port number that was allocated for the use of the WUI server. This value is used by Web Browser Users.
- ▶ @cmasname@ is the name of the CMAS you are connecting to (for example, the name of the CMAS that you created earlier).
- ▶ @mainplex@ is the name of the CICSplex that you are going to add your existing CICS systems to. It can be any eight-character string (A-Z and 0-9). You will create this CICSplex later. In this example, we use a CICSplex name of TESTPLEX, so in our WUIPARM we will have:
 - ▶ DEFAULTCONTEXT(TESTPLEX)
 - ▶ DEFAULTSCOPE(TESTPLEX)
- ▶ @cpsmhlq@ is the High Level Qualifier for the release of CICS TS that you are working on, for example: CICSTS41.CPSM.SEYUVIEW.
- ▶ @CMCIPORTNUMBER@ is the port number that is allocated for the use of the CICS Management Client interface for this WUI server. This value must be different to @portnumber@. This value is used when configuring the

connection to this WUI server on a CICS Management Interface connection in CICS Explorer.

Example 2-10 on page 34 is an example of all of these changes see. You are now ready to start the WUI server.

Starting the WUI Server

Submit the JCL you just modified. If the WUI starts successfully, you should see messages similar to the following messages in the system log:

```
EYUXL0030I IYK3ZDD4 ESSS connection in progress to CICSplex(WUIplex1)
for SYSID(@cmssysid@)
```

```
EYUXL0004I IYK3ZDD4 ESSS connection complete.
```

```
EYUCL0006I IYK3ZDD4 ESSS link to IYK3ZDD1 established.
```

```
EYUXL0007I IYK3ZDD4 LMAS Phase II initialization complete.
```

```
EYUNL0099I IYK3ZDD4 LMAS LRT initialization complete.
```

At the top of the EYULOG you should see messages similar to the following messages. There will also be additional messages after these, but do not worry about them because they mostly relate to the WUI loading the Views and Menus that it is going to use:

```
EYUVS0101I IYK3ZDD4 Parameter service initialization complete.
```

```
EYUVS0200I IYK3ZDD4 Starting CICS Web Interface.
```

```
EYUVS0204I IYK3ZDD4 TCP/IP service (EYUWUI) installed successfully.
```

```
EYUVS0206I IYK3ZDD4 CICS Web Interface enabled on TCP/IP port number
@portnumber@.
```

```
EYUVS0204I IYK3ZDD4 TCP/IP service (EYUCMCIT) installed successfully.
```

```
EYUVS0209I IYK3ZDD4 URI map (EYUCMCIU) installed successfully.
```

```
EYUVS0211I IYK3ZDD4 CICS Management Client Interface enabled on TCP/IP
port number @cmciportnumber@.
```

```
EYUVS0002I IYK3ZDD4 CICSplex SM Web User Interface initialization
complete.
```

```
EYUVS0010I IYK3ZDD4 Server connected to CMAS, SYSID(@cmssysid@).
```

If WUI initialization does not complete go back and make sure that all of the names, APPLIDs, and system IDs that you defined are correct.

You are now ready to create a CICSplex for all of the CICS systems that you want to manage.

2.5.4 Creating a CICSplex to manage your systems

We are now going to define a CICSplex that will be used to manage your existing CICS systems. We also define your CICS systems to the CICSplex, so that when you start those systems, CICSplex SM knows which CICSplex they are being managed by. Example 2-11 shows a sample JCL for creating the CICSplex and defining your CICS systems.

Example 2-11 Sample JCL to create CICSplex

```
//CPSMDEFN EXEC PGM=EYU9XDBT
//*
//STEPLIB DD DISP=SHR,DSN=@cpsmhlq@.SEYULOAD
// DD DISP=SHR,DSN=@cpsmhlq@.SEYUAUTH
//*
//SYSTSPRT DD SYSOUT=*
//EYUTRCF DD SYSOUT=*
//*
//EYUCPDEF DD DISP=SHR,DSN=@cpsmhlq@.SEYUPARM(EYUCPDEF)
//EYUCSDEF DD DISP=SHR,DSN=@cpsmhlq@.SEYUPARM(EYUCSDEF)
//EYUCSGRP DD DISP=SHR,DSN=@cpsmhlq@.SEYUPARM(EYUCSGRP)
//*
//EYUSYSIN DD DDNAME=SYSIN
* Set CONTEXT to CMAS
CONTEXT @cmasname@
* Define the CICSplex
DEFINE CICSplex @plexname@
* Set CONTEXT to the CICSplex
CONTEXT @plexname@
* Define a CICS region
DEFINE REGION @systemname@ -
        APPLID @systemapplid@ -
        SYSID @systemsysid@ -
        CMASID @cmasname@
```

To create a CICSplex that manages your systems:

1. @cpsmhlq@ is the High Level Qualifier for the release of CICS TS that you are working on, for example: CICSTS41.CPSM.
2. @cmasname@ is the name of the CMAS you are connecting to (for example, the name of the CMAS that you created earlier).
3. @plexname@ is the name of the CICSplex that is going to manage your systems. This is any name up to eight characters long (A-Z and 0-9). For this example, TESTPLEX would be a valid name to enter here.

4. @systemapplid@ is the APPLID of a CICS system that you want to manage in your CICSplex. Find the APPLID SIT parameter in the JCL for the system you want to manage, and copy its value into this variable.
5. @systemsysid@ is the system ID of the CICS system that you want to manage in your CICSplex. Find the SYSIDNT SIT parameter in your CICS JCL, and copy its value into this variable. If you do not have a SYSIDNT SIT parameter, create a four-character identifier. The last four characters of the system's APPLID can be used for this. This value must be unique.
6. @systemname@ is simply a name that CICSplex SM uses to identify the system. You can use up to 8 characters (A-Z and 0-9) for the name, you can use the APPLID of the system as a name. Make a note of the name because you will need it later.
7. Repeat the DEFINE REGION statement for every CICS system that you want to manage in your new CICSplex. Do not forget to change that variable to match the APPLID of each system.
8. Submit the job, which should cause all of your new definitions to be created.

You are almost ready to manage your CICS systems through CICSplex SM. The last step before starting your systems is to alter the JCL of your CICS systems to allow them to connect to CICSplex SM.

2.5.5 Modifying your existing CICS system JCL

Take the JCL that you have for an existing CICS system that you want to be managed by CICSplex SM, and make the following modifications to it:

1. Add the following dataset to your STEPLIB (as before the variables used depend of the release of CICS TS you are using):

```
@cpsmhlq@.SEYUAUTH
```
2. Add the following to DFHRPL:

```
@cpsmhlq@.SEYULOAD
```
3. Add the following SIT parameter:

```
CPSMCONN=LMAS
```
4. Add or change the SEC SIT parameter (you can turn on security at a later date):

```
SEC=NO
```
5. Add the following DD card:

```
//EYUPARM DD *
      NAME(@cicsname@)
```

CICSPLEX(@plexname@)

CMASSYSID(@cmsysid@)

The variable @cicsname@ is the name of the CICS system that we defined in the WUI, which MUST match the name defined in the WUI or else the system will not connect to the CICSplex. In our example, our system names are the same as our systems' APPLIDs. @plexname@ is the name of the CICSplex that we created in the WUI; however, in our example, this was TESTPLEX. @cmsysid@ is the system ID of the CICS system that is acting as out CMAS.

After you make these changes, you can submit your JCL and start your managed CICS system. If the CICS system successfully connects to the CICSplex, you should see the following messages in the system log:

```
EYUXL0030I IYK3ZDD4 ESSS connection in progress to CICSPLEX(DWDPLEX1)
for SYSID(DANA).
```

```
EYUXL0004I IYK3ZDD4 ESSS connection complete.
```

```
EYUCL0006I IYK3ZDD4 ESSS link to IYK3ZDD1 established.
```

```
EYUXL0007I IYK3ZDD4 LMAS Phase II initialization complete.
```

```
EYUNL0099I IYK3ZDD4 LMAS LRT initialization complete.
```

If the connection to the CICSplex fails, check that the NAME in the EYUPARM in your JCL matches the "CICS system definition name" for the definition you defined through the WUI.

Repeat this step for all of the CICS systems that you want CICSplex SM to manage.

2.5.6 Conclusion

To set up CICSplex SM, you:

1. Turned a CICS system into a CMAS
2. Turned a CICS system into a WUI server
3. Created a CICSplex
4. Defined your CICS systems to the CICSplex
5. Modified your existing CICS systems to allow them to connect to the CICSplex



Implementing IBM CICS Explorer

In this chapter, we discuss how to install the CICS Explorer. We focus on local and remote installation and CICS Explorer Security.

3.1 Installing CICS Explorer

CICS Explorer offers a range of installation options. In this section, we discuss the various options. When deciding on the best approach for installing the CICS Explorer within an organization it is important to consider your corporate guidelines and security requirements for client applications.

CICS Explorer can either be installed on each users local client machine or on a remote server for all users to access. Regardless of which option you choose, a users own customized data can be saved to the user private storage area.

Both local and remote installations of CICS Explorer start with the download of the appropriate distribution for your operating system. CICS Explorer is provided as an archive file:

- ▶ Windows file is a zip file
- ▶ Linux is a tar file

To download CICS Explorer, visit the following Web location, and then click the appropriate link under Downloads.

<http://www.ibm.com/software/htp/cics/explorer/>

3.1.1 Installing CICS Explorer locally

Extract the distribution file as appropriate for the operating system. Because there is no set up application required to install CICS Explorer, it is recommended that you expand the archive file to a suitable location on the systems file system, for example c:\program files\ on Windows and /opt/ on linux.

Figure 3-1 on page 45 shows the structure for Windows. Figure 3-2 on page 45 shows the structure for Linux.

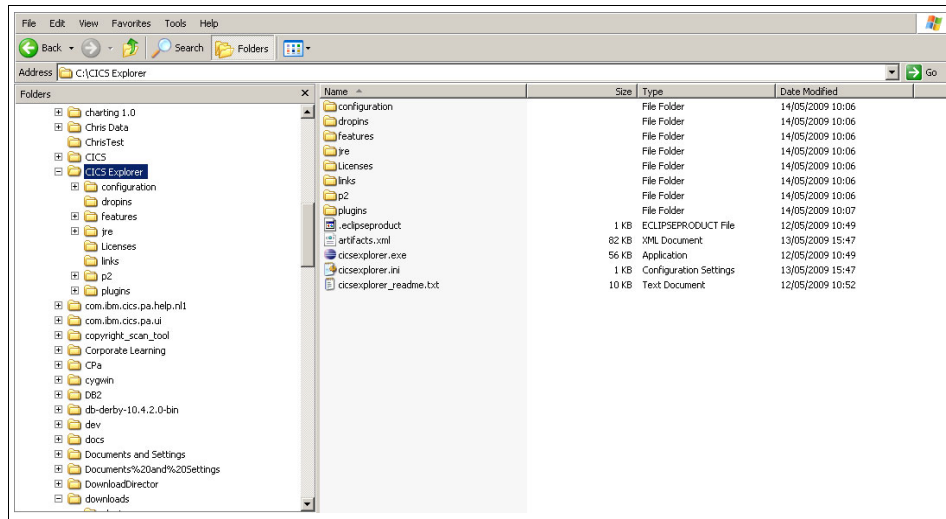

Figure 3-1 Windows view

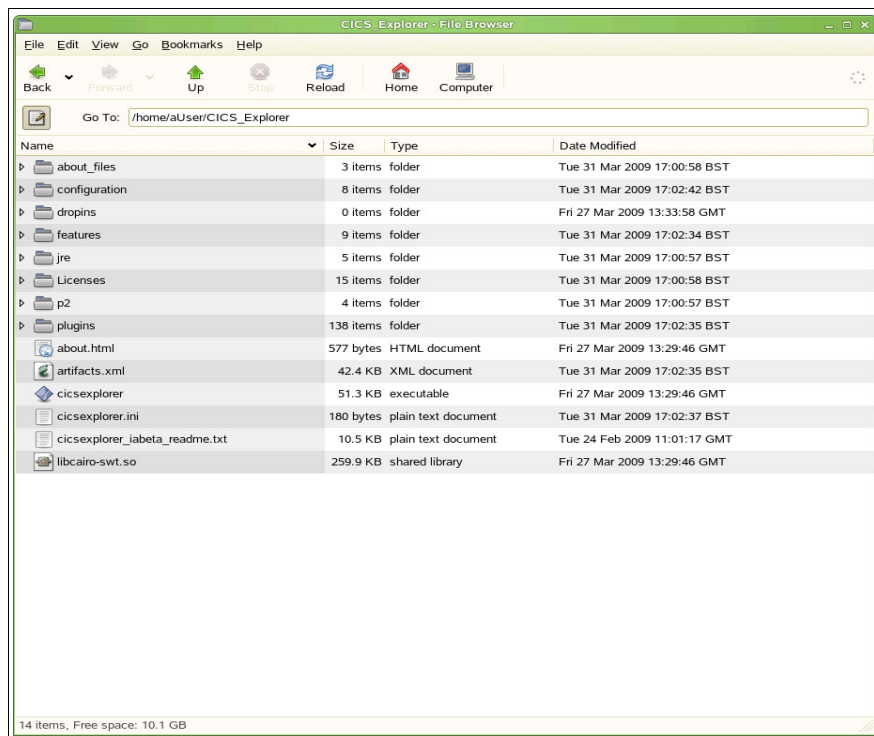

Figure 3-2 Linux view

You can decide if you want to create a desktop shortcut to the CICS Explorer executable file; however, essentially at this point basic installation is complete.

Alongside the distribution code at runtime CICS Explorer creates a separate directory, known as the workspace, where user specific settings and customizations are written. By default this is in your home directory:

- ▶ On Windows, the location is usually `c:\Documents and Settings\<<User Name>>\.cicsexplorer\`
- ▶ On Linux the location is `/home/<<User Name>>/.cicsexplorer`

Note: On some operating systems, folders that begin with a dot are not shown by default.

You might want to change the location of the workspace, for example, to a shared drive to be accessed from multiple locations. To do this, supply the `-data` option when invoking the CICS Explorer executable file. You can invoke `-data` either from the command line or by creating a shortcut to the file including the `-data` option, for example:

```
cicsexplorer.exe -data d:\myfiles\myworkspace
```

3.1.2 Installing CICS Explorer remotely

You can also install CICS Explorer on a remote server for clients to access. The benefits of this include only having one single copy of the binary to update; however, execution might be a little slower than running the client locally.

The simplest way to install CICS Explorer remotely is to install CICS Explorer onto a shared drive. Each client machine can then access the shared drive. Individual users can then start the CICS Explorer by directly running the executable file or by creating a local shortcut for the remote executable on the local machine. When CICS Explorer is run in this way, the user's workspace is written to their local machine, unless explicitly specified. (See 3.1.1, "Installing CICS Explorer locally" on page 44). When CICS Explorer is run from a remote drive there might be a delay in the time that it takes for CICS Explorer to start up because the binary data is copied over the network.

The benefits of running CICS Explorer remotely is that maintenance needs only to be applied to a single copy of the application binary and that it also removes the overhead of rolling the application out to every workstation. The disadvantages of running CICS Explorer remotely is that the initial start up time of CICS Explorer can be longer than if it were running locally.

You can run CICS Explorer remotely regardless of which operating system is used because the remote server is just acting as a file store. All of the processing is performed on the local machine.

You can also run CICS Explorer from a shared Linux server using any windows system to allow the GUI to be displayed on a users local terminal. To do this, install the CICS Explorer onto a Linux server in a location that is readable by logged on users. Users can then log onto the remote system using their preferred Windows package. After the users log on, they can run CICS Explorer on the remote system. When CICS Explorer is being run from a remote Linux server in this manner, the CICS Explorer binary executes on the server using the server's memory and CPU resources. The user's workspace is stored in the user's home directory and not on the local workstation.

3.2 CICS Explorer security

When CICS Explorer connects to any CICS system it can encrypt the link between it and the remote system. It also has the ability to provide security credentials to the CICS system for authentication of requests. In this section, we discuss the different options that are available.

Because CICS Explorer uses CICSplex System Manager to process user requests, the same level of security that is available within your CICSplex is available through the explorer.

When connecting to a CICS System through CICS Explorer users must use the same credentials they would use if logging into the CICSplex SM Web User Interface or the CICS region itself. When the user makes a request against the system CICS verifies that the credentials are correct and that the user has the correct authority to make that request.

Tip: If the system you are connecting to does not require you to sign on, you must enter a username into the connection preferences panel, but you can leave the password field blank.

As well as providing authentication information to the CICS region, you can also secure the communications link between the explorer and your CICS system. By default CICS Explorer uses unsecured HTTP requests, which means that system information flows over the network as plain text. Secure Sockets Layer (SSL) encryption can be used to encrypt the data flow between CICS Explorer and CICS, which are both supported by changing the TCP/IP Service that is used by the CICS Explorer to connect to the CICS system.

3.2.1 Using HTTP Basic Authentication

When using HTTP Basic Authentication, when you attempt to make a connection to the TCP/IP port, you are prompted to provide a username and password before the connection is established. HTTP basic authentication can be used to provide a level of DOS attack protection because only users with valid credentials are allowed to make a connection.

To use HTTP basic authentication in your environment, you must specify the value `basic` for the `Authenticate` property of the TCP/IP Service that is used as the entry point for the CICS Explorer.

During a connection attempt, CICS Explorer uses the same credentials that you specified in the connection preferences in response to a HTTP Basic Authentication Challenge.

3.2.2 Using SSL

CICS Explorer can use SSL to encrypt the link between it and the CICS system. However CICS Explorer cannot use a private certificate to affirm a user ID. The process is slightly different depending on if you are connecting CICS Explorer to a WUI server or a single CICS region.

SSL connection to a WUI server

Add the WUIPARMS:

- ▶ TCPIPSSL(YES)
- ▶ TCPIPSSLCERT(NAME)

The name of the TCPIPSSLCERT should be the name of a certificate that is attached to the keyring specified in the keyring SIT parameter. If TCPIPSSLCERT is omitted, the default certificate that is attached to the keyring is used instead.

Setting this parameters ensures that when CICS defines the TCP/IP Service resource definition for the CMCI port that the correct attributes are set for SSL operation.

SSL connection to a single CICS region

Change the TCPIPService resource that you are using to connect to the CICS region:

SSL = YES

You also need to ensure that you have a default certificate specified in the keyring that CICS is using.

3.3 Updating the CICS Explorer

Because CICS Explorer is built on Eclipse technology, you can automatically update it using the same mechanism that is used to update Eclipse.

3.3.1 Updating from the Internet

You can update CICS Explorer directly from a Web server. IBM will host an update site that contains updated versions of the CICS Explorer. Alternatively, your enterprise might provide an internal site.

CICS Explorer updates: All CICS Explorer updates will be available from:
<http://download.boulder.ibm.com/ibmdl/pub/software/htp/cics/updates/explorer/>

To update the CICS Explorer from the IBM site:

1. From the Help menu, select **Software Updates**.
2. From the Installed Software tab, select **IBM CICS Explorer**, as shown in Figure 3-3 on page 50.
3. Click **Update**.

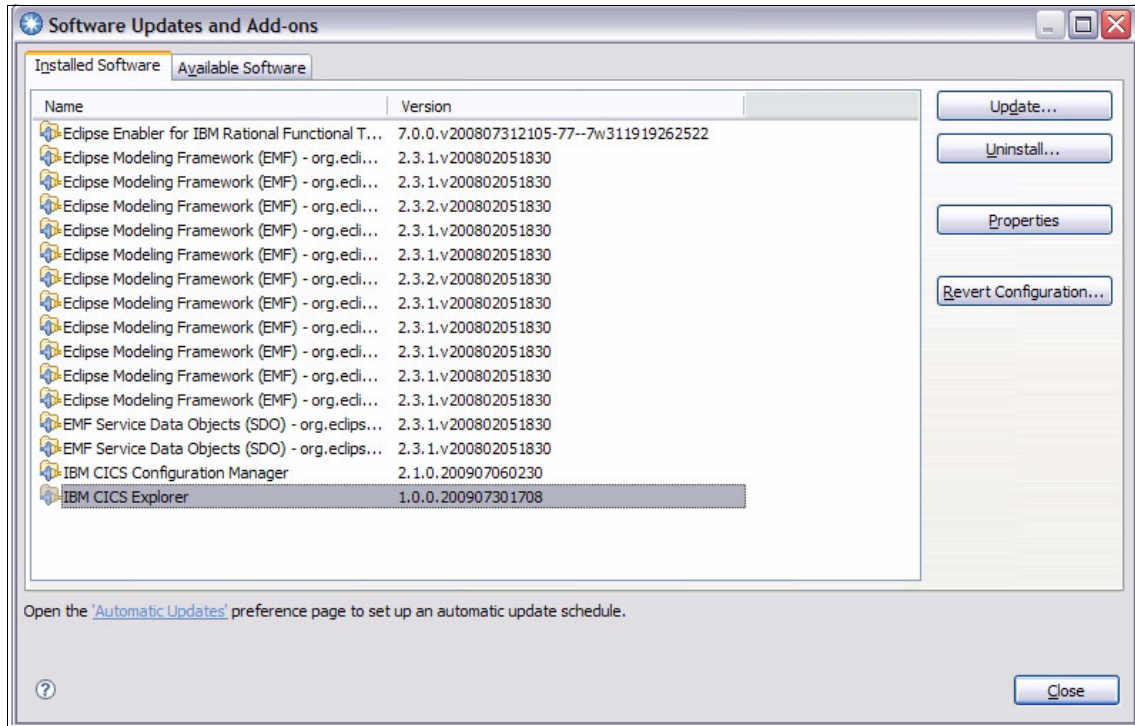

Figure 3-3 Software Updates Screen

CICS Explorer will now download and install the updates.

If your system administrator supplied you with a URL to use as an internal mirror of the IBM update site, alter your configuration to remove the IBM update site, and add the internal one:

1. From the Help menu, select **Software Updates**.
2. From the Available Software tab, select **Manage Sites**.
3. Select the site that points to:

<http://download.boulder.ibm.com/ibmdl/pub/software/htp/cics/updates/explorer/>

4. Click **Remove**.

The IBM site is now removed from the list of update sites. Now add your internal site.

5. Click **Add**.
6. In the next dialog, enter the name of the update site as provided to you by your system administrator, and click **OK**.

You can now update the CICS Explorer as shown. If the Web server that is hosting the update site requires authentication, you will be prompted for your credentials.

Restriction: Due to issues surrounding the update mechanism, we do not recommend that you allow CICS Explorer to save your password when connecting to an update site.

3.3.2 Updating from an archive file

If you are unable to connect to the Internet to update CICS Explorer, it is possible to update from a local archive file. An archive file is a compressed zip file that contains the same content that the update site has.

To update CICS Explorer from an archive file:

1. Download the archive file to your local machine. Put the file in a location that you can remember.
2. From the Help menu, select **Software Updates**.
3. From the Available Software tab, select **Manage Sites**.
4. Click **Add**, and then click **Archive**.
5. On the next dialog, navigate to the archive file that you downloaded.
6. Click **Open**, and then click **OK**.

You can now update the CICS Explorer, as we discussed in 3.3.1, “Updating from the Internet” on page 49

3.3.3 Updating automatically

After you configure CICS Explorer with an update site that the software can access, you can configure CICS Explorer to automatically search for updates on a regular basis, which ensures that you are kept up-to-date with new features of the CICS Explorer:

1. From the Help menu, select **Software Updates**.
2. Expand **Install/Update**.
3. Select **Automatic Updates**. Figure 3-4 on page 52 is displayed.

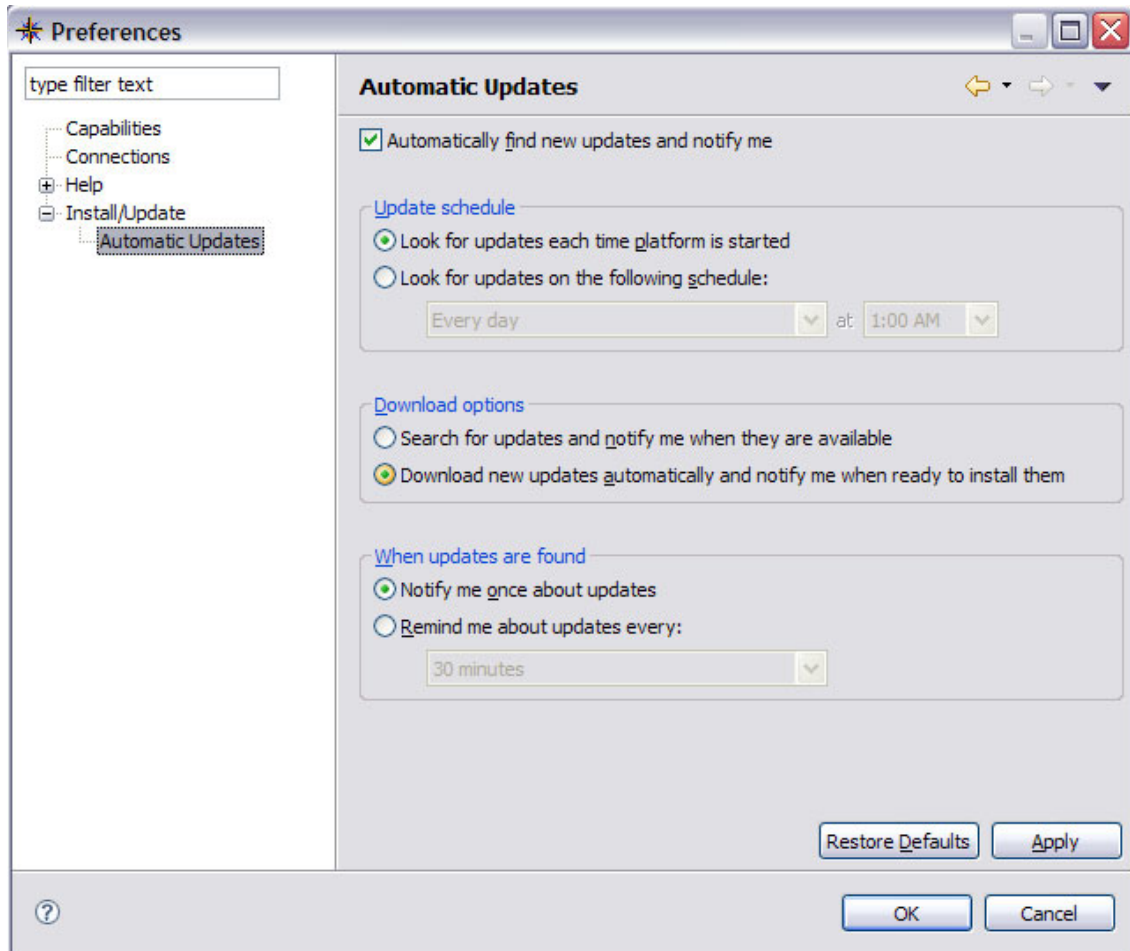

Figure 3-4 Automatic Update dialog

The dialog in Figure 3-4, then gives options that allow you to specify when the update site should be checked for new updates. After you make your selections, click **Apply** and **OK**.

3.4 Enterprise deployment

In this section, we discuss enterprise deployment of CICS Explorer.

3.4.1 Providing local mirrors

If your enterprise does not allow for users to access the Internet, it is possible to set up an internal mirror of CICS Explorer. Users can install and receive updates from the local mirror.

The CICS Explorer installation archive file can be freely downloaded and stored on an internal server to allow internal downloads. Alternatively it can be incorporated into an automated software delivery system.

Archive sites: The archive site files are stored separately on the main update site:

<http://www.ibm.com/support/fixcentral/>

CICS Explorer is under the product group WebSphere.

If you are providing a local mirror for users, you might also want to provide a local mirror of the IBM update site so that users can update their copy of CICS Explorer. This can either be a local copy of the update archive file or a copy of the entire update site.

The best practice is to provide a mirror of the IBM update site that is regularly updated. This method allows users to automatically update CICS Explorer from the local mirror with little intervention, ensuring that users are always using the most up-to-date version of the software.

3.4.2 Pre-installation customization

When considering implementing CICS Explorer within an enterprise you might want to provide some customizations that are specific to your organization, for example, pre-configured connection information to your CICS systems and custom panel layouts for specific user groups.

CICS Explorer saves customization and preferences within a folder that is known as the workspace. If you want to provide pre-installation customizations to the CICS Explorer, you must also provide a copy of the workspace that contains the customizations and ensure that your users start CICS Explorer correctly to use this workspace.

The main process to follow is:

1. Install CICS Explorer using `-data <<folder name>>` to specify a new workspace.

Workspace Location: Record the location of the workspace folder because you will need it later.

2. Make your customizations.
3. Export the created workspace to an archive.

Customizing perspectives

You can customize the CICS Explorer to create new perspectives. Custom perspectives can be useful to complete certain tasks, for example, when investigating why a certain resource is failing, it is useful to only see the views that are associated with that resource. Working with CICS Web services might only require the Web service, pipeline, urimap and TCP/IP operational views, while creating new application definitions require the definitional views.

Restriction: You cannot add internal update site locations to a customized workspace.

To create a new perspective, change and arrange the number of views on display by:

- ▶ Opening new views
- ▶ Closing open views
- ▶ Changing the position and size of a view
- ▶ Changing the columns that are displayed as part of a view

After the window is arranged as required:

1. On the menu bar, click **Window**.
2. Click **Save Perspective As**.
3. Enter a useful name for the new perspective.
4. Click **OK**.

The perspective is now saved and available from the **Window, Open Perspective** dialog.

Customizing connection details

You can pre-customize CICS Explorer to have predefined connection definitions to the CICS systems that your users want to connect to:

1. On the menu bar, click **Window**.

2. Select **Preferences** → **Connections**.
3. Enter the connection details.

Tip: When entering connection details do not enter your own user ID and password; however, you must enter some text in the userID field to ensure that CICS Explorer saves the connection. We suggest that you enter **USER**.

4. Click **Apply**, and then click **OK**.

After you finish customizing the CICS Explorer, you must close it before you can successfully export the workspace.

Now you can compress the workspace into an archive file to share with your users.

Important: Ensure the integrity of the archive after you create it. Some compression programs omit folders and files that begin with the '.' character. Such files exist in the workspace.

To consume the customizations, users must extract the workspace to their local machine. When starting the CICS Explorer they can then specify where to extract the workspace to.

3.5 Plug-ins

The individual plug-ins are downloaded from the appropriate support sites in the form of a site.zip file, which contains the executable code and the necessary licence agreements. After the file is downloaded onto the users machine it can be integrated into the installation:

1. From the Help menu, select **Software Updates**, as shown in Figure 3-5 on page 56.

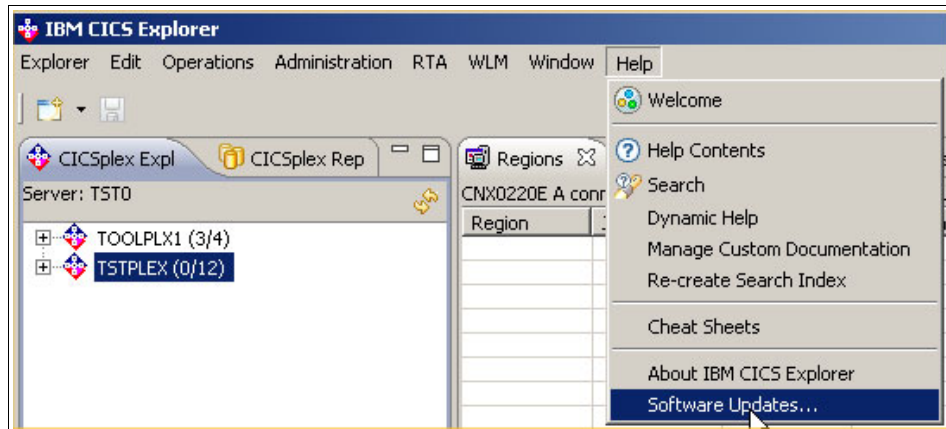

Figure 3-5 Software Updates menu

2. Click the **Available Software** tab, and click **Manage Sites**.

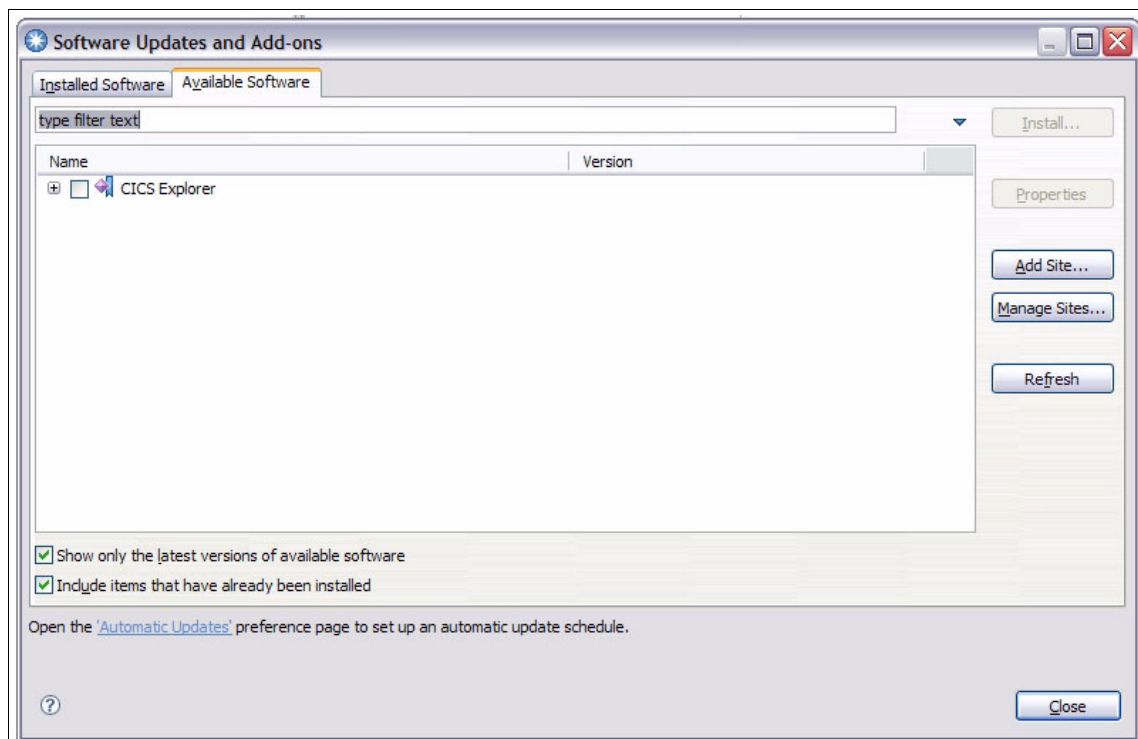

Figure 3-6 Available Software tab

3. Click **Add**. In the Add Site pop-up, shown in Figure 3-7, click **Archive** to select the zip file that you downloaded.

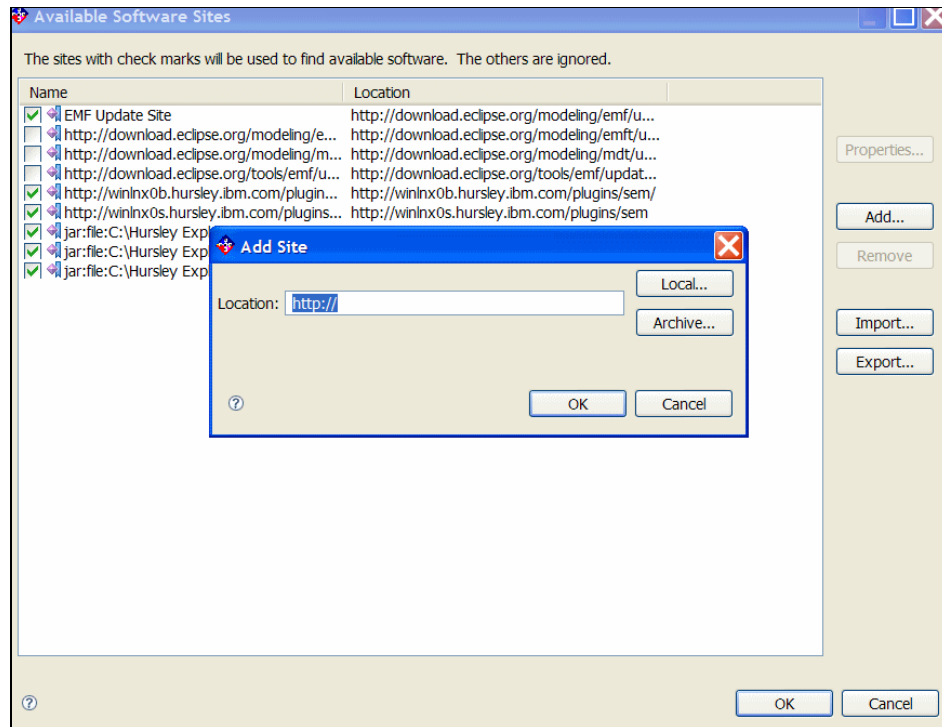

Figure 3-7 Add Site window

4. Click **OK** to close the pop-up.
5. Click **OK** to close the Available Software Sites window.
6. In the Available Software Tab, select the plug-in that you wish to install, as shown in Figure 3-8 on page 58.

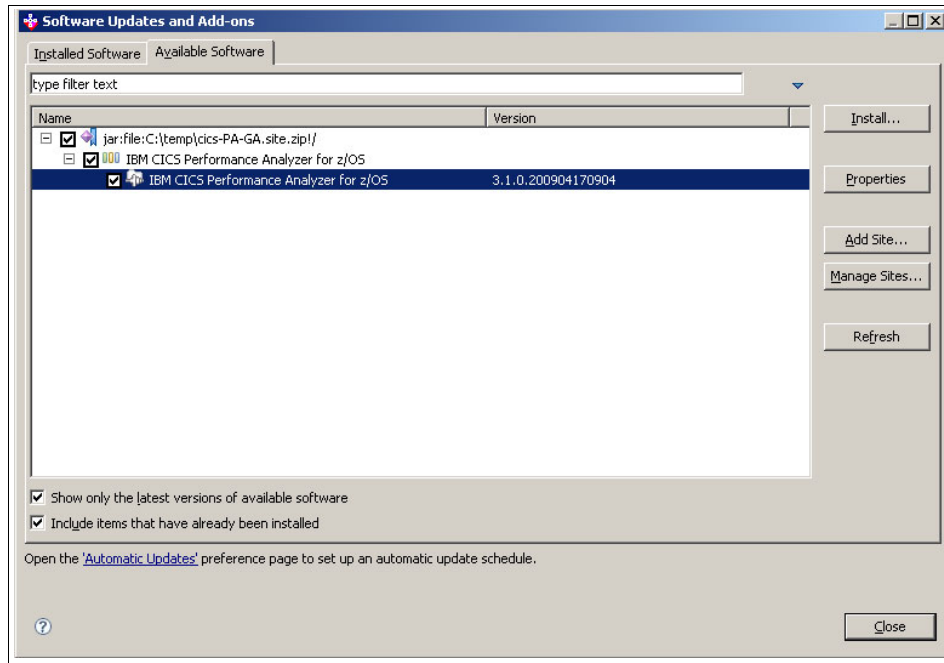

Figure 3-8 Plug-in check box

7. Click **Install**. Eclipse ensures that your selection is compatible with your installation. If everything is fine, Eclipse prompts you to accept the terms of the license agreement.
8. Agree to the terms of the license, and then click **Finish**.
9. After the installation is finished you are prompted to restart CICS Explorer. Click **Yes**. After the installation is complete, the Welcome window is displayed to show the new functionality that has been added to CICS Explorer.



CICS Explorer base familiarization

In this chapter, we look at the CICS Explorer base, and discuss Perspectives, Connections, Views, and the Editor.

4.1 Perspectives

CICS Explorer provides two perspectives for interacting with CICS:

- ▶ Resource

The Resource perspective is primarily concerned with the manipulation of event bindings and bundle projects.

- ▶ CICS SM

The CICS SM perspective is concerned with the viewing and manipulation of CICS resources, and is the focus of this chapter.

4.2 Connections

In this section, we discuss connections.

4.2.1 Connection Manager

In the Explorer, the status of any connections are represented by the connection manager, which resides in the bottom right corner of the Explorer window, as shown in Figure 4-1 on page 61.

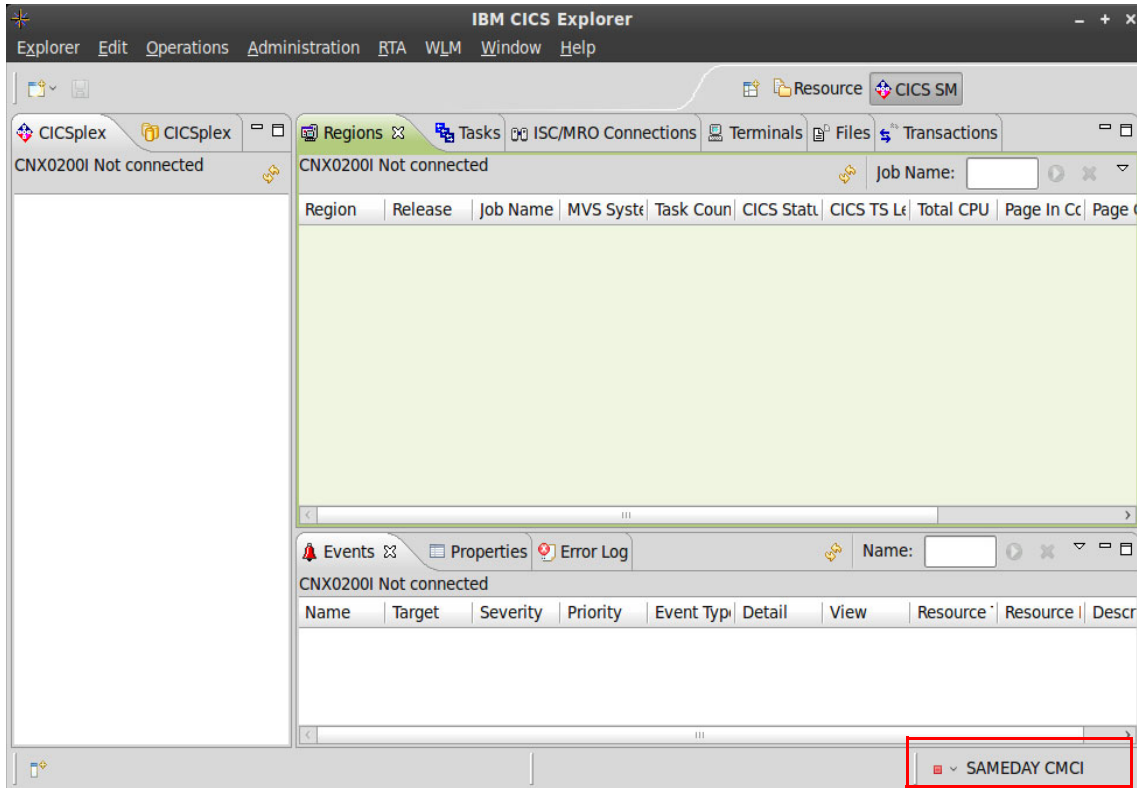







Figure 4-1 Connection Manager Location

When the CICS Explorer is configured with some connections, clicking the arrow on the connection status trim widget displays a list of available connections. Selecting one of these causes the CICS Explorer to attempt to establish that connection using the saved details. The connection manager icon represents the state of the named connection. Table 4-1 shows the Connection Manager status icons.

Table 4-1 Connection Manager status icons

Connection Status icon	Connection state
	Disconnected
	Connecting

Connection Status icon	Connection state
	Connection Established
	Secure Connection Established
	Connection Error

When you click the red square, the system attempts to connect to currently the named connection. While connecting, the icon changes to a yellow diamond. A successfully established connection is represented by a green circle. When a connection is established, clicking the green circle causes the Explorer to disconnect.

4.2.2 Connections Preference page

Connections in the explorer are managed through the connections preference page.

To access the connections preference page:

1. Click the text on the connection status trim widget, or use the menus Window → Preferences, to open the preferences dialog.
2. From the tree on the left side, select **Connections**, as shown in Figure 4-2 on page 63.

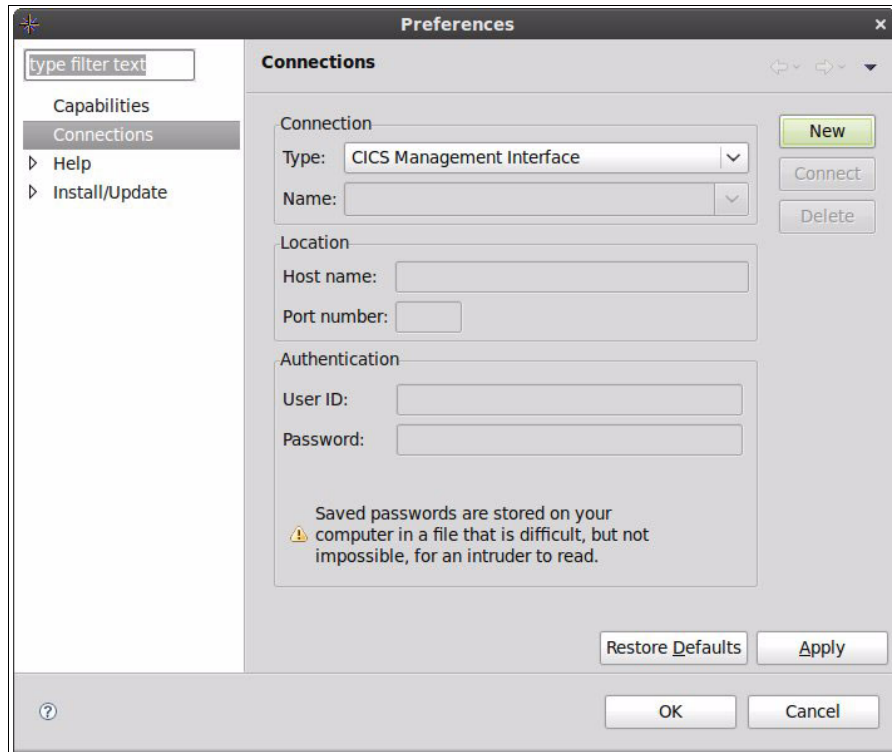

Figure 4-2 Connections Preference Page

To enter details for a new connection:

1. Select the type of connection that you want to define, and click **New**.
2. After you specify your connection details, click **Apply** to save them.
Alternately, you can click **OK** to save and close the preferences dialog.

Connections are categorized in the preferences page based on connection type. To view available connections for a specific connection type, in the Type combo, select the type of connection you want to examine. The Name combo is then populated with a list of connections of that type from which you can select.

The Type, Name, Host name, Port number, and User ID fields are mandatory. Passwords can optionally be specified for authenticated connections. If a password is not specified, CICS Explorer will prompt for one when establishing the connection.

4.2.3 CICS Explorer connectivity

In our CICS Explorer, we click **Window** → **Preferences**, and select the connection settings field, as shown in Figure 4-3.

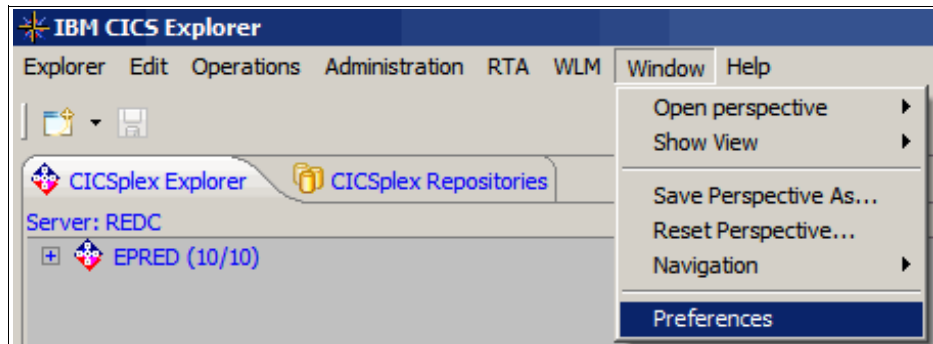

Figure 4-3 Explorer preferences

We use connection type CICS management client interface (CMCI), as shown in Figure 4-4 on page 65.

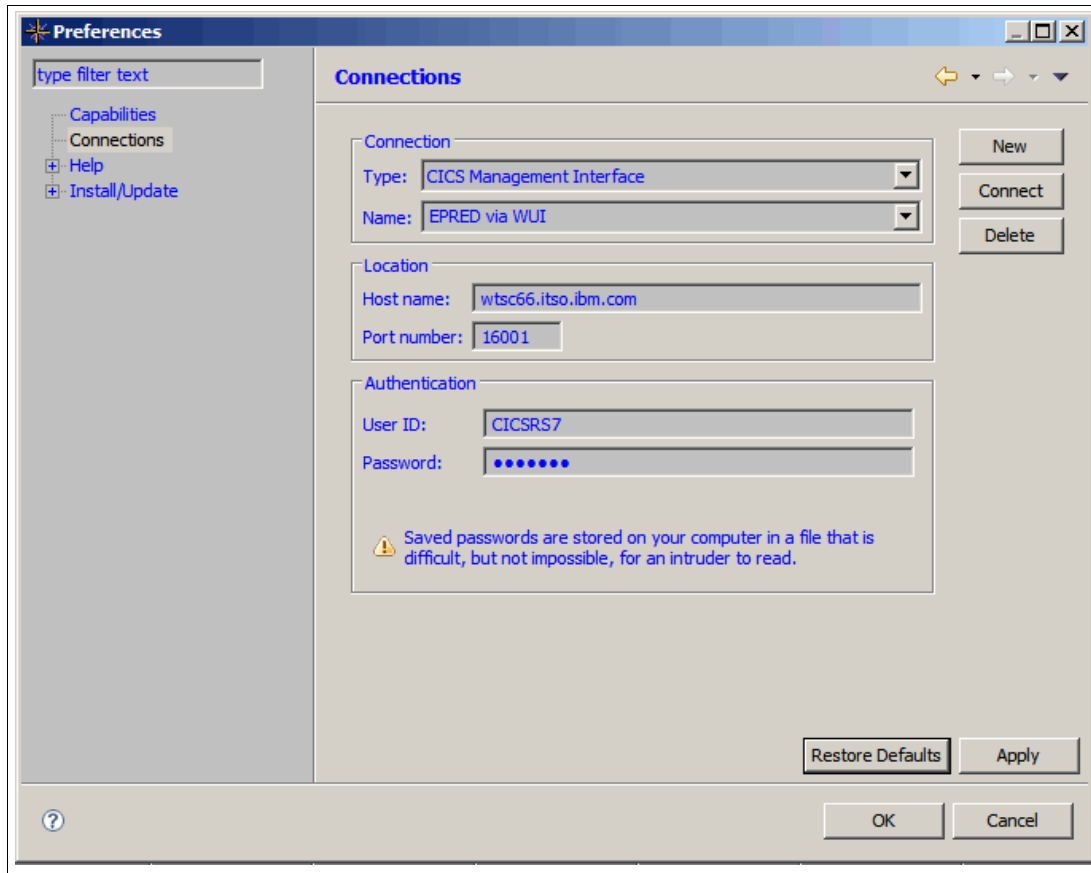

Figure 4-4 CICS Explorer connection options

Note: We use connection type CICS Management Interface to enable update capability. The default connection type, CICSplex SM Data Interface, allows read only capability.

Our Web user interface (WUI) server (Hostname: wtsc66.itso.ibm.com) has port = 16001. The CMCIPORT system initialization parameter for our WUI is set as CMCIPORT =16001.

In the CICS Transaction Server for z/OS Version 4 Information Center, read *Setting up the CICS management client interface* for further details:

https://publib.boulder.ibm.com/infocenter/cicsts/v4r1/index.jsp?topic=/com.ibm.cics.ts.clientapi.doc/topics/clientapi_setup.html

4.3 Views

In this section, we look at the two types of views: tabular and tree.

The context limits what data is displayed in most views:

- ▶ The context of a view can be manipulated by the CICSplex Explorer view or the CICSplex Repositories view.
- ▶ The CICSplex Explorer view can be used to set the context to a CICSplex or CICS region.
- ▶ The CICSplex Repositories view can be used to set the context to a resource group or system group.
- ▶ The Resource Group Definitions view can also be used to set the context to a resource group.

CICS Object Table Views use the last appropriate context that the user selected when populating, for example, only CICS definition views repopulate using a resource group because their context when one is selected by the user.

4.3.1 The CICSplex Explorer view

When connected to CICSplex SM, the CICSplex Explorer view, Figure 4-5, displays a list of CICSplexes. When using CMCI to connect to a single CICS region, the CICSplex Explorer view shows the region that you are connected to.

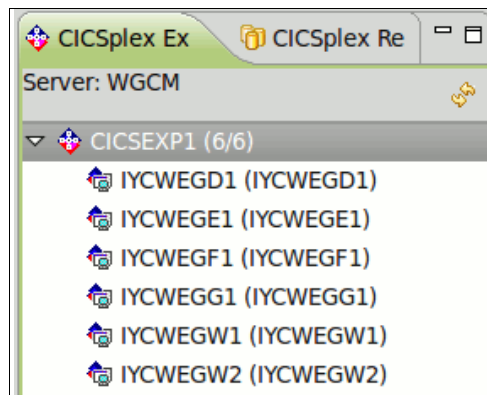

Figure 4-5 The CICSplex Explorer view

Expanding a CICSplex shows the managed regions within that CICSplex. If the icon is colored, then the managed region is active. If the icon is monochrome, then the region is inactive.

Selecting a CICSplex or a managed region sets the context accordingly.

4.3.2 The CICSplex Repositories view

The CICSplex Repositories, Figure 4-6, view shows the available resource groups, the available system groups, and their members.

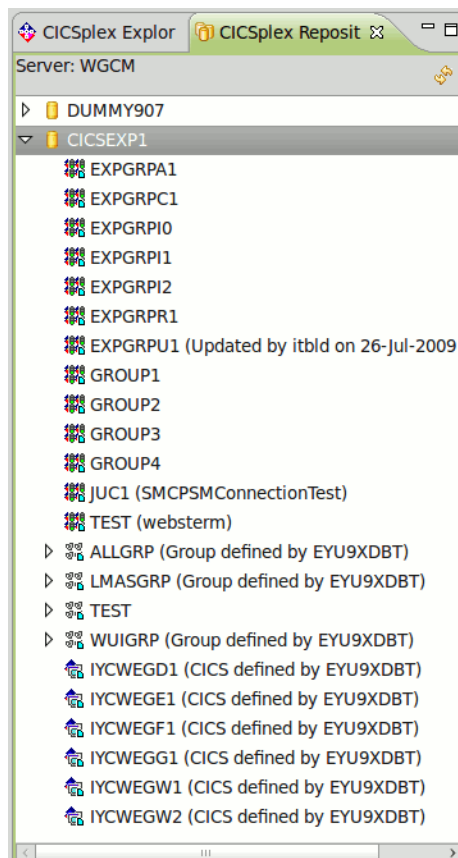





Figure 4-6 CICSplex Repositories view

Table 4-2 on page 68 shows the icons for the CICSplex Repositories view.

Table 4-2 CICSplex Repositories view icons

Icon	CICS object
	System Definition
	System Group
	Resource Group

Selecting any of these resources in the CICSplex Repositories view sets the context of any open CICS Object Table view where appropriate. System groups can be expanded to view their members, which might be either nested system groups or system definitions.

4.3.3 CICS Object Table views

CICS Object Table views display CICS resources of a specific type, from the current context. You cannot open Resources views from the Administration, Operations, WLM, and RTA menus.

Operations views

The Operations views are:

- ▶ Atom Services
- ▶ Bundles
- ▶ Bundle Parts
- ▶ Capture Specifications
- ▶ Completed Tasks
- ▶ DBCTL Subsystems
- ▶ DB2® Connections
- ▶ DB2 Entries
- ▶ DB2 Transactions
- ▶ Document Templates
- ▶ Event Bindings
- ▶ Event Processing
- ▶ Files
- ▶ Global Dynamic Storage Areas
- ▶ Interval Control Requests

- ▶ IPIC Connections
- ▶ ISC/MRO Connections
- ▶ JVM Class Caches
- ▶ JVM Pools
- ▶ JVM Profiles
- ▶ JVM Servers
- ▶ JVM Status
- ▶ Libraries
- ▶ Library DS Name
- ▶ Pipelines
- ▶ Process Types
- ▶ Programs
- ▶ Regions
- ▶ RPL List
- ▶ Tasks
- ▶ TCP/IP Services
- ▶ TD Queues
- ▶ Terminals
- ▶ Transactions
- ▶ Transaction Classes
- ▶ TS Models
- ▶ TS Queues
- ▶ Unit Of Work Enqueues
- ▶ URI Maps
- ▶ Web Services
- ▶ WebSphere MQ Connections
- ▶ WebSphere MQ Connection Statistics
- ▶ WebSphere MQ Initiation Queues
- ▶ XML Transforms

Administration views

The Administration views are:

- ▶ Atom Service Definitions
- ▶ Bundle Definitions
- ▶ CorbaServer Definitions
- ▶ DB2 Connection Definitions
- ▶ DB2 Entry Definitions
- ▶ DB2 Transaction Definitions
- ▶ Deployed JAR File Definitions
- ▶ Document Template Definitions
- ▶ Enqueue Model Definitions
- ▶ File Definitions
- ▶ IPIC Connection Definitions
- ▶ ISC/MRO Connection Definitions

- ▶ Journal Model Definitions
- ▶ JVM Server Definitions
- ▶ Library Definitions
- ▶ LSR Pool Definitions
- ▶ Map Set Definitions
- ▶ Partition Set Definitions
- ▶ Partner Definitions
- ▶ Pipeline Definitions
- ▶ Process Type Definitions
- ▶ Profile Definitions
- ▶ Program Definitions
- ▶ Request Model Definitions
- ▶ Session Definitions
- ▶ TCP/IP Service Definitions
- ▶ TD Queue Definitions
- ▶ Terminal Definitions
- ▶ Transaction Definitions
- ▶ Transaction Class Definitions
- ▶ TS Model Definitions
- ▶ Typeterm Definitions
- ▶ URI Mapping Definitions
- ▶ Web Service Definitions
- ▶ WebSphere MQ Connection Definitions
- ▶ Batched Repository Update Requests
- ▶ Resource Group Definitions

RTA views

The RTA view is:

- ▶ Events

WLM views

The WLM view is:

- ▶ Active Workloads

4.4 The Resources View

Figure 4-7 on page 71 illustrates the anatomy of a Resources View.

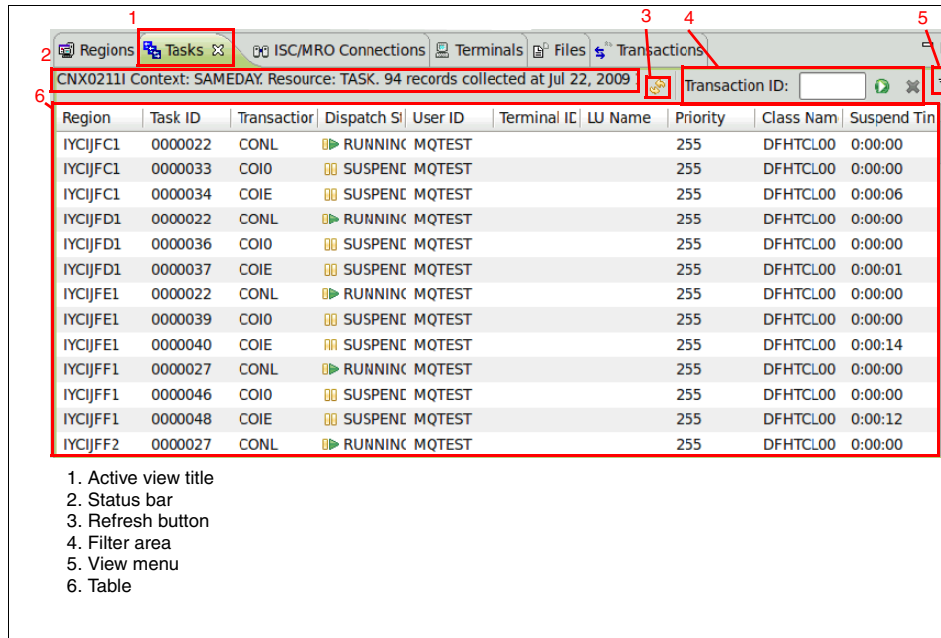

Figure 4-7 Anatomy of a Resources View

The Resources views are tabular views, where each row corresponds to a CICS resource in the current context. Each column represents a different attribute on the CICS resource type. At the top of each resource view is a status bar that is specific to that view, showing the context that is being used to populate the view, the CICS name for the resource that the view is displaying, the number of records that are available the last time the content was refreshed, and the time that the view content was last refreshed. To manually refresh the content of a Resources View, click Refresh, and the view automatically refreshes if visible when the context changes.

To minimize network traffic and server load, CICS Explorer only retrieves enough resources to fill the visible portion of the table. The remainder of the resources are retrieved as the table is scrolled. A consequence of this is that if you are viewing a resource for which a large number of records exist, you might have to wait for the table to be populated as you scroll.

CICS Explorer uses two special values to represent some attribute state, *N/A* and *?*:

- ▶ If an attribute is not supported on an older release of CICS in a CICSplex, the explorer fills its cell in the column with *N/A*.
- ▶ If CICS Explorer encounters an unexpected value for an attribute, its cell in the column is filled with *?*.

Values that represent attribute state: Both of these values are legitimate string values for attributes, so you must carefully determined their meaning.

Columns

Each column in a CICS resource view represents a specific attribute on the type of resource that is being viewed. You can manipulate columns, Figure 4-8, in a resource view by dragging them to a different position to change the order or by dragging the column separators to change the width. Any changes that you make to the layout of the table are persisted by CICS Explorer.

Each resource view has a predefined set of default columns to display, which you can customize by going to the view menu, and selecting **Customize Columns**.

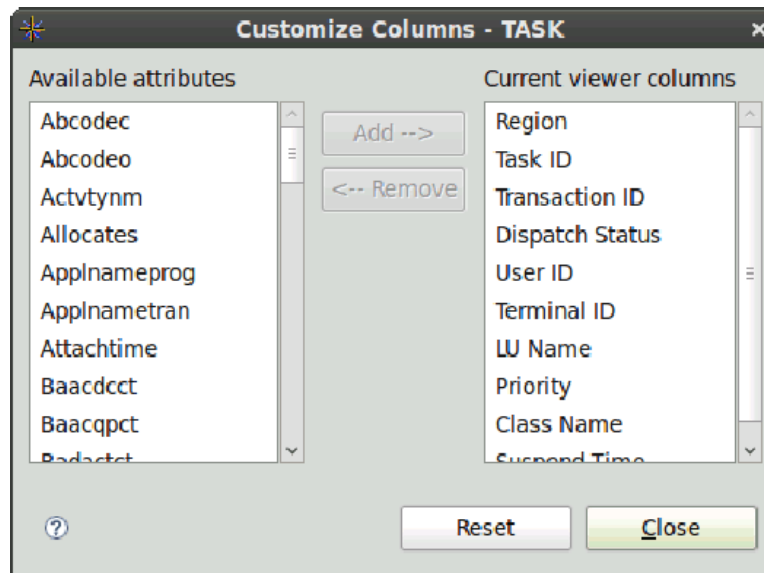

Figure 4-8 The Customize Columns dialog

You can move attributes between the left list of available attributes and the right list of displayed attributes by selecting them from a list and clicking **Add** or **Remove** as appropriate. Click **Close** to apply your changes. Click **Reset** to revert

the displayed columns to the predefined defaults. You can also reset the columns to the default state by selecting **Reset Columns** from the view menu.

Note: If you set the columns for a view without connecting, then establish a connection and further customize the columns. Selecting reset columns resets them to the state that you established without a connection.

Filtering

CICS Object Table Views can be filtered upon the value of most attributes. The filter area, Figure 4-9, displays the currently selected filter fields and the values being used as filter criteria. Each CICS Resource view has a default filter field that is presented initially. You can select additional filter fields by checking the appropriate box from the Choose filter attributes submenu in the view menu. The submenu displays a list of checkboxes that represent all currently visible columns in the view. To filter on additional attributes, you must first add them to the table using the customize columns dialog. Remove filter fields by deselecting them from this list.

Attribute filtering: You cannot filter on date attributes. You cannot filter on Region Name or CICS Release.

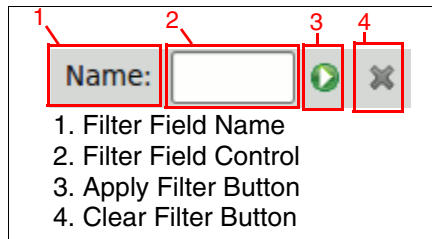

Figure 4-9 Filter area anatomy

For each filter field that is added to the view, the filter area will display the attribute name and an appropriate control for entering a value upon which to restrict the content of the view, either a textbox or a combo.

To apply a text filter:

1. Enter the characters that you want to filter on into the text box.
2. Either press Enter or click **Apply Filter**.
3. Append an * character to the end of your filter string as a wildcard, matching any subsequent combination of characters.

To apply a combo filter:

1. Select one of the available options from the list, and click **Apply Filter**.
2. Select the blank entry to make CICS Explorer disregard that filter.
3. Click **Clear Filter** to set the value of all of the displayed filters to blank, but they are not removed from the view. The state of the filter area is saved by CICS Explorer and recreated when the view is opened.

CICS Object Table Views with multiple types

In some cases, a CICS Resource view can reflect results for multiple CICS Resources, for example, the TD Queues view can display either Indirect, Extrapartition, Intrapartition, or Remote TD Queues.

Figure 4-10 shows the location of the toolbar from which the resource type for a view can be switched. Hover the cursor over each button to determine the type of resource that is represented. The type of resource last used to populate the view is displayed as usual in the view status bar.

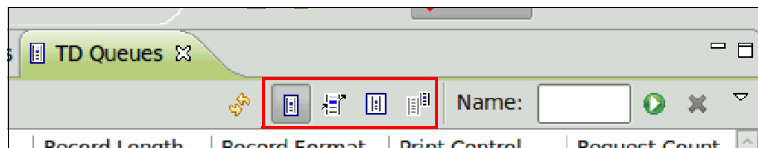

Figure 4-10 Resource selection toolbar location

Table 4-3 shows the views that support multiple resources.

Table 4-3 Views supporting multiple resources

View Name	Supported CICS Resources
TD Queues	<ul style="list-style-type: none">▶ EXTRATDQ▶ INDTDQ▶ INTRATDQ▶ REMTDQ
Files	<ul style="list-style-type: none">▶ LOCFILE▶ REMFILE
Transactions	<ul style="list-style-type: none">▶ LOCTRAN▶ REMTRAN

Performing actions

You can perform actions on resources from the Resources View by right-clicking and selecting the action that you want to perform from the context menu. Actions can be performed on a selection of multiple resources in a similar way. Actions

can only be performed where supported by the underlying connection, which means that you must have a CMCI connection or else the actions are disabled in the menus.

Upon a request to perform an action, the CICS Explorer presents you with a confirmation dialog, as shown in Figure 4-11, which displays the selected resource names and the action to be performed.

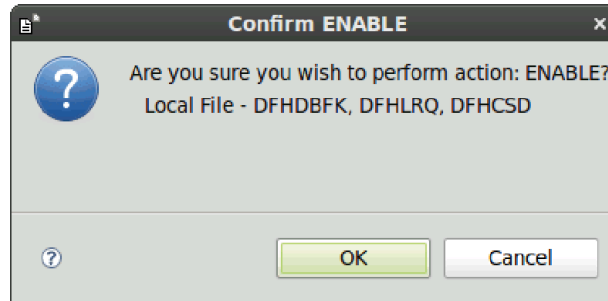

Figure 4-11 Perform action confirmation dialog

Clicking **OK** attempts to perform the action on the displayed list of resources, one by one. If too many resources are selected to list, the total number of resources is displayed instead. A progress bar and status message are displayed as the explorer performs the action. The **Cancel** button remains available to halt action processing part-way through.

CICS Explorer stops processing actions if any action fails. When action processing is completed, the results are displayed in the dialog, and a status message for each action is written to the status bar and the error log. Figure 4-12 on page 76 is an example of an action processing failure message.

Stopping the Explorer: An action processing failure or cancelling action processing stops the Explorer from carrying out any further actions. It will not undo the effect of actions that already processed.

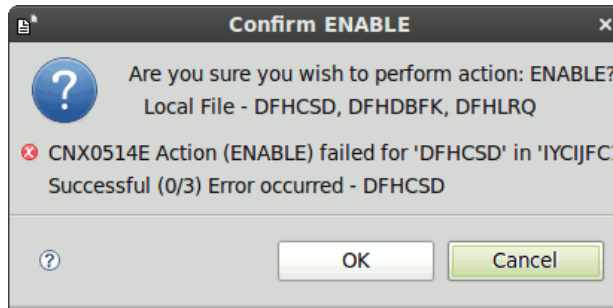

Figure 4-12 Action processing failure

Installing definitions

To install CICS definitions, right-click and select **Install** from the context menu. The Install dialog shows a list of all valid install targets, which includes system groups and managed regions.

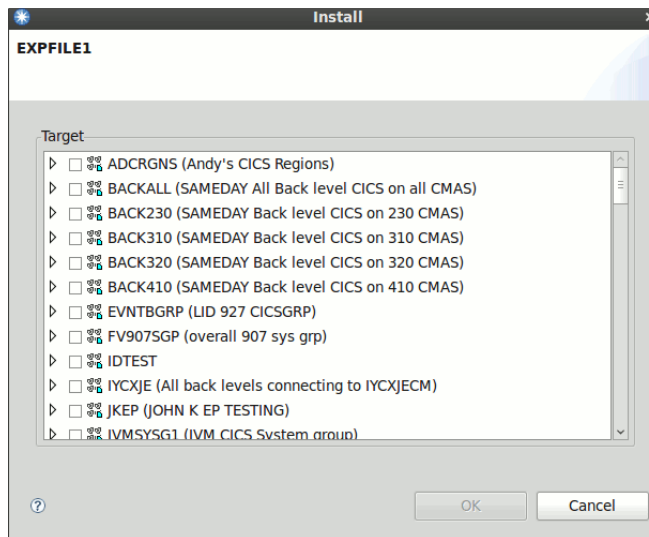

Figure 4-13 Install dialog

Select an install target, and click OK to install the definition into the selected target. Successful installation results in a confirmation message being written to the error log. If the install fails, an error message is displayed in the status bar and in the error log.

Editing CICS Resources

You can open CICS Resources in an editor by right-clicking and selecting **Open**; alternately, you can double-click the resource. If the connection that is used to retrieve the resource is a CMCI connection, the resource is made modifiable in the resulting editor. If the underlying connection is through the CICSplex SM Data Interface, the editor opens in a read-only mode.

4.4.1 Properties View

The Properties View, shown in Figure 4-14, displays a table of attributes for the last selected CICS Resource. The attributes are displayed by category. Changing the selection in any Resources View causes the Properties View to update itself to display the attributes for the newly selected resource.

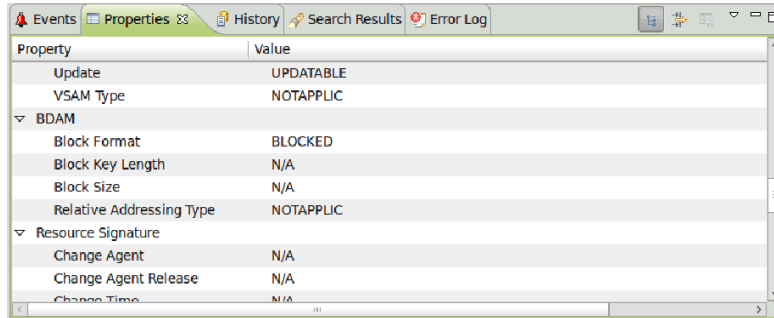

Property	Value
Update	UPDATABLE
VSAM Type	NOTAPPLIC
BDAM	
Block Format	BLOCKED
Block Key Length	N/A
Block Size	N/A
Relative Addressing Type	NOTAPPLIC
Resource Signature	
Change Agent	N/A
Change Agent Release	N/A
Change Time	N/A

Figure 4-14 Properties View

4.4.2 Status bar and error log

The status bar and the Error Log View communicate feedback to you about the success or failure of operations. The status bar is located at the bottom of the Explorer window, as shown in Figure 4-15.

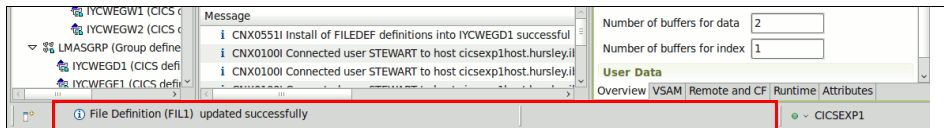

Figure 4-15 Status bar location

To open the Error Log View, click **Window** → **Show View** → **Error Log**, and information is displayed about the result of CICS operations and CICS Explorer state. Figure 4-16 on page 78 shows the Error Log View.

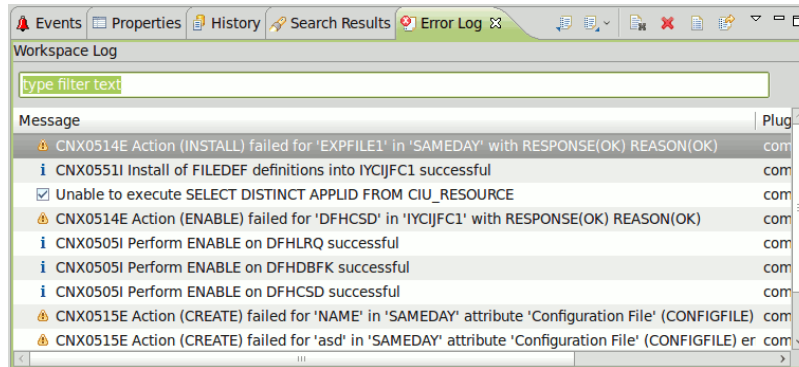

Figure 4-16 Error Log View

4.5 Editors

Using the CICS Object Editor you can make modifications to objects in CICS. You can open most CICS objects in an editor from the CICS Object view, by double-clicking or right-clicking and selecting **Open**.

When you open an editor for a CICS object, CICS Explorer attempts to retrieve the latest version of that object from the server before displaying it in an editor, which makes sure that no stale data is represented. If the latest version of an object cannot be retrieved (for example, a TASK object no longer exists since the Tasks view was last refreshed), CICS Explorer opens an editor on the cached data in read-only mode.

Figure 4-17 on page 79 shows the CICS Object Editor.

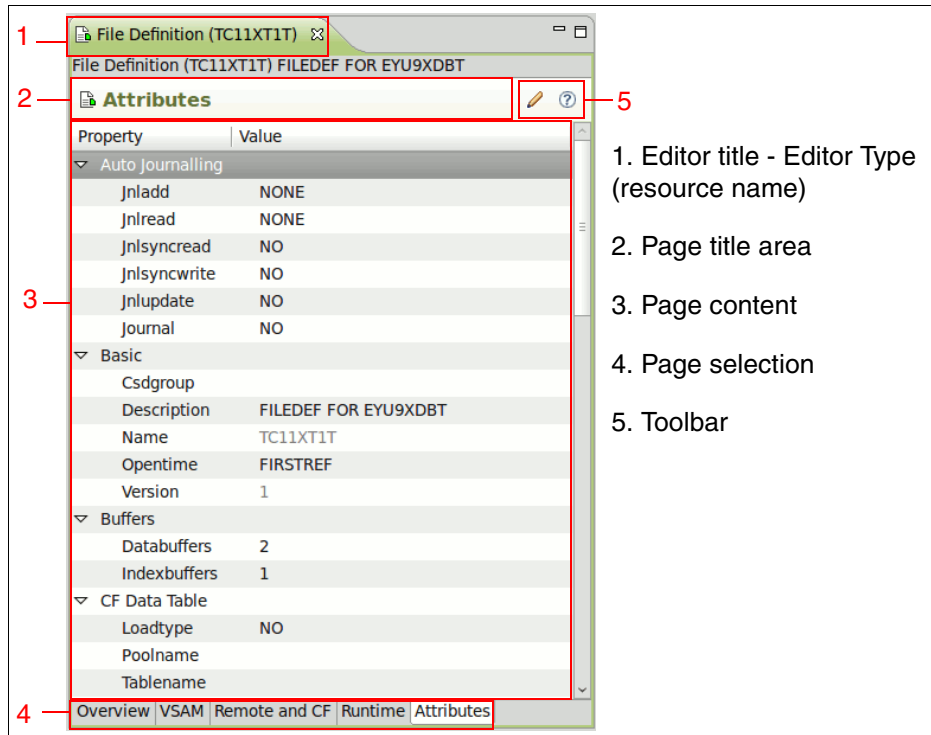

Figure 4-17 CICS Object Editor anatomy

The CICS Object Editor comprises one or more pages that provide different mechanisms for modifying the values of attributes on the target object. Changes are made to the state of the representation of the object in the Explorer. When you are happy with the changes, you can save the CICS object, which applies the changes to the object in CICS. The server sends feedback that pertains to the outcome of the attempted update: either the changes were applied successfully or there were problems performing the update. The CICS Object Editor reflects the outcome by displaying a message in the status bar and in the case of errors, where possible, updates the editor pages to indicate which attribute(s) caused the problem.

If an editor has local changes that were not yet saved to the server, the editor is said to be in dirty state. This state is indicated by an asterisk at the start of the editor title, as shown in Figure 4-18 on page 80. The save action for an editor is only enabled when it is in dirty state. When performing an update, the only attributes that the Explorer sends to CICS are those that were modified.

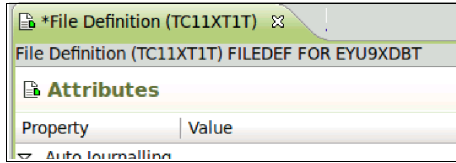

Figure 4-18 Editor in dirty state

All CICS objects can be manipulated using the attributes page.

Attributes page

The attributes page, shown in Figure 4-17 on page 79, displays a categorized list of attributes available on a CICS object, and their values, similar to the Properties View. The attributes page differs from the Properties View in that it provides an interface for manipulating the values. Attributes with the name in black can be modified, whereas attributes with the name in gray cannot. The attributes page contains a button on the toolbar, Figure 4-19, to toggle the display of non-editable attributes.



Figure 4-19 Toggle Show/Hide Non-mutable attributes icon

Click in the right column for a given attribute (or press **Enter** when the row has the focus) to modify the attribute's value. The editor used is appropriate for the type of attribute that is being modified: Attributes that represent CVDA/EYUDA values are edited using a combo box, and everything else is edited using a text box. Press **Enter** or otherwise force the focus out of the cell to apply the entered value.

Textbox cell editors use information about the underlying attribute to perform validation on any input without having to send the information to CICS. The net effect of this is that you are notified of simple validation errors as you type, on a key stroke-by-key stroke basis. The error is reflected by highlighting the cell with the editor in, and displaying an error feedback message in the page title area, as shown in Figure 4-20 on page 81. Attempting to apply the value for the text editor at this stage reverts the attribute back to its initial value.

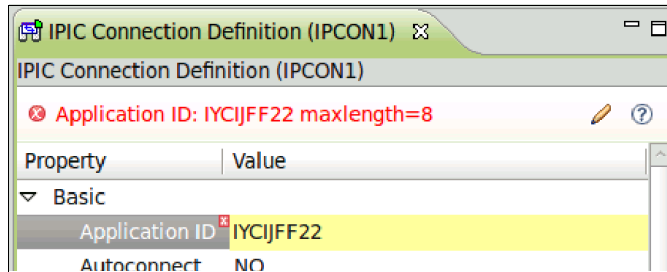

Figure 4-20 Attributes page validation feedback

Attributes that were modified since the last save are highlighted on the attributes page by setting the attribute name font to bold and prefixing it with a chevron, as shown in Figure 4-21.

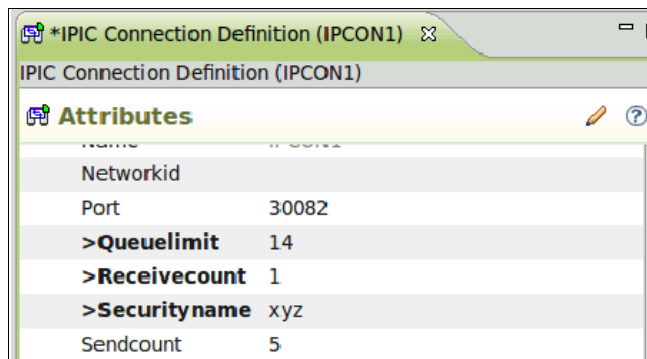

Figure 4-21 Modified attribute highlighting

The list of attributes on an attributes page is filtered. Attributes that are not supported by the CICS region that the object originated from (for example, they were introduced in a newer release) are removed from the list.

Rich editor pages

In addition to the attributes page, eight CICS objects have specific pages designed to allow interaction with the attributes on a higher level: DB2 Transaction Definition, Document Template Definition, File Definition, Pipeline Definition, Process Type Definition, Program Definition, TD Queue Definition, Transaction Definition.

Figure 4-22 on page 82 shows the File Definition Editor overview page.

File Definition (FIL1) ✕

File Definition (FIL1)

Overview ?

Basic

Name: FIL1 Description:

Version: 1 Created: Jul 17, 2009 2:45:19 PM
 Changed: Jul 17, 2009 2:45:19 PM

Initial Status

File remains closed until request is made to open it
 Following a cold or initial start of CICS the file status will be

Enabled Disabled Unenabled

Request exclusive use of the data set

Recovery

Images to be logged during the recovery phase

None
 Before (system log)
 Before (system log) and After to CICS Journal:

CICS Journal number

VSAM file eligible for backup while open for update

Buffers

Number of buffers for data

Number of buffers for index

User Data

1: 2: 3:

Overview **VSAM** Remote and CF Runtime Attributes

Figure 4-22 File Definition Editor overview page

The rich editor pages are designed to make it easier for you to understand the effect of manipulating specific CICS attributes, which is achieved by mechanisms, such as providing descriptions of what the attribute is used for, where appropriate, grouping logically connected attributes, and providing user interface that guides you away from setting conflicting values.

The same key stroke validation that is on the attributes page is present in text boxes on rich editor pages.

The rich editor validation behavior differs from the attributes page in that the attribute value is not reverted when the text box loses focus; instead, the erroneous state is maintained until you correct it. The ability to save changes to a CICS object is suppressed while there are outstanding errors on any rich editor page. Figure 4-23 shows rich editor validation feedback.

Click the error feedback message in the page title area to link back to the attribute that is responsible for the error. The link back reveals the appropriate page and gives the keyboard focus to the text box.

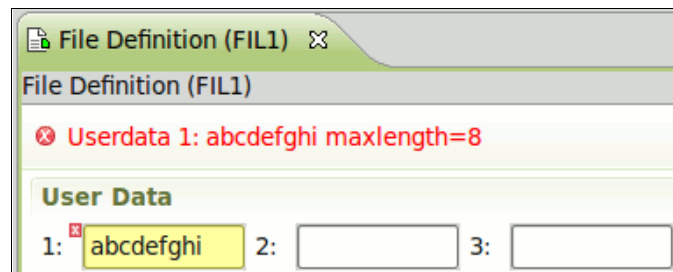

Figure 4-23 Rich editor validation feedback

Field level help

Both the attributes page and rich editor pages support showing help that is appropriate to the CICS attribute currently being edited. Press F1 on Windows or Ctrl + F1 on Linux to open the help that is associated with the current view within the Explorer. If you perform this key stroke within a CICS object editor when a specific attribute has the keyboard focus, the Explorer opens the help, if it is not already open, and displays help that is specific to that attribute.

Server error feedback

When save from within a CICS object editor, the Explorer tells CICS to update the attributes that were modified. This operation can either succeed or fail in a variety of ways. All results are communicated through the status bar; however, for some types of failure, the CICS object editor can display specific information about the failure.

The CICS Explorer performs basic validation on the values that are supplied for CICS attributes at a generic, low level, for example, the Explorer typically performs validation, such as string length or numeric range. For any attribute, CICS performs more specific validation, for instance the value might be required to be a valid HFS path or must adhere to some relationship with another attribute. Any of these types of validation failure result in an update failure after saving in the Explorer.

In cases like these, the CICS object editor highlights the attributes that are responsible for the failure in both rich editor pages and the attributes page and displays any error message in the page title area. Figure 4-24 shows the server error indication icon.



Figure 4-24 Server Error Indication icon

Figure 4-25 shows the rich editor page server error feedback.

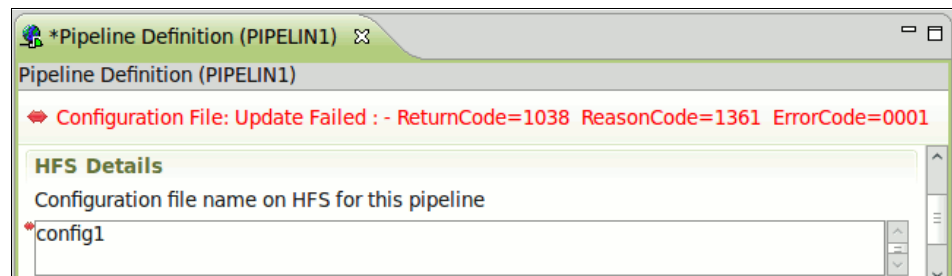

Figure 4-25 Rich Editor Page Server Error Feedback

Figure 4-26 shows the attributes page server error feedback.

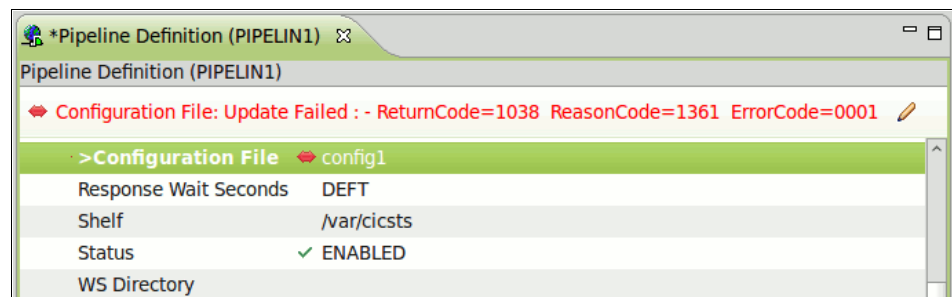

Figure 4-26 Attributes Page Server Error Feedback

In this case, the error is caused by the Configuration File attribute not being a valid HFS path.

Server errors do not suppress the save action, so the responsible attributes can be rectified, you can resave the object.

Update failures also result in a warning being appended to the error log with the full error returned from the server.

4.6 Creating new definitions

CICS Explorer provides a set of wizards for creating new resource definitions in CICS:

- ▶ To access the resource definition creation wizards select **Explorer** → **New Wizards**, and either select from the subset provided or select **Other** to display the New dialog.
- ▶ Wizards for creating resource definitions are in the CICS SM Administration group. To open a new definition wizard from a CICS resource view, for the type of CICS object being viewed, right-click anywhere on the table, and select **New**.

Figure 4-27 on page 86 shows the new definition wizard page.

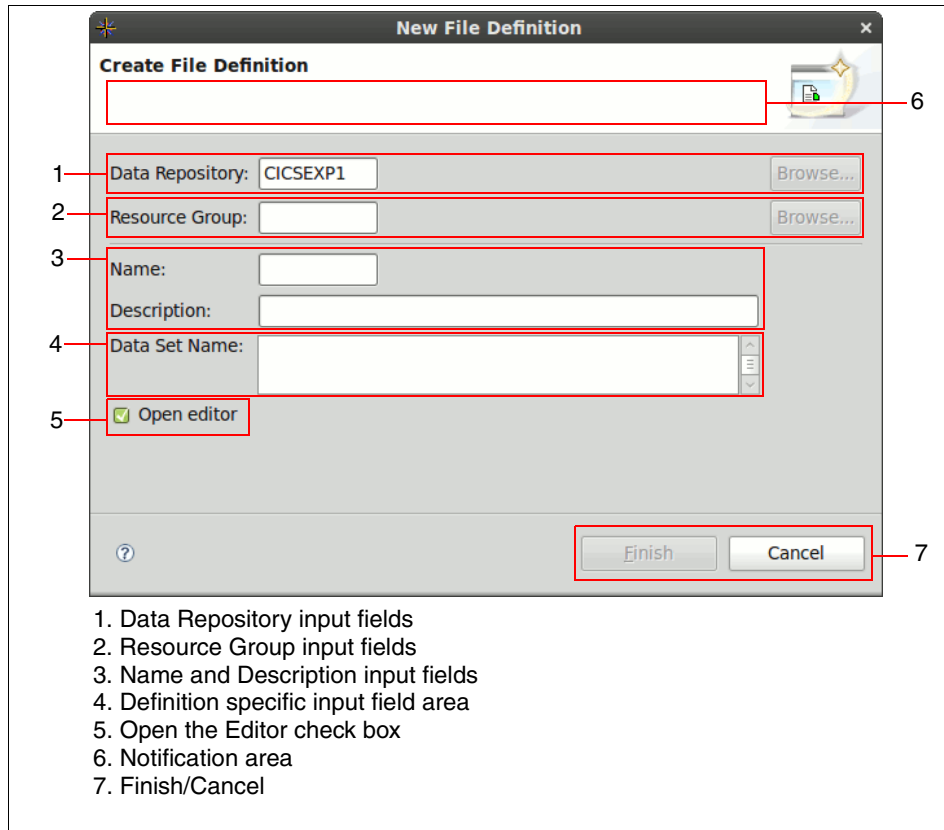

Figure 4-27 New definition wizard anatomy

The *Data Repository* is the location that the definition will be created in. This field is mandatory; however, if you start the wizard from the context menu in a resource definition view, it is populated with the context from that view. The value of the field must represent a valid repository and is validated by the Explorer against a list of valid repositories that are retrieved from the server. When the Data Repository field has the keyboard focus, press Ctrl + Space to activate content assist, which provides a list of all potential repositories for the definition.

In the Resource Group field, you can specify a group for the definition to be created in.

While all resource definitions require a name to be specified on creation, and optionally a description, many have additional attributes that are mandatory on creation. Controls representing these attributes are in the definition-specific input field area, such as the Data Set Name field, which we show on the file definition creation wizard in Figure 4-27.

Definition creation wizards have a similar validation mechanism to the CICS object editor. Fields that fail validation are highlighted with an Error icon, as shown in Figure 4-28, and a message that describes the failure is displayed in the notification area.

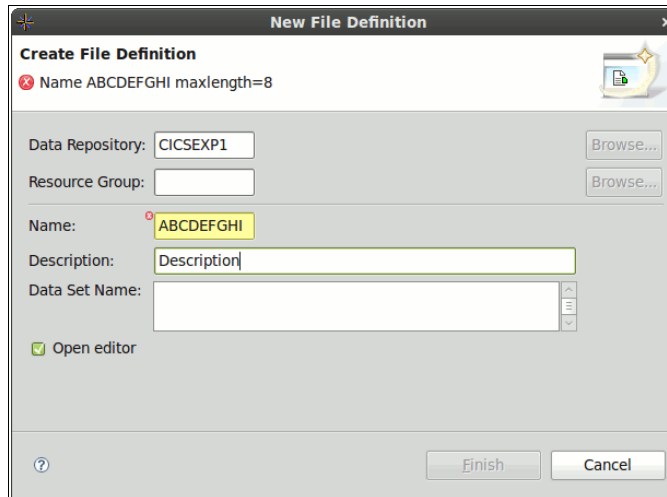

Figure 4-28 Validation in a definition creation wizard

When all mandatory field are completed, and no validation errors exist, the Finish button becomes enabled. Click **Finish** to create the definition in the specified repository. If the create fails, an error message that is associated with the failure is displayed. Where a specific attribute is responsible for the failure, CICS Explorer also highlights that attribute in the creation wizard, as shown in Figure 4-29 on page 88.

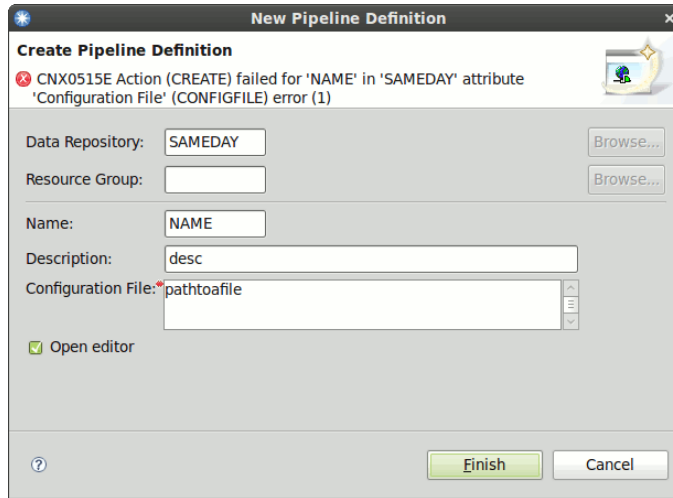

Figure 4-29 Creation server error

In Figure 4-29, the create failed because the Configuration File must be an absolute HFS path.

Select the **Open Editor** option to tell the Explorer to open a successfully created definition in a CICS object editor



CICS Explorer IA plug-in familiarization

The CICS Explorer IA plug-in provides a graphical user interface (GUI) to CICS IA that runs toolbar searches on common resources and helps you to build detailed queries to interrogate the Dependency and Affinity database objects. The CICS IA plug-in also provides a number of sample queries.

5.1 CICS IA introduction

IBM CICS Interdependency Analyzer for z/OS V2.2 identifies resource interdependencies in your CICS systems, automates detection of your CICS runtime relationships, records data in a DB2 database, and helps you analyze the collected information for use in your daily processes.

Some benefits of CICS IA are:

- ▶ The resources that are identified by this runtime tool are those that are associated with transactions, programs, Basic Mapping Support maps, files, temporary storage queues, transient data (TD) queues, 3270 Bridge facility, Web Services, CorbaServer and Enterprise JavaBeans (EJBs).
- ▶ Reports on DB2, IMS™ and WebSphere MQ resources that are used by CICS are also generated.
- ▶ A CICS IA plug-in is now available for the CICS Explorer to offer the same intuitive way to query CICS relationship data, manage queries and navigate through complex application relationships, now from a standard interface.
- ▶ The CICS IA plug-in integrates with other CICS Explorer perspectives, for example, to click a transaction in a CICS PA bar chart and drill right-down to see its dependencies, relationships, and affinities, and more.
- ▶ Sample queries assist you by highlighting those applications that are currently running in previous levels of CICS TS that are most sensitive to CICS API and SPI command changes.
- ▶ V2.2 includes support for modernizing your key CICS applications for deployment in a service-oriented architecture (SOA) by identifying applications that are suitable for exposure as Web services, and it provides initial integration with WebSphere Studio Asset Analyzer.
- ▶ Support for CICS resources used by Software AG Natural gives you new insight into the behavior of your Natural applications.

5.2 What can CICS IA do for you?

There are many business reasons for using CICS IA, and they vary by industry. Here are some of the business imperatives facing corporations today.

- ▶ Mergers and acquisitions

Many banks have been involved in mergers and acquisitions. The result is that they had to consolidate workloads and move CICS applications around, for isolation reasons or to spread the workload for performance reasons. Because these applications might not be well understood by the acquiring bank and documentation might be inadequate, there is a need to understand all of the resources that are associated with a given application.

- ▶ Outsourcing

Large outsourcing companies are continually facing the problem of running CICS applications with which they are unfamiliar. Often naming standards are lacking or conflict with other applications that are running on the same LPAR. Documentation might be nonexistent or incomplete. Again, there is a need for a tool to facilitate the understanding of the resource interdependencies and affinities that are involved.

- ▶ Maintenance or enhancement of applications

During the normal application life cycle, CICS applications require maintenance and enhancement. When a programmer who is unfamiliar with the application that they are required to modify starts the modification process, much time can be spent trying to understand the application and the inherent flow of transactions. This learning curve can be greatly reduced using CICS IA, which identifies the resources that are affected directly and indirectly.

5.2.1 CICS IA highlights

Using CICS IA you can:

- ▶ Automate detection of runtime resource relationships
- ▶ Understand application flow with flexible resource-relationship reports
- ▶ Accumulate resource-relationship data in a DB2 database
- ▶ Build relationship maps to help improve the speed of application maintenance and to help reduce the time to resolve problems
- ▶ Compare applications and resources across regions
- ▶ Migrate, reuse, and extend CICS applications more quickly
- ▶ Support SOA implementations with deep application understanding

- ▶ Make informed decisions about the best way to split workloads
- ▶ Minimize the impact of routine application maintenance for the user

5.2.2 What questions does CICS IA answer?

These are some of the questions that can be answered with CICS IA, and we offer them to give you a sense of what is possible with CICS IA:

- ▶ What region(s) does a particular CICS application run in?
- ▶ What are all of the CICS resources used by a given application?
- ▶ What are all of the CICS resources used by a given transaction?
- ▶ What transactions belong to a given application?
- ▶ What programs does a given transaction invoke?
- ▶ What transactions access a particular file and how?
- ▶ What resources are used by a specific program?
- ▶ How is a file accessed by a particular program?
- ▶ Which affinities does a transaction have?
- ▶ How would you query on DB2, MQ, or IMS resource use?

5.3 What is CICS IA?

IBM CICS Interdependency Analyzer for z/OS is the IBM discovery tool for CICS Transaction Server for z/OS, offering a wide range of new capabilities and supporting completely new functions in CICS Transaction Server, Version 3.2. New capabilities, such as threadsafe and affinity analysis, a new user interface, and support for Software AG Natural, make it possible to achieve better reuse, management, and control of your applications through improved understanding of an even wider range of CICS systems and resources. CICS Interdependency Analyzer facilitates projects, such as CICS version-to-version migration, affinity removal, and Web service refactoring that depend on deep knowledge of application, system, and resource relationships for their success.

CICS IA is a runtime and batch system for use with CICS Transaction Server for z/OS and CICS Transaction Server for OS/390®. It has two purposes:

- ▶ To identify CICS application resources and their interdependencies.

This function enables you to understand the makeup of your application set, such as:

- Which transactions use which programs
- Which programs use which resources (files, maps, queues)
- Which resources are no longer used
- What applications does a CICS region contain

CICS IA captures interdependency information while CICS is running and stores it in VSAM files. Detailed reports can be produced from the VSAM files, if desired. Subsequently, the VSAM files are used to load the DB2 database.

- ▶ To analyze transaction affinities

Affinities require particular groups of transactions to be run either in the *same* CICS region or in a *particular* region.

Affinities information is useful in a dynamic routing environment, since you must know of any restrictions that *prevent* particular transactions from being routed to particular application-owning regions (AORs) or that *require* particular transactions to be routed to particular AORs.

CICS IA captures and loads the Affinity data into its DB2 databases. The data can then be queried with the CICS IA plug-in, the CICS IA online transaction CINQ, with batch SQL queries, or with other SQL query software tools.

Through the use of batch SQL processing, detailed reports can be produced.

Many large organizations have used CICS since the early 1970s, their systems growing and evolving with the business. During this time, many techniques of implementing applications have been used — as a result of new function, changing corporate standards, technical requirements, and business pressures.

Frequently, this growth was not as structured as it might have been, with the result that many applications and services share common resources, and changes in one area typically affect many others. This issue can reach such a level that the system can no longer develop in a controlled manner without a full understanding of these interrelationships. CICS IA can help you achieve this understanding, for example, if you need to change the content or structure of a file, you must know which programs use this file because they must be changed too. CICS IA can tell you this and the transactions that drive the programs. CICS IA records the interdependencies between resources (such as files, programs, and transactions) by monitoring programming commands that operate on resources.

The application that issues such a command has a dependency on the resource that is named in the command, for example, if an application program issues the command EXEC CICS WRITE FILE(*myfile*), it has a dependency on the file called *myfile*. It might have similar dependencies on transient data queues, temporary storage queues, transactions, other programs, and so on.

The commands that are monitored are typically CICS application programming interface (API) and system programming interface (SPI) commands that operate on CICS resources; however, you can also instruct CICS IA to monitor some types of non-CICS command that operate on non-CICS resources; for example:

- ▶ MQ calls to WebSphere MQ resources

- ▶ EXEC DLI calls to IMS database resources
- ▶ DB2 calls
- ▶ Dynamic COBOL calls to other programs

Potentially, the inclusion of any non-CICS resources gives you a fuller picture of the resources that a transaction uses.

The Collector component of CICS IA collects the dependencies that apply to a single CICS region, that is, a single application-owning region (AOR) or a single, combined routing region-AOR. It can be run against production CICS regions and is also useful in a test environment to monitor possible dependencies that new or changed application suites or packages introduce.

From the interactive interface of CICS IA you can control Collectors running on multiple regions.

CICS IA with your entire workload: To ensure that you monitor as many potential dependencies as possible, use CICS IA with all parts of your workload, including rarely-used transactions and abnormal situations. CICS IA collects these dependencies into a database. You can store the dependency information from several CICS regions into the same database. You can review the collected dependencies using the CICS IA Query interface, or list them using the Reporter.

5.4 CICS IA plug-in overview

Figure 5-1 shows all of the views that are available in the new CICS IA plug-in.

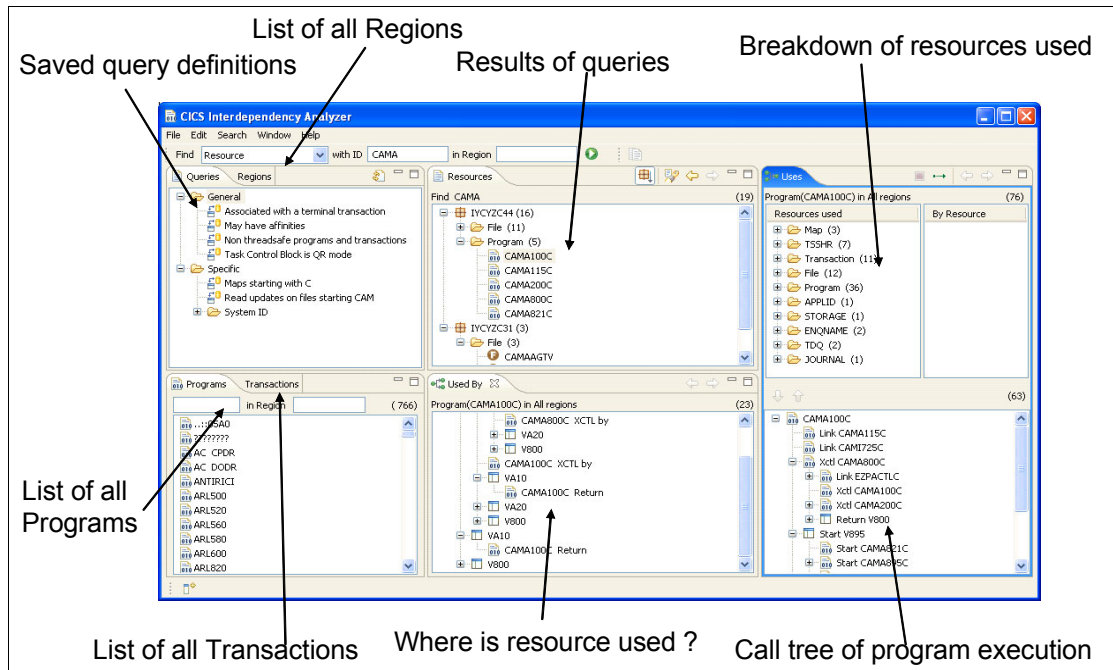

Figure 5-1 Views of CICS IA plug-in

5.5 Toolbar searches and queries

The CICS IA plug-in has two methods of interrogating data that the CICS IA Collector collects: toolbar searches and queries.

5.5.1 Toolbar searches

The CICS IA plug-in has four toolbars that you can use to search for common resources, programs, transactions, and regions, which you can see in Figure 5-2. Toolbar searching is a quick way of interrogating a limited amount of data because the resources that you can interrogate are fixed by the menu options.

You can search by name and region only, or you can use the Regions toolbar to search by regions only; however you can restrict or expand the search criteria by using the wildcard. The structure of the results that are displayed in the Resources window is also fixed. The description of the toolbar search that you run is shown above the results in the Resources window. You cannot save the results of a toolbar search. Figure 5-2 shows the toolbar search.

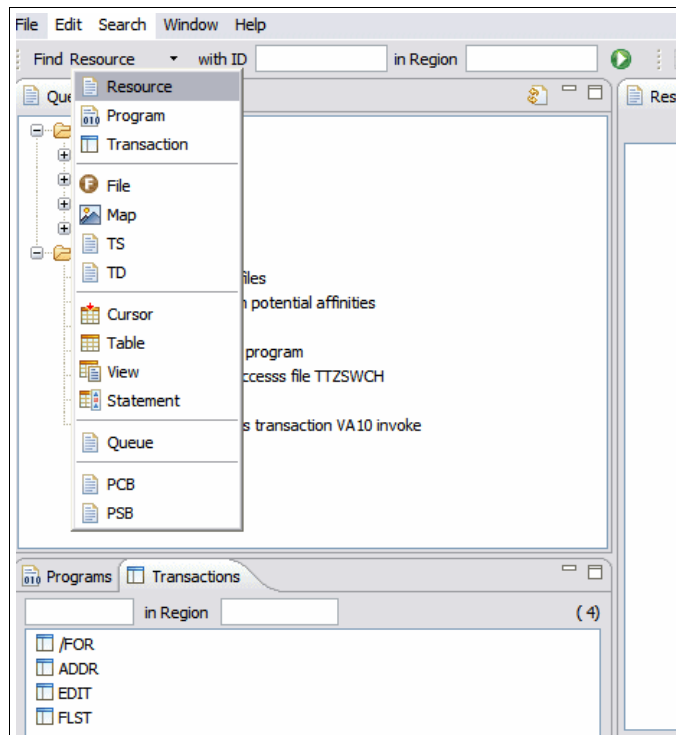

Figure 5-2 Toolbar search

5.5.2 Queries

The CICS IA plug-in provides you with a number of defined queries, which you can edit and helps you to build detailed queries of your own. When you create a query, you can define the structure of the results that are displayed in the Resources window. The structure is not fixed. You can query any resources in any combination. You can also add filters to the query to further refine the results. The description of the query that you run is shown above the results in the Resources window. You can save queries that you edit or create.

When you run a query, you can save the search results in a list under the query name in the Queries window for future reference. You can copy the definition of a query to the clipboard and paste it into the same folder, or a different folder, in the Query window. If you want to run your own SQL, you can paste the query definition into a text editor to view the raw SQL strings that run against the DB2 tables. Figure 5-3 shows the CICS IA plug-in main window.

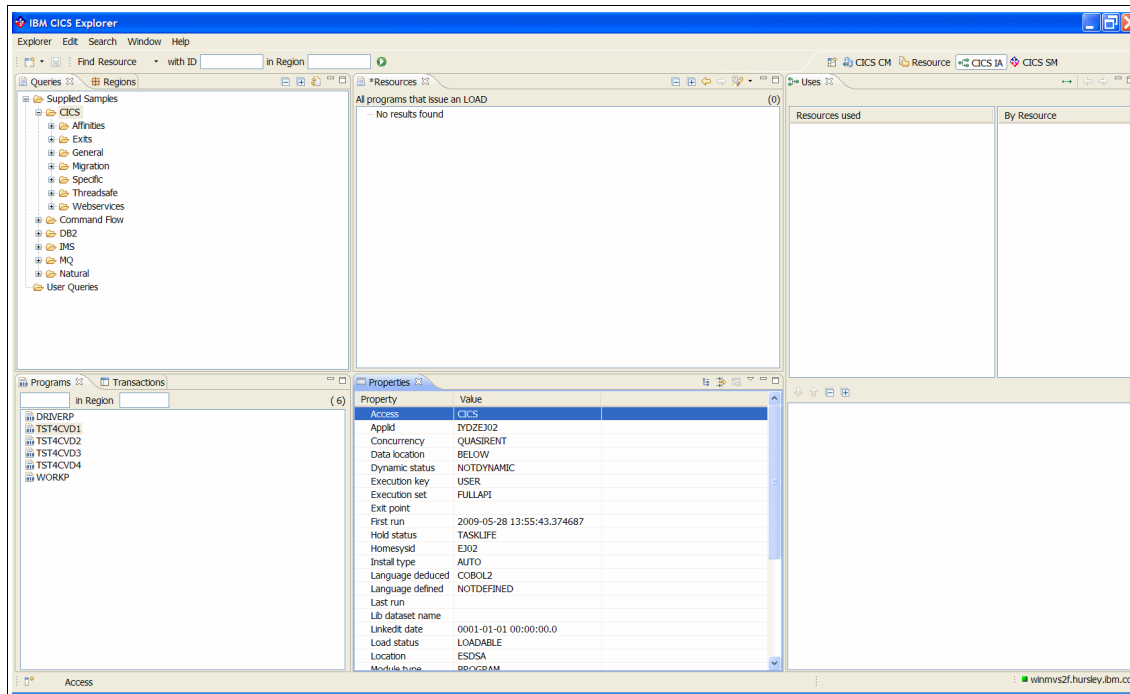

Figure 5-3 Main CICS IA plug-in menu

The Explorer has an implicit wildcard (*) that is added to the end of all search values. The wildcard is not visible, for example, when you search using the toolbar or define queries; instead, if you type FIN as a value, it is read as "FIN*".

The wildcard is denoted by the *. In this way, the search is for all resources that begin with “FIN”.

If you require an explicit wildcard, you can add it anywhere in the search definition; however, the implicit wildcard at the end of the search value remains, for example:

- ▶ To search for resources that begin with “FIN” and include 01, enter FIN*01.
- ▶ To search for resources that contain “01”, enter *01.
- ▶ To narrow your search as much as you want, you can use as many wildcards as required, for example, A*0*3* is also acceptable.

The implicit wildcard is nearly always added to the end of the search value, for example, searching for PROG*AF can return:

- ▶ PROGAAAF
- ▶ PROGAafa
- ▶ PROGafAA

Note: A wild card is not always added. If it is a transaction, and we enter FINA, we do not add an *.

Use the toolbar at the top of the CICS IA plug-in to search for common resources. You can search by name and region only. You can restrict or expand the search using the wildcard.

To run a toolbar search for common resources:

1. Use the menu in the Find field to select a resource to search.
2. Use the ID field to limit the search to a particular ID, or you can leave the field blank.
3. Use the Region field to limit the search to a particular region or regions.
4. To run the search, click **Search** → **Run**, or click the green toolbar button, or press **Enter**. The result of the search is shown in the Resources window.

5.6 Programs and Transactions windows

When you first open the CICS IA plug-in and connect to the database the information in the Programs window and Transactions window is retrieved from the data that is extracted to the database by the CICS IA Collector. The information is displayed in an alphabetic list and is static.

You can use the toolbar search, which is located at the top of the Queries and Regions window, to explore the programs and transactions. Figure 5-4 shows an example of the Programs and Transactions window.

The information in the Programs window is a list of all of the programs that are known to CICS IA, which are:

- ▶ Programs that are the sources of interactions
- ▶ Programs that are the results of interactions
- ▶ Programs that are CICS resource types

The information in the Transactions window is a list of all of the transactions that are known to IA, which are:

- ▶ Transactions in which programs are running
- ▶ Transactions that are the results of interactions
- ▶ Transactions that are CICS resources of TRANSID type

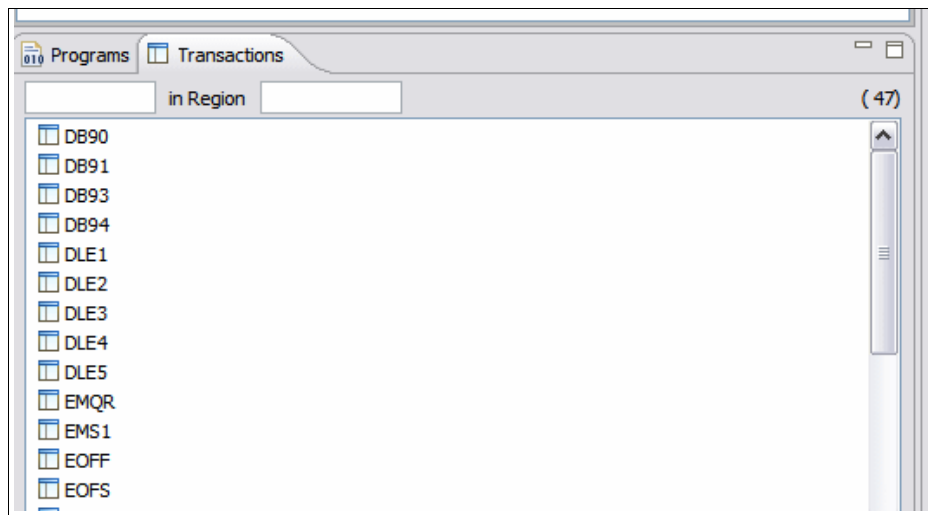

Figure 5-4 Programs and Transactions window

5.6.1 Searching programs and transactions

You can search the programs that are listed in the Programs window. The data is stored in the database by the CICS IA Collector and is retrieved when you first open the CICS IA plug-in and connect to the database.

To search the programs list for particular programs that you want to analyze further:

1. Click the **Programs** tab to bring the Programs window to the front.

2. To filter the search, in the left field, enter the name of the search criteria, and in the Region field, enter the region search criteria. An implicit wildcard is appended to the end of the search criteria, and you can add wildcards at the beginning and in the middle. You can search by name only, region only, or name and region.
3. Press **Enter**, or click **Search** → **Run** to run the search. The results are displayed in the Programs window.

Transactions: This is the same process for transactions except that you search transactions in the Transactions window.

5.7 Regions window

When you run a toolbar search or a query, the Regions window displays all of the regions for which the CICS IA Collector stored data in the database. The results are displayed in an alphabetic list. You have only one search field, which is for the region name. Figure 5-5 on page 101 shows an example of this window.

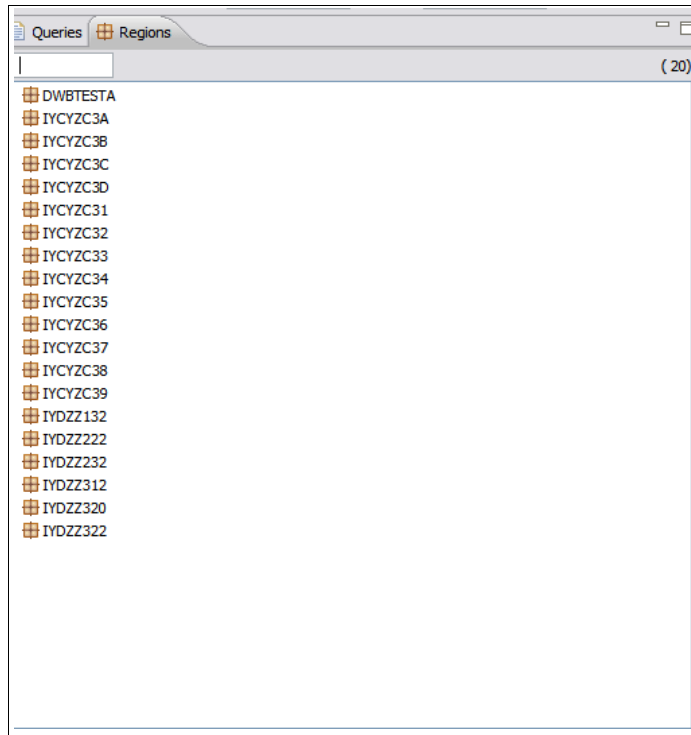

Figure 5-5 Regions window

You can search the regions list for particular transactions that you want to analyze further. To search in the Regions window:

1. Click the **Regions** tab to bring the Regions window to the front.
2. To filter the search, in the search field, enter the region name search criteria. An implicit wildcard is appended to the end of the search criteria, and you can add wildcards at the beginning and in the middle.
3. Press **Enter** or click **Search** → **Run** to run the search. The results are displayed in the Transactions window.
4. Right-click the name of the region you want to analyze.
5. From the menu, select the resource that you want to search.

5.8 Properties window

The Properties window gives you more details about programs, transactions, files, TD queues, TS queues, and exits, as shown in Figure 5-6 and Figure 5-7 on page 103.

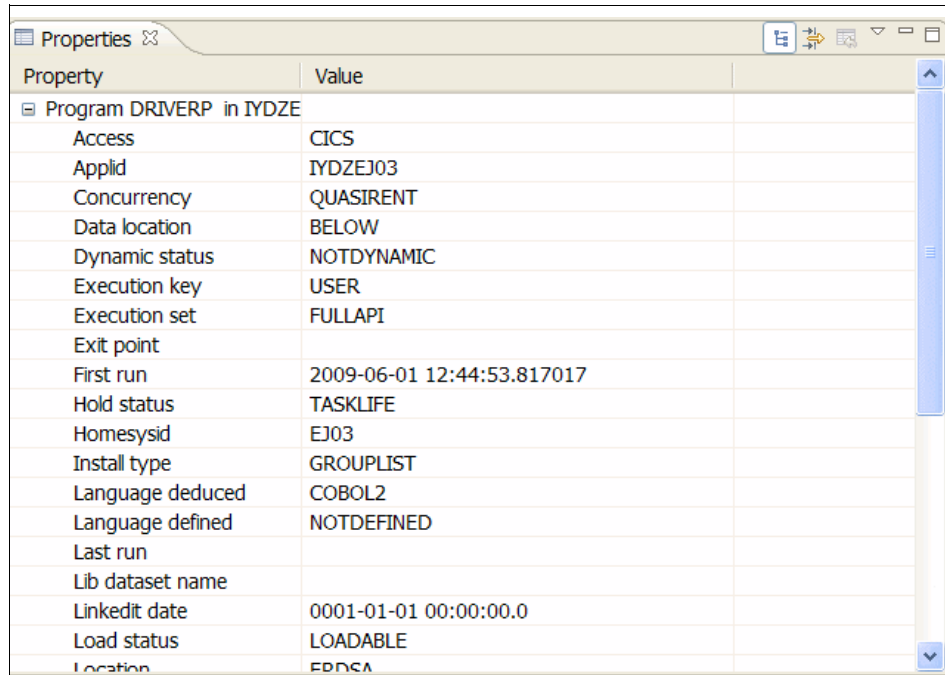

The screenshot shows a window titled 'Properties' with a close button. It contains a table with two columns: 'Property' and 'Value'. The table lists various attributes for the program 'DRIVERP' in the transaction 'IYDZE'. The properties include Access (CICS), Applid (IYDZEJ03), Concurrency (QUASIRENT), Data location (BELOW), Dynamic status (NOTDYNAMIC), Execution key (USER), Execution set (FULLAPI), Exit point, First run (2009-06-01 12:44:53.817017), Hold status (TASKLIFE), Homesysid (EJ03), Install type (GROUPLIST), Language deduced (COBOL2), Language defined (NOTDEFINED), Last run, Lib dataset name, Linkedit date (0001-01-01 00:00:00.0), Load status (LOADABLE), and Location (EPDCA).

Property	Value
Program DRIVERP in IYDZE	
Access	CICS
Applid	IYDZEJ03
Concurrency	QUASIRENT
Data location	BELOW
Dynamic status	NOTDYNAMIC
Execution key	USER
Execution set	FULLAPI
Exit point	
First run	2009-06-01 12:44:53.817017
Hold status	TASKLIFE
Homesysid	EJ03
Install type	GROUPLIST
Language deduced	COBOL2
Language defined	NOTDEFINED
Last run	
Lib dataset name	
Linkedit date	0001-01-01 00:00:00.0
Load status	LOADABLE
Location	EPDCA

Figure 5-6 Properties window

Property	Value
Transaction DE20 in IYDZEJ02	
Applid	IYDZEJ02
Brexit	
Cmdsec	N
Dtimeout	0
Dump	Y
Dynamic	N
First run	2009-06-02 14:33:25.816435
Homesysid	EJ02
Indoubt	BACKOUT
Indoubt wait	Y
Indoubt wait time	0
Initial program	DSWDE2VW
Isolate	Y
Last run	2009-06-02 14:56:13.852661
Local queuing	N
Otimeout	0
Partitionset	NONE
Partitionset name	
Primary transid	DE20

Figure 5-7 Properties window part 2

5.9 Supplied queries with CICS IA plug-in

There are a number of predefined queries that are supplied with the CICS IA plug-in for each resource. You can edit the queries to suit your requirements. Figure 5-8 on page 104 and Figure 5-9 on page 105 show examples of the window that you see with the queries all expanded.

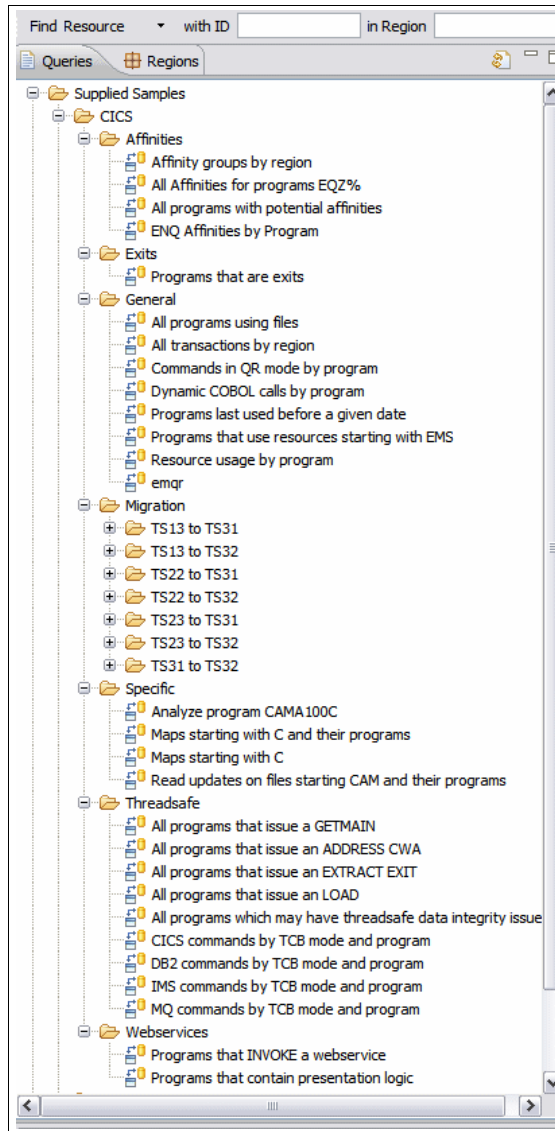

Figure 5-8 CICS supplied queries

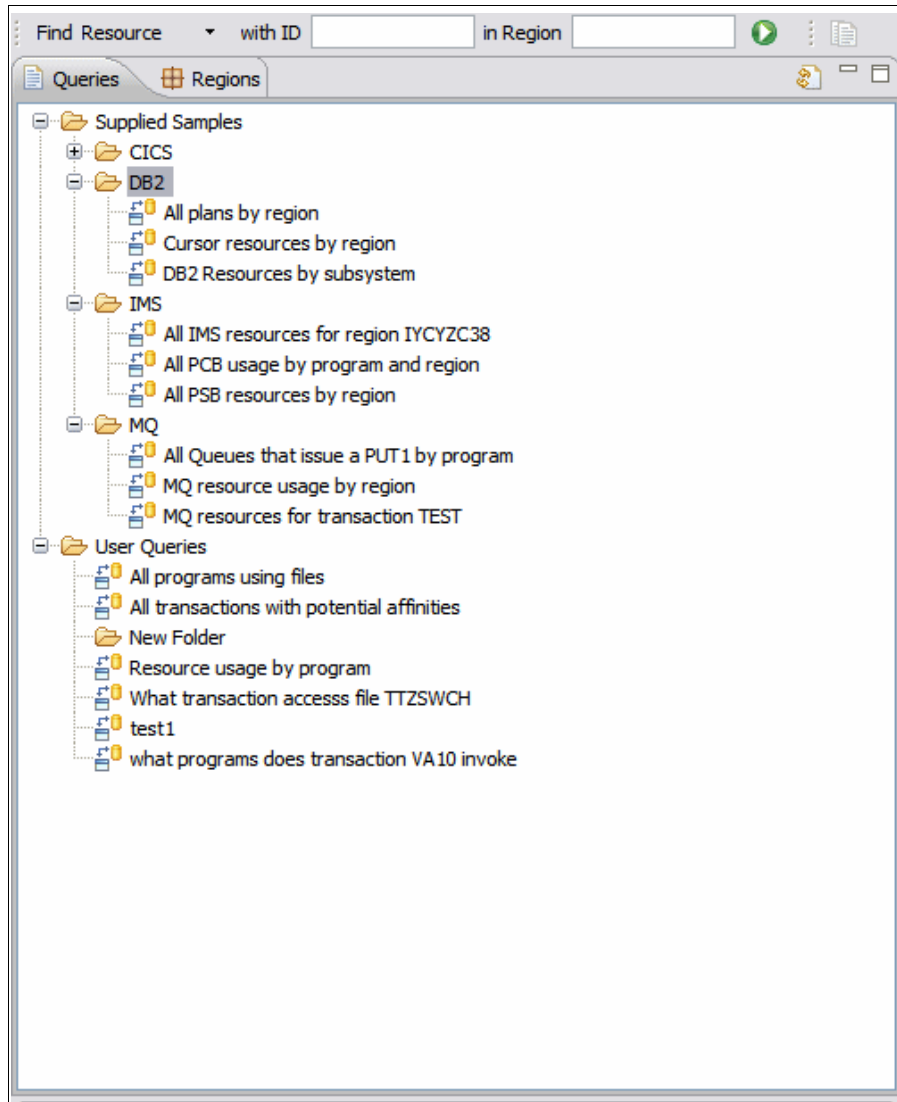

Figure 5-9 DB2 IMS and MQ supplied queries

To run a predefined query in the Queries window:

1. In the Queries window, select the resource that you want to query, as shown in Figure 5-10 on page 106.
2. To view the query names, click the plus sign to expand the list of queries, as shown in Figure 5-11 on page 107.

3. To run the query, right-click the query name, and click **Run**, or click the query you want to run, and click **Search** → **Run**. The results are displayed in the Resources window. You can save the results for future reference and further analyze the results. Figure 5-12 on page 108 is an example of you clicking **Run**, and Figure 5-13 on page 109 shows the results.

Next, we show a step-by-step example of running the supplied query: all transactions by region. Figure 5-10 shows the selected CICS queries.

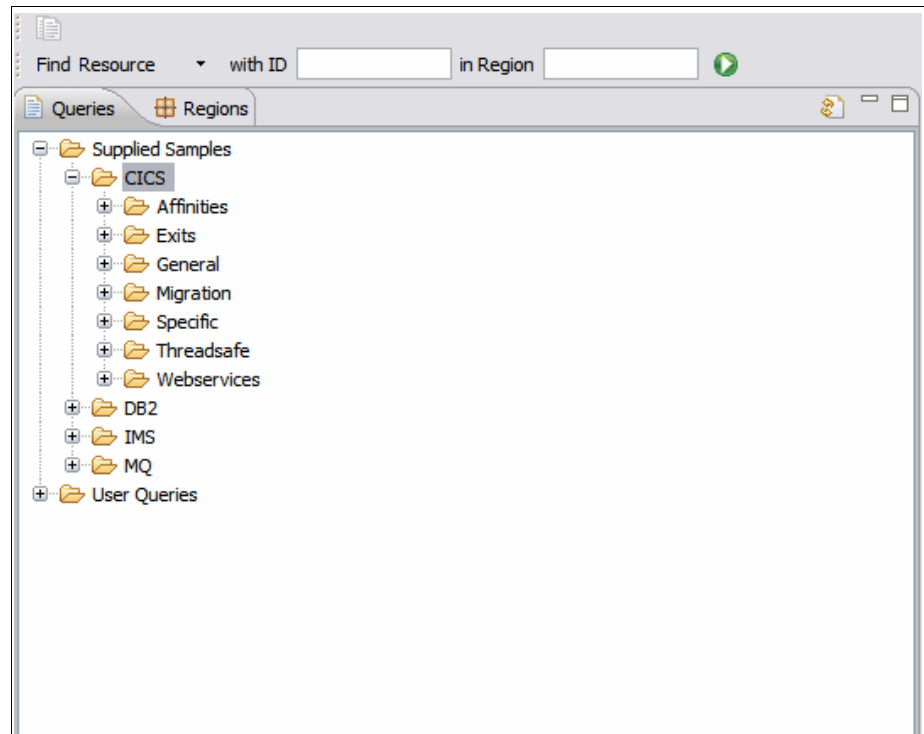

Figure 5-10 CICS query selected

Next, we look at general queries underneath the CICS heading. Figure 5-11 on page 107 shows the general queries expanded.

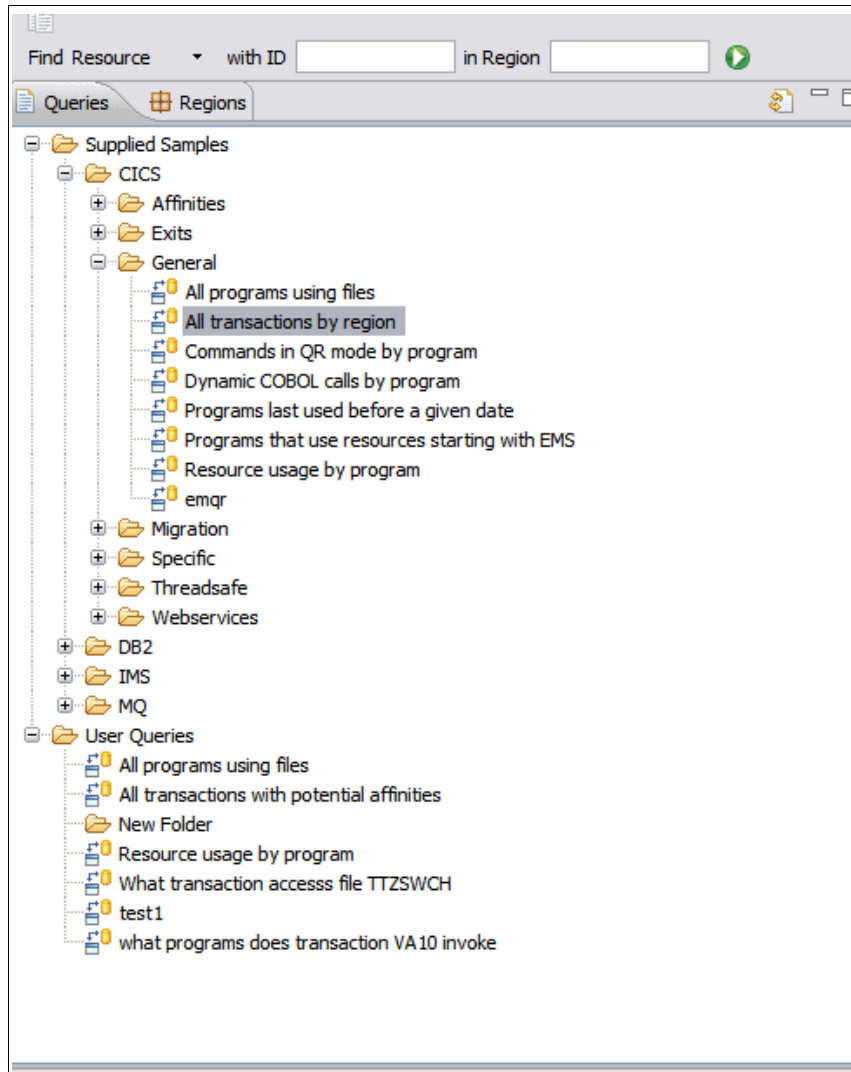

Figure 5-11 General queries expanded

Click **Run** to execute the query, as shown in Figure 5-12 on page 108.

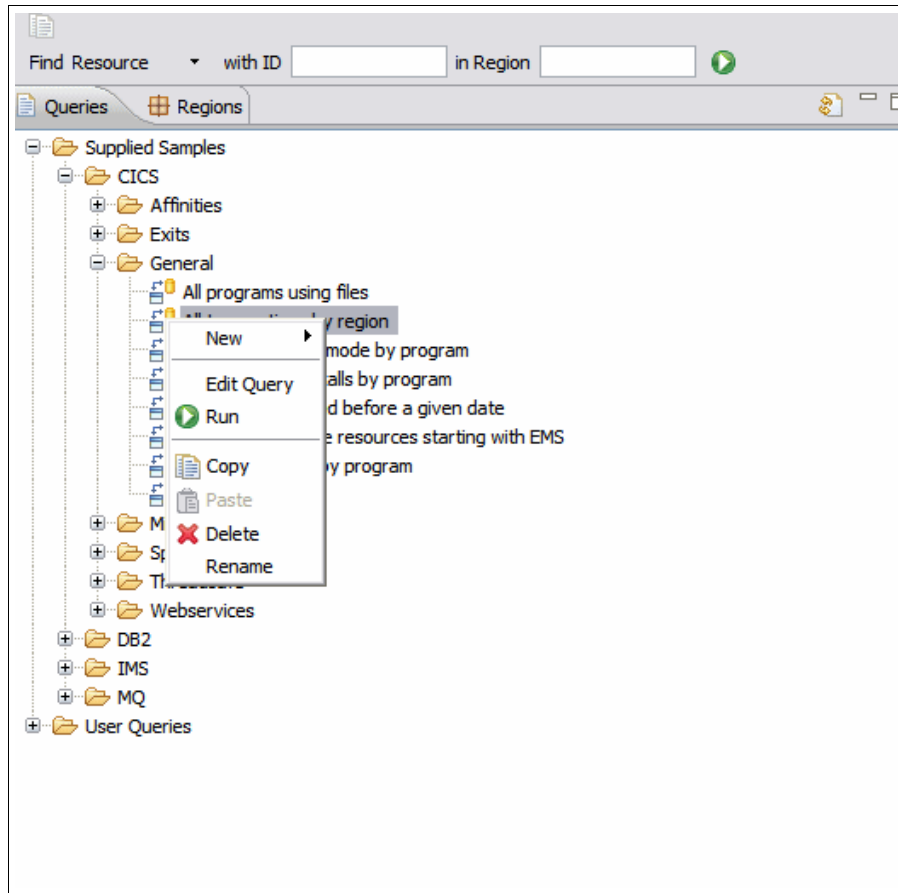

Figure 5-12 click run to execute

Figure 5-13 on page 109 shows results of the all transactions by region query.

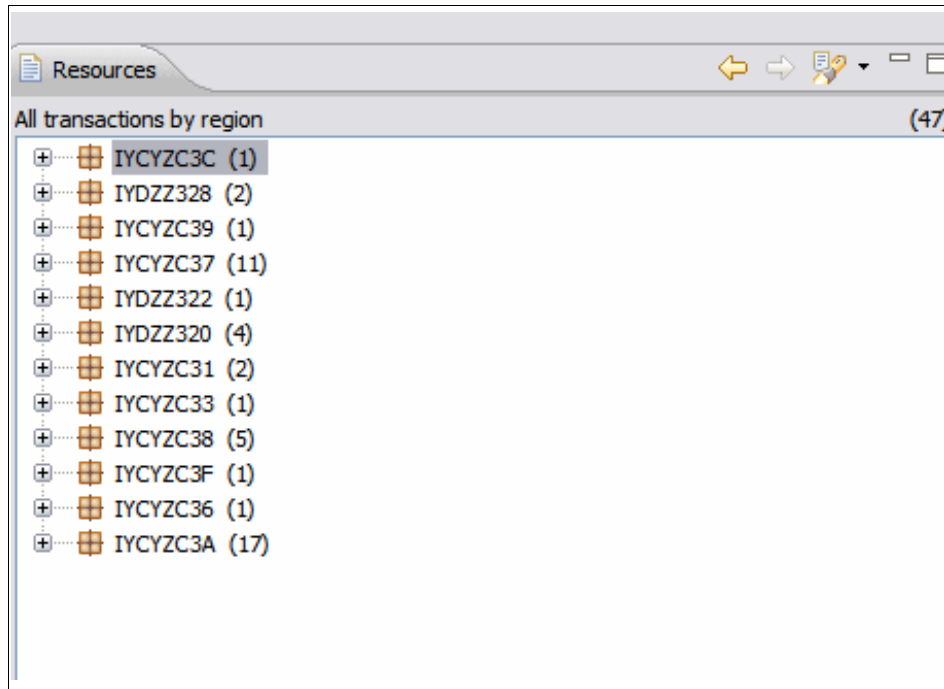

Figure 5-13 All transactions by region results

5.10 Creating your own queries in the CICS IA plug-in

To create a query:

1. Click **Explorer** → **New**, or right-click in the Queries window, and select **New**, as shown in Figure 5-14 on page 110. If you want to save the query, right-click the folder name under which you want the query to be listed.

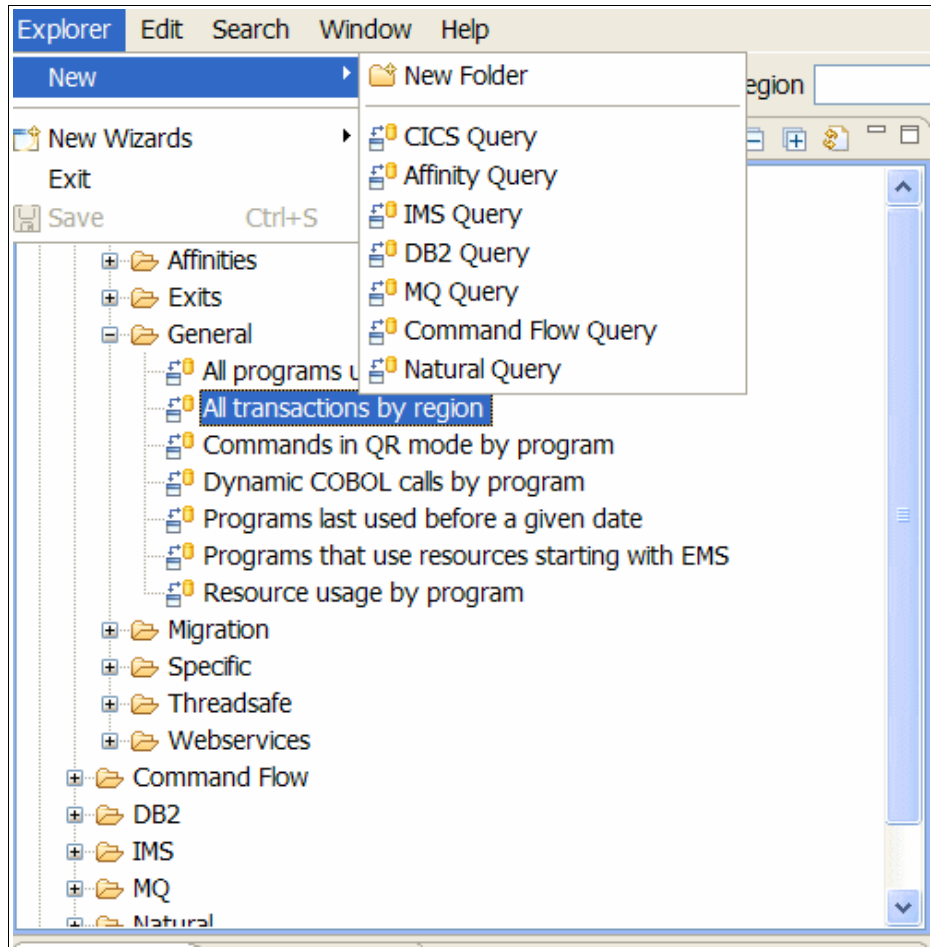

Figure 5-14 Create new query

2. From the menu, select the resource type that you want to query. We selected CICS, as shown in Figure 5-15 on page 111.

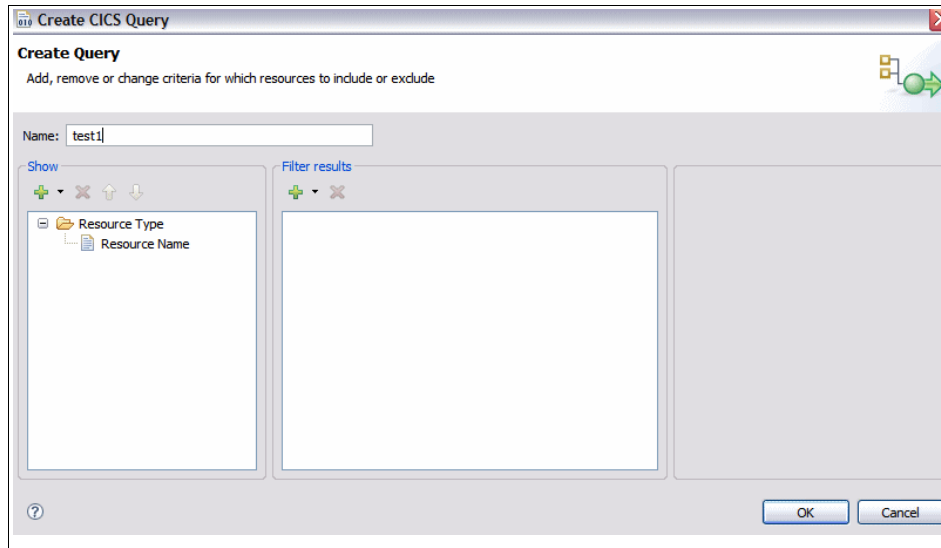

Figure 5-15 Create CICS query

3. In the Create Query window, go to the Name field, and enter a query name. We called ours test1.
4. In the Show panel, click the green plus sign button to select the resource or resources that you want to query, as shown in Figure 5-16 on page 112.

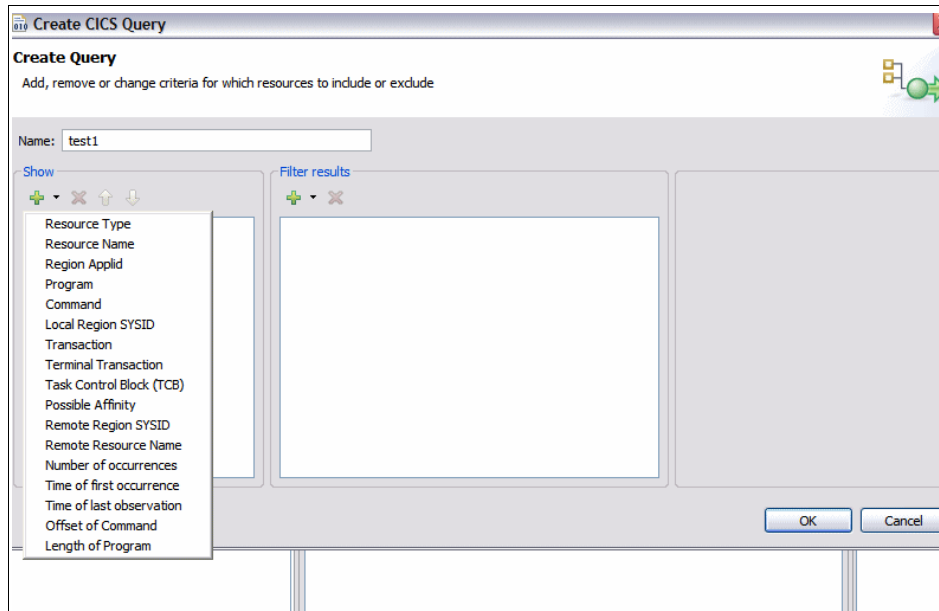

Figure 5-16 Query resource selection

5. Click the red **X** button to remove resources.
6. Click the yellow arrows to move the selected resources up and down the tree so that the query results are presented in the required order. The resources tree that is created from your selections is in the format in which the results are displayed in the Resources View when you run the query.

5.10.1 Adding filters to the query

When you create a query, you can further refine your query by editing the right pane in the Create Query window. When you select an expression, the right pane changes allow you to further define your query:

1. Select **is** or **is not** for the values in the query. If the expression that you selected has a known set of values, for example, Resource Type, the values are listed. These properties are added to the left pane so that you can view the query string for each line easily. If you need both is and is not values to be included in the query for the same resource, you require two lines for the same resource because you cannot combine is and is not values.
2. Define the expressions you selected by arbitrary values, for example, Resource Name. Use the editable table to define the values. These properties are added to the left pane so that you can easily view the query string for

each line. An implicit wildcard is appended to the end of the value, and you can add wildcards at the beginning and in the middle.

To our test1 query, we selected resources as being transactions. We then further filtered this down to being a particular transaction. So for the filter, we select **Transaction**. We then select **transaction is EMS1**, as shown in Figure 5-17.

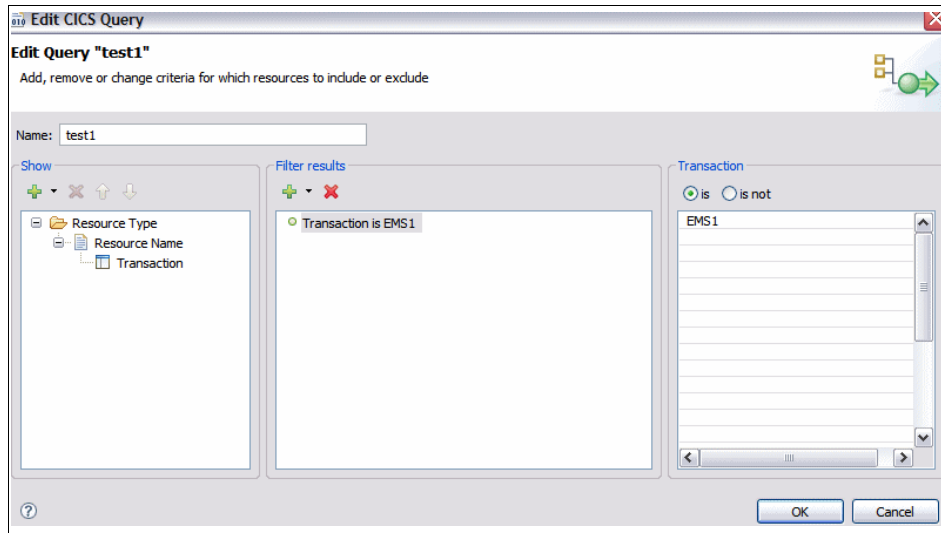

Figure 5-17 Filter query

When we run this query, we get the results shown in Figure 5-18 on page 114.

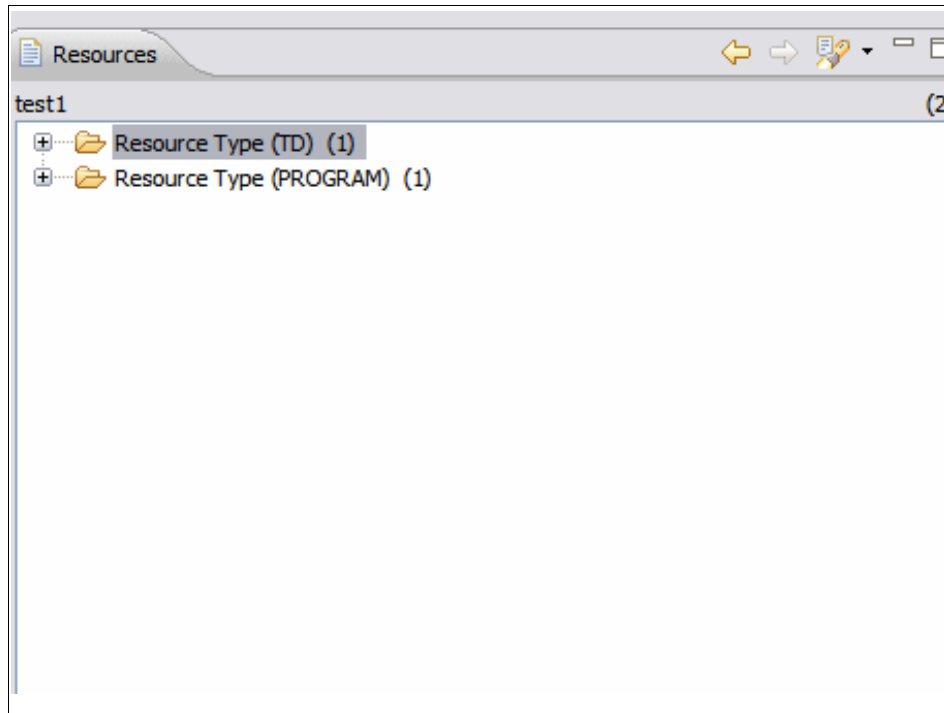

Figure 5-18 Results of test1

5.10.2 Modifying an existing query

You can modify existing queries whether they are supplied predefined queries or queries that you created.

To modify an existing query:

1. Right-click the query that you want to edit, and click **Edit**, or click the query that you want to edit, and click **Edit** → **Edit Query**. The Edit Query window is displayed, as shown in Figure 5-19 on page 115.

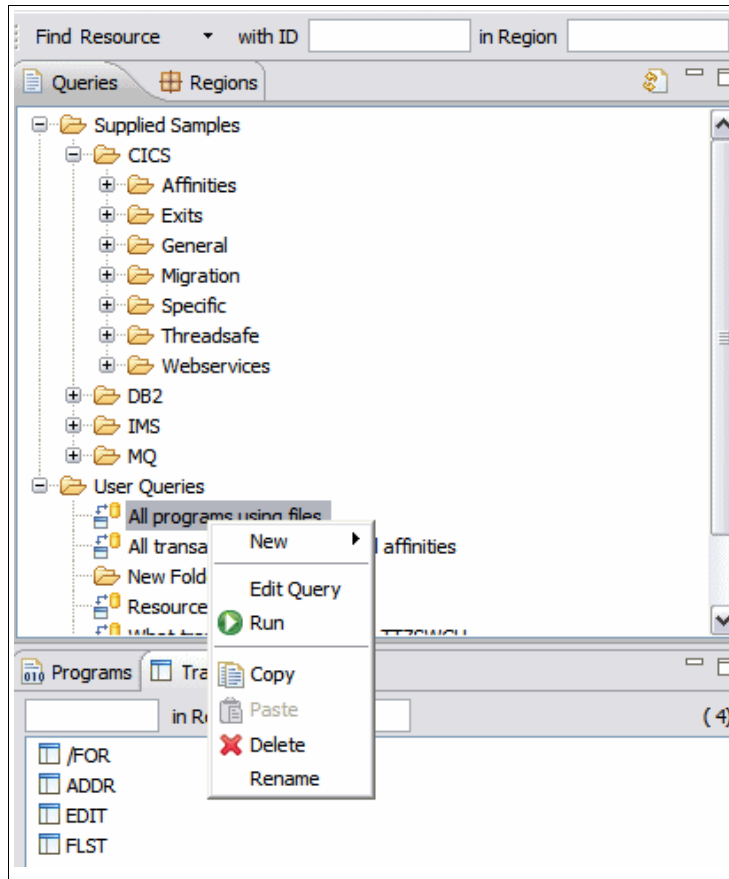

Figure 5-19 Edit query

2. Edit any aspect of the query that you want. To save the edited query as a new query, change the name. Figure 5-20 on page 116 shows the Edit CICS query window.

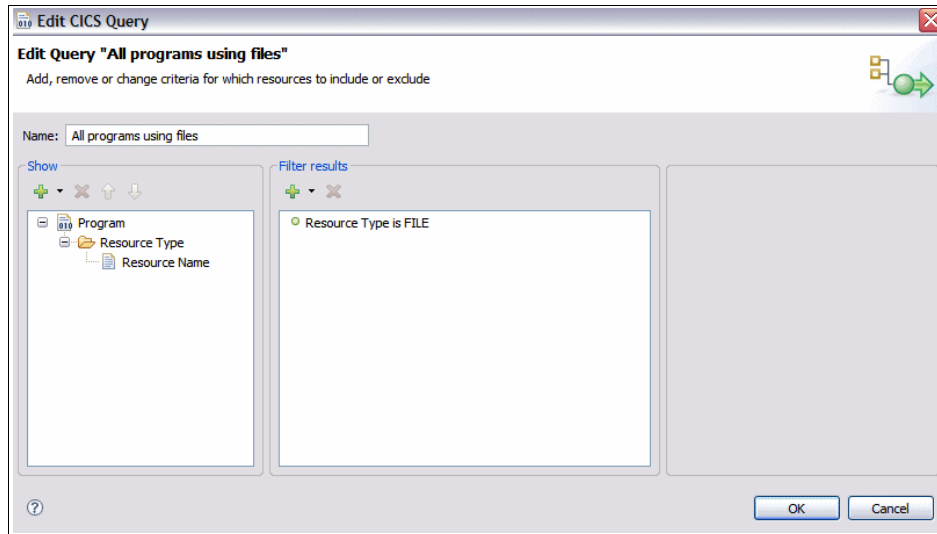

Figure 5-20 Edit CICS query window

3. Click **OK** to save the query. The query is saved in the same folder that the original query is saved.

5.10.3 Saving your queries in folders

When you create and define your queries, you can save them in the Queries window for future use.

To save your queries:

1. Before you create a query, in the Queries window, click the folder name under which you want the query to be listed. You cannot move a query after it is saved.
2. After you name and define your query, click **OK**, and the query is saved in the query folder that you selected.
3. To delete a query, in the Queries window, right-click the query name, and click **Delete**.

5.10.4 Creating a query folder

You can save queries and query results in the existing folders or create a new folder.

You can create folders under any of the existing folders as a subfolder. To create a folder:

1. In the Queries window, click the position where you want the folder to be created, and select **File** → **New** → **New Folder**, or right-click and select **New** → **New Folder**, as shown in Figure 5-21. A folder called New Folder is created in the Queries window.

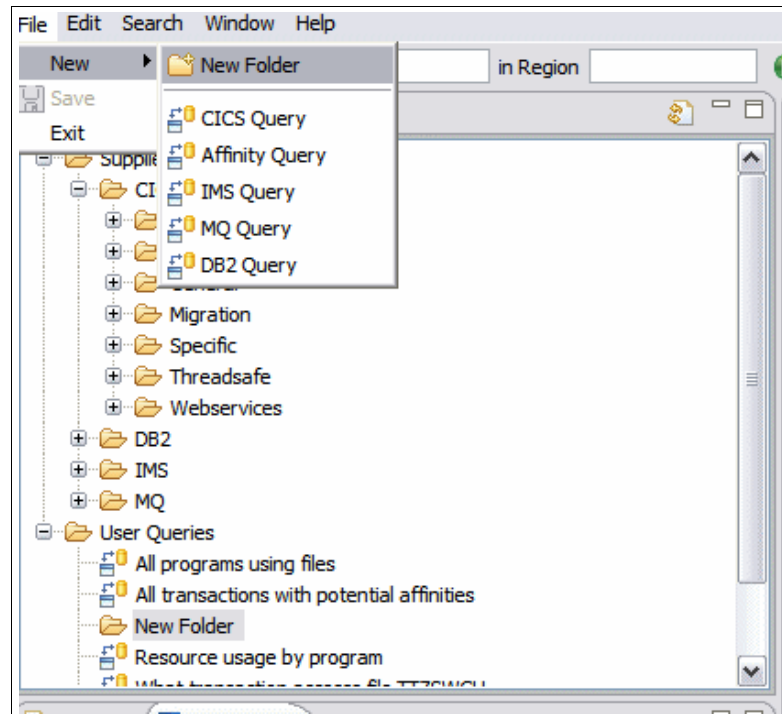

Figure 5-21 Create new folder

2. Change the name New Folder to the required folder name.
3. To delete a query folder, in the Queries window, right-click the query folder name, and click **Delete**. You cannot move an existing folder in the structure.

5.11 Analyzing query and search results

You can further analyze the results of any query or search that are displayed in the CICS IA plug-in windows. You can view the programs and transactions that are used as a resource and the region in which they are using that resource. You

have the option to analyze the resource in the region in which it is being used. You can analyze the use of each resource across all regions or specific regions.

To further analyze any query or search results:

1. Right-click any resource that is displayed in any window in the CICS IA plug-in.
2. Click **Used By** or **Uses Resources**, as shown in Figure 5-22. Only programs and transactions have the Uses Resources option.

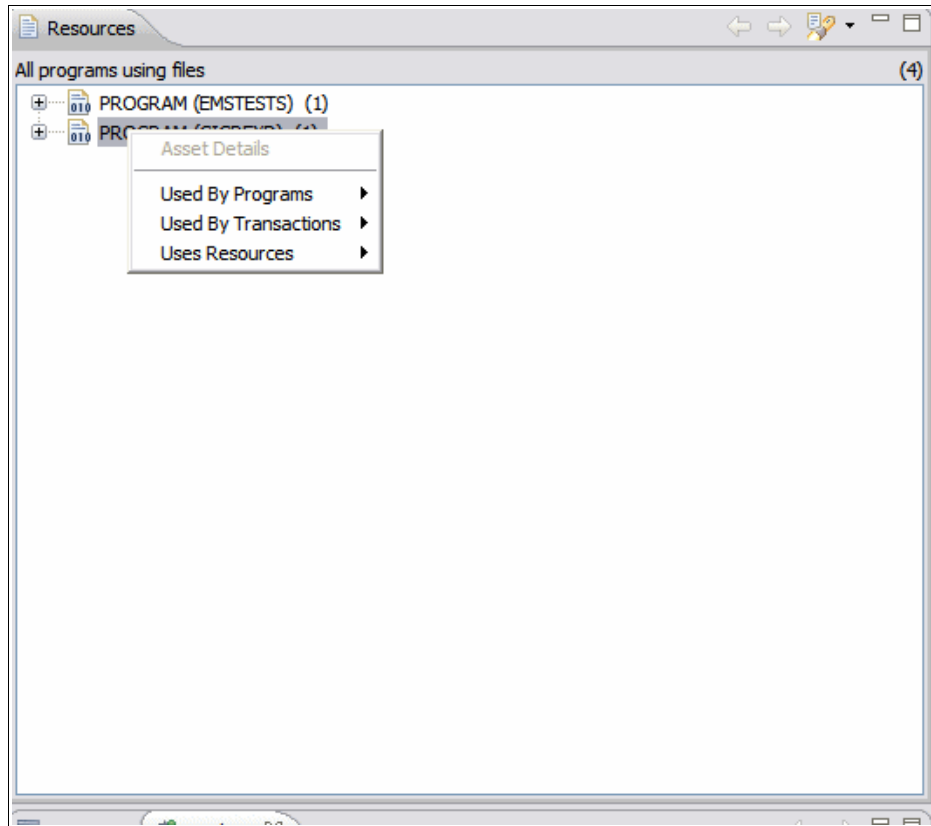

Figure 5-22 Used By and Uses Resources options

3. Click **All Regions** or a specific region that is shown in the menu:
 - The results for the Used By option are displayed in the Used By window.
 - The results for the Uses Resources option are displayed in the Uses windows.

4. Repeat steps 1 to 3 to further analyze the results in the Used By and the Uses windows.

If you select a resource in the Uses window, the lower panel in the Uses window shows the names of the programs that are using that resource. You can navigate the program tree that is displayed in the lower panel by using the yellow up and down arrows, which move between each resource in order.

5. To recall previous search results in your current CICS IA plug-in session, use the yellow back and forward arrows. The resource currently being analyzed is displayed at the top of the window, as shown in Figure 5-23.

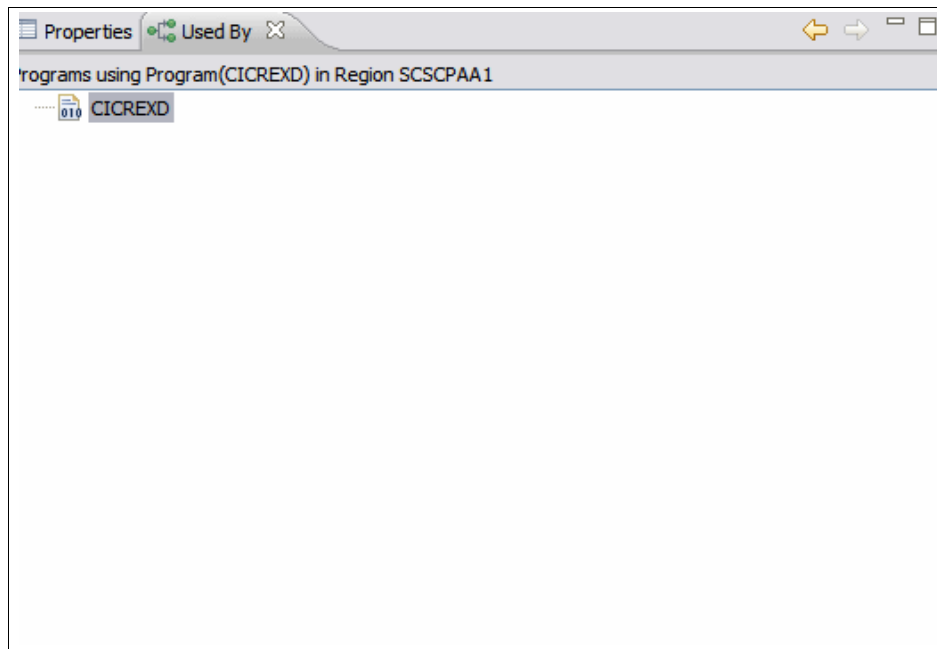

Figure 5-23 After clicking Used By

5.12 Comparing query and search results

When you have a number of query or toolbar search results, you might want to compare two or more results. You can select any number of results in the history using the Compare search results window. You can also compare saved query results.

The Compare search results window relies on complete searches being of the same structure. For large amounts of data, it is more efficient to create a query.

You can compare query and search results using the Compare search results window, which is shown in Figure 5-24:

1. Click the compare torch icon to open the Compare search results window, shown in Figure 5-24. Both panels contain a list of all query results. Select the results in the left panel to Show resources in those results and compare with the results that you select in the right panel to show resources that are not in those results.

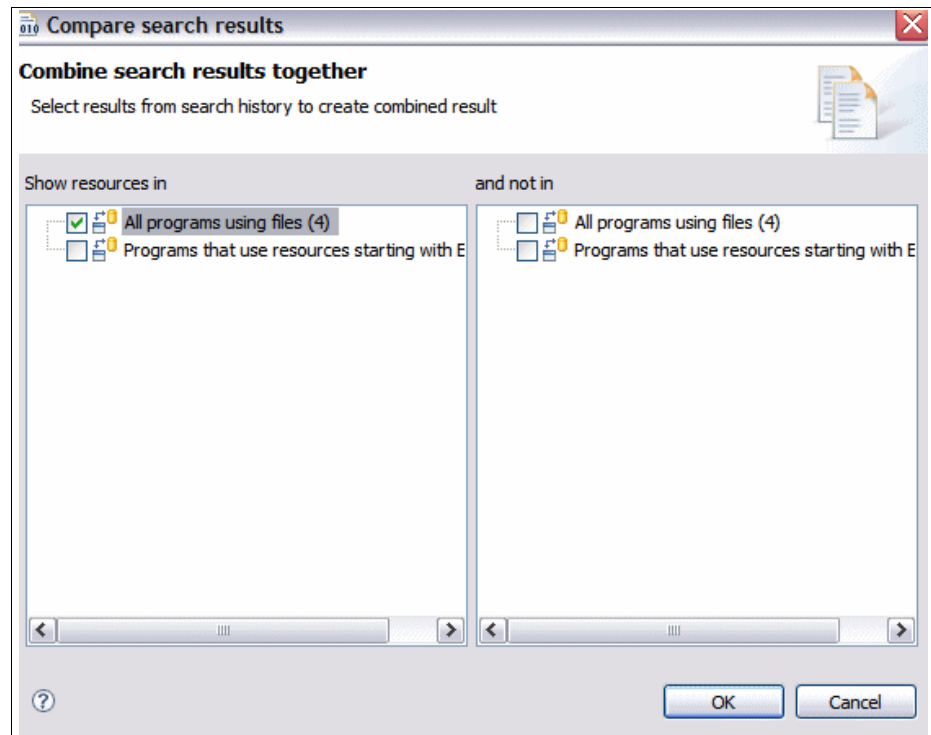

Figure 5-24 Compare search results

If you want to compare saved query results, you must view the saved query results in the Resources window so that the Compare window can include the saved query results in your selection of choices.

2. Click the boxes next to the results that you want to compare.
3. Click **OK**. The Resources window displays the results. The comparison that was run is identified in the grey section of the Resources window. If there are no results, the comparison information is shown but the results window is empty.

4. Optional step: To clear the history of query results from the Compare search results dialog box, click the down arrow next to the torch icon to display the menu items. Click **Clear History**.



CICS Explorer CM plug-in familiarization

In this chapter, we discuss the CICS Explorer CM plug-in.

6.1 Introduction

CICS Configuration Manager (CM) provides a single point of control for editing, reporting, and migrating CICS resource definitions across an enterprise. CICS CM is a CICS application that can read from and write to a CICS system definition (CSD) file and CICSplex SM contexts.

The CICS CM plug-in provides an Eclipse-based infrastructure to view and manage CICS CM resource definitions across an enterprise. It supports a subset of the function that is available in CICS CM.

CICS CM introduces the concept of a configuration that can be backed by either a CSD file or a CICSplex SM context, which means that the question of how a resource is stored is removed from you because CICS CM provides a single experience regardless of whether you are dealing with a CSD or a CICSplex SM context.

Configurations contain lists, which contain groups, which contain resources. Using CICS CM you can manage these resources using create, read, update, and delete operations.

Using the powerful search facility that CICS CM provides you can search for resources with common criteria across one or many configurations.

CICS CM records operations on resources and journals. This information is then available as part of the history of a resource and is also searchable on a configuration and a group level.

CICS CM also provides some clean up operations to identify potentially redundant resources and those resources that cannot be properly used.

6.2 CICS CM plug-in overview

In this section, we provide overview information about the CICS CM plug-in.

6.2.1 Setting up the CICS CM plug-in

When you install the CICS CM plug-in you must define a connection to CICS CM:

1. Open the preference page, and select the **Connections** option.
2. In the connections pane, select the **CICS Configuration Manager** option from the Type pull-down list, as shown in Figure 6-1 on page 125.

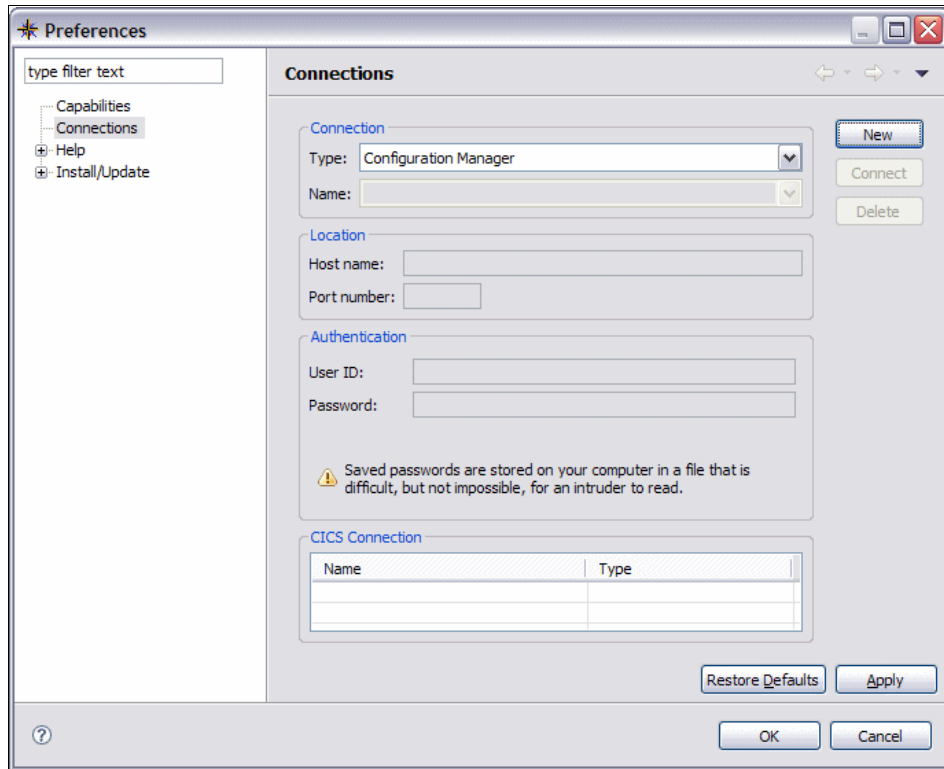

Figure 6-1 Connections Pane

When you start using your CICS CM Connection, all of your administration of CICS definitional resources is done through CM, and as a result is recorded in the journal.

You might also want to manage operational resources, which you can do by associating a CMCI or a WUI server connection with your CICS CM Connection, as shown in Figure 6-2 on page 126.

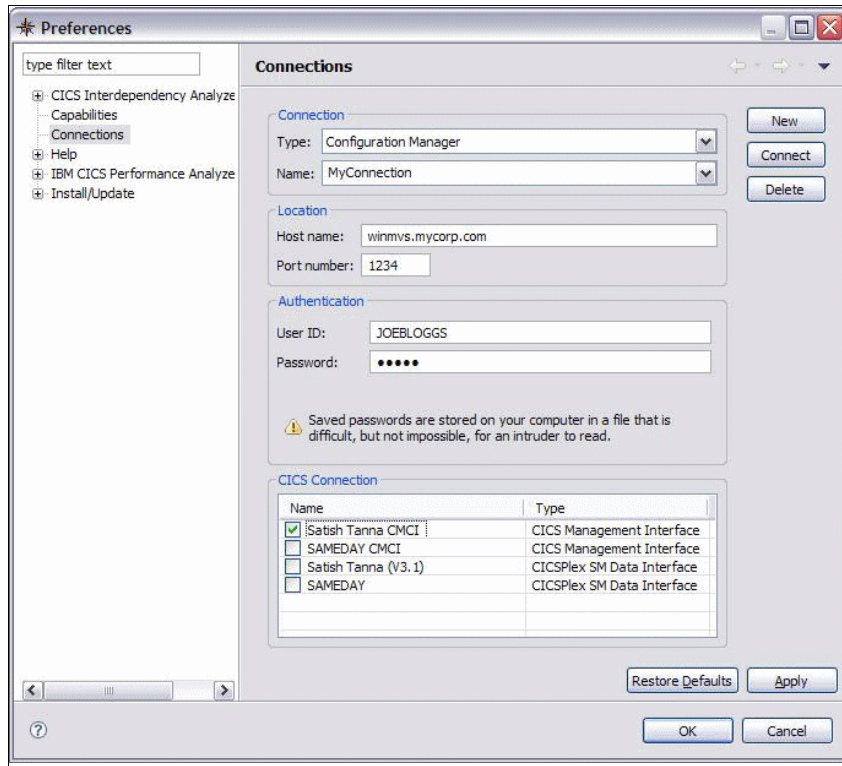

Figure 6-2 Manage operational resources

Now you can view operational resources from your region/WUI and definitional resources from CM. You can also install CICSplex SM Context resources to be installed, added, and removed from groups.

6.3 CM perspective overview

Installing CICS CM, Figure 6-3 on page 127, provides a new perspective to the CICS Explorer workspace.

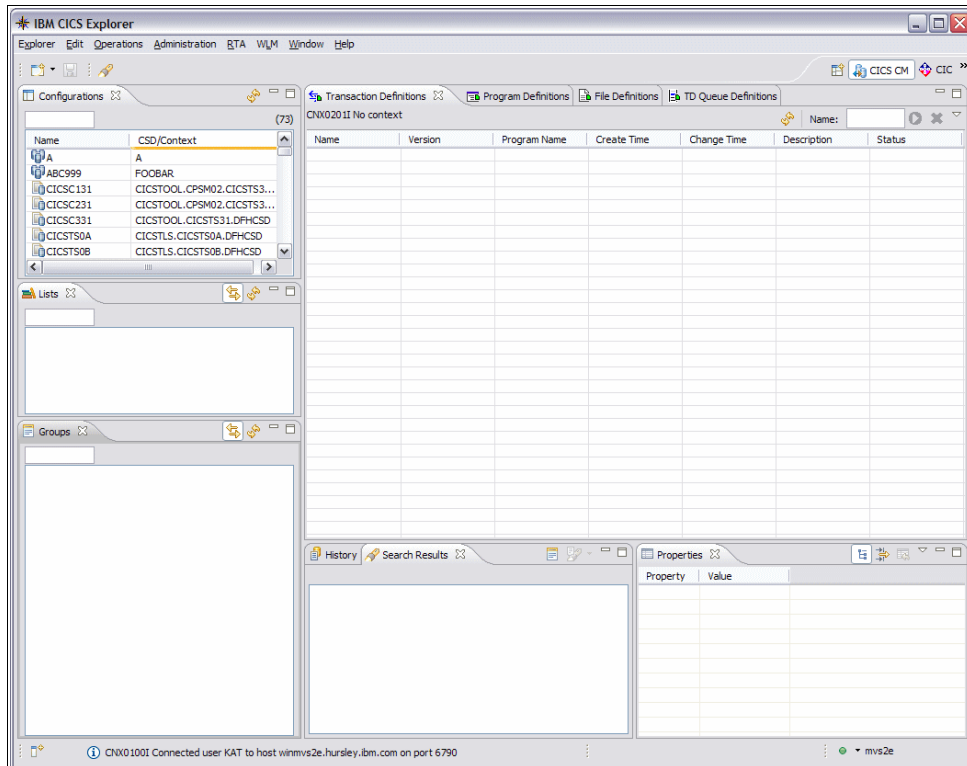

Figure 6-3 CICS CM perspective

Within this configuration there are views for configurations, lists, groups, History, Search, and some SM Administration views.

You can customize this perspective like you can with any other plug-in. Your changes are saved when you exit the Explorer.

You might want to open or close any of the views. You can find a particular view through the **Operations**, **Administration**, or **Window** → show view routes.

6.4 Configurations view

The Configurations view displays all CICS CM Configurations: both those representing CSDs and those representing CICSplex SM Contexts. Figure 6-4 on page 128 shows configurations.

Name	CSD/Context
A	A
ABC999	FOOBAR
CICSC131	CICSTOOL.CPSM02.CICSTS31.DFHCS
CICSC231	CICSTOOL.CPSM02.CICSTS31.DFHCS
CICSC331	CICSTOOL.CICSTS31.DFHCS
CICSTS0A	CICSTLS.CICSTS0A.DFHCS
CICSTS0B	CICSTLS.CICSTS0B.DFHCS
CICSTS0C	CICSTLS.CICSTS0C.DFHCS
CICSTS01	CICSTLS.CICSTS01.DFHCS
CICSTS02	CICSTLS.CICSTS02.DFHCS
CICSTS03	CICSTLS.CICSTS03.DFHCS
CICSTS04	CICSTLS.CICSTS04.DFHCS
CICSTS05	CICSTLS.CICSTS05.DFHCS

Figure 6-4 Configurations

The configuration information is retrieved from the server when you connect to CICS CM and is displayed in an alphabetic table by configuration name. The table also contains details of the CSD or Context that the configuration represents.

The different types of configuration are denoted by different icons.

You can filter the table of configurations by configuration name, using the filter box at the top of the view. This box includes an implicit wildcard, so, for example, searches for 'C' returns all configurations with a name beginning with C. You can also use the asterisk (*) to match any number of wildcard characters and the plus sign (+) to match exactly one wildcard character. You must press **Enter** to apply your filter.

You can refresh the configurations view using the **Refresh** button, which forces the view to retrieve the information from the server again.

Select a configuration in the table to populate the Lists and Groups Views and also display information about the selected configuration in the Properties View. If you select more than one configuration, only the selection that is closest to the top of the table is used to populate these views.

Select and right-click one or more configurations to display a context menu with several options for searching and clean up operations. We discuss this further in later sections.

6.5 Lists View

The Lists View, Figure 6-5, displays all lists in the currently selected configuration. The configuration information is displayed alphabetically, in the text in the top of the view.

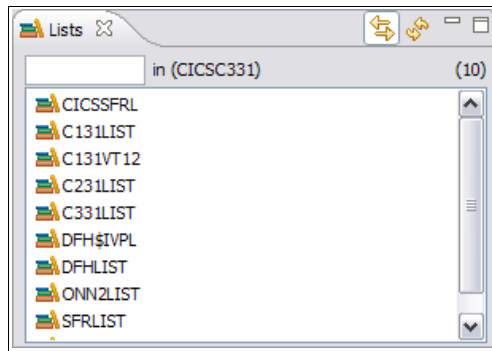

Figure 6-5 Lists View

For a configuration that represents a CSD, lists represent the Group Lists in the configuration.

For a configuration that represents a CICSplex SM Context, lists represent the ResDescs in the configuration.

You can prevent the lists view from changing its content by turning the **Link to Selection** option off. As a result, the view will no longer change contents when you select a configuration. You can turn this functionality back on by turning the **Link to Selection** option back on, as shown in Figure 6-6 on page 130.

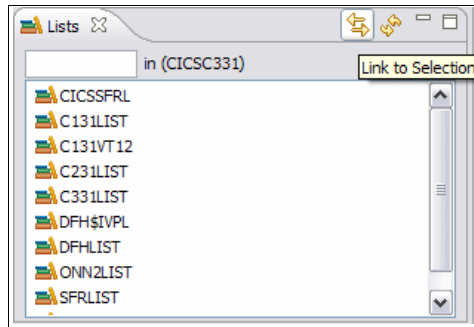

Figure 6-6 Lists View

You can filter the lists by name using the filter box at the top of the view. This box includes an implicit wildcard, for example, a search for 'C' returns all lists with a name that begins with C. You can also use the asterisk (*) to match any number of wildcard characters and the plus sign (+) to match exactly one wildcard character. You must press Enter to apply your filter.

You can refresh the Lists View using the **Refresh** button, which forces the view to retrieve the information from the server again.

Selecting a List populates the Groups View and also displays information about the selected list in the Properties View.

6.6 Groups View

The Groups View, Figure 6-7 on page 131, displays all Groups in either the currently selected configuration or the currently selected list. The last selection of either of these types is used to populate the view. This information is displayed in an alphabetic list. The information about where the view is being populated from is in text at the top of the view.

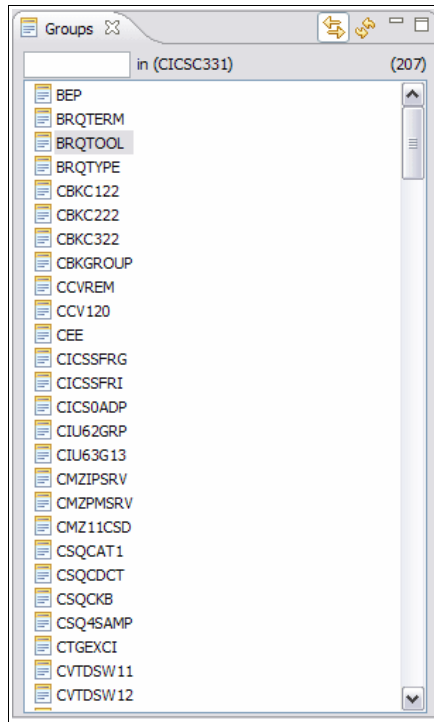

Figure 6-7 Groups View

For a configuration that represents a CSD, groups represent the csdgroups.

For a configuration that represents a CICSplex SM Context, groups represent the ResGroups.

You can prevent the lists view from changing its content by toggling the **Link to Selection** button to the off position. The view will no longer change its contents when you select a configuration. You can easily turn this functionality back on by toggling the **Link to Selection** button to the on position.

You can filter the Lists by name using the filter box at the top of the view. This box includes an implicit wildcard, for example, a search for 'C' returns all lists with a name beginning with C. You can also use the asterisk (*) to match any number of wildcard characters and the plus sign (+) to match exactly one wildcard character. You must press Enter to apply your filter.

You can refresh the groups view using the **Refresh** button, which forces the view to retrieve the information from the server again.

Selecting a group in the list populates any open definitional views with the resource definitions that are contained in the selected group.

Selecting a group also displays information about the selected group in the Properties View. If you select more than one group, only the selection that is closest to the top of the list is used to populate these views.

Selecting and right-clicking one or more groups displays a context menu with several options for searching and creating new definitions. See later sections for more information.

6.7 Definitional Views

By default in the CM Perspective, Figure 6-8, the following definitional views are already open: Transaction Definitions, Program Definitions, File Definitions, and TD Queue Definitions. You can customize the perspective in any way that you want, including closing these views and opening others. Other definitional views can be found through the Administration menu.

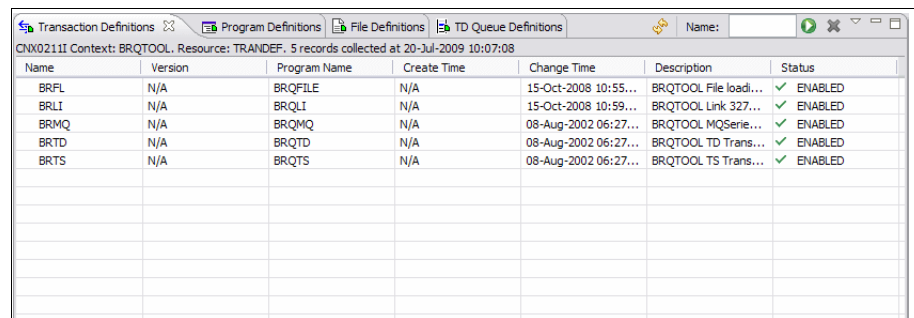

Name	Version	Program Name	Create Time	Change Time	Description	Status
BRFL	N/A	BRQFILE	N/A	15-Oct-2008 10:55...	BRQTOOL File loadi...	✓ ENABLED
BRLI	N/A	BRQLI	N/A	15-Oct-2008 10:59...	BRQTOOL Link 327...	✓ ENABLED
BRMQ	N/A	BRQMQ	N/A	08-Aug-2002 06:27...	BRQTOOL MQSerie...	✓ ENABLED
BRTD	N/A	BRQTD	N/A	08-Aug-2002 06:27...	BRQTOOL TD Trans...	✓ ENABLED
BRTS	N/A	BRQTS	N/A	08-Aug-2002 06:27...	BRQTOOL TS Trans...	✓ ENABLED

Figure 6-8 CM Perspective

CICS CM populates these views when a group is selected and all resources for the group are retrieved from the server.

You can manipulate these views by changing the order of columns, configuring which columns to display, and applying various filters.

More detailed information about how to manipulate views is in Chapter 1, “CICS Explorer introduction” on page 3.

6.8 Creating, editing, and deleting a resource definition

In this section, we discuss how to create, edit, and delete a resource definition.

6.8.1 Creating resources

CICS CM uses the Creation Wizards that are provided in the Base CICS Explorer to enable creation of resources. There are a number of different routes that you can take to create a resource definition.

To create a resource definition:

1. From a Group, in the context menu, select **New**.
2. From the list, select a specific type or **Other**, which displays more resource types. Select one of these resource types to create a definition of that type. Figure 6-9 shows the creation of a bundle definition.

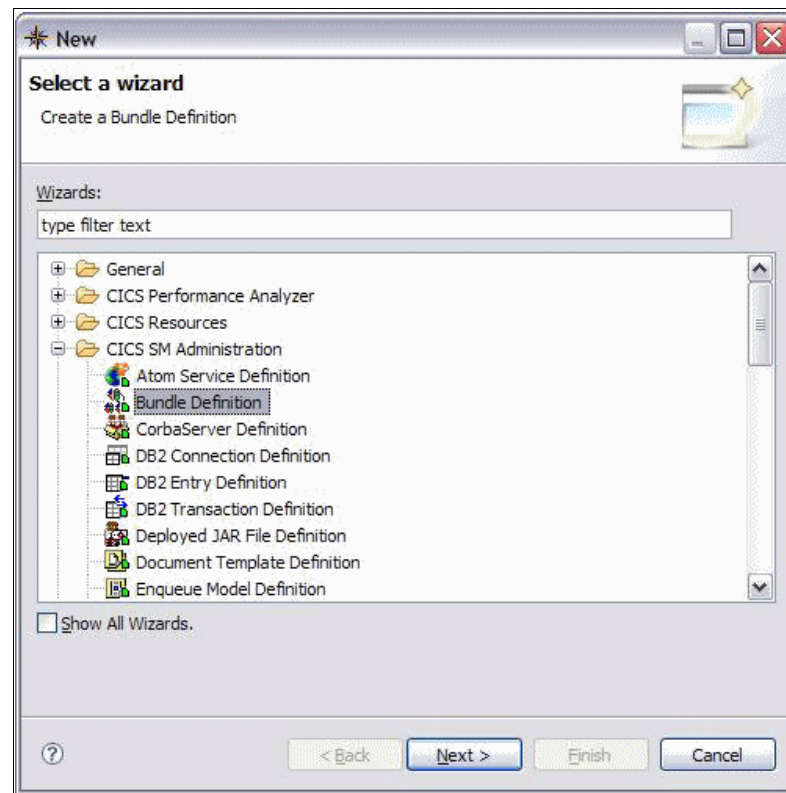

Figure 6-9 Resource creation

3. From a definitional view, locate the context menu, and select **New**. The creation wizard for that type is displayed. Figure 6-10 is an example of creating a TD Queue.

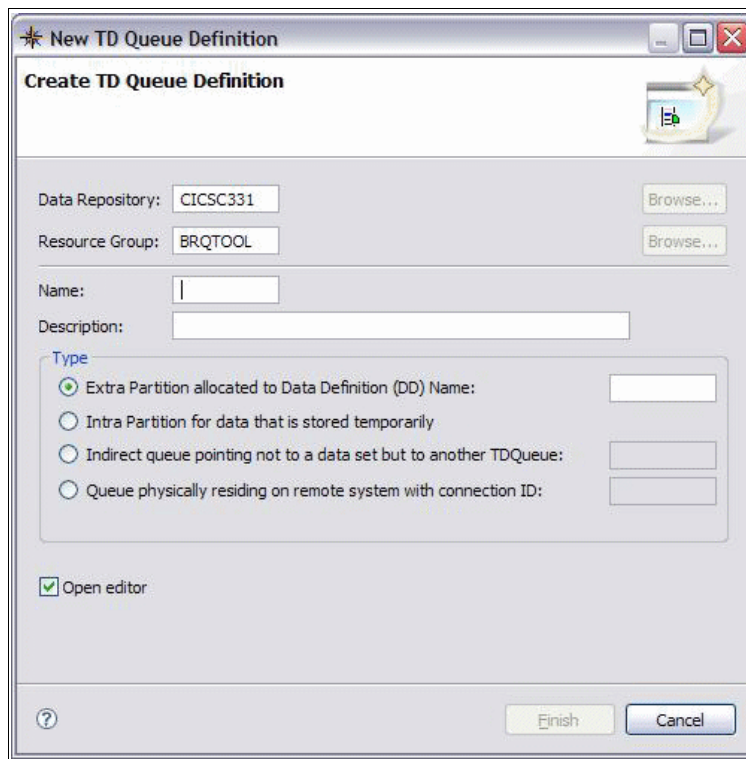

Figure 6-10 New TD queue

Each type of resource definition displays a different creation wizard because each type has different basic attributes that must be entered. For details about the creation wizards, see Chapter 1, “CICS Explorer introduction” on page 3.

When a definition is created it is then displayed in an editor where further editing can occur.

6.8.2 Editing a resource

You can use CICS CM to edit your resource definitions in configurations that are backed by both CSDs and CICSplex SM Contexts.

Editors

CICS CM uses the editors that are provided in the Base CICS Explorer to display resource definitions, as shown in Figure 6-11. The same framework is used to display and edit resource definitions; however, any changes that you make go through the CM server, which ensures that journaling takes place. For more information, see “Editors overview” on page 13 for more details about editors.

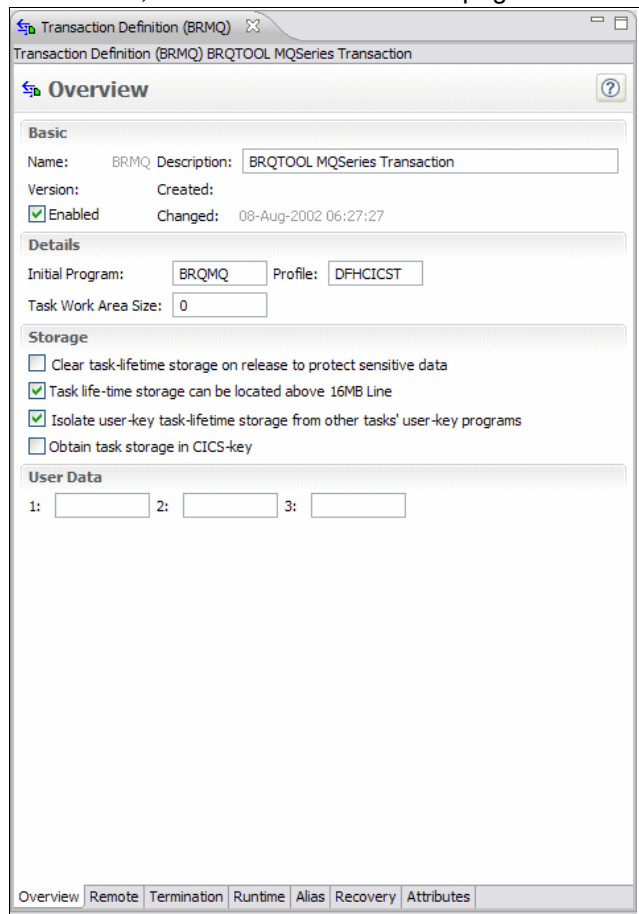

Figure 6-11 Transaction definition

To open editors on a particular resource definition select the **Open** option from the context menu or double-click the resource. The Editors provide some attribute validation, undo capabilities, and context help. Refer to Chapter 1, “CICS Explorer introduction” on page 3 for further information about the Editors and how to get the most out of them.

6.8.3 Deleting a resource

To delete a resource definition, select the resource, and from the context menu, click **Delete**.

6.8.4 Installing a resource

It is possible to install resources from a CICSplex SM Configuration into one or more active CICS systems, if you also defined an operational connection to work alongside the CICS CM connection.

If the operational connection is defined, the **Install** option is enabled in the context menu for these resources. See 3.1, “Installing CICS Explorer” on page 44 for instructions about installing the CICS Explorer.

6.9 Adding and removing from groups

You can add and remove resources from groups within a CICSplex SM Configuration, if you also defined an operational connection to work alongside the CICS CM connection.

If the operational connection is defined, the **Add to Group** option is enabled in the context menu for these resources. The **Remove from Group** option is only enabled if the resource definition already belongs to a group.

See section Chapter 4, “CICS Explorer base familiarization” on page 59 for details about adding and removing from groups.

6.10 History

In this section, we discuss History. You can review what changed.

6.10.1 CICS CM journal

In its journal, CICS CM records information about changes that are made to definitions. To keep track of these changes, you must make the changes using CICS CM. If you bypass CICS CM using CEDA, the CICSplex SM WUI, or a CMCI Explorer connection, your changes are not recorded in the journal.

If you use the CICS CM plug-in within the CICS Explorer to make changes to definitions through a connection to CICS CM, these changes are recorded in the journal. This connection can still be used in conjunction with a CMCI or a CICSplex SM Data Interface connection for operational resources.

6.10.2 History View

The History View displays changes that are made to definitions, as shown in Figure 6-12. This view is populated by the current selected definition, group, or configuration.

When a resource definition is selected the History View displays all changes for that definition, within the scope of the group that the definition is in.

Revision Time	Resource Name/After	Resource Type/Before	Group	User Name	Command	Change P...	Scheme
2009/07/08 13:38:44	ASILLY	FILEDEF	ABC123	CICSUSER	UPDATE		
2009/06/29 12:24:05	ASILLY	FILEDEF	ABC123	CICSUSER	UPDATE		
2009/06/26 12:21:17	ASILLY	FILEDEF	ABC123	CICSUSER	UPDATE		
2009/06/26 12:20:20	ASILLY	FILEDEF	ABC123	CICSUSER	UPDATE		
2009/05/22 16:43:33	ASILLY	FILEDEF	ABC123	CICSUSER	UPDATE		
2008/10/23 18:12:26	ASILLY	FILEDEF	ABC123	CICSUSER	UPDATE		
2008/10/23 18:12:07	ASILLY	FILEDEF	ABC123	CICSUSER	UPDATE		
2008/10/23 18:10:47	ASILLY	FILEDEF	ABC123	CICSUSER	UPDATE		
2008/10/23 18:05:06	ASILLY	FILEDEF	ABC123	CICSUSER	UPDATE		
2008/10/23 16:48:06	ASILLY	FILEDEF	ABC123	CICSUSER	CREATE		
2008/10/23 16:43:48	ASILLY	FILEDEF	ABC123	CICSUSER	DELETE		
2008/10/23 16:42:13	ASILLY	FILEDEF	ABC123	CICSUSER	UPDATE		
2008/10/23 16:42:00	ASILLY	FILEDEF	ABC123	CICSUSER	UPDATE		

Figure 6-12 History View

When a group or a configuration is selected the History View displays all changes within that group or configuration for the last three months. This is a default value that you can alter through the Date Range dialog.

You can prevent the lists view from changing its content by toggling the **Link to Selection** button to the off position. The view will no longer change its contents when you select a configuration. You can turn this functionality back on by toggling the **Link to Selection** button to the on position.

The History View displays information in a table. Each entry in the table represents a change made. Maximizing an entry shows the details of which attributes were changed: their before and after values. Table 6-1 on page 138 provides details about the History View.

Table 6-1 History View

Field	Description
Revision Time	Shows the date and time of changes made to the resource definition. You can click a date entry in this column to display the change properties in the Properties View.
Resource Name/After	When the row is collapsed the only the resource name is displayed. If you click the plus sign to expand the row, the value of the resource attributes after the change is displayed.
Resource Type/Before	When the row is collapsed the resource type only is displayed. If you click the plus sign to expand the row, the value of the resource attributes before the change is displayed.
Group	Shows the group name.
User Name	Shows the user who made the change and the change that was made to the data.
Command	Shows the command that was used to make the change, for example, Rename, Update, Delete.
Change Package	Shows the change package that was used to make the change.
Scheme	Shows each entry in the journal for the selected objects.

The data in the table is initially arranged by Revision Time; however, clicking any of the column headers sorts the data by that column.

Use the **Group By Date** toolbar button to turn on and off showing the entries group into date categories: Today, This week, Older than this week, Older than this month, Older than this year, as shown in Figure 6-13 on page 139.

Revision Time	Resource Name/After	Resource Type/Before	Group	User Name	Command	Change P...	Scheme
Older Than This Week							
2009/07/08 13:38	ASILLY	FILEDEF	ABC123	CICSUSER	UPDATE		
Older Than This Month							
2009/06/29 12:24	ASILLY	FILEDEF	ABC123	CICSUSER	UPDATE		
2009/06/26 12:21	ASILLY	FILEDEF	ABC123	CICSUSER	UPDATE		
2009/06/26 12:20	ASILLY	FILEDEF	ABC123	CICSUSER	UPDATE		
2009/05/22 16:43	ASILLY	FILEDEF	ABC123	CICSUSER	UPDATE		
Older Than This Year							
2008/10/23 18:12	ASILLY	FILEDEF	ABC123	CICSUSER	UPDATE		
2008/10/23 18:12	ASILLY	FILEDEF	ABC123	CICSUSER	UPDATE		
2008/10/23 18:10	ASILLY	FILEDEF	ABC123	CICSUSER	UPDATE		
2008/10/23 18:05	ASILLY	FILEDEF	ABC123	CICSUSER	UPDATE		
2008/10/23 16:48	ASILLY	FILEDEF	ABC123	CICSUSER	CREATE		

Figure 6-13 Group by date

You can filter the entries in the History View by selecting one or more filters from the view menu. The available filters are:

- ▶ Name
- ▶ Type
- ▶ Group
- ▶ User ID
- ▶ Command
- ▶ Change Package ID
- ▶ Scheme

Selecting one of these filters creates an input field in the History View. You can then enter in a filter value, select is, is not, equals, or apply. Figure 6-14 shows the filters.

Revision Time	Resource Name/After	Resource Type/Before	Group	User Name	Command	Change P...	Scheme
Older Than This Year							
2008/10/23 16:43	ASILLY	FILEDEF	ABC123	CICSUSER	DELETE		

Figure 6-14 Filters

The History View might contain many entries. If you know that you are only interested in entries within a specific set of dates, you can filter the view by date range. You can change the date range through the Set Date Range dialog, which is also available from the View menu, as shown in Figure 6-15 on page 140.

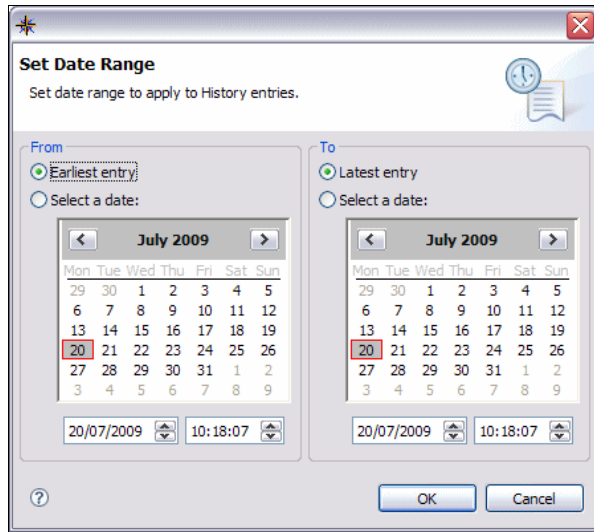

Figure 6-15 Set Date Range

You can restore some changes in the History View, and this options is displayed in the context menu of an entry in the History View. The resource definition is restored to the values before the change that you selected, as shown in the "Resource Type/Before" column.

If you restore an entry that was deleted, the resource definition is recreated. If you restore a create entry, the resource definition values are restored to the values when the resource definition was first created.

The restore option is not currently available for rename, add, or remove entries.

You can open a particular entry in the table in an editor, which displays the after attributes of the entry in the editor for the particular type and is in read-only mode.

To search for the current version of a resource definition, select an entry in the History View, and then select the **Find Current Version**.

Use the **Refresh** button to refresh the History View, which forces the view to retrieve the information from the server again.

6.11 Searches and the search view

CICS CM provides a number of different ways to search for resource definitions.

CICS CM provides some specific searches and a completely customizable search through the search dialog. Search results are displayed in the Search Results View.

Searches can be run against one or more groups within a particular configuration. They can also be run against one or more configurations in the current CM connection.

6.11.1 Specific searches

For any group or configuration you can run the Show All Resources search, which you can also run on more than one group or configuration. Simply select one or more of either groups or configurations, and select **Show All Resources**.

On any resource definition certain specific search options are displayed under the Find context menu. All resource types have an option to search for Similar resources. This feature searches for all resource definitions that have the same name and type as the resource definition that is selected, within in the same configuration.

Program Definitions have an additional specific search option. You can search for transactions that reference the selected Program.

LSR Pool Definitions have an additional option. You can search for files that reference the selected LSR Pool.

6.11.2 Using the search dialog

Using the search dialog you can perform more powerful searches to be run with filter criteria.

The search dialog is available from the **Search** icon in the toolbar or from the context menu when you select a configuration or a group.

Figure 6-16 on page 142 shows the Search Definitions.

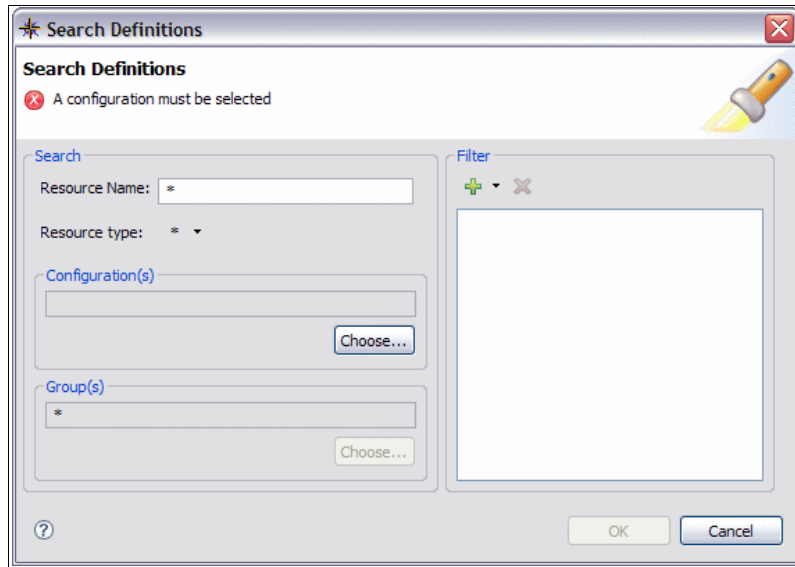

Figure 6-16 Search Definitions

You can filter by resource name and resource type. You can also select which configurations you want to search and (if appropriate) which groups to search within a configuration.

You must enter a resource name; however, you can use wildcards (*) to match any name or any number of characters within a string and (+) to match exactly one character.

Further filtering is enabled only when you select a specific resource type, as shown in Figure 6-17 on page 143. After which you can select filters from the filter pull-down menu, which allows filtering on every attribute for this type. After you select a filter, you must enter a value and where appropriate choose operators. Filters are joined together in an "and" clause.

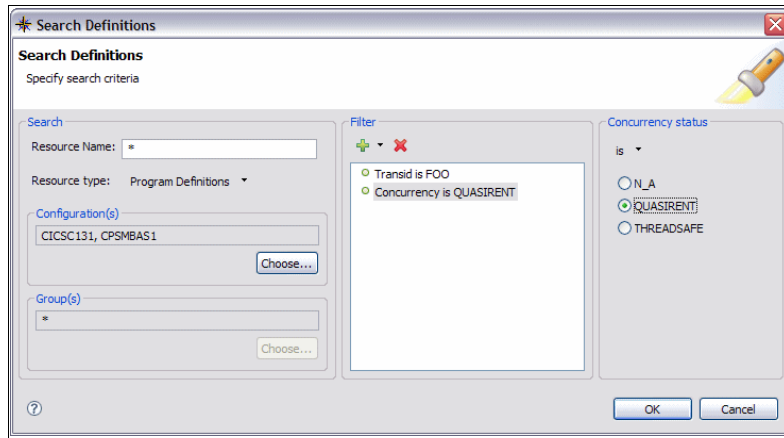

Figure 6-17 Additional filtering

Configurations might be pre-populated if you selected them when the search dialog was opened. You can add or remove Configurations from the search scope by editing the list that displays when you click the **Choose** button in the Configurations area.

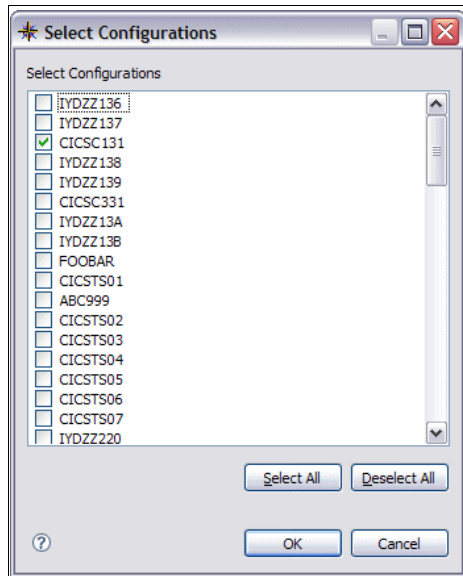

Figure 6-18 Configurations area

Groups might also be pre-populated if any were selected when the search dialog was opened. You can add or remove any groups from the search scope by

editing the list that is displayed when you click the **Choose** button in the Groups area. You can only specify groups within the same configuration. If a group is specified, you can only select one configuration. If more than one configuration is chosen, groups default to wildcard all groups (*), and the option to choose group(s) is disabled. This option is only re-enabled when exactly one configuration is selected.

6.11.3 Search results view

The search results view displays the results of any searches, as shown in Figure 6-19.

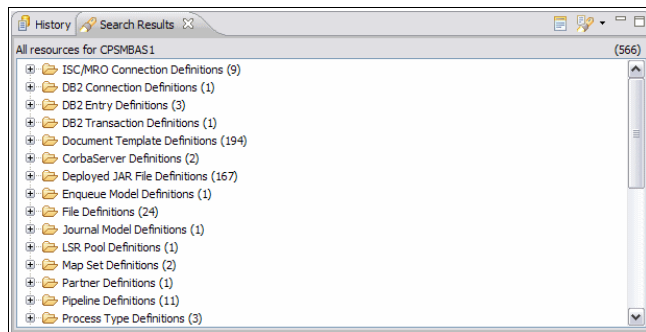

Figure 6-19 results of searches

The displayed resources are organized in tree form. If more than one configuration is selected, the top level element is a configuration. If all resource types are searched, by default results are grouped by type. Definitions that appear in more than one group are shown together.

You can introduce a new layer into the tree, separating the results into their resource groups by toggling the **Show Groups** icon.

You can navigate to the results of previously run searches through the Show Previous Searches toolbar menu within the Search results view.

Any definitions that appear in the search results view can be further manipulated by being deleted, opened, or edited. Any actions you can perform on the resource definition when navigated to in a specific resource definition view can also be performed from the search results view.

6.12 Cleaning up

CICS CM provides some options to help in resource definition clean up. For every configuration the options in Table 6-2 are available.

Table 6-2 resource definition cleanup options

Show Resources With Unique Names	Shows all resources within the selected configuration that have a unique name.
Show Duplicate Resources By Name and Type	Shows all resources within the selected configuration that could potentially be duplicates, based on name and type.
Show Orphaned Groups	Shows all groups within a configuration that do not belong to a list.

For CICSplex SM-based configurations, the additional options in Table 6-3 are also available.

Table 6-3 CICSplex SM additional options

Show Shared Resources	Shows resource definitions that are associated with two or more groups.
Show Orphaned Resources	Shows resource definitions that are not associated with any group. You cannot edit these definitions.

The results of these queries are displayed in the search results view.

Properties View

CICS CM populates the Properties View with the current selection. For resource definitions, the Properties View displays the attributes for the definition.

For Configurations, Lists, and Groups the Properties View displays additional information.



CICS Explorer PA plug-in familiarization

In this chapter, we discuss CICS PA, mainly focusing on the CICS Explorer plug-in for CICS PA.

7.1 Overview of CICS PA

In this section, we provide an overview of CICS PA.

7.1.1 Runtime product

The mainframe product provides system analysts assistance in a wide range of performance-related measurement scenarios with particular focus on:

- ▶ System performance analysis
- ▶ System tuning
- ▶ Capacity planning

The runtime product benefits CICS architects, developers, system managers, and administrators.

7.1.2 The plug-in

The CICS PA plug-in differs from the other CICS Explorer plug-ins because it does not utilize a published API on the host; instead, it uses data extracts from the PA runtime. From these data extracts targeted reports and analysis can be made.

Analysts can visualize their transaction performance data more easily using the graphing and tree views so that they can navigate and identify issues, such as Threadsafe, more readily and with less experience and skill.

At the time of writing, the CICS PA plug-in takes advantage of a subset of the main CICS PA runtime reporting functionality, presenting transaction performance summary data to you in a more understandable and intuitive way.

You can access performance data summaries and reporting scenarios through CSV files or database (DB2).

Information is extracted from the CICS PA runtime by a number of routes and can be saved either as CSV data or using a database. The data represents various measurements that are summarized over a defined time period. The CSV file is a simple portable form of data and is ideal when focused at a very specific data volume level. The database strategy is preferred for the analysis of larger data volumes not only because it can contain so much more historical data, but the performance is better from an application point-of-view rather than handling large CSV files in memory.

Presenting performance data in the context of CICS Explorer allows integration with the base explorer and other tools which compliments the historical performance information by presenting it alongside see the live data and definitions.

7.2 The PA Explorer environment

The Eclipse views that the CICS PA plug-in provides, Figure 7-1, can be used in a number of perspectives including the standard Eclipse resource perspective.

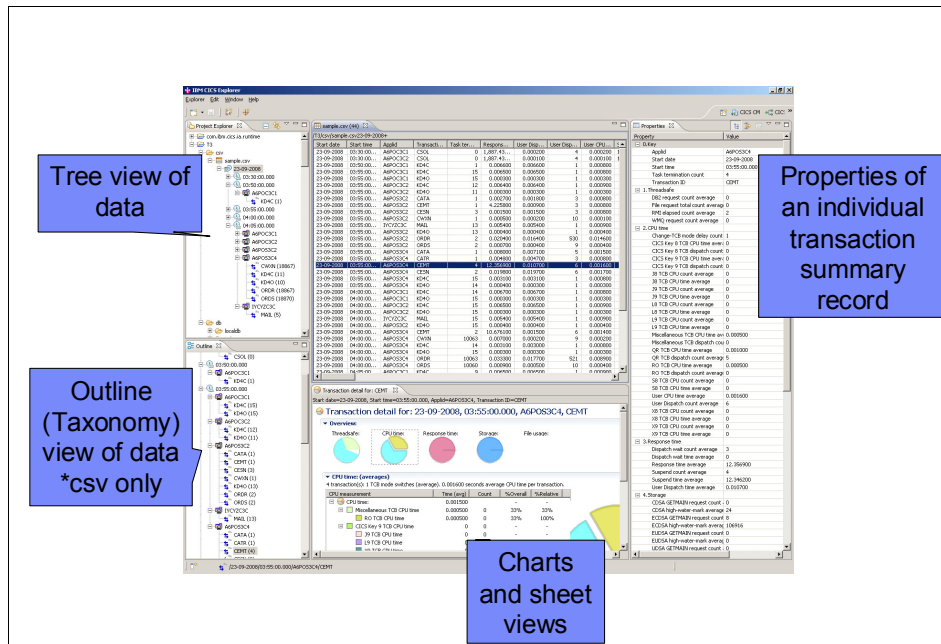

Figure 7-1 CICS PA Eclipse views

Most users' first point of contact is the Project Explorer view in the top left of Figure 7-1. The Project Explorer is a standard Eclipse view presenting resources such as files and folders to a user. In the context of the PA plug-in, files, such as a CSV file extracted from the PA runtime, are contained within a project and folders. There are numerous ways to import these files into the explorer, including Drag-and-Drop, Copy-and-Paste, plus Import. Consult the online help for more detail.

A similar mechanism to the CSV files is used for database references, which allows a consistent interface. The specification and configuration of database connectivity is described elsewhere.

The data that is contained through the CSV or database link is broken down by date, time, Applid, and transaction. This type of taxonomy makes it easy to navigate to a specific point of time to find a particular area of focus. Figure 7-2 shows data exposed using the CSV.

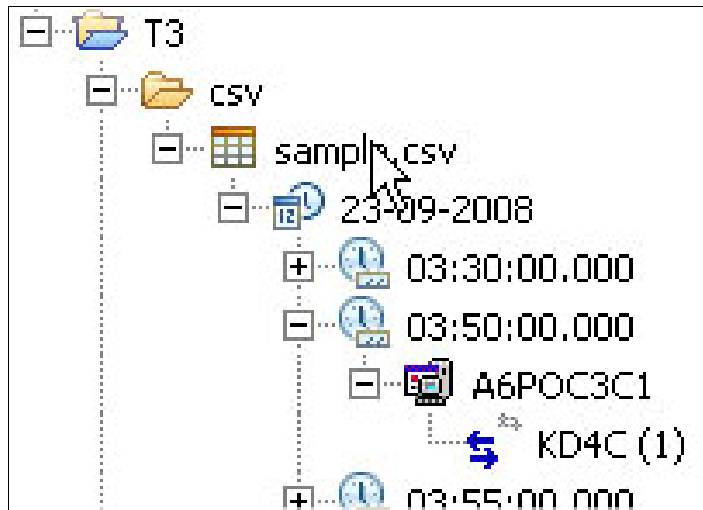

Figure 7-2 Data using CSV

After you identify an area of interest, you can see more information by opening a Sheet View or one of a series of charts, as shown in Figure 7-3 on page 151.

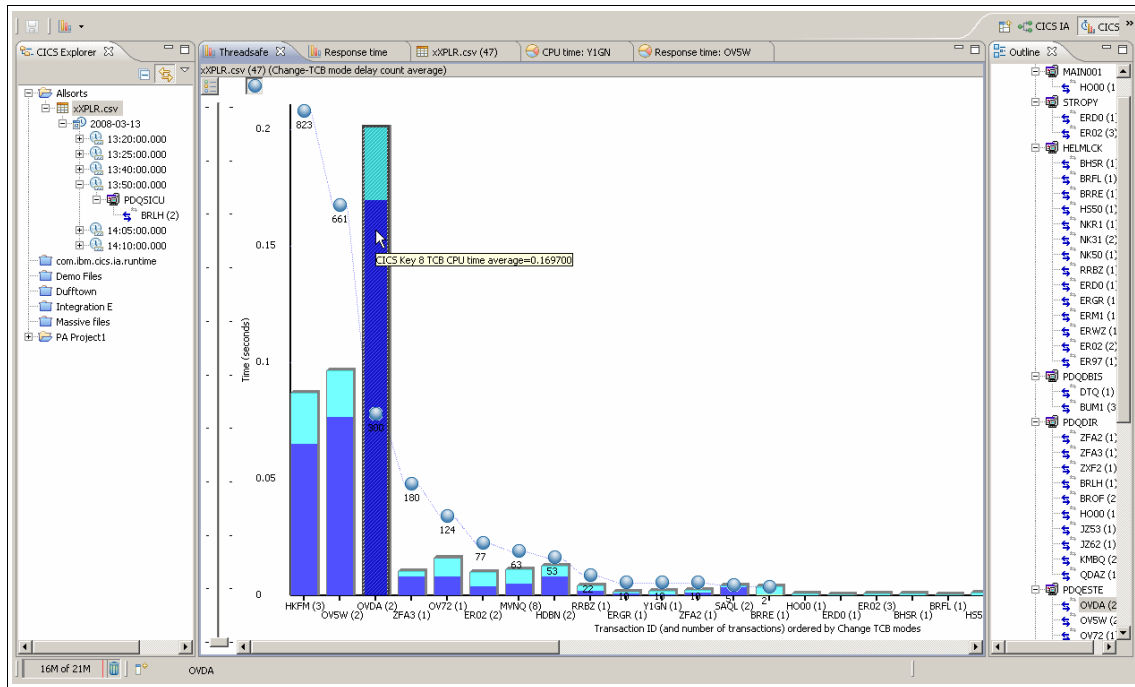

Figure 7-3 Bar chart with overlay

To accompany the main views, you can choose to complement your data picture by showing a taxonomy or outline view. This is a sort of a "where am I?" aid. This view is only enabled with a CSV file because the database equivalent can be immense and adversely affect performance.

You can also use the standard Eclipse Properties View, which shows every detail being held about a transaction instance. Data is organized based upon categorizations, which describe later.

7.3 PA views and editors in detail

In this section, we discuss the PA views and editors.

7.3.1 The Project Explorer

The Project Explorer, Figure 7-4 on page 152, is a standard Eclipse component within the Resource perspective, which is also standard Eclipse. When the PA plug-in is installed the Project Explorer displays conventional projects, folders,

and files, but if these files end with a suffix of CSV or CPA further information can be obtained from them, providing that they were created on the PA runtime.

Because we are using summary data with a unique key we can “drill into” these files and obtain a useful date, time, and applid transaction name taxonomy.

Note: Project Explorer can also be used to view and manipulate IA queries and bundles.

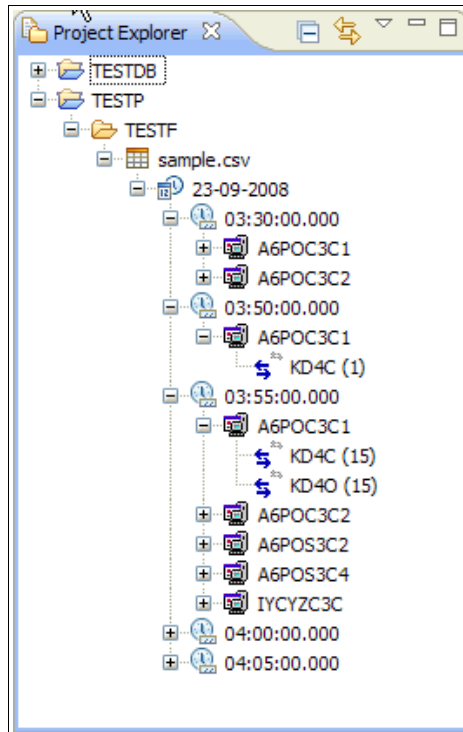

Figure 7-4 Project Explorer

Contextual menus, Figure 7-5 on page 153, are available on the project explorer view depending upon whether you selected one or more of the following options:

- ▶ Date
- ▶ Time
- ▶ Applid
- ▶ Transaction name

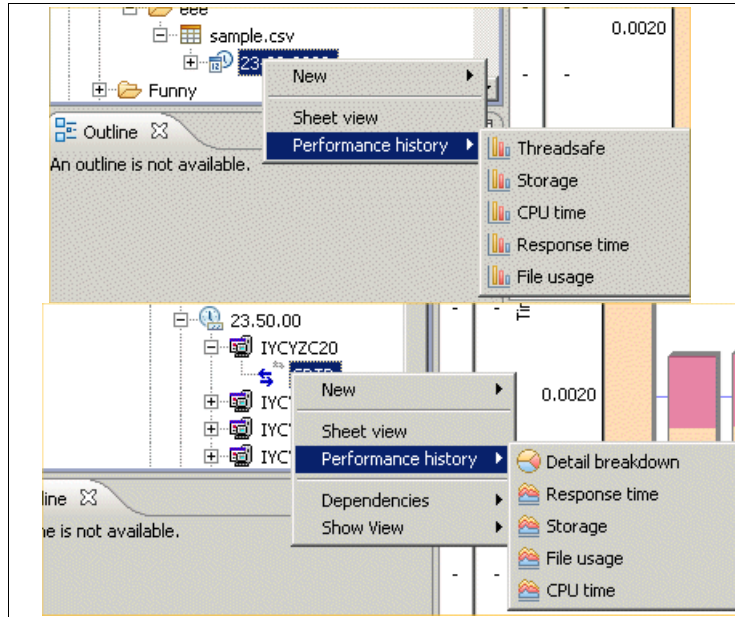

Figure 7-5 Contextual menu

7.3.2 The Sheet View

The Sheet View provides access to the raw detail information that is available from a summary report. The data is keyed based upon Start date, Time, the Applid, and Transaction name, which uniquely identifies a record instance.

Those four fields are essential for the PA Explorer to be able to read the CSV or database provided data. If these fields are not present, the application will not provide any functionality over simply displaying raw data.

You can choose the columns that are extracted from the PA runtime, but following the four columns that form the unique record key is the task termination count column. Although not part of the primary key, this value is always required in reports as additional information. Omission of this column limits further functionality.

The subsequent columns are as defined by the data extraction process on the server.

Using standard Eclipse functionality you can sort the retrieved columns and the columns can themselves be moved so that associated data can be placed side by side for visual comparison. However, remember that the sort function,

Figure 7-6, only sorts what was retrieved and does not cause a subsequent fetch of data to be executed.

Full path name

Sortable Columns

Movable Columns

Start date	Start time	Applid	Transacti...	Task ter...	Suspend count average	Suspend time average	R#
2007-01-12	10.25.00	IYCY2C23	CCVW	2	1	0.001744	
2007-01-12	10.30.00	IYCY2C23	CCVW			0.001211	
2007-01-12	10.35.00	IYCY2C23	CCVW			.000720	
2007-01-12	10.40.00	IYCY2C23	CCVW			.000411	
2007-01-12	10.45.00	IYCY2C23	CCVW			.000504	
2007-01-12	10.50.00	IYCY2C23	CCVW			.001040	
2007-01-12	10.55.00	IYCY2C23	CCVW	2		.001368	
2007-01-12	11.00.00	IYCY2C23	CCVW	3	1	0.001211	
2007-01-12	11.05.00	IYCY2C23	CCVW	2	1	0.000992	

Figure 7-6 Sort function

Other standard Eclipse functionality includes the ability to copy the data in an individual cell to the clipboard to be pasted into a document. Figure 7-7 is an example of how to copy data.

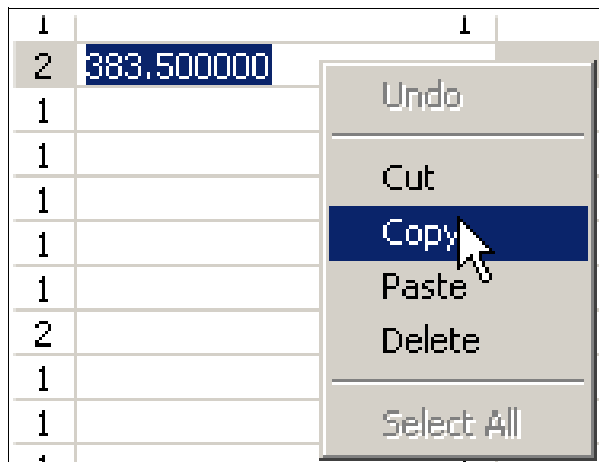

Figure 7-7 Copy data

You can also select and copy complete rows, as shown in Figure 7-8 on page 155.

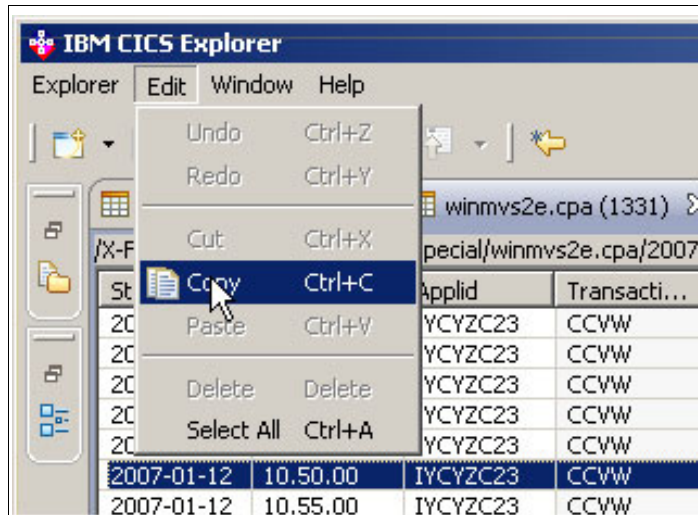

Figure 7-8 Copy complete rows

7.3.3 Pie chart view

Pie charts are displayed in the Transaction detail view, as shown in Figure 7-9 on page 156. The pie charts contain a detailed breakdown of a single transaction ID in the time period selected. To display the Transaction detail view:

1. Select a single transaction in the Project Explorer view or a Sheet View.
2. Right-click the selection, hover over Performance history, and select Detail breakdown. The Transaction detail view is displayed.
3. Click a pie chart to show the details for a specific analysis type. In Figure 7-9 on page 156, the Transaction detail view is shown with the CPU time pie chart selected, displaying detailed CPU time information for the selected transaction ID.

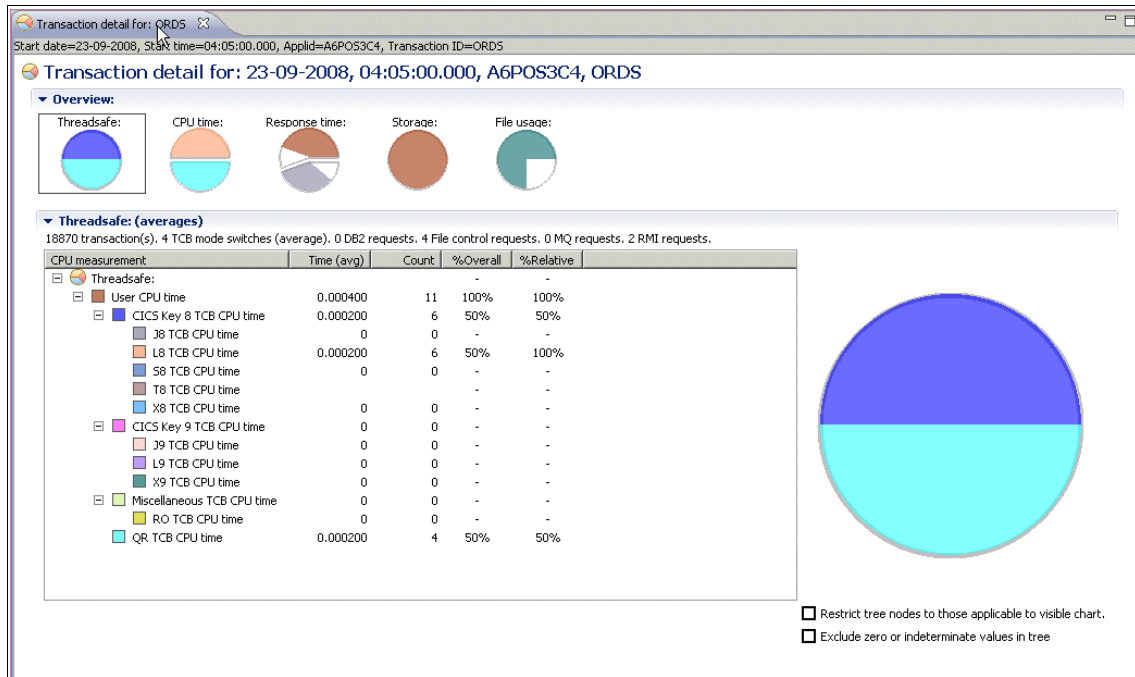

Figure 7-9 Transaction detail view

The Transaction detail view displays the following information:

- ▶ A view tab that shows the analysis type and the name of the transaction ID.
- ▶ An information bar below the view tab that contains further details about the transaction ID.
- ▶ A pie chart for each type of analysis. You can select each analysis by clicking the relevant pie chart.

The Transaction detail view contains one or more pie charts depending on the data selected and categorization enablement, for example, if the Storage categorization enablement is not selected, the Storage pie is not displayed. Similarly, if there is no file usage data in the selected sample, the File usage pie chart is not displayed.

7.3.4 Bar charts

A bar chart, Figure 7-10 on page 157, displays a bar for each transaction that is selected. Each bar contains one or more sectors, and each sector represents different information depending on the selection type.

You can access the bar chart through the Performance History Context menu. It is identified by a sub-menu that displays the bar graphic, as shown in Figure 7-10.

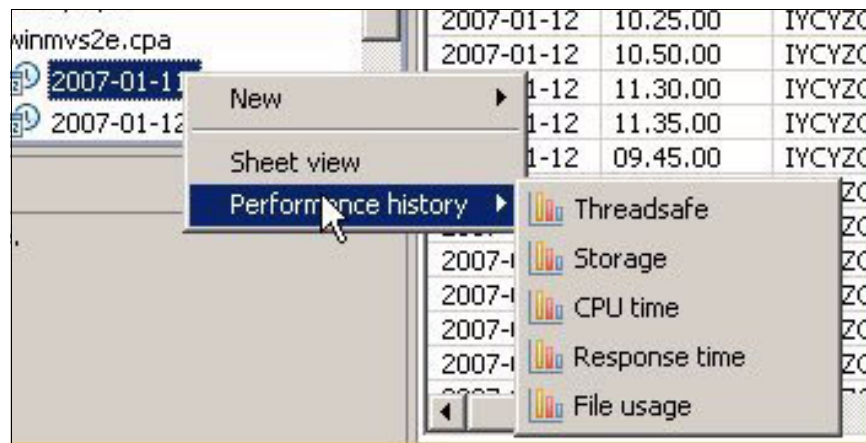

Figure 7-10 Creating a bar chart

The charts are described by scenarios, which give a pointer to what type of data is of specific interest. Figure 7-10 shows Threadsafe, which means that the fields that will be analyzed and displayed are important when considering a Threadsafe issue or concern:

1. Select two or more transactions or select a higher tree node, such as an application ID that contains two or more transactions, either in the Project Explorer view or a Sheet View.
2. Right-click the selection, hover over Performance history, and select the type of analysis to perform.

A new view opens displaying a bar chart for the selected analysis. In Figure 7-11 on page 158, a storage analysis is selected, and the Storage view is shown with a bar chart for each of the selected transaction IDs.

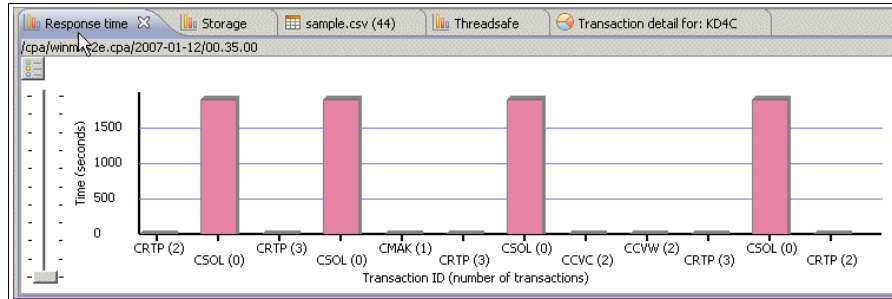

Figure 7-11 Bar Chart

The bar chart view displays the following information:

- ▶ A view tab, containing the name of the analysis in this case, Storage. You can hover over the tab to show the data source file and number of records in the sample.
- ▶ An information bar below the view title, that contains the path and name of the data source file that contains the data.
- ▶ Stacked bars that consist of one bar for each transaction ID selected. Each bar in a stack consists of one or more sectors, each representing a different field. You can hover over a sector to show further information about the field.
- ▶ A Legend icon in the top left corner of the chart. Click this icon to display the chart legend. The legend shows only the colors in use in the current chart.

You can select one or more bars and perform a further analysis on the information by right-clicking and selecting a new analysis from the menu.

7.3.5 Timeline charts

A timeline chart displays all instances of a transaction ID in the selected application ID across either the whole data file or a range of dates specified using the Date dialog when selecting the data, for example, selecting the single record with a transaction ID of CRTP in an application ID of IYCYZC20 displays a bar for every instance of the transaction ID in the application. To display a timeline chart:

1. Select a single transaction, either in the Project Explorer view or a Sheet View.
2. Right-click the selection, hover over Performance history, and select the type of timeline analysis to perform. The restrict analysis time period dialog is displayed, as shown in Figure 7-12 on page 159.

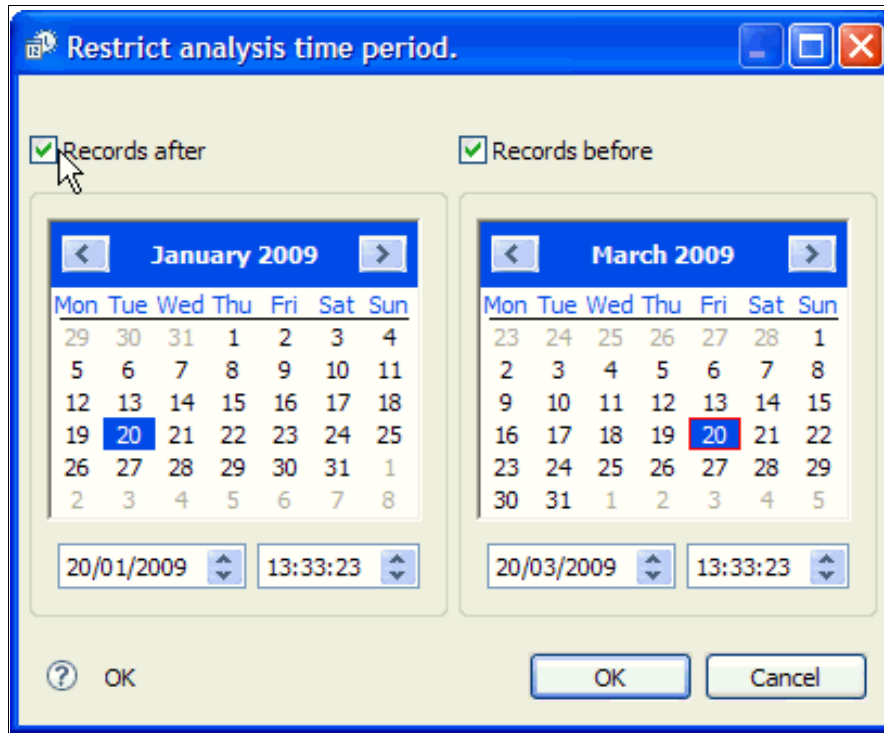

Figure 7-12 Restricting analysis time period

3. Select the time period to restrict the display to show only data between the two dates. Click **OK**. A new view opens displaying a timeline chart. In Figure 7-13, an analysis of transaction ID CRTP in application ID IYCYZC20 is selected.

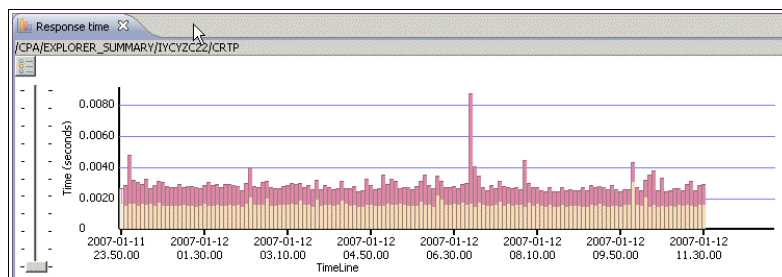



Figure 7-13 Transaction ID CRTP in application ID IYCYZC20

The timeline chart displays the following information:

- ▶ A view title that contains the name of the analysis, in this case, Response time. You can hover over the tab to show the data source file and number of records in the sample.
- ▶ An information bar below the view title that contains the name of the CSV or database file that contains the data, the application ID, and the transaction ID.
- ▶ Stacked bars that consist of one bar for each instance of the selected transaction ID in the application ID. Each bar in a stack consists of one or more sectors, each representing a different time field. You can hover over a sector to show the average time value for the CPU time field.
- ▶ A Legend icon  in the top left corner of the chart. Click this icon to display the chart legend.

You can select one or more bars and perform a further analysis on the information by right-clicking and selecting a new analysis from the pop-up menu.

By using multiple timeline charts you can compare the way transactions are performing in one CICS region against the way they perform in another CICS region and identify potential problems. Figure 7-14 shows the timelines for the same transaction ID over the same period of time but running under different applications.

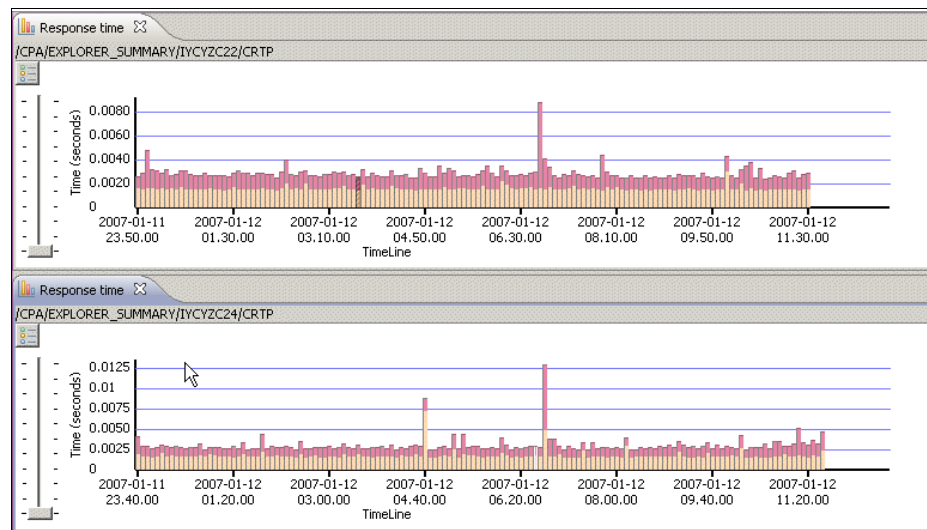

Figure 7-14 Multiple timeline charts

For more information about the details in specific timeline charts, see the related links at the end of this book.

7.3.6 Properties View

Another Eclipse view. You can select a single transaction ID from the Project Explorer view or from a chart, and display all of its properties in the Properties View.

1. From the workspace menu, click **Window** → **Show View** → **Properties**. The Properties View is displayed.
2. Select a single transaction in the Project Explorer view, Sheet View, or a chart view.

All of the details for the selected transaction ID are displayed in the Properties View, as shown in Figure 7-15.

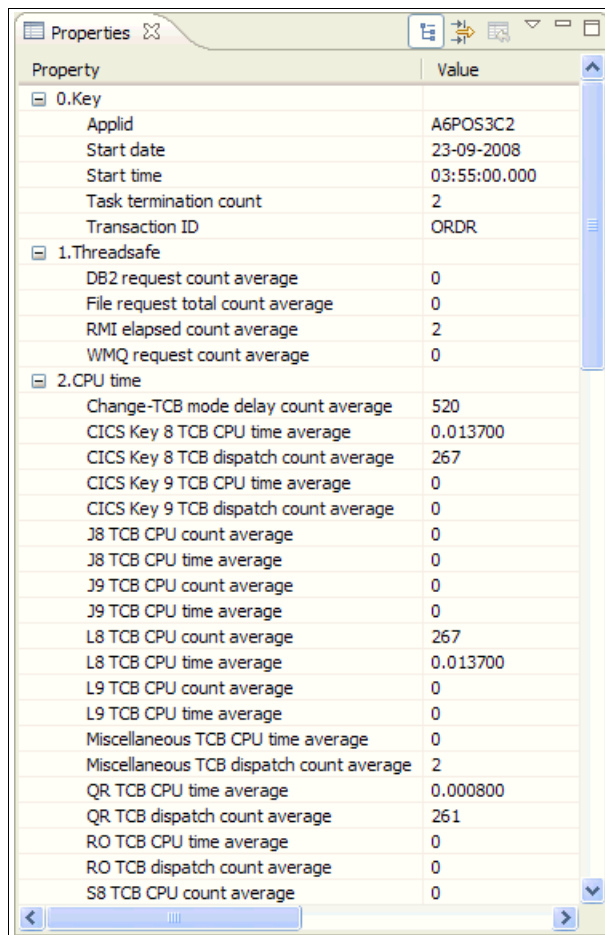

The screenshot shows the Eclipse Properties View for a transaction. The view is titled 'Properties' and contains a table with two columns: 'Property' and 'Value'. The table is organized into three main sections: '0.Key', '1.Threadsafe', and '2.CPU time'. The '0.Key' section includes properties like Applid, Start date, Start time, Task termination count, and Transaction ID. The '1.Threadsafe' section includes properties like DB2 request count average, File request total count average, RMI elapsed count average, and WMQ request count average. The '2.CPU time' section includes a large number of properties related to TCB CPU time and dispatch counts for various keys (8, 9, L8, L9, QR, RO, S8).

Property	Value
0.Key	
Applid	A6POS3C2
Start date	23-09-2008
Start time	03:55:00.000
Task termination count	2
Transaction ID	ORDR
1.Threadsafe	
DB2 request count average	0
File request total count average	0
RMI elapsed count average	2
WMQ request count average	0
2.CPU time	
Change-TCB mode delay count average	520
CICS Key 8 TCB CPU time average	0.013700
CICS Key 8 TCB dispatch count average	267
CICS Key 9 TCB CPU time average	0
CICS Key 9 TCB dispatch count average	0
J8 TCB CPU count average	0
J8 TCB CPU time average	0
J9 TCB CPU count average	0
J9 TCB CPU time average	0
L8 TCB CPU count average	267
L8 TCB CPU time average	0.013700
L9 TCB CPU count average	0
L9 TCB CPU time average	0
Miscellaneous TCB CPU time average	0
Miscellaneous TCB dispatch count average	2
QR TCB CPU time average	0.000800
QR TCB dispatch count average	261
RO TCB CPU time average	0
RO TCB dispatch count average	0
S8 TCB CPU count average	0

Figure 7-15 Properties View

7.3.7 Integrating with other plug-ins

The CICS Explorer provides contextual menus that are populated based upon what type of object is currently selected and what other plug-ins are currently loaded.

A single selection is represented by a row in the Sheet View, a column in a bar chart, and a detail view or a single transaction in the Project Explorer, which represents a single instance of a summary record and has specific information regarding the transaction ID and Applid. Consequently those parameters can be used as contextual parameters within the Interdependency Analyzer plug-in or the System Management plug-in, as indicated in Figure 7-16.

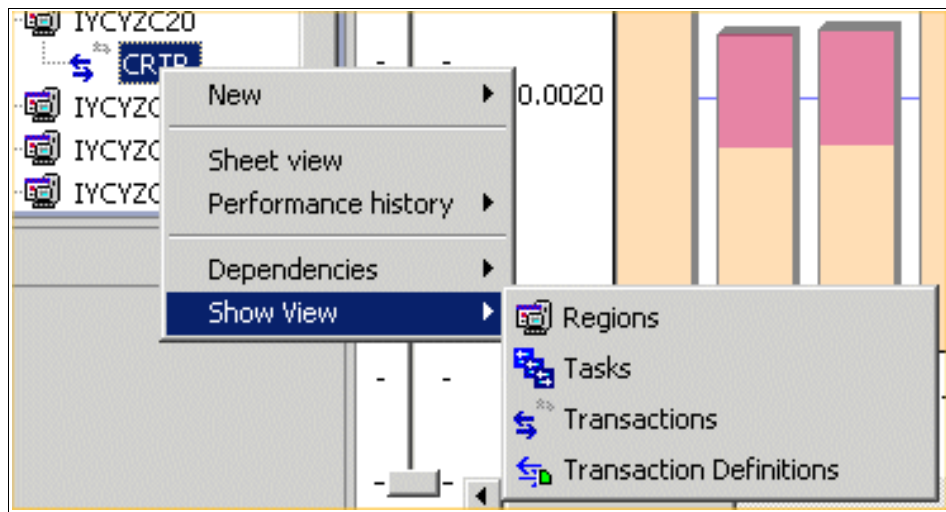

Figure 7-16 Contextual menus

Figure 7-17 on page 163 shows the dependencies.

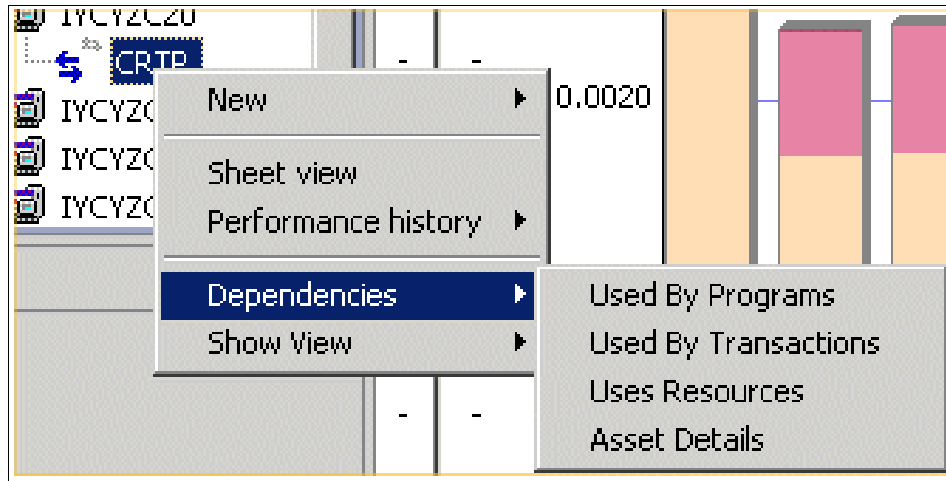

Figure 7-17 Dependencies

7.4 CSV data extraction process

In this section, we discuss the CSV data extraction process.

7.4.1 Server process

CICS PA provides report forms to enable a CSV data extract to be created using the Extract and Export option of the CICS PA Report Sets panel.

For CICS PA V2.1 users, a new Sample Summary Extract Report Form EXPLORE3 is provided by APAR PK71846.

For CICS PA V3.1 users, a new Sample Summary Extract Report Form EXPLORE4 is provided with the product.

When you create the CSV extract report, make sure that the Extract Format delimiter is set to a comma rather than the default semicolon. You can then download the CSV file to your workstation to be used within the CICS PA plug-in.

7.4.2 Plug-in process

You can load CSV data into the CICS PA plug-in using three ways:

- ▶ Copy and paste
- ▶ Drag and drop
- ▶ The import function of CICS PA plug-in

Other plug-ins: Using an application other than CICS PA plug-in to make changes to the CSV file might cause errors and make the data unusable by CICS PA plug-in.

Locate the performance data file that you want to analyze and follow one of the methods below to load the data into the CICS PA plug-in.

Using copy and paste

To copy and paste a file into PA Explorer:

1. Copy the data file by right-clicking and selecting copy from the menu.
2. In the Project Explorer view, select the folder where you want to store the data.
3. Right-click, and select **Paste** from the menu.

A copy of the data file is now in the CICS PA plug-in and available for analysis.

For further information about loading data and other Eclipse functions, see the Eclipse workspace User Guide.

Using drag and drop

To drag a file from your file manager and drop it into PA Explorer:

1. In your file manager, select the data file.
2. Use your mouse to drag the file across to the Project Explorer view.
3. Put the cursor over the folder where you want to store the data file, and release the mouse to drop the file into the folder.

A copy of the data file is now in the CICS PA plug-in and available for analysis.

Using the Import function

To import a file into PA Explorer from your local file system using the Eclipse import function:

1. Right-click anywhere in the white space of the Project Explorer view, and select **Import**.

2. In the Import dialog box, select **File System**. To assist in locating the file system, you can type File System in the text field. Click **Next**.
3. In the Import wizard, enter the directory path of the data, or click **Browse**, and select the directory from the list. All of the files in the directory are displayed in the Import wizard.
4. Select the data file to be imported.
5. In the Into folder text box, type the name of the folder where the data will be stored, or click **Browse**, and select the target from the list. Click **Finish**.

A copy of the data file is now in the CICS PA plug-in and available for analysis.

7.5 Database extraction process

In this section, we discuss the database extraction process.

7.5.1 Server process

CICS PA also enables SMF data to be loaded into a DB2 table by first loading the data into a Historical Database (HDB). From the HDB, you can export the data to a DB2 table or to a CSV file to use in the CICS PA plug-in.

The steps to Load CICS performance data from an SMF file into an HDB and exporting the data from an HDB file to a DB2 table or a CSV file are in Chapter 4 of the User's Guide for CICS PA Version 3.1. See *IBM CICS Performance Analyzer for z/OS User's Guide Version 3 Release 1*, SC34-7046-00 for more details.

7.5.2 Plug-in process

You can analyze CMF performance data that is produced by CICS Performance Analyzer for z/OS and stored in a database:

1. From the workspace menu bar, click **Window** → **Preferences**.
2. Click **IBM CICS Performance Analyzer** → **Data sources**. The Data sources dialog for CICS Performance Analyzer is displayed in the Preferences view. If it was pre configured, you see the connection details displayed; otherwise, the fields are blank. Figure 7-18 on page 166 shows the PA Data sources dialog, which contains sample connection details to a DB2 database.

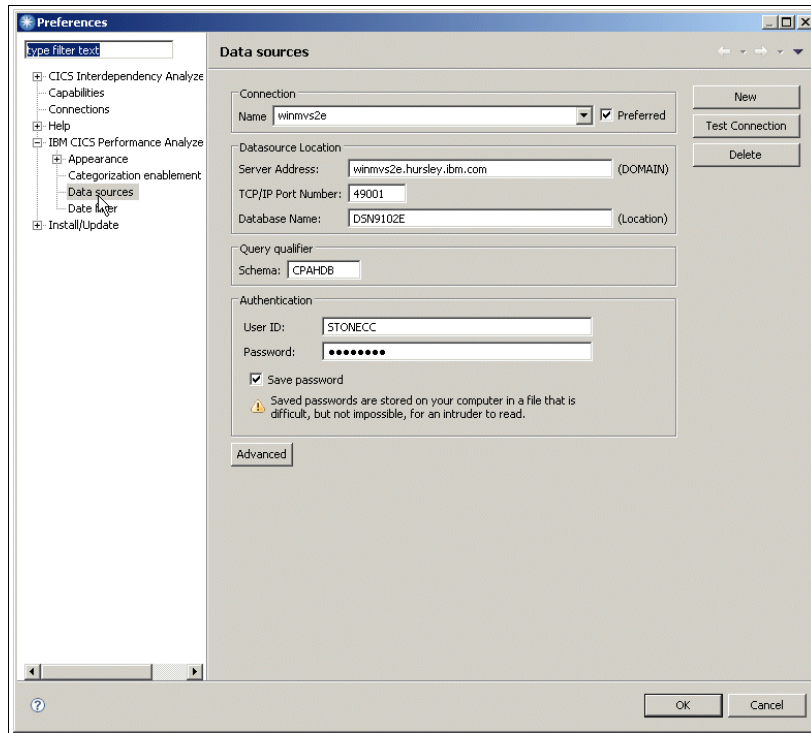

Figure 7-18 CMF performance data

3. Click **New** to create a new connection.
4. Complete the fields with the details that your system administrator provided. Table 7-1 provides a description of the fields.

Table 7-1 Option description

Option	Description
Name	The local name that is used to identify this database connection. The name can be anything you choose and is used only to help you distinguish between different database connections.
Preferred	Denotes the default data connection when accessing the plug-in from another plug-in.
Server Address	The TCP/IP host name of your database server.

Option	Description
TCP/IP Port Number	The port used to access the server.
Database Name	The name of the database on the server.
Schema (Qualifier)	The name of the schema that is used for the database.
Userid	Your authorized user ID for the database.
Password	Your password for the system. If you leave this field blank, you are asked to enter your password when the connection is attempted.
Save Password	Clicking this box saves your password on your computer.

5. Click **Apply** to save the configuration.

6. Click **Test Connection**.

When Test Connection is clicked CICS PA plug-in attempts to connect to the database that you configured. If you did not previously enter your password, you are asked to enter it now.

If the connection is successful, a message box opens at the bottom of the Data sources dialog showing the status, and you can now select data for analysis.

If the connection is not successful, the message box displays an error message that provides a reason for the failure. Check the values in the fields, correct any errors, and click **Connect** to test the corrections.

When the connection is successful, click **OK** to close the Preferences view.

If you did not click Apply, you can cancel the process and close the Preferences view without saving the new connection, by clicking **Cancel**. If you already clicked **Apply**, you must click **Delete** to remove the connection.

You can use the Data sources preference page to maintain multiple connections, which allows you to specify many different databases

Project Explorer CPA file definitions

To use the database table in the Resources View you must define the table based upon the database connection that you previously defined:

1. From the Project Explorer, select either a Project or Folder in which you want to create a link file.
2. Select **New** → **Other** (Shortcut Ctrl-n) to display Figure 7-19.

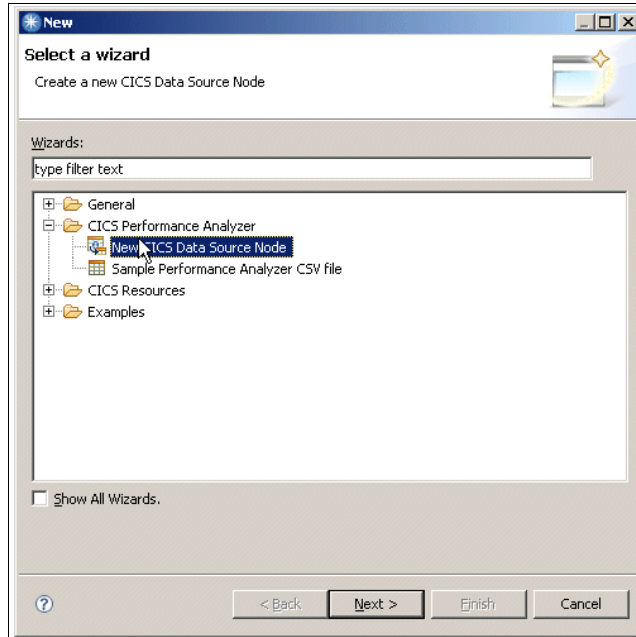

Figure 7-19 CPA file definitions

Figure 7-20 on page 169 shows the data source.

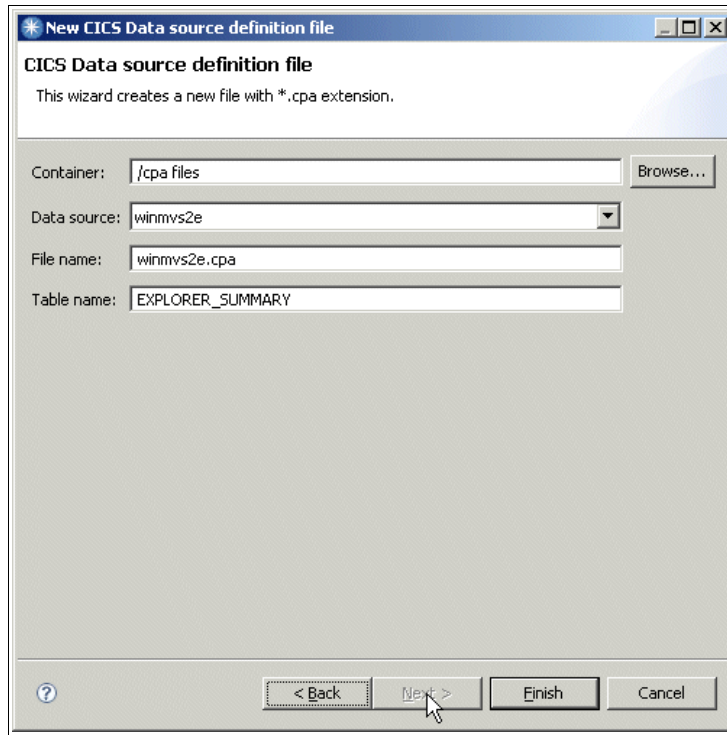

Figure 7-20 CICS Data source

3. Select New CICS Data Source Node, which displays Figure 7-21 on page 170 with default values populated, where available.
4. The Data source defaults to the Default Data Context but can be changed to another. The filename defaults to the data source with an additional cpa extension. The table name defaults to EXPLORER_SUMMARY in accordance with the server data extraction requirements.
5. Press **Finish**.

A link to the database table is now in CICS PA plug-in and available for analysis.

Click the Properties menu option on a cpa file (Alt-Enter shortcut) to access methods to alter some of these settings and test that the connection with the table works.

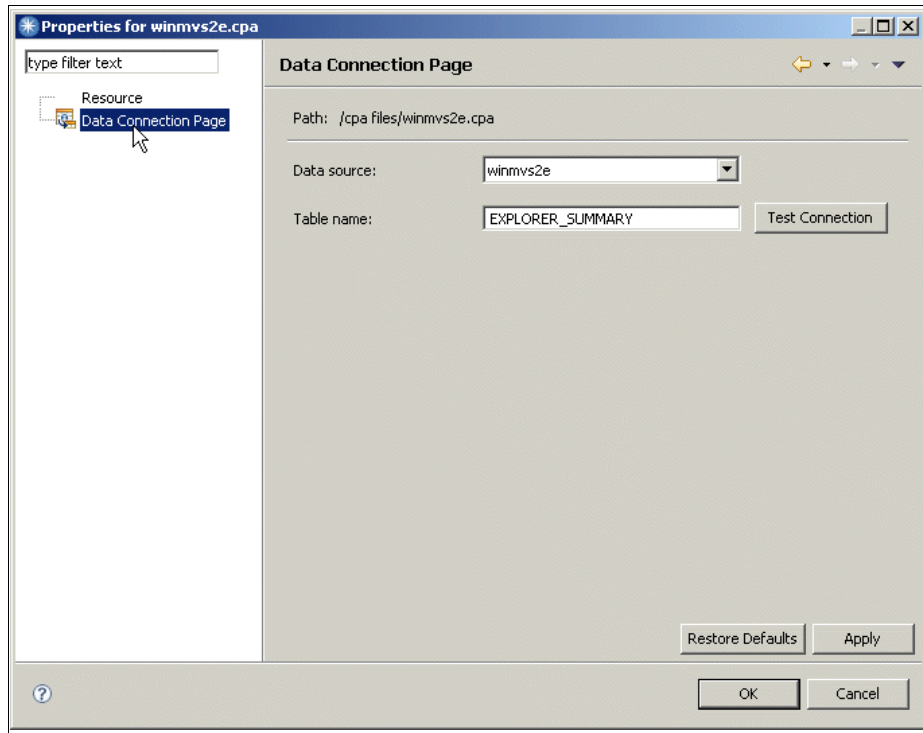

Figure 7-21 Properties

Default data context

It is important to note that when CICS PA plug-in is accessed from another plug-in, a default data context is used based upon the Data source that is specified as preferred. In addition, the table name must be described as EXPLORER_SUMMARY.



CICS Explorer troubleshooting

If a problem occurs with the CICS Explorer, you might be able to resolve it yourself. If you cannot resolve a problem yourself, you must gather the necessary documentation before contacting your IBM Support Center.

In this chapter, we describe where the CICS Explorer stores diagnostic data and how this data can be displayed or collected prior to calling IBM Support.

8.1 Workspace and logs

The CICS Explorer uses a folder, known as the workspace, to save all of its settings between user sessions and to store a log of its activity, including any errors that might occur.

On Microsoft Windows operating systems, the default CICS Explorer workspace is located at:

```
C:\Documents and Settings\\ .cicsexplorer
```

On Linux operating systems, the default CICS Explorer workspace is located at
/home/<username>/.cicsexplorer

If you are not using the default settings but are starting the CICS Explorer with the `-data` command line (or shortcut on Microsoft Windows operating systems) option to use an alternate workspace location, you should already know what workspace folder you are using.

The workspace folder contains, among other data, two logs:

- ▶ The Eclipse log is where errors, which are internal to the Eclipse platform that the CICS Explorer uses, can be recorded. It is contained in the file:

```
<workspace>/metadata/.log
```

This log is accessible from the UI (See 8.1.4, “Viewing the error log in an external application” on page 175).

- ▶ The IBM CICS Explorer’s own set of tracing files:

```
<workspace>/metadata/.cicsexplorer.trace.NN.log
```

Note: There might be up to 10 files like this one with NN=0 for the most recent to NN=9 for the oldest one and up to 1 MB in size each.

8.1.1 Capturing trace data

When the CICS Explorer is running it is constantly recording trace information in its trace buffers. If there is an unexpected failure, the CICS Explorer automatically writes the trace information out to the error log to help identify the cause of the failure. You can force the current information in the trace buffers to be written to disk using the **Explorer** → **Trace** → **Flush** menu option.

The tracing information is written to disk in the set of tracing files
<workspace>/metadata/.cicsexplorer.trace.NN.log.

Because the tracing facility is built using the standard Java logging API, the same tracing information can also be sent to a custom Handler, which you can achieve by launching the CICS Explorer with a command line (or shortcut on On Microsoft Windows operating systems), such as:

```
cicsexplorer -vmargs -Djava.util.logging.config.file=myfile
```

In the example, “myfile” is the name of a Java Properties file that is written according to the Java logging API.

The “myfile” configuration could, for instance, specify additional FileHandlers with different formatting or filtering than the default tracing; however, this is likely to have a detrimental performance effect if buffering is not adequate.

8.1.2 Tracing options

The default tracing granularity should be adequate, but it can be further enhanced.

1. Create a text file, and name it `.options`, in the same directory where the CICS Explorer executable file resides.
2. Inside the text file, add the lines that IBM service requests, as shown in Example 8-1.

Example 8-1 Options text file

```
#Example .options file for CICS Explorer
#
com.ibm.cics.core.ui/general=true
com.ibm.cics.core.ui/selection=false
com.ibm.cics.core.ui/draganddrop=false
com.ibm.cics.core.ui/resources=false
com.ibm.cics.core.ui/connection=false
com.ibm.cics.core.ui/adapters=false
com.ibm.cics.core.ui/preferences=false
com.ibm.cics.core.ui/decorators=false
com.ibm.cics.core.ui/properties=false
#
com.ibm.cics.core.model/general=true
com.ibm.cics.core.model/selection=false
com.ibm.cics.core.model/resources=false
com.ibm.cics.core.model/adapters=false
#
com.ibm.cics.core.ui.editors/markWithColors=false
com.ibm.cics.core.ui.editors/controls=false
com.ibm.cics.core.ui.editors/bindings=false
```

```
com.ibm.cics.core.ui.editors/propertysheet=false
com.ibm.cics.core.ui.editors/actions=false
#
com.ibm.cics.model/attributes=false
#
com.ibm.cics.sm.comm/general=true
com.ibm.cics.sm.comm/record=false
#
com.ibm.cics.sm.comm.cpsm/general=true
```

To use the .options file, start the CICSExplorer with the command line option **-debug**.

On Microsoft Windows operating systems, instead of using a command prompt window, you can append the **-debug** option to a shortcut created for the CICS Explorer executable.

Another alternative to specifying a command line option, on all the platforms, is to edit the cicsexplorer.ini file.

File backup: Saving a cicsexplorer.ini file that contains syntax errors or is missing essential options, can cause CICS Explorer to fail to start. Create a back up of the file before you edit it.

8.1.3 The Error Log View

The Error Log View displays information messages, warnings, and errors that the CICS Explorer logs. The underlying log file is where errors that are internal to the Eclipse platform that the CICS Explorer uses, can be recorded. It is contained in the file:

```
<workspace>/metadata/.log
```

The Error Log View is accessed from the **Window** → **Show View** → **Error Log** menu option.

The Error Log View is provided for information only. Figure 8-1 on page 175 shows information messages and error messages. The error messages are simulated for this example because typically the log does not contain errors. If the view contains errors, contact your IBM Service representative for advice.

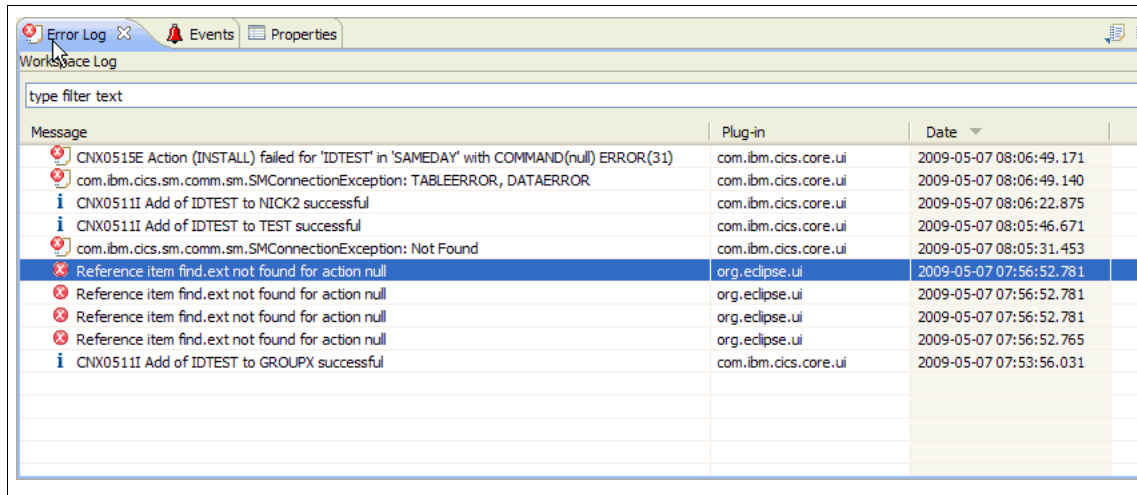

Figure 8-1 Error Log View

The CICS Explorer help contains a detailed description of the sorting, filtering, and export capabilities of the Error Log View.

8.1.4 Viewing the error log in an external application

You can view the Eclipse log in an external application, such as a text editor or a browser.

1. From the menu bar, click **Help** → **About IBM CICS Explorer**. The About IBM CICS Explorer window is displayed, as shown in Figure 8-2.



Figure 8-2 About IBM CICS Explorer

2. Click **Configuration Details**. The Configuration Details view is displayed, as shown in Figure 8-3.

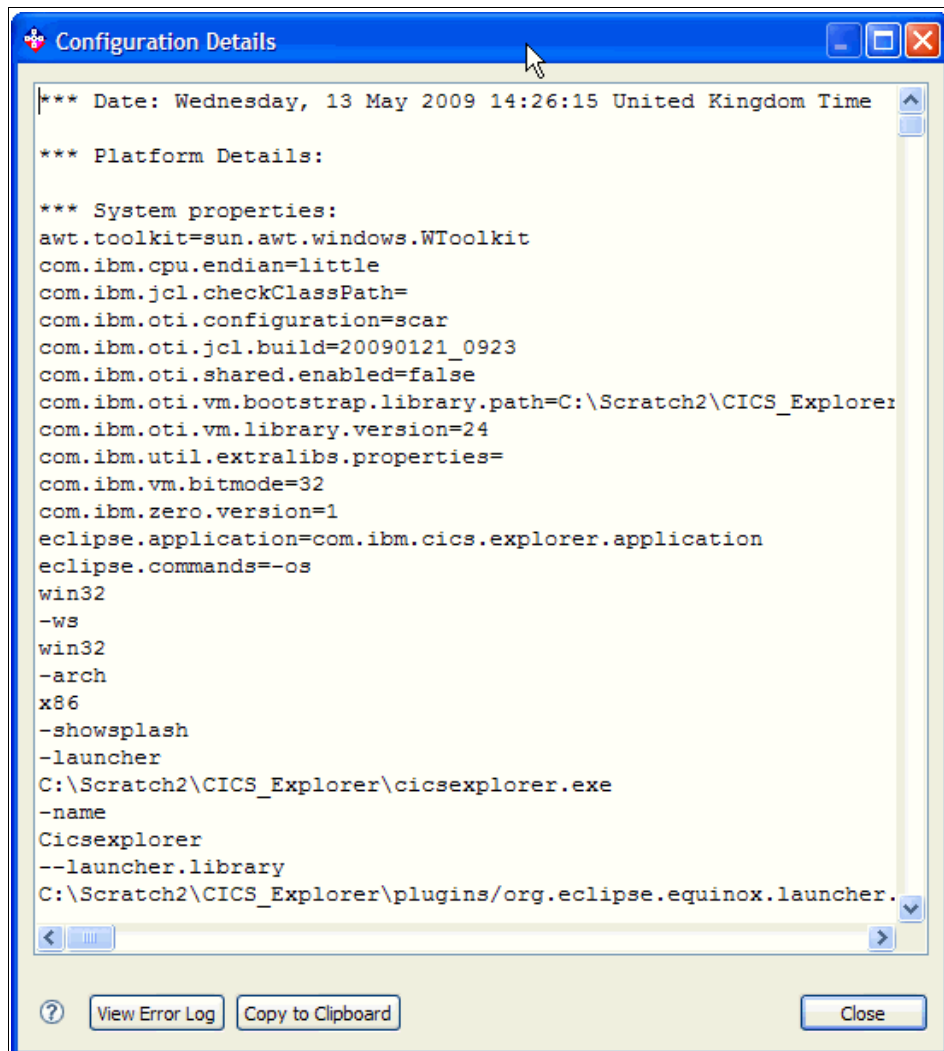

Figure 8-3 Configuration Details window

3. Click **View Error Log**. You are presented with a list of programs that can be used to open and display the log.
4. Select a text editor or browser from the list, and then click **OK**.

The Configuration Details is a comprehensive set of information about your CICS Explorer installation that can be of great help to IBM Service when an error report is submitted.

8.2 Preparing error data for IBM service

If you have a problem with the CICS Explorer, you might be asked to send the error logs and other information to the IBM service representative. The CICS Explorer collects all necessary error information in a single-compressed file that is ready for sending.

To prepare error data for IBM service:

1. From the workspace menu bar, click **Explorer** → **Trace** → **Collect Service Data**.
2. In the Save Service data as file dialog, select the location where you want to save the compressed file, and click **Save**.

The service data is saved as a compressed file. The filename is in the format CICSExplorerServiceData-20090701-080311.zip, where the numbers indicate the date and time of the collected data.

The zip file contains all of the diagnostic information that we described so far:

- ▶ Eclipse log
- ▶ CICS Explorer traces
- ▶ Configuration details

It also contains the CICS Explorer configuration settings, such as your defined connections and the set of columns to display in the resource views. It does NOT contain your saved passwords, which are stored encrypted on disk.

Remember to record the actions that you were performing at the time the failure occurred, which assists the IBM service representative if the problem requires further analysis.

8.2.1 Collecting error data when the CICS Explorer is not usable.

If you are unable to use the CICS Explorer user interface to collect service data, for example, because of a start up failure or because the user interface is unresponsive, you can at least create an archive file (for example in zip format on Microsoft Windows and in tar format on Linux) of all the traces, logs, and settings. This archive file does not include the comprehensive Configuration details that are available through the user interface.

Simply use an archiving utility to collect the directory content of your workspace location.

You might want to remove the file where the passwords are stored because although they are encrypted, they can be recovered:

```
<workspace>/ .metadata/ .plugins/com.ibm.cics.eclipse.common/com.ibm.cics
 .core.ui.secure_storage
```

If the user interface is up but hanging and unresponsive, creating a Java Thread Dump might be useful.

Creating a Java Thread Dump on Linux:

1. Find out the process ID of the CICS Explorer using any system tool, for example, from a shell (command line) enter:

```
$ ps -ef | grep cicsexplorer
```
2. From a shell, invoke `kill -QUIT <process_id>`, and a file named `javacore.YYYYMMDD.<other>.txt` is created in the CICS Explorer directory.
3. Add the file to the archive that contains the workspace data.

Creating a Java Thread Dump on Windows:

1. The CICS Explorer must have been started with the `-consolelog` parameter, which in addition to the graphical UI window, also opens a shell (command line) window only for output.
2. If a dump was not taken, enter the key combination CTRL-BREAK from that command line window to request a dump.
3. From the console log window, you will see a message that includes the location and name of the dump that you send to IBM, for example:

```
JVMDUMP010I Java dump written to C:\...\CICS
 Explorer\javacore.20090610.092732.6908.0001.txt
```
4. Add the file to the archive that contains the workspace data.

8.2.2 Searching for IBM MustGather information

The IBM support Web site contains additional documentation for preparing data for service. You can search the IBM Web site for “CICS Explorer MustGather”.

At the time of writing (July 2009) such a search returns these document links:

```
http://www.ibm.com/support/docview.wss?rs=1083&uid=swg21385862
http://www.ibm.com/support/docview.wss?rs=1083&uid=swg21385861
```

8.3 Plug-in specific issues

In this section, we describe special cases that affect the plug-ins.

8.3.1 Performance Analyzer

In this section, we discuss the Performance Analyzer.

CSV file corruption

It is critical that the csv file that is used in the PA plug-in was created by the PA runtime and was not modified in any way. Unfortunately, this includes a situation when a csv file is viewed using Excel. Excel restructures the time field in a manner that makes it relatively unusable by the PA plug-in. If when the application is closed Excel offers to save updates even though none were knowingly made, the file is corrupted and must be downloaded from the server again.

8.3.2 CSV file size and CICS Explorer runtime memory

The CSV file is held in java memory and is therefore restricted by factors that are external to the Explorer, including system memory. If you are using csv files, this might cause OutOfMemory Exceptions when an inadequate Java heap size is allocated. There is no hard rule to what needs to be allocated and many users find that the default maximum heap size is perfectly sufficient. However, it might be necessary in some circumstances to increase the value:

1. In a Windows or Linux command line, change the directory to the directory where the cicsexplorer.exe (cicsexplorer on Linux) file is located.
2. Start the CICS Explorer by typing the following command:
cicsexplorer -vmargs -Xmx512m
3. Alternatively, you can modify the cicsexplorer.ini file in the CICS _Explorer subdirectory to add the following information:
 - -vmargs
 - -Xms128m
 - -Xmx512m
4. Start the CICS Explorer as normal.



Part 2

CICS Explorer scenarios

In this part of the book, we review different scenarios where you can use the CICS Explorer to assist with problems:

- ▶ CICS Explorer - MQ application migration
- ▶ CICS Explorer clean up scenario
- ▶ CICS Explorer performance scenario
- ▶ CICSplex SM enablement using the CICS Explorer
- ▶ CICS Explorer resource manipulation scenarios



CICS Explorer - MQ application migration

In CICS TS V3.2, MQ calls are now run on the open L8 TCB; therefore, you must be aware of the MQ applications that you have and the implication of defining the programs as THREADSAFE.

In this chapter, we show how you can use the CICS Explorer and CICS Tools plug-ins to assist you in identifying MQ applications to migrate from CICS TS V3.1 to CICS TS V4.1. The same benefits can be obtained if migrating to CICS TS V3.2.

We use:

- ▶ The CICS IA and CICS CM plug-ins to identify MQ applications that can benefit from migrating to CICS TS V4.1.
- ▶ The CICS IA plug-in to investigate threadsafe requirements.
- ▶ The CICS PA plug-in to view before and after performance measurements.

We also show the integration between the plug-ins themselves and the base CICS TS Explorer.

9.1 Identifying MQ Applications

In this section, we use the CICS IA plug-in to identify programs and transactions that contain MQ commands.

We assume that you captured CICS IA data collector data with the 'Detailed' option on for 'Programs' and that we collected 'Command flow' detail for transaction MAIL.

For more information about data collection in CICS IA, refer to the *CICS IA V3.1 User Guide*, SC34-6992-00.

Before using the CICS IA Explorer plug-in, first ensure that you are connected to the CICS IA database. See 3.5, "Plug-ins" on page 55 in Chapter 3 Implementing CICS Explorer.

Selecting the IA perspective

To select the IA perspective:

1. After you are connected go to the CICS IA perspective, from the Explorer select **Window** → **Open Perspective** → **Other** → **CICS IA**. See Figure 9-1.

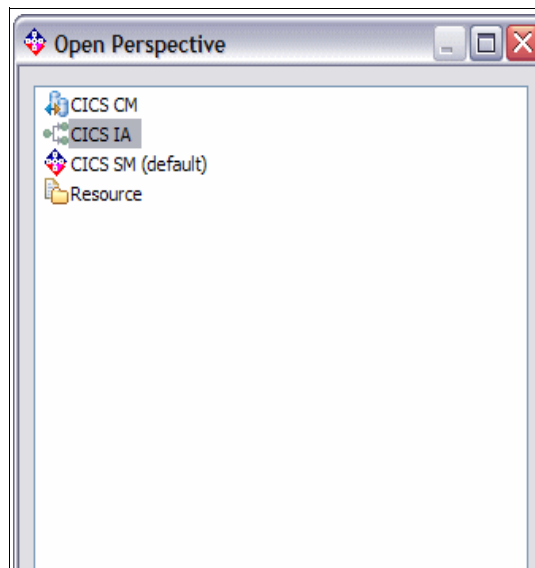

Figure 9-1 Open IA Perspective

2. In the IA perspective, create a new query to identify transactions and programs that use MQ resources. Select the **Queries** folder, right-click the MQ folder, and select **New** → **MQ Query**, as shown in Figure 9-2.

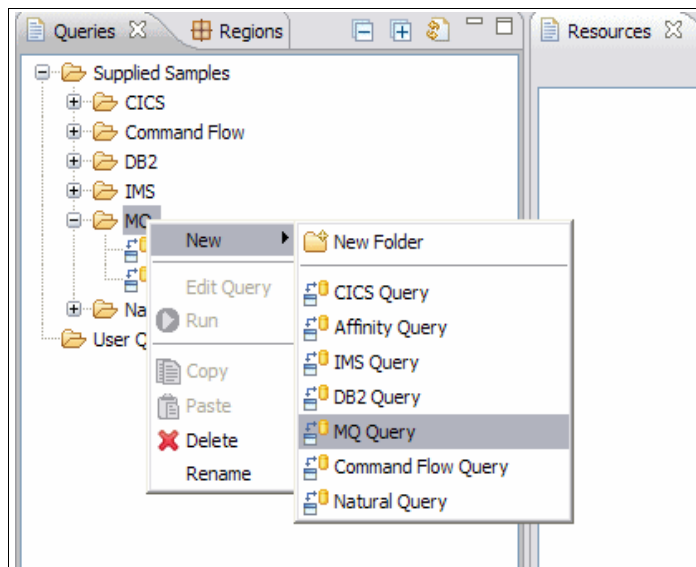

Figure 9-2 Create a new MQ query

3. Press Enter, and select the query name, the columns to show, and the filter criteria, as shown in Figure 9-3 on page 186.

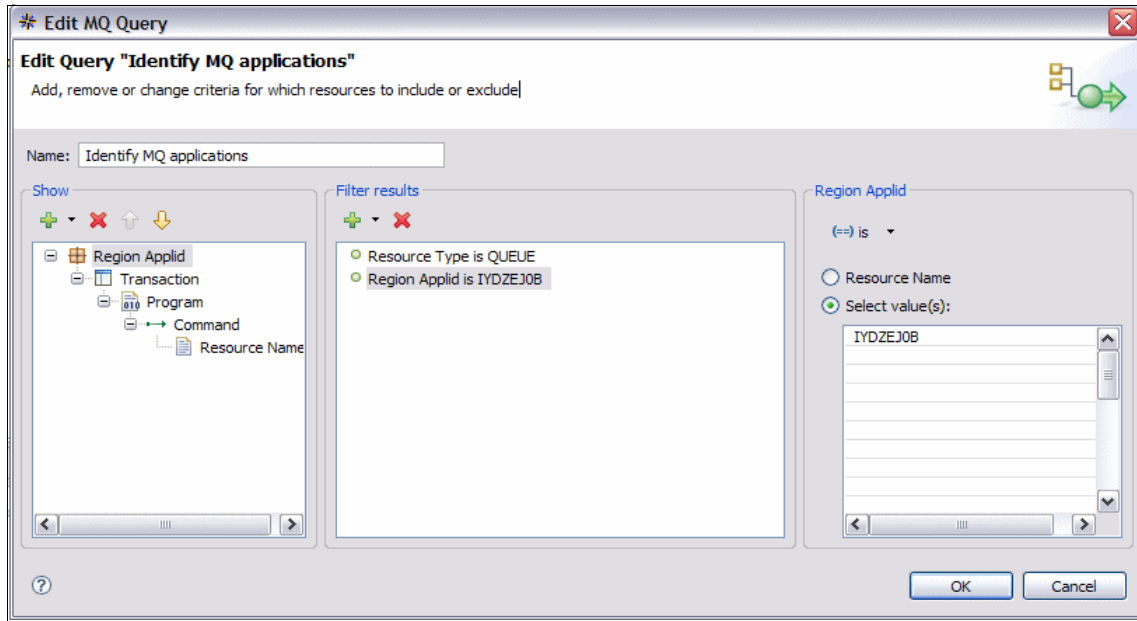

Figure 9-3 MQ Query edit panel

4. Select **OK** to save the query, and then run the query, as shown in Figure 9-4.

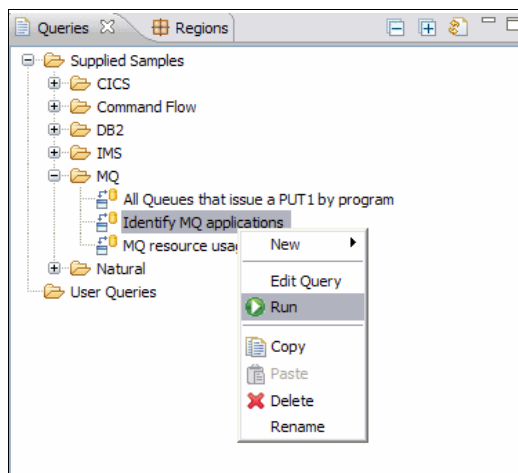

Figure 9-4 Run the MQ Query

The results of the query are shown in the resources folder, as shown in Figure 9-5 on page 187.

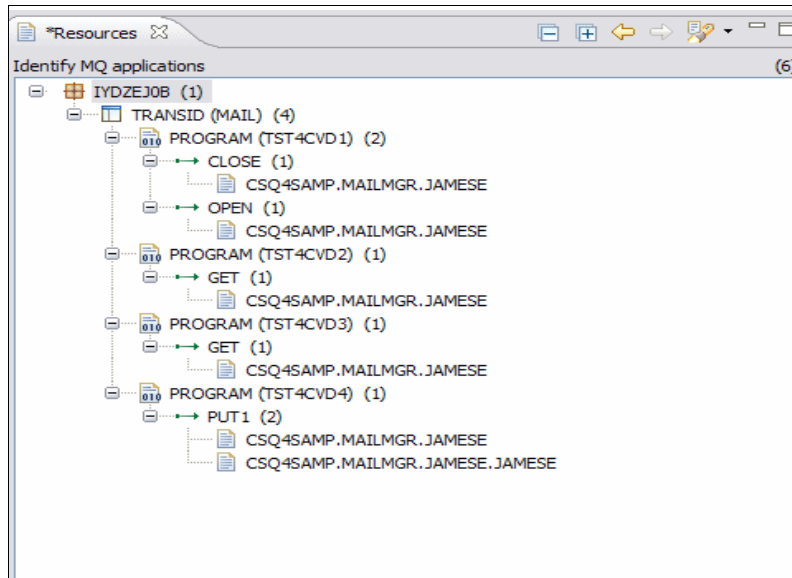

Figure 9-5 Results of the MQ query

We have one transaction, MAIL, in region IYDZEJOB. To migrate this transaction and the associated resources we must obtain more information before using the CICS CM plug-in.

9.2 Obtaining more information about the MAIL transaction

The CICS IA exits can collect detailed information about a number of resources, which include:

- ▶ CICS Applid
- ▶ Transactions
- ▶ Programs
- ▶ Exits
- ▶ TSqueues
- ▶ TDqueues
- ▶ Webservices
- ▶ Files

For more information about data collection in CICS IA, refer to the *CICS IA V3.1 User Guide*, SC34-6992-00.

To show the detailed information, we must turn on the Properties View. Select **Window** → **Show Property View**, as shown in Figure 9-6.

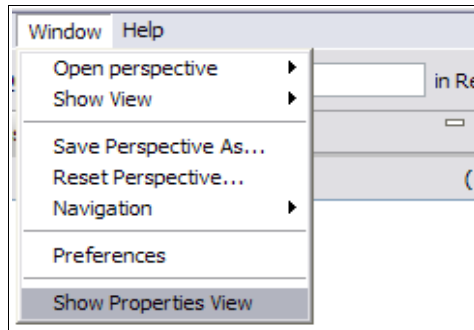

Figure 9-6 Select property view

A new view is displayed in your perspective and it is populated when ever you select a resource type for which detailed information is captured. In Figure 9-7, we selected the applid, IYDZEJ01.

The CICS region uses a CSD file called REDTOOLS.REDDEV31.DFHCSO, which we use later when we look at the CICS CM plug-in.

 A screenshot of the 'Properties' view in CICS Explorer. The view displays a table of properties for the resource type 'Region IYDZEJ0B'. The table has two columns: 'Property' and 'Value'.

Property	Value
Region IYDZEJ0B	
Aff coll lastsave	0001-01-01 00:00:00.0
Aff coll laststart	0001-01-01 00:00:00.0
Applid	IYDZEJ0B
Cics_release	0640
Csd group list1	DFHLIST
Csd group list2	
Csd group list3	
Csd group list4	
Csd name	REDTOOLS.REDDEV31.DFHCSO ...
Dep coll lastsave	2009-06-05 11:43:37.0
Dep coll laststart	2009-06-05 11:42:41.0
Homesysid	EJOB
Storage protect	INACTIVE

Figure 9-7 Detail view for APPLID IYDZEJ0B

We can also see the properties for a program, for example, in Figure 9-8 on page 189 we selected program TST4CVD1. For CICS TS V3.2 and above we show the Library database name and library.

Property	Value
Program TST4CVD1 in IYDZEJOB	
Program TST4CVD1 in IYDZEJOB	
Access	CICS
Applid	IYDZEJOB
Concurrency	QUASIRENT
Data location	ANY
Dynamic status	NOTDYNAMIC
Execution key	USER
Execution set	FULLAPI
Exit point	
First run	2009-06-03 16:01:14.636512
Hold status	TASKLIFE
Homesysid	EJOB
Install type	GROUPLIST
Language deduced	COBOL2
Language defined	COBOL
Last run	
Lib dataset name	
Lib name	
Load status	LOADABLE
Location	ESDSA
Module type	PROGRAM
Program attribute	REUSABLE
Program length	23904
Program name	TST4CVD1
Program type	PRIVATE
Program usage	APPLICATION
Remote definition	LOCAL
Remote progid	
Remote sysid	
Remote tranid	
Specified amode	NOTSPECIFIED
Specified rmode	NOTSPECIFIED

Figure 9-8 Program Properties View

We also must know what resources are used by transaction MAIL to migrate them to CICS TS V4.1:

1. Right-click the MAIL transaction, and select **Uses Resource** → **Specific region**, as shown in Figure 9-9.

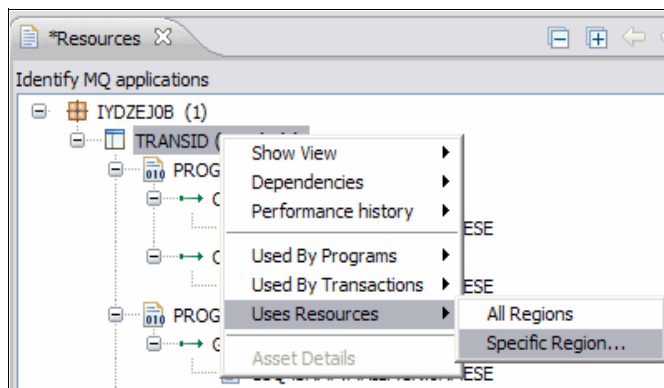

Figure 9-9 Show resource to transaction MAIL

2. Select region **IYDZEJOB**, as shown in Figure 9-10 on page 190.

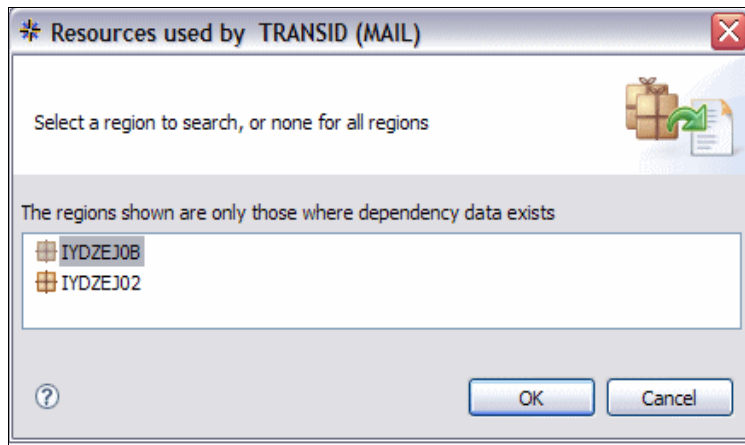

Figure 9-10 Select region IYDZEJOB

The results are shown in the Uses view, as shown in Figure 9-11 on page 191.

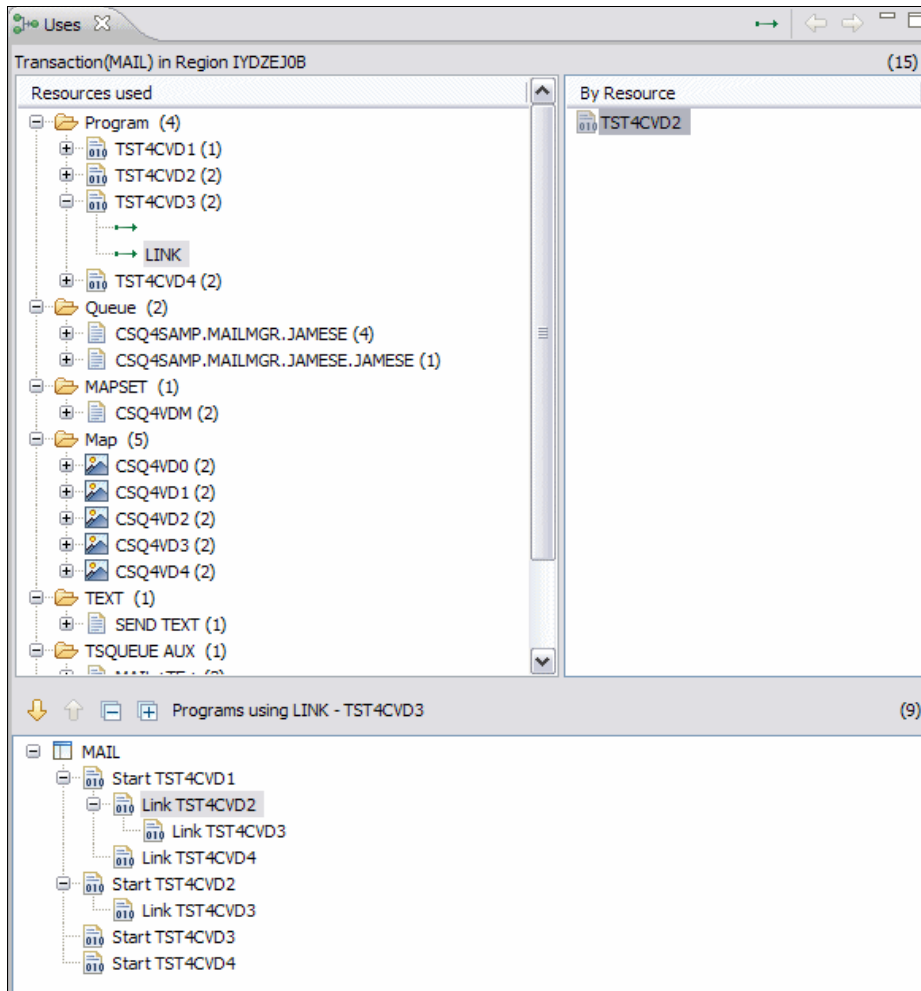

Figure 9-11 Resources used by transaction MAIL

Notice that there are a number of resources used by the MAIL application. For more information about how to navigate the Uses view, refer to Chapter 5, “CICS Explorer IA plug-in familiarization” on page 89.

We gathered the information that we require for using the CICS PA plug-in.

9.3 Locating the MQ Application in CICS CM

Now that we identified our MQ application, we can use the CICS CM plug-in to search for its resource definition. In this example, our application consists of:

- ▶ One transaction:
 - MAIL
- ▶ Five programs:
 - TST4CVD1
 - TST4CVD2
 - TST4CVD3
 - TST4CVD4
 - TST4CVD5

Before using the CICS CM Explorer plug-in, first ensure that you are connected to the CICS CM server. See 3.5, “Plug-ins” on page 55.

To locate the MQ Application in CICS CM:

1. Select the **CM perspective**, and from the Explorer select **Window** → **Open Perspective** → **Other** → **CICS CM**.
2. First we must select a configuration to work with. From CICS IA we know that the CSD in use is REDTOOLS.REDDEV31.DFHCSO. We must select this configuration in the CICS CM perspective. In the Configurations view, select the configuration for CSD REDTOOLS.REDDEV31, as shown in Figure 9-12.

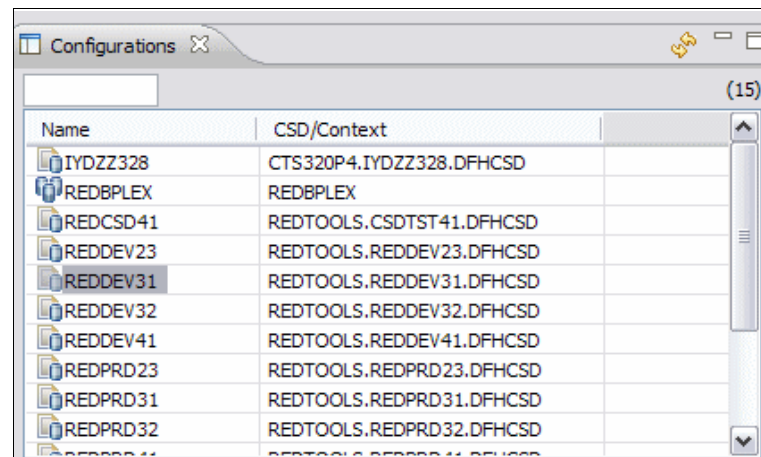

Figure 9-12 Select configuration

3. To search for a resource, click the torch in the top left corner of your perspective, as shown in Figure 9-13, and enter the resource name for MAIL.

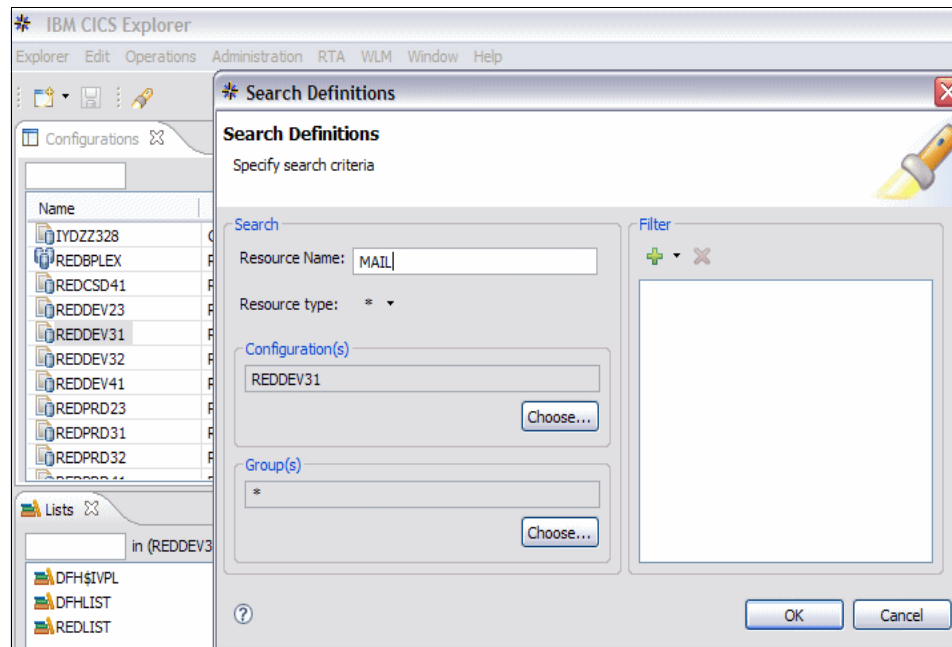

Figure 9-13 Search for MAIL

4. The results of the search are displayed in the Search Results. To show the group, click **Show Groups**, as highlighted in Figure 9-14. We can see that transaction MAIL is in MAILGRP.

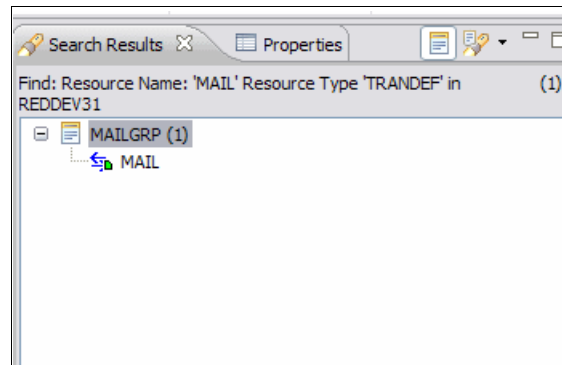

Figure 9-14 Results of the search

5. We now need to look at what other resources are stored in this group. Right-click the group, and select **Show all resources**, as shown in Figure 9-15.

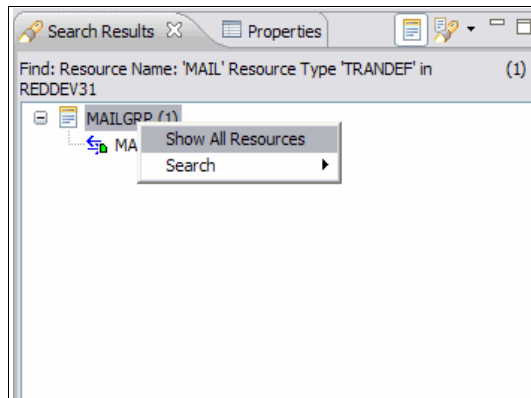

Figure 9-15 Show all resources for group MAILGRP

The results are shown in the same view, as shown in Figure 9-16.

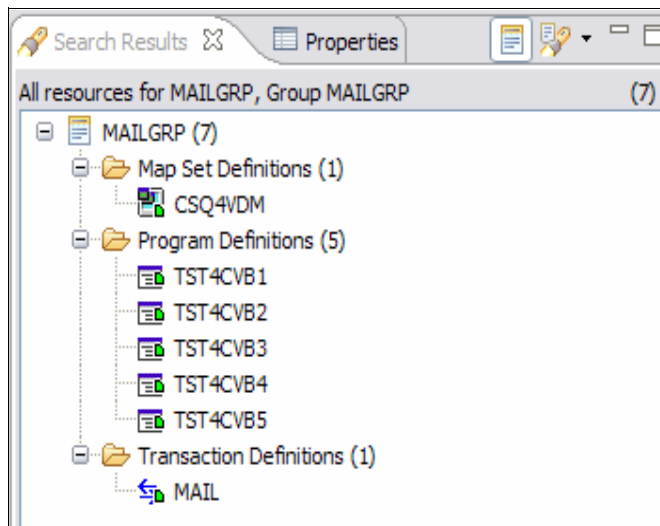

Figure 9-16 All resources in group MAILGRP

We have now established what resource group we need to migrate to CICS TS V4.1. We can now use the CICS CM ISPF to package and migrate this group to our CICS TS V4.1 development region. For more information about using change packages, refer to the *CICS CM User Guide*, GC34-7048-00.

9.4 Looking at performance data for the MAIL transaction

Before migrating the MAIL application, we used CICS PA to gather performance data on the CICS region REDDEV31. For more information about collecting CICS PA performance data, read the *CICS PA User's Guide*, SC34-7046-01.

9.4.1 Performance data for MAIL on CICS TS V3.1

For a given transaction, you can link to the CICS PA performance data from the IA or CM perspective. In the following example, we go from the CM perspective:

1. In the Search Results view, right-click the MAIL transaction, and select **Performance History** → **CPU Time**, as shown in Figure 9-17.

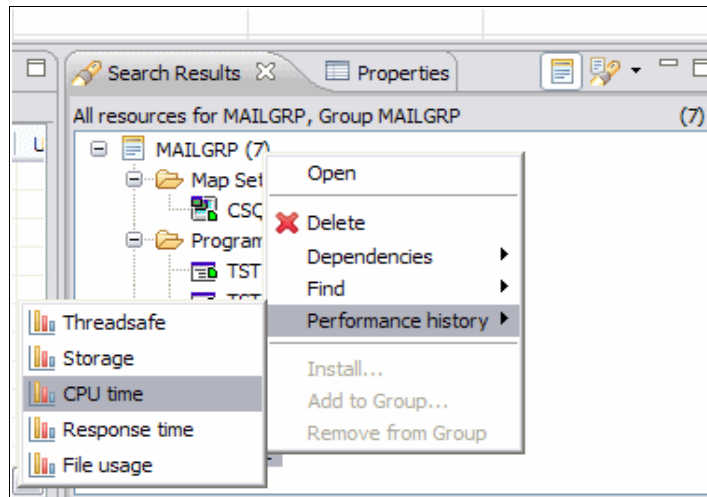

Figure 9-17 Link to Performance Data from CICS CM

2. A Restrict analysis time period is displayed. Select the date and time, as shown in Figure 9-18 on page 196.

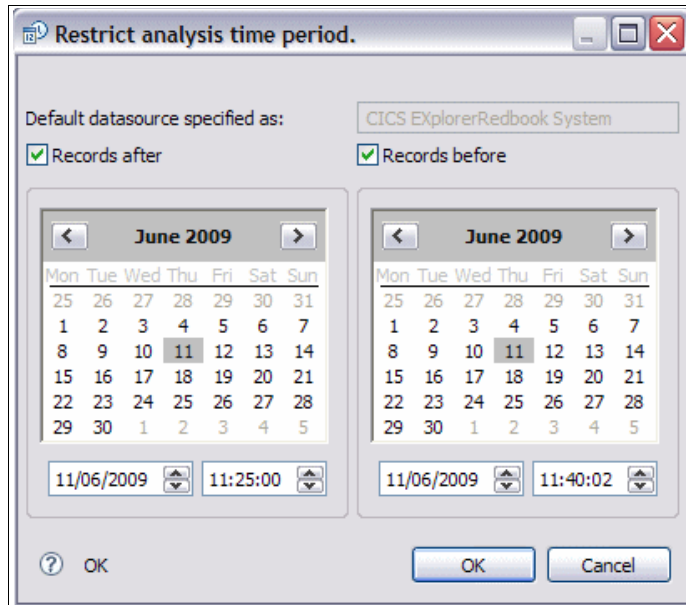

Figure 9-18 Select date and time options

3. After you select the time range, click **OK**. You should now see a graph similar to the one in figure Figure 9-19 on page 197.

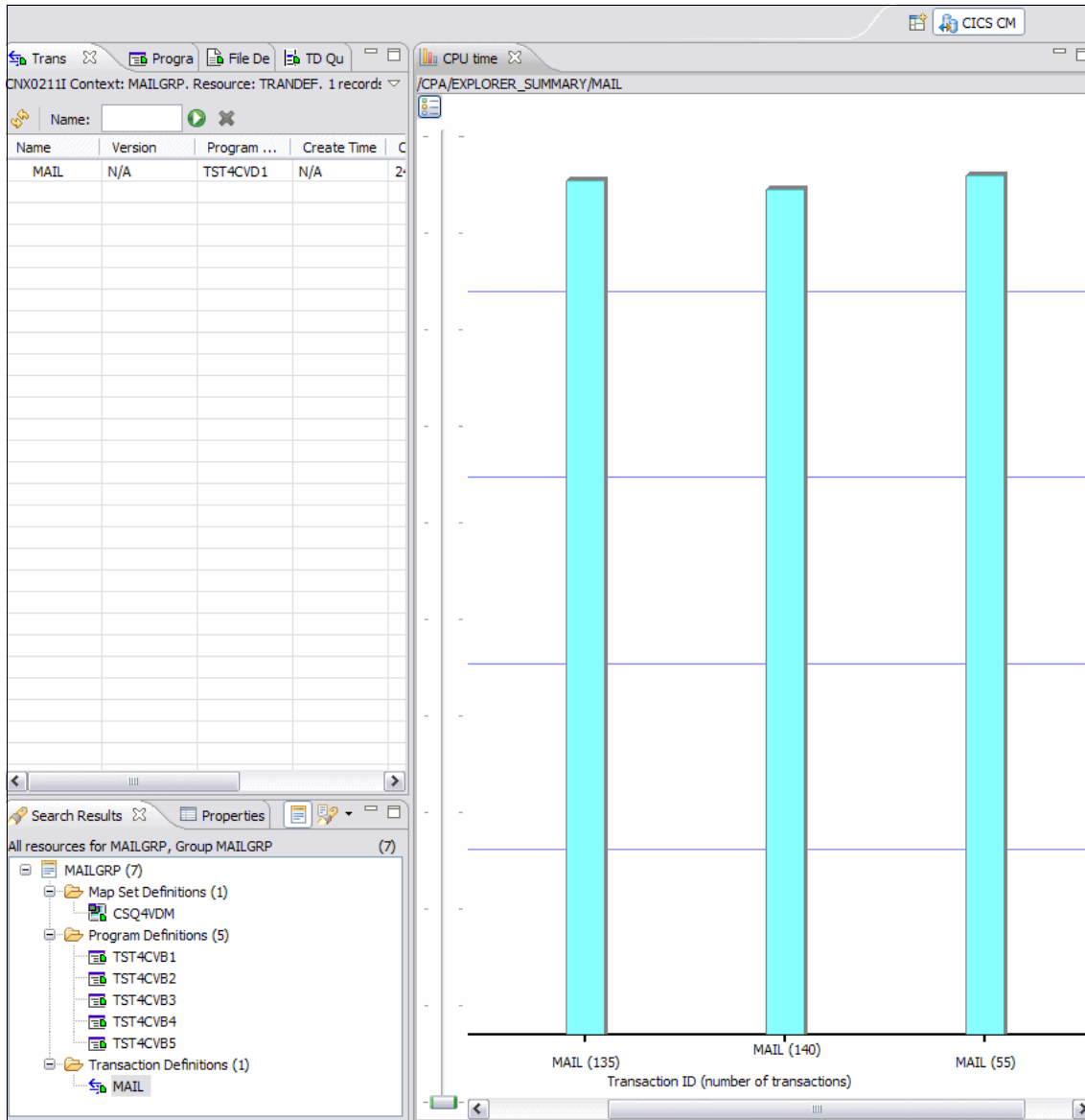

Figure 9-19 CICS PA CPU time for transaction MAIL in REDDEV31

- For more information, double-click any of the columns, and then maximize the view. Figure 9-20 on page 198 shows the Threadsafe report for transaction MAIL. As you can see from Figure 9-20 on page 198, you can choose other report types, such as CPU time or response times.

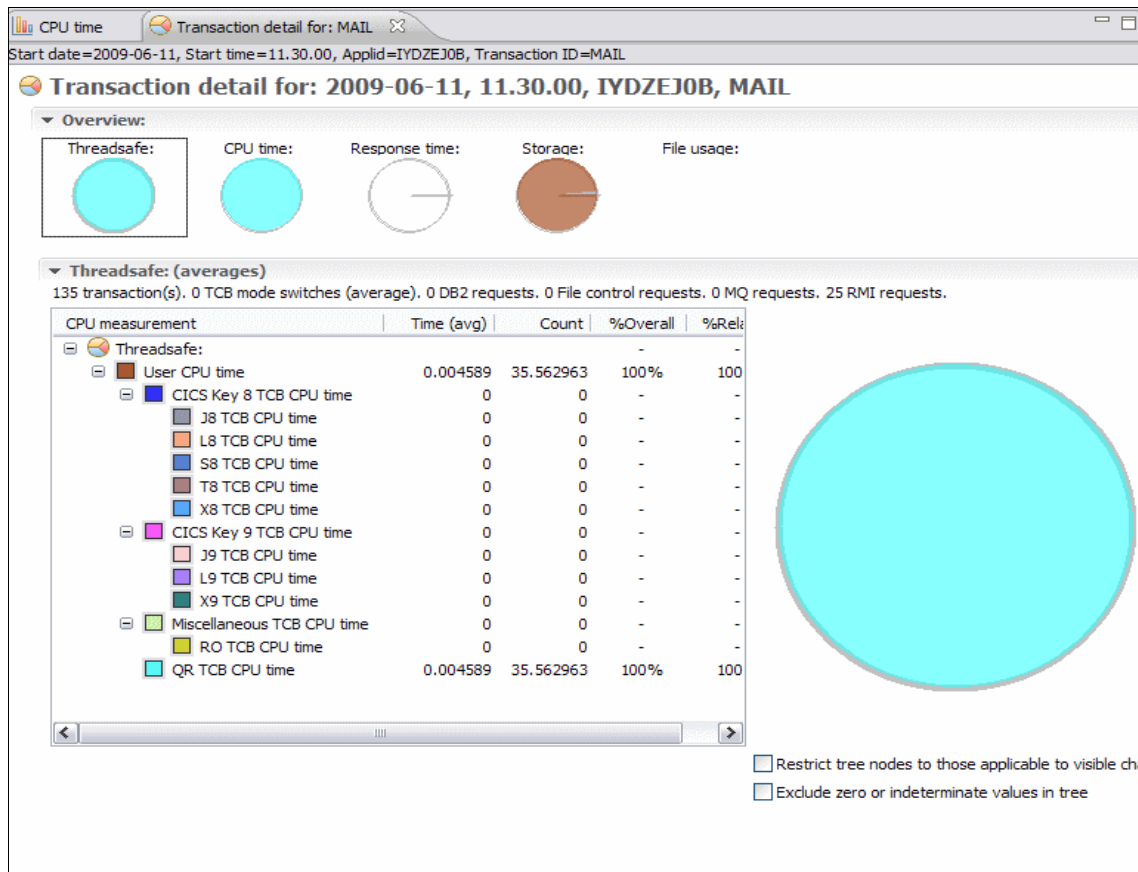

Figure 9-20 Detailed report for transaction MAIL in REDEV31

Notice that our MQ Mail transaction in REDEV31 runs in the QR mode only.

9.4.2 Performance data for MAIL on CICS TS V4.1

We migrated the MAIL application to CICS TS V4.1 on region REDEV41. We must collect new PA and IA data for this region.

For CICS IA, we also captured Command Flow data for transaction MAIL.

We now return to the IA perspective and look at the MAIL transaction in region REDEV41:

1. Select the IA perspective, and in the 'regions' folder, select the transactions used in region IYDZEJ02, as shown in Figure 9-21.

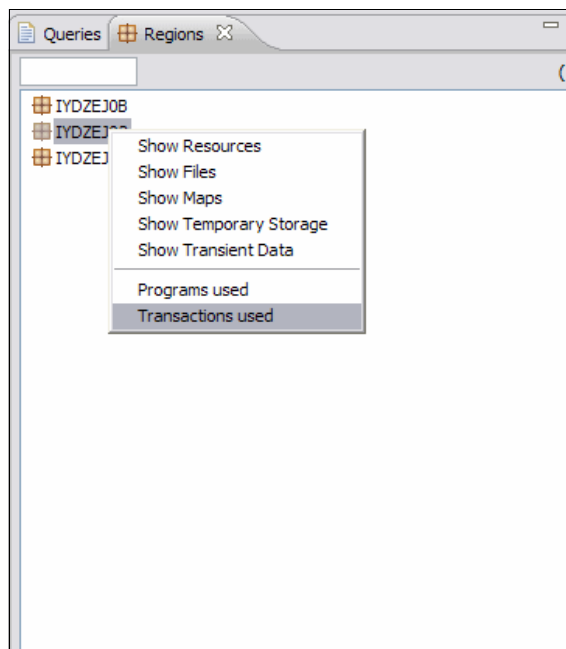

Figure 9-21 Select transaction in region IYDZEJ02

2. In the Transactions folder, in the input area enter M* to show only transactions that start with M*, as shown in Figure 9-22 on page 200, which also shows the properties for region IYDZEJ02. We can see that it is a CICS TS V4.1 region, and the CSD is called REDTOOLS.REDEV41.DFHCS.

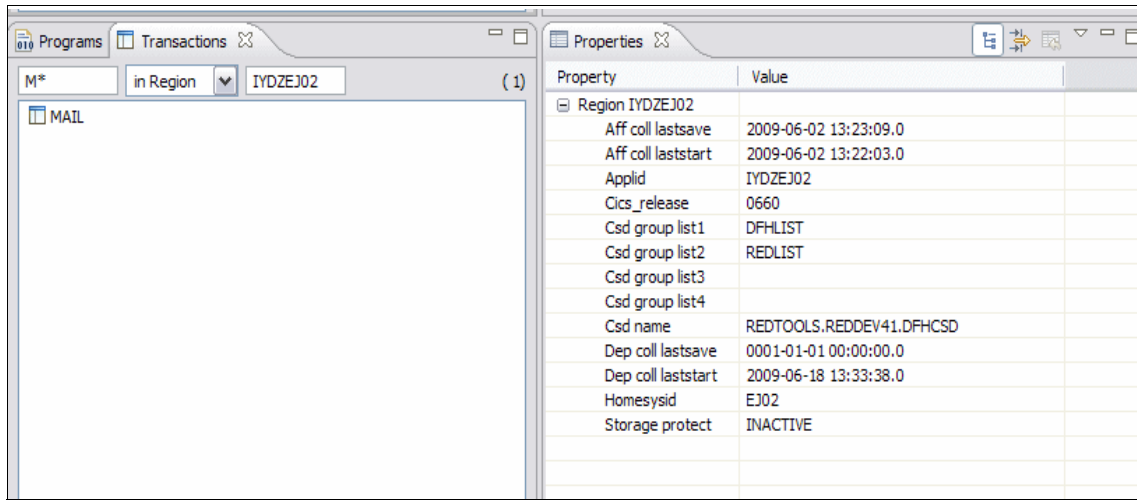

Figure 9-22 Transactions folder

- We now look at some CICS PA data for the MAIL transaction in region REDDEV41. This time we link from the IA perspective. Right-click the MAIL transaction, and select **Performance History** → **CPU time**, as shown in Figure 9-23.

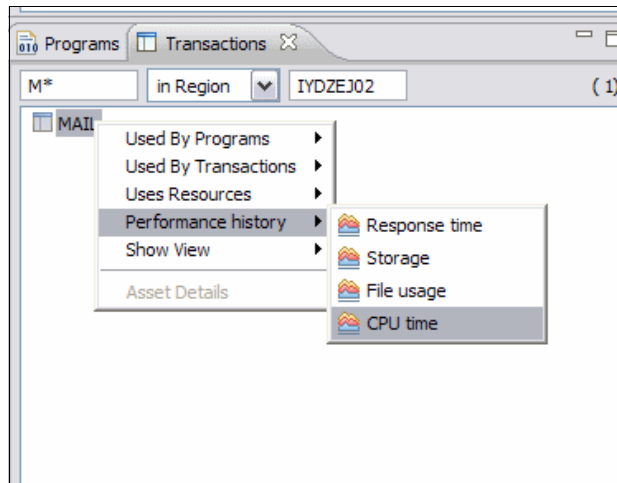

Figure 9-23 Show PA data for transaction MAIL in CICS TS V4.1

- Enter the date and time for the CICS PA collection in region REDDEV41, and then double-click the instance to obtain the threadsafe report, as shown in Figure 9-22.

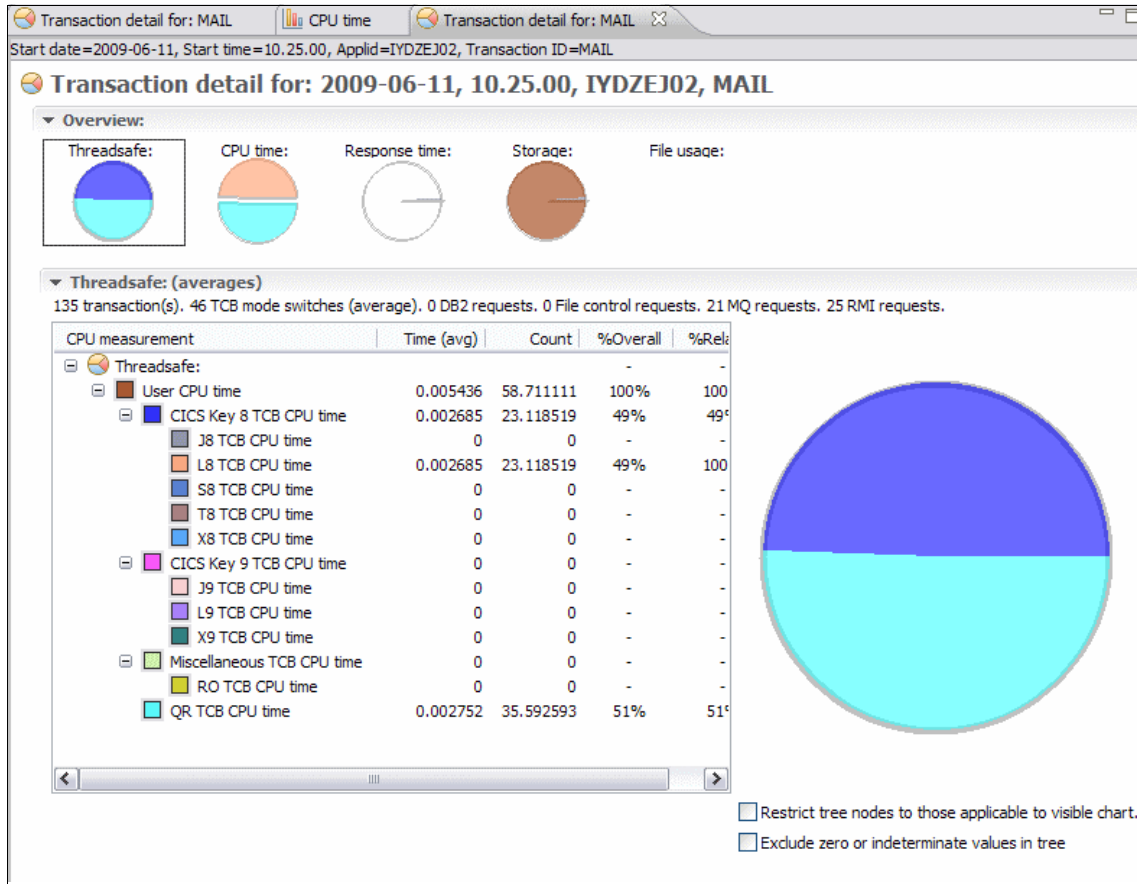

Figure 9-24 Threadsafe report for MAIL transaction in CICS TS V41

We can now see that the MAIL transaction spends nearly half of its time on an open L8 TCB, which reduces the time on the QR TCB.

We can also see 46 TCB mode switches. We now need to ask the following question:

Can we reduce the amount of TCB mode switches?

To answer this, we must understand the resources and commands that are issued by the MAIL transaction. We also must know how the transaction is currently defined.

9.5 Can we make the MAIL transaction threadsafe

First we obtain how the MQ programs that are associated with the MAIL application are defined. In particular, we are interested to see the ‘Concurrency’ value for the programs. We use the base CICS Explorer to look at the attributes of these programs:

1. Select the default CICS SM perspective. We explain how to connect to the base server in Chapter 2, “Getting started with CICS Explorer” on page 19.
2. In the CICS Explorer view, select region REDDEV41, as shown in Figure 9-25.

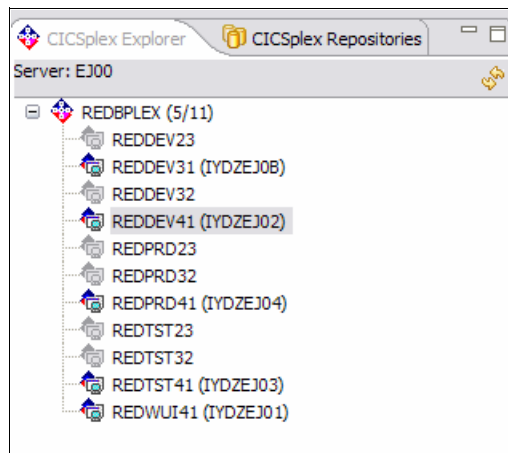
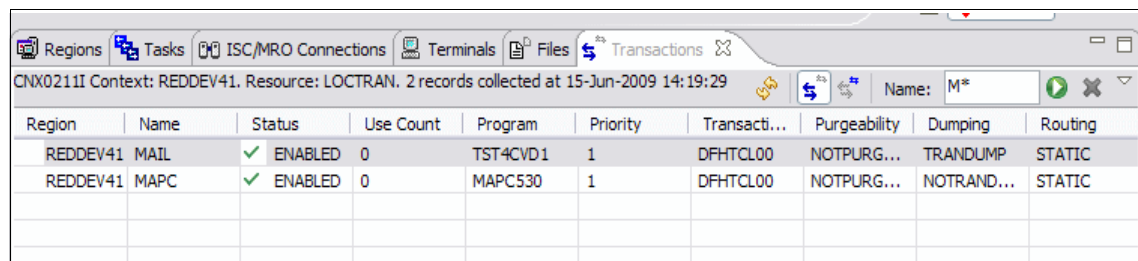

Figure 9-25 Select region REDDEV41

3. Select the transaction view with a filter of M*, as shown in Figure 9-26.

The screenshot shows the 'Transactions' view in CICS Explorer. The context is 'CNX0211I Context: REDDEV41. Resource: LOCTRAN. 2 records collected at 15-Jun-2009 14:19:29'. The filter is set to 'Name: M*'. The table below shows the details of the transactions.

Region	Name	Status	Use Count	Program	Priority	Transacti...	Purgeability	Dumping	Routing
REDDEV41	MAIL	✓ ENABLED	0	TST4CVD1	1	DFHTCL00	NOTPURG...	TRANDUMP	STATIC
REDDEV41	MAPC	✓ ENABLED	0	MAPC530	1	DFHTCL00	NOTPURG...	NOTRAND...	STATIC

Figure 9-26 Transaction view

4. Before looking at CICS IA data, we can look at the program attributes for program TST4CVD1. Right-click the entry for transaction MAIL, select **Open Related** → **Program**, as shown in figure Figure 9-27 on page 203.

Context: REDDEV41. Resource: LOCTRAN. 2 records collected at 15-Jun-2009 14:19:29

	Name	Status	Use Count	Program	Priority	Transacti...
V41	MAIL	ENABLED	0	TST4CVD1	1	DFHTCL00
V41	MAPC			MAPCE30	1	DFHTCL00

A context menu is open over the 'MAIL' row, showing options: Open, Open Related (with a sub-menu containing Program and Transaction Class), Discard, Enable, Disable, Dependencies, and Performance history.

Figure 9-27 Show program attributes

The program attributes are displayed, as shown in figure Figure 9-28 on page 204.

Property	Value
Basic	
API Status	CICSAPI
Average Load Time	00:00:00.000000
Basdefinever	0
CEDF Status	CEDF
CICS Release	E660
COBOL Type	NOTINIT
Concurrency	QUASIRENT
Concurrent Use Count	0
Current Location	NOCOPY
Data Location	ANY
DS Name	REDTOOLS.TESTAPPL.LOADLIB
Entry Point	FF000000
Execution Key	USEREXECKEY
Execution Set	FULLAPI
Fetch Count	0
Fetch Time	00:00:00.000000
Hold Status	NOTAPPLIC
Interval Use Count	0
JVM Class	
JVM Profile	DFHJVMPR
JVM Use Count	0
Language	COBOL
Length	0
Library	DFHRPL
Load Point	FF000000
Loading Rate	0.000
LPA Status	NOTAPPLIC
Mirror Transaction	
Name	TST4CVD1
NEWCOPY Count	0
NEWCOPY Status	NOTREQUIRED
Program Type	PROGRAM

Figure 9-28 Program details for TST4CVD1

We can see that the program is defined with a concurrency of QUASIRENT.

To ascertain whether we can define the programs that are associated with MAIL as THREADSAFE, we can now use CICS IA:

1. We can link to the CICS IA data and view resources that are used by this transaction from the Transaction view. Right-click the transaction mail, and select **Dependencies** → **Uses Resources**, as shown in figure Figure 9-29 on page 205.

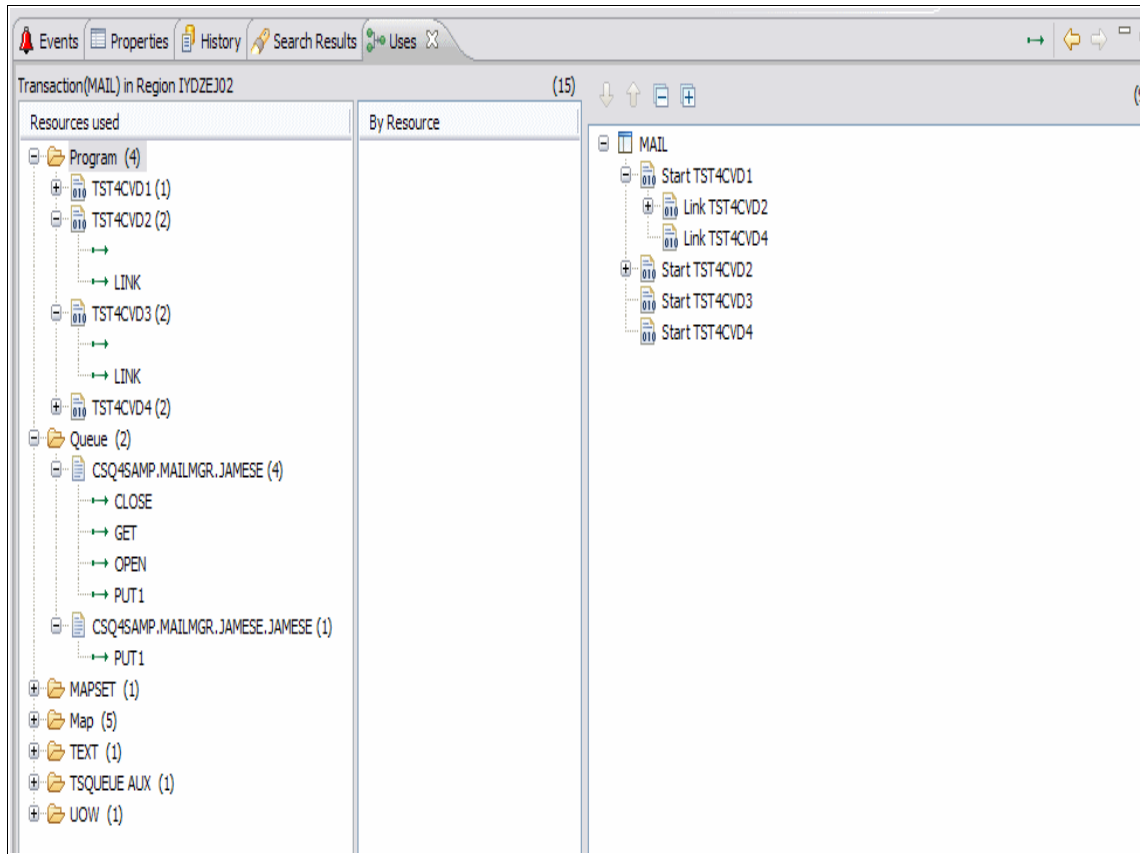

Figure 9-30 CICSIA resource view in the CICS SM perspective

In the case of the MAIL application, we can see that it consists of only four programs, as shown in figure Figure 9-31 on page 207.

We can see from Figure 9-31 on page 207 that there are no CWA, EXIT, or STORAGE resources.

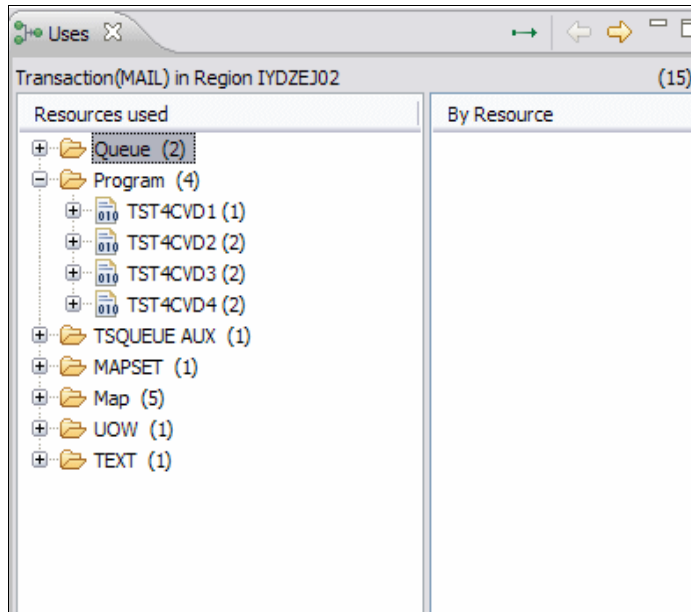

Figure 9-31 Programs used

We can fully expand the program calls to look for any LOAD commands, as shown in Figure 9-32. You see that some of the programs have a 'blank' command that indicates that the program was started as a result of a transaction start, and the transaction was MAIL.

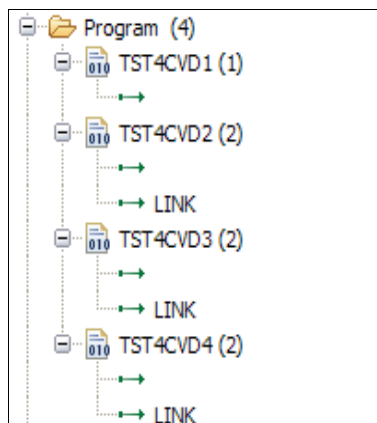

Figure 9-32 Program commands

So by exploring the MAIL transaction, we can ascertain that it is a good candidate to be made threadsafe because it contains MQ commands, and it has no shared resources.

In the next section, we use the CICS PA plug-in to review the performance data after making the MAIL programs THREADSAFE.

Using the CICS IA Command flow feature

In CICS IA V3.1, we provide a new feature to capture CICS API and APIs, MQ calls, IMS calls, and DB2 calls in chronological order. For information about how to capture command and load command flow data, refer to the CICS IA User Guide. To use the CICS IA Command flow feature:

1. From the Transactions folder, right-click the MAIL transaction, and select **Show Command Flow runs**, as shown in Figure 9-33.

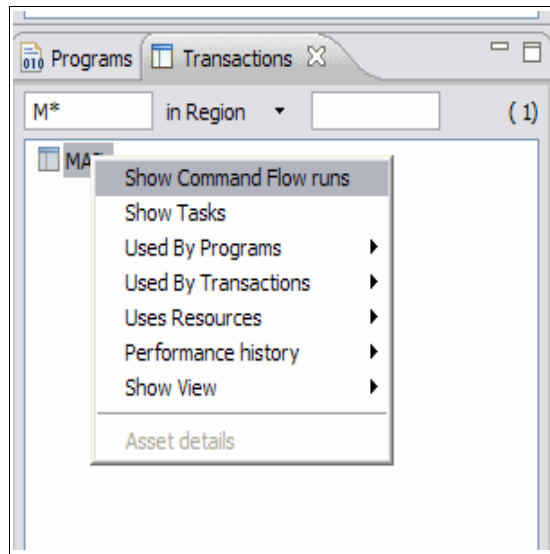

Figure 9-33 Select Command Flow runs

2. The Resources View is populated. Expand the tree for MAILTS41, as shown in Figure 9-34 on page 209.

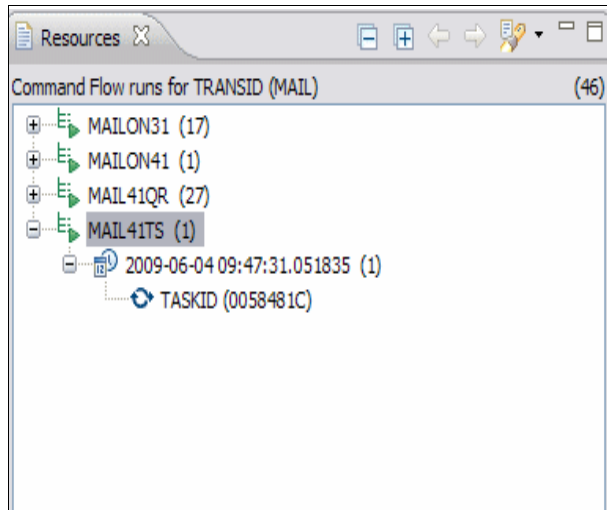

Figure 9-34 Command Flows for transaction MAIL

- Right-click the TASKID, and select **Show Execution**, as shown in Figure 9-35.

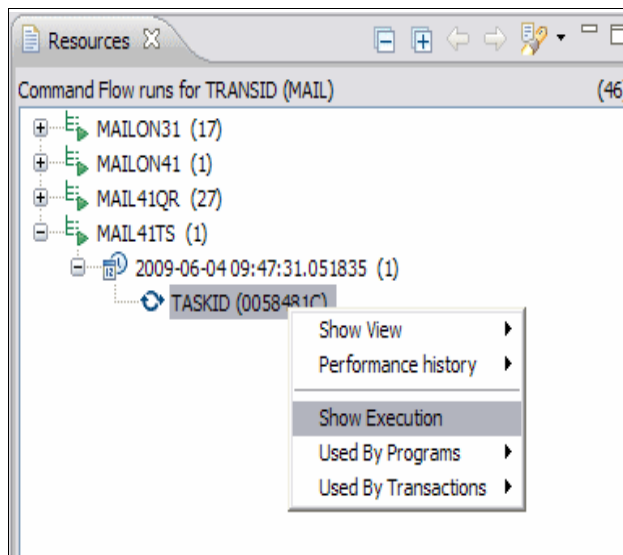

Figure 9-35 Select Show Execution

A new Command Flow view is opened, as shown in Figure 9-36 on page 210.

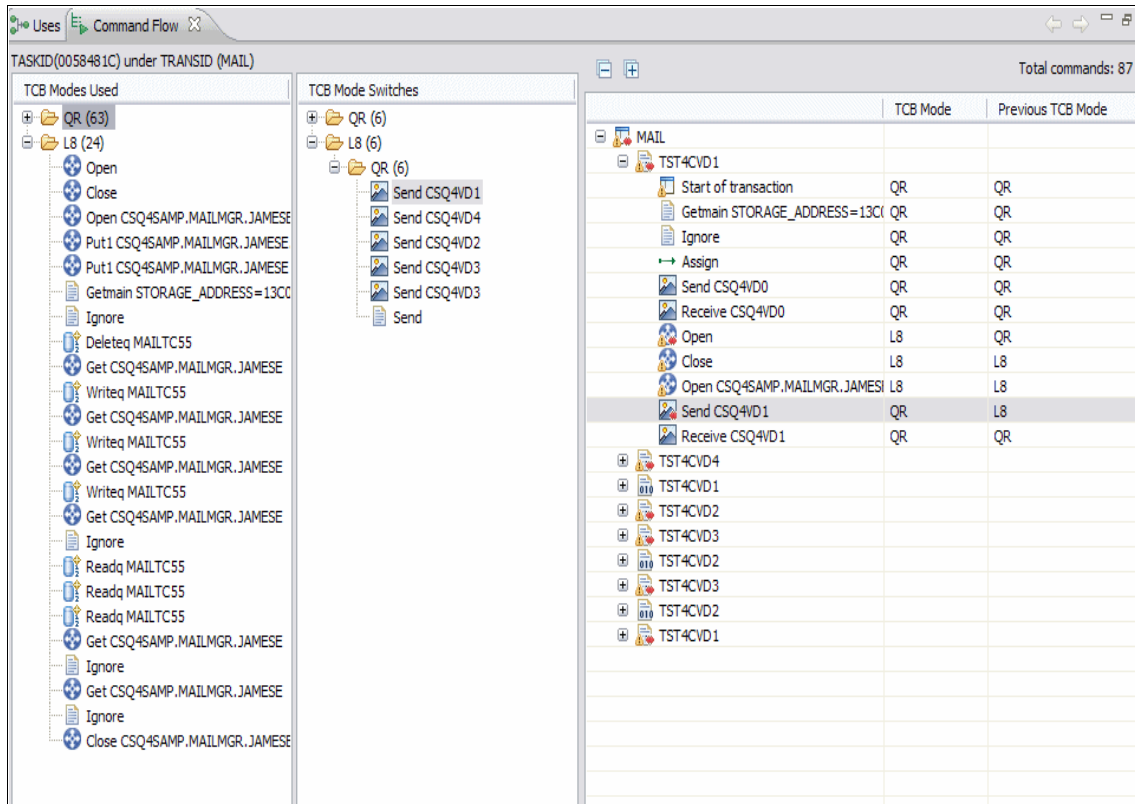

Figure 9-36 Command Flow view

The Command Flow view, Figure 9-36, consists of three sections:

- ▶ The left most section shows the commands that the TCB Modes use. In Figure 9-36, we show the commands used in the 'L8' TCB.
- ▶ The middle section shows the commands that cause a TCB switch. In this case, we are looking at the commands that caused a switch from L8 back to QR. We can see that these are SEND maps and text.
- ▶ The third right most view shows the execution tree itself. We can see here that transaction MAIL starts program TST4CVD1. If we select a command in either of the other views, it highlights this command in the execution tree. In this example, we selected the SEND CSQ4VD1 command in the TCB Mode Switches view. Notice in the execution tree that this SEND MAP occurs after an MQOPEN is running on TCB 'L8'.

9.6 Using CICS PA to analyze the (threadsafe) MAIL application

We use the Resource perspective to look at data stored in CSVs. You can store your data in a DB2 database. For more information about setting up the CICS PA data, refer to Chapter 7, “CICS Explorer PA plug-in familiarization” on page 147.

1. The CICS PA performance data collected after making the MAIL application threadsafe is stored in the REDTOOLS.MAIL41TH.CSV. We select this CSV file, as shown in Figure 9-37.

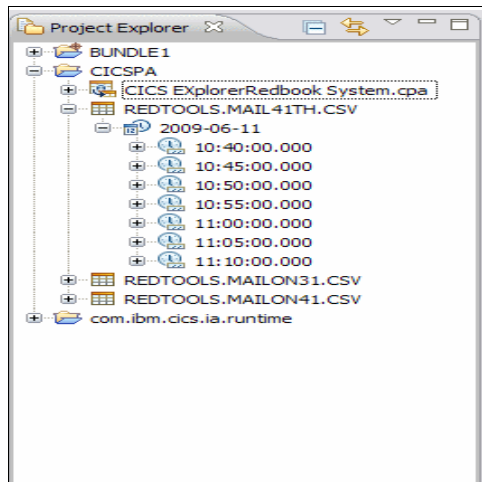

Figure 9-37 Select CSV file

You can expand each time slot further by region and the transaction, as shown in Figure 9-38 on page 212.

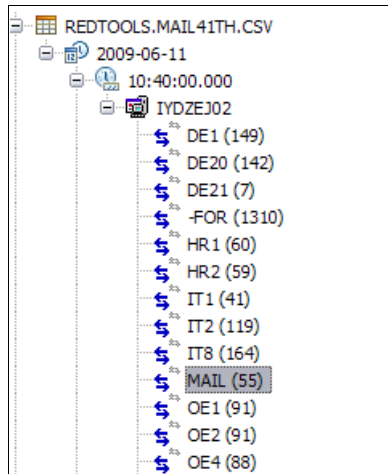

Figure 9-38 Select time and transaction

2. Select a CICS PA 'CPU time' report. Right-click the MAIL transaction, as shown in Figure 9-39.

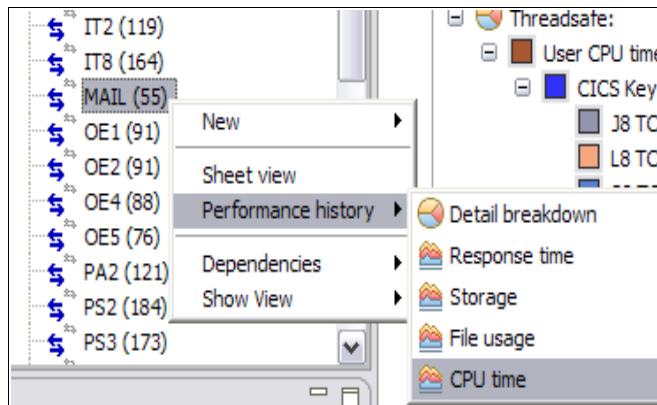

Figure 9-39 Select CPU time report

A new folder for the 'CPU time' report is displayed, as shown in Figure 9-40 on page 213.

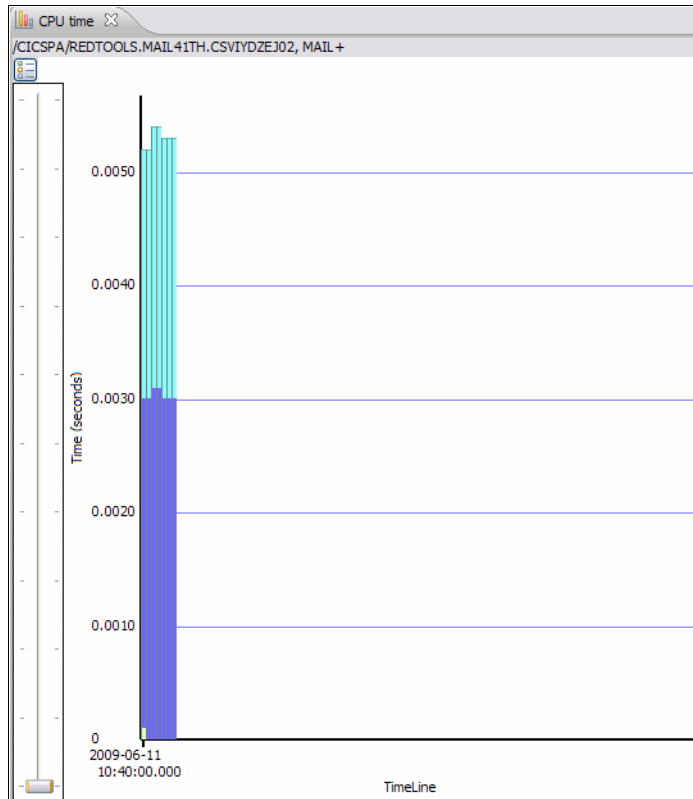

Figure 9-40 CPU Time report for MAIL

3. For more information about a particular instance, right-click an entry, and select **Detailed breakdown**, as shown in Figure 9-41.

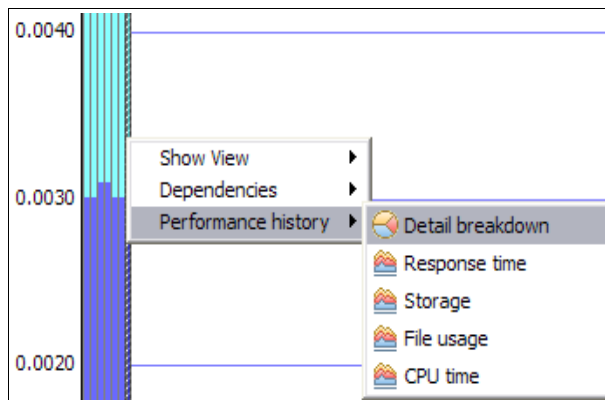

Figure 9-41 Select Detailed breakdown

The Detailed breakdown shows us the 'Threadsafe' chart for the MAIL application after it is made threadsafe, as shown in Figure 9-22 on page 200.

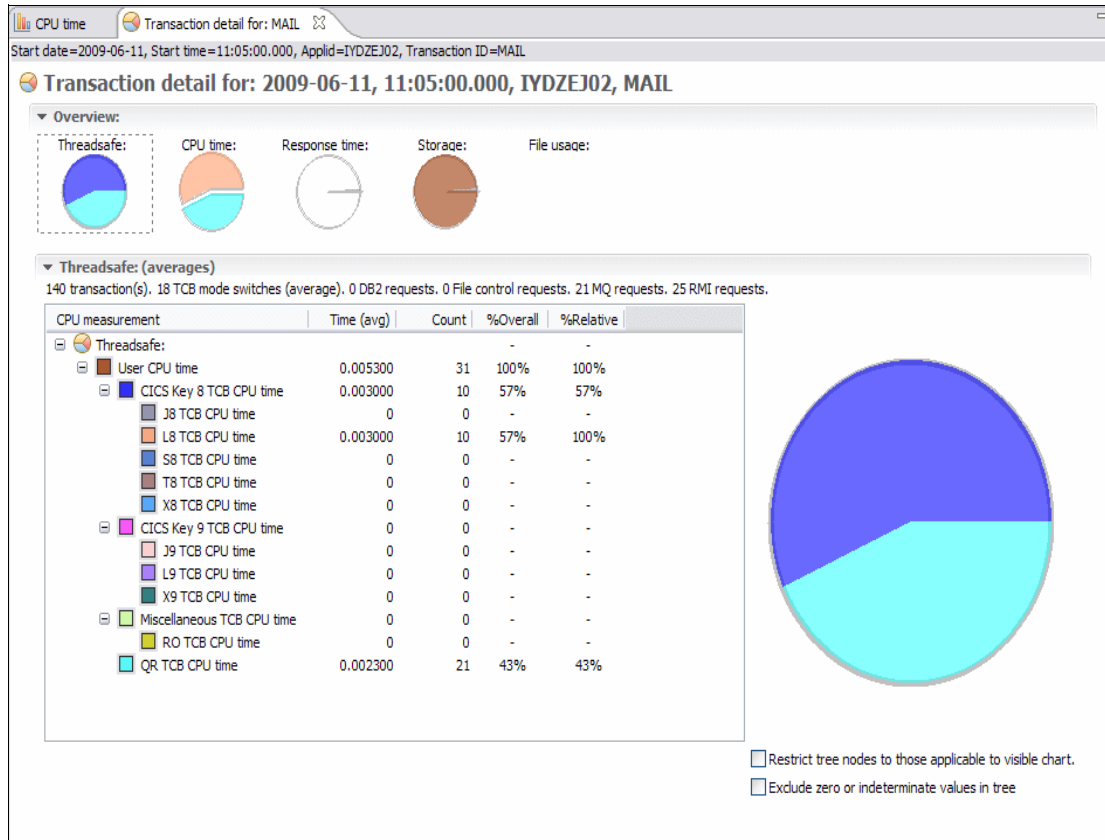

Figure 9-42 Threadsafe chart for transaction MAIL

We can see from this chart that by making the MAIL programs threadsafe, we reduced the number of TCB switches from 46 to 18. We can also see that the application spends more time on the open L8 TCB, which frees up the QR TCB.



CICS Explorer clean up scenario

In this chapter, we discuss a scenario that shows the use of the CICS Explorer and CICS Tools plug-ins to analyze CICS resource definitions with a view to cleaning up or tidying these up.

In most CICS environments, whether it is development, test, or even production (in some cases), there are redundant definitions that remain on CSDs for years. Often, systems programmers were reluctant to delete any definitions because there was no easy way for them to determine if the definitions were occasionally used.

In this chapter, we show that with the help of the CICS Explorer and the plug-ins for CICS CM and CICS IA, you can quickly identify duplicate or orphaned resources and then obtain if they are in use now or if they were ever used.

10.1 Orphaned resources

We first look at how with using CICS CM, you can identify all orphaned groups of resources within one or more CSDs.

To identify all orphaned groups of resources:

1. Using the CICS CM plug-in, first ensure that you are connected to the CICS CM server. See Figure 6-1 on page 125 for details.
2. Open the CICS CM perspective by clicking **Window** → **Open Perspective** → **Other** → **CICS CM**. Figure 10-1 shows the CICS CM perspective.

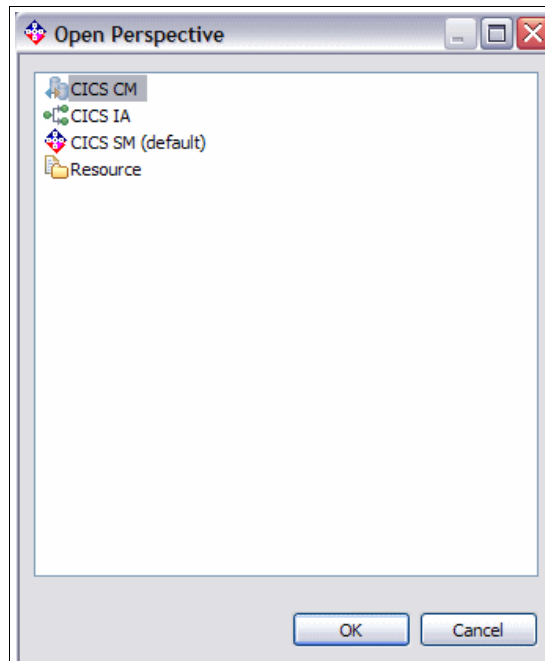

Figure 10-1 Selecting the CICS CM perspective

3. Within the CICS CM perspective, select the CICS CM configuration (CSD) that you want to work with. We select CSD REDCSD41.

Note: If you want to work with several configurations at a time, you can select multiple configurations, including CICSplex SM Contexts and CSDs.

Figure 10-2 on page 217 shows the CICS Explorer full screen with the CICS CM perspective.

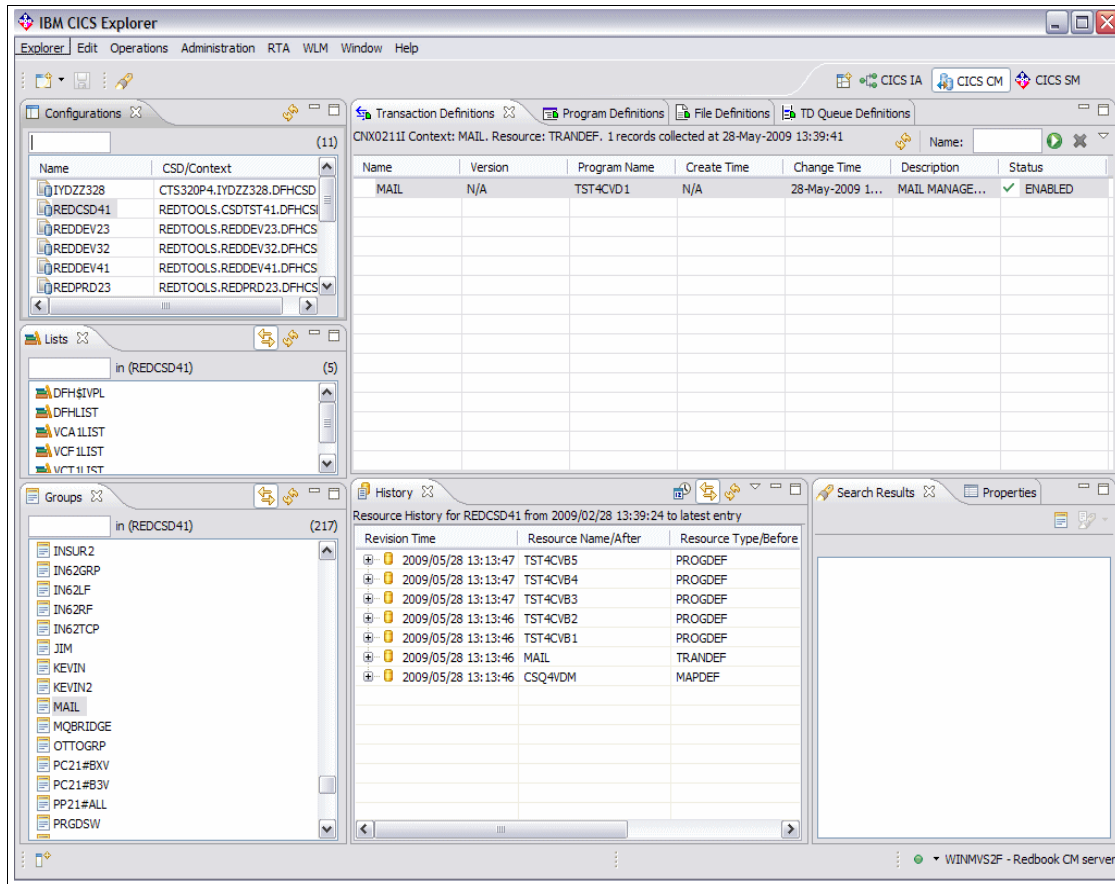

Figure 10-2 CICS CM perspective

4. Right-click, and select **Cleanup** → **Show Orphaned Groups**, as shown in Figure 10-3 and Figure 10-4 on page 218. This action populates the bottom right view with all of the orphaned groups within this CSD, as shown in Figure 10-5 on page 218.

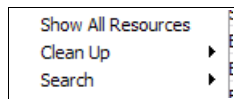

Figure 10-3 Clean-up option

5. Let us look at orphaned group Mail. Click this group in the list of orphaned groups, and the history of changes to definitions in this group is populated in the middle pane, shown in Figure 10-5 on page 218.

- Expand each entry in the History View to see what changes were made to these resource definitions, including the create date and change date.

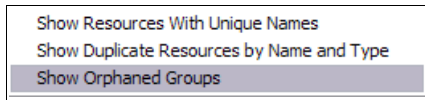

Figure 10-4 Orphaned Groups option

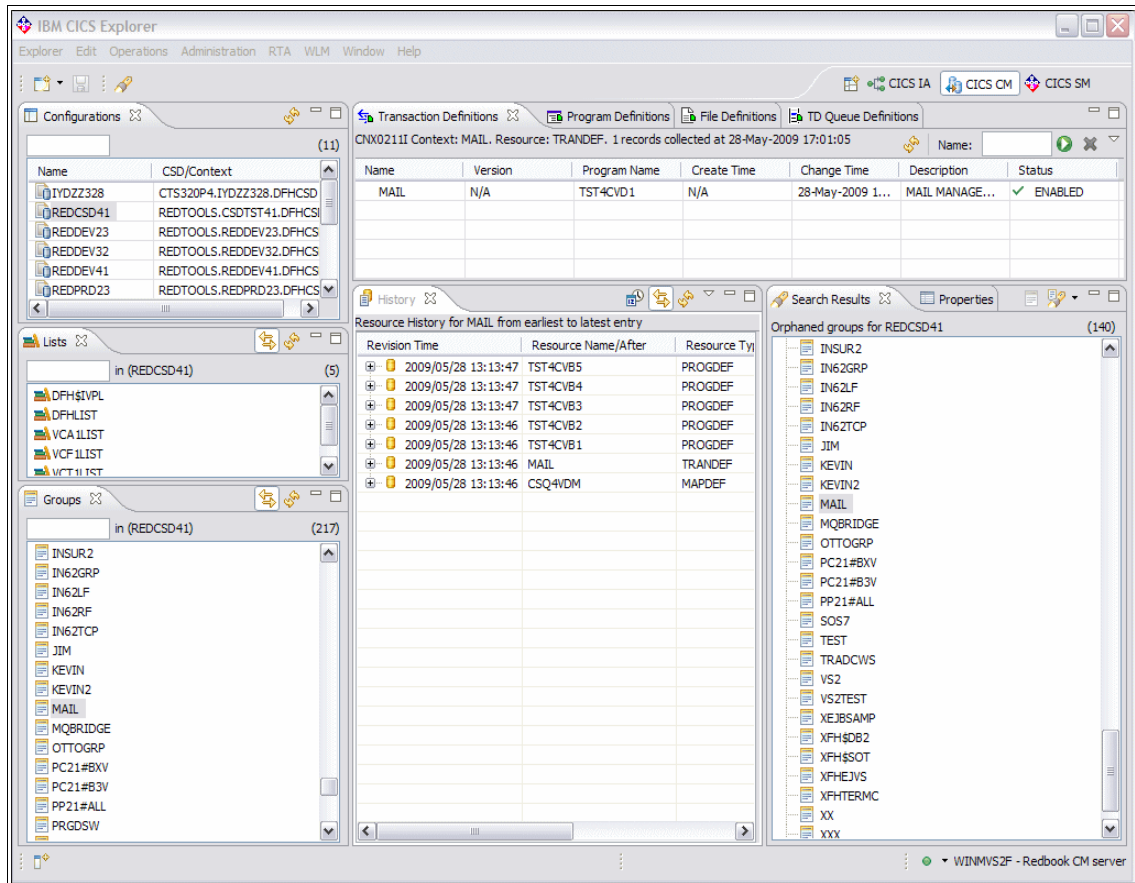

Figure 10-5 Orphaned groups in configuration REDCSD41

- In the Resources View, select the Transaction Definitions tab, and the Mail transaction is displayed. Right-mouse click the Mail transaction definition, and select **Dependencies** → **Uses Resources** to seamlessly invoke CICS IA and see the resources used by this transaction and the call tree of program execution, as shown in Figure 10-6 on page 219.

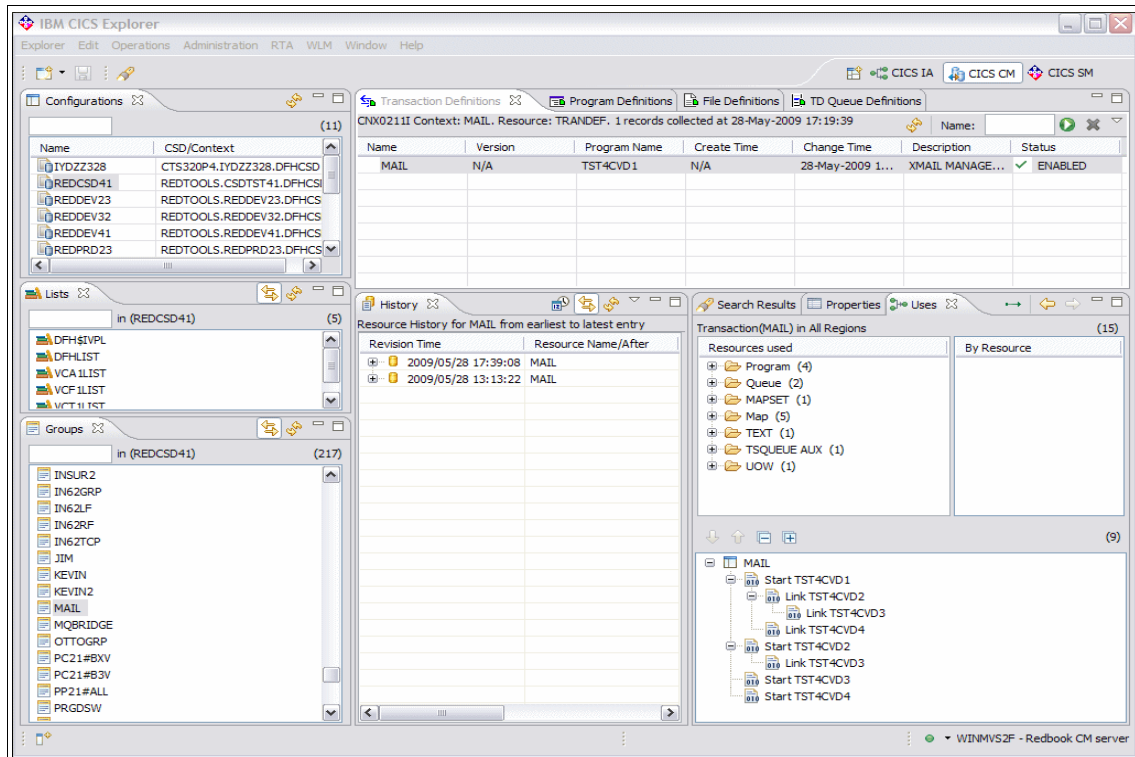

Figure 10-6 Resources used and call tree of program execution

8. We now invoke the CICS IA perspective for further analysis of this application. Click the **CICS IA** tab on the top right side of the perspective, which we show in Figure 10-6.
9. In the CICS IA perspective, click the **Transactions** tab, and specify a filter of M* in the box to narrow your search for this transaction, as shown in Figure 10-7 on page 220.

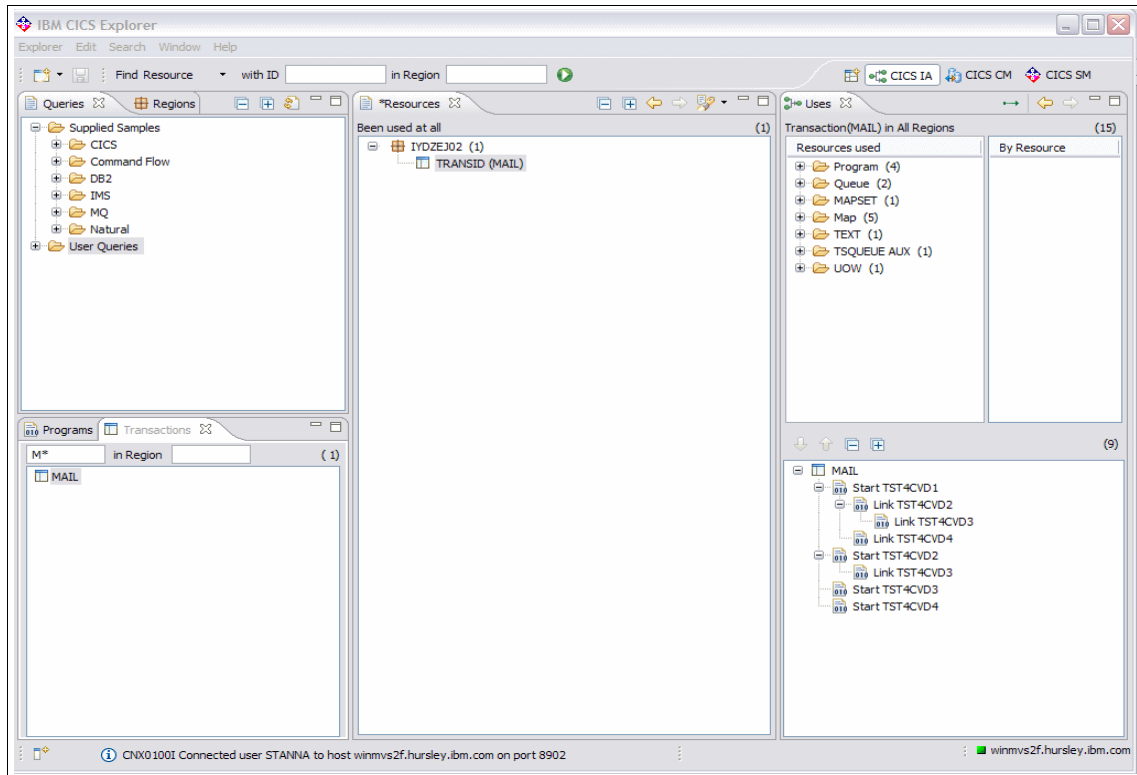

Figure 10-7 Mail transaction in CICS IA perspective

10. Right-mouse click the Mail transaction, and select **Show View and Transactions**, as shown in Figure 10-8.

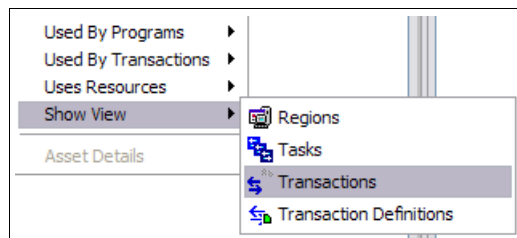

Figure 10-8 Show View and Transactions in the CICS IA perspective

We invoke the CICS SM perspective and determine which regions this application runs in.

In Figure 10-9 on page 221, the view on the far right side of the perspective shows the CICS regions in which transaction MAIL is installed.

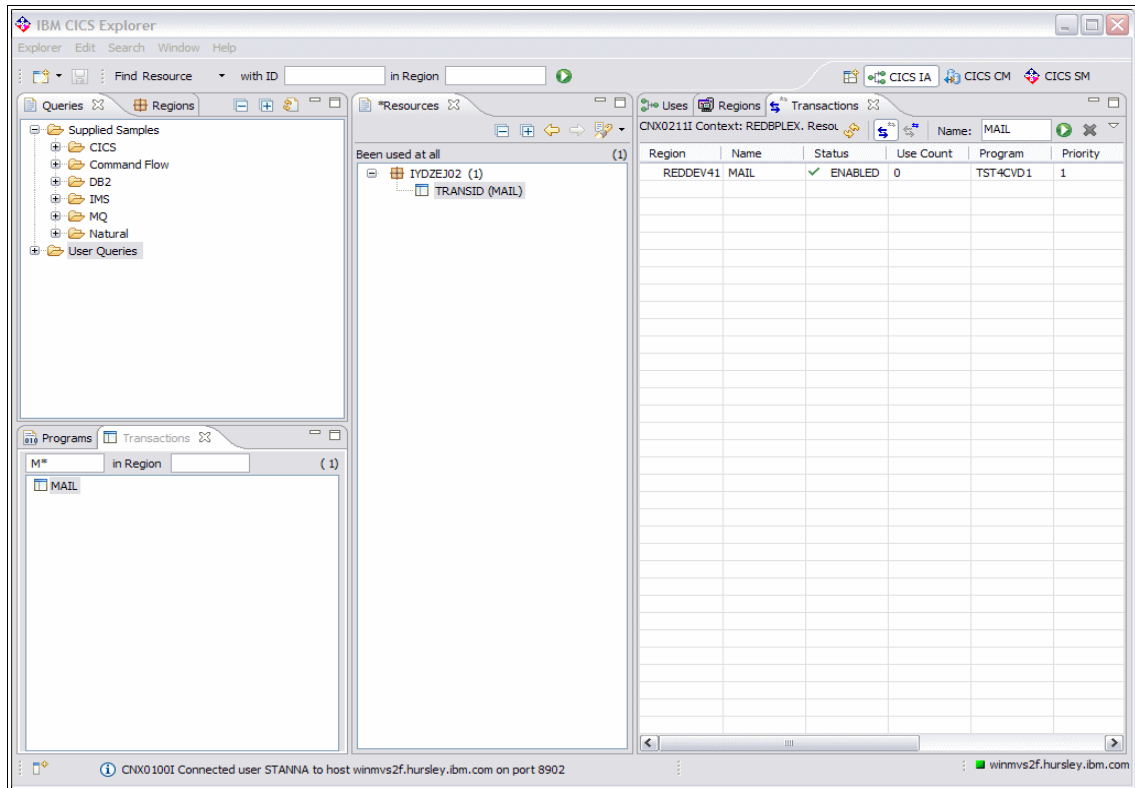

Figure 10-9 Details of regions in which the MAIL transaction is installed

11. From the CICS IA perspective, select **Show Properties View**, as shown in Figure 10-10.

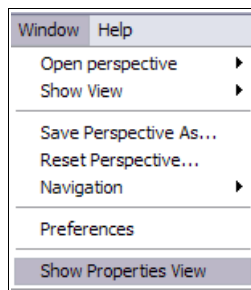

Figure 10-10 Access the Show Properties View

Figure 10-11 on page 222 shows details about the First run and Last run of the transaction.

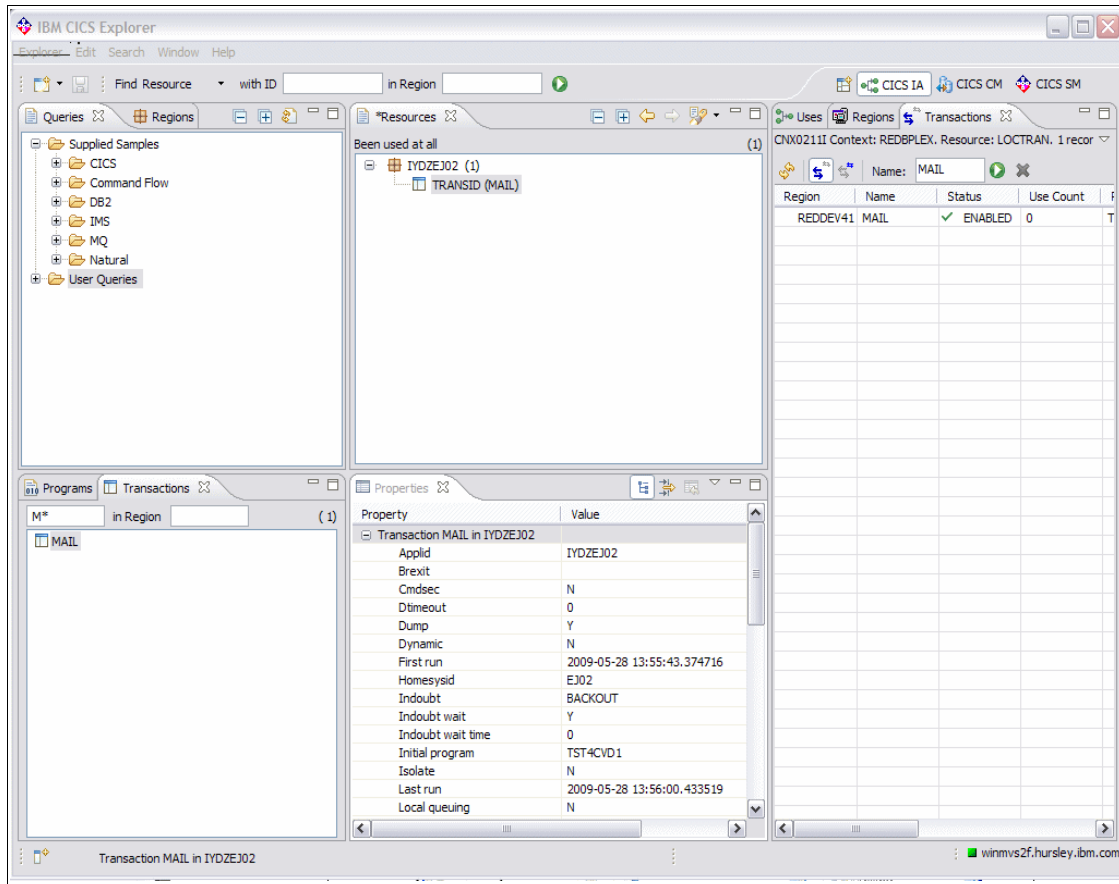

Figure 10-11 Details of First run and Last run of the transaction

By working through this scenario, we determined that the MAIL application group, although orphaned, is still used. The cleanup action here is to add the group to a grouplist for the relevant CICS region.

By working through the other groups in the list of orphaned groups and following the instructions in this section, we can quickly obtain if the groups are in use and then take the appropriate action.

10.2 Duplicate resources

Another capability that the CICS CM plug-in provides is finding duplicate resources in a CSD or CICSplex SM BAS repository.

To find duplicate resources in a CSD or CICSplex SM BAS repository:

1. From the CICS CM perspective, right-click the configuration that you want to work with. Select **Cleanup** → **Show Duplicate Resources by Name and Type**, as shown in Figure 10-12 and Figure 10-13.

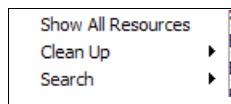

Figure 10-12 Cleanup

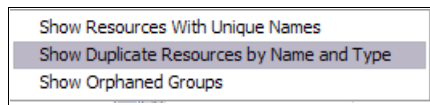

Figure 10-13 Duplicate Resources by Name and Type

A list of resource definitions within groups that have duplicate resources of the same name and type within the repository is displayed, as shown in Figure 10-14 on page 224.

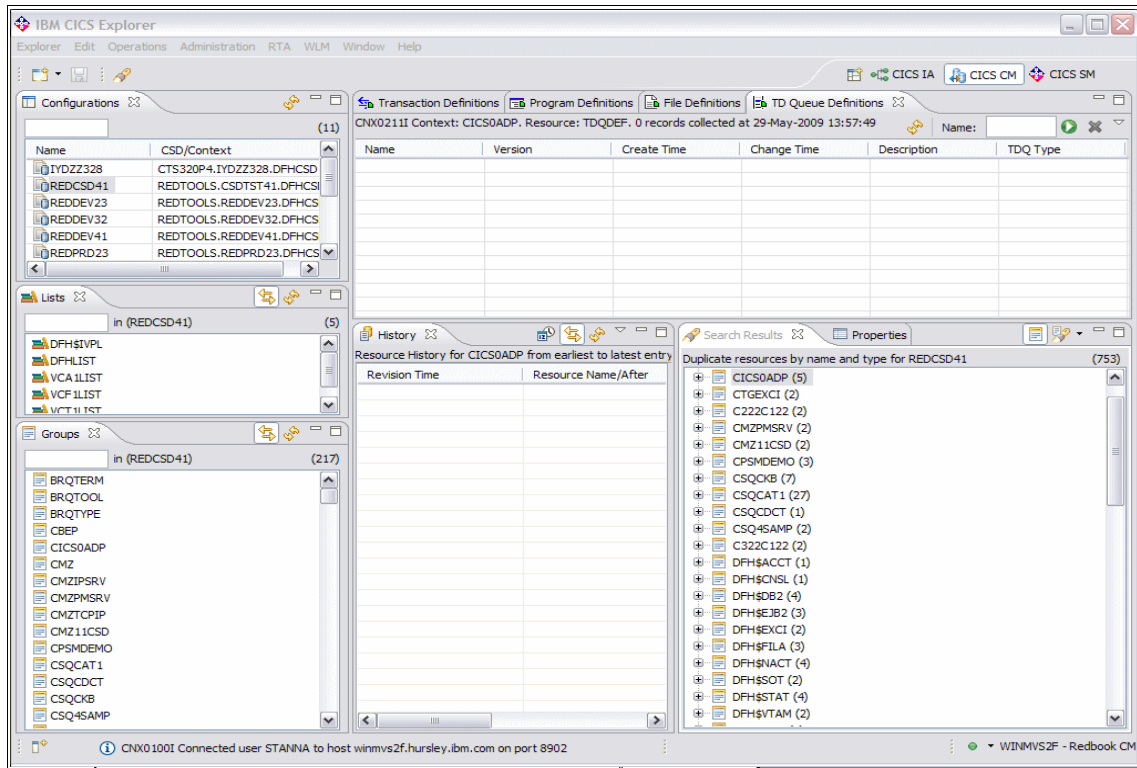

Figure 10-14 Duplicate Definitions found

- Expand each group, right-click a resource definition, and select **Find** → **Similar resources** to list all resources of the same name and type within the repository, as shown in Figure 10-15.

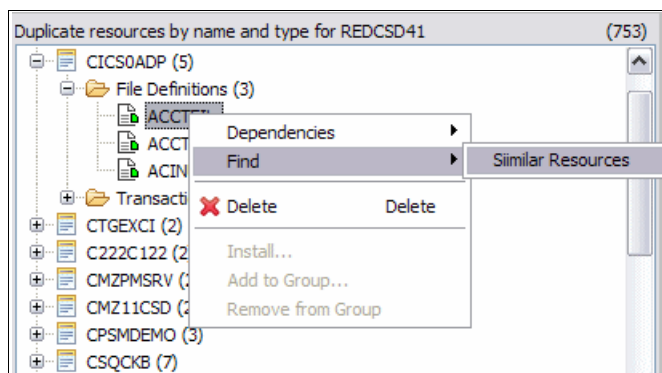

Figure 10-15 Finding similar resources

In Figure 10-16, notice that the file ACCTFIL was found in three different groups.

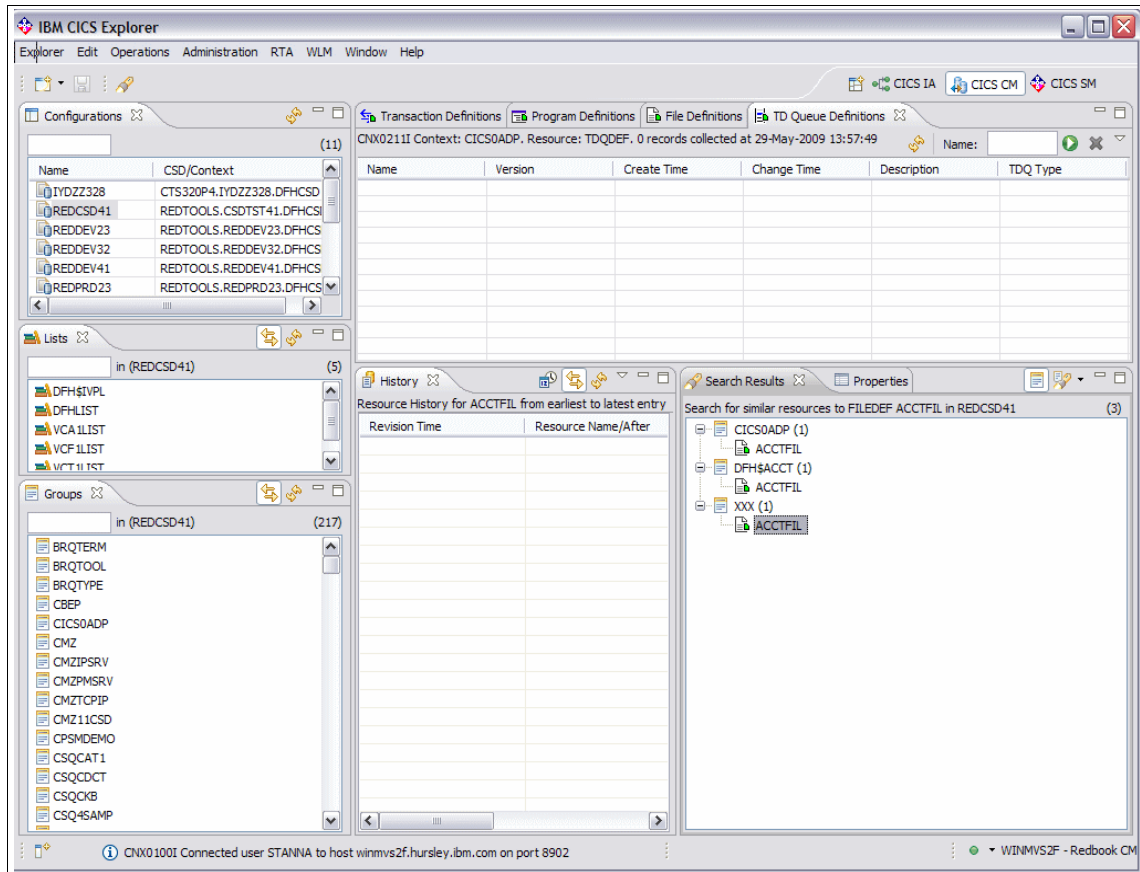

Figure 10-16 Duplicate file

3. From here you can right-click, and delete the file definition in group XXX, if you believe that this definition is not used. Figure 10-17 on page 226 shows an example of deleting a duplicate file.

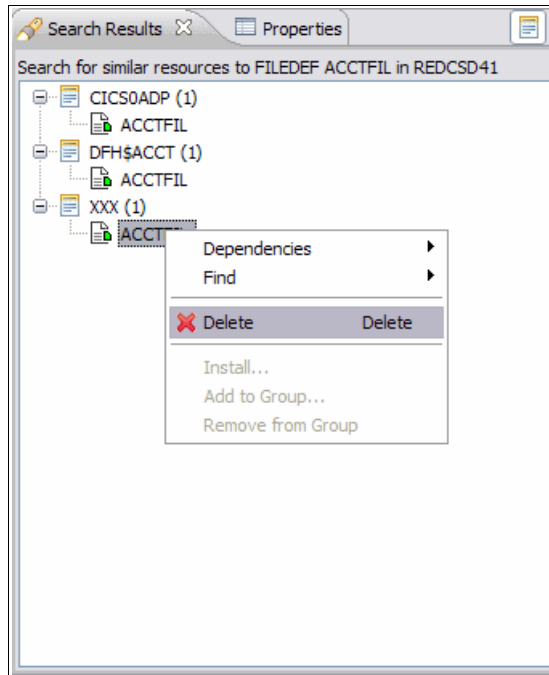

Figure 10-17 Delete a duplicate definition

4. When you select the **Delete** option, the Confirm Delete prompt is displayed, as shown in Figure 10-18. Click **OK** to delete the resource definition.

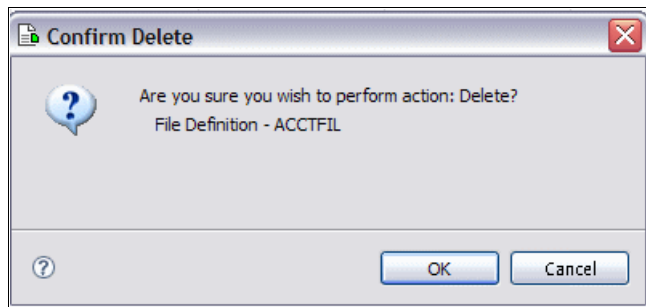

Figure 10-18 Delete confirmation



CICS Explorer performance scenario

In this chapter, we discuss how you can use the CICS Explorer together with the CICS PA plug-in to navigate through the large amount of performance data that is available in a complex CICS configuration.

As we described in Chapter 7, “CICS Explorer PA plug-in familiarization” on page 147, using CICS Performance Analyzer for z/OS V 3.1 you can create performance data extracts in the form of CSV files or DB2 tables. These data extracts are typically for a subset of the large amount of SMF data that is recorded in most CICS installations.

By using the CICS Explorer, you can identify CICS system level performance problems without having to delve into large amounts of CICS monitoring and statistics data.

Using the CICS PA plug-in to analyze the data extracts that CICS PA creates you can create charts and reports that can help to identify performance bottlenecks within specific transactions.

11.1 Resolving system performance problems

The CICS Explorer provides a number of alerts for performance problems at the system level, such as:

- ▶ Short on Storage
- ▶ System dump in progress
- ▶ Transaction dump in progress
- ▶ System has reached MAXTASKS limit
- ▶ Tasks stalling because of resource contention

In Figure 11-1, we create a Short on Storage condition using transaction SOS7, which GETMAINs large amounts of CICS DSA.

After running the transaction, we immediately see the alert in the CICS Explorer view, as shown in Figure 11-1.

The screenshot shows the IBM CICS Explorer interface. The left pane shows a tree view of CICSplex components under the server E300, including REDBPLEX (10/10) and various DEV, PRD, and STS resources. The main pane displays transaction details for SOS7, showing 0 records collected at 03-Jun-2009 11:18:17. The Events pane at the bottom shows an alert for SOS7, with the following details:

Name	Target	Severity	Priority	Event Type	Detail	View	Resource ...	Resource ...	Description
!!SAMSOS	REDDEV41	HS	255	SAM	NO	CICSDSA			SOSABOV...

Figure 11-1 SOS Condition

If we invoke the Operations and Tasks view and specify a Transaction name filter of SOS7, we can display the status of this task, as shown in Figure 11-2.

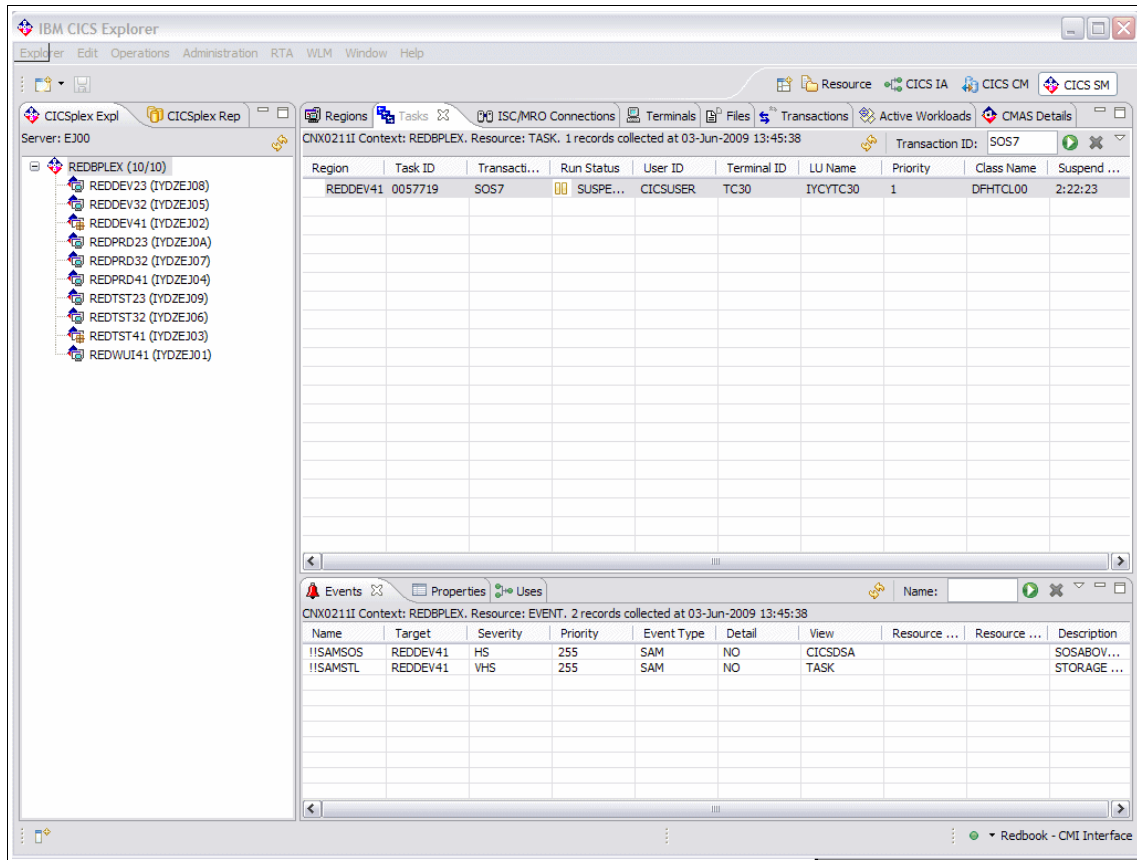

Figure 11-2 Status of task

Right-click the task to select the option to Purge, Force Purge, or Kill the task, as shown in Figure 11-3.

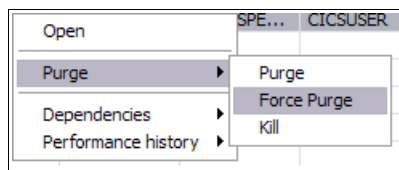

Figure 11-3 Options to remove the task causing SOS

We tried the Purge option and received the response in Figure 11-4.

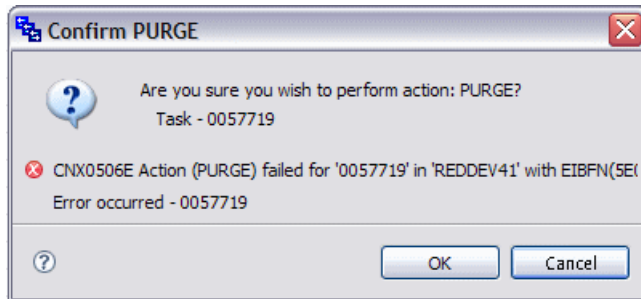

Figure 11-4 Purge response

We then used the Force Purge option, and the task was purged successfully. The SOS condition was rectified as confirmed by the Event view in the CICS Explorer.

To investigate the problem further, you can click the **Transactions** tab in the CICS Explorer and look at the attributes of the SOS7 transaction. We double-clicked transaction SOS7 and could see all of the runtime attributes of this transaction, as shown in Figure 11-5 on page 231.

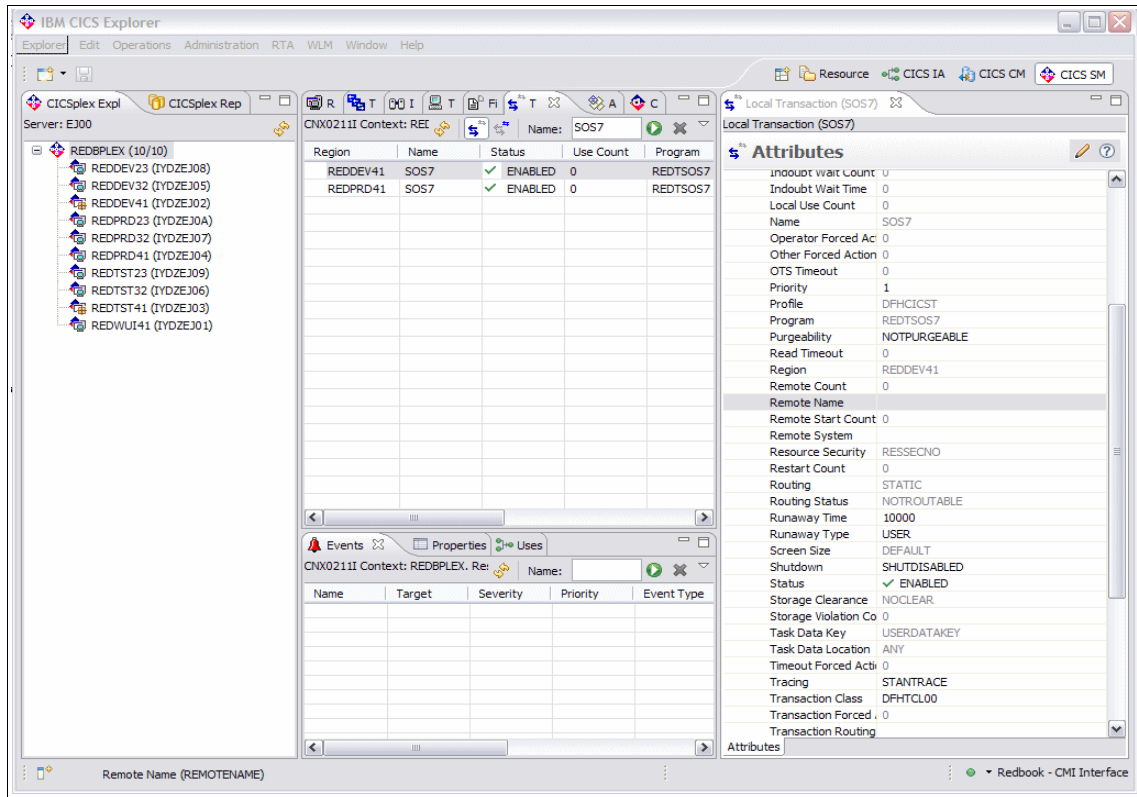

Figure 11-5 Runtime attributes of transaction SOS7

11.2 Drilling down into transaction detail

To obtain further information about transaction SOS7, we right-click the transaction in the CICS CM perspective, and select **Dependencies** → **Uses Resources**, as shown in Figure 11-6.

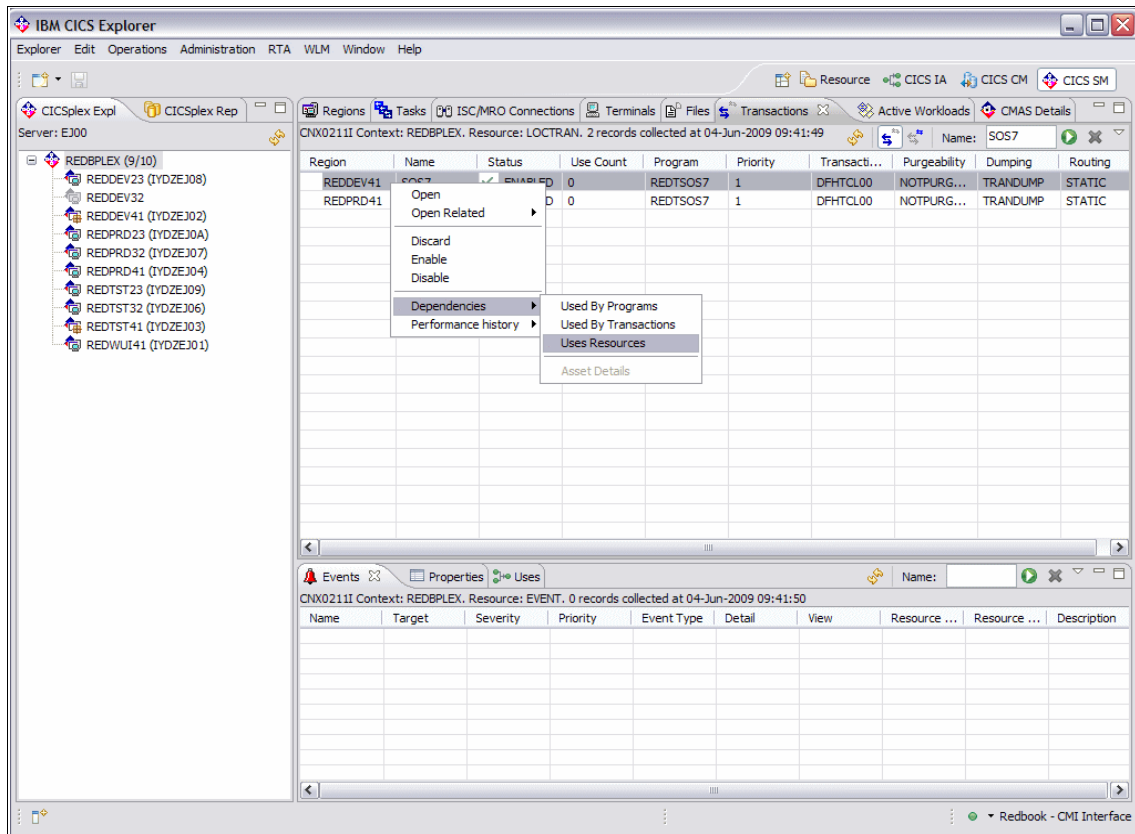

Figure 11-6 Finding details of Resources used

The CICS IA perspective is invoked and provides further details about this transaction. As shown in Figure 11-7 on page 233, transaction SOS7 runs program REDTSOS7, which issues a number of API commands including a GETMAIN.

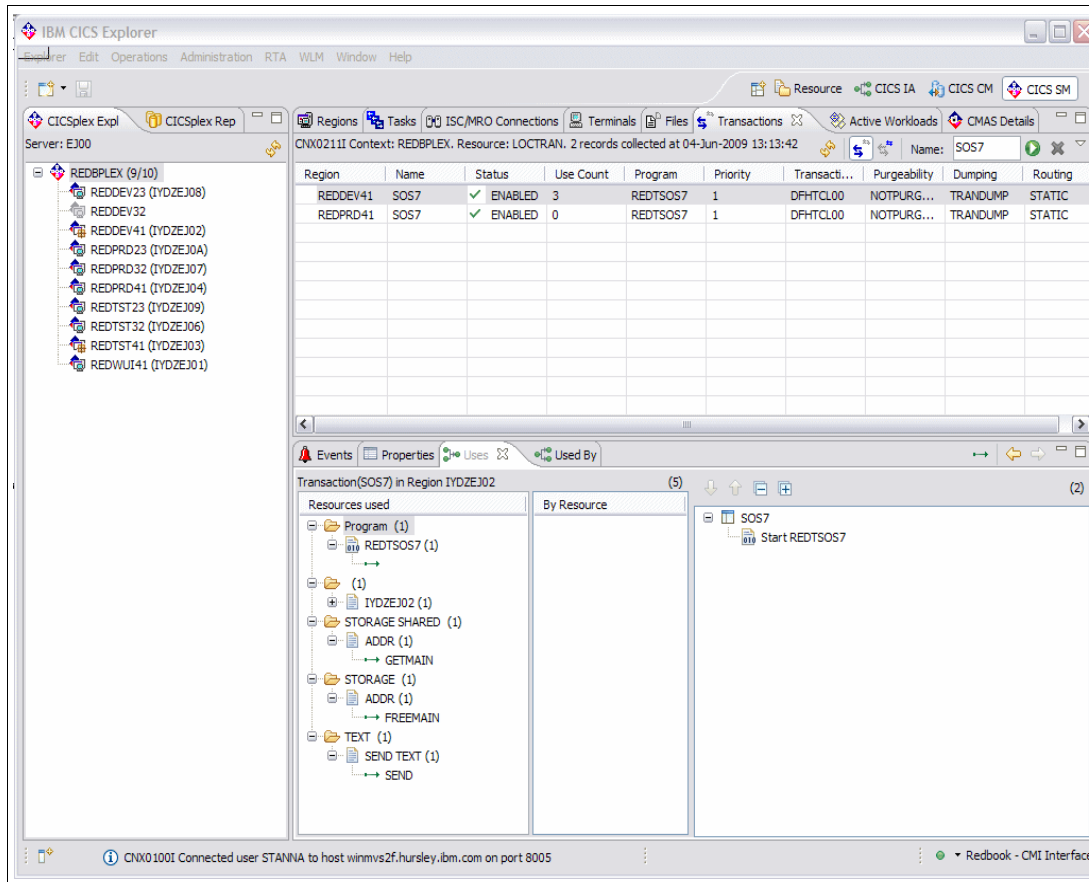

Figure 11-7 Detailed view of transaction SOS7

To look at the performance profile for this transaction, from the CICS CM perspective and the Transaction view, right-click transaction SOS7, and select **Performance history** → **Storage**.

Looking at the transaction detail, we can see that the EUDSA high-water-mark was reached four times, and the ECDSA high-water-mark was reached five times.

Figure 11-8 on page 234 shows the storage usage detail for transaction SOS7.

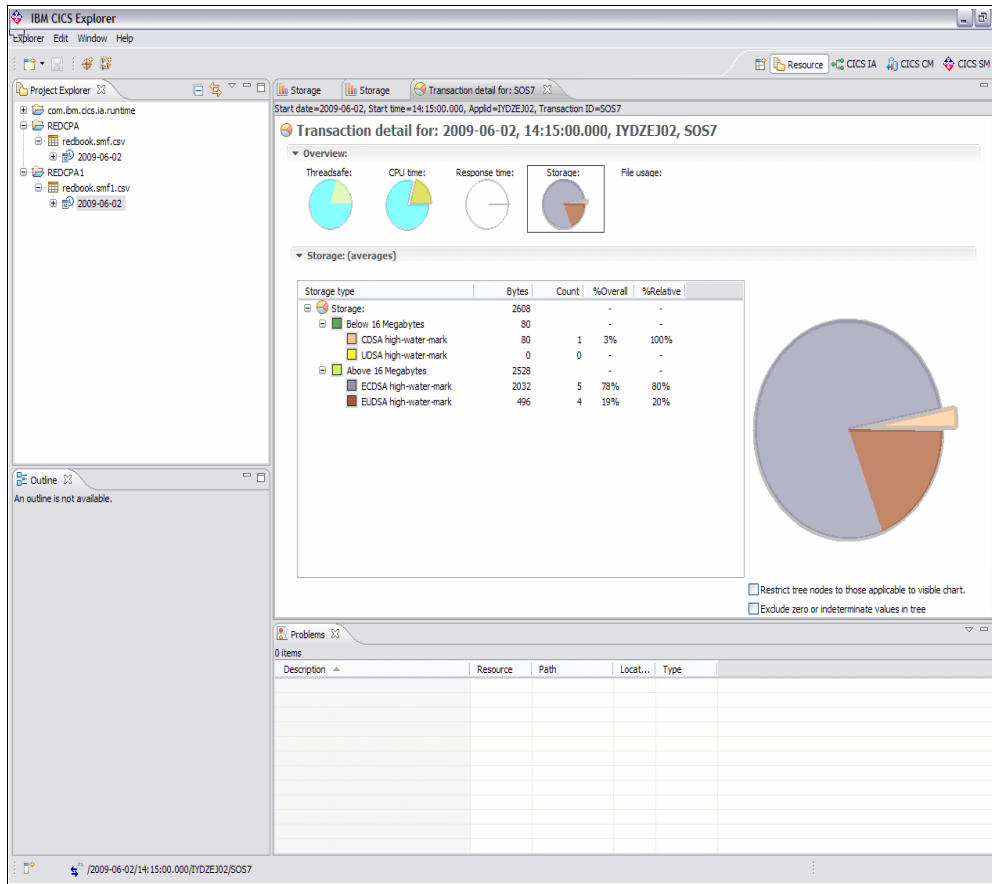

Figure 11-8 Storage usage detail for transaction SOS7

Analyzing transaction performance

In this scenario, we provide an example of navigating through the CICS PA plug-in to analyze the performance characteristics of a transaction.

We first ensure that the connection from the CICS PA plug-in to the DB2 database that contains the CICS PA HDB data is active. See Chapter 7, “CICS Explorer PA plug-in familiarization” on page 147.

Next, we invoke the CICS PA perspective. We expand the CICS Explorer Redbooks System.cpa folder to see the dates on which SMF data was loaded into a CICS PA HDB and then exported to a DB2 table.

We want to analyze a set of transactions that executed on the 11th of June 2009, so we right-click the folder for this date, and select Sheet View. Figure 11-9 shows the Sheet View.

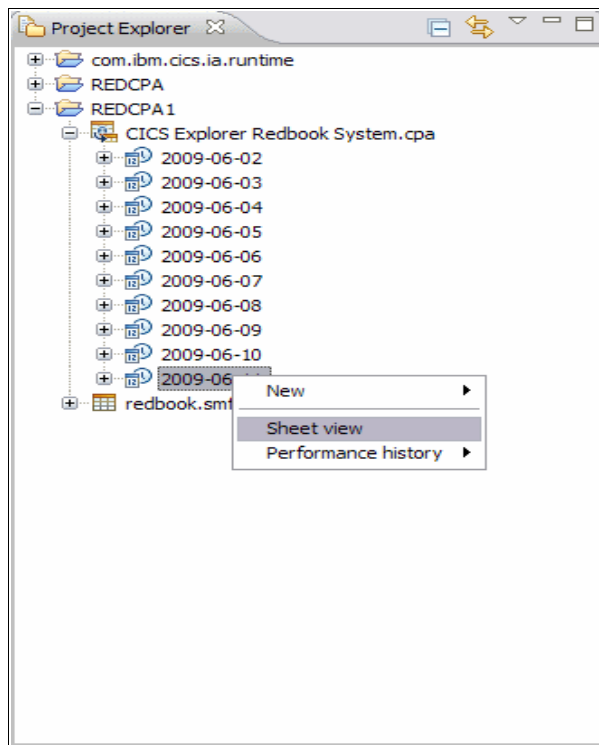

Figure 11-9 Invoke Sheet View

From the Sheet View, we can select a set of transactions for a particular date and time and start further analysis. To do this, we simultaneously press the Shift key and the Scroll Down key to select a set of transactions to analyze.

Having selected our set of transactions, we right-click and invoke other views to drill down into the performance profile for these transactions, as shown in Figure 11-10 on page 236.

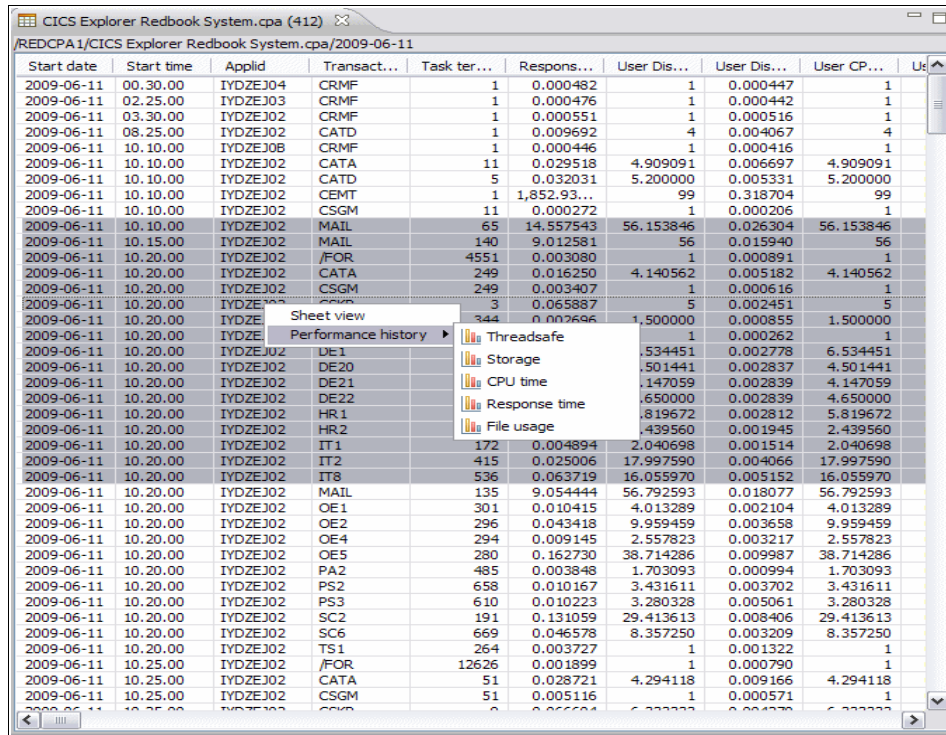

Figure 11-10 Drilldown into performance analysis from the Sheet View

In our case, we wanted to start with details of response times for these transactions, so we click **Response time** to invoke the bar chart view for these transactions.

Looking at the response times for the MAIL transaction, we immediately see a significant difference in response times for this transaction during two separate time intervals.

By hovering the mouse cursor over the bars, we saw that the suspend time average during one interval was 14.531239 seconds and during another it was 8.996642 seconds.

Figure 11-11 on page 237 shows the response times for the Mail transaction.

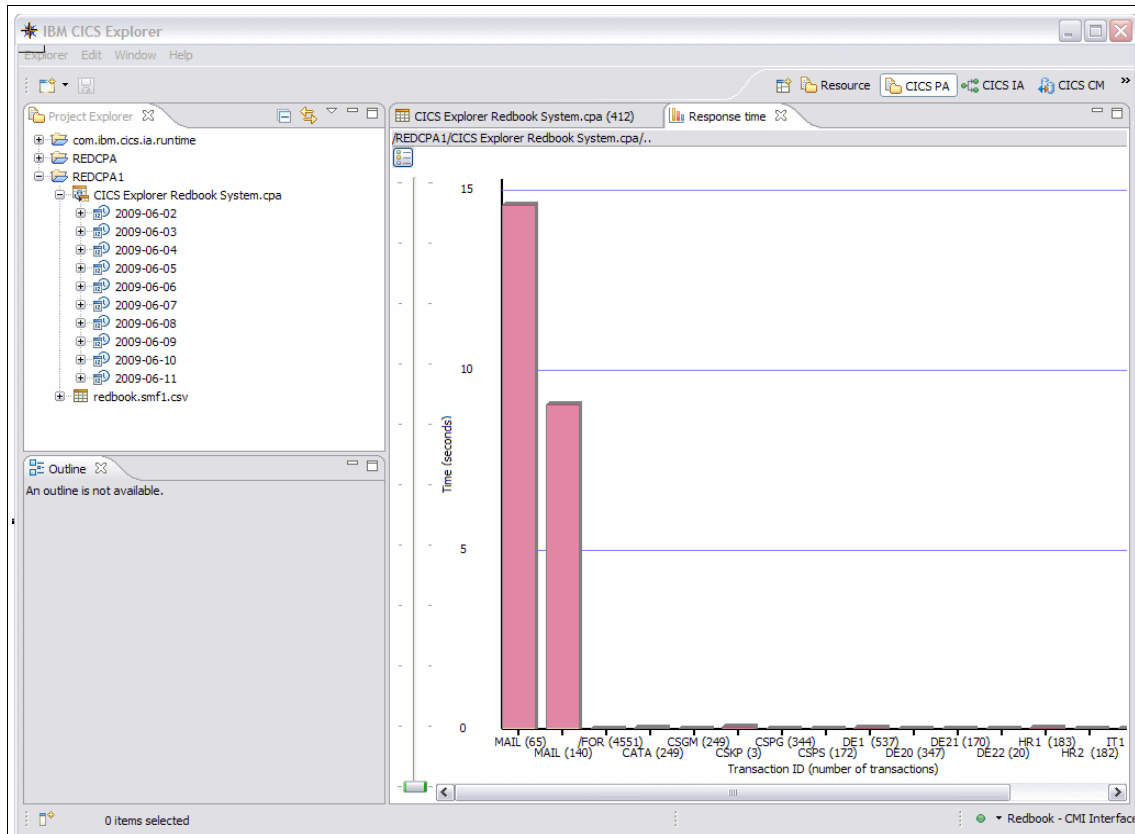

Figure 11-11 Response times for Mail transaction

By double-clicking each bar we can invoke the detail breakdown view. Then we select **Response time** to get the complete Response time breakdown for that interval.

As we can see from the detailed breakdown for the 10:10 am interval, the User Dispatch time was 0.026304 seconds and the suspend time was 14.531239 seconds, as shown in Figure 11-12 on page 238.

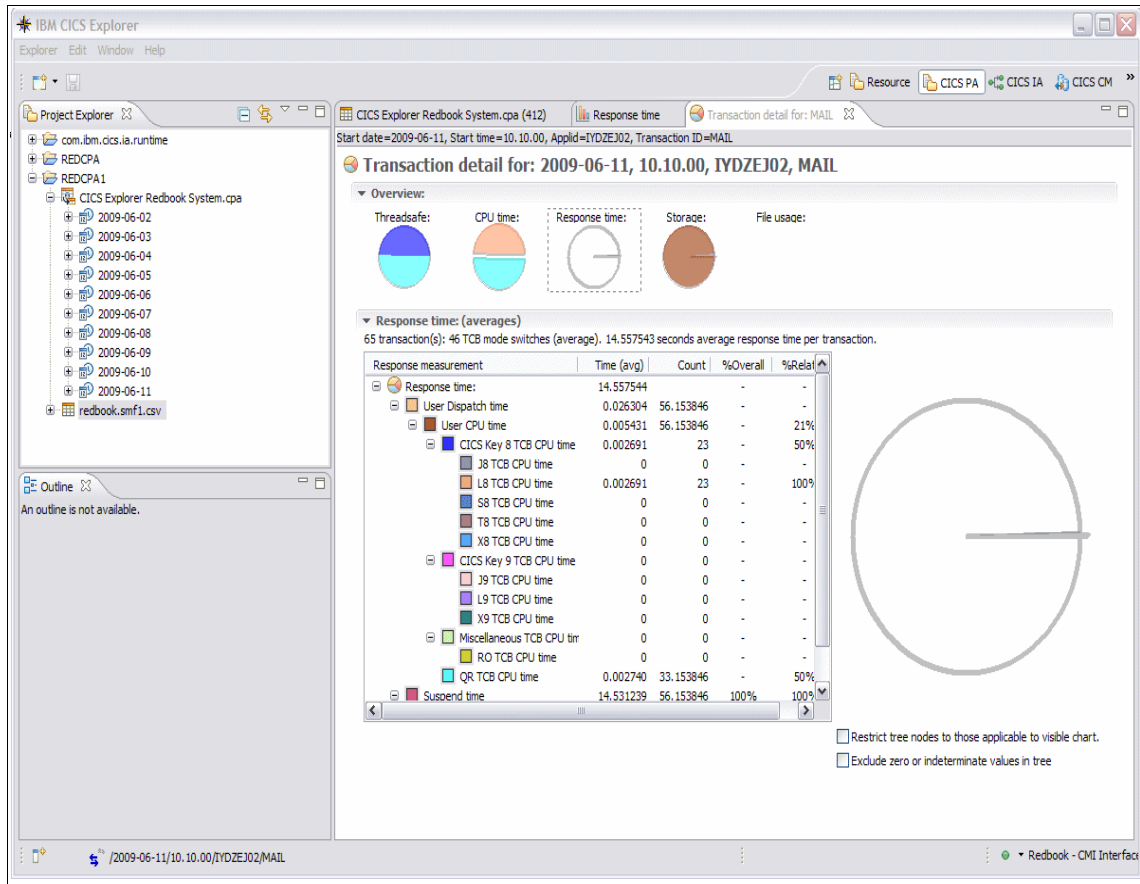

Figure 11-12 Response time breakdown for 10:10 interval

As we can see from the detailed breakdown for the 10:15 am interval, Figure 11-13 on page 239, the User Dispatch time was 0.015940 seconds and the suspend time was 8.996642 seconds.

From the detailed breakdown views, we can determine a lot of information about the performance profile for this transaction during the two intervals using the Threadsafte, CPU time, Storage, and File usage views if appropriate.

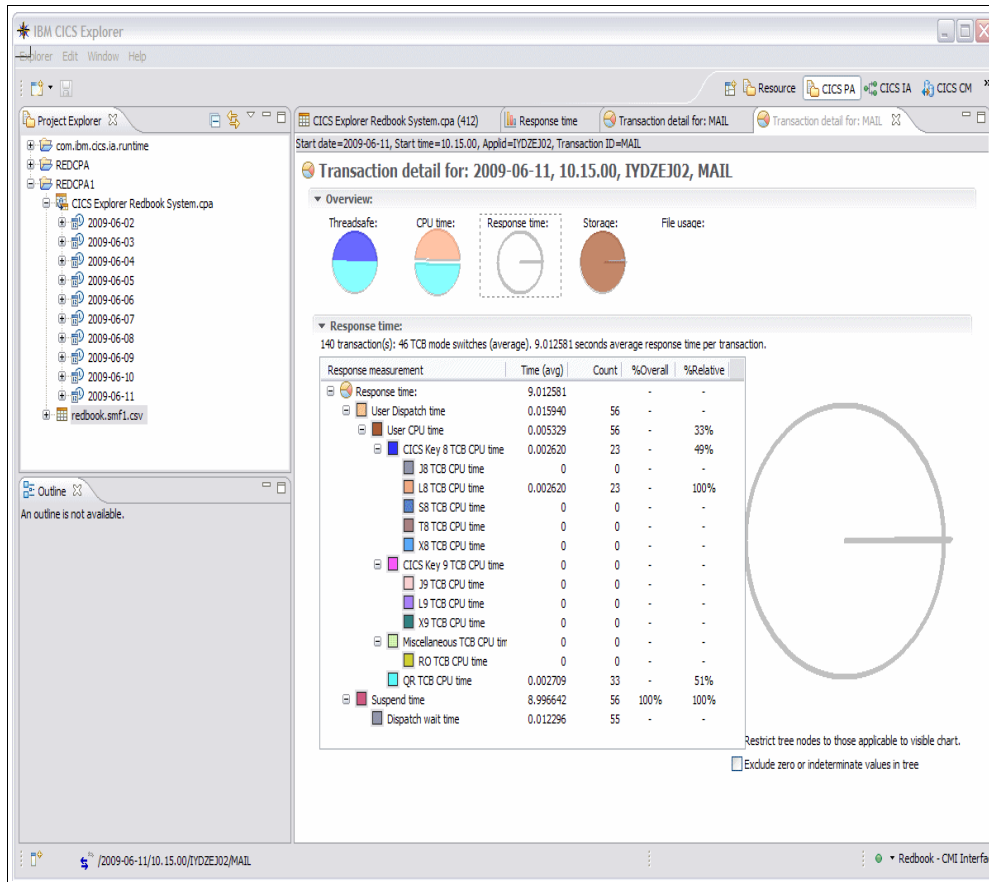

Figure 11-13 Response time breakdown for 10:15 interval

To determine the cause of the long Suspend time during the 10:10 interval, we can look again at the Sheet View by clicking the appropriate tab.

As we can see from the Sheet View and by scrolling right to the “Terminal Control I/O wait time average” column the difference in Suspend time for the MAIL transaction for the two intervals is entirely due to Terminal Control I/O wait, as shown in Figure 11-14 on page 240.

Example 11-1 Wait analysis for MAIL transaction at 10:00

```

Start=10:10:00  APPLID=IYDZEJ02  Tran=MAIL  Interval=00:05:00
Summary Data
----- Ratio -----
# Tasks
Response Time
Dispatch Time
0.2% of Response
CPU Time
20.6% of Dispatch
Suspend Wait Time
99.8% of Response
Dispatch Wait Time
0.2% of Suspend
Resource Manager Interface (RMI) elapsed time
0.1% of Response
Resource Manager Interface (RMI) suspend time
0.0% of Suspend

Suspend Detail
----- Count -----
Total Average
TCIOWTT Terminal wait for input time
585 9.0
DSCHMDLY Redispatch wait time caused by change-TCB mode
2990 46.0
DSPDELAY First dispatch wait time
65 1.0
N/A Other Wait Time
8 0.1
TSIOWTT VSAM TS I/O wait time
2 0.0

```

		Time		Count	
		Total	Average	Total	Average
# Tasks				65	
Response Time		946.2403	14.5575		
Dispatch Time		1.7098	0.0263	3650	56.2
0.2% of Response					
CPU Time		0.3530	0.0054	3650	56.2
20.6% of Dispatch					
Suspend Wait Time		944.5306	14.5312	3650	56.2
99.8% of Response					
Dispatch Wait Time		1.4515	0.0223	3585	55.2
0.2% of Suspend					
Resource Manager Interface (RMI) elapsed time		1.3208	0.0203	1625	25.0
0.1% of Response					
Resource Manager Interface (RMI) suspend time		0.0000	0.0000	0	0.0
0.0% of Suspend					

		Suspend Time			
		Total	Average	%age	Graph
Total	Average				
TCIOWTT	Terminal wait for input time	943.1267	14.5096	99.9%	*****
585	9.0				
DSCHMDLY	Redispatch wait time caused by change-TCB mode	1.2319	0.0190	0.1%	
2990	46.0				
DSPDELAY	First dispatch wait time	0.1243	0.0019	0.0%	
65	1.0				
N/A	Other Wait Time	0.0384	0.0006	0.0%	
8	0.1				
TSIOWTT	VSAM TS I/O wait time	0.0093	0.0001	0.0%	
2	0.0				

Example 11-2 Wait Analysis for MAIL transaction at 10:15

```

Start=10:15:00  APPLID=IYDZEJ02  Tran=MAIL  Interval=00:05:00
Summary Data
----- Ratio -----
# Tasks
Response Time
Dispatch Time
0.2% of Response
CPU Time
33.4% of Dispatch
Suspend Wait Time
99.8% of Response
Dispatch Wait Time
0.1% of Suspend
Resource Manager Interface (RMI) elapsed time
0.1% of Response
Resource Manager Interface (RMI) suspend time
0.0% of Suspend

Suspend Detail
----- Count -----
Total Average
TCIOWTT Terminal wait for input time
1260 9.0
DSCHMDLY Redispatch wait time caused by change-TCB mode
6440 46.0
DSPDELAY First dispatch wait time
140 1.0

```

		Time		Count	
		Total	Average	Total	Average
# Tasks				140	
Response Time		1261.7614	9.0126		
Dispatch Time		2.2316	0.0159	7840	56.0
0.2% of Response					
CPU Time		0.7461	0.0053	7840	56.0
33.4% of Dispatch					
Suspend Wait Time		1259.5298	8.9966	7840	56.0
99.8% of Response					
Dispatch Wait Time		1.7214	0.0123	7700	55.0
0.1% of Suspend					
Resource Manager Interface (RMI) elapsed time		1.5895	0.0114	3500	25.0
0.1% of Response					
Resource Manager Interface (RMI) suspend time		0.0000	0.0000	0	0.0
0.0% of Suspend					

		Suspend Time			
		Total	Average	%age	Graph
Total	Average				
TCIOWTT	Terminal wait for input time	1258.0697	8.9862	99.9%	*****
1260	9.0				
DSCHMDLY	Redispatch wait time caused by change-TCB mode	1.3667	0.0098	0.1%	
6440	46.0				
DSPDELAY	First dispatch wait time	0.0934	0.0007	0.0%	
140	1.0				



CICSplex SM enablement using the CICS Explorer

One of the functions of CICSplex SM is to implement dynamic workload management within CICS. In this chapter, we review the various factors that you must take into account when delivering such a solution. We also discuss how we can identify these solutions and address them using the CICS Explorer.

When a program or transaction in CICS uses an external resource, such as a file or temporary storage, this creates an affinity within the transaction to that resource. CICS Interdependency Analyzer gives us the ability to analyze affinity data. The affinity data is loaded into DB2 databases, on which you can perform SQL queries and from which you can produce detailed reports.

12.1 Overview of transaction affinities

CICS transactions use many different techniques to pass data from one transaction to another. Some techniques require that the transactions that are exchanging data must execute in the same CICS region and therefore impose restrictions on the dynamic routing of transactions. If transactions exchange data in ways that impose such restrictions, there is said to be an affinity between them.

There are two categories of affinity:

- ▶ Inter-transaction affinity
- ▶ Transaction-system affinity

The restrictions on dynamic routing caused by transaction affinities depend on the duration and scope of the affinities. Clearly, the ideal situation for a dynamic routing program is for there to be no transaction affinity at all, which means there is no restriction in the choice of available target regions. However, even when transaction affinities do exist, there are limits to the scope of these affinities that are determined by the:

- ▶ Affinity relations
- ▶ Affinity lifetime

CICS IA cannot detect affinities in the following types of dynamically routed requests:

- ▶ Non-terminal-related START requests
- ▶ Distributed program link (DPL) requests
- ▶ Method requests for enterprise beans or CORBA stateless objects

For these types of dynamically routed requests, review your application to determine whether it is suitable for dynamic routing.

12.1.1 Inter-transaction affinity

An inter-transaction affinity is an affinity between two or more CICS transactions. It is caused by the transactions using techniques to pass information between one another or to synchronize activity between one another in a way that requires the transactions to execute in the same CICS region.

Inter-transaction affinities that impose restrictions on the dynamic routing of transactions, can occur in the following circumstances:

- ▶ One transaction terminates, leaving “state data” in a place that a second transaction can access only by running in the same CICS region as the first transaction.
- ▶ One transaction creates data that a second transaction accesses while the first transaction is still running. For this to work safely, the first transaction usually waits on an event, which the second transaction posts when it has read the data that the first transaction created. This synchronization technique requires that both transactions are routed to the same CICS region.

12.1.2 Transaction-system affinity

A transaction-system affinity is an affinity between a transaction and a particular CICS region. It is caused by the transaction interrogating or changing the properties of the CICS region.

Transactions with an affinity to a particular CICS region, rather than to another transaction, are not eligible for dynamic transaction routing. Typically, they are transactions that use CICS SPI commands, such as EXEC CICS INQUIRE or SET or that depend on global user exit programs.

12.1.3 Affinity relations

When a transaction is associated with an affinity, the affinity relation determines how the dynamic routing program selects a target region for an instance of the transaction. An affinity relation can be classified as one of the following relations:

Global	A group of transactions in which all instances of all transactions in the group that are initiated from any terminal, or are BTS or Link3270 transactions, must execute in the same target region for the lifetime of the affinity. The affinity lifetime for global relations can be “system” or “permanent.”
BAPPL	All instances of all transactions in the group are associated with the same CICS Business Transaction Services (BTS) process. There might be many different user IDs and terminals that are associated with the transactions that are included in this affinity group.
LINK3270	All instances of all transactions in the group are associated with the same Link3270 bridge facility.

LUname	A group of transactions in which all instances of all transactions in the group that are initiated from the same terminal must execute in the same target region for the lifetime of the affinity. The affinity lifetime for LUname relations can be “pseudoconversation,” “logon,” “pseudoconversational,” “system,” or “permanent.”
UserID	A group of transactions in which all instances of the transactions that are initiated from a terminal and executed on behalf of the same user ID must execute in the same target region for the lifetime of the affinity. The affinity lifetime for userID relations can be “pseudoconversation,” “signon,” “system,” or “permanent.”

12.1.4 Affinity lifetimes

The affinity lifetime determines when the affinity is ended. An affinity lifetime can be classified as one of:

System	The affinity lasts for as long as the target region exists and ends whenever the target region terminates (at a normal, immediate, or abnormal termination). The resource shared by transactions that take part in the affinity is not recoverable across CICS restarts.
Permanent	The affinity extends across all CICS restarts. (The resource shared by transactions that take part in the affinity is recoverable across CICS restarts.) This is the most restrictive of all the inter-transaction affinities.
Process	The affinity exists until the BTS process completes.
Activity	The affinity exists until the BTS activity completes.
Facility	The affinity exists until the Link3270 bridge facility is deleted.
Pseudoconversation	The (LUname or userID) affinity lasts for the whole pseudoconversation and ends when the pseudoconversation ends at the terminal.
Logon	The (LUname) affinity lasts for as long as the terminal remains logged on to CICS and ends when the terminal logs off.
Signon	The (userID) affinity lasts for as long as the user is signed on, and ends when the user signs off. Note that this lifetime is only possible in those situations where only one userID is permitted. Signon lifetime cannot be detected if

multiple users are permitted to be signed on with the same userID at the same time.

Note: If an affinity is both “userID” and “LUName” (that is, all instances of all transactions in the group were initiated from the same terminal and by the same user ID), “LUName” takes precedence.

12.2 Running CICS Interdependency Analyzer for affinities

In the first instance, we must run the collector component of CICS Interdependency Analyzer for z/OS against our candidate application. We chose a single application to analyze to prepare this for CICSplex enablement.

We need to set the correct parameters in the collector panel through the transaction CINT, as shown in Figure 12-1.

```
CIU290          CICS Interdependency Analyzer for z/OS - V3R1M0      2009/06/01
                  Resource Options for                               09:28:10AM
                  CICS Sysid: EJ02  CICS Applid: IYDZEJ02

Type action code then press ENTER:

  1 = General Options
  2 = Time/Date Options

Interdependency Options          Affinity Options
  3 = CICS Options for APIs      8 = Affinity Options
  4 = CICS Options for SPIs
  5 = DB2/IMS/MQ Options
  6 = Task Options
  7 = Natural Options

CICS Sysid: EJ02   CICS Applid: IYDZEJ02   TermID: TC47

F1=Help   F2=       F3=Exit   F4=       F5=       F6=
F7=       F8=       F9=       F10=      F11=      F12=Exit
```

Figure 12-1 CICS IA CINT transaction

To set the collection for Affinity options, we much choose Option **8**, which then displays the panel in Figure 12-2 on page 248.

```

CIU270 CICS Interdependency Analyzer for z/OS - V2R2M0      2009/06/01
      CICS Affinities Options for                09:44:56AM
      CICS Sysid :EJ02  CICS Applid : IYDZEJ02

Modify the options and press Enter to update, or PF12 to Cancel.

Detect affinity types: Y=Yes, N=No or blank=default

Inter-Transaction
ENQ, DEQ . . . . Y TS QUEUE . . . . Y ADDRESS CWA. . . Y
RETRIEVE WAIT. . Y LOAD . . . . . Y GETMAIN SHARED . Y
CANCEL . . . . . Y

Transaction-System
INQUIRE, SET . . Y ENABLE, DISABLE. Y EXTRACT. . . . Y
COLLECT STATS . Y PERFORM . . . . Y RESYNC . . . . . Y
WAIT . . . . . Y DISCARD . . . . Y CREATE . . . . . Y
CSD . . . . . Y

CICS Sysid: EJ02  CICS Applid: IYDZEJ02  TermID: TC47

F1=      F2=      F3=Exit  F4=      F5=      F6=
F7=      F8=      F9=      F10=     F11=     F12=Cancel

```

Figure 12-2 Resource options panel for CICS IA

From this panel, we can set the Affinity detection options on for both Inter-Transaction and Transaction System Affinities, which enables us to scope the amount of effort that is required to resolve any affinities. It is worth noting that you can resolve an affinity by making a system-related change, as opposed to an application-related change, for example, having to amend program code. One example of this is to move any queue related activity, for example, TS or TD, to a queue-owning region.

12.3 Loading the DB2 database with the collected affinity data

CICS Interdependency Analyzer provides you with a number of supplied jobs to load your collected data into the DB2 tables. The CICS IA Affinity data is loaded by the sample job CIUAFFLD, as shown in Example 12-1.

Example 12-1 CICS IA CIUAFFLD sample JCL

```

//CIUAFFLD JOB USER=JAMESE,NOTIFY=JAMESE,
//          CLASS=A,MSGCLASS=Y,REGION=0M
//*
//*
//*****
//*
//* JCL NAME = CIUAFFLD

```



```

/*
/* DESCRIPTIVE NAME = IBM CICS INTERDEPENDENCIES UTILITY
/* LOAD THE AFFINITY TABLES FROM AFFINITY VSAM
/* FILES , CIUAFF1/2/3
/* AFFINITY FILES CREATED BY CICS/IA
/*
/* CHANGES TO BE MADE
/* PLEASE CONSULT WITH YOUR DB2 ADMINISTRATOR
/*
/* 1) CHANGE THE JOB CARD TO SUIT YOUR SYSTEM CONVENTIONS
/* 2) CHANGE THE FOLLOWING PARAMETERS:-
/*
/* DG2F
/* THE DB2 ID
/*
/* CICSTS.CICS.IA.V31.INC38
/* THE HLQ FOR CIU PRODUCT
/*
/* SYS2.DB2.V810.SDSNLOAD
/* THE DATASET HLQ FOR DB2 SDSNLOAD
/*
/* REDTOOLS.CICSIA
/* THE HLQ FOR THE CIA AFFINITY FILES. THESE FILES ARE
/* CREATE AS PART OF THE CICS AFFINITIES UTILITY
/*
/* 81
/* FOR THE PLAN SHOULD BE REPLACED WITH THE FIRST 2 DIGITS
/* OF THE DB2 VERSION NUMBER
/*
/* DSN8102F.RUNLIB.LOAD
/* TO THE DATASET HLQ FOR DB2 RUNLIB.LOAD
/*
/* YOU MAY ALSO WISH TO REVIEW THE SCIUSQL(CIUSPCDB)MEMBER.
/*
/* 3) EDIT THE SCIUCLIS MEMBER CIUDB2BT AND CHANGE THE FOLLOWING:-
/*
/* ANTZ.CICS.IA.V31.INC38
/* THE HLQ FOR CIA PRODUCT
/*
/* 4) IF YOU WISH TO UPDATE THE DATABASE WITH THE LAST USAGE
/* COUNTS THEN CHOOSE PARM(UPDATE)
/*
/* 5) You can load Affinities for a region by selecting an APPLID
/* Enter ALL for all APPLIDs or the APPLID to be loaded
/* No entry is treated the same as ALL
/******
/* @start_copyright@
/* Licensed Materials - Property of IBM
/*
/* "Restricted Materials of IBM"
/*
/* 5697-J23
/*
/* (c) Copyright IBM Corp. 2004, 2007 All Rights Reserved.
/*
/* US Government Users Restricted Rights - Use, duplication or
/* disclosure restricted by GSA ADP Schedule Contract with
/* IBM Corp.
/* @end_copyright@
/******
/* CHANGE HISTORY
/*
/* PN= REASON REL YMMDD HDXIII: REMARKS
/* -----
/* £L0= H274130 300 040601 hdej: Date Created

```

```

//* EP1= 00050    300 040725 hdej:  Load affinity data tables      *
//* EP2= 00079    300 040725 hdej:  Set region to 0M              *
//* EP3= PK02704  300 050505 hdej:  New affinity files            *
//* EP4= 00230    2100 050606 hdej:  Update to CIUBTCH4           *
//* EP5= 00244    2100 050628 hdej:  Change CAU to CIU all        *
//* EL6= 00235    2100 050923 hdej:  Add new jobcard.            *
//* EP6= 00363    2100 051003 hdej:  COrrrect EXEC in STEP00      *
//* EP7= 00478    2100 051026 hdjah: Add DD for SCIULODE          *
//* EL7= 00806    2200 070516 hd-nsm: Add step - total number of rows *
//* EP8= 00822    2200 070606 hd-mxs: Add DB2 plan customization  *
//* EP7= PK72394  2200 081002 hd-ej:  New update for CIU_RESOURCE *
//* EP8= 01158    2200 081216 hd-ej:  Add SYSREC06               *
//* EM1= 001189   3100 090128 hdej:  Remove .SDSNLOAD and.RUNLIB.LOAD*
//*****
//JCLLIB  JCLLIB  ORDER=DSN8102F.PROCLIB
//JOBLIB  DD DSN=ANTZ.CICS.IA.V31.INC38.SCIULOAD,
//          DISP=SHR
//          DD DSN=ANTZ.CICS.IA.V31.INC38.SCIULODE,
//          DISP=SHR
//          DD DSN=SYS2.DB2.V810.SDSNLOAD,
//          DISP=SHR
//          DD DSN=DSN8102F.RUNLIB.LOAD,
//          DISP=SHR
//*****
//*-----
//*          RUN THE BATCH PROGRAM CIUUREG
//*-----
//STEP000 EXEC PGM=IKJEFT1B,
//          DYNAMNBR=20,
//          PARM=('%CIUDB2BT','SYS(DG2F)','PROG(CIUUREG)',
//          'PLAN(REDIADD)')
//*-----
//*          IF YOU WISH TO UPDATE THE DATABASE WITH THE LAST USED
//*          TIME STAMP FOR EACH DB2 ROW THEN CHOOSE PARM(UPD)
//*-----
//SYSPROC DD DSN=REDTOOLS.REDTST41.SCIUCLIS,
//          DISP=SHR
//SYSUDUMP DD SYSOUT=*
//SYSTSIN DD DUMMY
//SYSTSPRT DD SYSOUT=*
//SYSABOUT DD SYSOUT=*
//SYSOUT DD SYSOUT=*
//CIUCNTL DD DSN=REDTOOLS.CICSIA.CIUCNTL,
//          DISP=SHR
//*****
//STEP010 EXEC PGM=IKJEFT1B,
//          DYNAMNBR=20,
//          PARM=('%CIUDB2BT','SYS(DG2F)','PROG(CIUAFFL1)',
//          'PLAN(REDIADD)','PARM(UPDATE)')
//          'PLAN(REDIADD)')
//*-----
//*          IF YOU WISH TO UPDATE THE DATABASE WITH THE LAST USAGE
//*          COUNTS THEN CHOOSE PARM(UPDATE)
//*-----
//SYSPROC DD DSN=REDTOOLS.REDTST41.SCIUCLIS,
//          DISP=SHR
//SYSUDUMP DD SYSOUT=*
//SYSTSIN DD DUMMY
//SYSTSPRT DD SYSOUT=*
//SYSABOUT DD SYSOUT=*
//SYSOUT DD SYSOUT=*
//CIUAFF1 DD DSN=REDTOOLS.CICSIA.CIUAFF1,
//          DISP=SHR
//CIUAFF2 DD DSN=REDTOOLS.CICSIA.CIUAFF2,
//          DISP=SHR

```

```

//CIUAFF3 DD DSN=REDTOOLS.CICSIA.CIUAFF3,
//          DISP=SHR
//CIUCNTL DD DSN=REDTOOLS.CICSIA.CIUCNTL,
//          DISP=SHR
/** Enter ALL for all APPLIDs or the APPLID to be loaded
/** No entry is treated the same as ALL
//APPLID DD *
/*
//SYSPRINT DD SYSOUT=*
//SYSUDUMP DD SYSOUT=*
/*-----
/**          RUN SQL QUERIES FOR DB2 TABLES
/*-----
//CIUSPACE EXEC PGM=IKJEFT01
//SYSPRINT DD SYSOUT=*
//SYSTSPRT DD SYSOUT=*
//SYSTSIN DD *
DSN SYSTEM(DG2F)
  RUN PROGRAM(DSNSTEP2) PLAN(DSNSTEP81) PARMS('/ALIGN(LHS) MIXED') -
  LIB('DSN8102F.RUNLIB.LOAD')
END
/*
//SYSIN DD DSN=REDTOOLS.REDTST41.SCIUSQL(CIUSPCAF),
//          DISP=SHR
/*-----
/**          UPDATE THE CIU_RESOURCE TABLE
/*-----
//CIUUNLD EXEC PGM=IKJEFT01
//SYSTSPRT DD SYSOUT=*
//SYSREC DD DUMMY
//SYSTSIN DD *
DSN SYSTEM(DG2F)
  RUN PROGRAM(DSNIAUL) PLAN(DSNIB81) PARMS('SQL') -
  LIB('DSN8102F.RUNLIB.LOAD')
//SYSPRINT DD SYSOUT=*
//SYSPUNCH DD DUMMY
//SYSUDUMP DD SYSOUT=*
//SYSRECO0 DD DSN=&&DATA0,DISP=(,PASS),
//          UNIT=SYSDA,SPACE=(CYL,(200,15),RLSE)
//SYSRECO1 DD DSN=&&DATA1,DISP=(,PASS),
//          UNIT=SYSDA,SPACE=(CYL,(200,15),RLSE)
//SYSRECO2 DD DSN=&&DATA2,DISP=(,PASS),
//          UNIT=SYSDA,SPACE=(CYL,(200,15),RLSE)
//SYSRECO3 DD DSN=&&DATA3,DISP=(,PASS),
//          UNIT=SYSDA,SPACE=(CYL,(200,15),RLSE)
//SYSRECO4 DD DSN=&&DATA4,DISP=(,PASS),
//          UNIT=SYSDA,SPACE=(CYL,(200,15),RLSE)
//SYSRECO5 DD DSN=&&DATA5,DISP=(,PASS),
//          UNIT=SYSDA,SPACE=(CYL,(200,15),RLSE)
//SYSRECO6 DD DSN=&&DATA6,DISP=(,PASS),
//          UNIT=SYSDA,SPACE=(CYL,(200,15),RLSE)
//SYSPUNCH DD SYSOUT=*
//SYSIN DD DSN=REDTOOLS.REDTST41.SCIUSQL(CIURS8U),
//          DISP=SHR
/*-----
//CIURLD EXEC DSNUPROC,
//          SYSTEM=DG2F,
//          UID='CIUAFFLD',
//          UTPROC=' '
//SYSUT1 DD UNIT=SYSDA,SPACE=(CYL,(200,15),RLSE)
//SORTOUT DD UNIT=SYSDA,SPACE=(CYL,(200,15),RLSE)
//SORTWK01 DD UNIT=SYSDA,SPACE=(CYL,(200,15),RLSE)
//SORTWK02 DD UNIT=SYSDA,SPACE=(CYL,(200,15),RLSE)
//SORTWK03 DD UNIT=SYSDA,SPACE=(CYL,(200,15),RLSE)
//SORTWK04 DD UNIT=SYSDA,SPACE=(CYL,(200,15),RLSE)
//SORTWK05 DD UNIT=SYSDA,SPACE=(CYL,(200,15),RLSE)

```

```
//SYSREC00 DD DSN=&&DATA0,DISP=(OLD,DELETE)
//          DD DSN=&&DATA1,DISP=(OLD,DELETE)
//          DD DSN=&&DATA2,DISP=(OLD,DELETE)
//          DD DSN=&&DATA3,DISP=(OLD,DELETE)
//          DD DSN=&&DATA4,DISP=(OLD,DELETE)
//          DD DSN=&&DATA5,DISP=(OLD,DELETE)
//          DD DSN=&&DATA6,DISP=(OLD,DELETE)
//SYSIN    DD DSN=REDTOOLS.REDTST41.SCIUSQL(CIURSV8L),
//          DISP=SHR
//
```

After the data is loaded into DB2, we can then use the CICS IA plug-in to view the affinities that were collected.

12.4 Using the CICS IA plug-in to identify affinities

After we have our data loaded into DB2, we can connect using the CICS IA plug-in to review all of the data that was collected. When we use the CICS IA perspective, as a default we should be presented with a panel that is similar to Figure 12-3 on page 253.

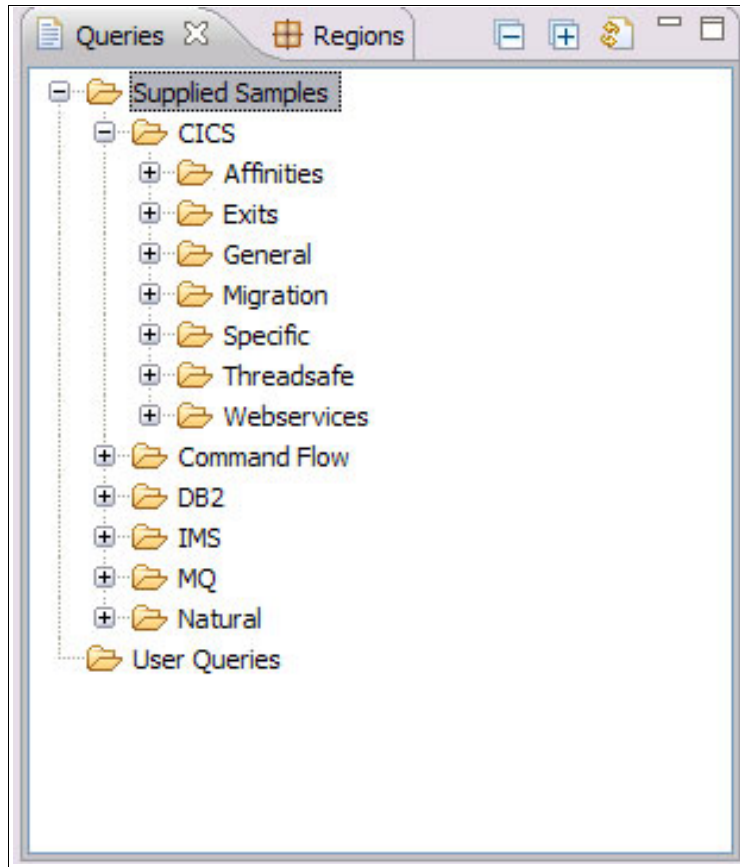

Figure 12-3 CICS IA plug-in Supplies Samples queries

The Supplied Samples that are available in the CICS IA plug-in are displayed. We are interested in the Affinities folder under the CICS samples, so we expand that to see what queries are predefined for us, as shown in Figure 12-4 on page 254.

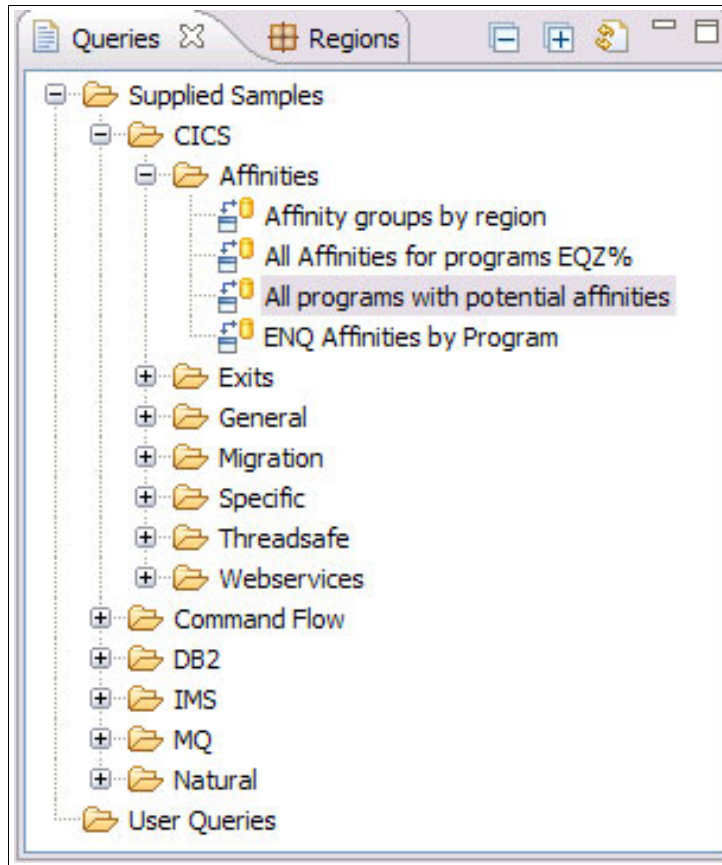

Figure 12-4 CICS IA Supplied Sample Affinity queries

There is one particularly useful query to run, so we highlighted it. If we run that query as it stands, we should be presented with a list of programs that have affinity statements, as shown in Figure 12-5 on page 255.

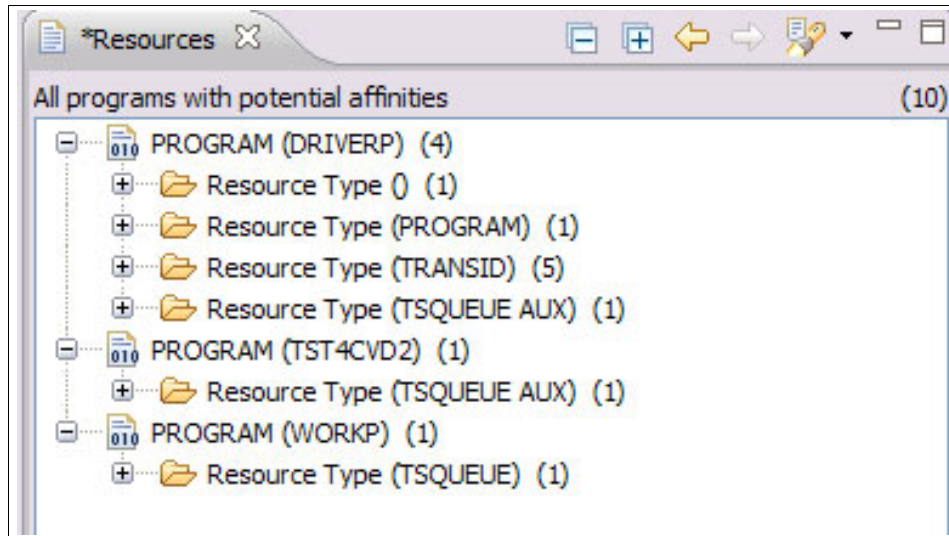

Figure 12-5 All programs with potential affinities

Now that we decided that we need to address the affinity issues, we must make decisions regarding the ability of the transactions to be CICSplex enabled.

First, we must understand what resource relationships our candidate programs are involved with. In Figure 12-6 on page 256, we can see that program DRIVERP has some transactions that are associated with it and another program, a TSQUEUE, and another as yet unidentified resource. If we expand that display, we can see the full list of resources.

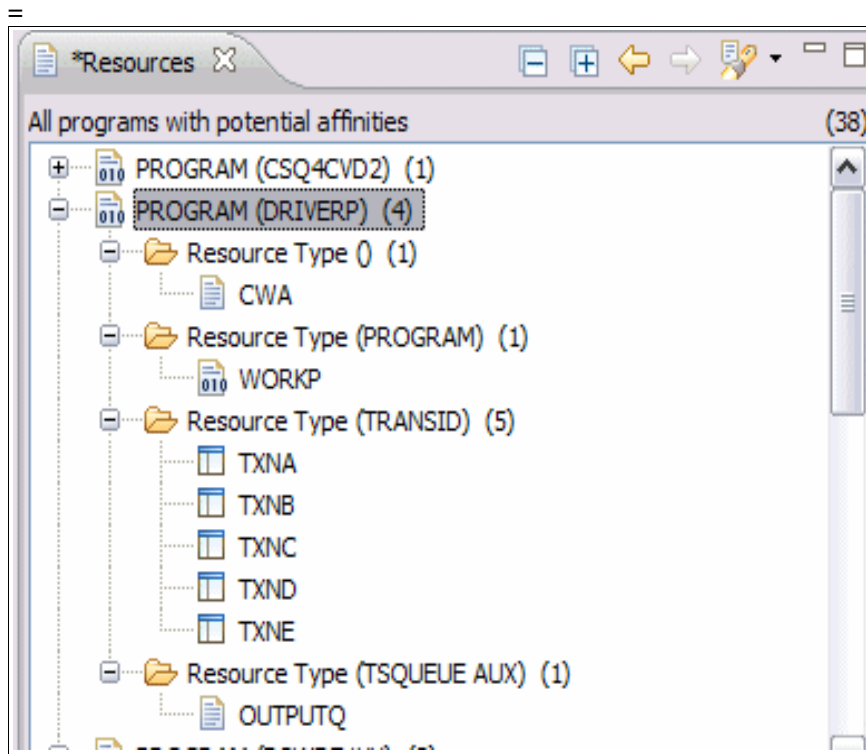

Figure 12-6 Affinities by program

We must address all of the affinity issues that are identified here, so to begin with, we want to make sure that we have all of the relevant resources that are required for this program to run successfully within a CICSplex. This lists additional transactions and an additional program. We must run the same exercise on the additional program to make sure that we covered all possibilities. If we look at program WORKP, Figure 12-7 on page 257, we can see that this program uses a TSQUEUE also. Fortunately for us, it is the same TSQUEUE that our DRIVERP program uses.

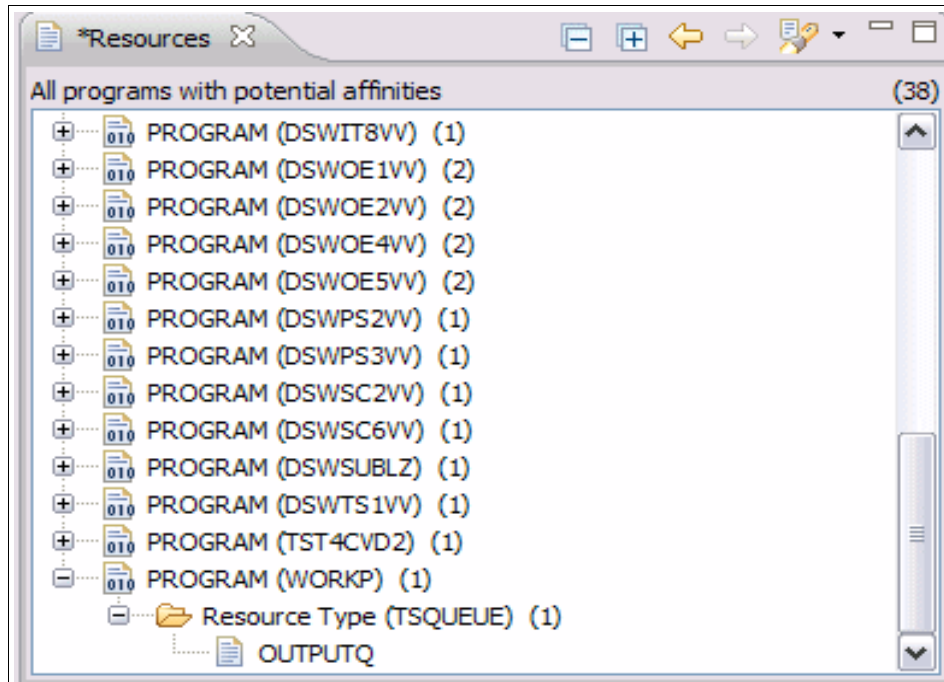

Figure 12-7 Program WORKP affinities

The CICS IA collector derived this information from a running CICS region, and there might be some other commands that were not detected. In this case, it is recommended that you use the load library scanner component of CICS IA to run against the statically defined program to ensure that no commands were excluded during this exercise.

We have two affinity issues that we must address:

- ▶ ADDRESS CWA

Our DRIVERP program uses the ADDRESS CWA command, and therefore we must examine the program further to see what type of access is used. If the CWA is being addressed in read-only mode, for example, to obtain the contents of a table, then we must ensure that the table is available to all of our target regions when we implement the workload. If you want to restrict write access to the CWA, you can specify CWAKEY=CICS, which means that CICS allocates the CWA from CICS-key storage, restricting application programs that are defined with EXECKEY(USER) to read-only access to the CWA. The only programs that are allowed to write to a CWA that is allocated from CICS-key storage are those programs that you define with EXECKEY(CICS).

▶ TSQUEUE AUX

Again, if we write to temporary storage, we must determine if there is a requirement for that to be read by any other program that is executing as part of this workload. If that is the case, we can resolve this problem by one of two methods:

- Implementing a Queue Owning Region: To define a queue as remote you must include an entry for the queue in a temporary storage table (TST) or use an appropriate TSMODEL. TS queue names are frequently generated dynamically, but they can also be unique fixed names.
- Defining a Share Temporary Storage Server: By defining Temporary Storage pools that reside in the Coupling Facility, the queues can be shared across a sysplex.

12.5 Workload management considerations

The easiest part of workload management is setting up the definitions and installing them. However, it is much more complex than that because we must understand the current configuration and what affect our changes will have on it. The first part is to decide where our dynamic workload is going to run. There is plenty of technical material that is available to help you make those decisions, so we do not go into detail here, but we summarize the steps in Figure 12-8.

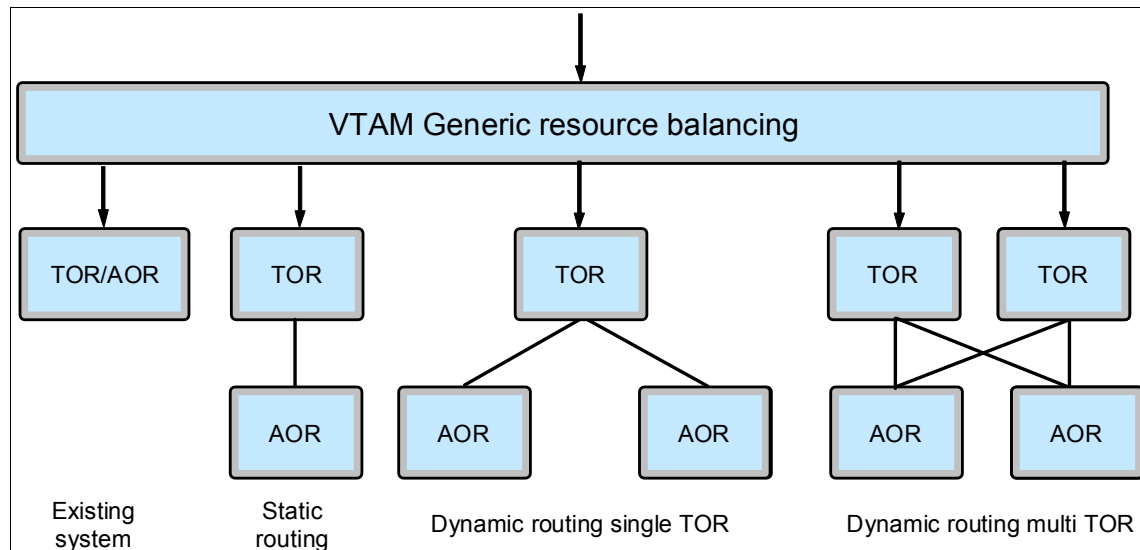

Figure 12-8 Dynamic routing exploitation

In Figure 12-8 on page 258, we show (from left to right) the stages that we can go through to fully enable our transactions to be part of a dynamic workload. The stages are:

1. Existing System: This is where our transaction runs and accesses all resources that are local to the CICS region that the transaction(s) and program(s) are defined in.
2. Static Routing: The transaction is defined with a remote attribute of Dynamic=NO in our Terminal Owning Region and is defined as Local in the Application Owning Region. The program is not normally defined in the TOR and defined as Local in the AOR. There is a RemoteSystem attribute set to the SYSID of the AOR and, optionally, a RemoteName attribute set if you want to run the transaction under a different name in the AOR.
3. Dynamic Routing Single TOR. The transaction is defined with a remote attribute of Dynamic=YES in our Terminal Owning Region and is defined as Local in the Application Owning Region. At this point, our target AORs were referenced by a TRANGRP definition within the Workload Management feature of CICSplex SM.

12.6 Creating the definitions for workload management

After we decide that we have all of the relevant resources defined for our application, we must create definitions within CICSplex SM so that we can exploit workload management. From CICS Transaction Server V3.2, the only method of creating and managing these definitions is through the CICSplex SM Web User Interface.

CICSplex SM uses a routing program to process all routing requests that are made to it. This program, EYU9XLOP, is specified in the System Initialization Table parameters DSRTPGM and DTRPGM for any CICS region that wants to participate in dynamic transaction routing.

Figure 12-9 on page 260 shows the elements that are required to define the workload management criteria for balancing, separation, and affinity processing.

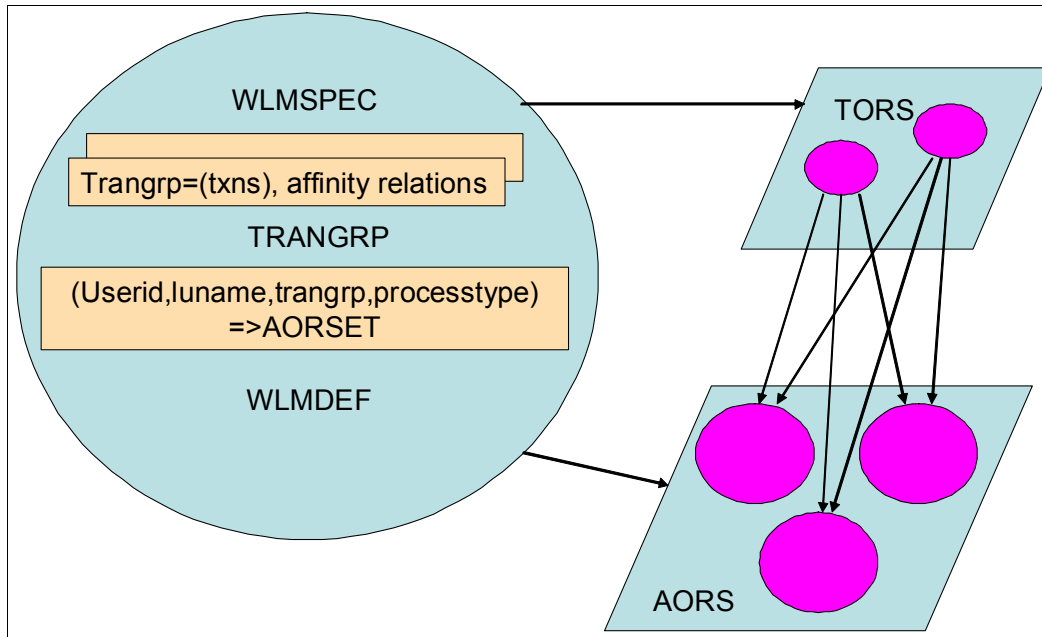

Figure 12-9 Workload management model

The elements are:

- | | |
|-----------------|---|
| TRANGRPS | These define the transactions that take place in dynamic routing and also their affinity relations. They are also used to define transactions for workload separation. |
| WLMDEFS | These specify workload and separation criteria.
TrangrpName, LUname, Userid, and Process Type. |
| WLMGROUP | These are purely for administration purposes, for example, assigning WLMGRPS to specifications. |
| WLMSPEC | These define default routing criteria, the routing algorithm to be used, and whether abend avoidance is activated (diverts workloads from a region if it is deemed to be unstable). The workload criteria are made known to the relevant regions by association of the WLMSPEC to the region, usually through a System Group. |

Figure 12-10 on page 261 shows Transactions in Transaction Groups.

The screenshot shows the 'Transactions in transaction groups' page in the CICSplex SM Web User Interface. The page title is 'Transactions in transaction groups' and it shows 6 records collected at 06/30/09 14:07:16. The context is REDBPLEX. The transaction group is TXNGRP and the transaction is TXNA. The automatic refresh is set to 60 seconds. The table below lists the transactions and their last modification times.

Record	Transaction group	Transaction	Pseudo-conversational mode	Last modification	Last modification user id
1	TXNGRP	TXNA	N_a	06/30/09 14:06:00	
2	TXNGRP	TXNB	N_a	06/30/09 14:06:19	
3	TXNGRP	TXNC	N_a	06/30/09 14:06:33	
4	TXNGRP	TXND	N_a	06/30/09 14:06:48	
5	TXNGRP	TXNE	N_a	06/30/09 14:07:09	
6	TXNGRP	TXN0	N_a	06/30/09 14:05:44	

Resource name: DTRINGRP. View name: EYUSTARTDTRINGRP.TABULAR

Figure 12-10 Transactions in Transaction Groups

In this group, Figure 12-10TXNGRP, we defined the six transactions that are part of our application. They can now be associated with target AORs by defining the relationship to the WLMGROUP and the WLMSPEC.

12.7 Migrating the definitions using CICS Configuration Manager

Now that we selected our application for CICSplex enablement, we must migrate the selected definitions from our existing single region into their target regions. If we look at the resources, Figure 12-11 on page 262, that are being used by our candidate application, we can then prepare them to be migrated.

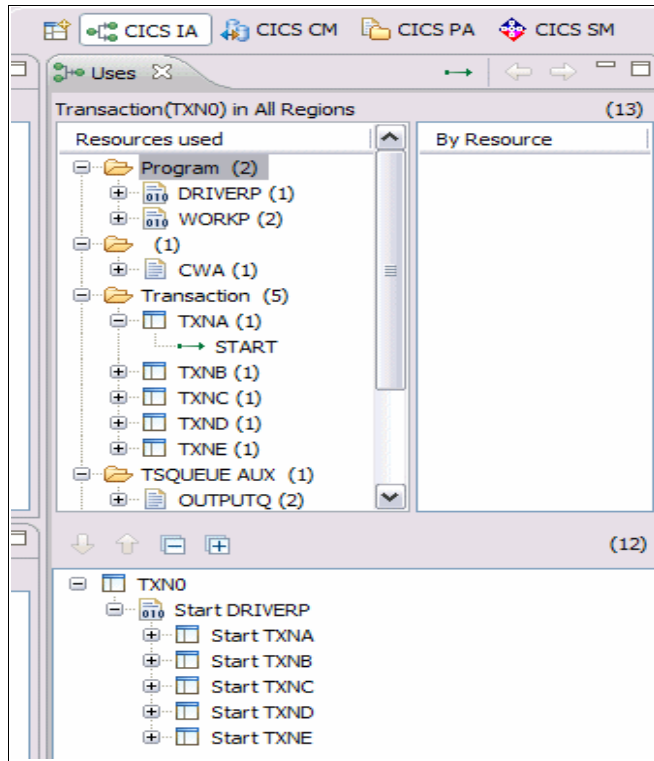

Figure 12-11 Resources captured

We can see that our application is going to require a number of programs, some mapsets, and then we have three datasets that must access from each region that the application runs in. Our decision on the datasets is to use a file-owning region so that our definitions must be migrated, which changes the attributes to remote.

From this information, we can prepare a package to be migrated in CICS Configuration Manager. To do this, we must select the resources that are identified by the data that we collected in CICS Interdependency Analyzer. These resources are then placed into a package, ready to be migrated between differing environments.

Figure 12-12 on page 263 shows the resource packaging.

```

File Menu Settings Help
ssssssssssssssssssssssssssssssssssssssssssssssssssssssssssssssssssssssssssssssssssssssss
List - All resources          Change Package TXNGRP          Row 1 to 8 of 8
Command ==>                  Scroll ==> PAGE

To prepare Scheme views, enter a Scheme on the previous panel

                          Change Package resources
                          sssssssssssssssssssssssssssssssssssssssssssssssssssssssssssss
Filter *          *          + *          *

/   Name      Type          Group   Status          Config
   DRIVERP   PROGRAM       WORKSHOP Not ready, new object REDTST41
   TXNA      TRANSACTION    WORKSHOP Not ready, new object REDTST41
   TXNB      TRANSACTION    WORKSHOP Not ready, new object REDTST41
   TXNC      TRANSACTION    WORKSHOP Not ready, new object REDTST41
   TXND      TRANSACTION    WORKSHOP Not ready, new object REDTST41
   TXNE      TRANSACTION    WORKSHOP Not ready, new object REDTST41
   TXNO      TRANSACTION    WORKSHOP Not ready, new object REDTST41
   WORKP     PROGRAM        WORKSHOP Not ready, new object REDTST41
***** Bottom of data *****

```

Figure 12-12 Resource packaging

We defined a package called NACTGRP and placed all of the required resources into it. We must now apply some transformation rules to the package before we try to migrate it. Our prime concern is that the files that we use must now be defined as REMOTE, so we can build a Transformation Rule to include in the package.

Figure 12-13 on page 264 shows a Transformation Rule.

```

File Menu Settings Help
ssssssssssssssssssssssssssssssssssssssssssssssssssssssssssssssssssssssssss
Edit                                Transform Rule
Command ==>

Name . . . . : TXNGRP
Description . .

Qualification criteria
Scheme . . . . : TXNGRP      +
Source Config . . REDTST41  +
Target Config . . REDPRD41  +
Group . . . . . : WORKSHOP
Resource Type . . TSMODEL    +
Resource Name . . OUTPUTP
Check Field . . . . .      +
Check Operator      +
Check Value . . . . .      +

Choose a Processing Option
1 1. Transform and continue
   2. Transform and lock field
   3. Transform and lock record
   4. Stop migration of this resource

Transform Field and Values
Change Field . . POOLNAME    +
Change From . . . . *      +
Change To . . . . . TSPool1  +

```

Figure 12-13 Transformation Rule

As we migrate our resources between environments, any TSQUEUE that we find in the Group that has the name of OUTPUTP has its POOLNAME field changed to the name of the pool that it needs to reside in, which in this case is TSPool1.



CICS Explorer resource manipulation scenarios

The CICS Explorer is described as “The New Face of CICS”. One of the main assets of the Explorer and the plug-ins is to introduce a whole new community to CICS and the System z in general. Traditionally, the accepted interface to CICS was always through the 3270, with its ability to perform operational tasks through the CEMT transaction (“The Master Terminal”) and resource definition tasks through the CEDA transaction (“RDO - Resource Definition Online”). With the advent of the CICS Web User Interface, CICSplex SM users can perform these tasks by an implementation of Web Services utilizing the CICSplex SM API.

The CICS Explorer, with its Eclipse-based environment, took this to another level by presenting CICS and CICSplex through a Graphical User Interface, thus giving it a very modern “look and feel” and enabling integration with a multitude of IBM Enterprise Software Portfolio products.

In this chapter, we discuss how we can manipulate resource definitions using the CICS Explorer to manage some of the scenarios that typically confront us when supporting CICS environments.

13.1 Resource locking scenarios

Resource locking is a constant factor that affects the day-to-day running of CICS applications all over the world. One of the best examples of locks being held on resources is that of the VSAM file, which has multiple users trying to update the same copy of a record. There are many programming techniques that are available today to circumvent this problem; however, they still occur on a daily basis.

13.1.1 VSAM record locking

We have an application that updates records on a VSAM file on a regular basis. In general, this runs satisfactorily throughout most of the day. However, a user calls us to say that his transaction appears to be suspended, so we must investigate. The initial window from the CICS Explorer shows us the transactions in region REDDEV41, and it appears that our problem transaction is one of the ones shown in Figure 13-1.

Region	Task ID	Dispatch ...	Terminal ID	User ID	Suspend ...	Transact...	LU Name	Priority	Class Name
REDDEV41	0000028	▶▶▶ RUNN...		CICSUSER	0:00:00	CONL		255	DFHTCLO0
REDDEV41	0000039	▶▶▶ SUSPE...		CICSUSER	5:52:32	OKAM		255	DFHTCLO0
REDDEV41	0000044	▶▶▶ SUSPE...		CICSUSER	0:00:00	COIO		255	DFHTCLO0
REDDEV41	0000045	▶▶▶ SUSPE...		CICSUSER	0:00:09	COIE		255	DFHTCLO0
REDDEV41	0000051	▶▶▶ SUSPE...		CICSUSER	5:52:32	OKTI		1	DFHTCLO0
REDDEV41	0010378	▶▶▶ SUSPE...	TC61	CICSUSER	0:01:32	NACT	IYCYTC61	1	DFHTCLO0
REDDEV41	0010395	▶▶▶ SUSPE...		CICSUSER	0:01:32	CEDP		1	DFHTCLO0
REDDEV41	0010401	▶▶▶ SUSPE...	TC62	CICSUSER	0:00:58	NACT	IYCYTC62	1	DFHTCLO0

Figure 13-1 Transactions suspended

Initially, we customize the columns so that we can see the reason for the suspend on each of our transactions. We do this by selecting the **Customize Columns** tab in the top right corner of the perspective, as shown in Figure 13-2.

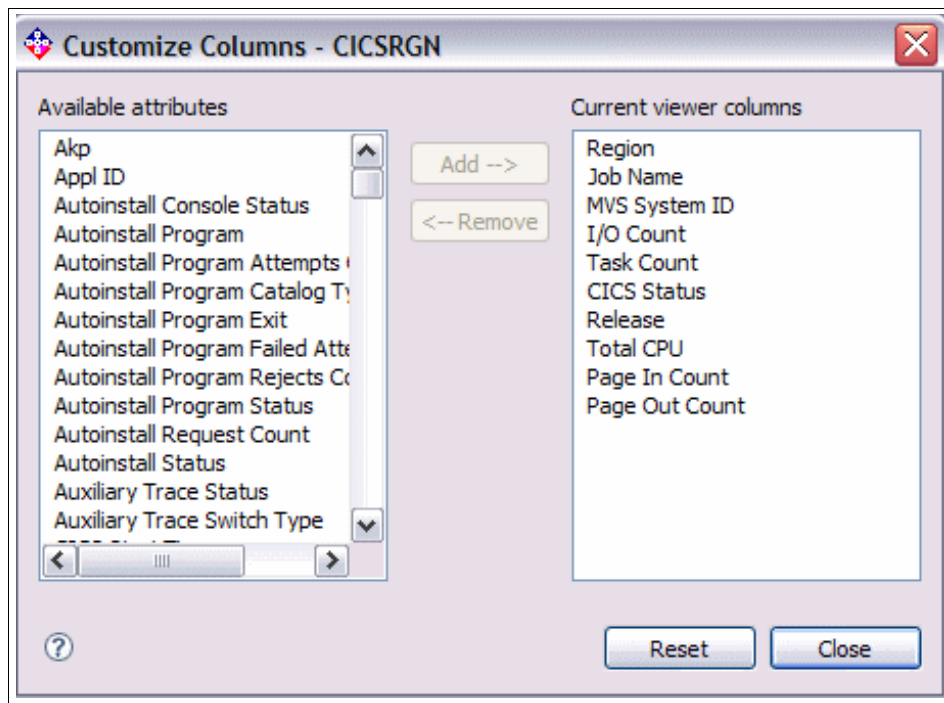

Figure 13-2 Customize columns

From here, we can add `SuspendType` and `SuspendValue` so that we have a much more efficient view of where the problem is, which results in Figure 13-3 on page 268.

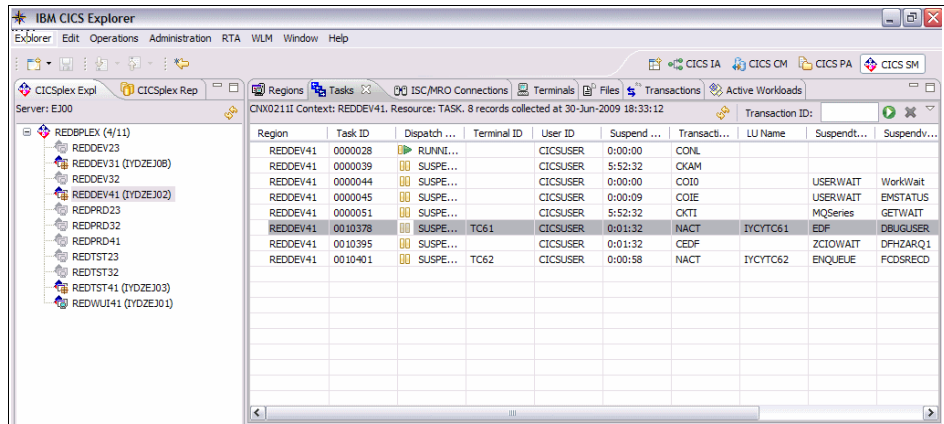

Figure 13-3 Suspend Types display

Now we can see that it appears that task 10401 issued some form of request against a dataset and is suspended with an ENQUEUE. The SuspendValue of FCDSRECD tells us there is a wait for a record lock in a VSAM file or CICS-maintained data table. If a transaction attempts to access a record that is locked by another transaction, it is suspended on resource type ENQUEUE until the lock is released. This can be a long wait because an update might depend on a terminal operator typing in data. Also, the suspended transaction relinquishes its VSAM string and, perhaps, its exclusive control of the CI, and has to wait again for those resources.

If transactions are commonly made to wait for this reason, review the programming logic of your applications to see if the record-locking time can be minimized.

So in our case, we have an earlier task, 10378, that is running the same transaction. In this case, this task has a suspend type of EDF, which means that someone is debugging this transaction and failed to release the record lock. Because we must resolve the situation quickly, we PURGE the task and see if that sorts out the problem. By right-clicking the task, we can select the option to remove the task, as shown in Figure 13-4 on page 269.

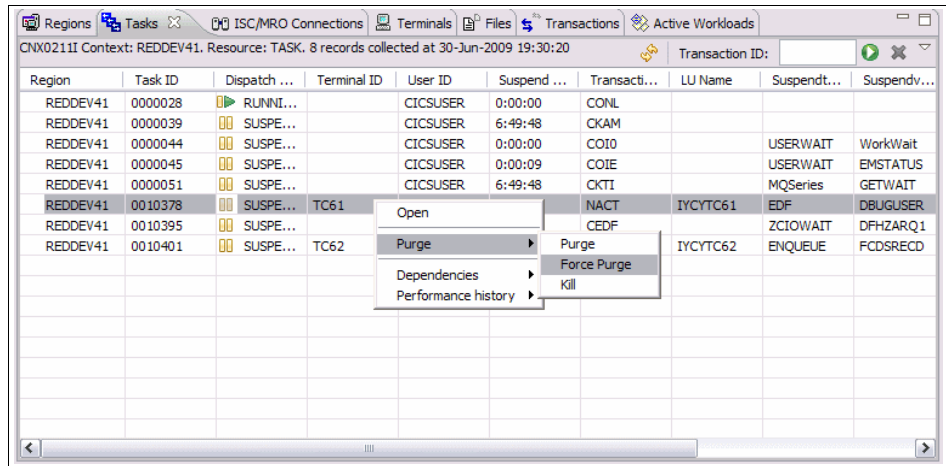

Figure 13-4 Force Purge a Task

Before we do this, we get a confirmation window to ensure that we selected the right task, as shown in Figure 13-5.

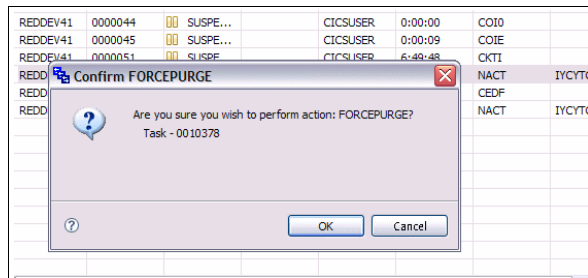

Figure 13-5 Confirm Force Purge

The operational view of our tasks now shows that the task causing the wait was purged, Figure 13-6 on page 270, and that our suspended transaction has (hopefully) completed successfully.

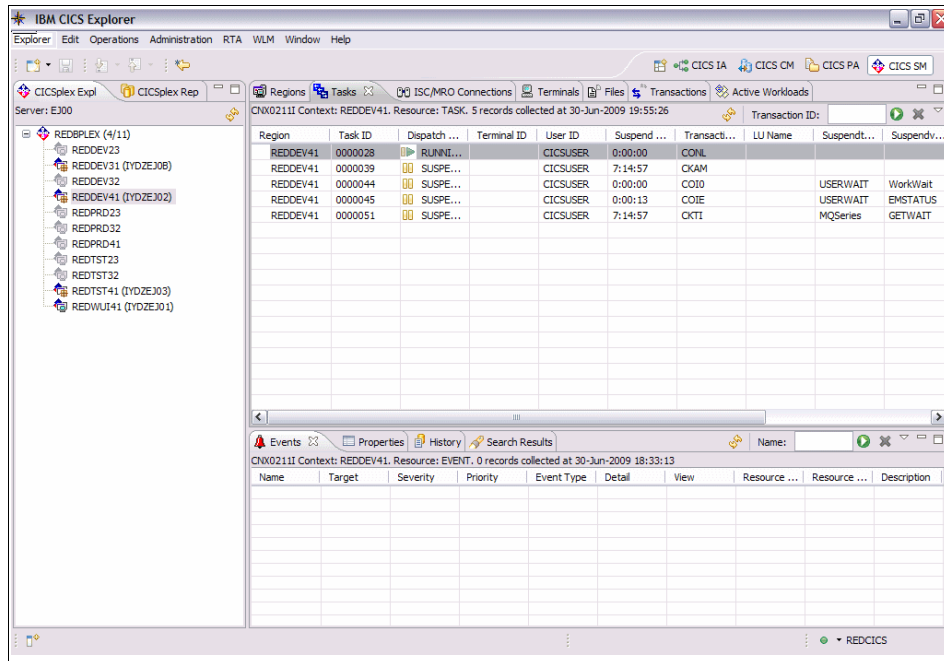

Figure 13-6 Transactions Resumed

One final task we could do is to reset the columns back to their original settings, which we do by selecting the same drop-down list from the right corner and using the **Reset Columns** option.

13.2 Resource state manipulation

When connecting the CICS Explorer for the first time, the initial perspective you get is the System Management view, shown in Figure 13-7 on page 271.

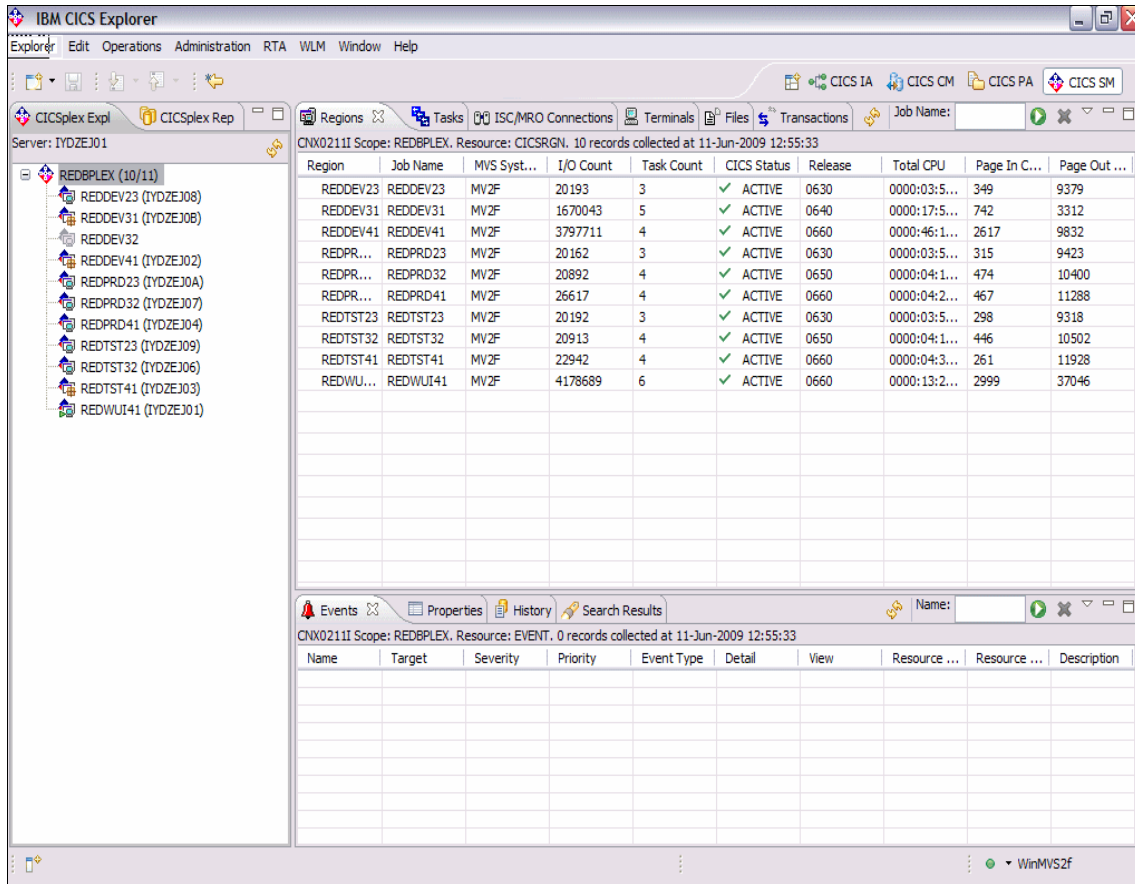

Figure 13-7 CICS Explorer System management view

From the view in Figure 13-8 on page 272, you can display all of the resources that are relevant to the CICS regions within the CICSplex. CICS regions can be individually selected just by clicking on the region name, which dynamically displays those details, or you can view the whole CICSplex by selecting the CICSplex name.

Across the top of this perspective is a list of resources that can be displayed. The default view contains a number of resources, one of them being transactions, as shown in Figure 13-8 on page 272.

If we select the **Transactions** tab, we are presented with a list of transactions that are defined, dependent upon the scope that is selected. In Figure 13-8 on page 272, we selected the CICS region REDDEV41, to reduce the amount of data displayed.

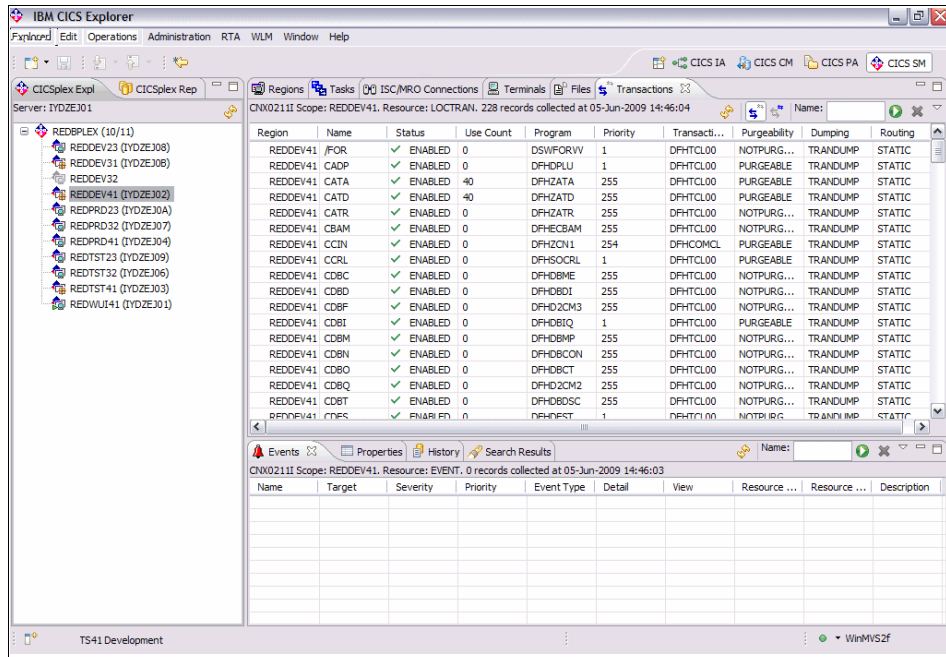

Figure 13-8 Transaction List

We still have a large list of transactions, so what we need to do is filter this down until we are presented with the transactions that we actually want to work with, which we do by entering the criteria in the filter window, shown in Figure 13-9.

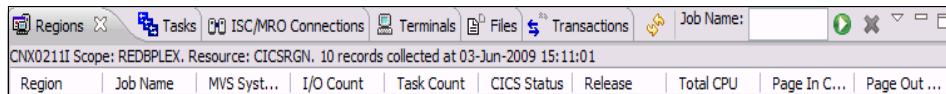

Figure 13-9 Filter window

Figure 13-10 on page 273 shows the resulting filter criteria.

Region	Name	Status	Use Count	Program	Priority	Transacti...	Purgeability	Dumping	Routing
REDDEV41	/FOR	✓ ENABLED	0	DSWFORVV	1	DFHTCL00	NOTPURG...	TRANDUMP	STATIC
REDDEV41	CADP	✓ ENABLED	0	DFHDPLU	1	DFHTCL00	PURGEABLE	TRANDUMP	STATIC
REDDEV41	CATA	✓ ENABLED	0	DFHZATA	255	DFHTCL00	PURGEABLE	TRANDUMP	STATIC
REDDEV41	CATD	✓ ENABLED	0	DFHZATD	255	DFHTCL00	PURGEABLE	TRANDUMP	STATIC
REDDEV41	CATR	✓ ENABLED	0	DFHZATR	255	DFHTCL00	NOTPURG...	TRANDUMP	STATIC
REDDEV41	CBAM	✓ ENABLED	0	DFHECBAM	255	DFHTCL00	NOTPURG...	TRANDUMP	STATIC
REDDEV41	CCIN	✓ ENABLED	0	DFHZCN1	254	DFHCOMCL	PURGEABLE	TRANDUMP	STATIC
REDDEV41	CCRL	✓ ENABLED	0	DFHSOCRL	1	DFHTCL00	PURGEABLE	TRANDUMP	STATIC
REDDEV41	CDBC	✓ ENABLED	0	DFHDBME	255	DFHTCL00	NOTPURG...	TRANDUMP	STATIC
REDDEV41	CDBD	✓ ENABLED	0	DFHDBDI	255	DFHTCL00	NOTPURG...	TRANDUMP	STATIC
REDDEV41	CDBF	✓ ENABLED	0	DFHD2CM3	255	DFHTCL00	NOTPURG...	TRANDUMP	STATIC
REDDEV41	CDBI	✓ ENABLED	0	DFHDBIQ	1	DFHTCL00	PURGEABLE	TRANDUMP	STATIC
REDDEV41	CDBM	✓ ENABLED	0	DFHDBMP	255	DFHTCL00	NOTPURG...	TRANDUMP	STATIC
REDDEV41	CDBN	✓ ENABLED	0	DFHDBCON	255	DFHTCL00	NOTPURG...	TRANDUMP	STATIC
REDDEV41	CDBO	✓ ENABLED	0	DFHDBCT	255	DFHTCL00	NOTPURG...	TRANDUMP	STATIC
REDDEV41	CDBQ	✓ ENABLED	0	DFHD2CM2	255	DFHTCL00	NOTPURG...	TRANDUMP	STATIC
REDDEV41	CDBT	✓ ENABLED	0	DFHDBDSC	255	DFHTCL00	NOTPURG...	TRANDUMP	STATIC
REDDEV41	CDFE	✓ ENABLD	0	DFHDEFST	1	DFHTCL00	NOTPURG...	TRANDUMP	STATIC

Figure 13-10 Filter criteria

If we now select the **Apply Filter** button, the results should display the transactions that we are interested in. In this case, we look for all transactions in CICS region REDDEV41 that begin with the characters NA. After applied, we get a much shorter list of transactions to work with, as shown in Figure 13-11.

Region	Name	Status	Use Count	Program	Priority	Transacti...	Purgeability	Dumping	Routing
REDDEV41	NACP	✓ ENABLED	0	NACTNA3	1	DFHTCL00	NOTPURG...	TRANDUMP	STATIC
REDDEV41	NACT	✓ ENABLED	0	NACTNA1	1	DFHTCL00	NOTPURG...	TRANDUMP	STATIC

Figure 13-11 Filter criteria applied

There is more than one method of changing the state of a particular resource. In our case, we want to disable one of our transactions. The quickest method of doing this is to select the resource in question, and then right-click, as shown in Figure 13-12 on page 274.

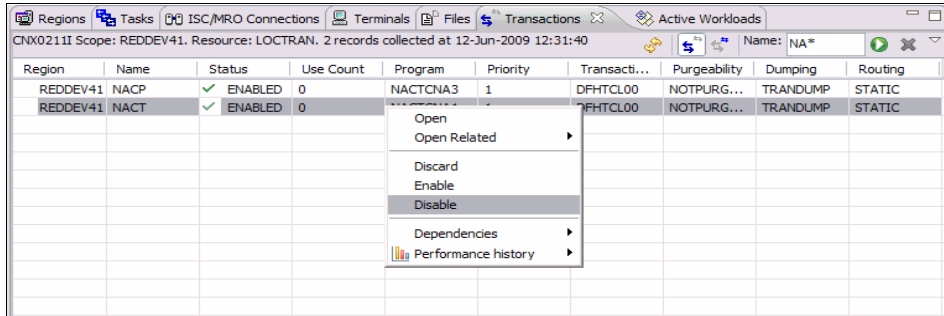

Figure 13-12 Disable a Transaction

A window is displayed that offers us a number of options, and one option is to DISABLE the transaction. If we choose that option, we receive a confirmation dialog box, Figure 13-13.

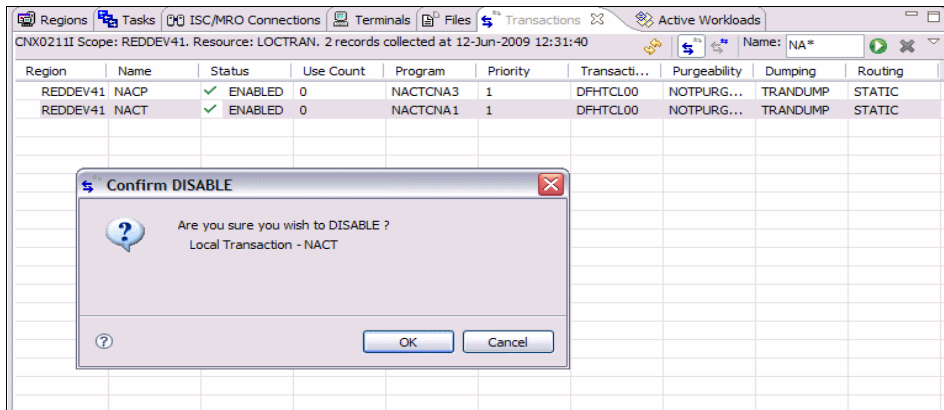

Figure 13-13 Figure 16-13 Confirm disable window

Our transaction display should automatically refresh to display the new status of the transaction, as shown in Figure 13-14 on page 275.

Region	Name	Status	Use Count	Program	Priority	Transacti...	Purgeability	Dumping	Routing
REDDEV41	NACP	✓ ENABLED	0	NACTCNA3	1	DFHTCL00	NOTPURG...	TRANDUMP	STATIC
REDDEV41	NACT	✗ DISABLED	0	NACTCNA1	1	DFHTCL00	NOTPURG...	TRANDUMP	STATIC

Figure 13-14 Transaction disabled

Let us assume that we inadvertently disabled the wrong transaction. We can use the alternative method of altering the resource to get it back into its correct state by double-clicking the resource in question. We disabled transaction NACT, so by double-clicking Figure 13-15 is displayed.

Property	Value
Basic	
Basdefiniver	0
Bridge Exit Program	
Command Security	CMDFSECNO
Data Isolation	ISOLATE
Deadlock Timeout	0
Dumping	TRANDUMP
Facility Like	
Indoubt	BACKOUT
Indoubt Action Mismatch Co	0
Indoubt Wait	WAIT
Indoubt Wait Count	0
Indoubt Wait Time	0
Local Use Count	0
Name	NACT
Operator Forced Action Cou	0
Other Forced Action Count	0
OTS Timeout	0
Priority	1
Profile	DFHCICST
Program	NACTCNA1
Purgeability	NOTPURGEABLE
Read Timeout	0
Region	REDDEV41
Release	E660
Remote Count	0
Remote Name	
Remote Start Count	0
Remote System	

Figure 13-15 Transaction Attributes

In Figure 13-15, we scroll to the attribute that we want to change and update. In this instance, it is Transaction Status that we want to alter. When we select the attribute field, we are presented with a list of the only options that are available

for this resource. In the case of Status, it can only be DISABLED or ENABLED, as shown in Figure 13-16.

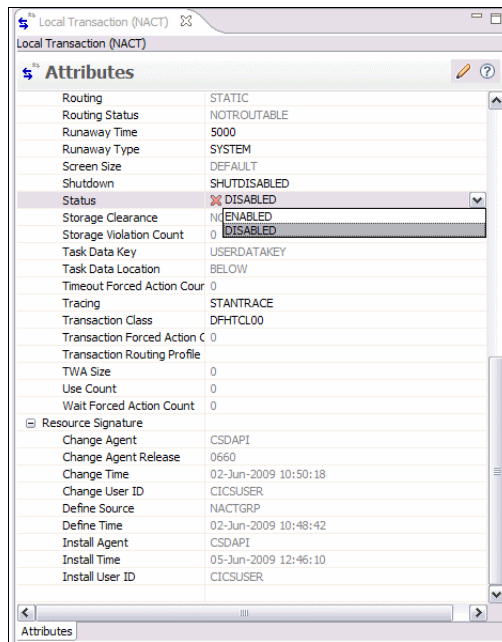

Figure 13-16 Transaction Status Attributes

We select the ENABLED status and receive a confirmation message to save the changes. On confirming this, we should have a display of our transaction list, similar to Figure 13-17 on page 277.

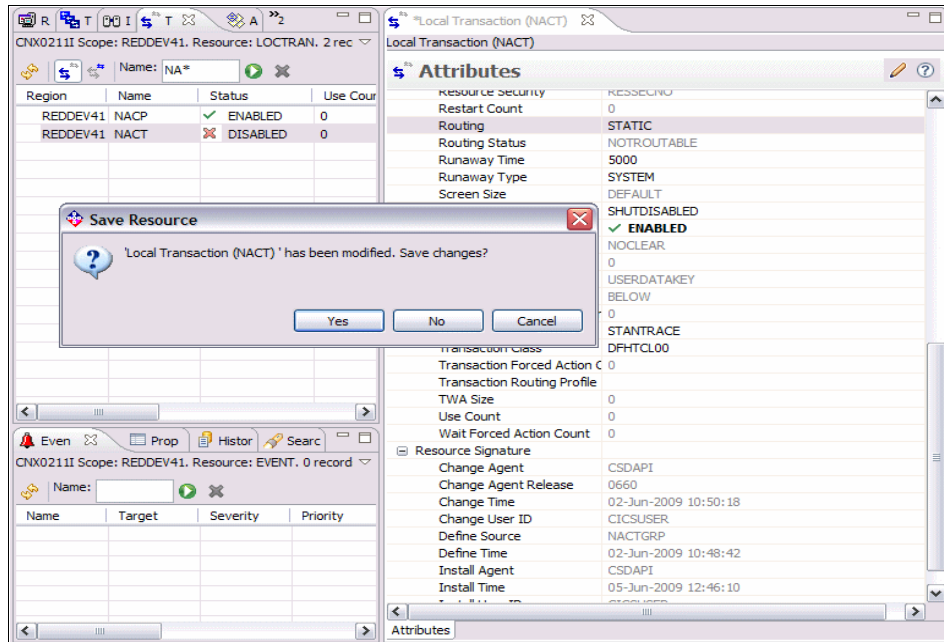

Figure 13-17 Confirmation of Save Changes

13.3 Discarding resources

One of the abilities of the CICS Explorer is to discard resources from a running CICS region. The command executes under the CICS API, effectively performing a CEMT DISCARD command.

The DISCARD command deletes the definition of a resource installed in the local CICS system, so that the system no longer has access to the resource. It reverses the effect of the installation of the resource, which can occur at system startup, through a subsequent CREATE command or CEDA transaction, by an automatic installation process or by a CICSplex SM BAS command.

Each DISCARD command removes the definition of one resource. You can remove definitions for the following types of resources.

Autoinstall models for terminals:

- ▶ Connections
- ▶ CorbaServer (CORBASERVER)
- ▶ DB2Conns
- ▶ DB2EntryS

- ▶ DB2Trans
- ▶ Deployed JAR files (DJAR)
- ▶ Document templates
- ▶ ENQ models
- ▶ Files
- ▶ Journals and journal models
- ▶ LIBRARY concatenations
- ▶ Partners
- ▶ PIPELINEs
- ▶ Process types
- ▶ Profiles
- ▶ Programs, map sets, and partition sets
- ▶ Request models
- ▶ TCP/IP service
- ▶ Temporary storage queue models
- ▶ Terminals
- ▶ Transaction classes
- ▶ Transactions
- ▶ Transient data queues
- ▶ URIMAPs
- ▶ WEBSERVICEs

You cannot discard a resource that is currently in use, for example, you cannot discard a PROFILE definition if some installed TRANSACTION definition still points to it, or a FILE that is open, or a TRANSACTION that is scheduled for execution.

In addition, some resources are not eligible for discard at all, which include resources whose names begin with the letters DFH (reserved for CICS-supplied definitions) and transactions with names that begin with C (also reserved for CICS).

Some DISCARD commands cause a sync point on behalf of the issuing task, as the CREATE commands do.

DISCARD commands are recorded in the CICS catalog so that their effects persist over a warm or emergency restart, but they do not modify the CSD file and thus are lost on a cold or initial start

If we return to our list of transactions, we can use the previous transaction, NACT, as our target. With the filter criteria still in place, refer to Figure 13-18 on page 279 to see that there are two transactions in the list.

CNX0211I Scope: REDDEV41. Resource: LOCTRAN. 2 records collected at 12-Jun-2009 12:31:40

Region	Name	Status	Use Count	Program	Priority	Transacti...	Purgeability	Dumping	Routing
REDDEV41	NACP	✓ ENABLED	0	NACTCNA3	1	DFHTCL00	NOTPURG...	TRANDUMP	STATIC
REDDEV41	NACT	✓ ENABLED	0	NACTCNA1	1	DFHTCL00	NOTPURG...	TRANDUMP	STATIC

Figure 13-18 Transaction List

Select the NACT transactions, and right-click it to bring up the pop-up window that displays our options. In this case, we DISCARD the transaction, as shown in Figure 13-19.

CNX0211I Scope: REDDEV41. Resource: LOCTRAN. 2 records collected at 12-Jun-2009 14:29:59

Region	Name	Status	Use Count	Program	Priority	Transacti...	Purgeability	Dumping	Routing
REDDEV41	NACP	✓ ENABLED	0	NACTCNA3	1	DFHTCL00	NOTPURG...	TRANDUMP	STATIC
REDDEV41	NACT	✓ ENABLED	0	NACTCNA1	1	DFHTCL00	NOTPURG...	TRANDUMP	STATIC

- Open
- Open Related
- Discard
- Enable
- Disable
- Dependencies
- Performance history

Figure 13-19 Discard a Transaction

When selecting the DISCARD option, you will get a confirmation window before you can proceed, as shown in Figure 13-20 on page 280.

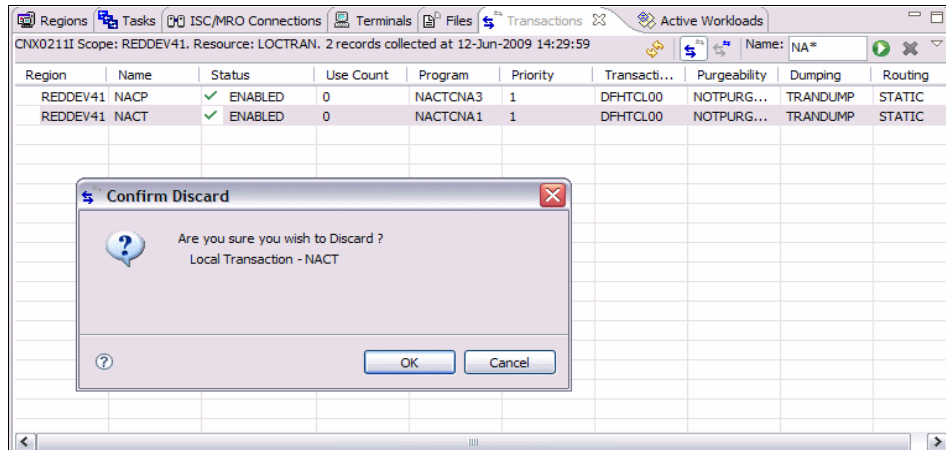

Figure 13-20 Confirm Discard window

After you confirm your action, you are presented with the transaction list again minus the resource you just discarded, as shown in Figure 13-21.

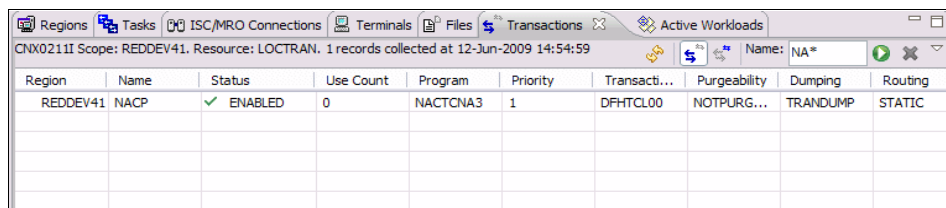

Figure 13-21 Transaction List after Discard

Let us assume that we made another mistake. We want to re-instate the transaction that we just discarded. How would we go about that? Select the Administration View from the toolbar. We receive a list of resource types that we can choose from, as shown in Figure 13-22 on page 281.

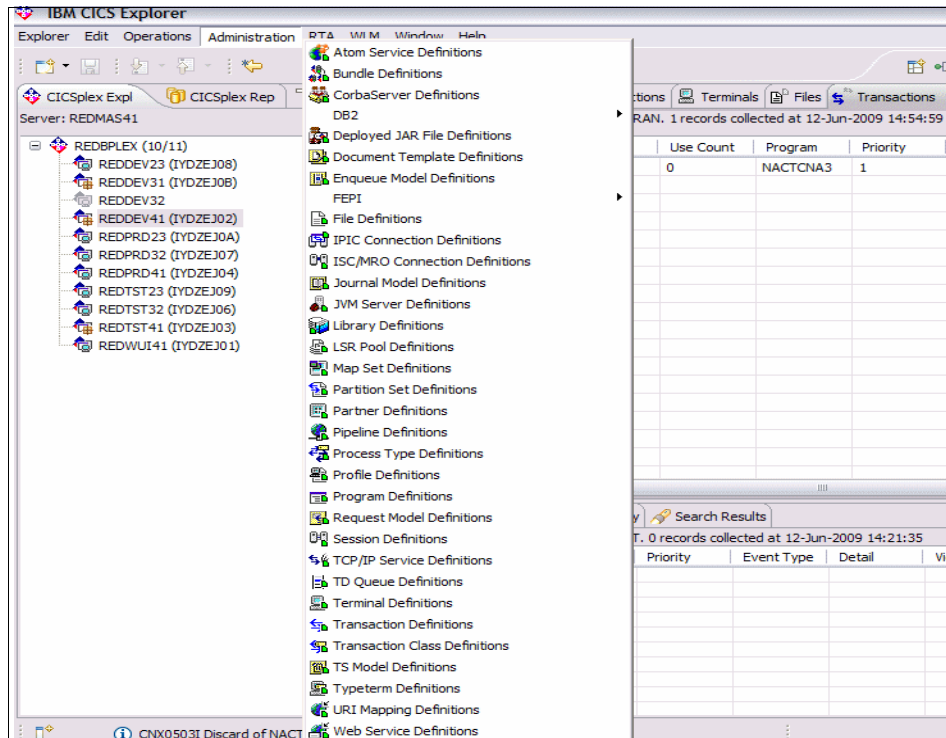

Figure 13-22 Administration Resource Options

If we select Transaction Definitions, then we are presented with a list of transactions that match our criteria. The filter that we applied in the Transaction View perspective still applies here, so we only see our filtered list.

By selecting the transaction that we just discarded, NACT, we now have an option to INSTALL it, as shown in Figure 13-23 on page 282.

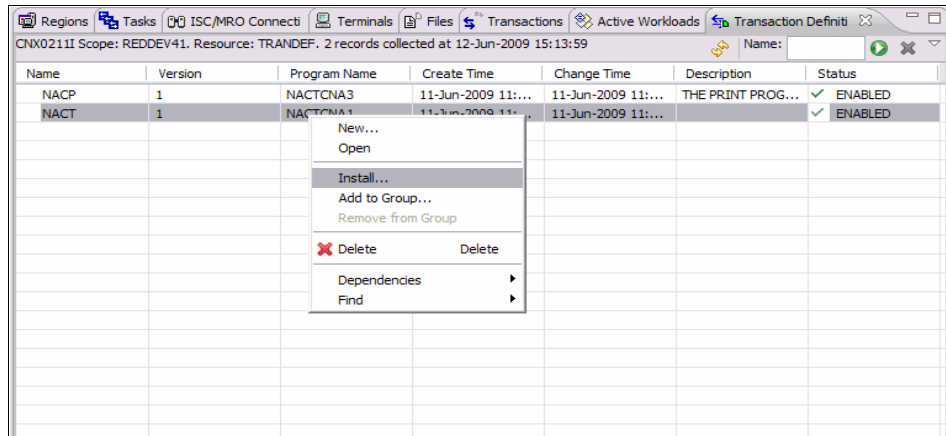

Figure 13-23 Install transaction

After we select the Install option, we are presented with a list of available regions to install it into. We choose our current region, REDDEV41, as shown in Figure 13-24.

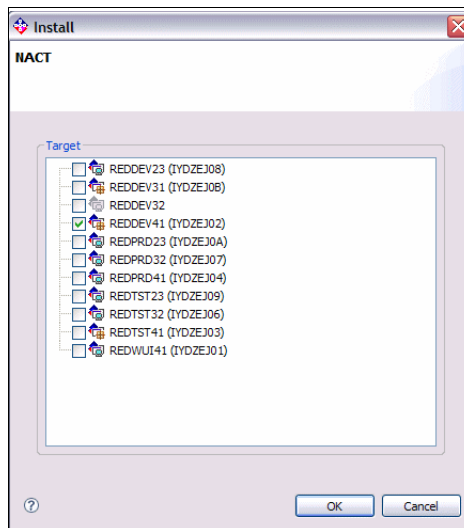

Figure 13-24 Region Selection

You should receive a message indicating the success of your install, as shown in Figure 13-25 on page 283.

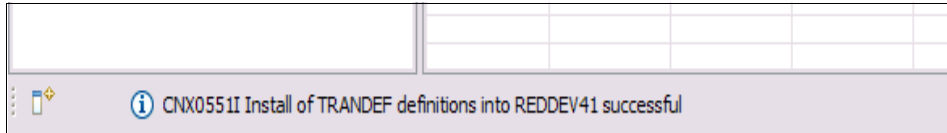

Figure 13-25 Successful Install

Let us return to our transaction list, shown in Figure 13-26. We should see that both of our transactions are now displayed. Also, if we select the Properties View, we can see that the Resource Signature details are updated to reflect the install. These attributes were introduced in CICS Transaction Server V4.1.

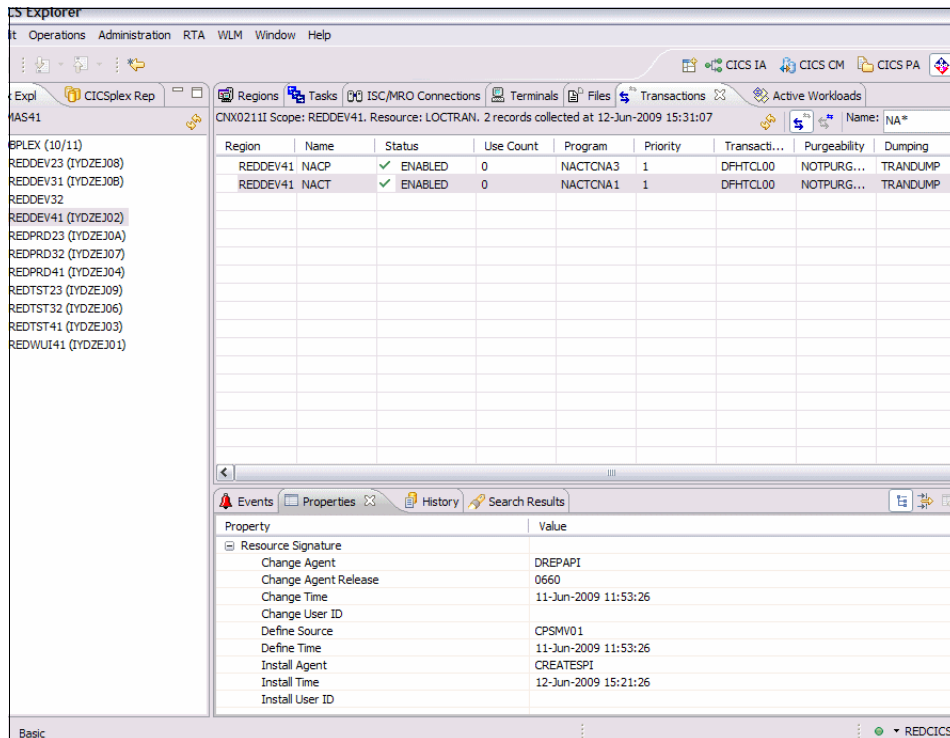

Figure 13-26 Transaction Install and Resource Signature

As we discussed earlier, you can DISCARD a number of resources. However, these resources must be in an acceptable state before we can successfully remove them. So what happens when we try to remove a resource that is currently in use by the CICS region? Let us consider the case of the CONNECTION. What conditions must exist for the connection to be successfully discarded?

The DISCARD CONNECTION command removes a CONNECTION definition from the local CICS system. When a connection is removed, all of the associated sessions also are removed.

For deletion to be successful:

- ▶ The connection can have no active sessions if it is remote (that is, has a REMOTESYSTEM value other than the name of the local region) and must be in OUTSERVICE status if it is not remote.
- ▶ The interregion communications facility must be closed if the connection is an MRO connection. You can use the SET IRC CLOSED command to close it.
- ▶ If the connection is an APPC connection and the local CICS system is a member of a VTAM® generic resource group, there can be no deferred work pending. Deferred work occurs when a failure causes a unit of work, which used a session on the connection at SYNCLEVEL 2, to be "shunted" (held for later disposition because recovery action is required before disposition can be completed).

Other types of connection can be discarded, even if there is recovery work outstanding for them; however, it is recommended that you do not discard them if there is. You can use the INQUIRE CONNECTION RECOVSTATUS command to check.

There can be no indirect CONNECTION definitions pointing to the connection to be discarded.

Note: In unusual circumstances, the discard of an LU6.1 connection can fail, even when it is out-of-service, if some of its sessions are still in-service. If this happens, set the connection status to INSERVICE, then OUTSERVICE, and then reissue the DISCARD command.

CICS completes successful DISCARD CONNECTION processing with an implicit sync point on behalf of the issuing task, committing changes to recoverable resources made up to that point in the task. If the discard processing fails, CICS raises the INVREQ exception condition with a RESP2 value of 27, and does a SYNCPOINT ROLLBACK instead, rolling back changes to recoverable resources. For all other exception conditions, however, discard processing is not attempted and SYNCPOINT nor SYNCPOINT ROLLBACK is issued.

So our attempt to DISCARD a CONNECTION should fail if it is in use. First, select a suitable connection in our current CICS region, REDDEV41, as shown in Figure 13-27 on page 285.

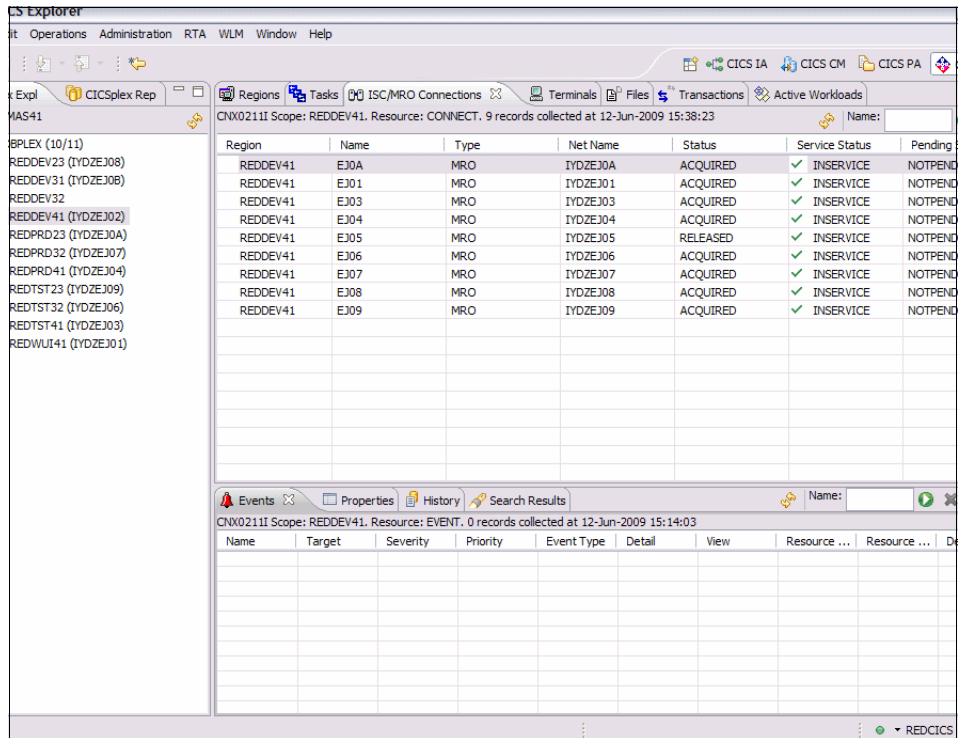

Figure 13-27 Connection List

So now let us try to DISCARD the connection. Right-click to display the pop-up window with all of the options available. Notice in Figure 13-28 on page 286 that there are many more options for this resource than there were for our transaction.

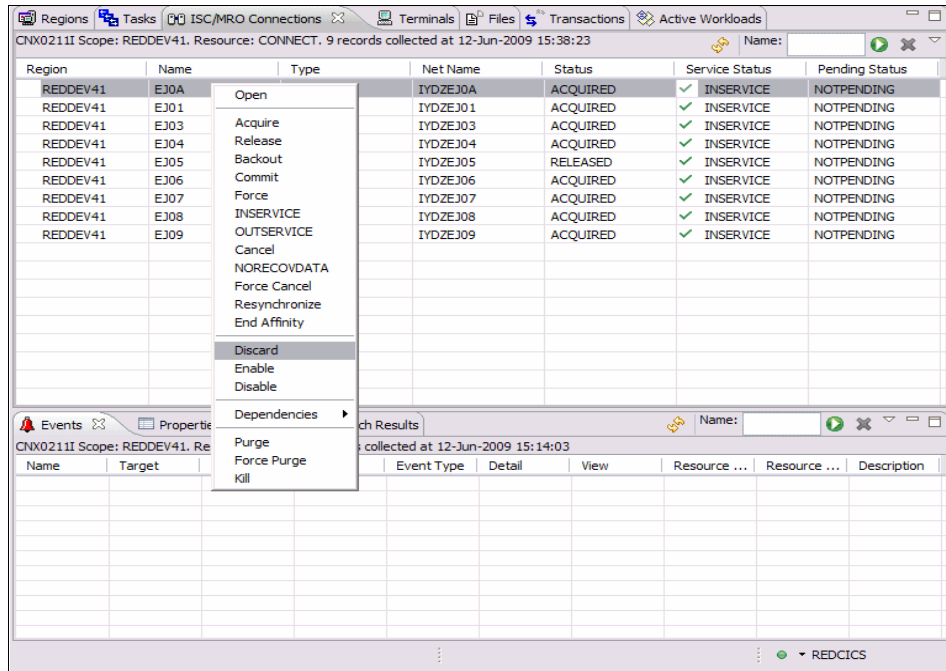

Figure 13-28 Discard a Connection

We receive a confirmation panel for the command that we are trying to execute, as shown in Figure 13-29.

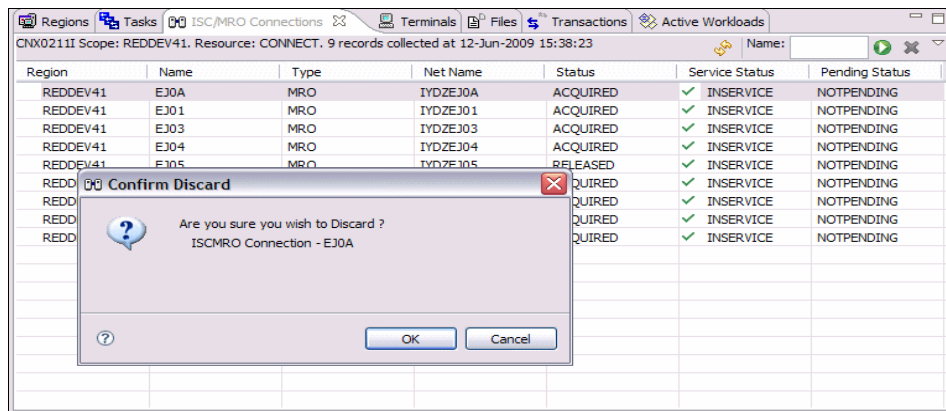

Figure 13-29 Confirm Discard Connection

This time, our DISCARD command will fail, and we should receive a message telling us the reason why, as shown in Figure 13-30 on page 287.

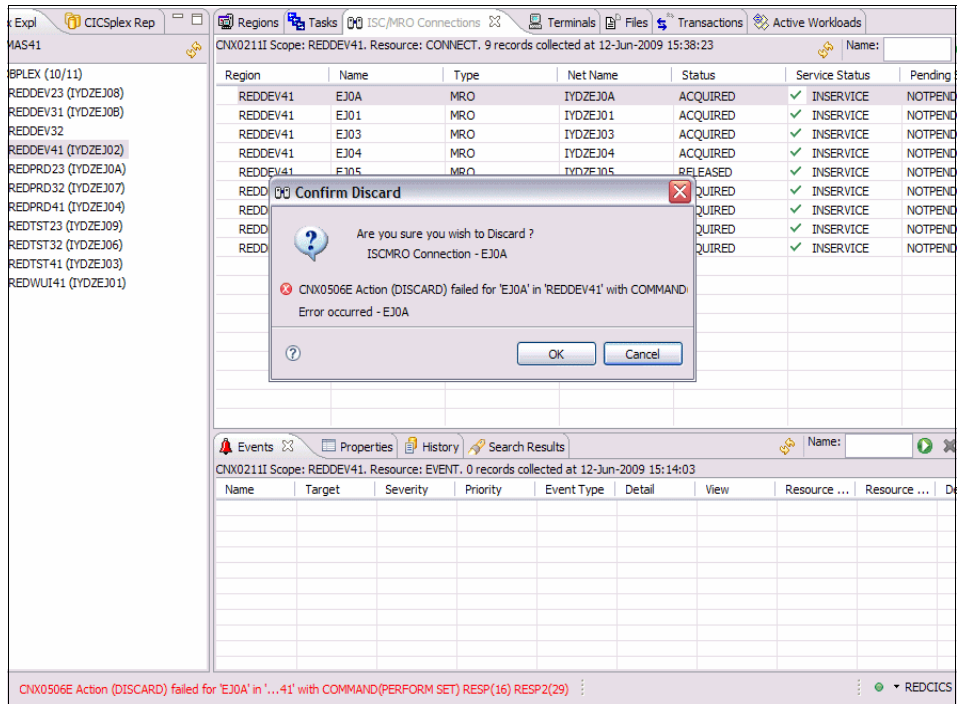

Figure 13-30 Discard Connection Failure

We receive a message in the pop-up panel telling us that our DISCARD command was not successfully executed, but the information bar on the perspective details more of the failed command. It describes the failure and includes the RESP and RESP2 values that were recorded. In this instance, our RESP code has a value of 16, which signals the INVREQ condition, and the RESP2 code has a value of 29, which signals that the connection is an MRO connection and the IRC is not closed.

Related publications

The publications listed in this section are considered particularly suitable for a more detailed discussion of the topics covered in this book.

IBM Redbooks

For information about ordering these publications, see “How to get Redbooks” on page 290. Note that some of the documents referenced here may be available in softcopy only:

- ▶ *Migration Considerations for CICS Using CICS CM, CICS PA, and CICS IA*, SG24-7294-00
- ▶ *IBM CICS Interdependency Analyzer*, SG24-6458-01
- ▶ *CICS Performance Analyzer*, SG24-6063-00
- ▶ *Threadsafe Considerations for CICS*, SG24-6351-02

Other publications

These publications are also relevant as further information sources:

- ▶ *CICS Interdependency Analyzer for z/OS, User's Guide and Reference*, SC34-6790-02
- ▶ *IBM CICS Configuration Manager for z/OS, User's Guide*, GC34-6777-04
- ▶ *IBM CICS Performance Analyzer for z/OS, User's Guide*, SC34-7046-01

Online resources

This Web site is also relevant as further information sources:

Installation Guide:

<https://publib.boulder.ibm.com/infocenter/cicsts/v4r1/index.jsp>

How to get Redbooks

You can search for, view, or download Redbooks, Redpapers, Technotes, draft publications and Additional materials, as well as order hardcopy Redbooks publications, at this Web site:

ibm.com/redbooks

Help from IBM

IBM Support and downloads

ibm.com/support

IBM Global Services

ibm.com/services



CICS Explorer

(0.5" spine)
0.475" <-> 0.875"
250 <-> 459 pages



CICS Explorer



Learning about the CICS Explorer

IBM Customer Information Control System (CICS) Explorer is the new face of CICS Integration point for CICS tooling with rich CICS views, data, and methods.

Using CICS Explorer plug-ins for tools integration

Are you looking for new ways to accelerate the transfer of knowledge, skills, and best practices to the next generation of technical staff and experts? Do you need to maintain productivity and protect service-levels? CICS Explorer and System z lead the way to platform simplification.

Exploiting the CICS Explorer with usage scenarios

IBM CICS Explorer has a common, intuitive, Eclipse-based environment for architects, developers, administrators, system programmers, and operators. The task-oriented views provide integrated access to a broad range of data and control capabilities, and it also has powerful, context-sensitive resource editors.

In this IBM Redbooks publication, we focus on the new CICS Explorer. The first part of the book is an overview of the CICS Explorer along with all of the CICS Tools' plug-ins. In the second part of the book, we focus on different scenarios in which you can use the CICS Explorer with the CICS Tools plug-ins to resolve different problems.

INTERNATIONAL TECHNICAL SUPPORT ORGANIZATION

BUILDING TECHNICAL INFORMATION BASED ON PRACTICAL EXPERIENCE

IBM Redbooks are developed by the IBM International Technical Support Organization. Experts from IBM, Customers and Partners from around the world create timely technical information based on realistic scenarios. Specific recommendations are provided to help you implement IT solutions more effectively in your environment.

For more information:
ibm.com/redbooks