

IBM WebSphere DataPower SOA Appliances

*Simplify, Help Secure & Govern Your
SOA*



Smart
SOA

Ad van den Boogaard
Technical Sales Specialist
advanden@au1.ibm.com

WebSphere DataPower SOA Appliances

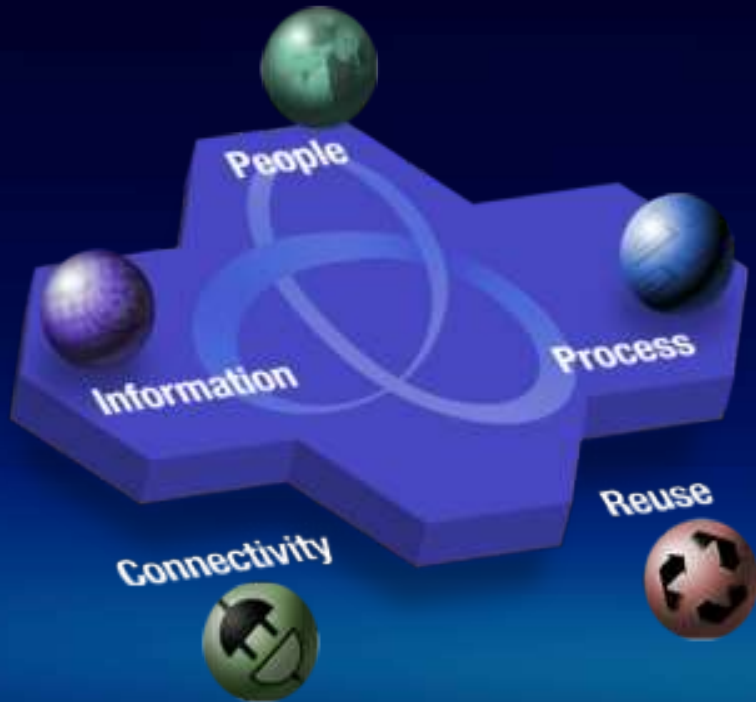

An SOA Appliance...



Creating customer value through extreme SOA connectivity, performance and security

- **Simplifies** SOA and accelerates time to value
- **Helps secure** SOA XML implementations
- **Governs and enforces** SOA/Web services policies

WebSphere DataPower SOA Appliances redefine the boundaries of middleware extending the SOA Foundation with ***specialized, consumable, dedicated SOA appliances*** that combine ***superior performance and hardened security*** for SOA implementations.

WebSphere DataPower SOA Appliances



An SOA Appliance...



Creating customer value through extreme SOA connectivity, performance and security

- Simplifies SOA and accelerates time to value
- Helps secure SOA XML implementations
- Governs and enforces SOA/Web services policies

WebSphere DataPower SOA Appliances redefine the boundaries of middleware extending the SOA Foundation with **specialized, consumable, dedicated SOA appliances** that combine **superior performance and hardened security** for SOA implementations.

What are the Painpoints?

XML is the foundation of SOA, but brings new challenges:

Scalability: XML is bandwidth, CPU, and memory intensive

Performance: some XML apps literally grind to a halt

Security: connecting systems never before connected

Security: clear text over HTTP with no inherent security

Integration: connecting Web services to legacy applications

Standards: are still in flux

Governance: ability to manage your SOA

- Businesses want to deploy secure XML-based applications...but security adds further bulk to the application that slows it down.
- Businesses want to move to standards-based XML...but XML is bulky which can cause performance bottlenecks.
- Businesses want to integrate their new Web Services to each other and to existing legacy applications...but they don't want to do it point to point because that diminishes the flexibility that SOA is supposed to bring.
- Businesses want to manage and monitor their Web Services in the same way as server up/down but SOA management is more than just management from an IT perspective— achieving a level of control, policy, and governance.

DataPower SOA Appliances Are Not . . .

- Regular rack mount servers with some pre-loaded software
- Running a full standard operating system
- Traditional network packets (below layer 7)
- Java-based
- Application servers, which typically provide business logic for specific functions such as customer relationship management or sales force automation
 - XML processing is the common element found across these applications
 - DataPower appliances add headroom and scalability, allowing application servers to process business logic while leveraging a common platform for the heavy lifting that comes with XML processing and security
- Routers, load balancers or IP firewall replacements
 - DataPower augments existing network infrastructure by adding a layer of intelligent infrastructure to the enterprise network
 - Devices are IP-addressable and designed to be deployed alongside existing network infrastructure without requiring adjustments to network topology

Why an Appliance for SOA?

- **Hardened, specialized hardware for helping to integrate, secure & accelerate SOA**
- **Many functions integrated into a single device:**
 - *Impact: connectivity will require service level management, routing, policy, transformation*
- **Higher levels of security assurance certifications require hardware:**
 - *Example: government FIPS Level 3 HSM, Common Criteria*
- **Enables run-time SOA governance and policy enforcement**
 - *Impact: dynamically control service availability, security, performance, and endpoint selection*
- **Higher performance with hardware acceleration:**
 - *Impact: ability to perform more security checks without slow downs*
- **Addresses the divergent needs of different groups:**
 - *Example: enterprise architects, network operations, security operations, identity management, web services developers*
- **Simplified deployment and ongoing management:**
 - *Impact: reduces need for in-house SOA skills & accelerates time to SOA benefits*
- **Proven Green / IT Efficiency Value**
 - *Example: Appliance performs XML and Web services security processing as much as 72x faster than server-based systems*
 - *Impact: Same tasks accomplished with reduced system footprint and power consumption*

WebSphere DataPower SOA Appliances Address Critical Connectivity Issues

Simplicity



Robustness

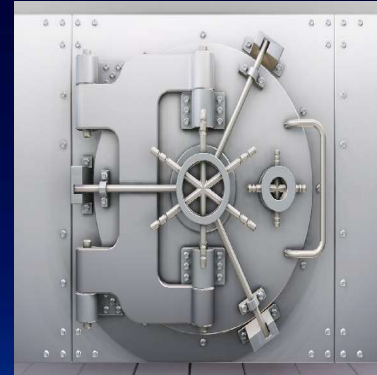

Governance



Speed



Meet the Family..

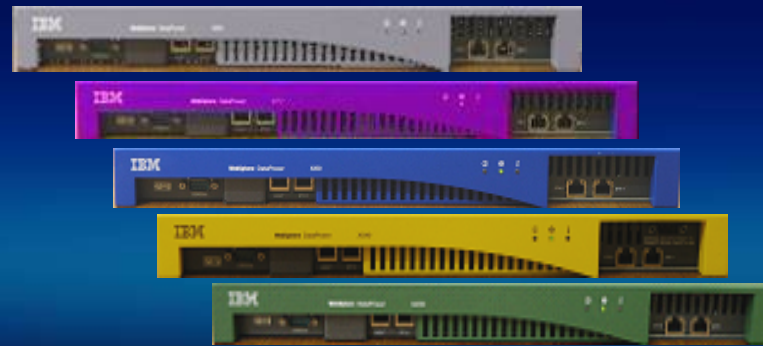

Meet the Family..

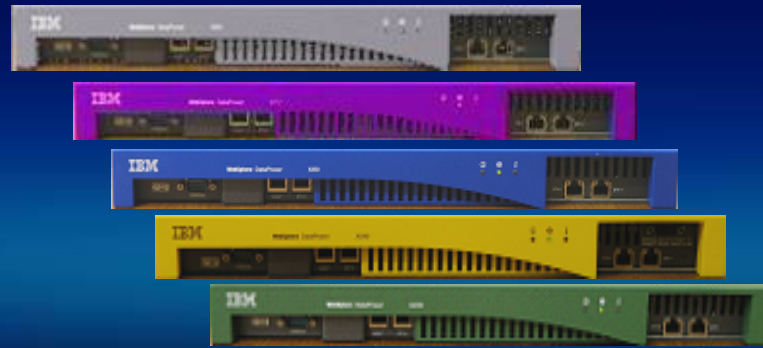

← XA35

XML Accelerator XA35

Centralized XSLT Management, Offload XML Processing



- Wirespeed XML/XSLT/XPath Processing
- Schema validation, XML compression, XML caching
- SSL termination and acceleration
- Easy configuration and administration



Accelerates XML processing and SSL termination/acceleration, increasing throughput, decreasing latency, and reducing server workload.



Innovative XML pipeline processing and XML caching reduce impact of increased XML traffic, improving scalability of resource intensive applications.



Performs XML schema validation to ensure incoming/outgoing XML documents are legitimate and properly structured.



Fully integrated with industry standard IDEs such as Altova XML Spy and Eclipse allows developers to design, debug and deploy against a single XML and XSLT processor, saving valuable cycles from pilot to production.

Meet the Family..

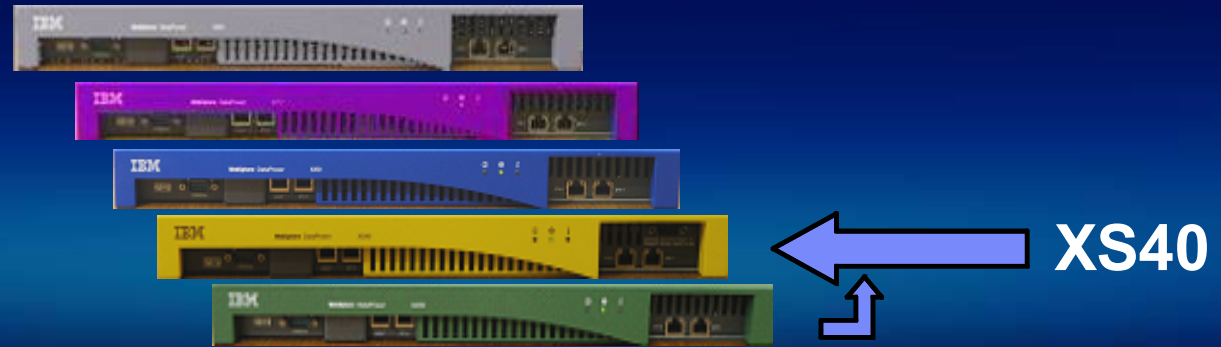

XML Security Gateway XS40

Web service threat protection and message security

- Centralizes XML security and policy enforcement
- Hardened security appliance for DMZ deployments
- Configuration-driven interface reduces need for specialized SOA skill sets
- Heterogeneous interoperability enables secure integrations with partners, customers, and/or vendors



Secures next-generation applications with an XML and SOAP firewall that filters any content, metadata, or network variables at wirespeed.



Validates XML schemas and messages, protecting against XML attacks, buffer overflows, or vulnerabilities in malformed XML documents.



Provides field-level XML security through encryption/decryption and signing/verification of entire messages or individual XML fields.



Supports a variety of access control mechanisms, and can control access by rejecting unsigned messages and verifying signatures within SAML assertions.

Comprehensive Web Services & XML Security

- Encryption of transport layer - HTTP, HTTPS, SSL
- XML/SOAP Firewall - Filter on any content, metadata or network variables
- Data Validation - Approve incoming/outgoing XML
- Field Level Security - WS-Security, encrypt & sign individual fields, non-repudiation
- Access Control (AAA) - enforces access policy stored in an Identity Management Solution
- Message Enrichment – Insert header info, SAML token, Kerberos token, transaction ID...
- Anti Virus Protection - integrates with corporate virus checking through ICAP protocol
- Security standards - WS-Security, WS-Policy, SAML, XACML, WS-Trust, WS-Addressing...

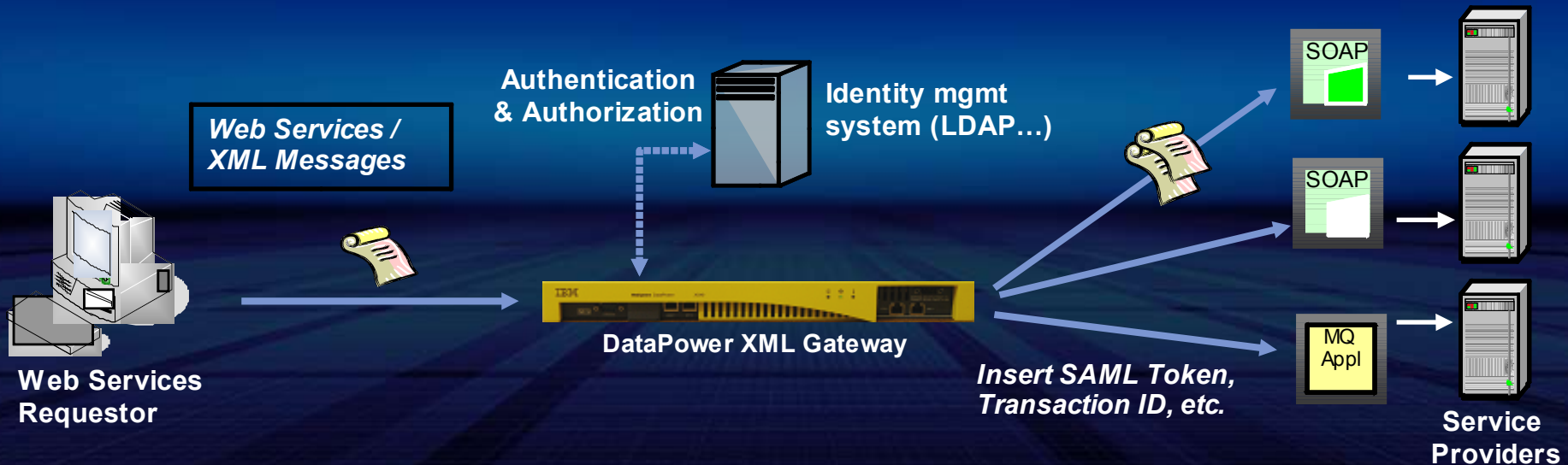

DataPower AAA Framework Diagram

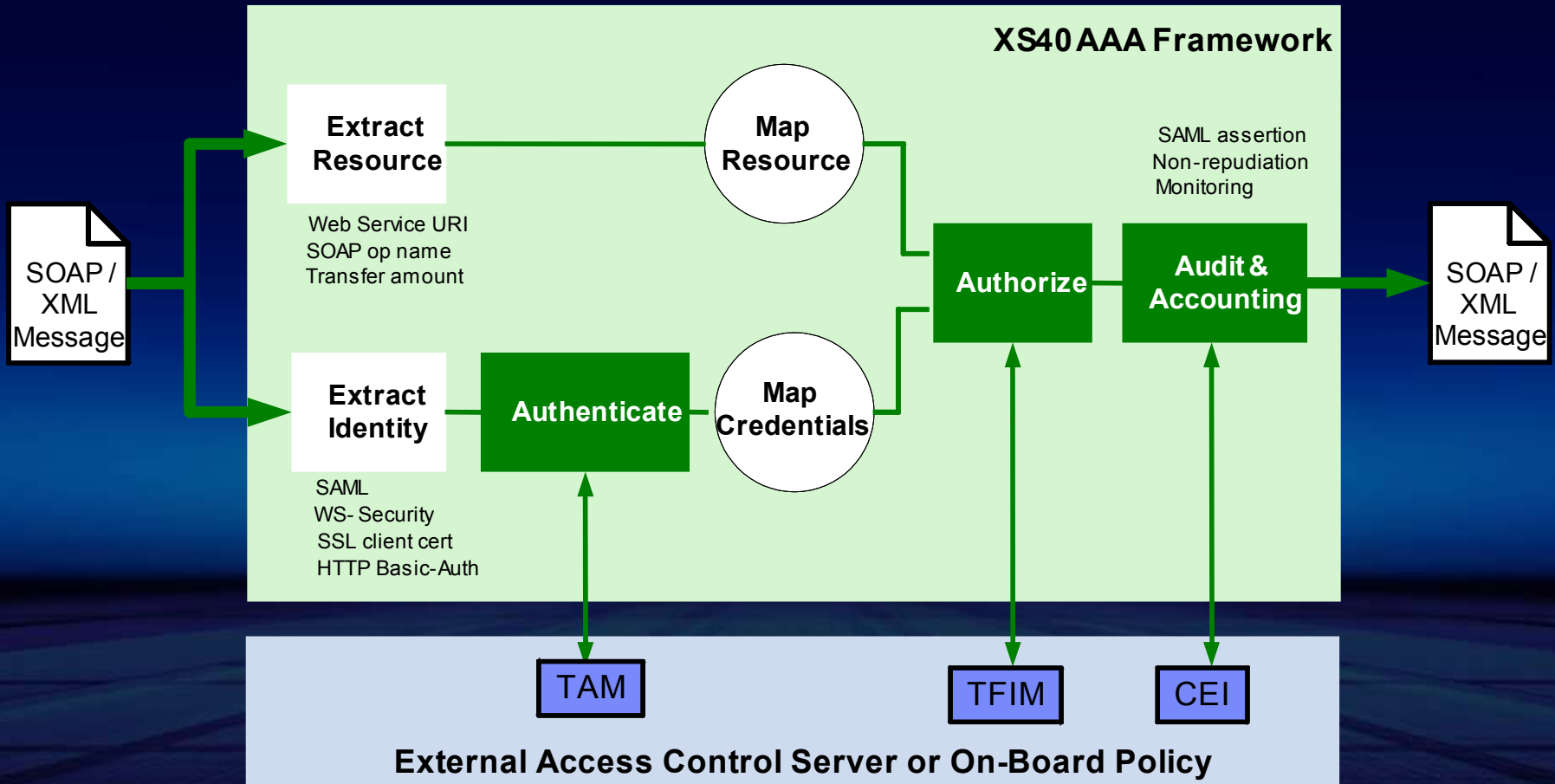

XML Threats - *Security Risks Growing*

- XML Entity Expansion and Recursion Attacks
- XML Document Size Attacks
- XML Document Width Attacks
- XML Document Depth Attacks
- XML Wellformedness-based Parser Attacks
- Jumbo Payloads
- Recursive Elements
- MegaTags – aka Jumbo Tag Names
- Public Key DoS
- XML Flood
- Resource Hijack
- Dictionary Attack
- Message Tampering
- Data Tampering
- Message Snooping
- XPath Injection
- SQL injection
- WSDL Enumeration
- Routing Detour
- Schema Poisoning
- Malicious Morphing
- Malicious Include – also called XML External Entity (XXE) Attack
- Memory Space Breach
- XML Encapsulation
- XML Virus
- Falsified Message
- Replay Attack
- ...others

SQL injection...



See: <http://www.areino.com/hackeando/>

Meet the Family..

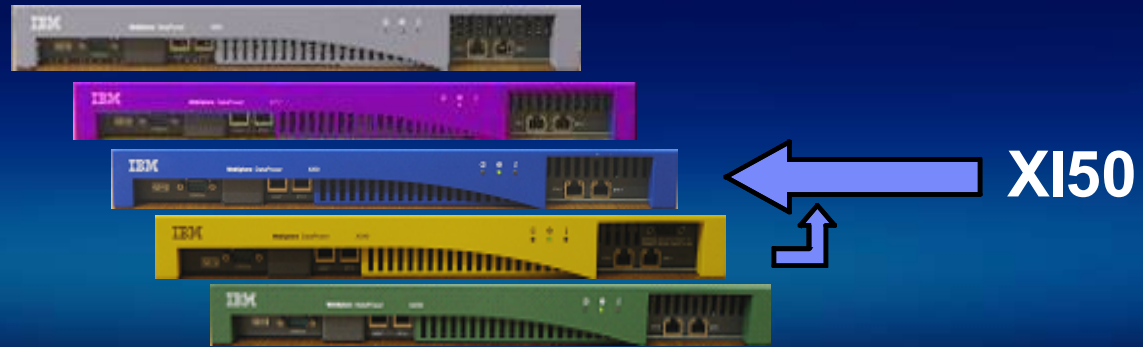

Integration Appliance XI50

Purpose-built hardware ESB for simplified deployment and hardened security



- Redefines the boundaries of middleware with specialized hardware
- Many functions integrated into a single device
- Simplified deployment and ongoing management
- Routes messages based on content and policy



Secures services on the network with sophisticated web services access control, policy enforcement, message filtering, and field-level encryption



Optimized to bridge between leading standard protocols at wirespeed, including web services, messaging, files, and database access

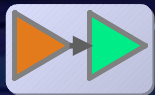

Enables transformation between a wide range of data formats, including XML, legacy, and industry standards, and custom formats



Captures and emits events to facilitate web services management and enable business visibility in Business Activity Monitoring solutions

Integration Appliance XI50

Purpose-built hardware ESB for simplified deployment and hardened security



- Redefines the boundaries of middleware with specialized hardware
- Many functions integrated into a single device
- Simplified deployment and ongoing management
- Routes messages based on content and policy



Secures services on the network with sophisticated web services access control, policy enforcement, message filtering, and field-level encryption



Optimized to bridge between leading standard protocols at wirespeed, including web services, messaging, files, and database access

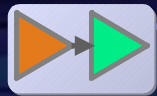

Enables transformation between a wide range of data formats, including XML, legacy, and industry standards, and custom formats



Captures and emits events to facilitate web services management and enable business visibility in Business Activity Monitoring solutions

Provide Service Enrichment The ESB

An Enterprise Service Bus (ESB) is a flexible connectivity infrastructure for integrating applications and services.

An ESB performs the following between requestor and service



MATCHES & ROUTES
communications between services



CONVERTS
between different transport protocols

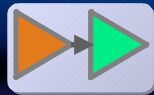

TRANSFORMS
between different data formats



IDENTIFIES & DISTRIBUTES
business events



Shape = Transport protocol
Color = Data format

Deep-Content Routing/Aggregation

- Route based on
 - IP information
 - SSL parameters
 - HTTP headers
 - XPath on XML/SOAP

- Load balancing
- Enrich and aggregate messages with data from
 - A remote Web Service
 - A database

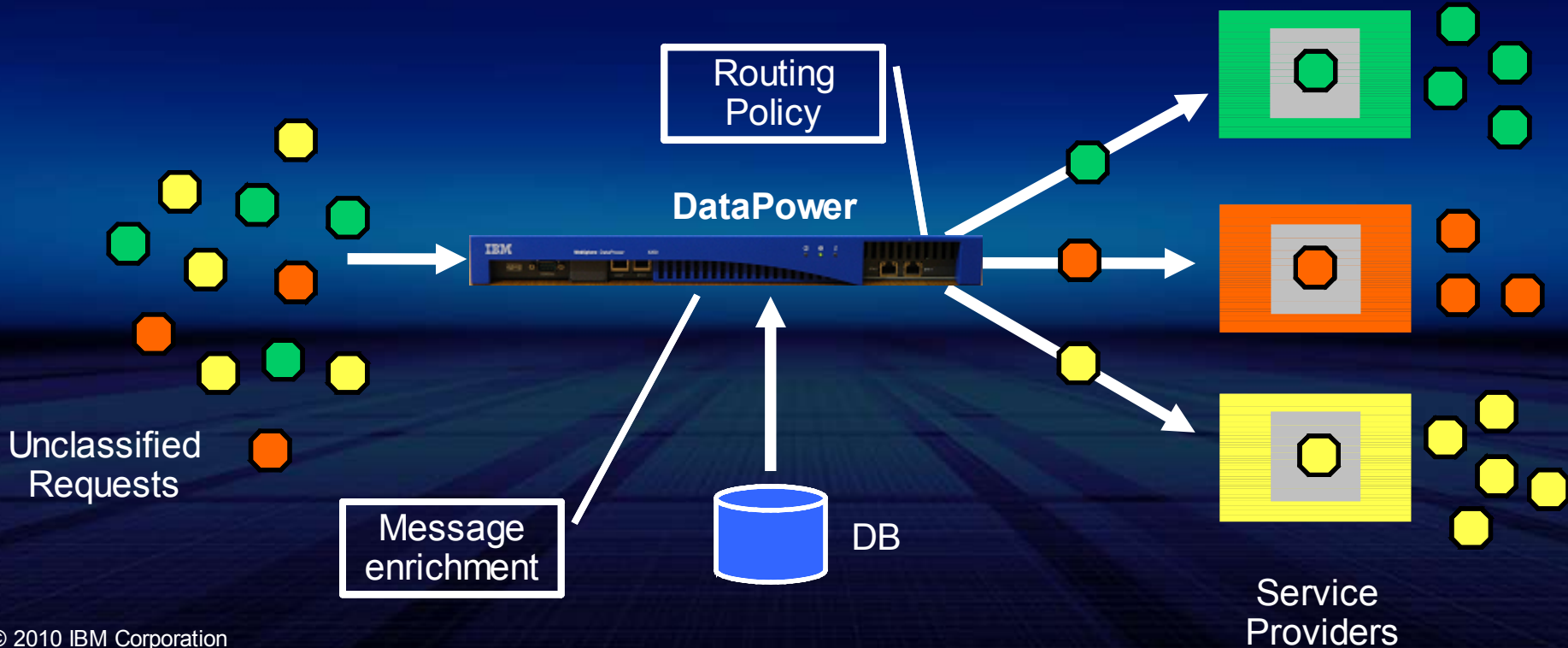

Protocol Bridging & Transformation

- Application formats

- EDI
- Binary Formats
- CORBA
- CICS
- ISO 8583
- CSV
- ASN.1
- ebXML
- Web 2.0 (REST, ATOM, AJAX)

- Transport protocols

- HTTP
- HTTPS
- MQ
- SSL
- SOAP
- Tibco
- JMS
- FTP
- FTPS
- SFTP

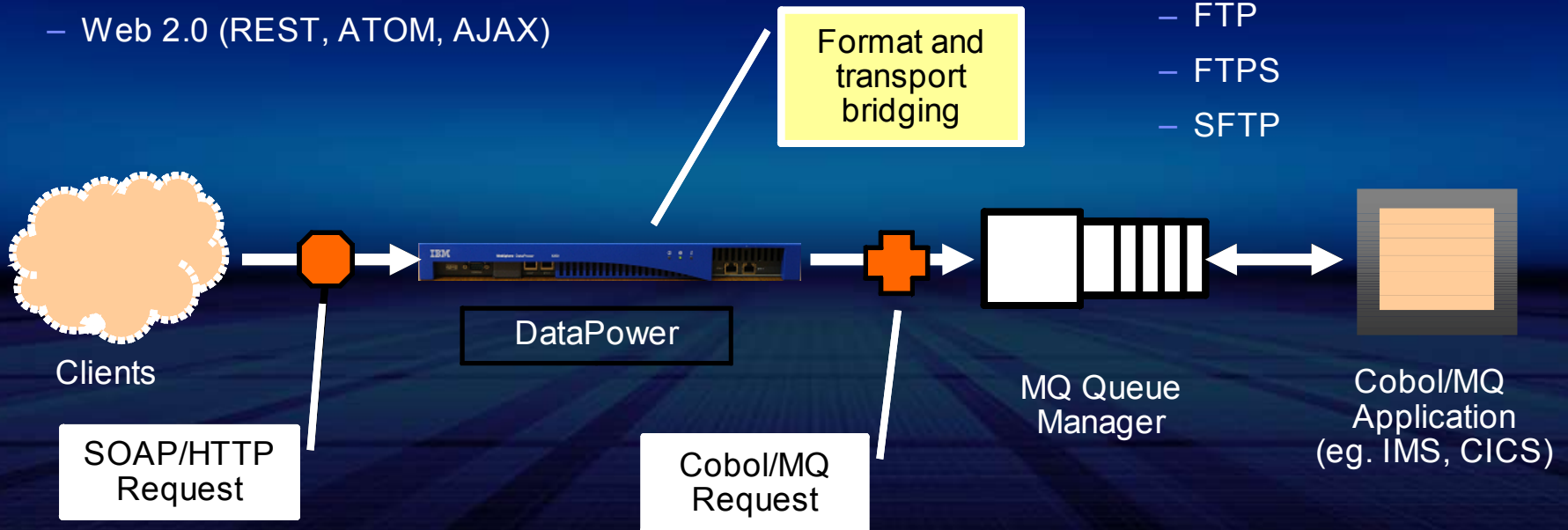

A choice of ESBs

IBM offers three ESBs to choose



Optimized with WebSphere Application server for an integrated SOA platform

ESB offerings from IBM WebSphere

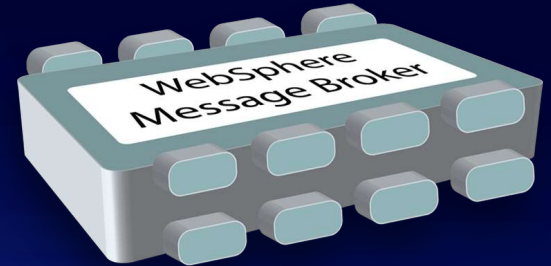

Built for universal connectivity and transformation in heterogeneous IT environments



Purpose-built hardware for simplified deployment and hardened security

Departments have differing ESB requirements which are best met by different products

Traditional ESB

- ✓ XML firewall and filtering helps stop SOA threats
- ✓ Message-level encryption and access control enforcement
- ✓ Web services Authentication, Authorization & Auditing
- ✓ Transformation/Mapping
- ✓ Helps promote Compliance (e.g. PCI, Sarbanes, etc)

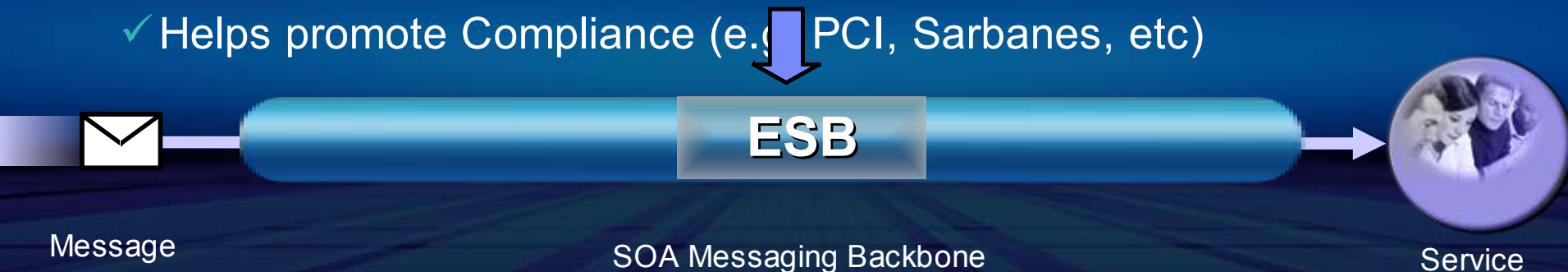

Extend your ESB to partners and customers

WebSphere DataPower XML Security Gateway XS40

- ✓ XML firewall and filtering helps stop SOA threats
- ✓ Message-level encryption and access control enforcement
- ✓ Web services Authentication, Authorization & Auditing
- ✓ Transformation/Mapping
- ✓ Helps promote Compliance (e.g. PCI, Sarbanes, etc)

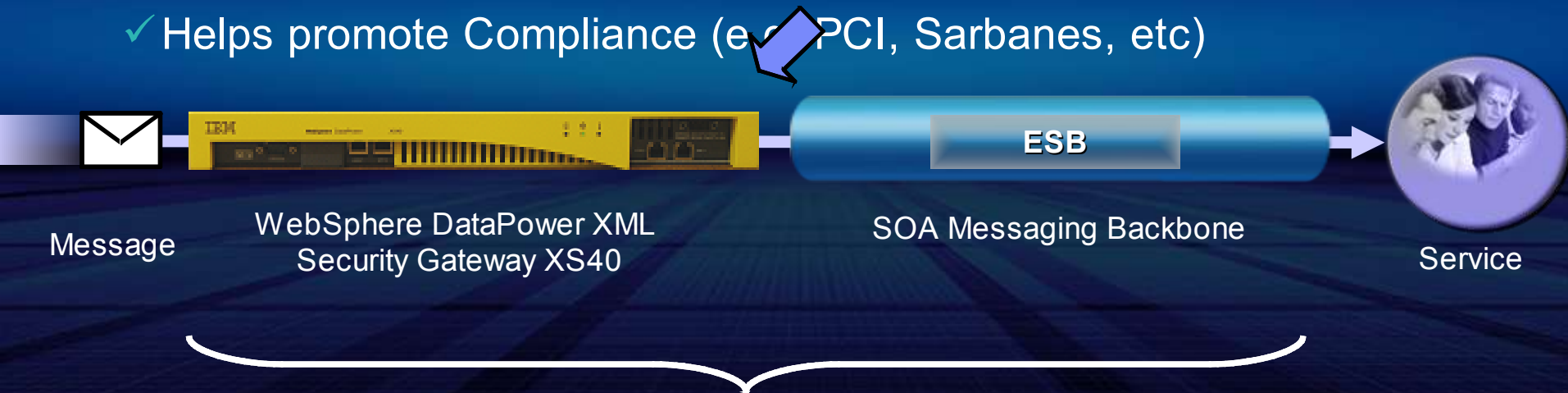

Extend your ESB to partners and customers

WebSphere DataPower XML Security Gateway XS40

- ✓ XML firewall and filtering helps stop SOA threats
- ✓ Message-level encryption and access control enforcement
- ✓ Web services Authentication, Authorization & Auditing
- ✓ Transformation/Mapping
- ✓ Helps promote Compliance (e.g. PCI, Sarbanes, etc)

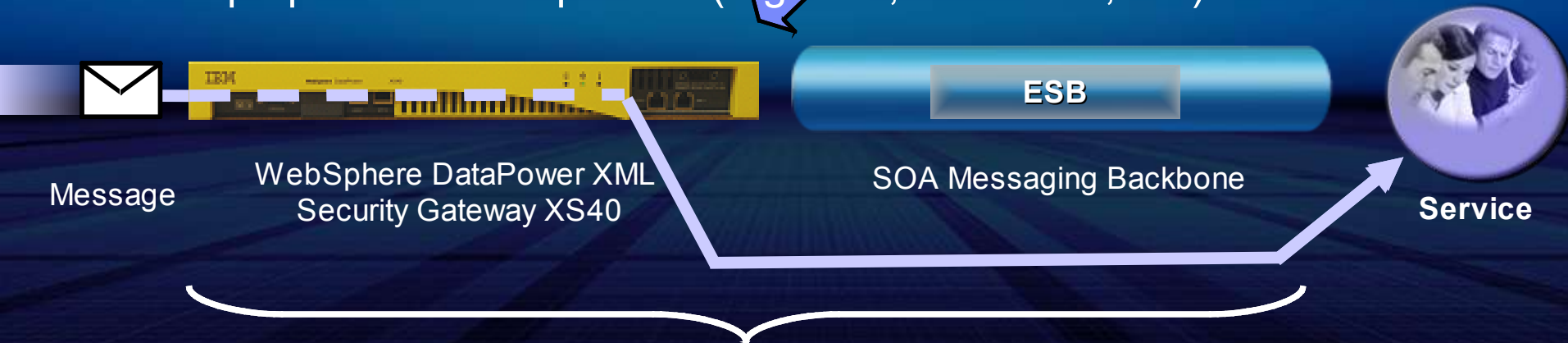

Meet the Family..

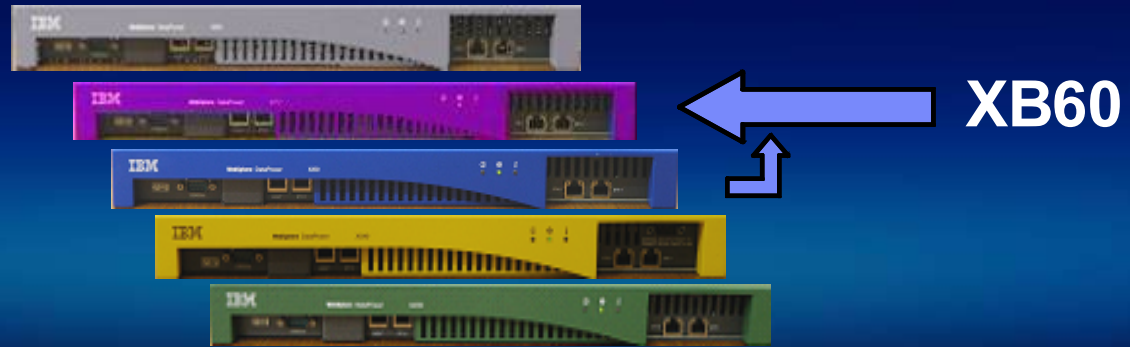

Business to Business (B2B) Appliance XB60

Purpose-built B2B hardware for simplified deployment, exceptional performance and hardened security

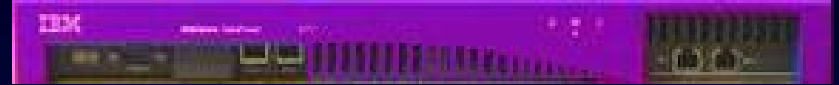

- Extend integration beyond the enterprise with B2B
- Hardened Security for DMZ deployments
- Easily manage and connect to trading partners using industry standards
- Simplified deployment and ongoing management



Trading Partner Management for B2B Governance; B2B protocol policy enforcement, access control, message filtering, and data security



Application Integration with standalone B2B Gateway capabilities supporting B2B patterns for AS1, AS2, AS3, ebXML, Web Services



Full featured User Interface for B2B configuration and transaction viewing; correlate documents and acknowledgments displaying all associated events



Simplified deployment, configuration and management providing a quicker time to value by establishing rapid connectivity to trading partners

Meet the Family..

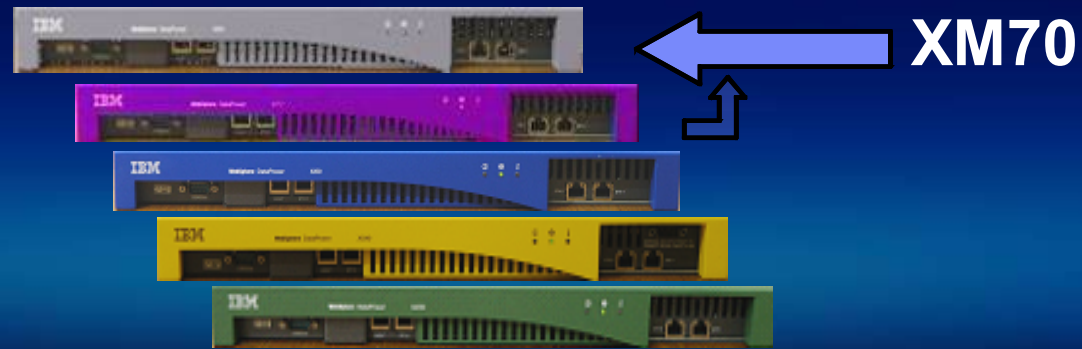

Low Latency Appliance XM70

Purpose-built hardware for low-latency, network-based messaging and data feed processing

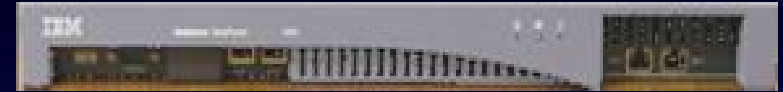

- Drop-in messaging solution which plugs into existing network infrastructure
- Enhanced QoS and performance with purpose-built hardware
- Simplified, configuration-driven approach to low-latency, publish/subscribe messaging and content-based routing
- High availability out of the box (two or more appliances)



Low-latency unicast and multicast messaging, scaling to 1M messages / sec with microsecond latency



Destination, property and content-based routing, including native XML and FIX parsers



Optimized to bridge between leading standard messaging protocols such as MQ, Tibco, WebSphere JMS and HTTP(S)



Simplified deployment, configuration and management providing a quicker time to value by rapidly configuring messaging destinations, connectivity and routing

WebSphere DataPower Base Qualities & Features

Maslow's Hierarchy of Enterprise Needs

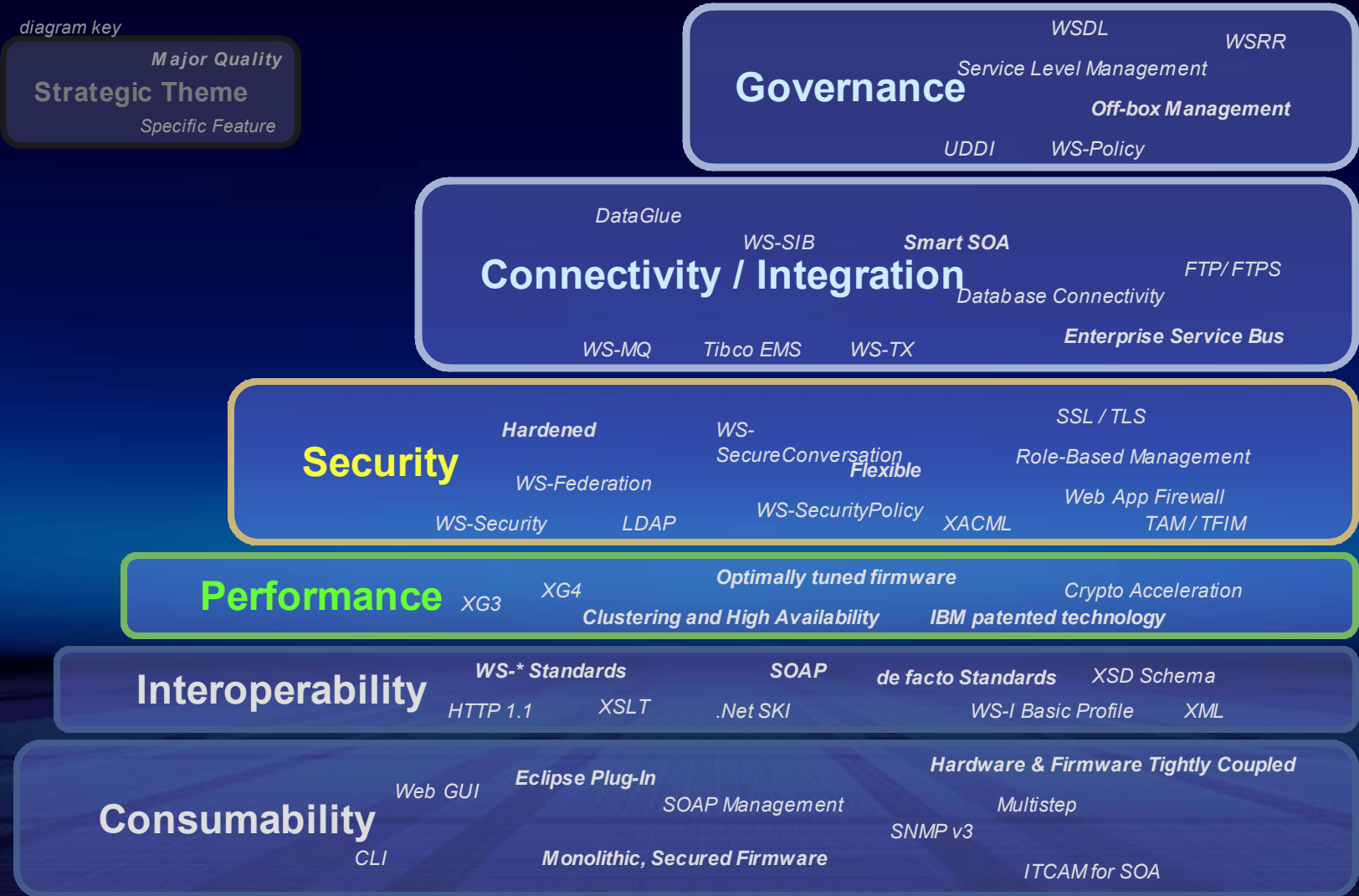

Simple Appliance Configuration for Robust Connectivity Functionality

Fits into your existing environment:

- Address broad organizational needs (Architects, Developers, Network Operations, Security)
- Complete Configuration from WebGUI, CLI interface or SOAP Management interface
- IDE integration/Eclipse plug-in
- XPath / XML config files

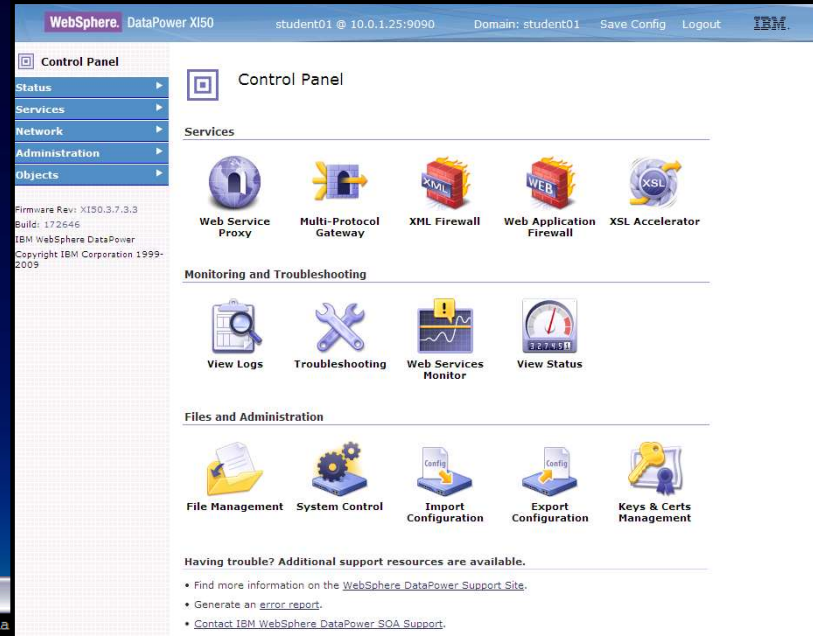

```

9.33.97.170 - PuTTY
wsa-default-faultto http://schemas
mous
wsa-force off
wsa-genstyle sync
wsa-http-async-response-code 204
wsa-timeout 120
type static-from-wsdl
autocreate-sources off
endpoint-rewrite-policy SomeBanker [up]
stylepolicy SomeBanker [up]
wsdl local:///somebankchecking.wsdl somebankchecking.wsdl
soap-action-policy lax

xi50[gateways]# show int

interface IP Address RX (kb/pkts/errors)
-----
eth0 0.0.0.0/0 0/0/0
eth1 9.33.97.170/23 256/2609/0
eth2 0.0.0.0/0 0/0/0
mgt0 0.0.0.0/0 0/0/0

xi50[gateways]#
  
```

```

<?xml version='1.0' encoding='UTF-8'?>
<env:Envelope xmlns:env='http://schemas.xmlsoap.org/soap/envelope'>
  <env:Body>
    <dp:request domain='testDomain'
      xmlns:dp='http://www.datapower.com/schemas/management'>
      <dp:set-config>
        <Matching name='matchAny'
          xmlns:dp='http://www.datapower.com/schemas/management'
          xmlns:env='http://www.w3.org/2003/05/soap-envelope'>
          <MatchRules>
            <Type>url</Type>
            <Url>.*</Url>
          </MatchRules>
        </dp:set-config>
      </dp:request>
    </env:Body>
  </env:Envelope>
  
```

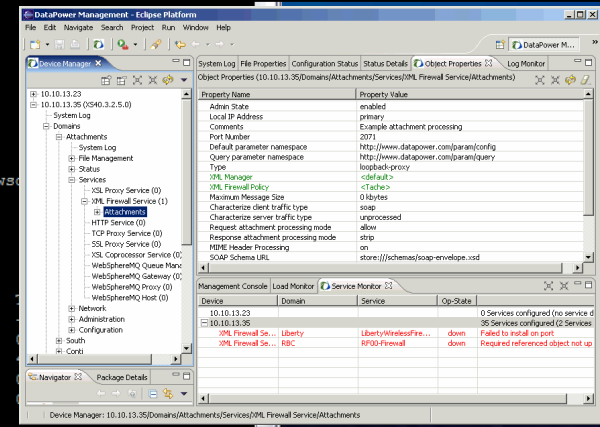

Why an Appliance for SOA?

Configuration vs. Programming

- Configuration driven Web GUI
- Drag & Drop Workflow Style
- Implement Complex Policies
- No Programming, Less Errors
- All Functions Available via WebGUI, CLI & SOAP Interface

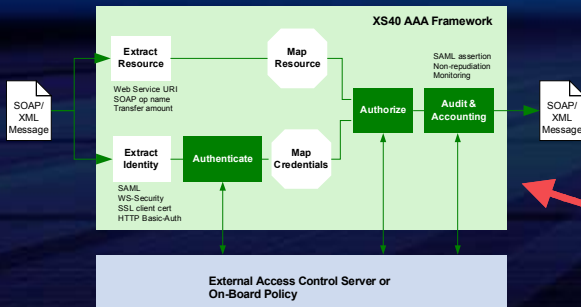
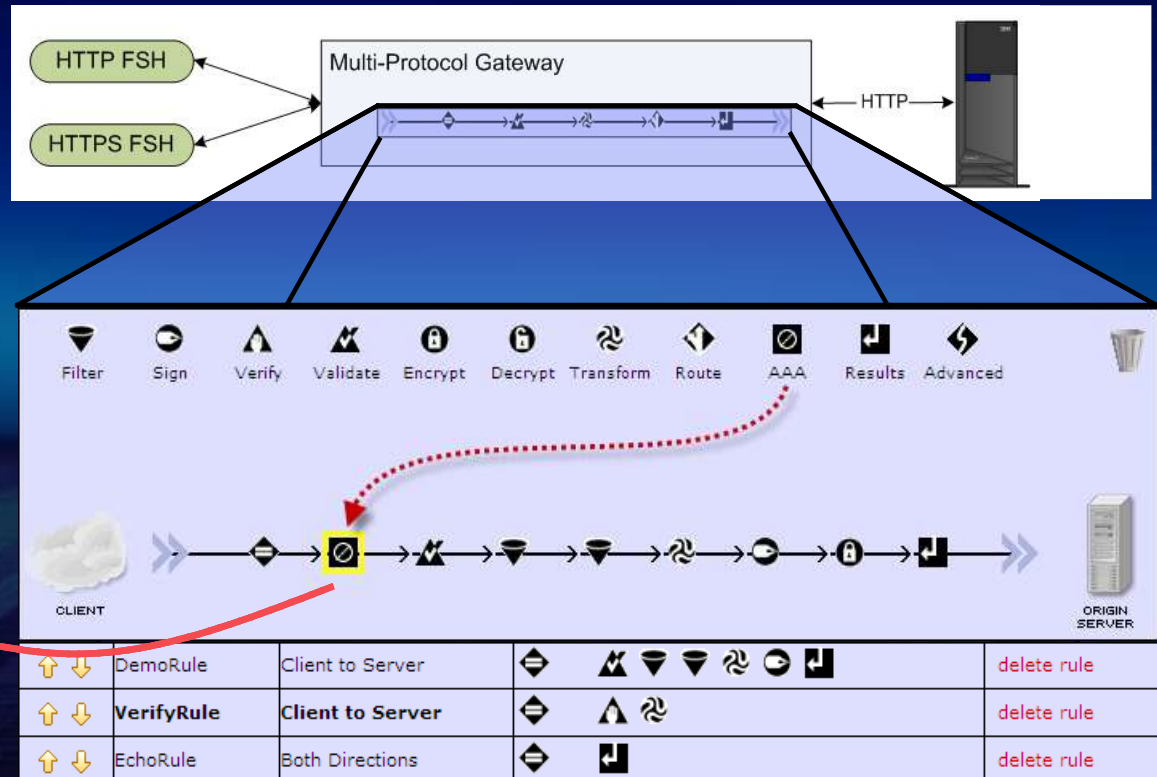

Governance and enforcement for secure connectivity

- Natural fit for a high-speed, secure, message-aware hardware device
- Standards based centralized governance
 - WS-Policy and WS-SecurityPolicy
 - Integration with centralized policy stores
 - Lowers risk and management cost
 - IBM WebSphere Registry and Repository
 - UDDI v2 and v3
- Centralized management and monitoring
 - ITCAM SE, ITCAM for SOA, WS-Management, SOAP Management Interfaces
- Process Integrity
 - Service Level Monitoring
 - Authentication and Authorization
 - Extended logging option
 - Off-device logs
- Security governance
 - Hardware XACML enforcement
 - Existing SSO's (LDAP, 3rd party)
 - IBM TAM and TFIM

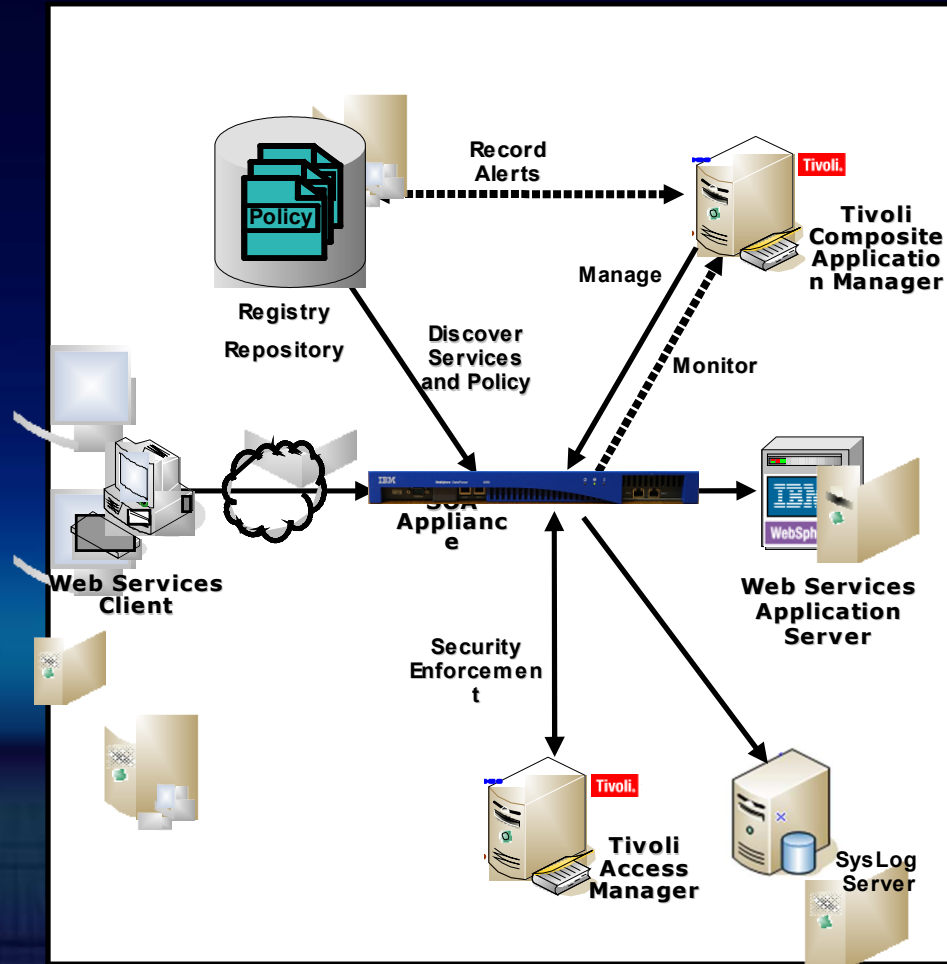

WebSphere DataPower Solution Categories

SOA Integration / ESB Enrichment and Messaging

- Efficiently transforming, routing, logging messages among applications and Web services using multiple protocols and data formats (XML and non-XML)
- Connecting Z or legacy applications to Web services/SOA



ESB & SOA Security

- Securely enabling access to back-end systems for partners and customers
- Protecting against XML-borne threats



SOA Governance & Policy Enforcement

- Manage Web services easily through service-level management, security management, enterprise management console, registry/repository integration



Business-to-Business Gateway

- Extend integration beyond the enterprise with B2B
- Easily manage and connect to trading partners using industry standards

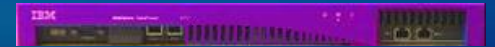

Low Latency Messaging

- Drop-in messaging solution which plugs into existing network infrastructure
- Simplified, configuration-driven approach to low-latency, publish/subscribe messaging and content-based routing



WebSphere DataPower Appliance Use Cases



Securing Web Services

Securely enabling access to back-end systems for partners and customers
Protecting against XML-borne threats



Legacy Integration

Connecting mainframe or legacy application to Web services/SOA
XML-enabling legacy systems via MQ



SOA Integration / Enterprise Service Bus (ESB)

Efficiently transforming, routing, logging messages among applications and Web services using multiple protocols and data formats (XML and non-XML)



SOA Runtime Governance

Manage Web services easily through service-level management, security management, enterprise management console, registry/repository integration



Web Application Firewall

Protect web application assets



Deployment Scenarios for Advanced Connectivity

Federated Extranet

B2B Governance through adherence to the AS1, AS2, AS3 and ebXML Standards

Internet

Outgoing B2B messages that support Trading Partner Agreements for AS1, AS2, AS3 and ebXML messaging

Intranet

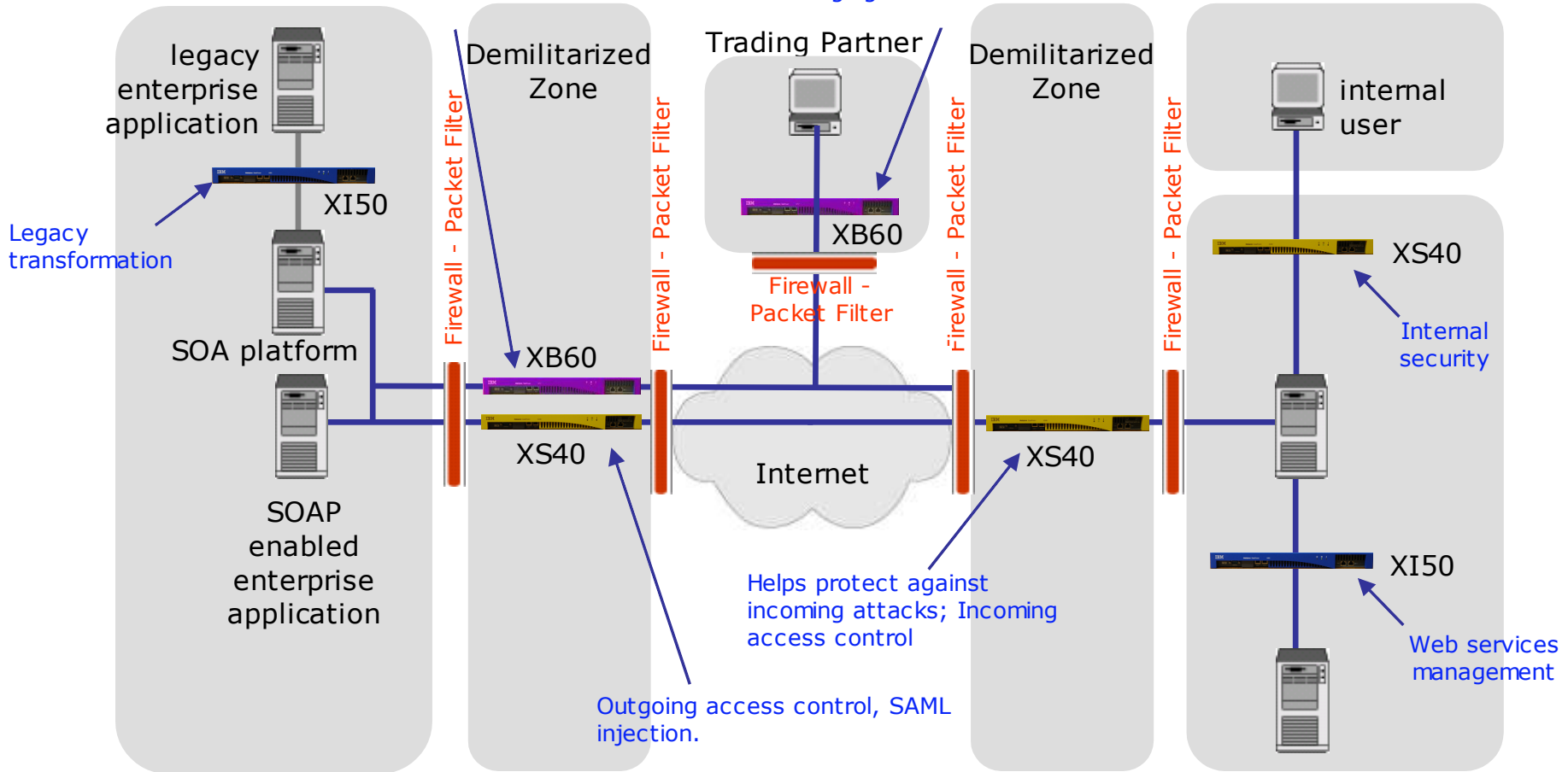

Integration across the IBM Software Portfolio

- Mature integration within WebSphere software portfolio
 - *WebSphere MQ with WebSphere DataPower: 4+ years, numerous customers*
 - *Industry-leading SOA Runtime Governance with WSRR + DataPower*
 - *Many more examples: WTX for data maps, WS-Security for WMB*
 - *Auto-configure XML firewall by importing WebSphere service descriptors*
- Complete SOA Security and Management solution with Tivoli products
- Robust enterprise integration through native DB2 and IMSConnect
 - *Deliver data as Web services into new or existing SOA solutions with DataPower/Data Studio integration*
- IBM Autonomic Integration – CBE/CEI Certified

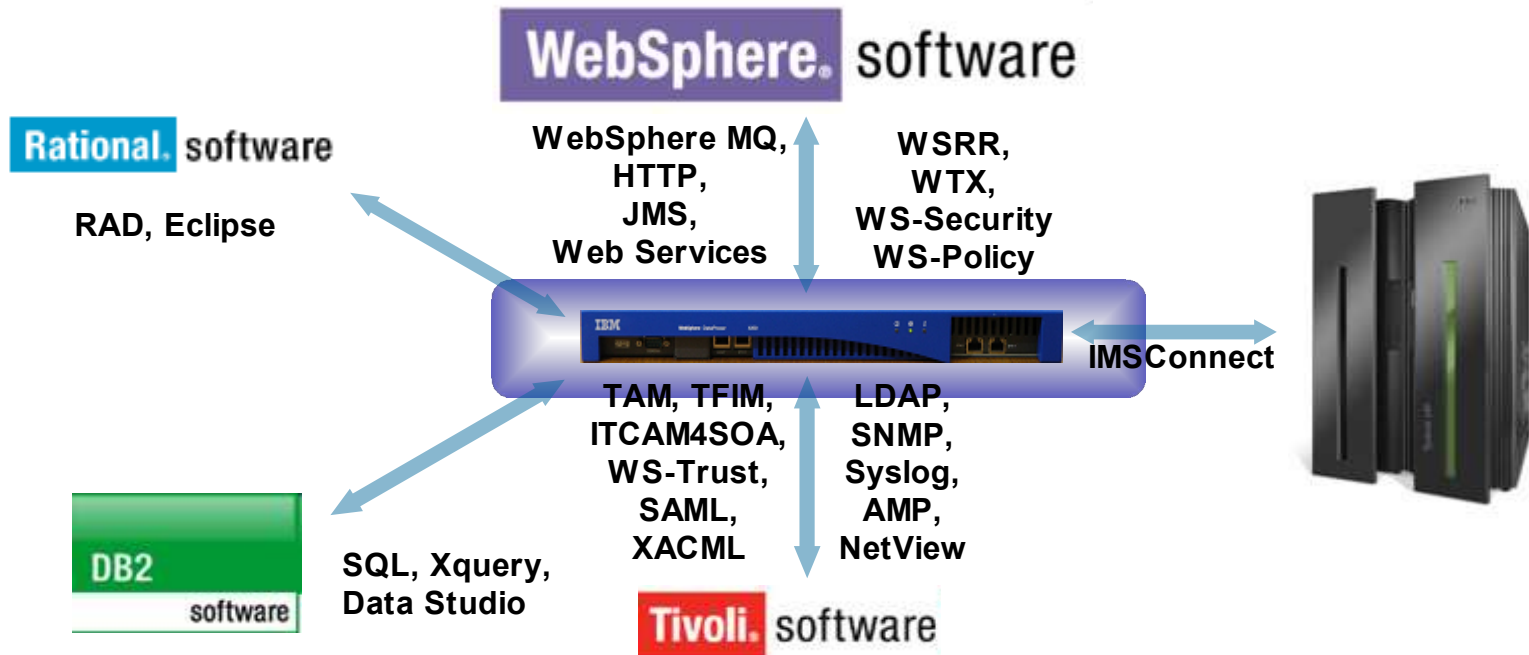

Integration with the Competition

- Standards-based integration with third party vendors
- Tighter integration with some key competitors
- No platform dependencies – hardware or software
- Exceptional interoperability through industry profiles and testing

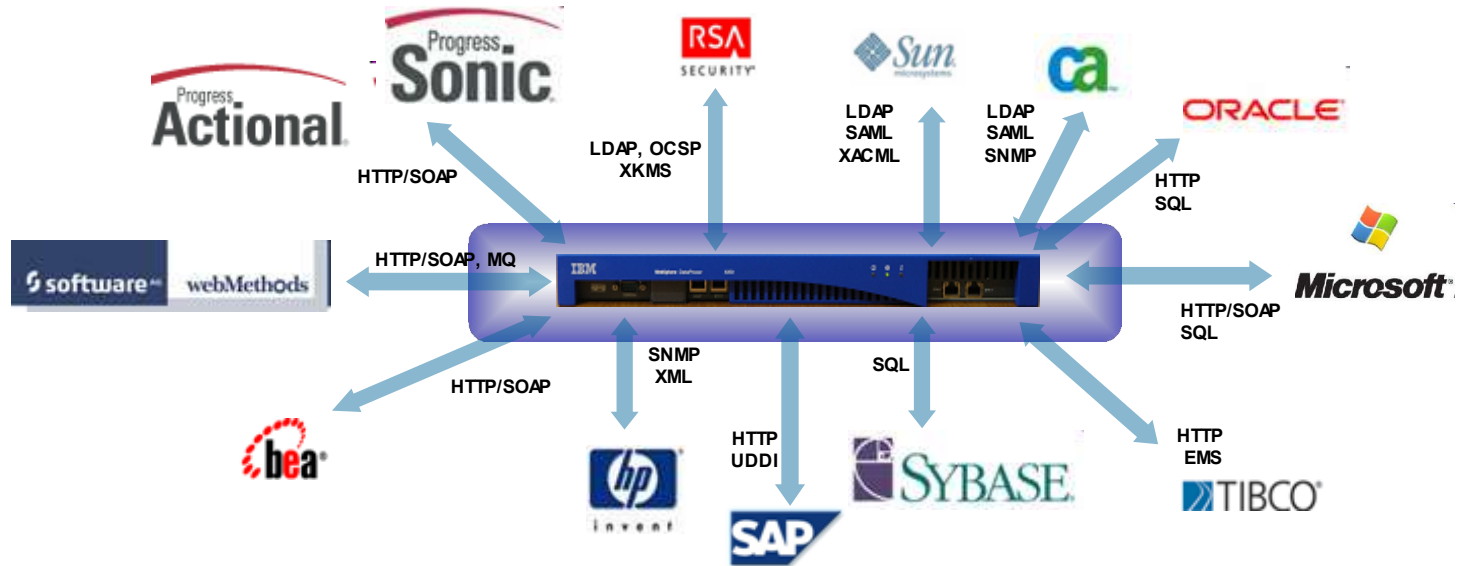

WebSphere DataPower Appliances Benefits

- **Flexible Connectivity:** an XML appliance shields the applications from security requirements, protocol changes and service versioning - no application modifications needed
- **Reduce Complexity:** Replace software servers functionality with an XML appliance, reduce infrastructure footprint, and off-load heavy processes to dedicated XML appliances
- **Lower TCO:** Dedicated XML appliances have shown to reduce operational costs by as much as 50%
- **Improved Agility by Reduced Time to Market:** dramatically decrease the testing time and amount of development required to upgrade your environment, most policies are configuration driven as opposed to development driven
- **Reduce Risk:** the XML appliance provides the connectivity layer without requiring application modification, and delivers improved security and audit support
- **Configuration Driven:** The XML appliance is configuration driven to do policy definitions, it does not involve development to support your infrastructure



DataPower 'Proof Of Technology'

Smart
SOA

You're invited!

- **Discovering the Value of IBM WebSphere DataPower SOA Appliances!**

A one-day Proof of Technology (PoT) provides a hands-on experience for those needing to understand how DataPower appliances.

The objective of the session is to provide participants with a hands-on experience creating and testing configurations that demonstrate a variety of scenarios that are common in SOA implementations.

This Proof of Technology is specifically targeted for Enterprise Architects, Systems Architects, and Security Architects evaluating architectural solutions for SOA deployments.

Thank you

