

# Simplify & Optimise SAP

## with IBM® Business Process Management Solutions

Joe Kaczmarek

Global Executive, IBM BPM for SAP  
joe.kaczmarek@us.ibm.com

Richard Davies

Client Technical Specialist, IBM BPM  
drichard@au1.ibm.com

Grand Hyatt  
Melbourne, VIC Australia  
October 8, 2013

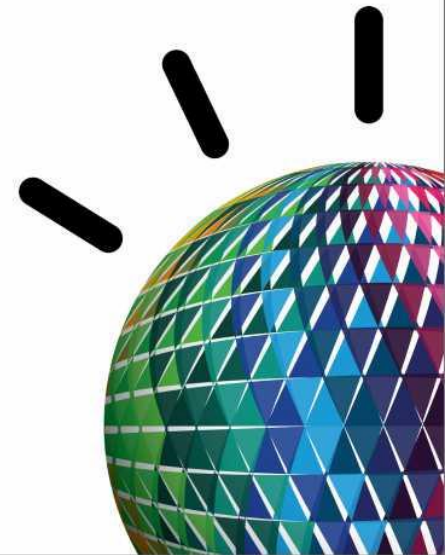

# Agenda



Topic	Start Time	Speaker
<b>Registration/Breakfast</b>	8:30 AM	
Welcome	9:15 AM	Joe Kaczmarek
The process imperative for SAP implementations	9:25 AM	Joe Kaczmarek
What is IBM BPM for SAP?	9:45 AM	Joe Kaczmarek Richard Davies
<b>MORNING TEA</b>	10:30 AM	
A day in the life of order to cash	10:45 AM	Joe Kaczmarek Richard Davies
Value Summary and the SAP Process Opportunity Workshop	11:15 PM	Joe Kaczmarek
<b>Networking</b>	11:30 PM	
Adjourn	12:00 Noon	

# Agenda



Topic	Start Time	Speaker
<b>Registration/Breakfast</b>	8:30 AM	
Welcome	9:15 AM	Joe Kaczmarek
The process imperative for SAP implementations	9:25 AM	Joe Kaczmarek
What is IBM BPM for SAP?	9:45 AM	Joe Kaczmarek Richard Davies
<b>MORNING TEA</b>	10:30 AM	
A day in the life of order to cash	10:45 AM	Joe Kaczmarek Richard Davies
Value Summary and the SAP Process Opportunity Workshop	11:15 PM	Joe Kaczmarek
<b>Networking</b>	11:30 PM	
Adjourn	12:00 Noon	

# Welcome!

- Objectives:
  - Explore root causes of common SAP implementation and operational challenges
  - Demonstrate IBM process management innovations that address these root causes and:
    - Help you discover and characterize your existing business processes
    - Improve process visibility and productivity
    - Reduce SAP customization
    - Help you react to complex business events in near-real time
    - Improve business outcomes
  - Investigate how these innovations can be applied
  - Explain next steps you can take to learn how these capabilities can help you

# Agenda



Topic	Start Time	Speaker
<b>Registration/Breakfast</b>	8:30 AM	
Welcome	9:15 AM	Joe Kaczmarek
The process imperative for SAP implementations	9:25 AM	Joe Kaczmarek
What is IBM BPM for SAP?	9:45 AM	Joe Kaczmarek Richard Davies
<b>M O R N I N G T E A</b>	10:30 AM	
A day in the life of order to cash	10:45 AM	Joe Kaczmarek Richard Davies
Value Summary and the SAP Process Opportunity Workshop	11:15 PM	Joe Kaczmarek
<b>Networking</b>	11:30 PM	
Adjourn	12:00 Noon	

# The SAP Advantage

Leverage world-class ERP software

Sharpen your competitive edge and drive growth with enterprise resource planning from SAP



- Improve alignment of strategies and operations
- Improve productivity and insight
- Reduce costs through increased flexibility
- Support changing industry requirements
- Reduce risk
- Improve financial management and corporate governance
- Optimize IT spending
- Gain higher ROI faster
- Retain top performers
- Provide immediate access to enterprise information
- Give employees new ways to access the enterprise information required for their daily activities.

# The IBM and SAP Partnership - Qualified, Awarded, Proven

## Certified Global SAP Partner

- Global Service Partner
- Global Technology Partner
- Global Cloud Service Partner



**SAP 2013 Partner Excellence Awards - Top Services Partner and Top Channel Partner**

## IBM has been recognized with an SAP Pinnacle Award every year since its inception



SAP Award of Excellence for IBM



2005  
2 awards for IBM



2006  
2 awards for IBM



2007  
3 awards for IBM



2008  
3 awards for IBM



2009  
4 awards for IBM



2010  
2 awards for IBM

## IBM is the largest SAP User and Implementor

- 40,000+ SAP production users, mixed release levels, all on IBM hardware
- Over 25,000 SAP consultants worldwide
- Large set of complementary SAP product and solution offerings



# Evolution of Packaged Applications Business Drivers

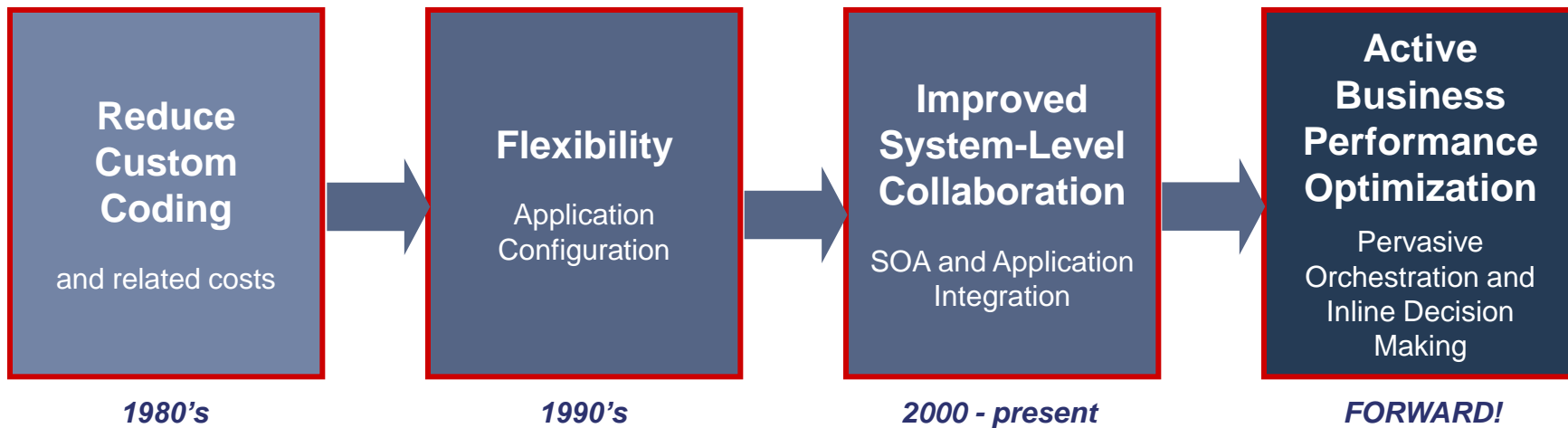



# Achieve Active Business Performance Optimization

## Operational Intelligence

Transform visibility into insight and action

## Agile Processes

Change processes at the pace required by the business

## Value Realization

Manage value with closed loop triggers and orchestrated playbooks

- Operational intelligence
  - Drives the need for action
  - Assists or automates inline decision making
  - Helps the business characterize issues and potential solutions
- Agile processes enable new insights to be implemented at ‘business speed’
- Value realization detects performance measure threats and initiated and manages structured and artful responses
- This combination allows the business to optimize its operations to dramatically improve business outcomes

# How SAP Processes Are Implemented Today



Most SAP implementations *rely on static documentation to implement processes* and may not reflect the processes actually being used

...*much customization* is often required

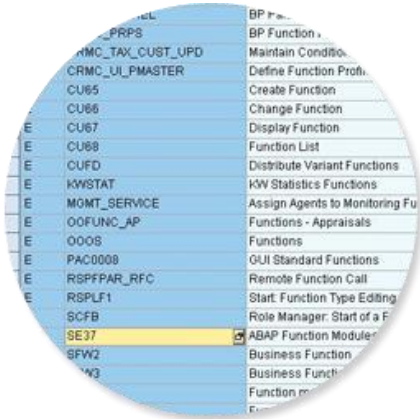
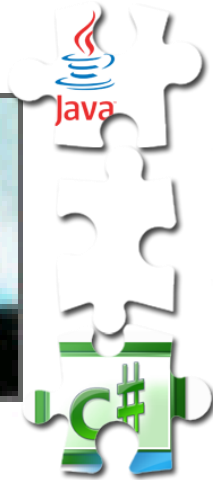

A documentation-centric approach to SAP needs *human compliance with process documentation*

...making it *difficult to migrate* to future releases



**SOLUTION IMPLEMENTATION**  
SAP CONFIGURATION

# Process is a Priority for Our Clients

## Typical Process Challenges

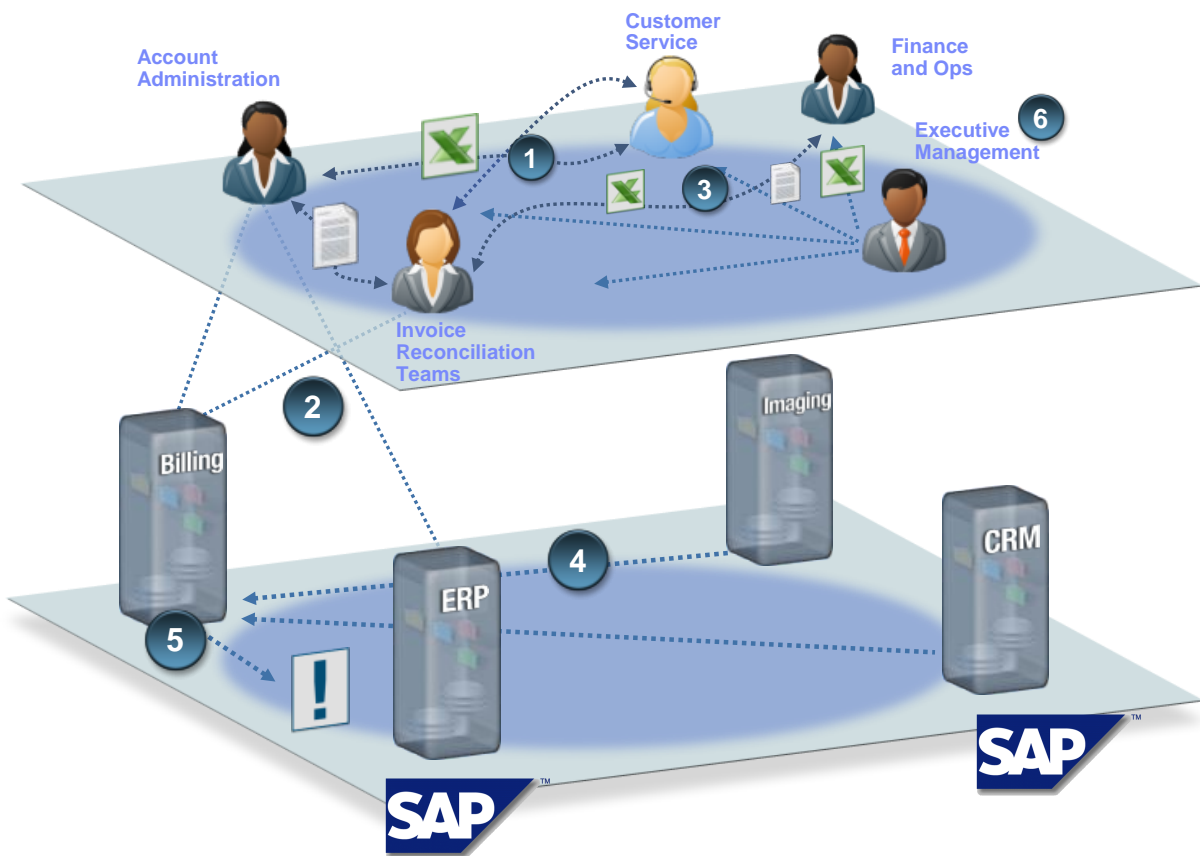

1. Confusion caused by asynchronous, informal compensation
2. Ineffective compliance and control
3. Poor visibility
4. Difficulty prioritizing critical work
5. Ineffective follow-up
6. Lack of business agility
7. Sub-optimal business results

***Unresolved, these process challenges inhibit virtually every aspect of business performance.***

# Top SAP Challenges

## SAP Issues

- **Informal and incomplete** process management paradigm
- **Complex** configuration and transaction tailoring
- **Frustrating** user interface and other usability issues



## Business Challenges

- Inadequate operational visibility, flexibility, agility and control
- A transaction-centric business driven by custom reports and informal compensation
- Best business optimization options not clear

## Design Tensions



Standardized SAP Components and Transaction Linkages

- Negative impact on **business performance**

Process Differentiation and Optimization

- **Excessive customization and functional extension**

# This Implementation Approach Can Result In...



Late Deployments



Budget Overruns

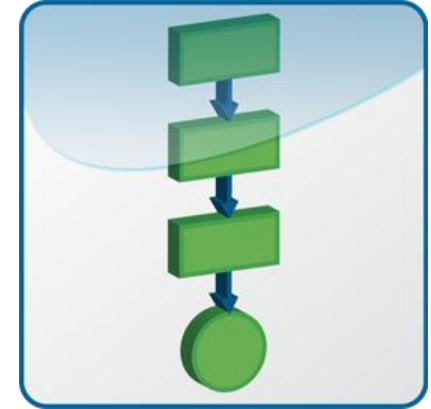

Rigid Processes

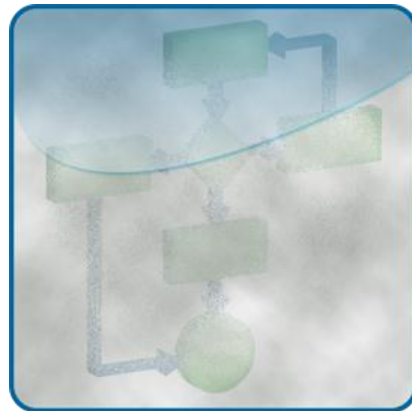

Inadequate Visibility and Response



ROI Targets Not Met

# BPM Brings Order to the Chaos

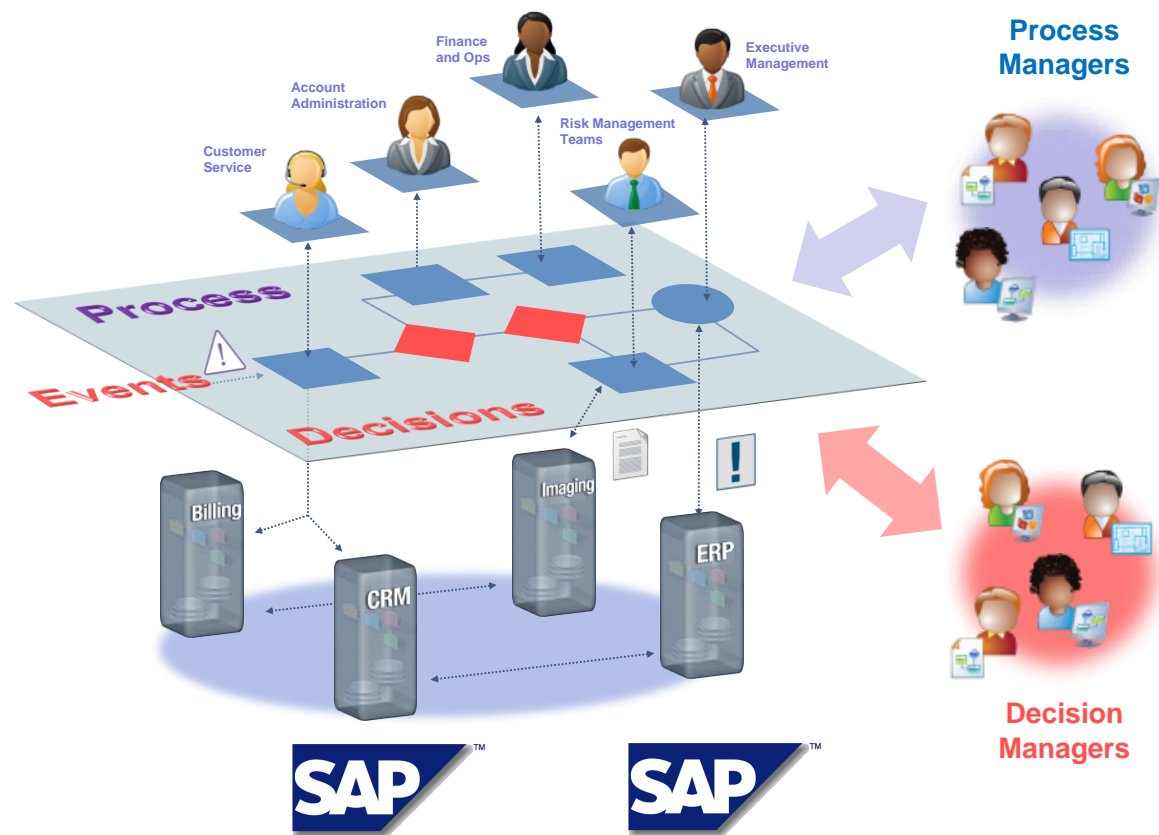

- **Model, Orchestrate and automate** workflow and routine decision making
- **Monitor** KPIs, SLAs and discrete business measures to provide real-time operational visibility and response
- **Manage** processes to realize and manage business value

***BPM allows the business to continuously drive improvements in virtually every aspect of business performance.***



# IBM is the proven leader in all aspects of BPM

## #1 in BPMS market share for 2012

IBM was named the **number one vendor in BPMS software** with a 27.1 percent share, ***almost triple*** that of its closest competitor\*

**Largest Customer Base**

Over **5000** BPM customers worldwide and growing

**Strongest Ecosystem**

Over **1000** certified business partners

**Unparalleled expertise**

Over **15 years** of industry leadership

### Gartner

#### Magic Quadrant

Figure 1. Magic Quadrant for Intelligent Business Process Management Suites

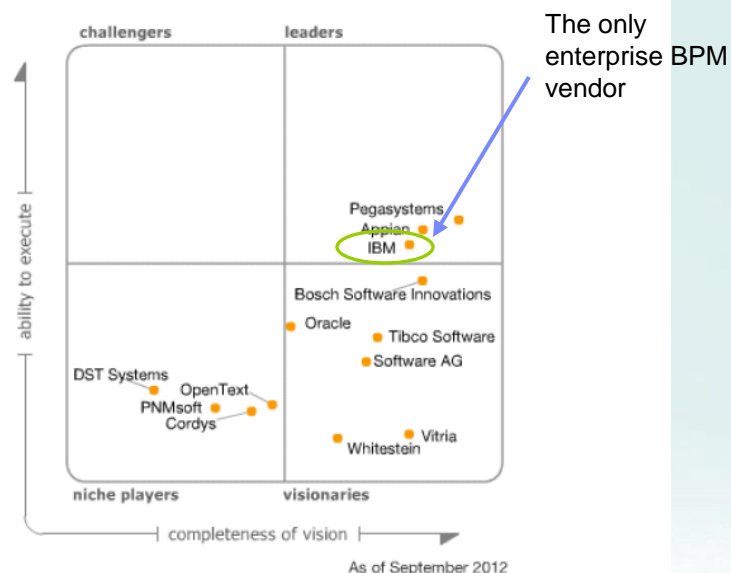



# What If You Could Have....



*Process Layer*

- The premiere BPM platform, providing a **formal and complete** process management paradigm
- **Simple** process configuration and SAP transaction tailoring
- **Flexible, highly productive** user interface
- The right amount of **process differentiation**, driven by business need – not time and cost



*Transactional Layer*

- The premiere **integrated business application** platform
- **Robust and complete** transactional capabilities

# Agenda



Topic	Start Time	Speaker
<b>Registration/Breakfast</b>	8:30 AM	
Welcome	9:15 AM	Joe Kaczmarek
The process imperative for SAP implementations	9:25 AM	Joe Kaczmarek
What is IBM BPM for SAP?	9:45 AM	Joe Kaczmarek Richard Davies
<b>MORNING TEA</b>	10:30 AM	
A day in the life of order to cash	10:45 AM	Joe Kaczmarek Richard Davies
Value Summary and the SAP Process Opportunity Workshop	11:15 PM	Joe Kaczmarek
<b>Networking</b>	11:30 PM	
Adjourn	12:00 Noon	

Unlike Other BPM Platforms, With IBM BPM 8.0...

## The picture IS your SAP process...

**Draw a picture, create a smarter process.**

"Within the first few hours of the first day, you can run a meaningful process – enabling direct process and decision management by business users."

→ Schedule a live custom demo.



**IBM  
Business  
Process  
Manager**

*Analyze. Define. Execute. Monitor. Improve.*

**All in one tool – analysis through execution through improvement**

# So SAP Processes Can Be Played Back At Any Time

*Regardless of their definition maturity*

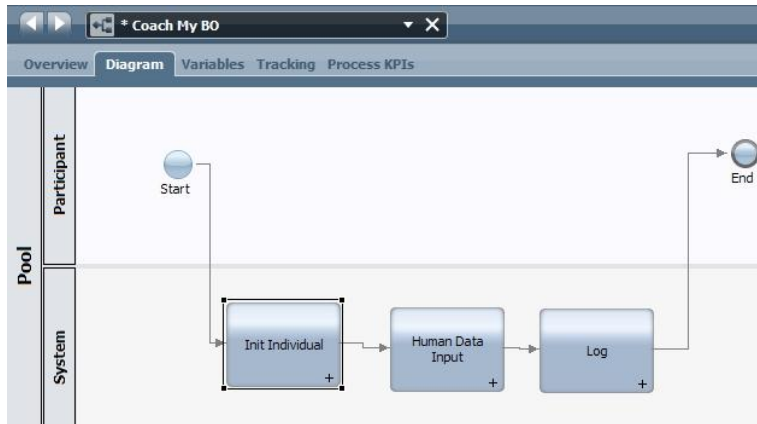

# Playback



- Start by importing SAP or IBM best practice libraries
- Playback any process from the design environment – regardless of the level of detail and completion
- Include real screens (guided workflow), mockups or images
- Clarify roles, process steps, flow, KPIs and reporting
- Even process skeletons can be executed
  - Process execution is logged
  - All process performance parameters are visible
  - KPIs are calculated and displayed in real time

# BPM Process Hierarchy for SAP

*BPM Adds Value Above and Below the SAP Transaction*

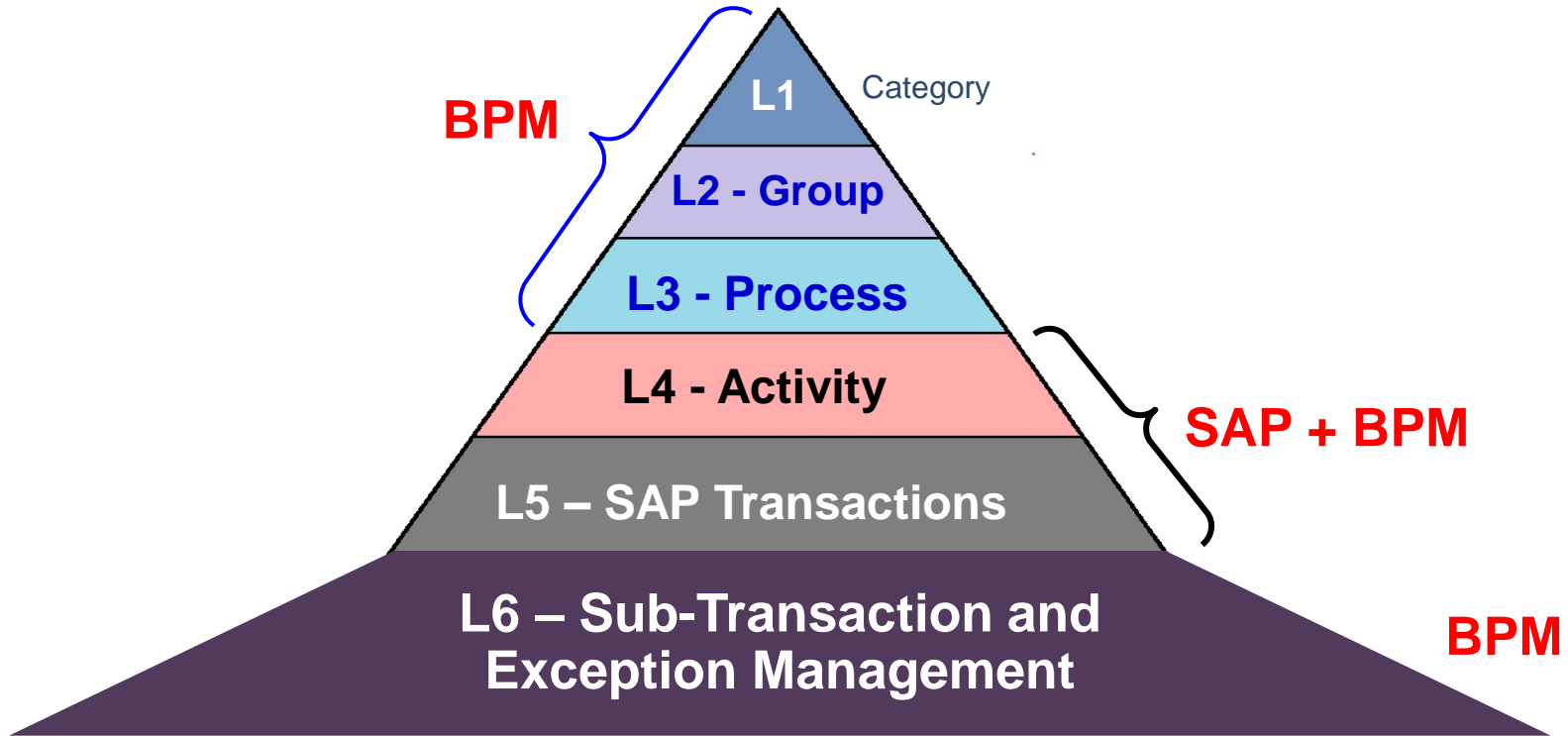

**Process Levels - APQC Process Classification Framework**  
(Source: APQC – American Productivity and Quality Center)

# IBM BPM Integrates Seamlessly with SAP

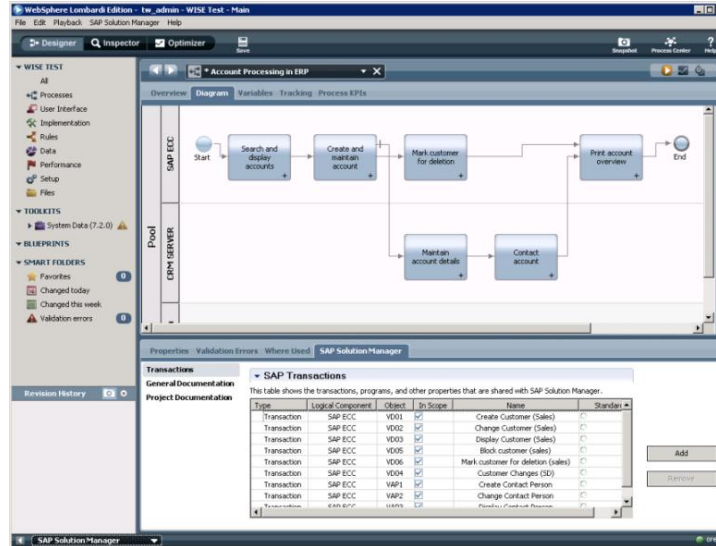

Orchestrate SAP Processes and Services

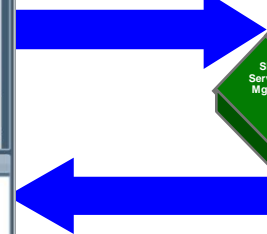

Monitor SAP Business Events and metrics

Retrieve Enterprise Service Definitions

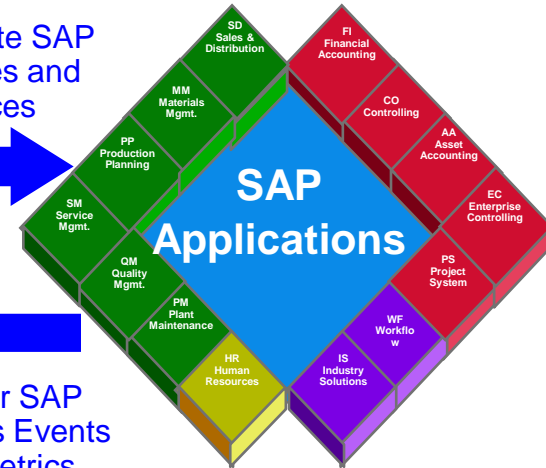

Download BPH from Solution Manager

Integrate SAP Solution Manager business metrics

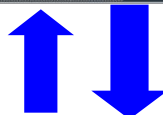

Upload BPH to Solution Manager

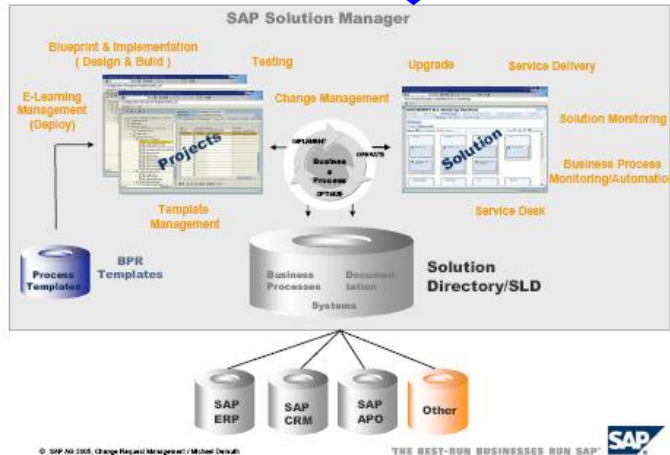

ES Repository Objects

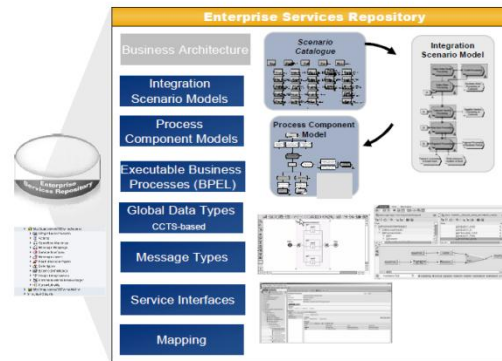

# Core IBM BPM for SAP Capabilities

## Innovation

**Reduce blueprinting time, cost and risk**

**Iterative Business Blueprinting**

Use an iterative, experiential-based approach to accelerate traditional SAP blueprinting with SAP Solution Manager

**Improve process reliability, flexibility, visibility and control**

**Process Discovery and Monitoring**

Mine SAP Business Events to discover actual processes and act in real time to business challenges

**Guided Workflow**

Interactively guide end users through SAP screens to improve productivity, visibility and consistency

## Transformation

**Improve process efficiency and reduce business complexity**

**Process Integration and Orchestration**

Optimize process steps to improve cycle time, manageability and visibility of key processes

**Decision Automation**

Automate complex decision making to reduce bottlenecks and improve business outcomes

**Process Automation**

Dramatically reduce the cycle time of high volume processes by reducing/removing human interaction

**Business Optimization Potential**



- Apply the right mix of process innovation capabilities based on:
  - Process characteristics
  - The level of optimization desired
  - Current process innovation maturity



# IBM BPM is Leveraged Throughout the SAP Project Lifecycle

*IBM's agile SAP implementation approach reduces cost, time and risk*

## Blueprinting

- **Experiential** process design and validation
- **Iterative** realization of process design
- **Accelerated** downstream activities

## Realization

- Reduced **configuration** requirements
- Reduced SAP **customization**
- Faster completion of other **realization** tasks

## Deploy

- Reduced functional **testing**
- Reduced time and cost to **localize** global templates
- Reduced **training** costs and **adoption** challenges

## Sustain

- Extensive **initial** business optimization
- **Agile** SAP process improvement
- A platform for **continuous** business optimization

***IBM's agile SAP implementation approach assures faster, cheaper, better SAP implementations – while delivering sustainable incremental business benefits long term.***

# SAP Guided Workflow

# Traditional BPM Orchestration Challenges

- Generally, BPM does not leverage native application GUIs. As a result:
  - Custom GUIs must be developed
  - Technical integration with the application is then required
  - Adequate technical integration mechanisms may not exist and might need to be developed
  - Data integrity, process step validation, etc., normally part of an application's GUI program, are often re-developed
  - Most BPM projects include a substantial amount of technical development
- As a result, only a very small percentage of a business's processes typically get BPM orchestration

***What if you could achieve all of the benefits of BPM process orchestration without extensive technical development?***

# IBM BPM Automatically Generates SAP Process Orchestrations

## SAP Guided Workflow Feature

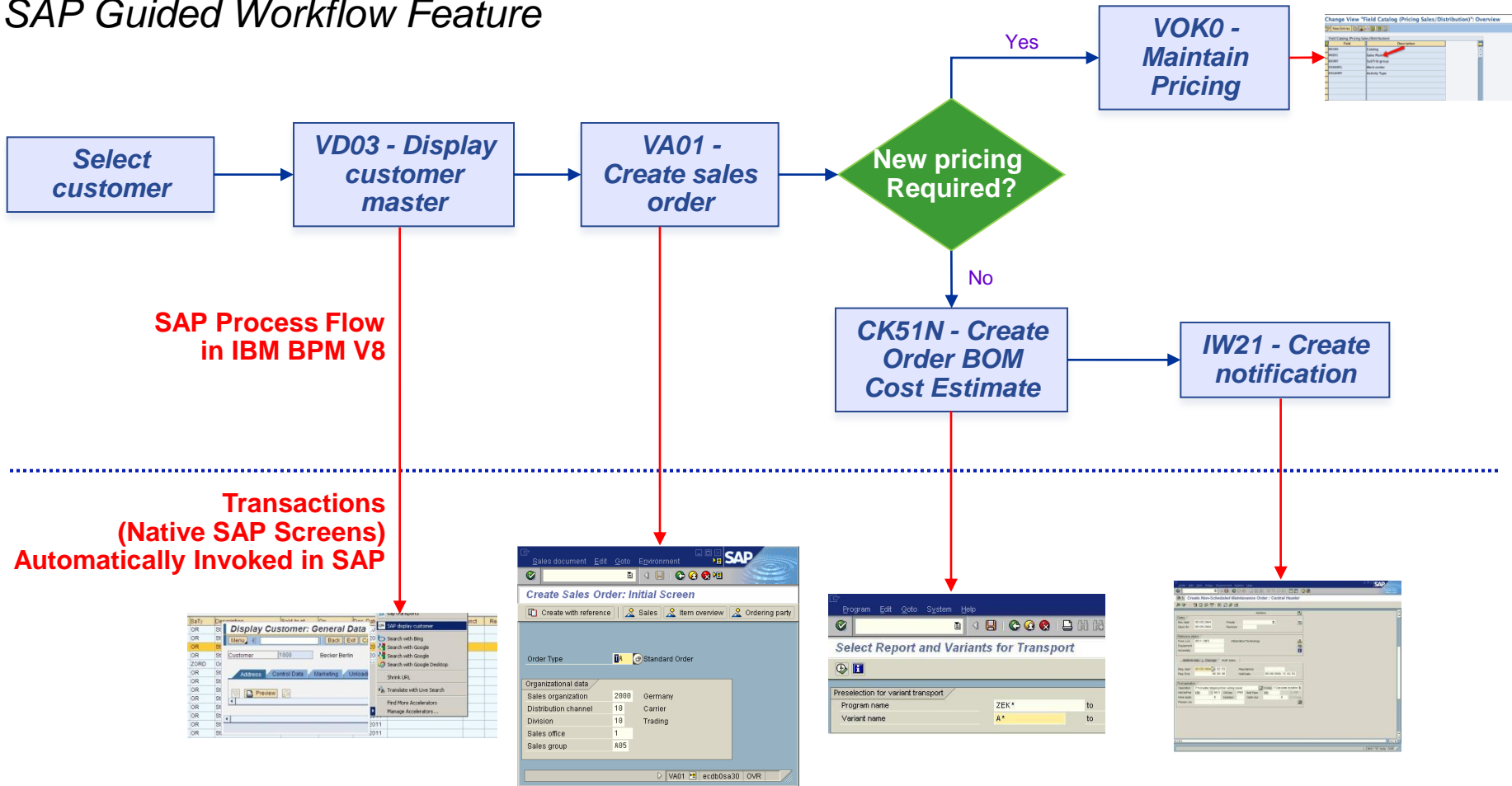

**Invoke the correct SAP transaction sequence for each process instance, while gaining real time insight into business performance issues and opportunities**

# IBM BPM Guided Workflow Requires Limited IT Involvement

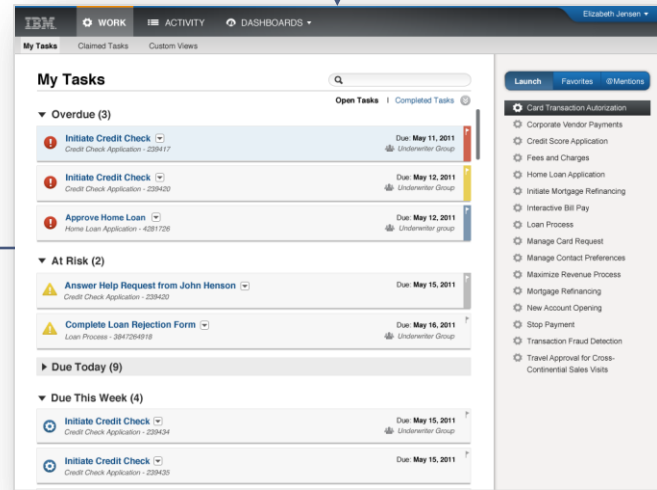
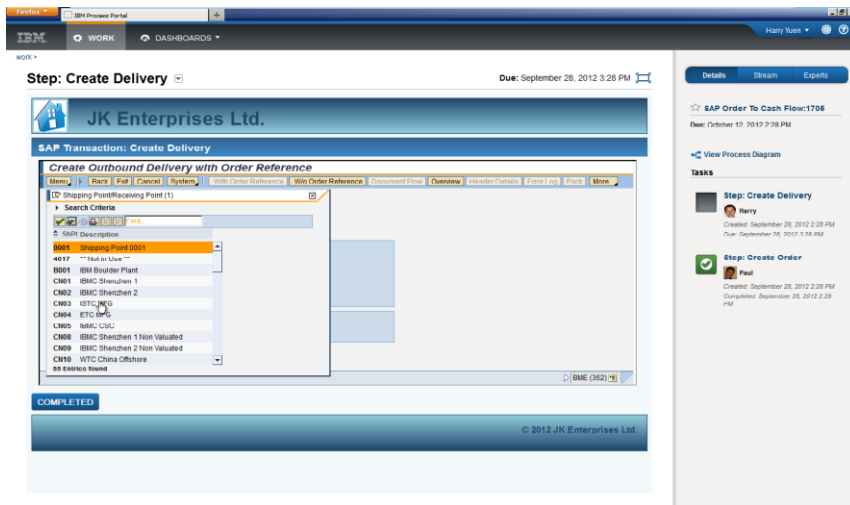
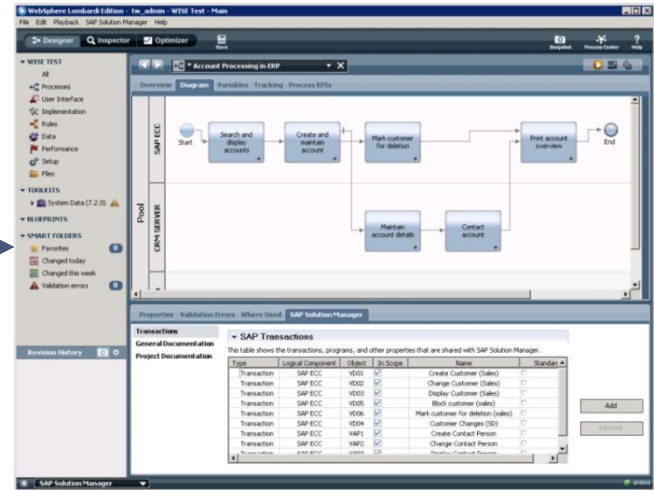

**3** *Complete your SAP transaction. Review the process picture, see who has worked on previous process steps, leverage previous process collaborations*

**2** *Launch a new process instance or select from your inbound task list.*

# IBM BPM Guided Workflow Enhances the User Experience

*The SAP GUI is Automatically Surrounded by Rich Process Tools for Every End User*

## Standard or 'Z' SAP GUI

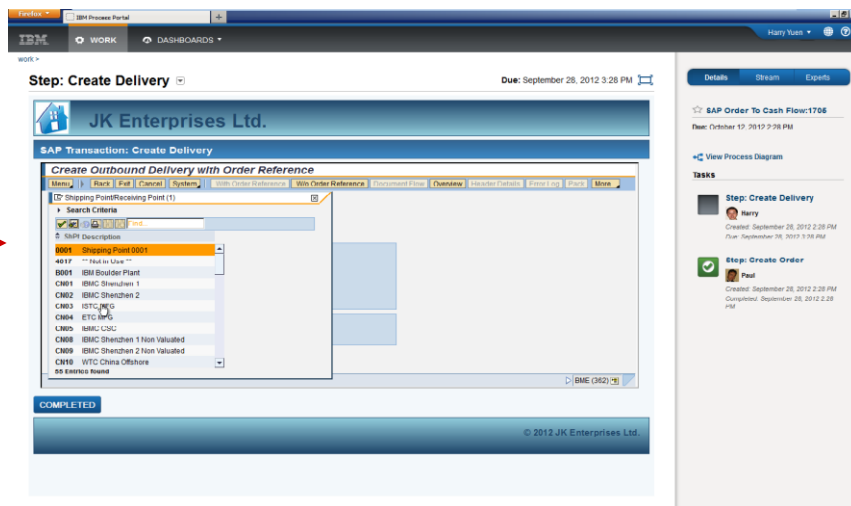

Process instance data from previously steps can be pre-loaded into the SAP screen

**IBM BPM Guided Workflow for SAP automatically transforms any SAP GUI into a rich process workspace, tightly integrated into its process context.**

**Process Launch Bar**

Launch any process for which a user is authorized

**Process Status (Diagram)**

See a pictorial process history and downstream steps

**Process History**

See a detailed stream showing all process steps completed thus far

**Process Collaboration History**

See the complete collaboration history for the current process step

**Process Experts Community**

Instantly contact an identified expert in the current process step

# SAP Solution Manager Integration and Guided Workflow Demo



# IBM BPM Guided Workflow Delivers Visibility, Consistency, Agility and Control

Users who start a flow launch an entire process, not just complete a single screen

Process Launch Bar

Work is automatically routed to the right users at the right time, in the right priority

Tiered, multi-level views into the process immediately pinpoint problem areas

Broader process improvement opportunities are visible at the push of a button

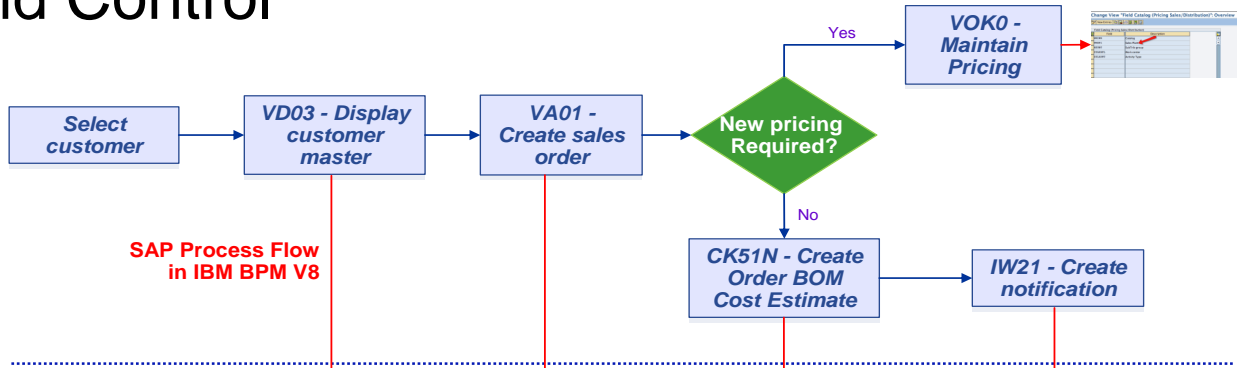

SAP Process Flow in IBM BPM V8  
Transactions (Native SAP Screens) Automatically Invoked in SAP

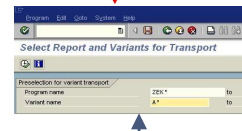
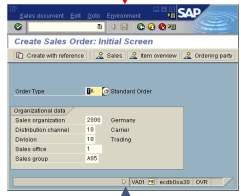
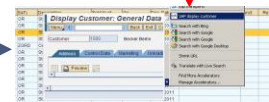

Task List for User A

Task List for User B

Task List for User C

Process Dashboard (Departmental)

Process Dashboard (Executive)

Process Optimizer

Conditional steps can be completed inline without going to a task list or menu

Dashboards and the optimized provide visibility over the entire process

# IBM BPM for SAP Guided Workflow Benefits

- Gain all of the benefits of traditional BPM process orchestration with **ZERO CODING OR IT DEVELOPMENT**
- **Simplify** SAP process work management
- Provide end users with assured **guidance** and the **business context** of their transactional activity
- **Route, prioritize and manage** all SAP transactional activity
- **Quickly change** and enhance SAP business processes without costly SAP re-configuration
- Manage process changes outside of SAP in order to deliver SAP process **agility** 'at the speed of business'
- Integrate, capture and mine **collaborations** to identify systemic process issues



# SAP Technical Integration and Transaction Decomposition

# Drag and Drop SAP Technical Application Services Into Your Process Model



## Create Sales Order

IBM BPM SAP  
Integration Module

*Easily use SAP BAPIs, IDOCs,  
Enterprise Services, HANA APIs, etc.  
in your process flows*

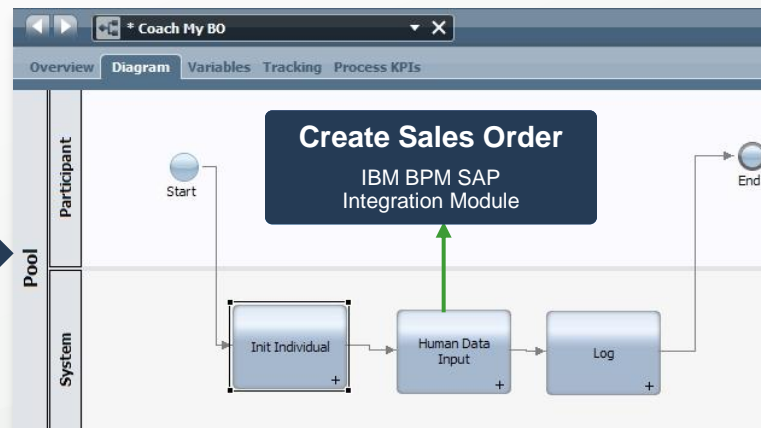

- Allows process designers with no technical knowledge of SAP technical integration to directly use powerful SAP capabilities in process diagrams
- Simplifies all technical interactions with the SAP environment
- Streamlines process design
- Eliminates complex coding for SAP interfaces

# IBM BPM for SAP - Process Level 5

*Decompose Large SAP Transactions for Maximum Flexibility*

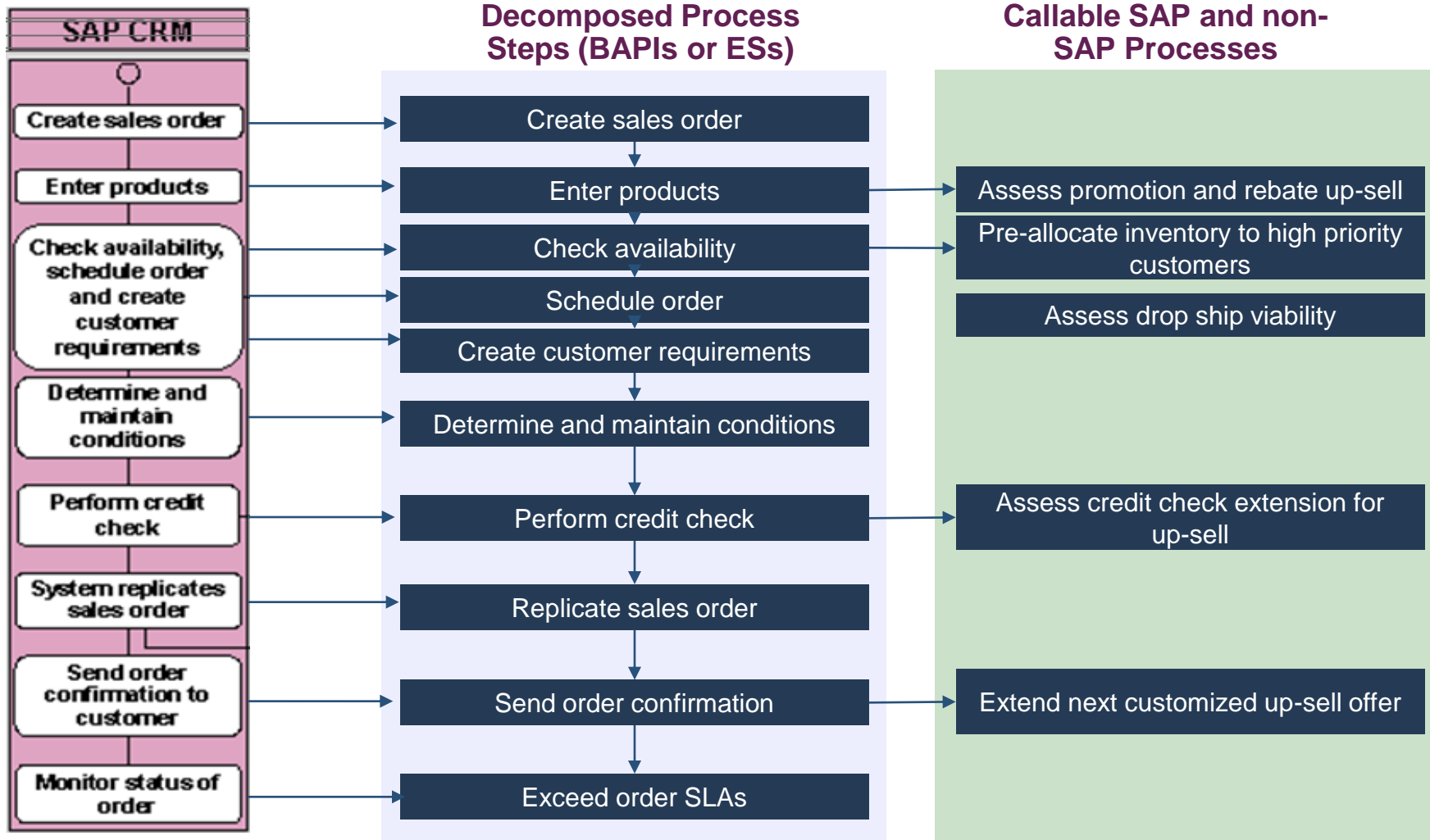

**VA01 - Level 5**  
*One monolithic process step with user exits*

**VA01 - Level 5**  
*Now 10 reusable BPM process steps for maximum flexibility and control*

**New Process Steps to be Executed Inline for Optimization**

# Simplify Complex SAP Transaction Flows with Simpler User Interactions and Process Flexibility

Replace....

.....With

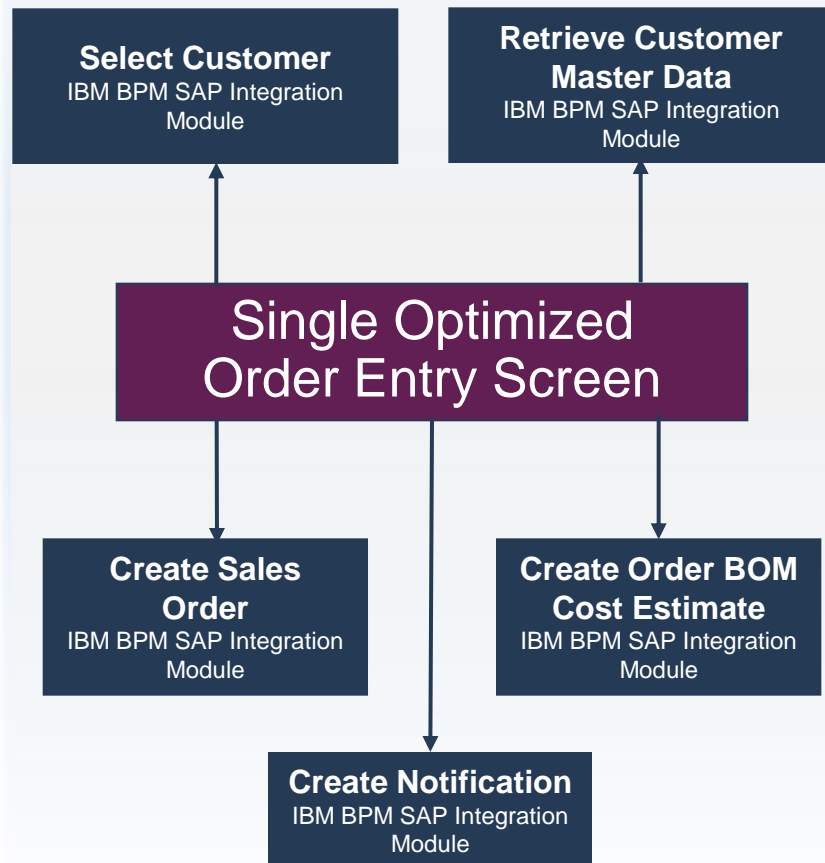
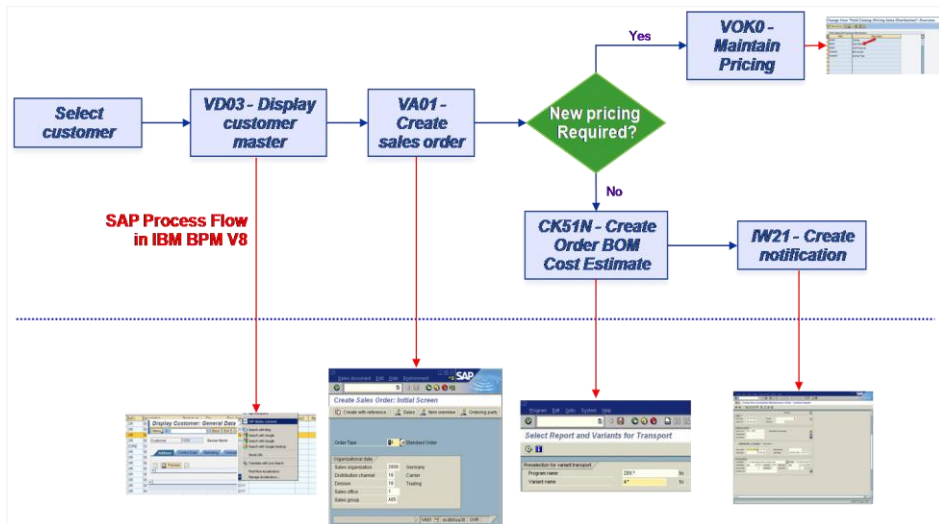

- Replace complex flows of multiple SAP transactions with highly efficient single screens
- Simplify work content
- Reduce process cycle times and errors
- Improve business performance

# Orchestrate and Automate Complex E2E Processes

WebSphere® software



## End-to-End Process Choreography

1. Order is received from the web site
2. Customer records are updated with order request information
3. Credit check and approval are completed
4. Customer order is written and confirmed for production
5. Required components are determined, ordered, allocated and received
6. Production order is completed and warehoused
7. Customer order is approved for shipment
8. Customer order is picked from warehouse and scheduled for shipping
9. Customer order is invoiced

## IBM BPM Order to Ship End-To-End Process



**Retrieve Customer Master Data**  
IBM BPM SAP Integration Module

**Create Sales Order**  
IBM BPM SAP Integration Module

**Create Order BOM Cost Estimate**  
IBM BPM SAP Integration Module

**Create Notification**  
IBM BPM SAP Integration Module



# Benefits of SAP Transaction Decomposition

- **Granular, online process guidance** for complex SAP transactions
- Prioritize and manage sub-transactional activity **dynamically**
- Make SAP transactional activity **flexible and dynamic**
- **Adapt** your SAP process and sub-transactional activity to changing business conditions
- **Ensure** that key process components are executed and at the right time
- Easily **coordinate forked activities** that typically cause increased cycle time or bottlenecks
- Integrate additional functionality **without the side effects of SAP user exits and custom coding**

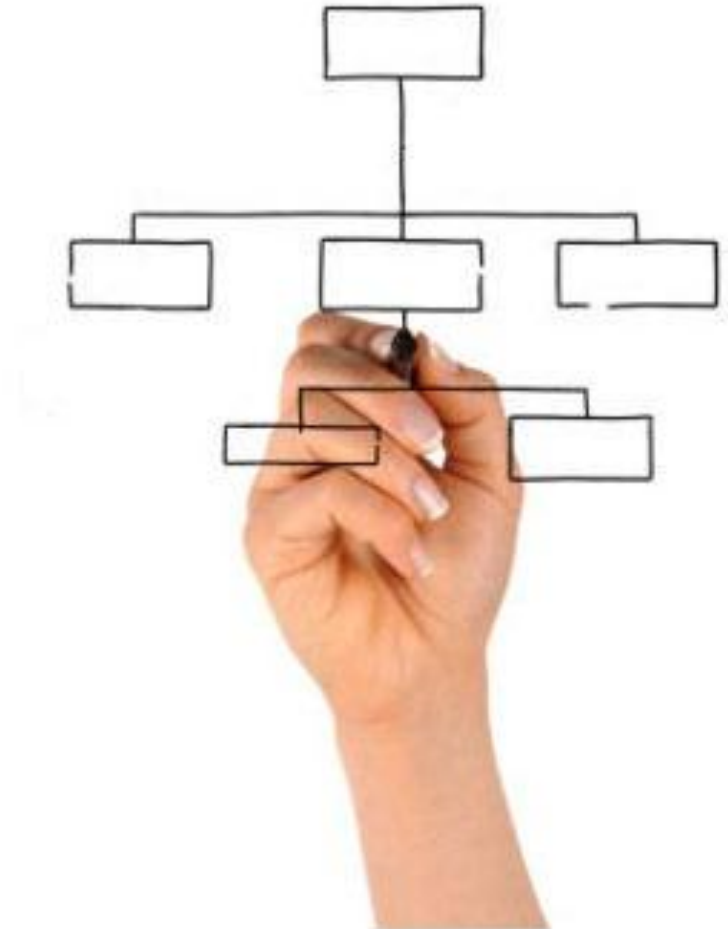

# SAP Process Discovery and Business Monitoring

# SAP Process Documentation Is Usually Outdated by Months or Years

2008		2013	
SAP process blueprints created			Probably Outdated
SAP design completed			Probably Outdated
SAP configuration changes completed	Additional SAP configuration changes		Documentation Possibly Outdated
SAP customization completed	Additional SAP customization		Documentation Possibly Outdated
	Ad hoc changes to processes by end users		Blueprint Not Updated

***Without insight into the 'real' SAP processes being used in production, it is very difficult to initiate and build an effective process innovation program or to migrate to a newer SAP release.***

# Understand and Manage Any Process – Even Without Orchestration!

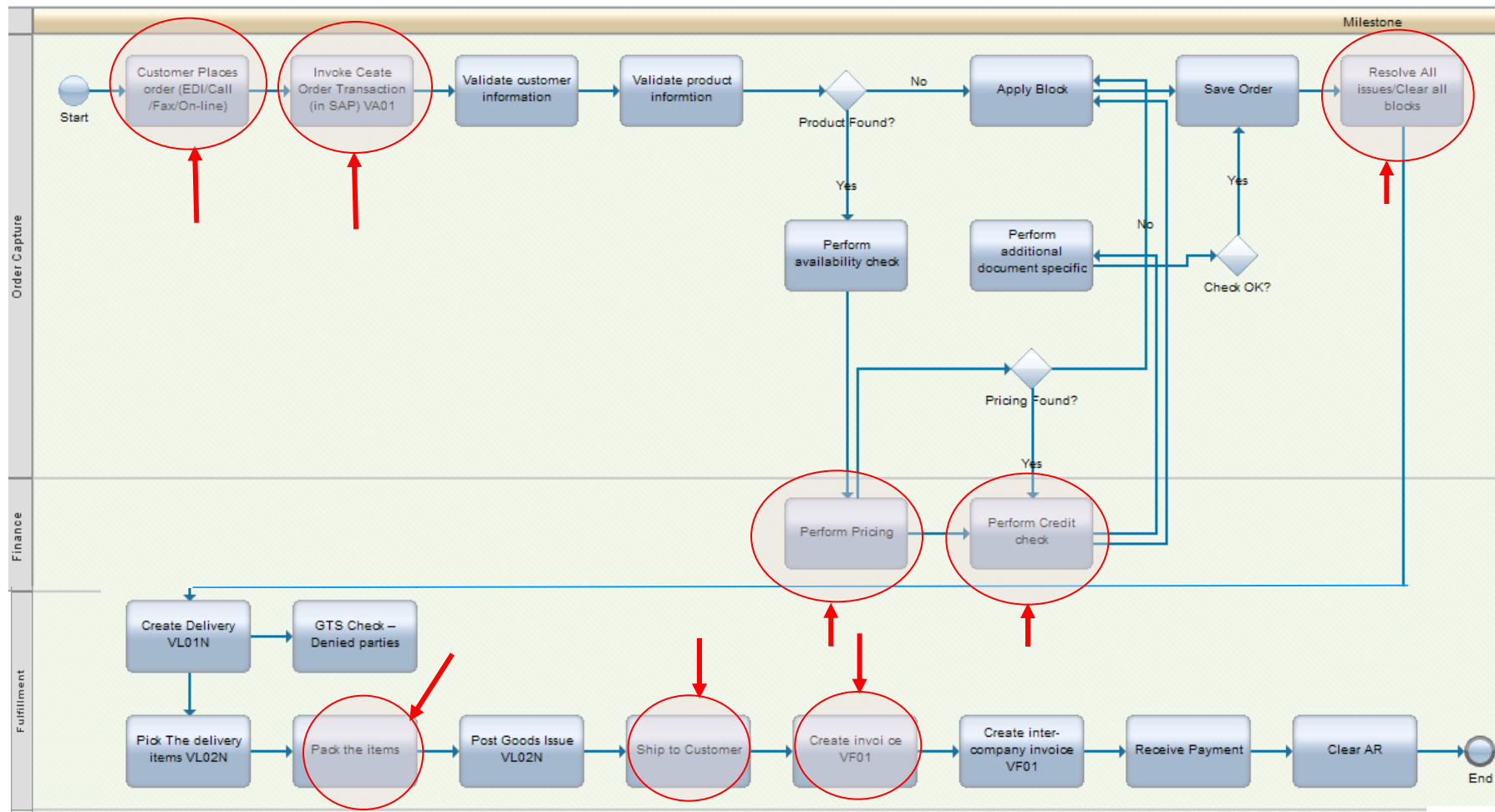

- Gain real time operational insight. Monitor total cycle time, process step cycle time, lag times between process steps, average queue size, actual queue at time of execution
- Orchestration is not necessary!
- Identify exception process frequency and causality

# Operationalize OTC KPI and SLA Management with IBM BPM

## For Business Outcome Assurance - At Any Process Level

**Real-Time Operational and Value Realization Dashboards**

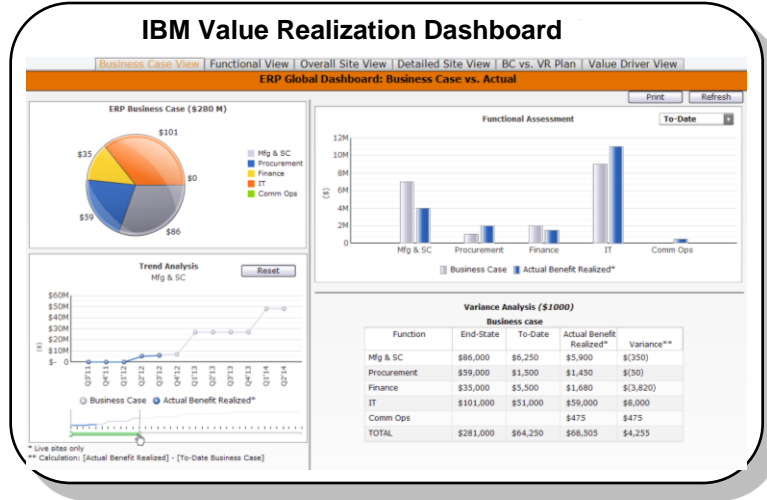

### Business Alignment & Ownership



**KPI Operational Playbooks**

- **What** KPI's should be tracked
- **Who** is accountable for performance
- **When and How** KPI governance will take place

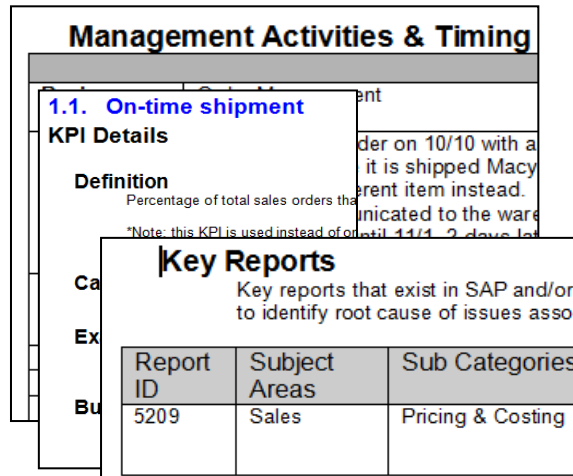

### Playbook Orchestration

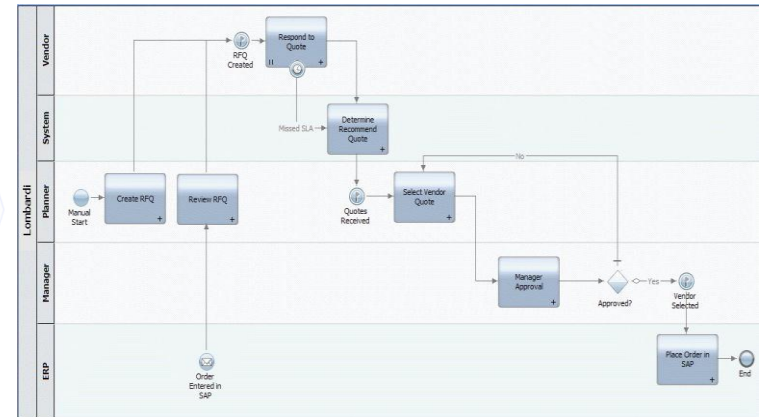

# IBM BPM for SAP Value Realization Benefits

- Actively **manage value realization** across all stakeholder communities
- Align and simplify stakeholder outcome **accountability**
- **Assure KPI and SLA outcomes** at each level in the organization accountability chain
- **Formalize, manage and optimize** mature exception processes
- Apply systematic **governance** to value management processes to continuously improve business outcomes
- Easily identify areas of **highest business impact** for investment



# SAP Value Realization Demo

# SAP Iterative Blueprinting



# Traditional SAP Implementation Approach

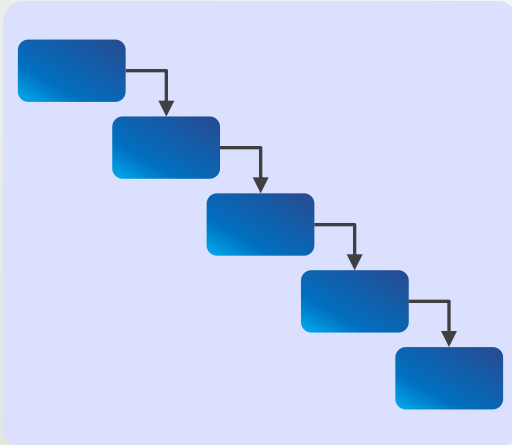

- Most SAP implementations follow a typical waterfall approach
  - Goal setting
  - Analysis
  - Design
  - Test
  - Deployment
- SAP maintains their process flows in Solution Manager, (*documentation only*)

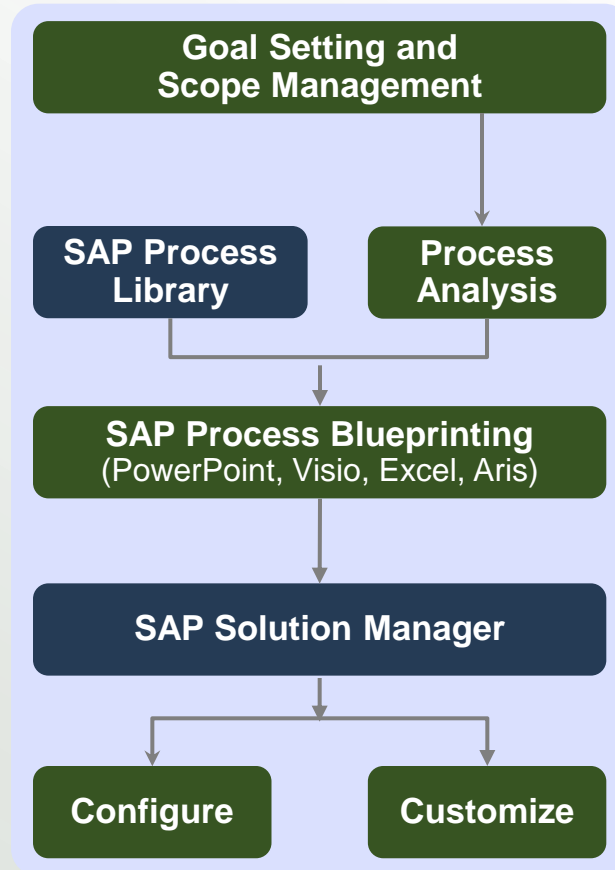

- Most SAP customers use *general purpose documentation tools* such as Office or Visio
- Some leverage Aris or another documentation-centric *modeling tool*
- These tools encourage:
  - Documentation-centric SAP implementations
  - A waterfall approach filled with risk and multiple delay points
  - Lengthy ‘analysis paralysis’

# Guided Workflow Enables Iterative SAP Process Blueprinting

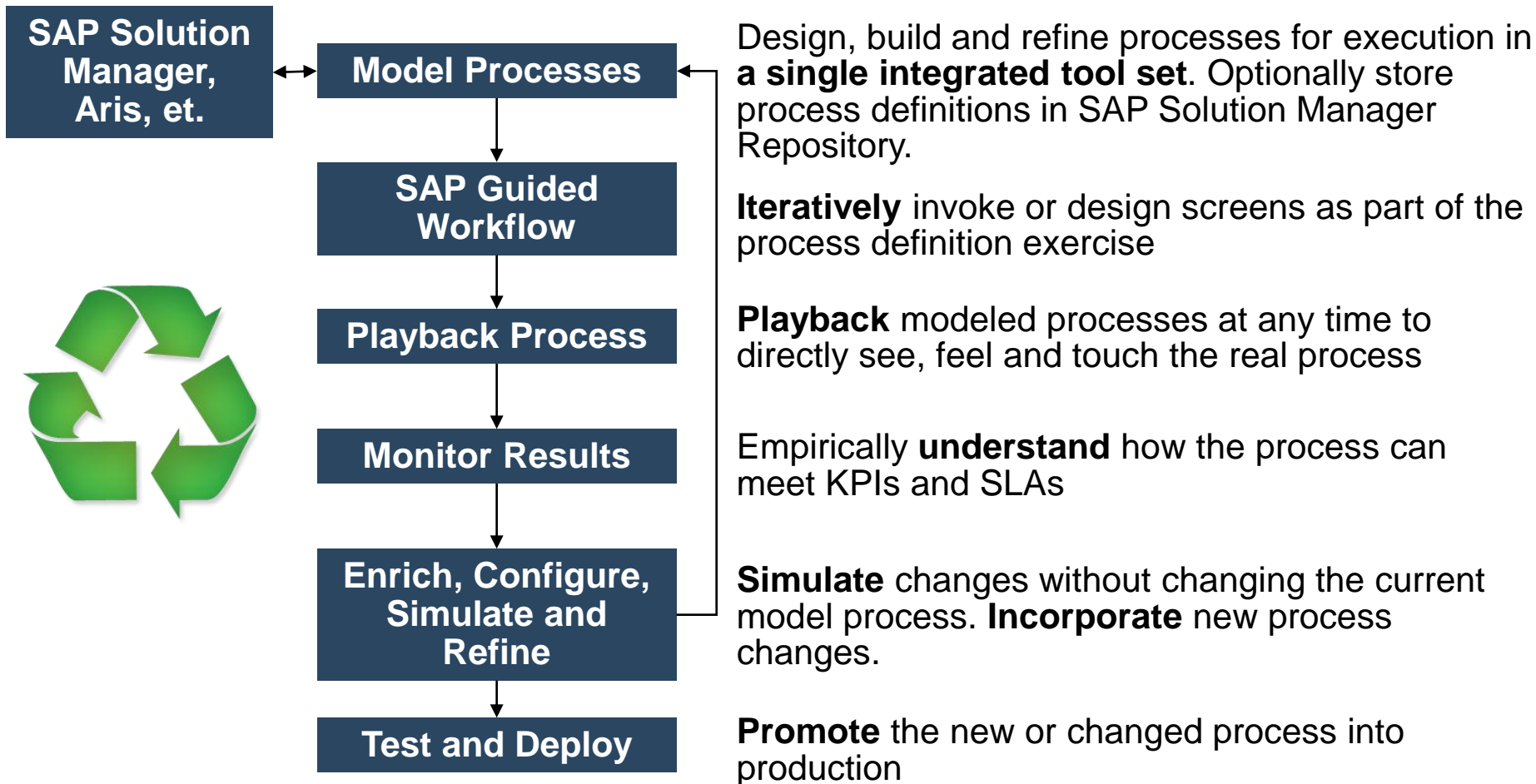

*Use 'live' process execution to design and test SAP business processes, then implement your SAP process using the same tool!*

# The IBM SAP Agile Delivery Process

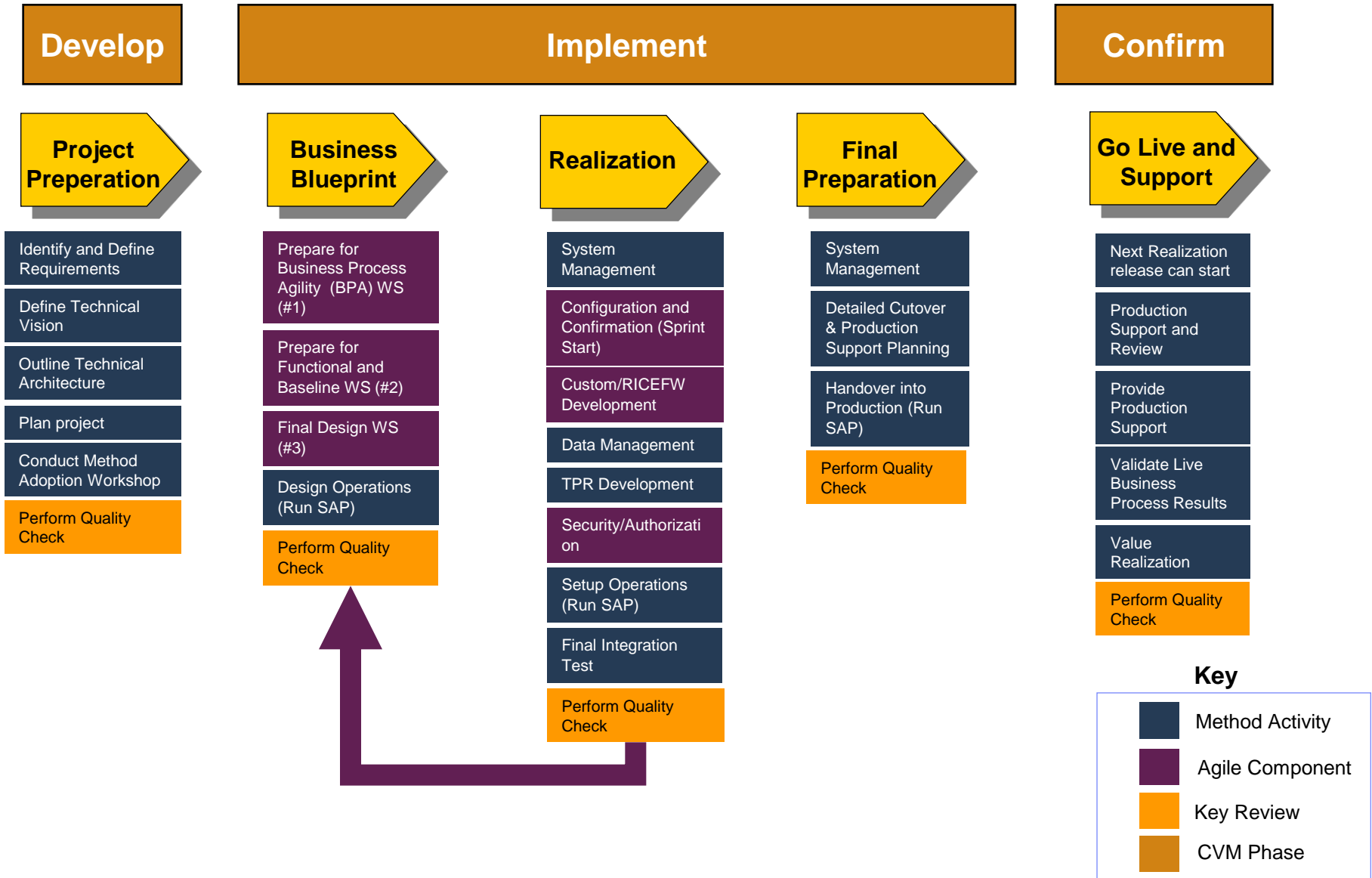

## Example: Traditional vs. Agile Blueprinting

Features	Traditional Process			New Paradigm
	MS Visio	MS Word	MS Sharepoint	IBM BMP 8.5 Advanced
Design and build process models using one tool set	✓			✓
Functions as Central Repository & Built-in Version Control		✓	✓	✓
CMIS Compliant (Content Management Interoperability System)			✓	✓
Backend Integration with SAP & Non-SAP Systems				✓
SAP Guided Workflow - Iteratively design and invoke SAP screens as part of the process definition exercise				✓
Test and Validate Processes during workshop sessions				✓
Real-time Team Collaboration				✓
Set KPI definitions, Identify Process Constraints				✓
Collaborative Social Interactions and Actionable Dashboards/Reports				✓
Generate Documentation for Solutioning exercises (Ex. PDD)		✓		✓
Process Simulations to calculate cost and ability to setup SLA's per process Model				✓

### The Process Modeling Evolution defined.... Connect Strategy to Build to Execution

- **Map:** Capture a business process in its basic form – including “Happy Path” and known variations
- **Model:** Extend process Maps to include exceptions and other information in preparation for execution
- **Execute:** Taking a Model to a level of detail and integration that makes it executable in IBM BPM

# SAP Iterative Blueprinting Demo

# Agenda

Topic	Start Time	Speaker
<b>Registration/Breakfast</b>	8:30 AM	
Welcome	9:15 AM	Joe Kaczmarek
The process imperative for SAP implementations	9:25 AM	Joe Kaczmarek
What is IBM BPM for SAP?	9:45 AM	Joe Kaczmarek Richard Davies
<b>MORNING TEA</b>	10:30 AM	
A day in the life of order to cash	10:45 AM	Joe Kaczmarek Richard Davies
Value Summary and the SAP Process Opportunity Workshop	11:15 PM	Joe Kaczmarek
<b>Networking</b>	11:30 PM	
Adjourn	12:00 Noon	



# Agenda

Topic	Start Time	Speaker
<b>Registration/Breakfast</b>	8:30 AM	
Welcome	9:15 AM	Joe Kaczmarek
The process imperative for SAP implementations	9:25 AM	Joe Kaczmarek
What is IBM BPM for SAP?	9:45 AM	Joe Kaczmarek Richard Davies
<b>MORNING TEA</b>	10:30 AM	
A day in the life of order to cash	10:45 AM	Joe Kaczmarek Richard Davies
Value Summary and the SAP Process Opportunity Workshop	11:15 PM	Joe Kaczmarek
<b>Networking</b>	11:30 PM	
Adjourn	12:00 Noon	



# IBM BPM for SAP – Process Level 3

*Guided Workflow – Automatically Sequence and Route SAP User Transactions*

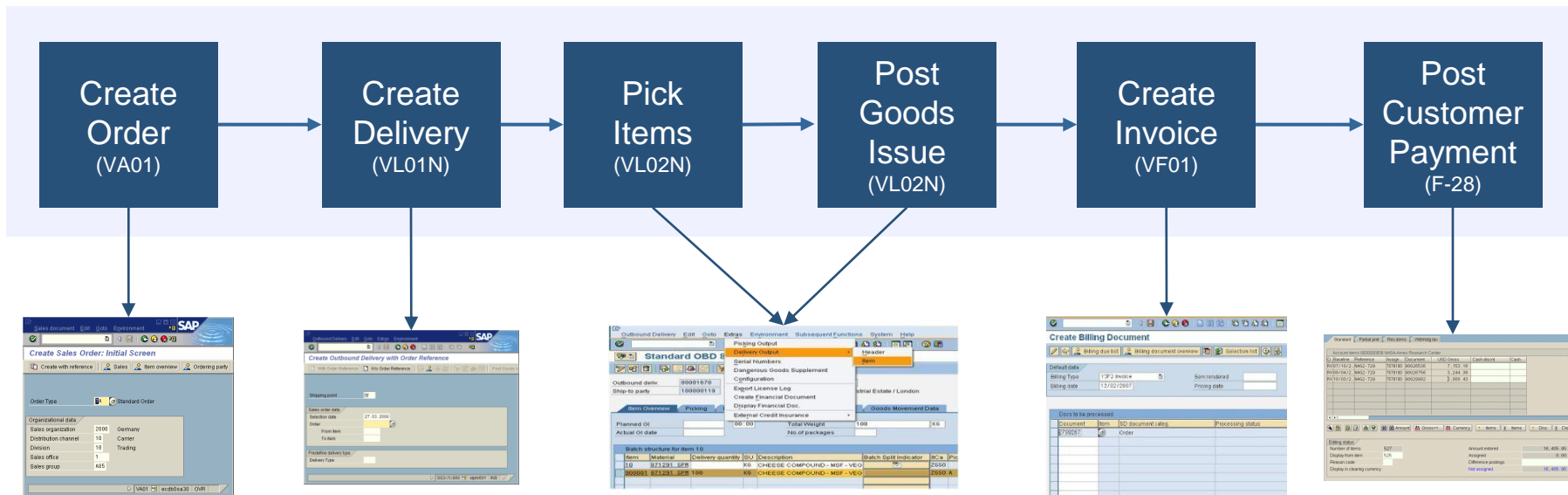

- Automatically sequence the correct SAP transactions for the correct users at the right time, in the right execution priority
- Easily detect and correct bottlenecks and other critical process issues
- Leverage collaborative capabilities to enable users work together in real-time to reduce cycle time
- Automatically allow end users to see all the relevant details about a process definition and a specific process instance



# The Actual OTC Process is Actually More Complex

*Includes Level 5 and Deeper*

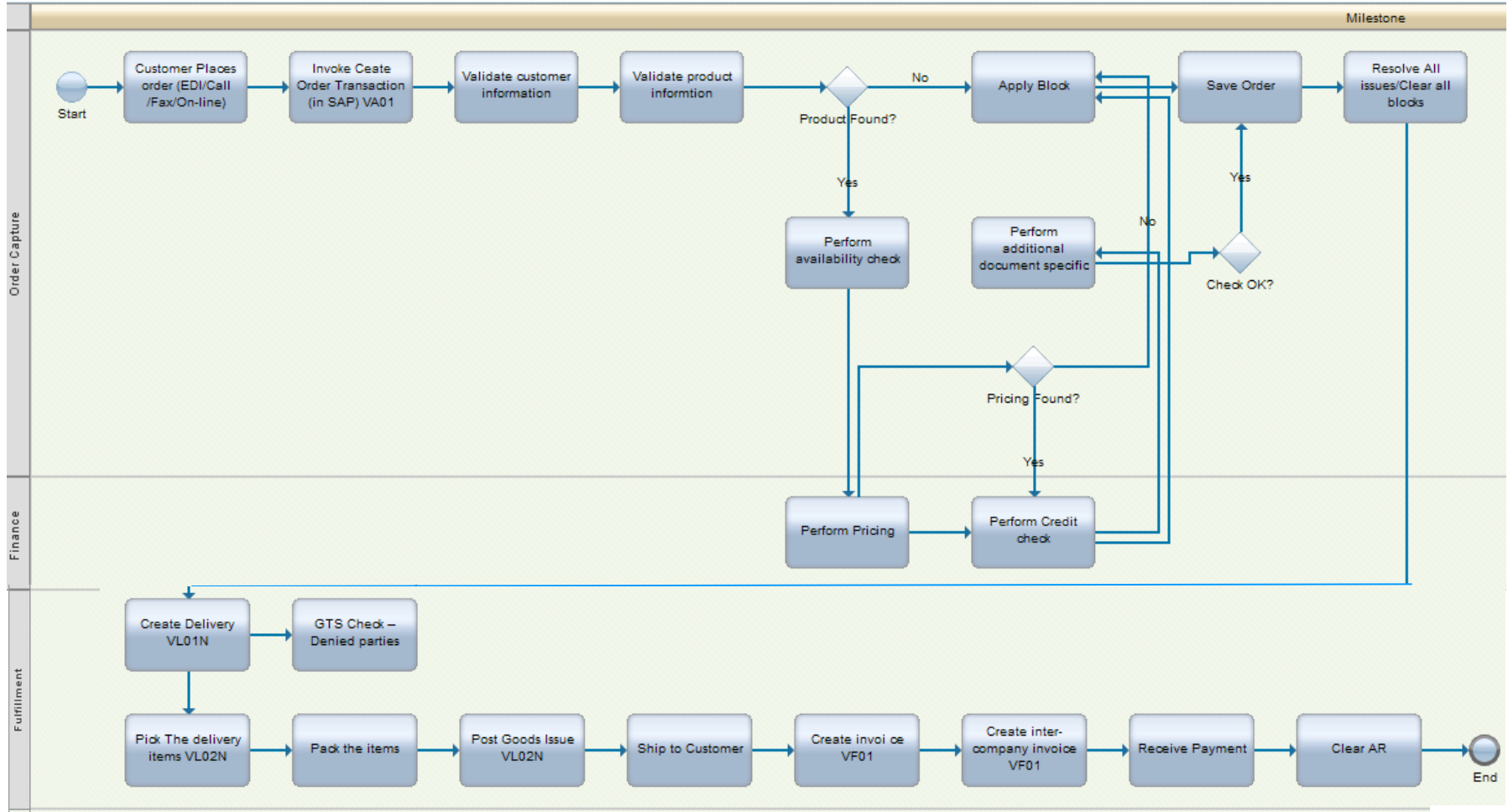

***A complete business process typically contains more detail than what is normally defined in the SAP BPH.***

# The OTC Process is Fraught with Pain Points

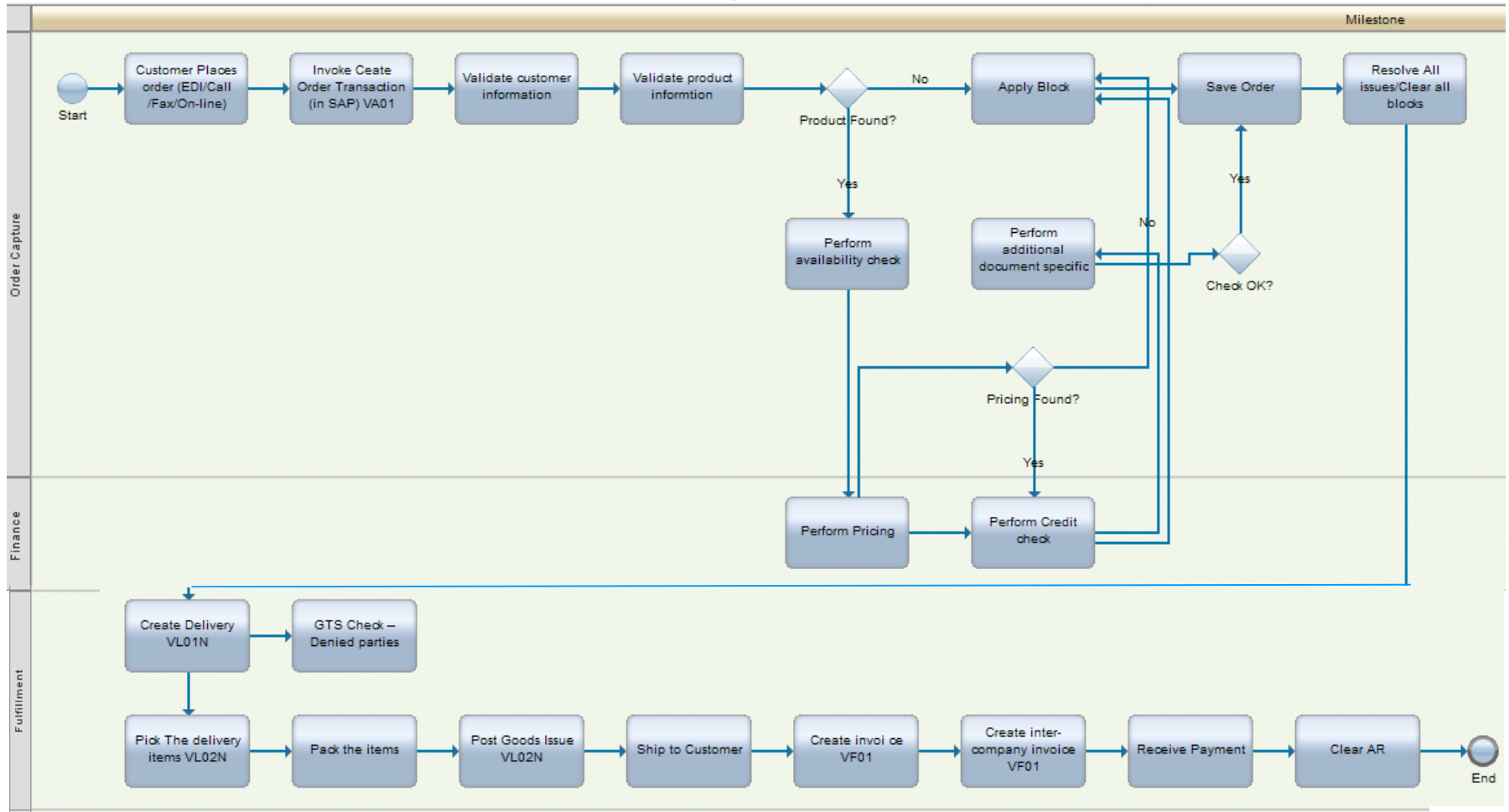

***OTC issues cause order delays, add costs and increase the risk of lost orders, or even lost customers.***

# OTC Exceptions Candidates for BPM - Order Capture

*Typically Level 5 and Below*

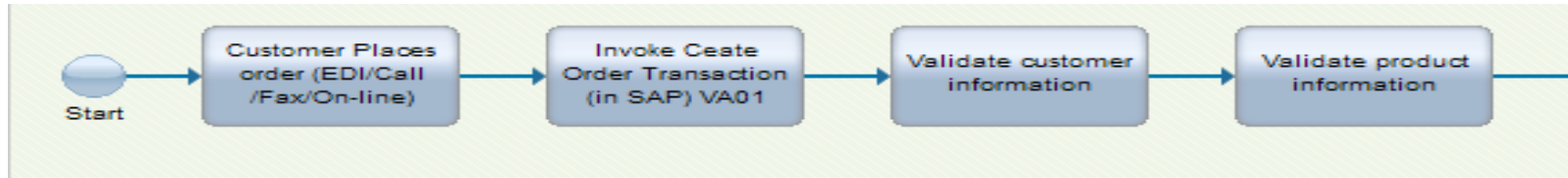

- Not knowing when to start, suspend, resume or cancel the order capture process

- Errors in the EDI or B2B communication process or data payload

- Customer not currently in SAP
- Customer information in SAP is incorrect
- Multiple custom numbers exist in SAP for the same customer
- Incomplete ship-to information

- Customer product number provided on order does not cross-foot correctly to Global Data Synch data
- Incomplete or inconsistent product line item validation on a web commerce site
- SAP product master unit of measure does not match customer order unit of measure
- Customer-supplied description does not match SAP



# OTC Candidates for BPM – Resolving Order Bottlenecks

*Typically Level 5 and Below*

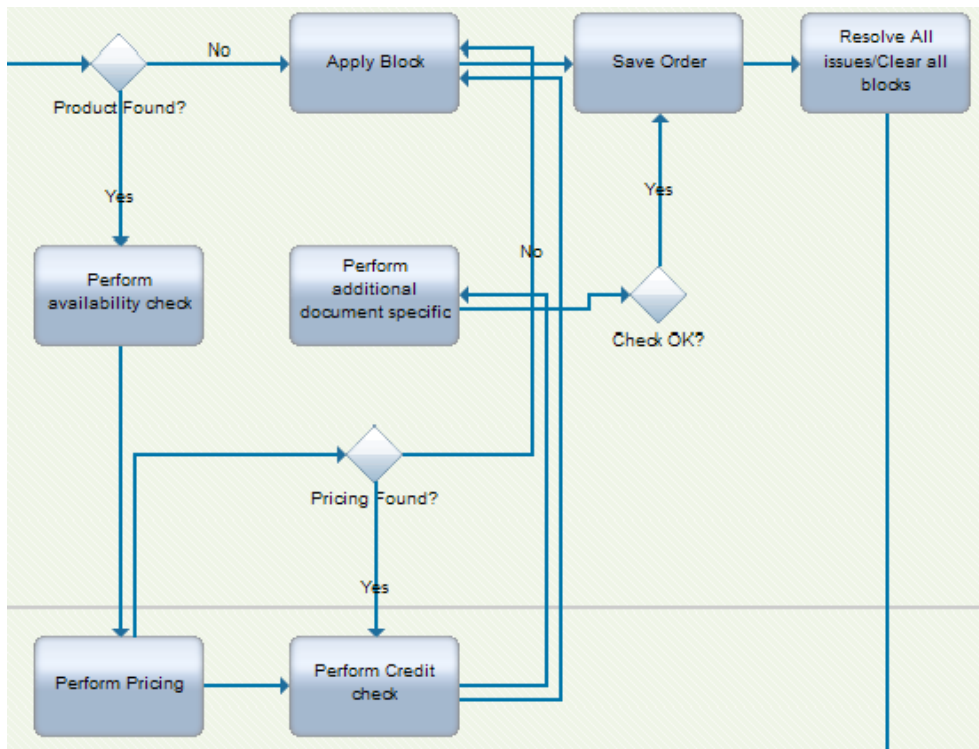

- Resolve blocked orders due to invalid items (VA02)
- Expedite and prioritize credit approval requests going to customer service
- Automate business rules to expedite 'credit limit exceeded' bypass
- Integrate drop shipment into order entry process
- Automatically invoke the remediation to resolve pricing issues (missing price, special discounts)
- SAP allows only one order block at a time – use BPM to automatically initiate steps to create, manage and resolve multiple blocks
- Complex pricing and chargeback scenarios
- Prioritize limited inventory to optimize revenue and customer satisfaction
- Backorder rescheduling

# OTC Exceptions Candidates for BPM – Fulfillment

*Typically Level 5 and Below*

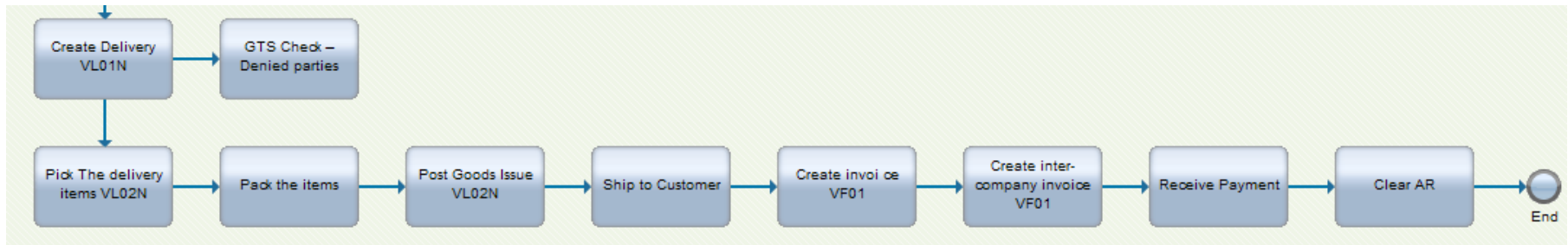

- Compliance with customer-level and order-level shipping rules and customer SLAs - to prevent customer loss due to SLA violation
- Rules and processes to allocate and resolve miscounted inventory
- Prioritize limited inventory to optimize revenue and key customer satisfaction
- Immediate backorder reschedule when the wrong material is received in the warehouse (normal or cross dock)
- Real time cross-dock revenue or key customer optimization
- Assorted shipping anomalies (not enough space on truck, customer truck late, etc.)

# Understand and Manage The OTC Process – Even Without Orchestration!

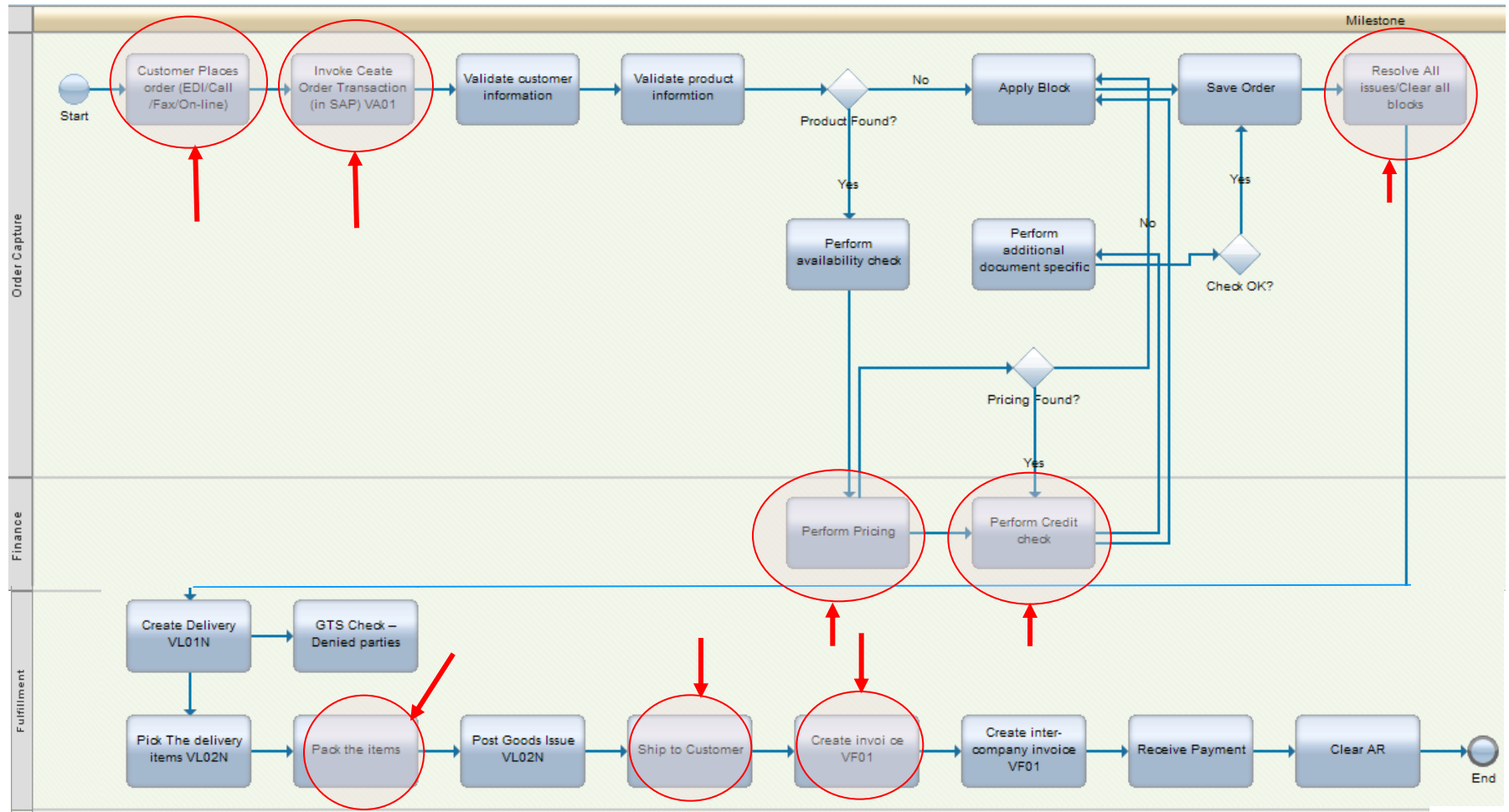

- Gain real time operational insight. Monitor total cycle time, process step cycle time, lag times between process steps, average queue size, actual queue at time of execution
- Orchestration is not necessary!
- Identify exception process frequency and causality



# IBM BPM for SAP Can Orchestrate the Entire OTC End-To-End Process for High Business Optimization

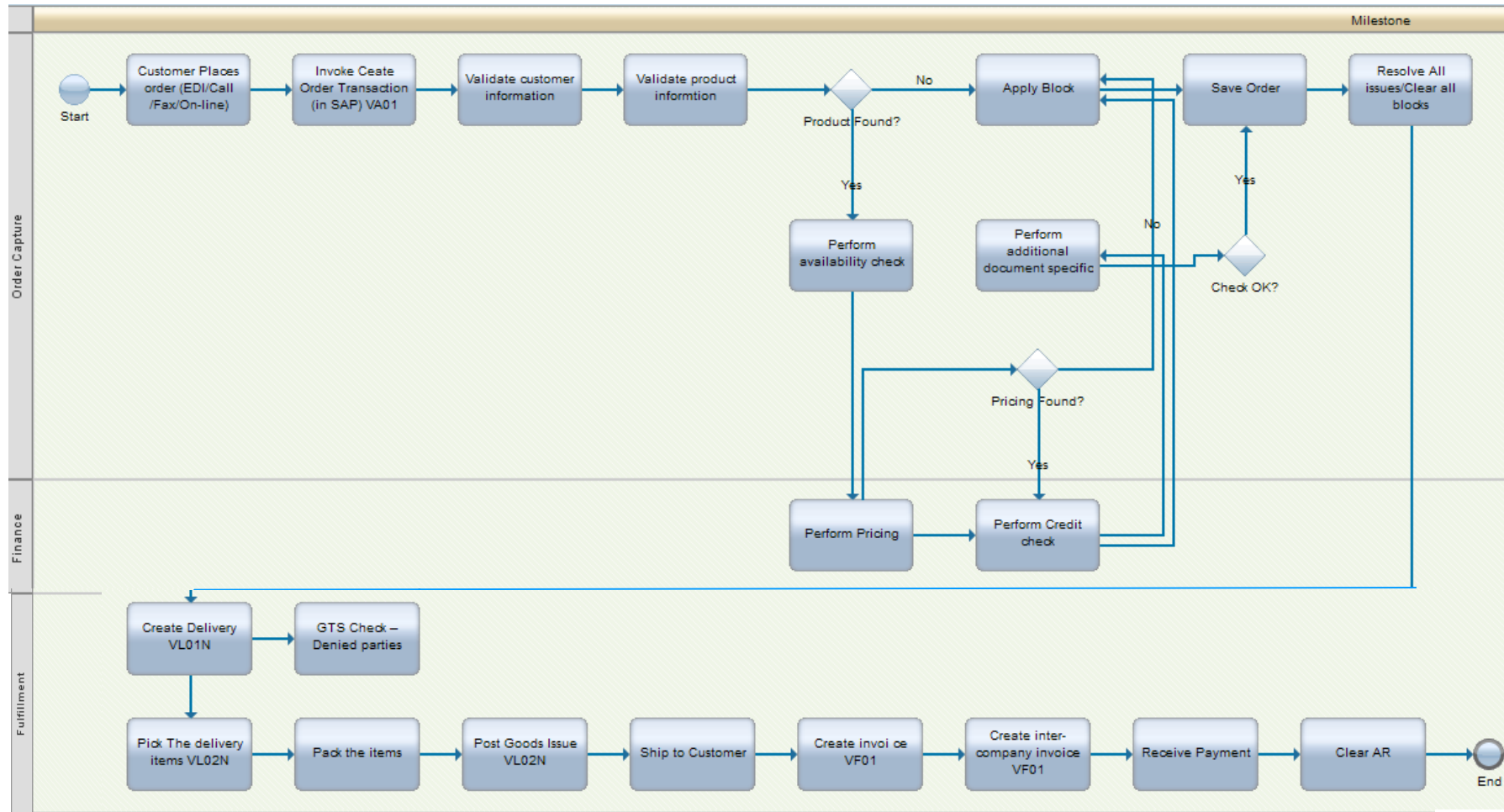

**Orchestrate, automate and monitor as much of the OTC process as is needed to optimize the OTC process to its next level of maturity**

# Benefits of SAP Transaction Decomposition

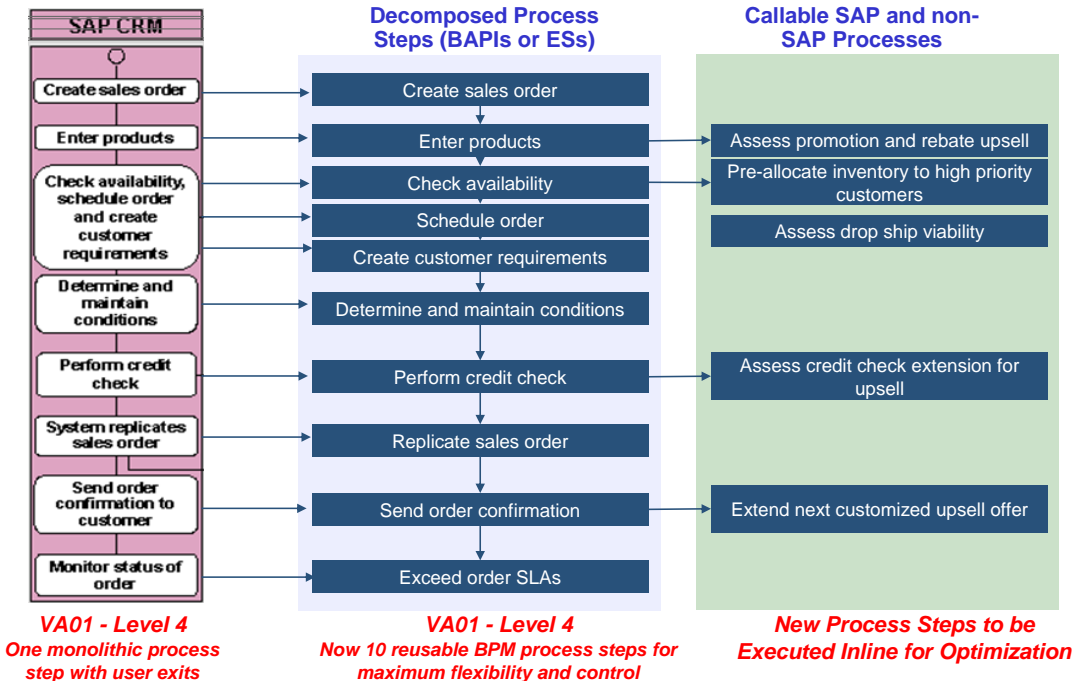

- Provide granular, online process **guidance** for key transaction components
- **Ensure** that key process components are executed (at all) and at the right time
- Avoid **e-mail and phone calls** typically needed for collaboration among the roles
- **Prioritize** tasks dynamically
- **Correlate** forked activities that typically cause increased cycle time or bottlenecks (e.g. credit approval)
- Provide real-time **visibility** to operational and management stakeholders
- **Integrate** additional functionality without the side effects of user exits
- **Operationalize** KPI and SLA management

**Alternative, 'companion' or subordinate processes can be orchestrated in IBM BPM after a traditional SAP transaction has been fully or partially completed.**



# Sample Decision Table to Optimize Shipment Value

<b>Scenario 3 Rules</b>				
Gold Customer?	Order value	Line item quantity available to allocate is less than the quantity required (shortage)	Total available + already allocated satisfies line item quantity	Optimization Process to Initiate
Yes	>= \$250,000	Yes	Yes	Reallocate inventory to gold order and deploy premier customer care for reallocated customer orders (includes rescheduling)
			No	
	<\$250,000	No		
No				

***This decision table automatically optimizes the utilization of available inventory by automatically changing the SAP business process and previous allocations to maximize shipment quantities to priority customers.***

# Key IBM BPM Capabilities and Benefits for SAP OTC

## ■ Key Capabilities:

- **Automatically disposition, prioritize and route** exceptions and contingencies
- **Reduce user intervention** in process completion
- **Gain assurance** that the entire process is actually executed
- Automatically identify, route and prioritize key **exception mitigation** processes to help meet KPIs and SLAs

## ■ Benefits:

- Reduce order processing **costs and cycle time**
- Improve **customer satisfaction**
- Optimize **revenue potential**



## Some Other Uses of Transaction Decomposition in OTC

- Use sophisticated SAP screen parameterization to completely eliminate 'coding' sheets and post-it notes
- Split each 'step' of the sub-transaction process into separate GUIs in order to simplify, properly allocate and distribute work to the right communities
- SAP allows only one order block at a time - automatically route and prioritize blocked orders to the correct sub-process and workgroup based on type of block or block combinations
- Automatically relax or tighten the credit check process and credit rules based on business conditions in order to optimize revenue
- Dynamically prioritize credit reviews for top customers and largest orders
- Automatically invoke drop shipment options for certain types of inventory shortages
- Spread high demand, low availability items across the highest priced orders in order to optimize revenue
- Deploy dynamic cross-docking
- Automatic backorder scheduling
- Dynamic recovery for common shipping anomalies

## Other Common IBM BPM for SAP Use Cases

- Revenue optimization
- Regulatory compliance
- Supply chain exception handling
- Design/execution integration
- New product introduction
- Vendor sourcing and procurement compliance
- New product and pricing release
- New employee onboarding
- SAP custom development
- SAP CoEs



# Agenda

Topic	Start Time	Speaker
<b>Registration/Breakfast</b>	8:30 AM	
Welcome	9:15 AM	Joe Kaczmarek
The process imperative for SAP implementations	9:25 AM	Joe Kaczmarek
What is IBM BPM for SAP?	9:45 AM	Joe Kaczmarek Richard Davies
<b>M O R N I N G T E A</b>	10:30 AM	
A day in the life of order to cash	10:45 AM	Joe Kaczmarek Richard Davies
Value Summary and the SAP Process Opportunity Workshop	11:15 PM	Joe Kaczmarek
<b>Networking</b>	11:30 PM	
Adjourn	12:00 Noon	



# Surround SAP With a Highly Flexible Process Layer

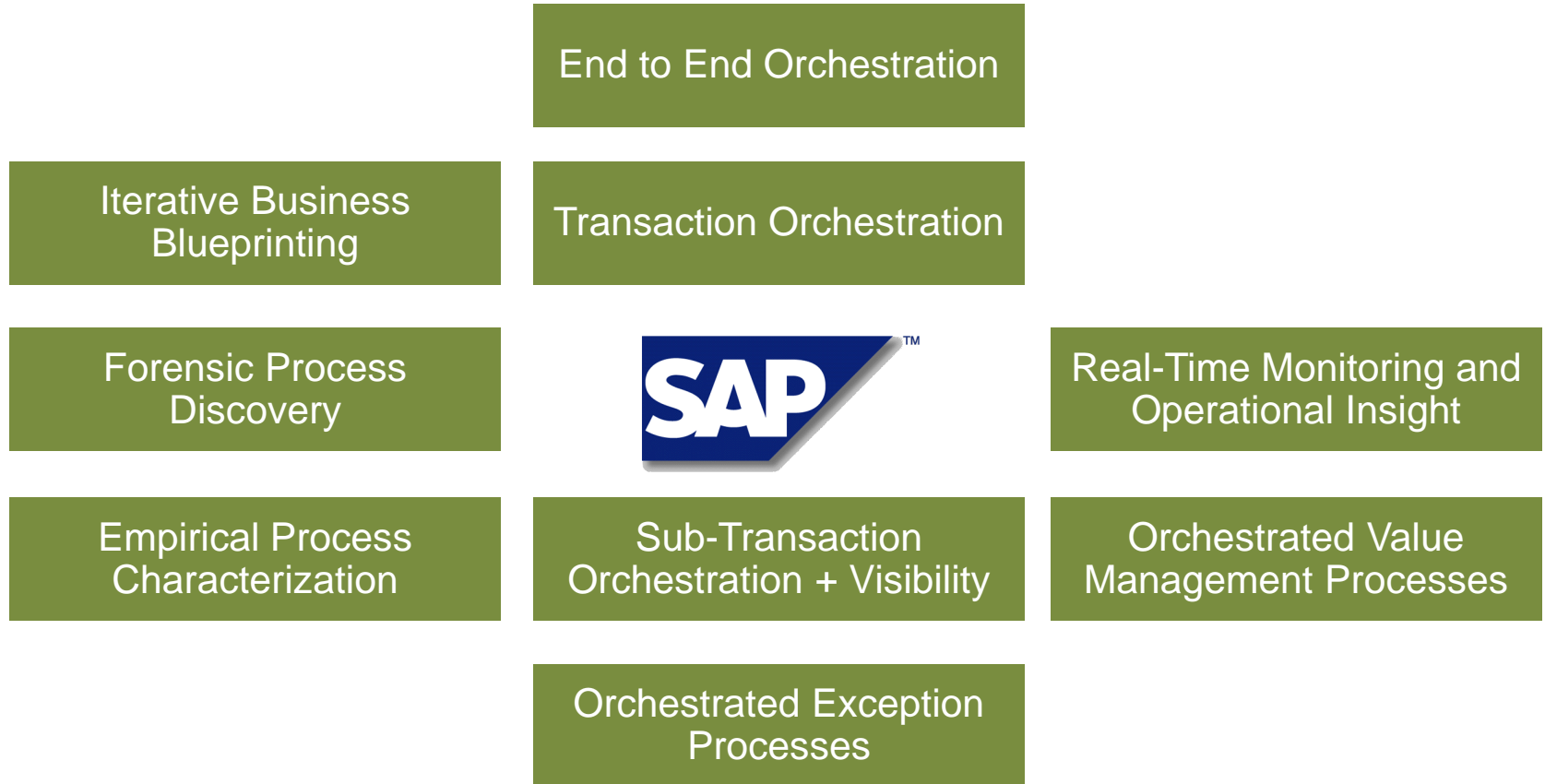

***IBM BPM for SAP delivers a radically superior SAP process paradigm.***

# Use IBM BPM Throughout Your SAP Life Cycle

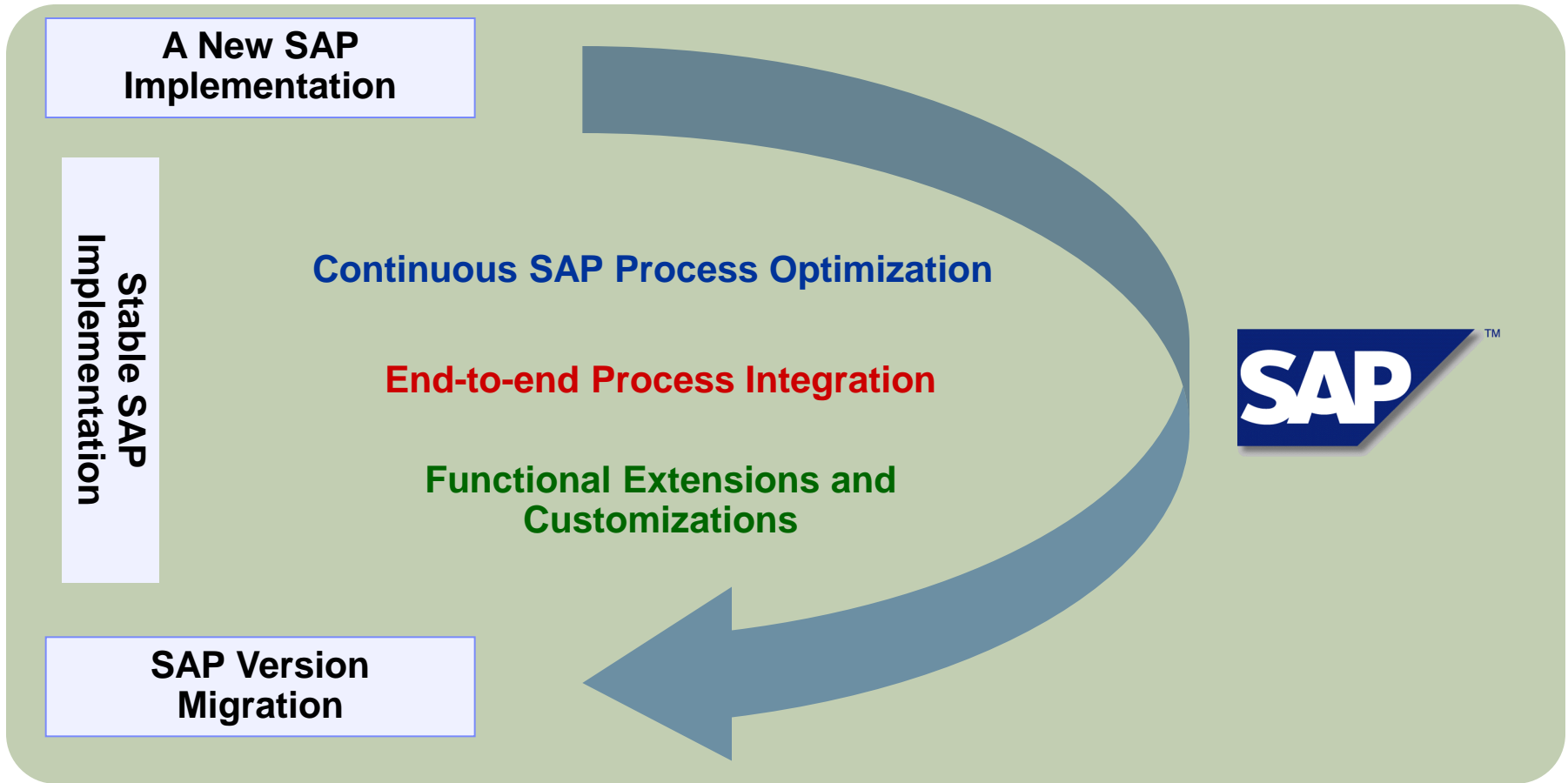

*Any SAP Implementation can benefit from every IBM BPM capability at every life cycle stage.*

# IBM BPM Helps Reduce Most SAP Customizations

Core business logic

Data access, quality and integration

Process flow and integration

Business rules

User interface and other usability issues

Application integration and technical collaboration

## IBM BPM Capabilities

*Guided workflow and process orchestration*

*Business rules and complex event processing*

*Reusable coach views; guided workflow*

*SAP integration modules and Advanced Integration Services*

*IBM BPM helps to reduce these classes of SAP customizations – the highest volume of customizations*



# IBM BPM Reduces the Scope and Cost of SAP Upgrades

- Process hierarchy modeling
- Process change visualization and playback
- Rapid prototypes
- Reduced scope of impact analysis
- SAP customization removal and reduction
- Externalization of SAP customization

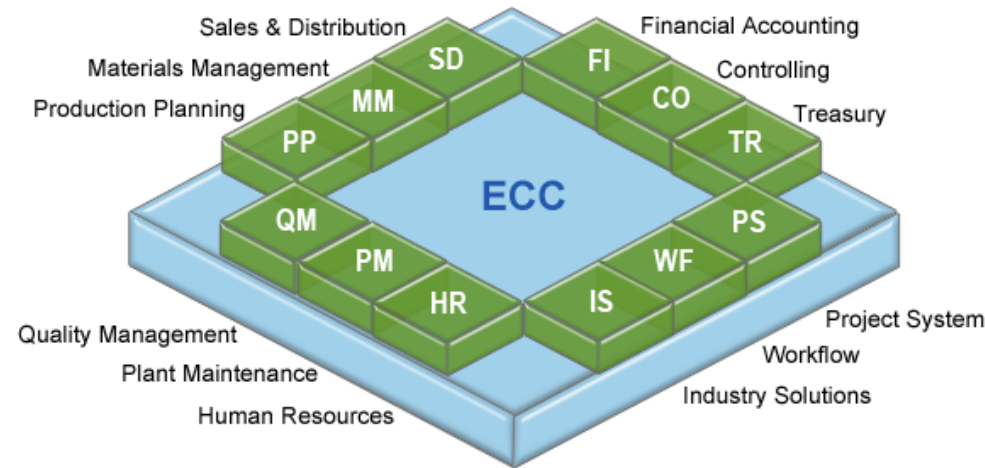

# Achieve Active Business Performance Optimization

## Operational Intelligence

Transform visibility into insight and action

## Agile Processes

Change processes at the pace required by the business

## Value Realization

Manage value with closed loop triggers and orchestrated playbooks

- Operational intelligence
  - Drives the need for action
  - Assists or automates inline decision making
  - Helps the business characterize issues and potential solutions
- Agile processes enable new insights to be implemented at ‘business speed’
- Value realization detects performance measure threats and initiated and manages structured and artful responses
- This combination allows the business to optimize its operations to dramatically improve business outcomes

# IBM BPM for SAP Value Summary – Typical \$30M USD Implementation

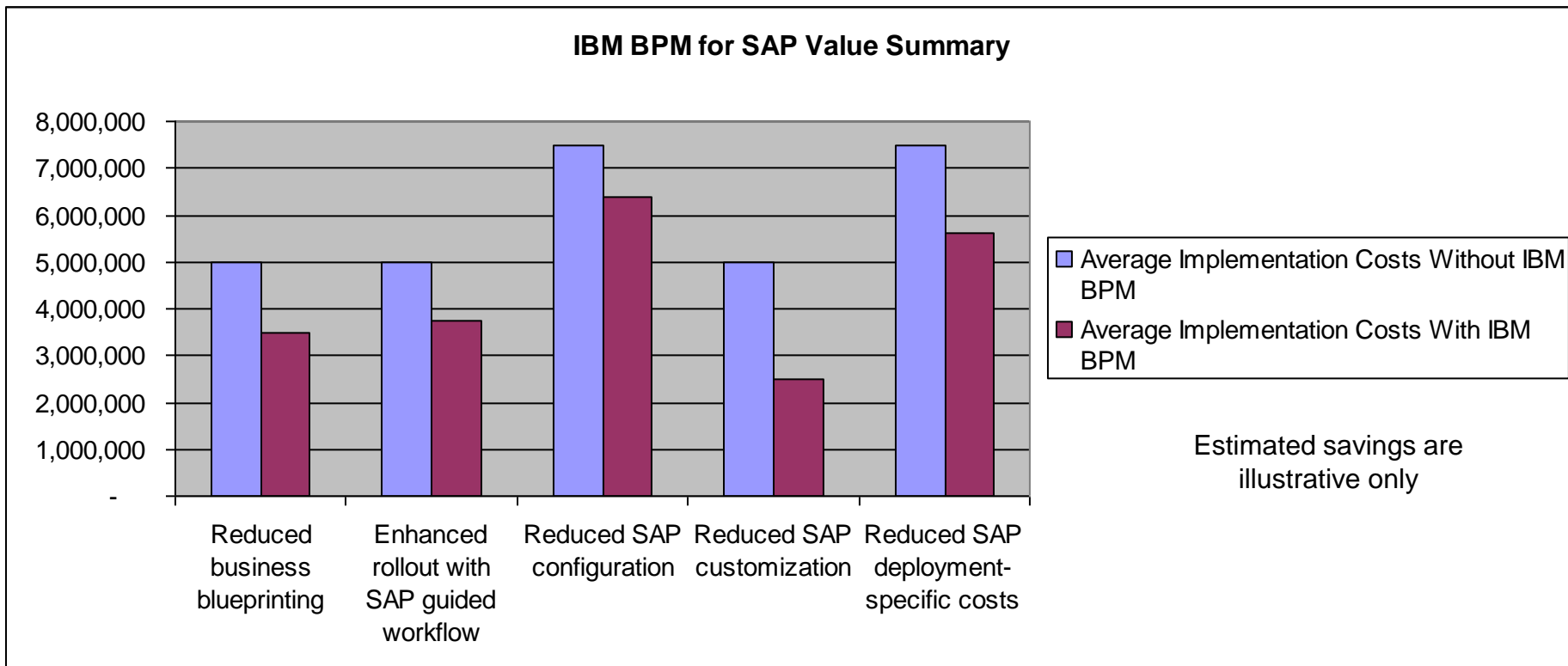

***IBM BPM for SAP, when used with IBM’s agile SAP approach, can reduce the cost of an average SAP implementation by 25-30% with a net savings of 10-15%.***

# IBM BPM for SAP Post-Implementation Benefits

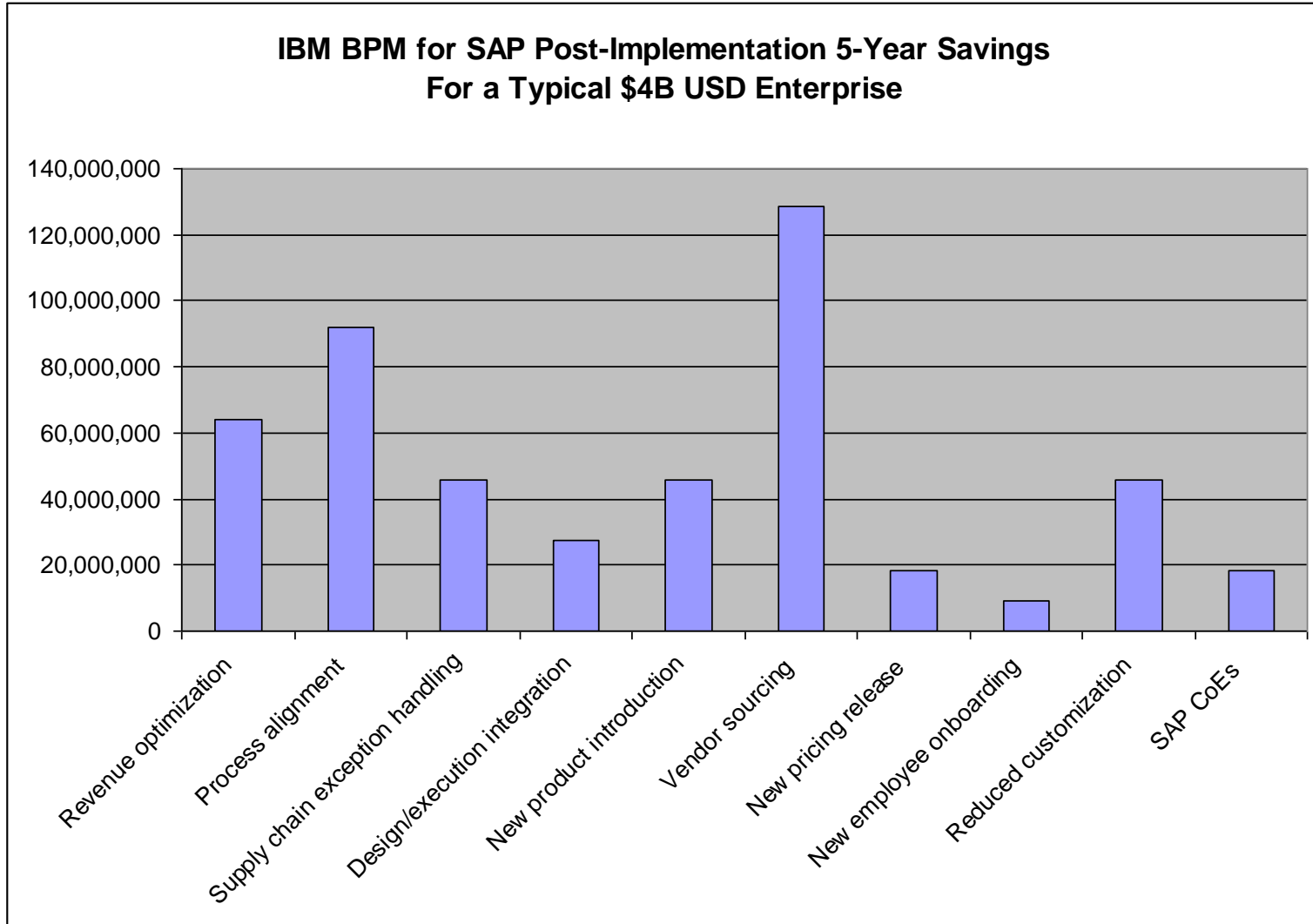

Estimated savings are illustrative only

# Large US Toy Company Improves SAP Supply Chain Processes to Reduce Costs

## Challenge:

- Increase responsiveness with customers and collaboration with suppliers while utilizing previous investments in core enterprise applications

## Benefits:

- **Increased productivity by 250 percent** without additional resources being put into play
- **Reduced cycle times by 80 percent**, from 12 days to only two
- Improved overall business efficiency

## BPM Solution

- Gathers the bill-of-lading information from freight forwarders and corresponding invoice data from SAP at the right time
- Automatically prepares and routes all documentation required
- Automates the reconciliation process required for all US Customs requirements, updating SAP at each milestone



***IBM BPM reduced dependency on phone calls, e-mails and paper faxes, while standardizing communication between employees and vendors with increased process visibility***

# Leading Global Apparel Manufacturer Needs SAP Blueprinting At Light Speed

This client begins with a passion for its products and a deep understanding of its consumers. Their rigorous method combines data-driven insights, expert execution, and some of the most creative minds in the industry, with expert help from IBM. The results are products that strengthen the bond between consumers and brands.

## Business Challenge

This client endeavors to be fast and flexible, leveraging its highly diversified global supply chain so it can continue to expand its reach around the world. With a new SAP ERP global deployment, this client needed to blueprint over 300 business processes for integration into SAP Solution Manager.

## Solution and Benefits

The blueprinting approach included IBM BPM, IBM Bluework Live and IBM services to streamline process design before input into SAP Solution Manager. Out of an estimated 300 processes for the project, **the client blueprinted over 120 of them in days using our SAP modeling capabilities by putting the process design directly in the hands of the process owners.** The client needs to be fast and flexible and IBM BPM gives them the agility they are looking for.

# A Leading Electronics Manufacturer Uses IBM BPM for SAP As a Strategic Weapon

This client is a diversified company, focused on improving people's lives through timely innovations. As a world leader in healthcare, lifestyle, and lighting, this leading manufacturer integrates technologies and design into people-centric solutions, based on fundamental customer insights and the brand promise of **sense and simplicity**

## Business Challenge

The client needed to be more agile and change the “clockspeed” of the company by decreasing process cycle times and business change cycles. It is also targeting substantial reduction of inventory levels in order to reduce risk and costs.

## Solution and Expected Benefits

- **Speed to market:** Reduce average time to market by 20-25%
- **Inventory:** Reduce inventory days by 25-35%
- **New product success:** Strengthen leadership position by 3 percentage points per year

# Examples of IBM's Own BPM Projects and Benefits

Business  
Agility  
Achieved

**Mid-Market Deal Registration:** Delivered **\$18.5M 2012 PTI** by reducing deal registration cycle time with rules-based work-flow automation.

**Supply Chain Alerts:** **Over \$2M annual savings** for timely notifications when supply chain disruptions occur.

**Pricing estimator for Cross-brand solutions:** **Reduced pricing proposal implementation from 14 days to 1 day** and deployment to new countries in days versus weeks.

**GTS Cloud Sales Enablement:** Integrated work-flow, rules and monitoring to reduce partner “register to welcome kit” cycle-time from days to hours.

**GMU Geo Location Code Assignment:** Geo location code is key enabler of GMU expansion. **Eliminated manual process** and enabled GMU reps to update rules directly and reduced cycle time to update and run rules from several weeks with many handoffs to just a week for more than 50 countries.

**MTS:** Increased IBM Client satisfaction through proactive notification of exposures in clients’ IT inventory by applying rules derived via analytics. Proof of value delivered.

**Infrastructure Optimization:** **Reduced cycle time by 75%** to complete the analysis required to migrate from Physical servers to Virtual servers.



# Build Your Roadmap to Achieve SAP Process Innovation

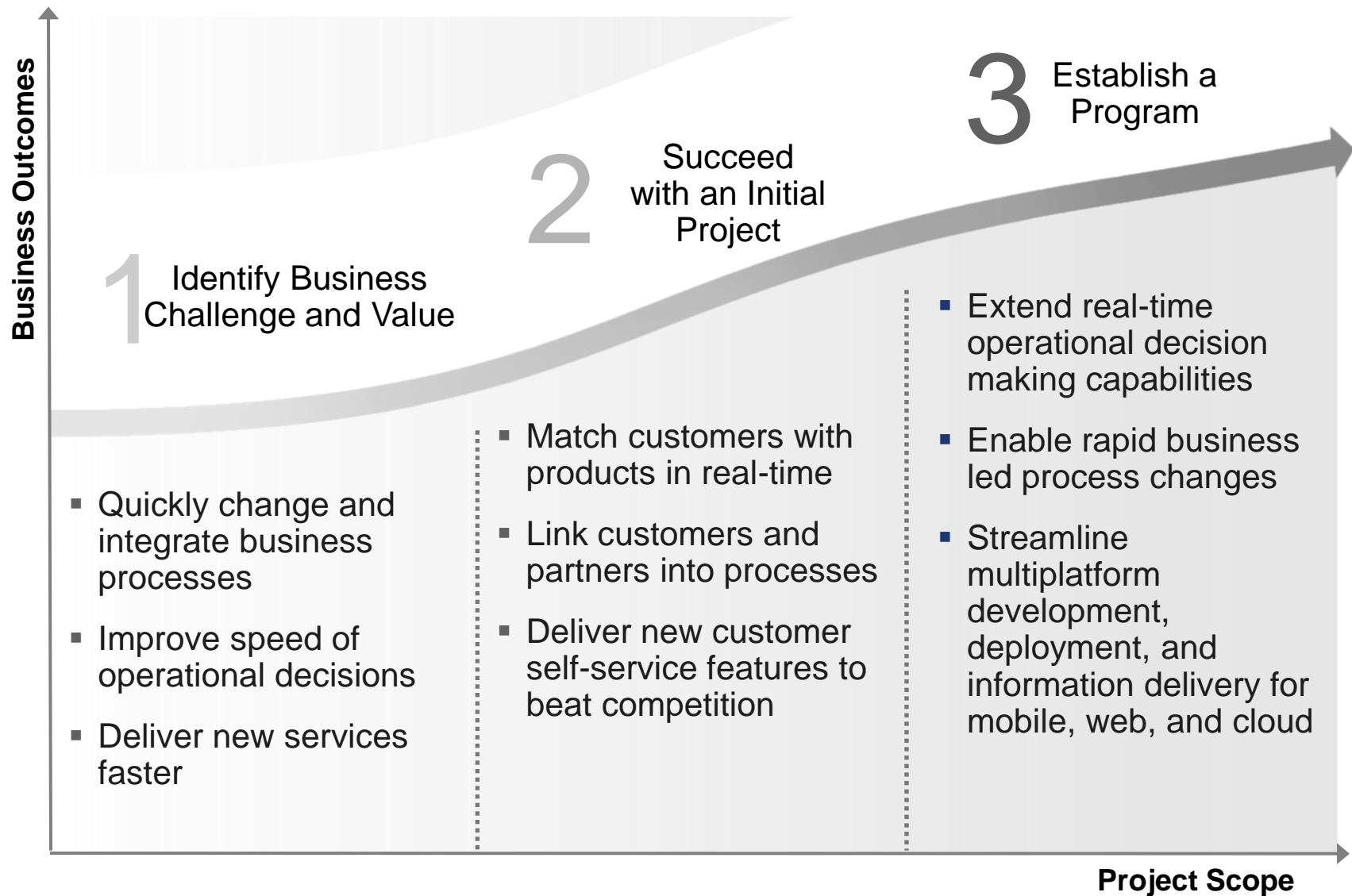

# The SAP Process Opportunity Workshop

- **A collaborative workshop between IBM and you to:**
  - Determine which areas of business pain and/or opportunity are good fits for BPM for SAP
  - Select candidate process sets with high affinity to IBM BPM for SAP
  - Identify and prioritize potential pilot projects
  - Select and scope a pilot project (90-120 days)
- **What does the IBM team do?**
  - Clarify the pilot project scope
  - Characterize the expected business impact and benefits
  - Assess the high-level implementation effort and solution development
  - Identify and rank additional projects beyond the pilot project
- **How does it work?**
  - Onsite discovery sessions with process owners, business and technology stakeholders
  - Pre-workshop preparation calls to identify potential improvement opportunities and set the workshop agenda
  - Preparatory time for gathering and reviewing existing customer process documentation
- **Typically 2-3 days, conducted free of charge**



Stay connected

Join our group



**IBM BPM (Smarter Process) ANZ**

Any questions, anytime, please post them **HERE!**



**Hand your completed  
evaluation form to an IBMer to  
receive your leather money clip**

# Agenda

Topic	Start Time	Speaker
<b>Registration/Breakfast</b>	8:30 AM	
Welcome	9:15 AM	Joe Kaczmarek
The process imperative for SAP implementations	9:25 AM	Joe Kaczmarek
What is IBM BPM for SAP?	9:45 AM	Joe Kaczmarek Richard Davies
<b>MORNING TEA</b>	10:30 AM	
A day in the life of order to cash	10:45 AM	Joe Kaczmarek Richard Davies
Value Summary and the SAP Process Opportunity Workshop	11:15 PM	Joe Kaczmarek
<b>Networking</b>	11:30 PM	
Adjourn	12:00 Noon	



# Agenda

Topic	Start Time	Speaker
<b>Registration/Breakfast</b>	8:30 AM	
Welcome	9:15 AM	Joe Kaczmarek
The process imperative for SAP implementations	9:25 AM	Joe Kaczmarek
What is IBM BPM for SAP?	9:45 AM	Joe Kaczmarek Richard Davies
<b>MORNING TEA</b>	10:30 AM	
A day in the life of order to cash	10:45 AM	Joe Kaczmarek Richard Davies
Value Summary and the SAP Process Opportunity Workshop	11:15 PM	Joe Kaczmarek
<b>Networking</b>	11:30 PM	
<b>Adjourn</b>	12:00 Noon	



Thank you!  
Jimmy

