

Aktuelles zu z/VSE, z/VM und Linux on System z

Dr. Klaus Goebel
z/VSE Systems Manager
IBM Entwicklung, Böblingen
kgoebel@de.ibm.com



Bad Reichenhall, Nov 2007

IBM Systems

Trademarks

The following are trademarks of the International Business Machines Corporation in the United States and/or other countries.

CICS*	System Storage
DB2*	System z
Enterprise Storage Server*	System z9
IBM*	TotalStorage*
IBM eServer	WebSphere*
IBM logo*	z/OS*
IMS	z/VSE
OMEGAMON*	zSeries*
Parallel Sysplex*	

* Registered trademarks of IBM Corporation

The following are trademarks or registered trademarks of other companies.

Intel is a trademark of Intel Corporation in the United States, other countries, or both.

Java and all Java-related trademarks and logos are trademarks of Sun Microsystems, Inc., in the United States and other countries

Linux is a registered trademark of Linus Torvalds in the United States, other countries, or both.

UNIX is a registered trademark of The Open Group in the United States and other countries.

Microsoft, Windows and Windows NT are registered trademarks of Microsoft Corporation.

Red Hat, the Red Hat "Shadow Man" logo, and all Red Hat-based trademarks and logos are trademarks or registered trademarks of Red Hat, Inc., in the United States and other countries.

* All other products may be trademarks or registered trademarks of their respective companies.

Notes:

Performance is in Internal Throughput Rate (ITR) ratio based on measurements and projections using standard IBM benchmarks in a controlled environment. The actual throughput that any user will experience will vary depending upon considerations such as the amount of multiprogramming in the user's job stream, the I/O configuration, the storage configuration, and the workload processed. Therefore, no assurance can be given that an individual user will achieve throughput improvements equivalent to the performance ratios stated here.

IBM hardware products are manufactured from new parts, or new and serviceable used parts. Regardless, our warranty terms apply.

All customer examples cited or described in this presentation are presented as illustrations of the manner in which some customers have used IBM products and the results they may have achieved. Actual environmental costs and performance characteristics will vary depending on individual customer configurations and conditions.

This publication was produced in the United States. IBM may not offer the products, services or features discussed in this document in other countries, and the information may be subject to change without notice. Consult your local IBM business contact for information on the product or services available in your area.

All statements regarding IBM's future direction and intent are subject to change or withdrawal without notice, and represent goals and objectives only.

Information about non-IBM products is obtained from the manufacturers of those products or their published announcements. IBM has not tested those products and cannot confirm the performance, compatibility, or any other claims related to non-IBM products. Questions on the capabilities of non-IBM products should be addressed to the suppliers of those products.

Prices subject to change without notice. Contact your IBM representative or Business Partner for the most current pricing in your geography.

Agenda

- § **New Announcements**
- § **z/VSE**
- § **z/VM and Linux on System z**
- § **Middleware and Systems Management Solutions**
- § **IBM System Storage**
- § **Summary**

Important Announcements -- You shouldn't have missed!



§ April 2006

- ▶ IBM System z9 Enterprise Class (EC) and Business Class (BC), GA May-26-2006

§ June 2006

- ▶ End-of-Service for all models of 2003, 3006, and 9672-G4, effective Dec-31-2007

§ January 2007

- ▶ **z/VSE V4.1**, GA March-16-2007
- ▶ z/VSE **Mid-Range Workload License Charge** and z/OS zNALC Software Pricing

§ February 2007

- ▶ **z/VM V5.3**, GA June-29-2007
- ▶ End-of-Service for VSE/ESA V2.7, effective Feb-28-2007

§ April 2007

- ▶ z9 BC and z9 EC enhancements
- ▶ Project '**Gameframe**': Mainframe plus Cell Broadband Engine

§ June 2007

- ▶ End-of-Marketing for all models of the z890, effective Dec-31-2007
- ▶ End-of-Marketing for z/VSE V3.1, effective May-31-2008



Announcements



§ July 2007

- ▶ TS1120 Tape Controller supports **TS3400 Tape Library** attachment for System z

§ August 2007

- ▶ Project '**Big Green**'
- ▶ End-of-Service for z/VSE V3.1, effective July-31-2009
- ▶ End-of-Service for z/VM V5.1, effective Sep-30-2007
- ▶ **IRMM Integrated Removable Media Manager**, GA Sep-14-2007
- ▶ z/OS V1.9, GA Sep-28-2007
- ▶ z/OS.e V1.8 is the last release of z/OS.e (support is planned to end in Sep 2009)

§ October 2007

- ▶ **z/VSE V4.2 Preview**
- ▶ **SCRT V14.2**, GA Oct-10-2007
- ▶ **Encryption Facility for z/VSE V1.1**, GA Nov-30-2007
- ▶ **Statement-of-Direction for CICS/VSE**
- ▶ **DS6000** and **DS8000 Turbo enhancements**, GA Dec-07-2007

§ November 2007

- ▶ **DB2 for VSE and VM V7.5**, GA Nov-30-2007
- ▶ z/VSE V4.1.1 Refresh

Agenda

§ New Announcements

→ § z/VSE

- Sub-capacity Tools
- z/VSE V4.2 Preview
- Press Reaction
- Encryption Facility for z/VSE V1.1

§ z/VM and Linux on System z

§ Middleware and Systems Management Solutions

§ IBM System Storage

§ Summary

MWLC - Introduced with z/VSE V4.1 on System z9

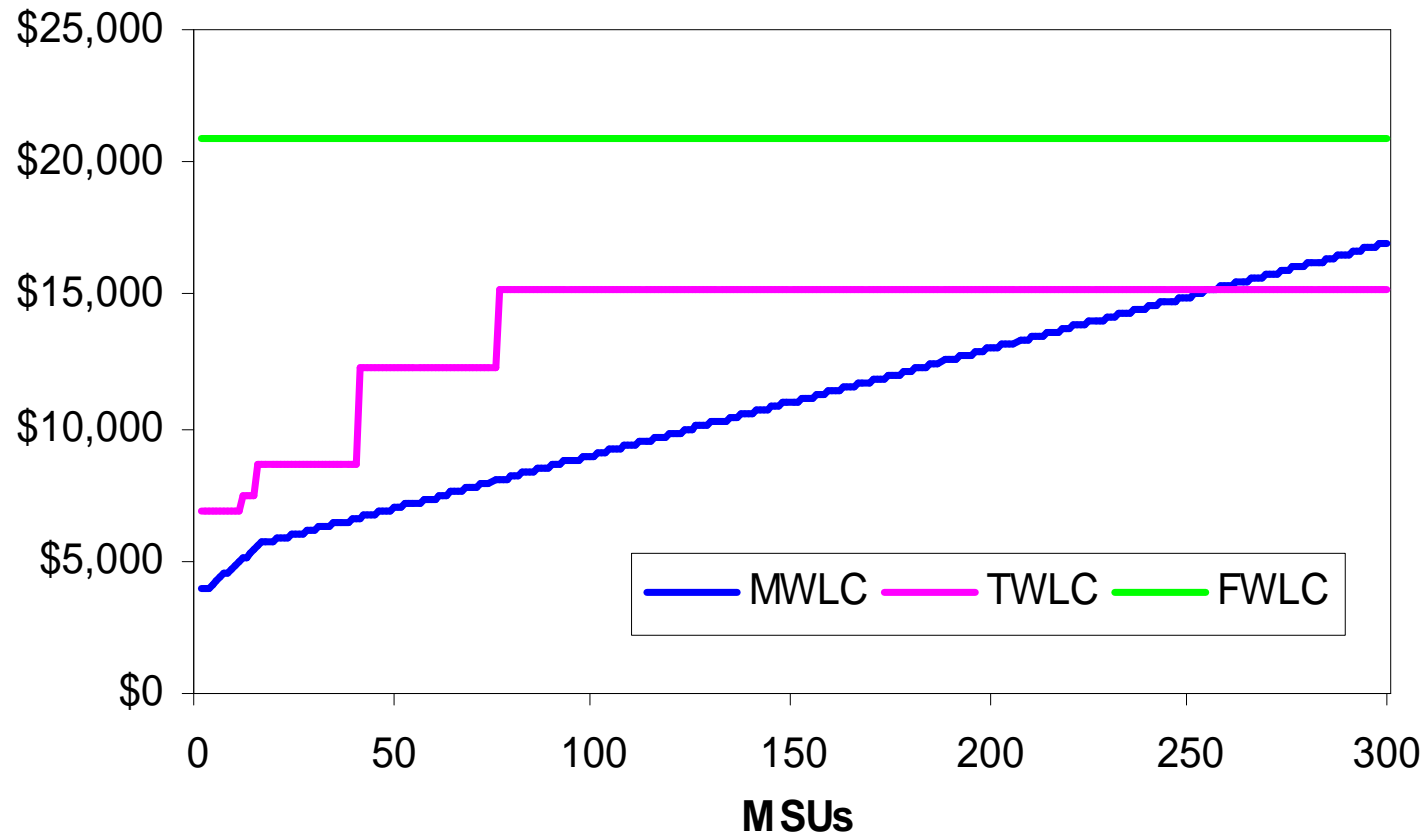

- § Customers may **choose** between MWLC/TWLC or MWLC/FWLC as appropriate to their machine.
- § Additional price/performance may be possible with **sub-capacity mode**.

*Sample software stack includes: VSE CF V8, HLASM, VTAM, DITTO, COBOL

*Prices subject to change without notice; all prices shown in USD



Press and Analyst Articles

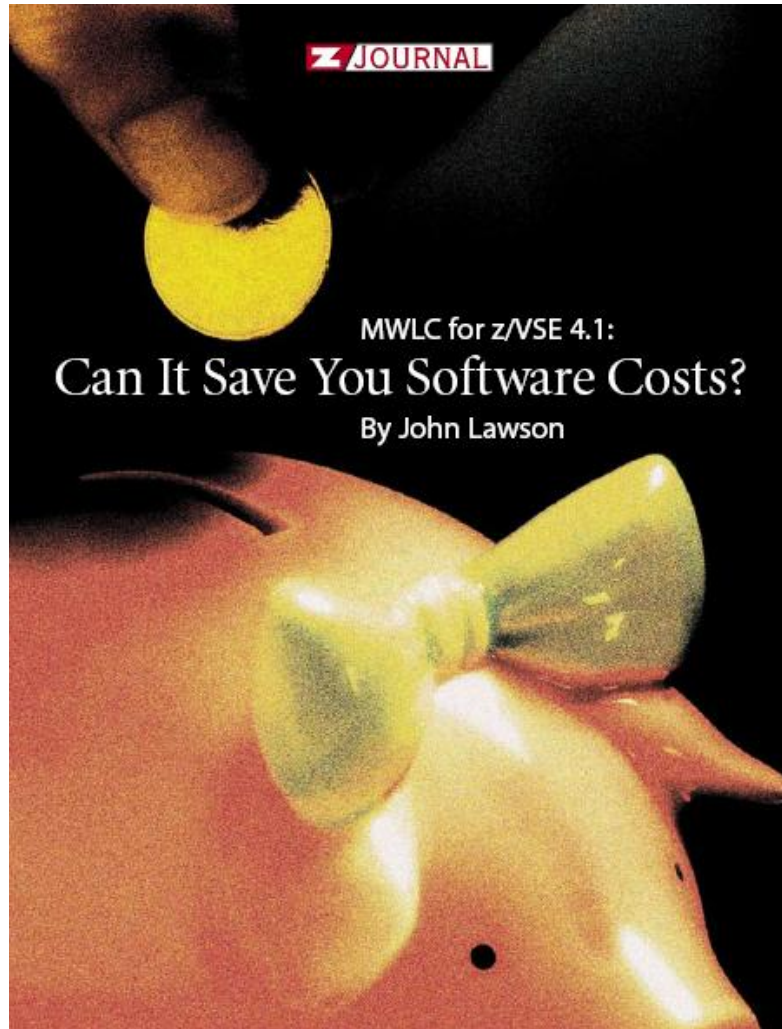

Source: z/Journal, April / May 2007

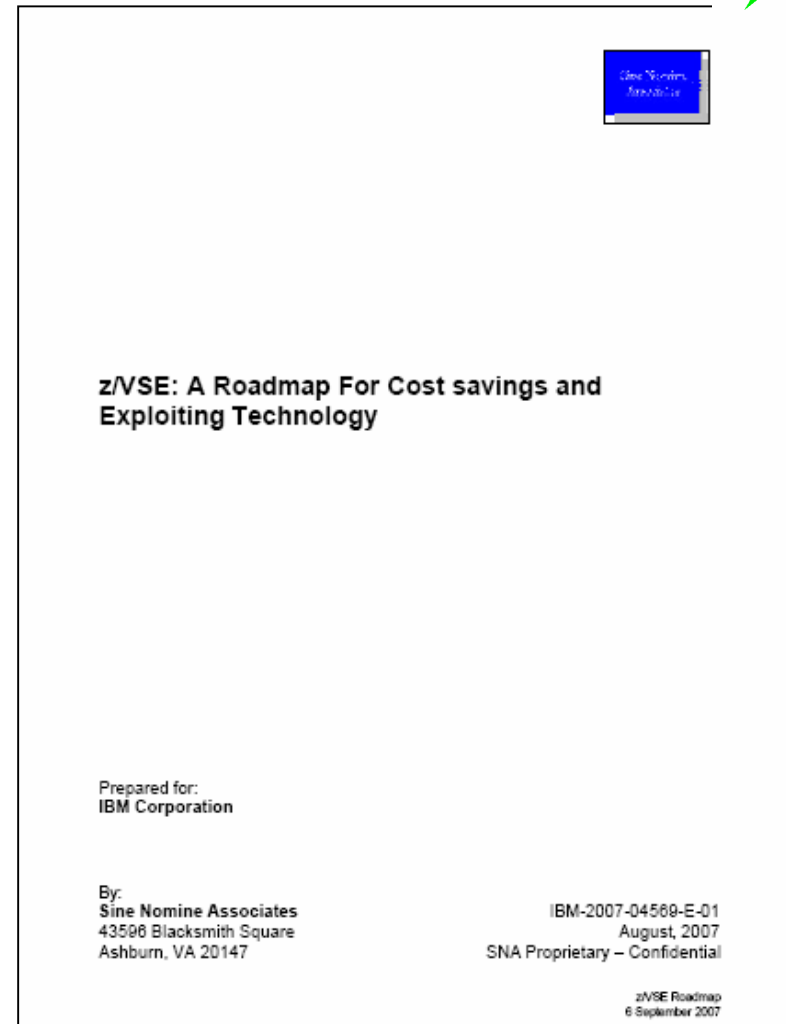

Source: Sine Nomine Associates, August 2007

z/VSE Sub-Capacity Tools

§ CMT: Capacity Measurement Tool

- ▶ Announced and available with z/VSE V4.1 since March 16, 2007
- ▶ Can be activated on z9 BC and z9 EC models only
- ▶ Requires z/Architecture mode è z/VSE V4.1 only
- ▶ Collects data for LPARs and/or guest machines running under z/VM 5.2 (or later)
- ▶ Implemented as a new z/VSE V4.1 system task
- ▶ Output from CMT is input for SCRT

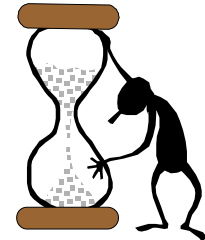

§ SCRT: Sub-Capacity Reporting Tool

- ▶ ~~Not announced and not available for z/VSE V4.1~~
- ▶ ~~Requires z/OS system to execute~~
- ▶ Analyzes SCRT89 records as produced by CMT on z/VSE V4.1
- ▶ ~~Customers must send SCRT89 records to IBM, and IBM runs SCRT on z/OS~~
- ▶ Output from SCRT is a report, similar to a spreadsheet report
- ▶ Customers must send that report to the IBM billing department via Web interface



§ SCRT: Sub-Capacity Reporting Tool

- ▶ Now announced for z/VSE V4.1
- ▶ Available as SCRT V14.2 since October 10, 2007
- ▶ Planned to be integrated into z/VSE V4.2 (when available)



z/VSE V4.1 Overview

z/VSE V4.2 Preview

§ Preview 4/27/2006, Announce 1/9/2007, **General Availability 3/16/2007**

§ z/Architecture mode only

- ▶ 64-bit real addressing (31-bit *virtual* addressing)
 - up to 8 GB real processor storage
- ▶ IBM System z9 EC and z9 BC servers
- ▶ IBM eServer zSeries 990, 890, 900, 800 servers

§ Capacity Measurement Tool (CMT)

- ▶ Fulfills SoD from July 2005

§ New MWLC pricing metrics (System z9 only)

- ▶ Attractive full-capacity MWLC price points
- ▶ Sub-capacity MWLC option for added price/performance

§ Encryption enhancements

- ▶ CPACF enhancements (AES-128)
- ▶ Configurable Crypto Express2 (add accelerator option)
- ▶ TS1120 encrypting tape
- ▶ SecureFTP

§ SOA and interoperability improvements

§ CICS TS & CICS/VSE supported w/ z/VSE V4.1

§ FSU from z/VSE V3.1 and VSE/ESA V2.7

§ Implemented 22 customer requirements

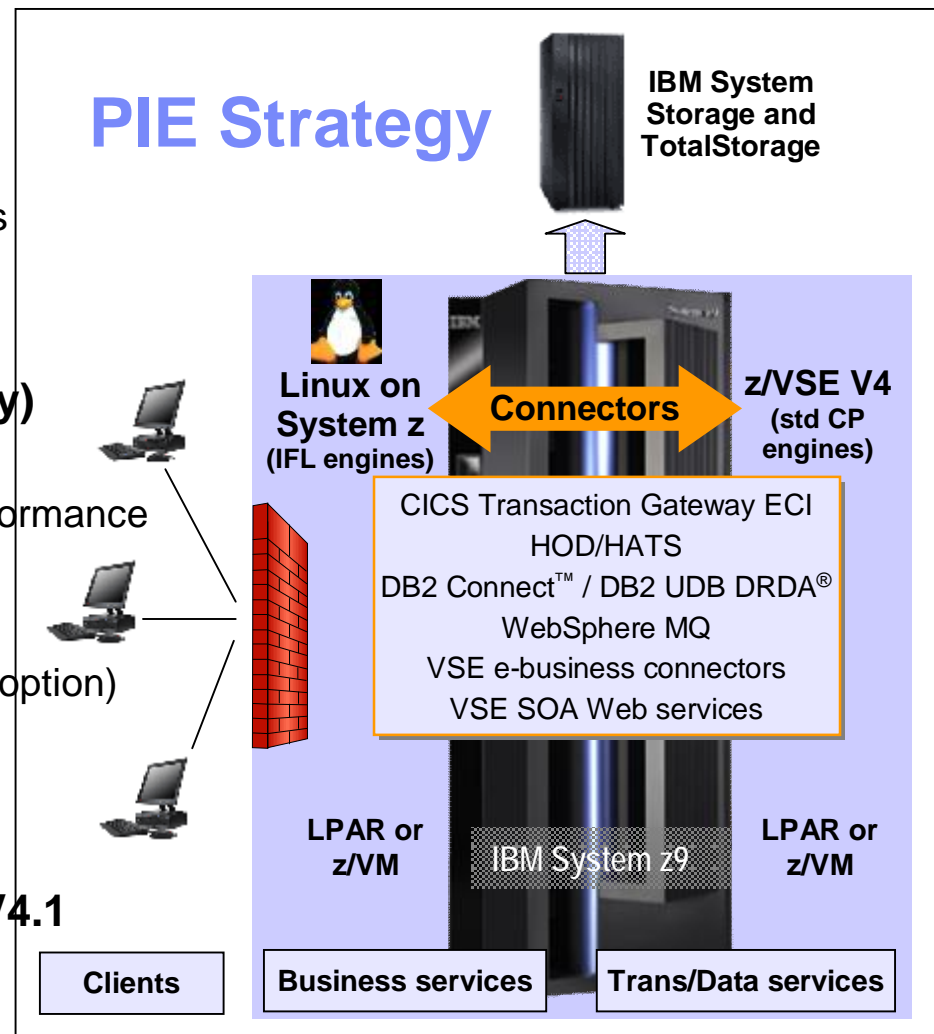



z/VSE V4.2 – What's changed, what's new ?

§ **Preview Oct 9, 2007**; planned availability 4Q2008

§ **z/Architecture mode only**

- ▶ 64-bit *real* addressing (31-bit *virtual* addressing)
 - up to 32 GB real processor storage
- ▶ IBM System z9 EC and z9 BC servers
- ▶ IBM eServer zSeries 990, 890, 900, 800 servers

§ **More than 255 VSE tasks**

- ▶ Enable growth, ease migration to CICS TS

§ **Sub-Capacity Reporting Tool (SCRT)**

- ▶ Available now with z/VSE 4.1 (and later)

§ **Encryption Facility for z/VSE V1.1**

- ▶ Optional priced feature on z/VSE V4.1 (and later)
- ▶ MWLC enabled

§ **Added support for System Storage**

- ▶ TS3400 Tape Library
- ▶ TS7740 Virtualization Engine

§ **CICS TS & CICS/VSE supported w/ z/VSE V4.2**

- ▶ Statement of Direction (SoD) for CICS/VSE

§ **FSU from z/VSE V3.1 and z/VSE V4.1**

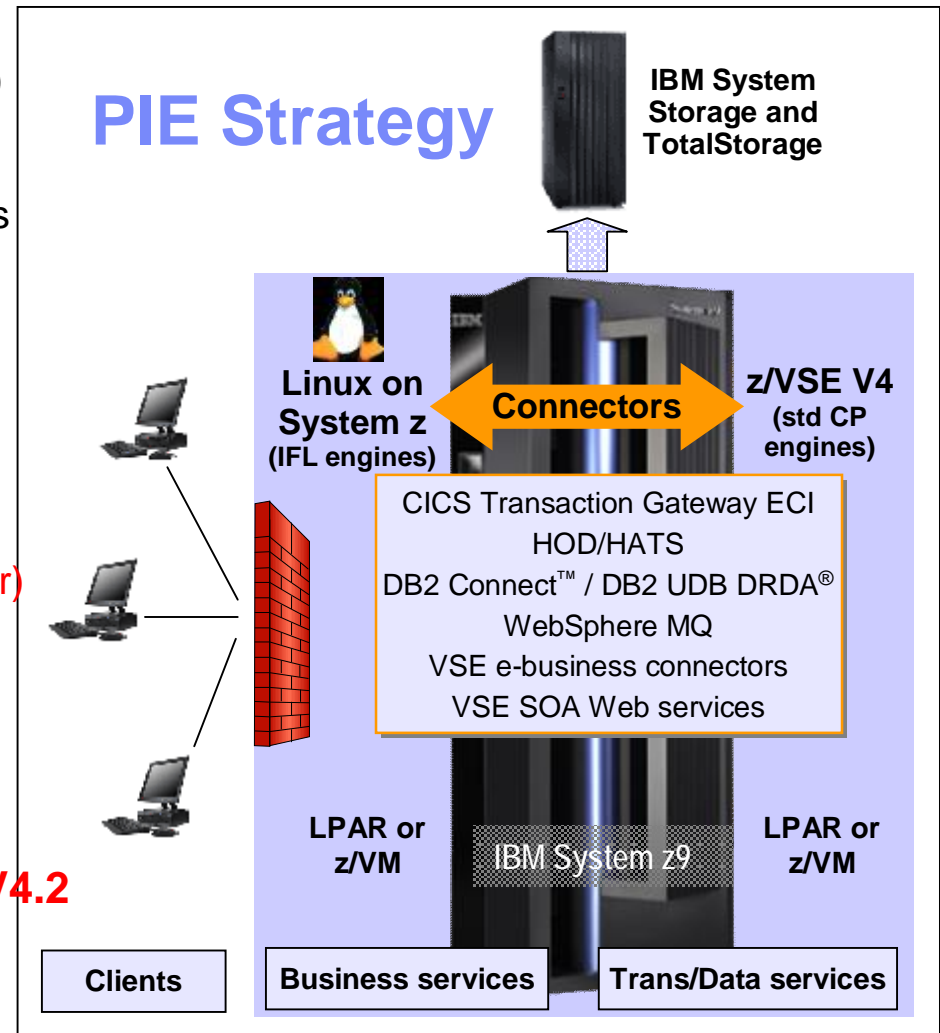

z/VSE Roadmap

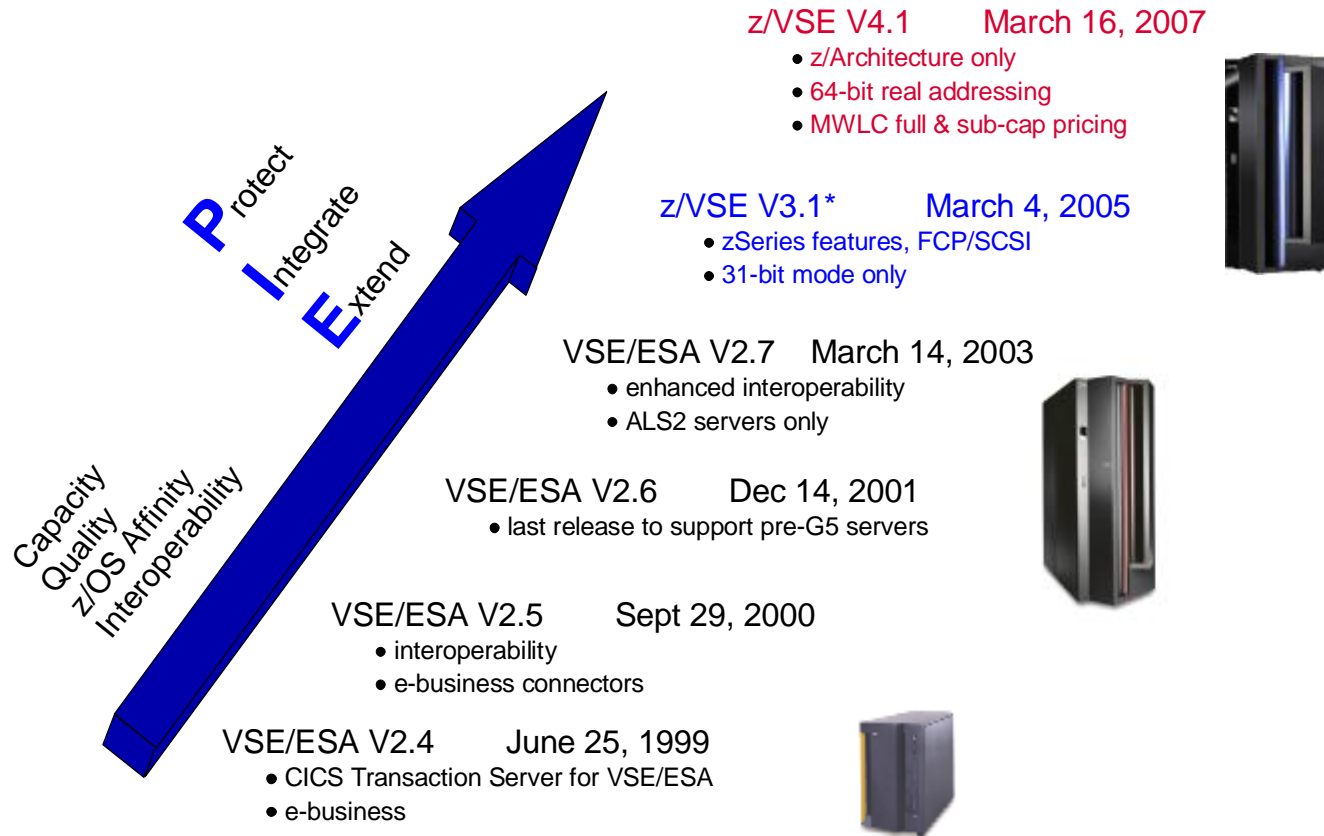

•Note: z/VSE V3 can operate in 31-bit mode only. It does not implement z/Architecture and specifically does not implement 64-bit mode capabilities. z/VSE V3 is designed to support selected features of IBM System z hardware.



z/VSE Roadmap

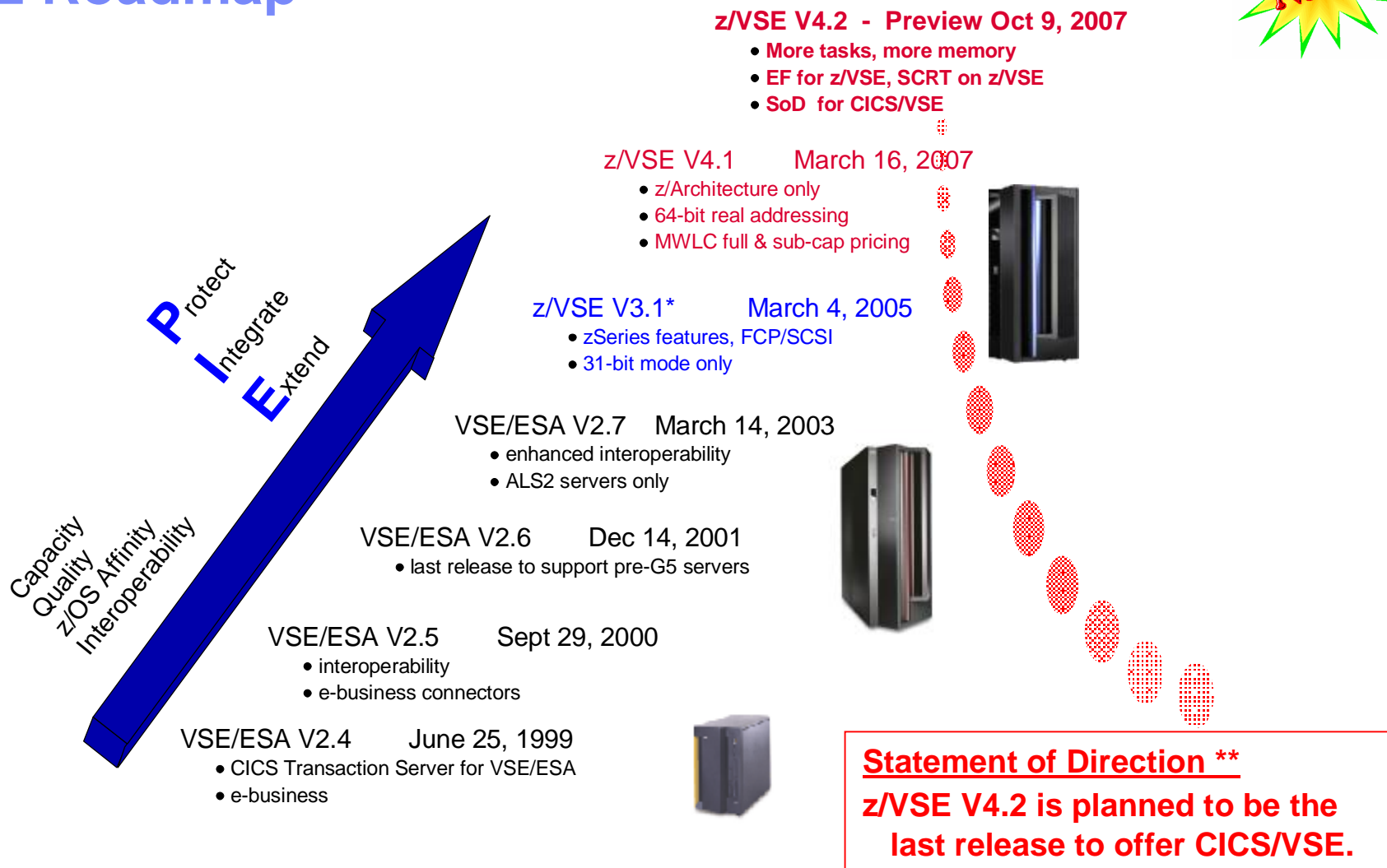

•Note: z/VSE V3 can operate in 31-bit mode only. It does not implement z/Architecture and specifically does not implement 64-bit mode capabilities. z/VSE V3 is designed to support selected features of IBM System z hardware.

**** All statements regarding IBM's plans, directions, and intent are subject to change or withdrawal without notice.**

Press on z/VSE V4.1

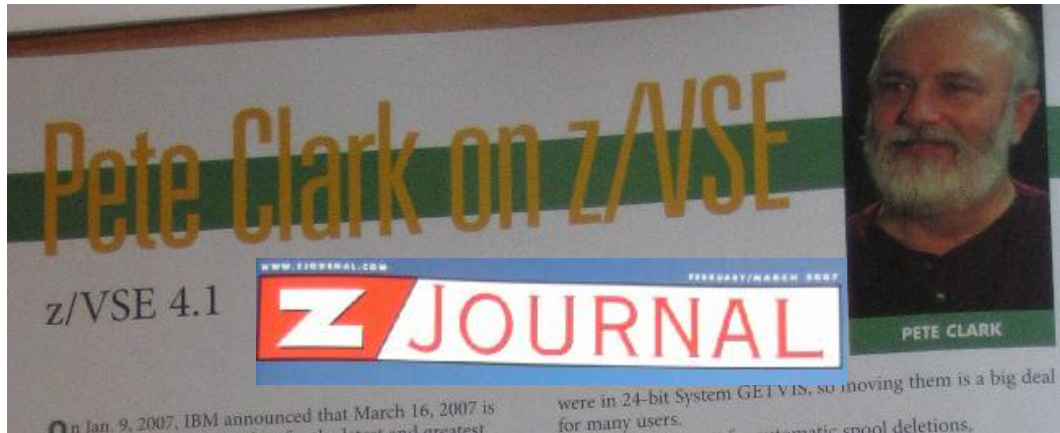

VSE users receive an offer they can't refuse

Most of the activity in the IBM mainframe world not surprisingly focuses on the z/OS environment, but there is still a sizeable population of users running systems based on VSE, often in conjunction with the VM hypervisor.

Many of these sites are slow growers with limited in-house technical skills and a reluctance to upgrade their hardware or software even in exchange for significant cost savings. As a result their relationship with IBM (and with other ISVs supporting their applications) is a difficult one.

In its recent announcement of z/VSE 4.1, IBM has shown some of the 'carrot and stick' tactics that often characterize its product developments in this part of the market.

The latest version of the operating system offers many attractions for small mainframe users, including some important enhancements to SOA/web service support and tape encryption. Moreover the software is accompanied by a new pricing scheme (Midrange Workload License Charge), which can bring sub-capacity benefits and very significant savings to VSE users. But to get the savings they need to upgrade to a z9 BC or EC.

Even for VSE users, it is becoming increasingly difficult to make a cost case for avoiding an upgrade to the latest hardware, and the months ahead are likely to witness a steady stream of VSE-base upgrades to the z9 BC.

IBM VSE mainframe operating system gets upgrade

By Mark Fontecchio, News Writer
21 Mar 2007 | SearchDataCenter.com

RSS FEEDS: [IT infrastructure news](#)



IBM has upgraded the VSE mainframe operating system to include storage, security and networking improvements, as well as introduced pricing schemes that can lower mainframe software licensing costs.

Source: SearchDataCenter.com, March 2007

IBM Systems MAGAZINE

Features

Print

Ahead of the Pack

July 2007

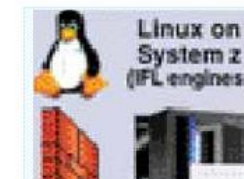

Figure 1

Although z/OS* is correctly regarded as the flagship OS for the IBM* System z** platform, z/VSE* remains an important part of IBM's mainframe portfolio and a viable option for many satisfied IBM customers. At the risk of oversimplification, z/VSE is similar to z/OS but relatively smaller, simpler and less capable. z/VSE is designed for smaller IBM mainframe clients with somewhat less demanding requirements. For z/VSE users, many of whom have been using it for decades, z/VSE is robust enough without additional applications found in z/OS, and comes

with a lower TCO than z/OS. However, both z/OS and z/VSE are equally committed to product quality and customer service that are second to none.

Heritage

z/VSE V4 has a long tradition that spans more than four decades. DOS/360 was launched in 1965 along with the famed IBM System/360*. Originating as a basic alternative to OS/360*, a distant ancestor of z/OS, DOS/360 quickly became a workhorse OS, especially for the popular S/360 Model 30. In the 1970s and '80s,

Source: Systems Magazine, July/August 2007

Press on z/VSE V4.2



- HOME
- NEWS
- MARKETS
- MY PORTFOLIO
- TECHNOLOGY
- JOBS
- PERSONAL FINANCE
- LUXU

<http://money.cnn.com/news/newsfeeds/articles/marketwire/0317343.htm>

IBM Continues the Evolution of Its z/VSE Mainframe Operating System

October 19, 2007: 08:01 AM EST



IBM (NYSE: IBM) today announced that the z/VSE mainframe operating system is being updated to help address customer needs for scalability, security and integration. z/VSE V4.2 is designed to support growing mainframe applications and drive stronger investment protection.

"Many customers are beginning to put new Linux applications on the same IBM System z9 mainframe that also runs their production z/VSE applications. This integrated approach is designed to offer the best of Linux, the robust data serving capabilities of z/VSE, and the potential for low total cost of ownership of the System z9 mainframe," said Dr. Klaus Goebel, Development Executive Project Manager and z/VSE PDT Leader. "IBM's powerful mainframe virtualization system, z/VM, is fundamental to these integrated environments. It helps customers get the most from their Linux and z/VSE applications, integrate their business, and support business growth."

Previewed at a special international meeting of the GUIDE SHARE EUROPE (GSE) mainframe user group earlier this week, z/VSE enhancements include a range of new features, especially important to modern applications, such as on-line commerce. Capabilities include:

-- More z/VSE tasks and more real storage designed to improve scalability

IBM: http://www-05.ibm.com/de/pressroom/presseinfos/2007/10/19_1.html

The Wall Street Journal: <http://tools.thestreet.com/tsc/quotes.html?pg=qcn&guid={390AD43F-424F-47D6-9BE2-B7E4AD03823F}&sybm=ibm&sid=2595&orig=1&timer>

The New York Times: <http://marketwatch.nytimes.com/custom/nyt-com/html-story.asp?guid={390AD43F-424F-47D6-9BE2-B7E4AD03823F}&sybm=ibm&sid=2595&siteid=NYT&dist=NYT&osymb=ibm>

and many more, e.g. pressebox.de, verivox.de, boerse-go.de, news.moneycentral.msn.com, yahoo.com, marketwatch.com, businessweek.com, smartmoney.com, ...



Arkeia Software präsentiert seine ...



Sie sind Gast
Einloggen | Registrieren

news 19.10.2007 16:37

Suche ..

IBM verspricht Weiterentwicklung von z/VSE

Immer mehr Anwender der IBM-Mainframes setzen nicht nur Linux ein, sondern lassen ihre Linux-Anwendungen in einer virtuellen Maschine auf dem Großrechner laufen. Diesen Trend zur Konsolidierung sieht jedenfalls Dr. Klaus Gobel, Leiter des z/VSE-Produktentwicklungsteams. Darum soll die für das vierte Quartal 2008 erwartete nächste Version des Betriebssystems mehr parallele VSE-Tasks und mehr Hauptspeicher unterstützen. Zudem will man Linux-Anwendungen besseren Zugriff auf z/VSE-Daten ermöglichen, etwa auf die des Datenbanksystems DB2 UDB.

<http://www.heise.de/newsticker/meldung/97662>



PREMIUM-Login

CW-Traveller | Aboshop | Kontakte | Mediadaten | ID

E-Mail-Adresse
.....
Passwort vergessen?
ANMELDEN

Sie sind hier: > Startseite > Nachrichten

NACHRICHTEN

Totgesagte leben länger: IBM entwickelt VSE weiter
19.10.2007 um 15:50 Uhr

Der Investitionsschutz lebe hoch: IBM hat angekündigt, das "Legacy"-Großrechnerbetriebssystem z/VSE weiterzuentwickeln.

Die neue Version z/VSE 4.2 ist einer IBM-Pressmitteilung allerdings erst in rund einem Jahr (Q4/2008) generell verfügbar. Sie soll dann mehr Tasks und realen Storage unterstützen, eine Verschlüsselungseinrichtung (Encryption Facility) beinhalten und last, but not least Integration mit Linux auf System z bieten. Damit sollen Kunden z/VSE-Produktionsdaten in neuen Linux-Anwendungen - etwa Data Warehouses mit DB2 UDB - übernehmen können. Vorgestellt wurden die Verbesserungen in dieser Woche auf einer internationalen Tagung der Mainframe-Usergroup [Guide Share Europe](#) (GSE). (tc)

<http://www.computerwoche.de/nachrichten/582317/>



Encryption Facility for z/VSE V1.1

§ **Announce:** Oct-09-2007

§ **GA:** Nov-30-2007

§ **Optional priced feature for VSE Central Functions V8**

- ▶ requires z/VSE V4.1 or later
- ▶ MWLC-eligible

§ **Requires CP Assist for Cryptographic Function (CPACF)**

- ▶ no charge feature
- ▶ only on z990, z890, z9 EC, and z9 BC servers

§ **Extends affinity between z/VSE and z/OS**

- ▶ function roughly equivalent to EF for z/OS V1.1
- ▶ compatible with EF for z/OS V1.1 (Encryption Facility System z format)
 - EF for z/VSE tapes can be read by EF for z/VSE, EF for z/OS, EF for z/OS Java Client, and Decryption Client for z/OS
 - EF for z/OS V1.1 and EF for z/OS Java client tapes can be read by EF for z/VSE V1.1

§ **Complements z/VSE support for IBM TS1120 tape**

- ▶ TS1120 preferred solution for high volume backup/archive
- ▶ EF option for limited backup/archive and/or exchange with partners with no TS1120





EF for z/VSE V1.1

IBM Encryption Facility for z/VSE V1.1
 Program number: 5686-CF8-40
 Runs on: System z9 EC, z9 BC
 zSeries 890 or 990
 Requires: z/VSE 4.1 (with DY46717) or higher

IBM Encryption Facility for z/OS V1.1
 Program number: 5655-P97
 Runs on: System z9 EC, z9 BC
 zSeries 900 or 990
 zSeries 800 or 890
 Requires: z/OS 1.4 or higher; z/OS.e 1.4 or higher

Optional Priced **z/VSE** Feature*

- § Supports encrypting, decrypting, and **compression** of data at rest (tapes, disk).
- § Supports either Public Key/Private keys or passwords to create highly-secure exchange between partners.
- § **Can** use z/OS Java Client or Decryption Client for z/OS for data exchange with client systems or decryption on z/OS.
- § Use zvse@de.ibm.com mailbox for questions about z/OS Java Client and Decryption Client for z/OS when used in conjunction with z/VSE.

Java Client
Web Downloadable

Java technology-based code that allows client systems (z/OS and non-z/OS) to decrypt and encrypt data for exchange with z/OS **and z/VSE** systems.

Decryption Client for z/OS
Web Downloadable

Decryption only code designed to run on z/OS systems. Can process data encrypted and compressed or just encrypted by the Encryption Facility for z/OS **or Encryption Facility for z/VSE**.

Feature: Encryption Services

- Optional Priced Feature*
- § Supports encrypting and decrypting of data at rest (tapes, disk)
 - § Supports either Public Key/Private keys or passwords to create highly-secure exchange between partners

Feature: DFSMSdss Encryption

Optional Priced Feature*

•Variable Workload License Charges (VWLC, **MWLC**), Entry Workload License Charges (EWLC), zSeries Entry License Charges™ (zELC), Parallel Sysplex® License Charges (PSLC) **Statements regarding IBM's future direction and intent are subject to change or withdrawal without notice, and represent goals and objectives only.

Agenda

§ **New Announcements**

§ **z/VSE**

 § **z/VM and Linux on System z**

- Consolidation Effect
- Project 'Gameframe'
- Project 'Big Green'

§ **Middleware and Systems Management Solutions**

§ **IBM System Storage**

§ **Summary**

Impact of Virtualization

% Growth x86 Shipments

4Q Rolling x86 Customer Spending (\$M)

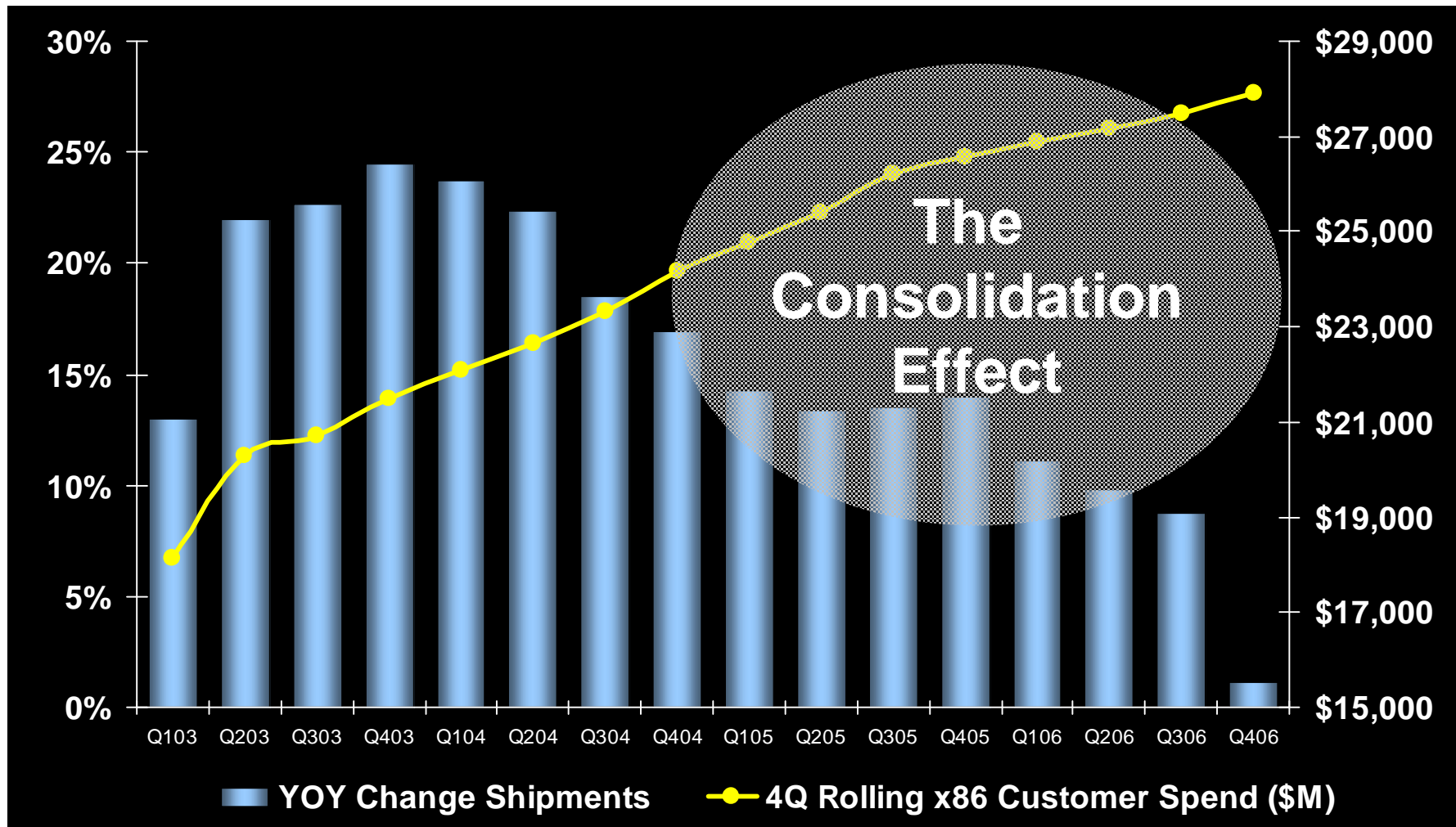

Source: IDC, "Virtualization and Multicore Innovations Disrupt the Worldwide Server Market," March 2007

z/VM V5.3 – Business Value Proposition

§ Large, single-image, resource-balanced “Scale out” and “Scale up” support for hosting virtual server workloads

- ▶ Large real *memory* exploitation support (up to 256 GB)
- ▶ Single-image *CPU* support for 32 processors
- ▶ Enhanced *networking* bandwidth and availability support with OSA-Express2 Link Aggregation (Statement of Direction)
- ▶ *HyperPAV I/O* support for IBM System Storage DS8000
- ▶ Concurrent *FlashCopy I/O* support for one-to-many volumes
- ▶ Enhanced *memory management* for Linux guests running on System z9 servers

§ Specialty processor support for z/OS guests

- ▶ Enhanced z/OS-on-z/VM development / test support

§ LDAP support for guest authentication

- ▶ Enhanced virtual server security infrastructure support

§ Staff productivity gains with IBM Director for Linux on System z

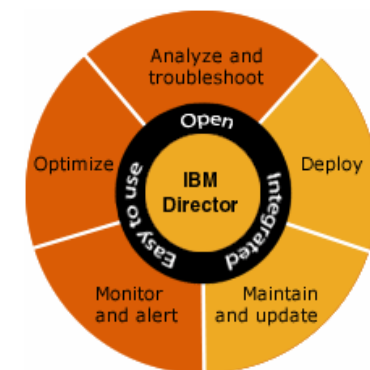
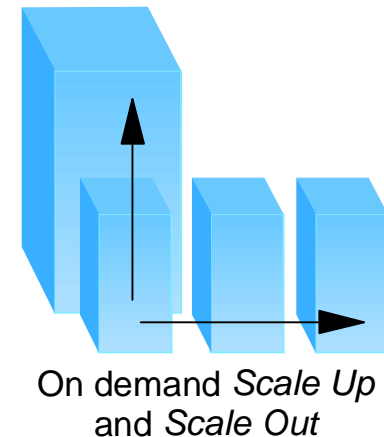

Consolidation and Virtualization Case Studies

Case Study: Nationwide Uses Linux and High-Power Virtualization for Web Presence

Gartner DAS Core Research Note G00145213, John R. Phelps, Mike Chuba, 29 June 2007

Nationwide Insurance significantly reduced expenditures by consolidating nonmainframe server workloads using Linux-only System z mainframes, while improving quality of service and providing for growth that has minimal impact on floor space, power and cooling. Its approach will interest any organization that houses a combination of Windows (where its applications have Linux equivalents), Linux, Unix and IBM mainframe operating environments and that is looking at new and innovative ways to consolidate its server environment.

Key Findings

- Mainframe running Linux can be used to consolidate some workloads that run on x86 servers, deliver substantial operational savings and avoid/defer potentially costly data center expansions.
- The large number of Linux virtual servers that Nationwide needed made the total cost of ownership (TCO) benefits easier to prove. Those implementing the solution with a small number of potential virtual servers (one to 25) will need closer evaluation.
- In-house skills that can be leveraged should be considered as part of any virtualization/consolidation strategy.
- Nationwide achieved very significant results. Although not all situations lend themselves so readily to the Nationwide approach, there are a growing number of opportunities in which this approach might yield significant benefits and should at least be considered.

Recommendations

- Use cross-disciplinary teams that are dedicated to the project to gain broad commitment.
- Be prepared to change your billing models as you move from individual dedicated servers to a virtualized shared-resource model.
- Do not implement virtualization as a "knee jerk" reaction to the issue of underutilized servers, but rather introduce it as part of a process that incorporates meeting performance, availability and security objectives while also allowing for possible volatility in usage.

WHAT YOU NEED TO KNOW

Nationwide was able to significantly reduce expenditure by consolidating nonmainframe server workloads using Linux-only System z mainframes. The nature of the consolidation solution also has improved quality of service and provided for growth within the same footprint of the two installed mainframes. The growth will have minimal impact on floor space, power and cooling in the data center.

Gartner.

Source:

<http://mediaproducts.gartner.com/gc/reprints/ibm/external/volume2/article13/pdf/article13.pdf>

IBM Case Study

Nexxar Group transfers to IBM System z9 Business Class for cost savings



Key Benefits

- Significant reduction in physical complexity of infrastructure for improved security and greater ease of management; fewer processors means reduction in software licensing fees, while virtualization improves utilization of resources; overall 30 percent reduction in operational costs; faster time-to-market for new customer solutions; greater ease and speed of integrating new corporate acquisitions

Overview

Challenge

Enable very high availability to support business growth; develop an IT Service Management solution to enable integration, automation and optimization of IT resources; provide high security for customer-specific data and applications; enable rapid, low-cost provisioning of new servers

Solution

Worked with IBM Global Technology Services to consolidate more than 80 physical servers to virtual servers running under Linux® on an IBM System z9™ Business Class mainframe; implemented IBM Service Management methodologies to enable easy management of complex environment

Founded in 2003, Nexxar Group, Inc. is a money transfer company that also offers bill payment, check cashing and money order services. Headquartered in the US, Nexxar Group has a network of agents and branches in more than 40,000 locations across 105 countries. The company provides money transfer services under several of its own brands and also as a white-label offering to other financial services providers.

Nexxar has grown rapidly through corporate acquisitions, and plans to continue growing in this way. To enable acquisitions to be swiftly integrated into its business, and to support the

Source: [http://www-](http://www-306.ibm.com/software/success/cssdb.nsf/CS/STRD-6VHGK2?OpenDocument&Site=swzseries&cty=en_us)

[306.ibm.com/software/success/cssdb.nsf/CS/STRD-6VHGK2?OpenDocument&Site=swzseries&cty=en_us](http://www-306.ibm.com/software/success/cssdb.nsf/CS/STRD-6VHGK2?OpenDocument&Site=swzseries&cty=en_us)

Project 'Gameframe'



"Taikodom": Massive Multiuser Online Game (MMOG)

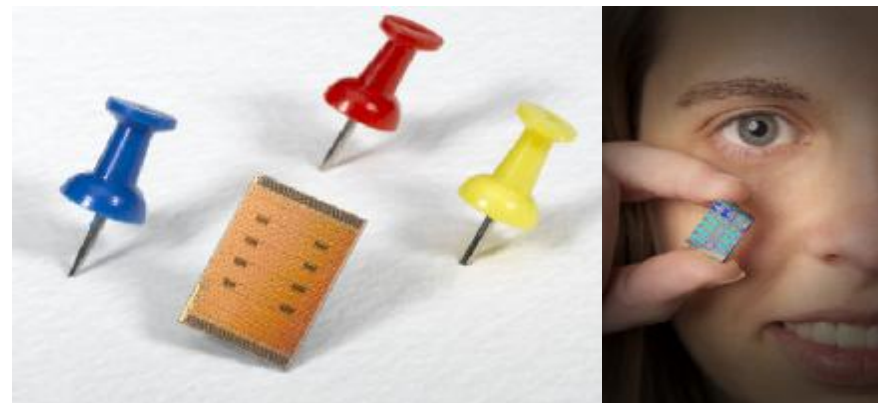

April 26, 2007:
IBM and Hoplon Infotainment announced a joint project to integrate Cell/B.E. as a front-end processor for IBM System z.

Cell Broadband Engine (Cell/B.E.) is a trademark of Sony Computer Entertainment Inc.



New Customers, New Markets, New Wins

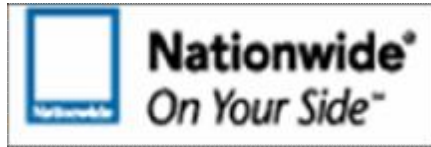



IBM Consolidation Announcement Highlights

- § **IBM will consolidate thousands of servers onto approximately 30 System z mainframes**
- § **We expect substantial savings in multiple dimensions: energy, software and system support costs**
- § **Major proof point of IBM's 'Project Big Green' initiative**
- § **The consolidated environment will use 80% less energy**
- § **This transformation is enabled by the System z's sophisticated virtualization capability**



IBM'S PROJECT BIG GREEN SPURS GLOBAL SHIFT TO LINUX ON MAINFRAME



Plan to shrink 3,900 computer servers to about 30 mainframes targets 80 percent energy reduction over five years

Optimized environment to increase business flexibility

ARMONK, NY, August 1, 2007 – In one of the most significant transformations of its worldwide data centers in a generation, IBM (NYSE: IBM) today announced that it will consolidate about 3,900 computer servers onto about 30 System z mainframes running the Linux operating system. The company anticipates that the new server environment will consume approximately 80 percent less energy than the current set up and expects significant savings over five years in energy, software and system support costs.

At the same time, the transformation will make IBM's IT infrastructure more flexible to evolving business needs. The initiative is part of Project Big Green, a broad commitment that IBM announced in May to sharply reduce data center energy consumption for IBM and its clients.



IBM consolidates its own Data Centers for large Savings

Your IT Cost may vary:

- § **92% less hardware**
 - ▶ 23,000 processor cores going to 1,782 IFLs
 - ▶ +80% energy reduction
 - ▶ +85% space reduction
- § **180% greater utilization**
 - ▶ 30% average utilization going to over 85%
- § **Reduced people cost through virtualization**
 - ▶ Freeing up resources for growth opportunities
- § **Potential for dramatic reductions in software expense for processor based licenses**
 - Elimination of 23,000 SW licenses and related on-going S&S costs
- § **Significant reductions in power and cooling costs are possible**
 - ▶ Less Stress on Data Center Infrastructure
- § **Significant reductions in IT Data Center square footage are likely**
 - ▶ Enables growth and better utilization of facilities

Workload consolidation using Linux on a mainframe may result in over 40% IT Cost savings.

IBM Global Account (IGA) IT Costs
 Varied Distributed Workloads
 5-Year IT Cost Study Results

Potential 5-Year IT Cost Savings

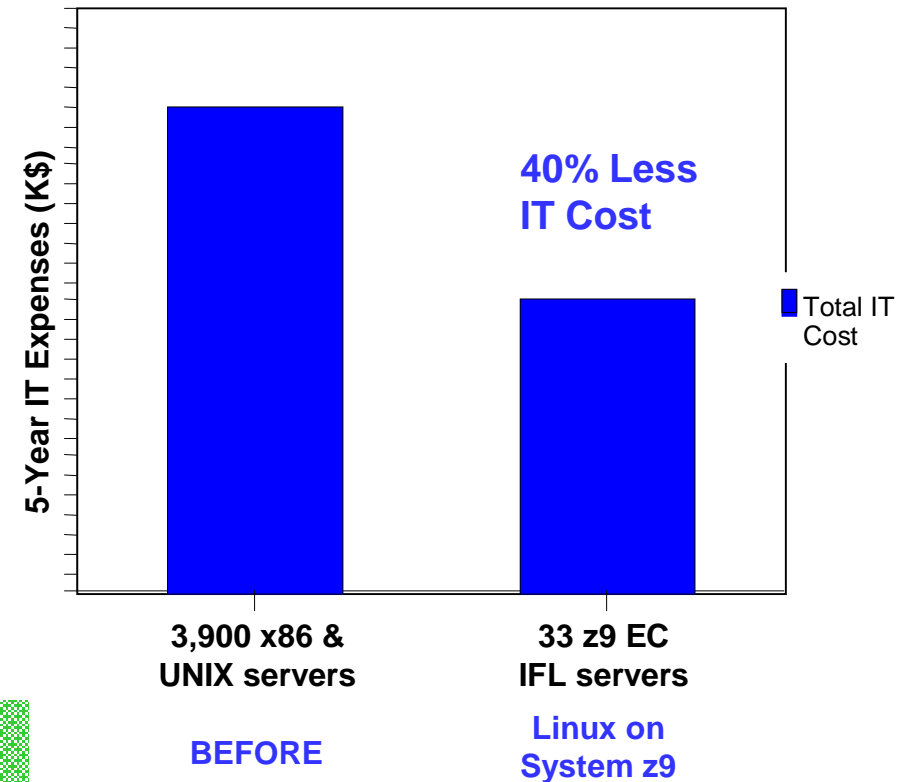

Project 'Big Green'

§ IBM to reallocate \$1 billion each year:

- To accelerate “green” technologies and services
- To offer a roadmap for clients to address the IT energy crisis while leveraging IBM hardware, software, services, research, and financing teams
- To create a global “green” team of almost 1,000 energy efficiency specialists from across IBM

§ Re-affirming a long standing commitment at IBM:

- Energy conservation efforts from 1990 – 2005 have resulted in a 40% reduction in CO₂ emissions and a quarter billion dollars of energy savings
- Annually invest \$100M in infrastructure to support remanufacturing and recycling best practices
- *Will double compute capacity by 2010 without increasing power consumption or carbon footprint saving 5 billion kilowatt hours per year ... equals energy consumed by Paris – “the City of Lights”.*

§ What “green” solutions can mean for clients:

- For the typical 25,000 square foot data center that spends \$2.6 million in power annually, energy costs could be cut in half
- Equals the reduction of emissions from taking 1,300 automobiles off of the road

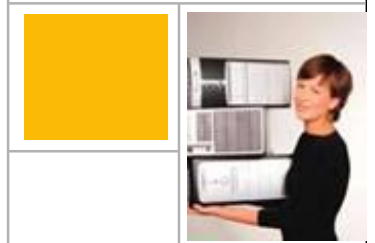

Agenda

§ **New Announcements**

§ **z/VSE**

§ **z/VM and Linux on System z**

 § **Middleware and Systems Management Solutions**

- DB2 for VSE and VM V7.next
- IRMM

§ **IBM System Storage**

§ **Summary**

DB2 V7.5 – announced Nov-13-2007, GA Nov-30-2007

§ In the past, DB2 VSE client functionality could be obtained via PRPQ P10154

§ Now, DB2 offers a runtime only client edition for z/VSE and z/VM (no PRPQ required)

§ Plus performance enhancements, e.g.

- ▶ bind file support
- ▶ reduced DRDA code path length
- ▶ and many more ...

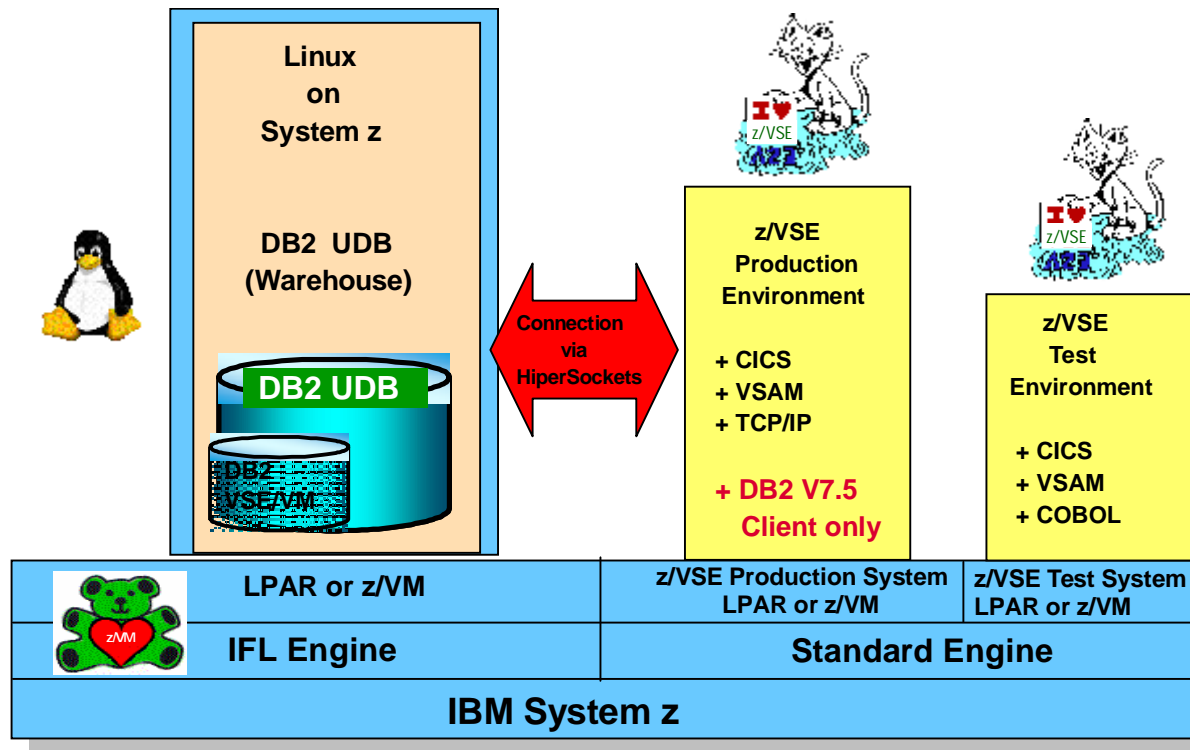

IRMM – announced Aug-7-2007, GA Sep-14-2007



§ Integrated Removable Media Manager is:

- ▶ A new robust systems management product for Linux® on IBM System z™ that manages open system media in heterogeneous distributed environments and virtualizes physical tape libraries, thus combining the capacity of multiple heterogeneous libraries into a single reservoir of tape storage that can be managed from a central point

§ IRMM is designed to provide:

- ▶ Centralized media and device management
- ▶ Dynamic resource sharing

§ IRMM extends IBM's virtualization strategy to tape library resources

- ▶ Drives and cartridge pools

§ IRMM complements Linux on System z consolidation efforts

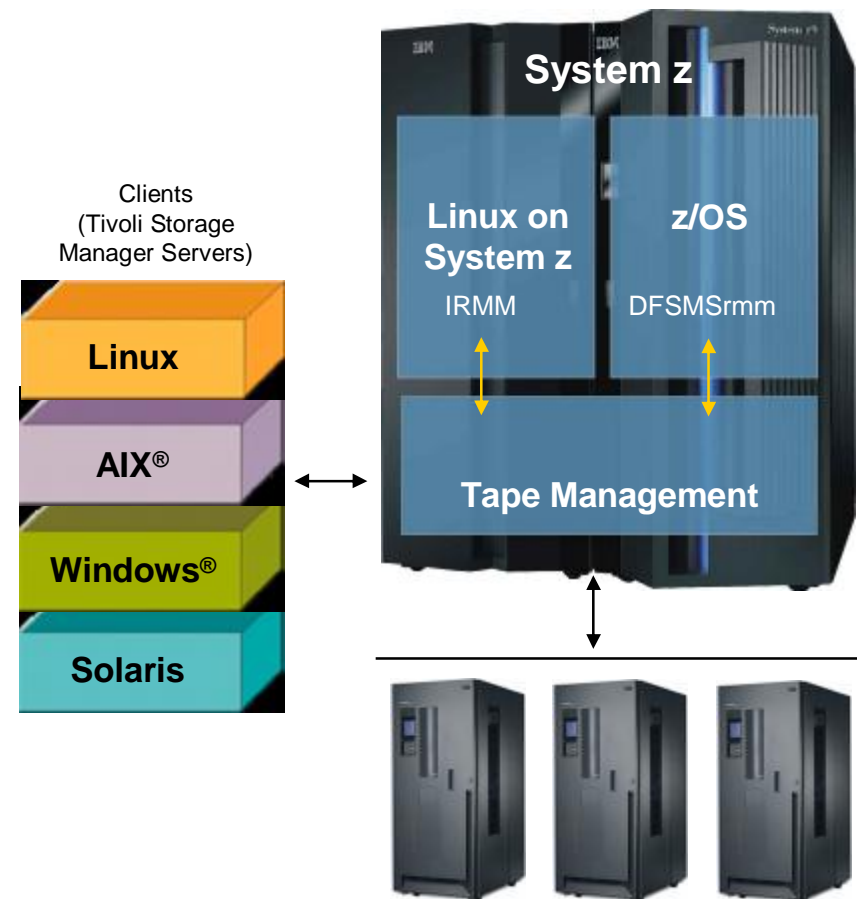

TSM in a VM/VSE and Linux Environment

Integration with z/VSE V4.1

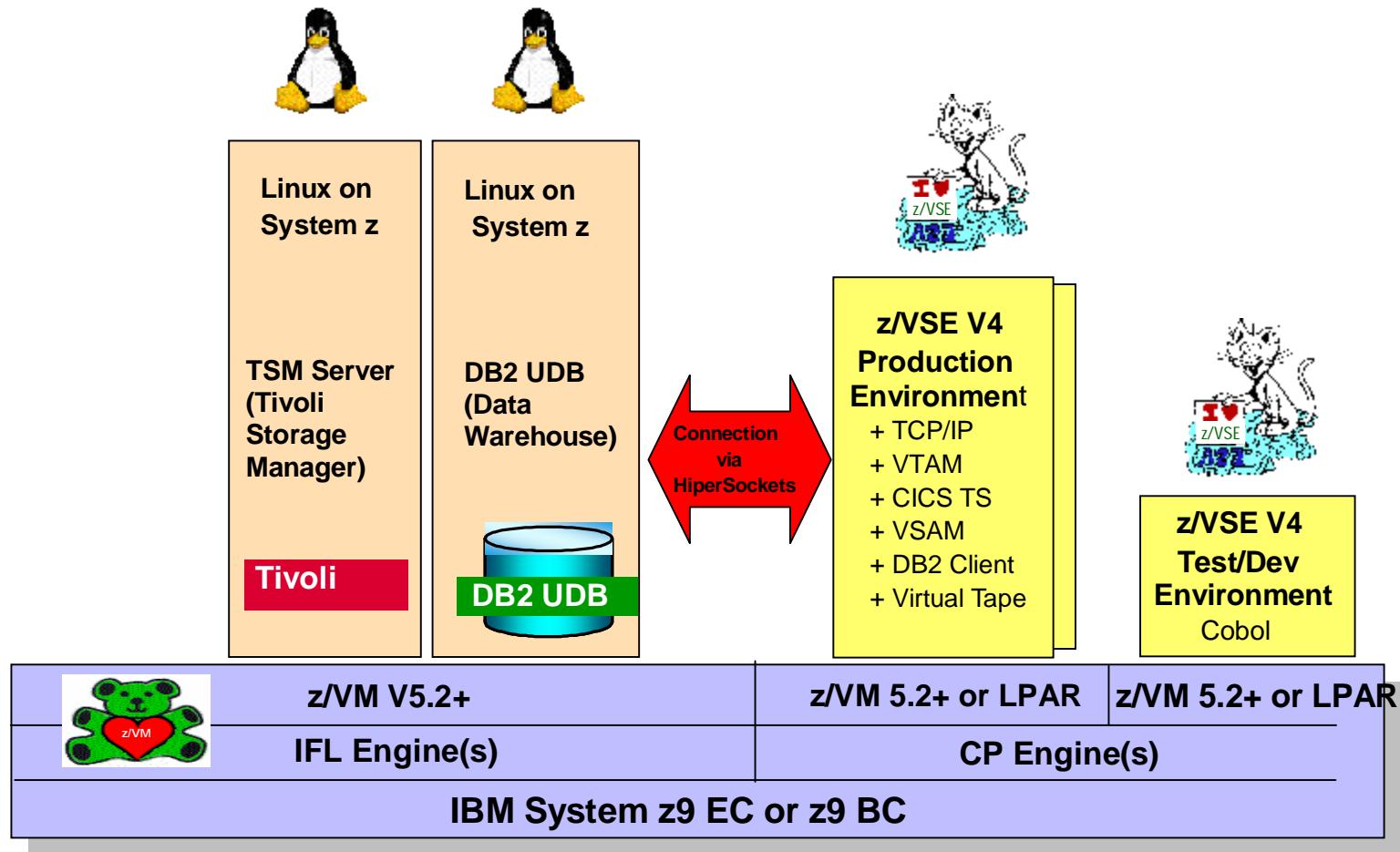



IRMM in a VM/VSE and Linux Environment

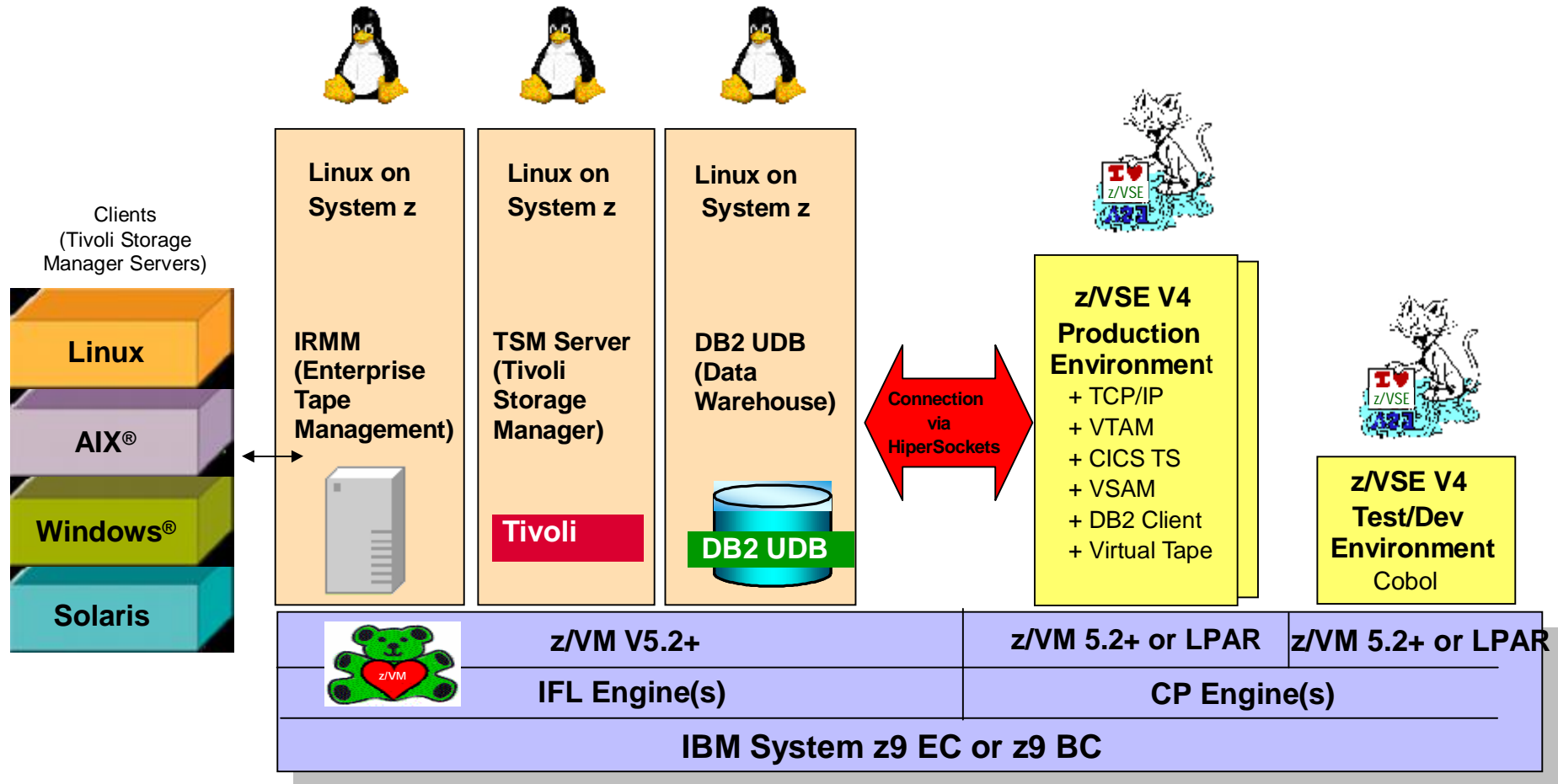

Agenda

§ **New Announcements**

§ **z/VSE**

§ **z/VM and Linux on System z**

§ **Middleware and Systems Management Solutions**

 § **IBM System Storage**

- DS8000 Turbo
- DS6000
- TS3400

§ **Summary**

IBM System Storage DS8000 Turbo Enhancements

Announced Oct-23-2007, GA planned for Dec-07-2007



Innovation that extends DS8000 world class performance

- ▶ **Storage Pool Striping** - new volume configuration option to maximize performance without special tuning
- ▶ **AMP** – breakthrough caching technology (Adaptive Multi-stream Pre-fetching) can dramatically improve sequential read performance to reduce backup times, processing for BI/DW, streaming media, batch
- ▶ **z/OS Global Mirror Multiple Reader** - IBM unique innovation to improve throughput for z/OS remote mirroring

Innovation to simplify and increase efficiency

- ▶ **IBM FlashCopy SE** - Space Efficient snapshot capability can lower costs by reducing capacity needed for copies
- ▶ **Dynamic Volume Expansion** - easier online volume expansion to support growth
- ▶ **Expansion frame warranty intermix** - increased upgrade flexibility and investment protection through base and expansion frame machine type Intermix
- ▶ **SSL** - new secure connection protocol option for call home support and additional audit logging
- ▶ **IBM System Storage Productivity Center** - enhanced user interface with single panel control and management

Enabled through new release of microcode!

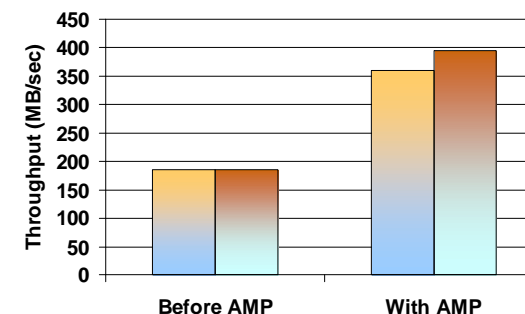

IBM System Storage DS6000 Disk Drive Update

Announced Oct-23-2007, GA Nov-16-2007



§ IBM System Storage DS6000 now supports 300GB 15,000 RPM Fiber Channel disk drives

- ▶ Significant performance improvement over 10,000 RPM 300 GB disk drive
- ▶ Enables larger capacity and denser Fiber Channel disk configurations with performance boost over 10,000 drives



§ Withdrawal of 10,000 RPM Fiber Channel disk drives

- ▶ For both, DS8000 and DS6000
- ▶ Last order date Jan-11-2008



IBM System Storage TS3400 Tape Library Overview **NEW!**

Announced Feb-13-2007, GA March-09-2007

§ 1 to 2 TS1120¹ tape drives

- ▶ 4Gbps dual port Fibre Channel attachment

§ 2 removable cartridge magazines

- ▶ Each holds up to 9 cartridges
 - Front three slots of the lower magazine can be configured as I/O station slots
 - Two slots in the upper magazine, if installed, can be configured as cleaning slots

§ Bar code reader standard

§ Ability to partition the library into 2 logical libraries

- ▶ Each logical library comprised of one drive and one magazine
- ▶ Run any single-drive logical library in either sequential (autoloader) mode or random (library) mode

§ Manageable by local operator panel or remote web GUI

§ Storage capacity of up to 12.6 TB (up to 37.8 TB with 3:1 compression)

§ Stand alone or rack mount configurations



¹3592 J1A drives are not supported

Agenda

- § **New Announcements**
- § **z/VSE**
- § **z/VM and Linux on System z**
- § **Middleware and Systems Management Solutions**
- § **IBM System Storage**
-  § **Summary**

Summary: Exploiting the Best of all Worlds with IBM System z9, IBM System Storage, and IBM Middleware

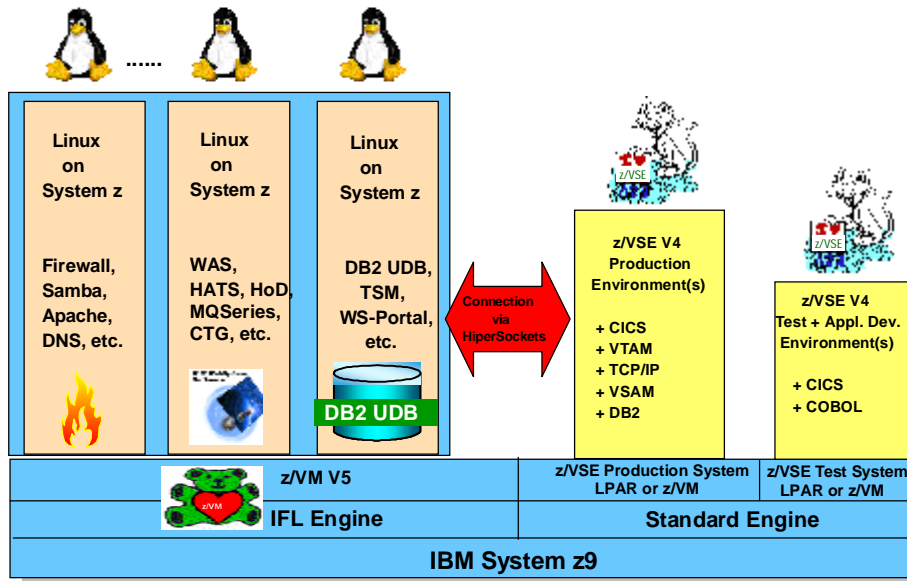

§ z/VSE V4

- ▶ Protect core IT investments thru PIE
- ▶ Robust, secure enterprise server
- ▶ Cost-effective solutions
- ▶ Interoperability with network / servers
- ▶ Highly improved price / performance

§ z/VM V5

- ▶ Highly flexible, industrial strength
- ▶ Advanced virtualization
- ▶ Multiple z/VSE and Linux images
- ▶ Designed to exploit System z9

§ Linux on System z

- ▶ Large portfolio of new applications
- ▶ Platform for IBM middleware
- ▶ Infrastructure Simplification
- ▶ Massive scalability / consolidation



Q&A



Questions?

Backup

Press on z/VM V5.3

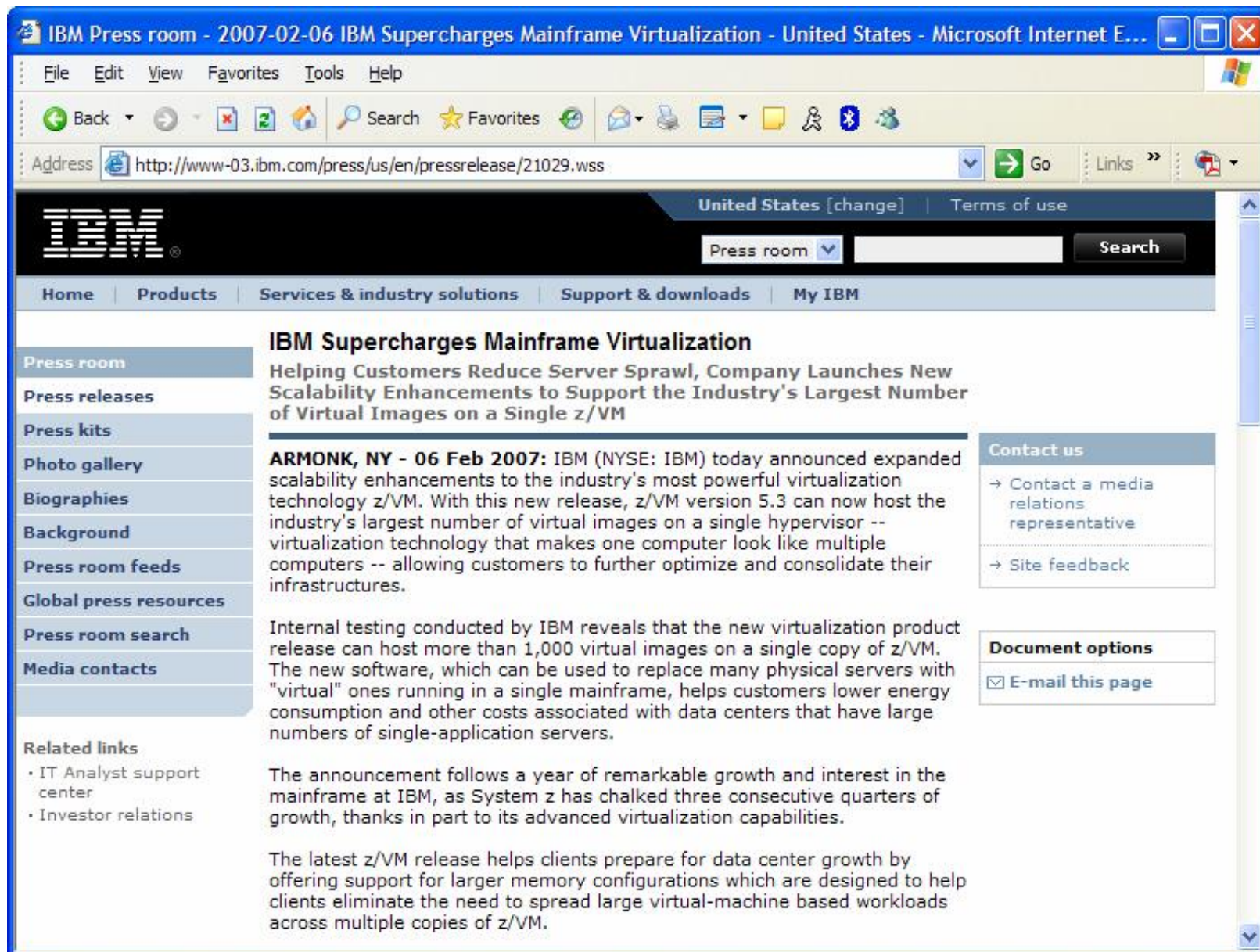

IBM Press room - 2007-02-06 IBM Supercharges Mainframe Virtualization - United States - Microsoft Internet E...

File Edit View Favorites Tools Help

Back Forward Stop Home Search Favorites Refresh Print Mail News RSS Feeds

Address <http://www-03.ibm.com/press/us/en/pressrelease/21029.wss> Go Links

United States [change] Terms of use

Press room Search

Home Products Services & industry solutions Support & downloads My IBM

Press room

Press releases

Press kits

Photo gallery

Biographies

Background

Press room feeds

Global press resources

Press room search

Media contacts

Related links

- IT Analyst support center
- Investor relations

IBM Supercharges Mainframe Virtualization

Helping Customers Reduce Server Sprawl, Company Launches New Scalability Enhancements to Support the Industry's Largest Number of Virtual Images on a Single z/VM

ARMONK, NY - 06 Feb 2007: IBM (NYSE: IBM) today announced expanded scalability enhancements to the industry's most powerful virtualization technology z/VM. With this new release, z/VM version 5.3 can now host the industry's largest number of virtual images on a single hypervisor -- virtualization technology that makes one computer look like multiple computers -- allowing customers to further optimize and consolidate their infrastructures.

Internal testing conducted by IBM reveals that the new virtualization product release can host more than 1,000 virtual images on a single copy of z/VM. The new software, which can be used to replace many physical servers with "virtual" ones running in a single mainframe, helps customers lower energy consumption and other costs associated with data centers that have large numbers of single-application servers.

The announcement follows a year of remarkable growth and interest in the mainframe at IBM, as System z has chalked three consecutive quarters of growth, thanks in part to its advanced virtualization capabilities.

The latest z/VM release helps clients prepare for data center growth by offering support for larger memory configurations which are designed to help clients eliminate the need to spread large virtual-machine based workloads across multiple copies of z/VM.

Contact us

→ Contact a media relations representative

→ Site feedback

Document options

E-mail this page

Linux on System z Spotlight



Learn about the benefits of server consolidation on SUSE Linux Enterprise Server for System z now +

Z JOURNAL [about us](#) | [editorial calendar](#) | [advertising](#) | [subscribe](#) | [contact](#)

logged in

ISSUES **ARTICLES** **AUTHORS**

z/RESOURCES

- Mainframe Community
- Mainframe Jobs
- Industry News
- White Papers
- Subscribe

SPONSORS

This department is sponsored by:

Linux on System z

Articles 1 – 4

Title	Author	Issue
Mainframe Linux on \$2 a Day	Mark Post	
Insider Insights: Linux on the Mainframe Provides Big Savings for Nationwide Insurance	Bill Carico	
Enhancing Efficiency With Mainframe Virtualization: Enter Linux on the Mainframe	Alan Radding	
Migrating to Linux on System z: Lessons Learned From the Province of Quebec's Award-Winning Project	David Kreuter	

1

Consolidate with SUSE Linux Enterprise Server for System z

<http://www.zjournal.com/>

Nationwide leverages Linux and saves \$16M over 3 years

Key Benefits (Value Proposition)

Expect to save over \$16M over the next 3 years.

Initial phase consolidated 250+ Production, Development & Test servers to 6 IFLs

Savings will be in cooling, maintenance, software and equipment costs, said Guru Vasudeva, a Nationwide computer expert who is overseeing the technology's implementation

Lower middleware and application costs, 50% reduction in monthly charges for Web infrastructure 80% reduction in data center floor space utilization, optimized CPU utilization

Greater operational and managerial efficiencies and lower cost per virtual server

Building better capacity management processes and workload modeling to better assess which applications and workloads most appropriate to migrate to the z platform for additional cost savings

Leveraged IBM services, server and software expertise for best practices in tuning and capacity management, better management and resource optimization to drive down costs



<http://www.linuxworld.com/events/keynotes/lwsf06-guru.html>

Solution:

GTS Capacity Planning and Capacity Management Services
IBM zSeries 990 IFLs with 136 GB memory and associated systems software licenses

Novell SUSE Enterprise Linux 9

IBM WebSphere

IBM DB2 Universal Database™ (UDB)

IBM WebSphere MQ

z/VM-Linux and Support Line Linux support