

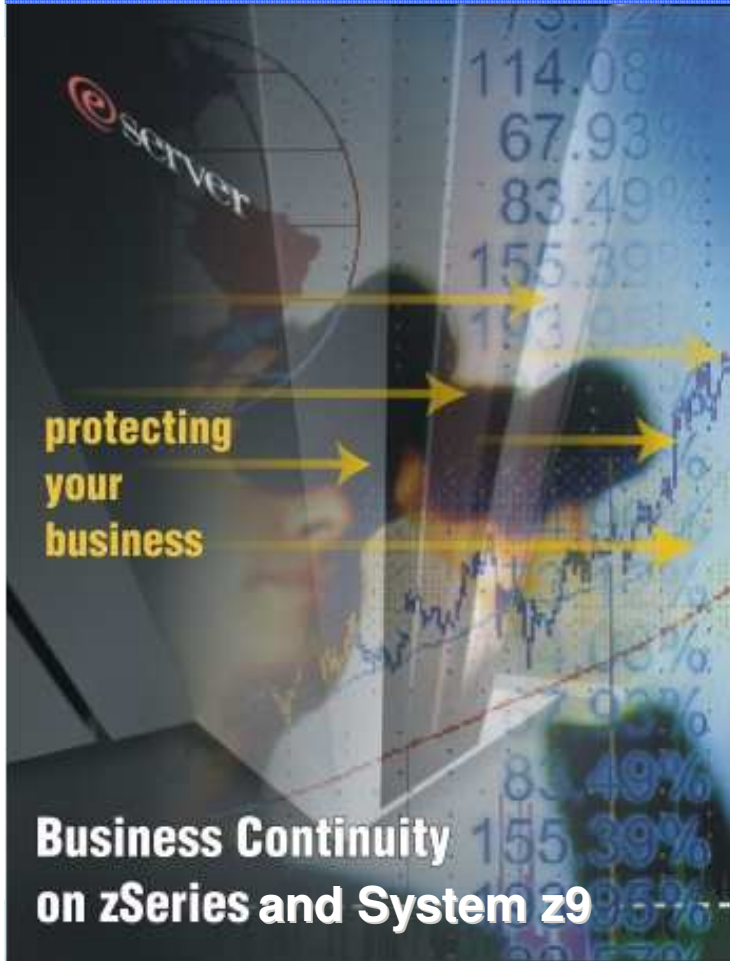

IBM zSeries and System z9

What's New with GDPS?

David Raften
Raften@us.ibm.com



ON DEMAND BUSINESS™

Trademarks

The following are trademarks of the International Business Machines Corporation in the United States and/or other countries.

AIX*	GDPS*	S/390*
CICS*	HyperSwap	Sysplex Timer*
DB2*	IBM*	Tivoli*
e-business logo*	IBM eServer*	TotalStorage*
Enterprise Storage Server*	IBM logo*	z/OS*
ESCON*	NetView*	z/VM*
FICON	OS/390*	zSeries*
FlashCopy*	Parallel Sysplex*	

* Registered trademarks of IBM Corporation

The following are trademarks or registered trademarks of other companies.

Intel is a trademark of the Intel Corporation in the United States and other countries.

Java and all Java-related trademarks and logos are trademarks or registered trademarks of Sun Microsystems, Inc., in the United States and other countries.

Microsoft, Windows and Windows NT are registered trademarks of Microsoft Corporation.

SET and Secure Electronic Transaction are trademarks owned by SET Secure Electronic Transaction LLC.

UNIX is a registered trademark of The Open Group in the United States and other countries.

* All other products may be trademarks or registered trademarks of their respective companies.

Notes:

Performance is in Internal Throughput Rate (ITR) ratio based on measurements and projections using standard IBM benchmarks in a controlled environment. The actual throughput that any user will experience will vary depending upon considerations such as the amount of multiprogramming in the user's job stream, the I/O configuration, the storage configuration, and the workload processed. Therefore, no assurance can be given that an individual user will achieve throughput improvements equivalent to the performance ratios stated here.

IBM hardware products are manufactured from new parts, or new and serviceable used parts. Regardless, our warranty terms apply.

All customer examples cited or described in this presentation are presented as illustrations of the manner in which some customers have used IBM products and the results they may have achieved. Actual environmental costs and performance characteristics will vary depending on individual customer configurations and conditions.

This publication was produced in the United States. IBM may not offer the products, services or features discussed in this document in other countries, and the information may be subject to change without notice. Consult your local IBM business contact for information on the product or services available in your area.

All statements regarding IBM's future direction and intent are subject to change or withdrawal without notice, and represent goals and objectives only.

Information about non-IBM products is obtained from the manufacturers of those products or their published announcements. IBM has not tested those products and cannot confirm the performance, compatibility, or any other claims related to non-IBM products. Questions on the capabilities of non-IBM products should be addressed to the suppliers of those products.

Prices subject to change without notice. Contact your IBM representative or Business Partner for the most current pricing in your geography.

This presentation and the claims outlined in it were reviewed for compliance with US law. Adaptations of these claims for use in other geographies must be reviewed by the local country counsel for compliance with local laws.

Agenda



- Business Continuity Overview
 - Business Continuity Objectives
 - Need for Data Consistency
 - GDPS overview
- Continuous Availability of Data within a Single Site
 - Disk Maintenance and Disk Failures with HyperSwap Manager
- Metropolitan Distance Continuous Availability / Disaster Recovery (D/R) Solution (2 sites)
 - Configuration Options
 - Planned and Unplanned Site Reconfiguration with HyperSwap
 - Open LUN Management
- Unlimited Distance D/R Solution (2 sites)
 - GDPS/XRC
 - GDPS/Global Mirror
- CA/DR Solution (3 sites)
 - z/OS[®] data only
 - z/OS[®] and Open data
- What's New / Futures
- Summary
 - Reference Customer Experiences

GDPS Overview

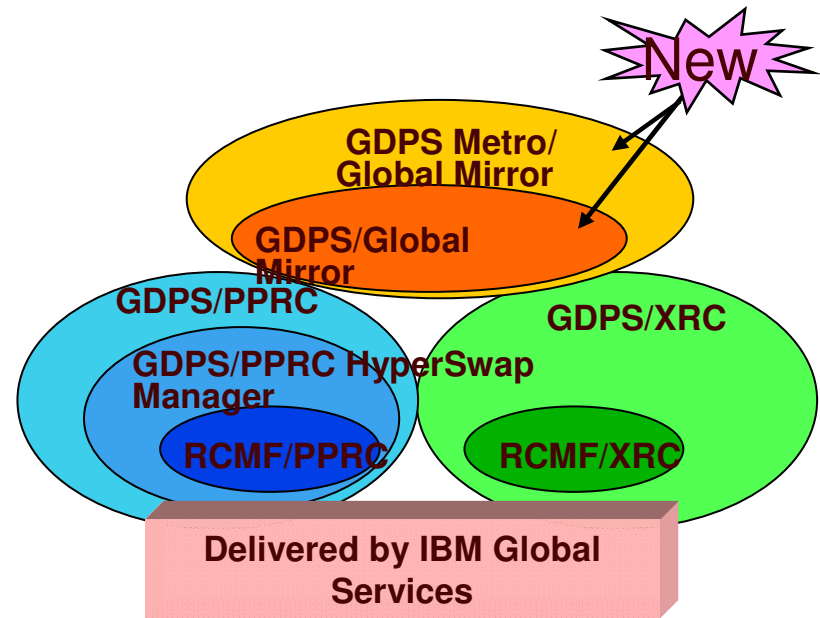

✓ What is GDPS

PPRC and XRC Overview

PPRC (Metro Mirror)

- Synchronous remote data mirroring
 - Application receives “I/O complete” when both primary and secondary disks are updated
- Typically supports metropolitan distance
- Performance impact must be considered
 - Latency of 10 us/km

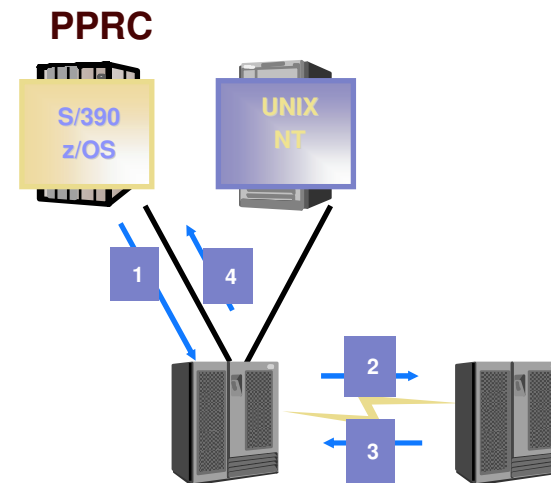

XRC (z/OS Global Mirror)

- Asynchronous remote data mirroring
 - Application receives “I/O complete” as soon as primary disk is updated
- Unlimited distance support
- Performance impact negligible
- System Data Mover (SDM) provides
 - Data consistency of secondary data
 - Central point of control

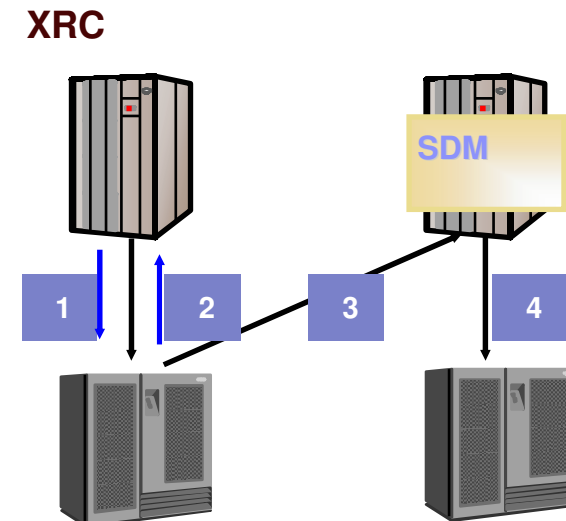

Global Mirror Overview

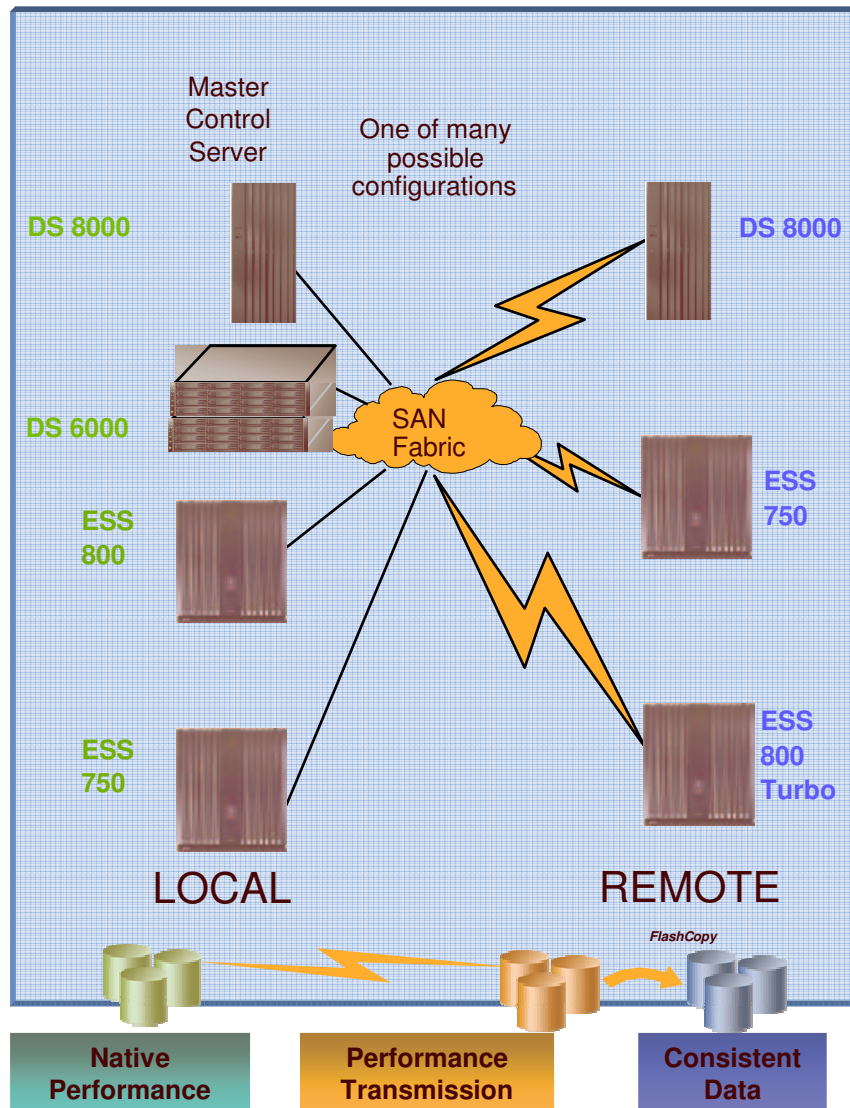

- **Designed to Provide:**
 - **Global Distance:** Two-site, unlimited distance, data consistent asynchronous disk mirroring
 - **Heterogeneous:** Data can span zSeries® and open systems data, and can contain a mix of zSeries and open systems data
 - **Scalability:** Consistency Group supported across up to 17 total ESSs in Global Mirror session (with RPQ)
 - **Flexibility:** Many possible configurations
 - **Application Performance:** Native
 - **Mirroring Performance:** Two ESS Fibre Channel disk mirroring links per ESS sufficient for almost all workloads
- **Intended Benefits**
 - **Autonomic:** No active external controlling software required to form consistency groups
 - **Saves cost:** No server cycles required to manage consistency groups
 - **Lowers TCO:** designed to provide improved performance, global distances, and lower costs

Need for Time Consistency

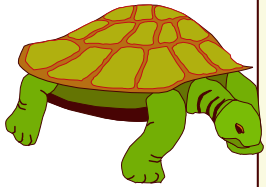

Recovery

Process measured in hours or days

Restore last set of Image Copy tapes
Apply log changes to bring database up to
point of failure

Restart

Process measured in minutes

To start a DB application following an
outage without having to restore the
database

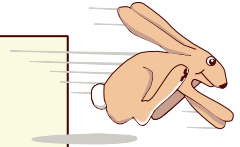

Protection against mirroring failures

- Many examples where the start of one write is time dependent on the completion of a previous write
 - Database & log
 - Index & data components
 - Time sequence could be exposed
- GDPS automation ensures consistency
 - Across any number of primary subsystems
- Consistency enables Restart instead of Recovery
- *Even if second copy can be trusted, disk switch is disruptive for the entire workload*

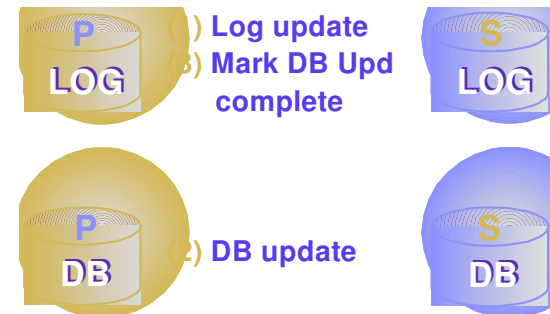

- ✓1 is OK
- ✓1,2 is OK
- ✓1,2,3 is OK
- ✓1,3 is NOT OK

GDPS Automation

- **Allows business continuity processes to be built upon a reliable, consistent recovery time**
 - No need to keep updating recovery procedures
 - Assured Scalable
 - Affordable testing
- **Manage and Monitor remote copy environment**
 - Establish and delete Paths and Pairs,
 - Issues commands to Recover, Queries, Suspend, Resynchronize ...
 - Alerts
- **Manage day to day activities**
 - Coupling Facilities, Couple Data Sets
 - Shut down, Start up, Recycle systems
 - Responds to messages at IPL time
- **Manage Resources**
 - CBU, FlashCopy, PtP VTS

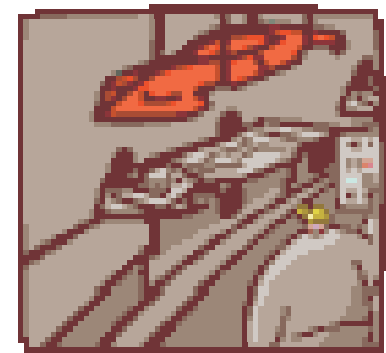

GDPS offers a comprehensive solution,
not just remote copy technology

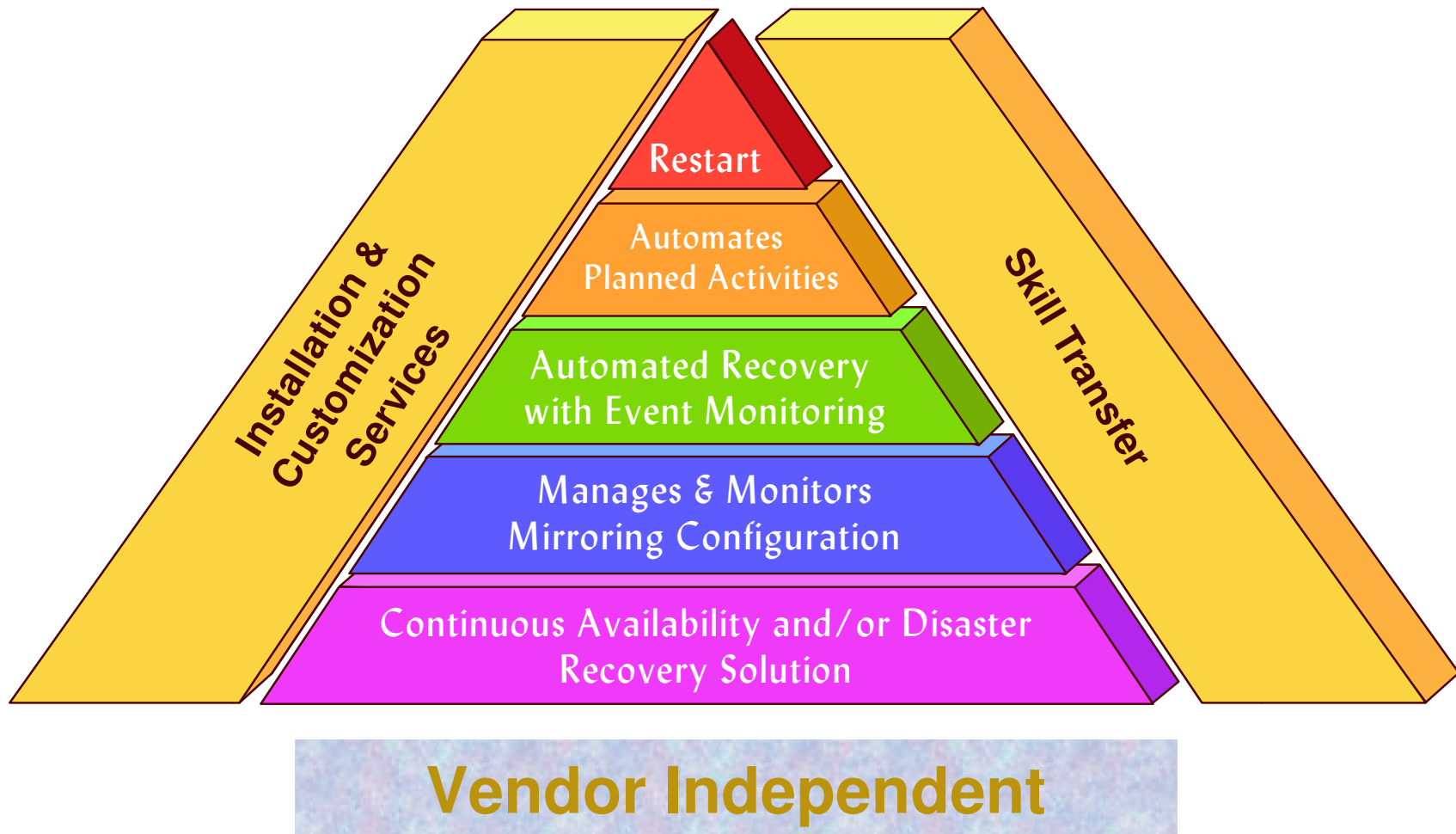

GDPS Maintenance / Testing

- Same processes as other z/OS products
 - Installed via SMP/E through Shopz
 - Fixes go through RSU process
- Stress and saturation testing, failure and recovery testing, and rolling IPL maintenance testing
 - z/OS at 3 levels (e.g., z/OS R4, z/OS R5, & z/OS R6)
 - subsystems at 2 levels (e.g., 'n' and 'n-1')
- PPRC Scenarios
 - Planned / Unplanned HyperSwaps,
 - Simulated site disaster (CF, zOS failures)
 - Break communication links
 - Manages IPL
- Monthly RSUs:
 - HIPERs, PE fixes, Security, Integrity APARs
- Quarterly RSU:
 - Severity 1, 2, 3 & 4 APARs



EOS and Future GDPS Releases



Release	GA	EOS
GDPS V3.1	February 2004	January, 2006
GDPS V3.2	March, 2005	March, 2007 *
GDPS V3.3	January, 2006	March, 2008 *

- * Indicates projected date. Actual end of marketing or end of service date has not been announced yet.
- All statements regarding the future direction and intent of IBM are subject to change or withdrawal without notice and represent goals and objectives only.

Coming Soon ...

- GUI Interface
 - Not limited to ISPF-like NetView Console panels

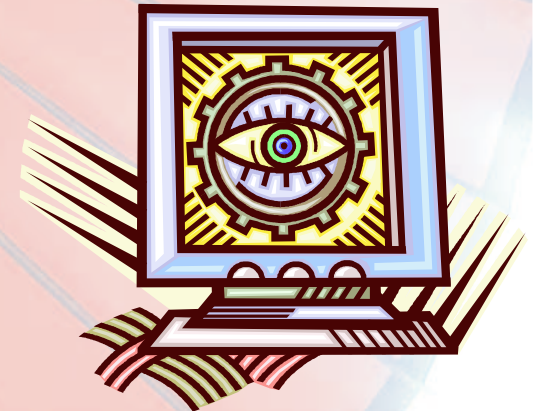

Continuous Availability of data within a single site

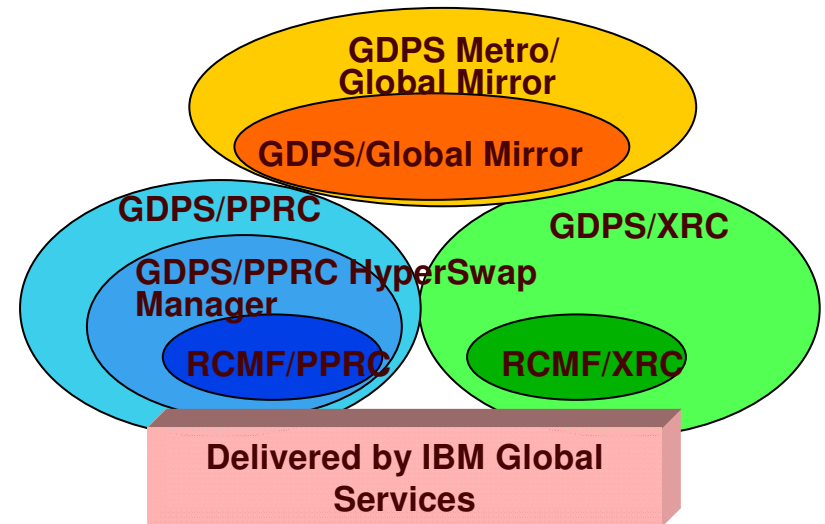

- ✓ HyperSwap technology
- ✓ GDPS/PPRC HyperSwap Manager
- ✓ Unplanned and Planned disk reconfiguration w/ HyperSwap

GDPS/PPRC HyperSwap

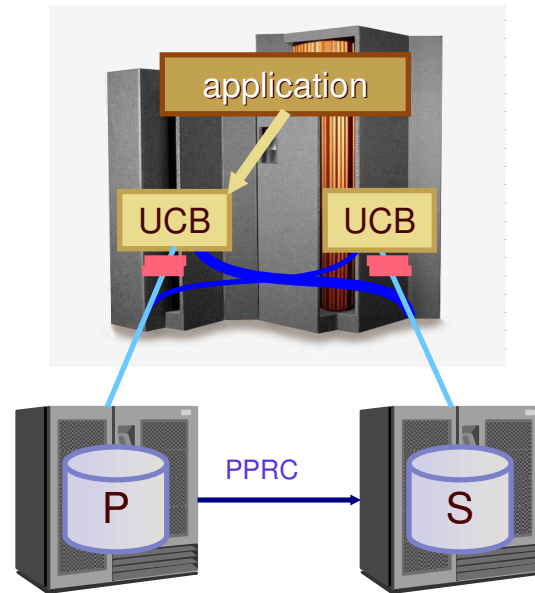

- **Substitutes PPRC secondary for primary device**
 - No operator interaction - GDPS-managed
 - Can swap large number of devices - fast
 - Includes volumes with Sysres, page DS, catalogs
 - Non-disruptive - applications keep running

With HyperSwap
and FO/FB

13 Seconds! (6545 volume pairs, 19.6 TB, 46 LSSs)

Only changed data needs to be copied to restore to original configuration

PPRC Failover, swap the primary & secondary PPRC UCBs, systems continue

GDPS/PPRC HyperSwap Manager

- **Availability**
 - Extends Parallel Sysplex availability to disk subsystems
- **System Management**
 - Simplifies management of Remote Copy configuration, reducing storage management costs
 - Reduces time required for Remote Copy implementation
 - Combines the features of Remote Copy management with the automation of GDPS
- **Effective entry level offering** for customers that require high levels of availability
 - Specially priced Tivoli NetView and System Automation products
 - Positioned to upgrade to full GDPS



Parallel Sysplex designed to provide Near-Continuous Availability of systems, servers and applications within a single site (degree of availability depends on exploitation of Parallel Sysplex)

PPRC Failover / Failback (GDPS V3.2)

- The new primary volumes (at the remote site) record changes while in failover mode.
- The original mode of the volumes at the local site is preserved as it was when the failover was initiated.
- Only need to resynchronize from time of failover, not entire data set

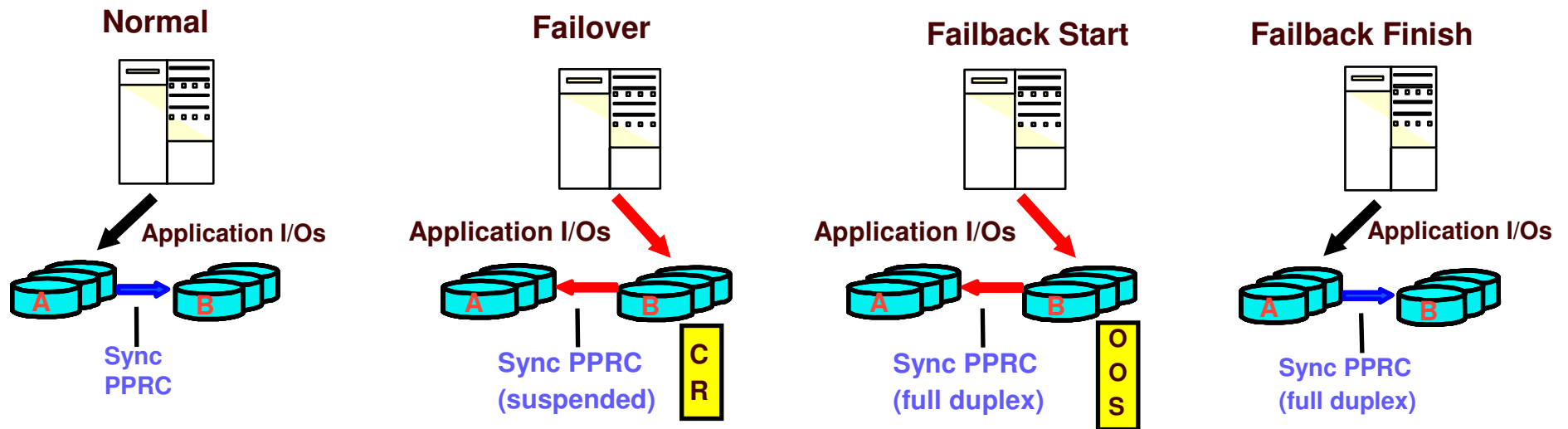

- **Faster Resynchronization**
- **Less resource consuming**

HyperSwap Extensions (GDPS V3.3)

- **Existing HyperSwap Triggers**
 - I/O errors
 - Boxed devices
 - Control Unit failures
- **IOS Timing Trigger**
 - Availability
 - Autonomic detection of “**Soft Failures**” to trigger HyperSwap
 - Based upon customer defined I/O timing thresholds
- **Dual site and single site environments**
 - GDPS/PPRC
 - GDPS/PPRC HyperSwap Manager



Metropolitan Distance Continuous Availability / Disaster Recovery Solution (2 sites)

- ✓ GDPS/PPRC
- ✓ Distance Testing
- ✓ CF Duplexing support
- ✓ Management of Open Systems LUNs
- ✓ Multi-Platform Resiliency

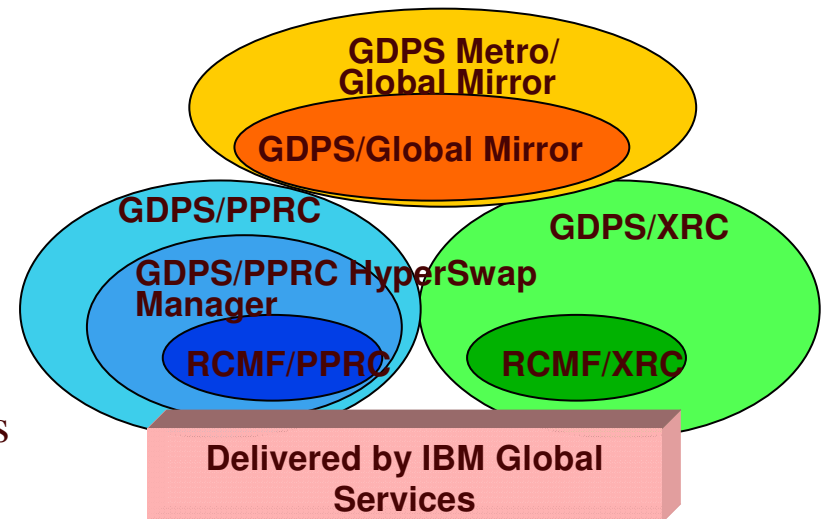

What is GDPS/PPRC? (Metro Mirror)

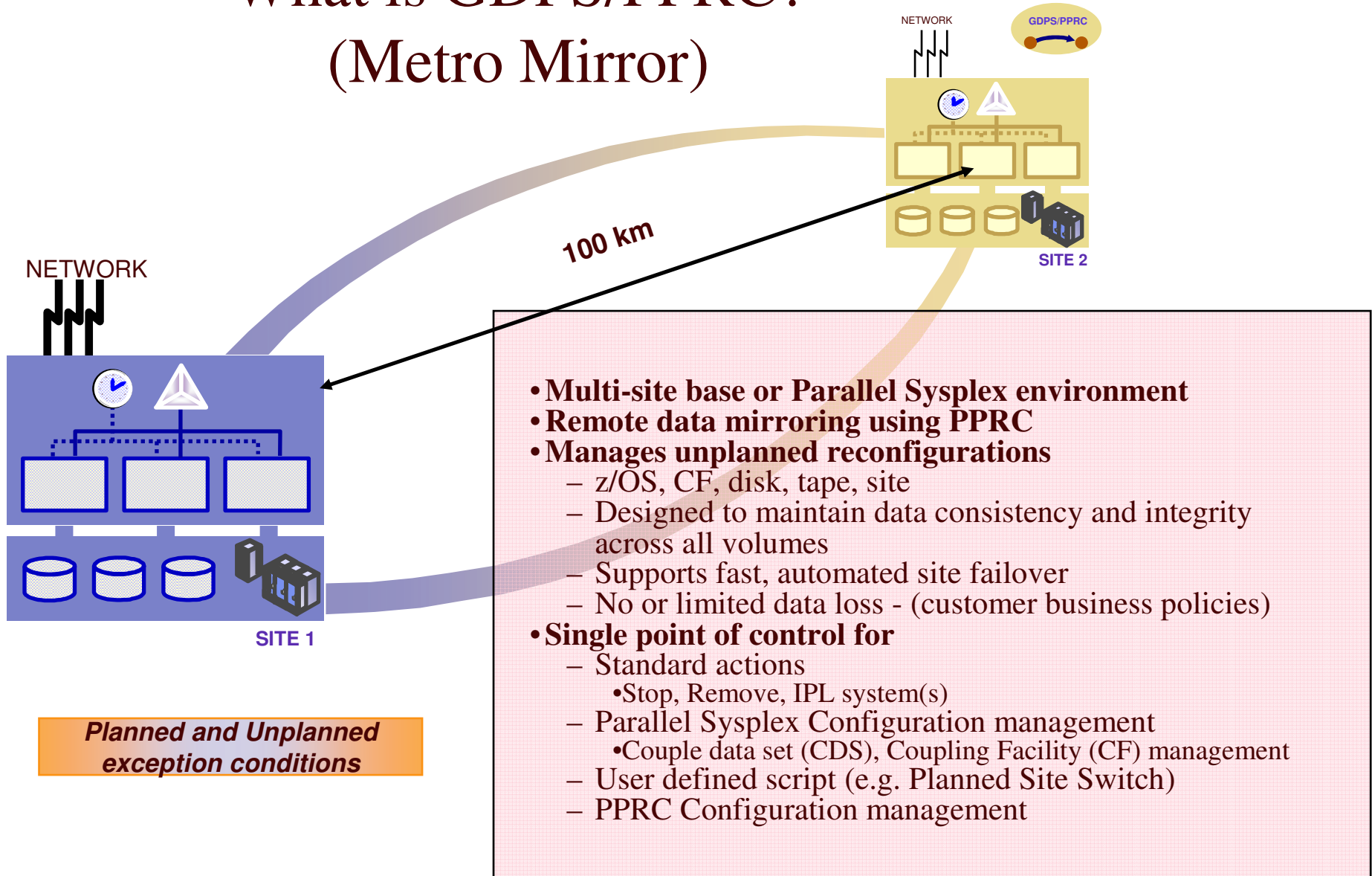

Server Time Protocol (STP)

GA Announcement: **Days away**

- Designed to provide capability for multiple System z9 and zSeries platforms to maintain time synchronization with each other
 - Does not require the 9037 Sysplex Timer if all servers STP capable
- Timing information transmitted over ISC-3 links (Peer mode), ICB-3 and ICB-4 links
- Supports a multi-site timing network of up to **100 km** (62 miles)
 - Allows a Parallel Sysplex cluster to span up to 100 km
- May reduce the cross-site connectivity required for a multi-site Parallel Sysplex clusters
- Can coexist with an External Time Reference (ETR) network (9037 based)
 - Mixed Timing Network
- Designed to allow use of dial-out time services to set the time to international time standard (UTC) as well as adjust to UTC
- Prerequisites
 - z890, z990, z9
 - z9 HMC Code load
 - z/OS V1.7 + APARs



Environment 1 Single Site Environment

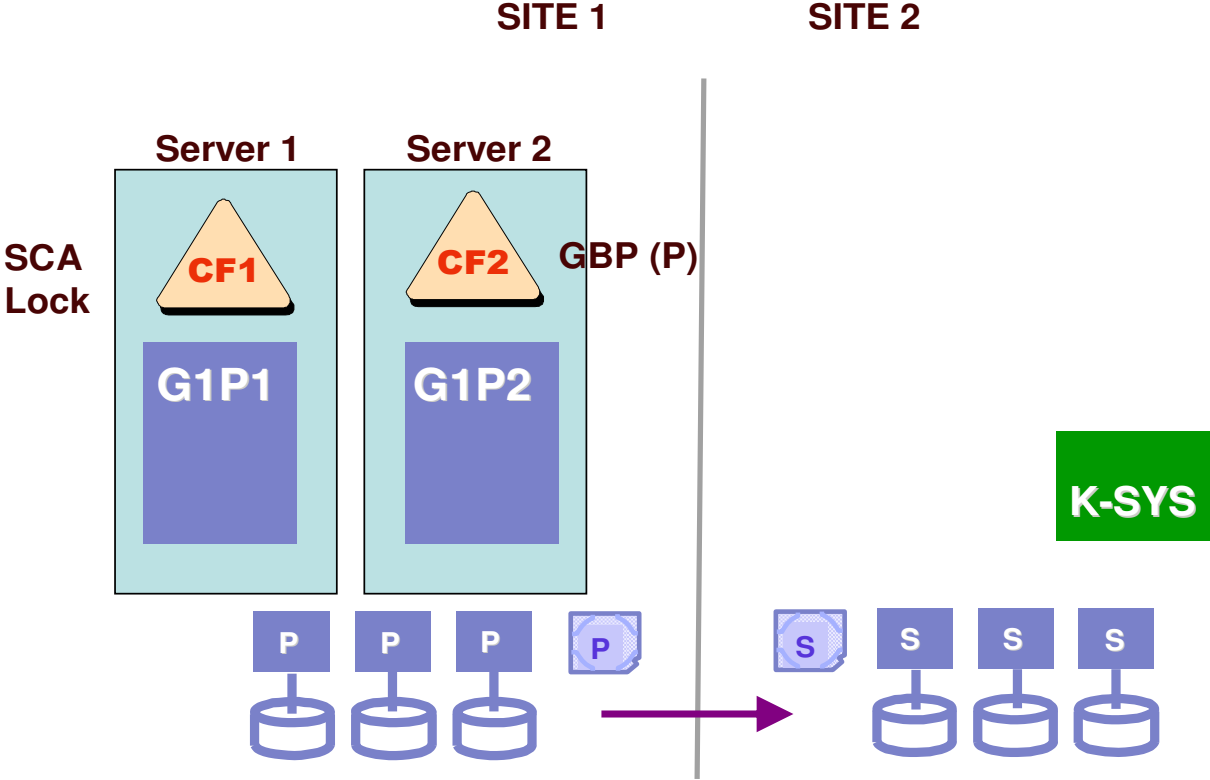

Environment 2: CF on Site 2

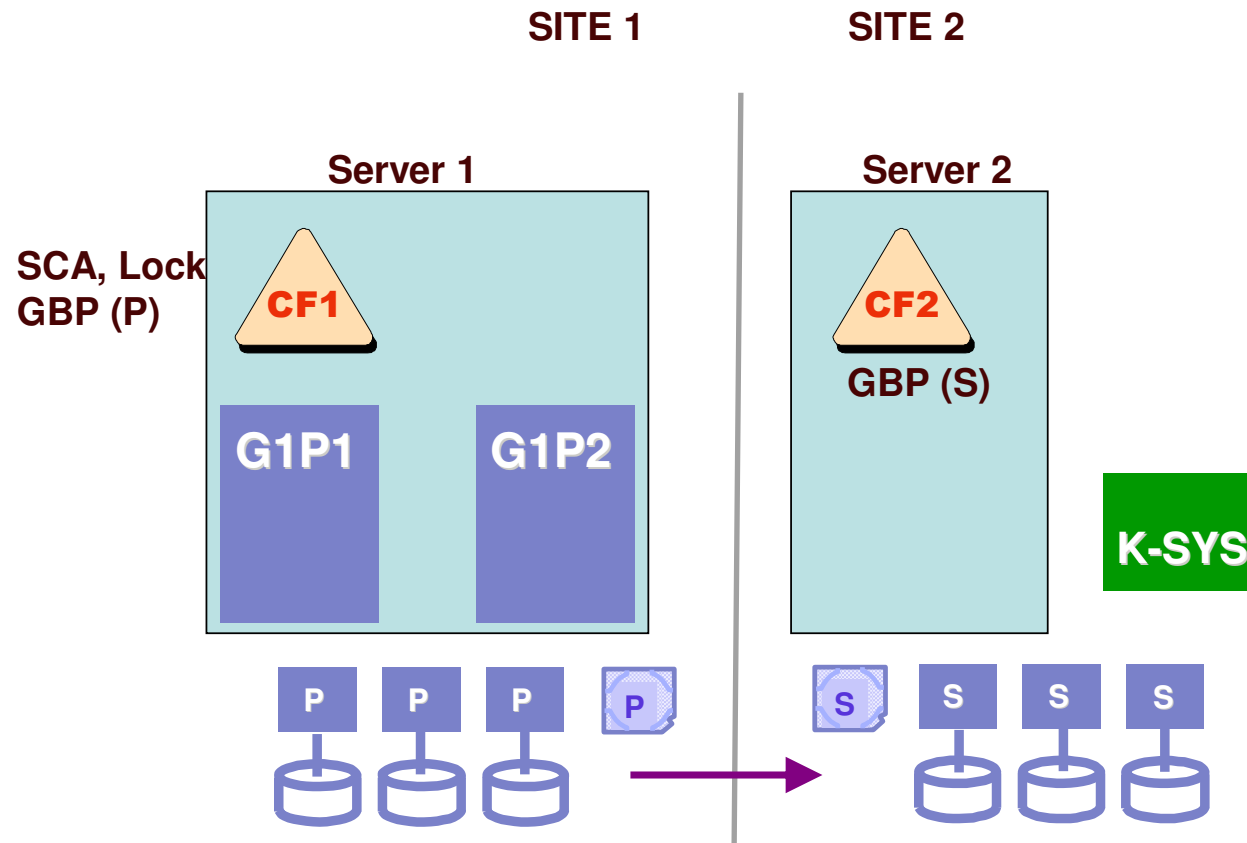

Environment 3: Multi-Site Workload

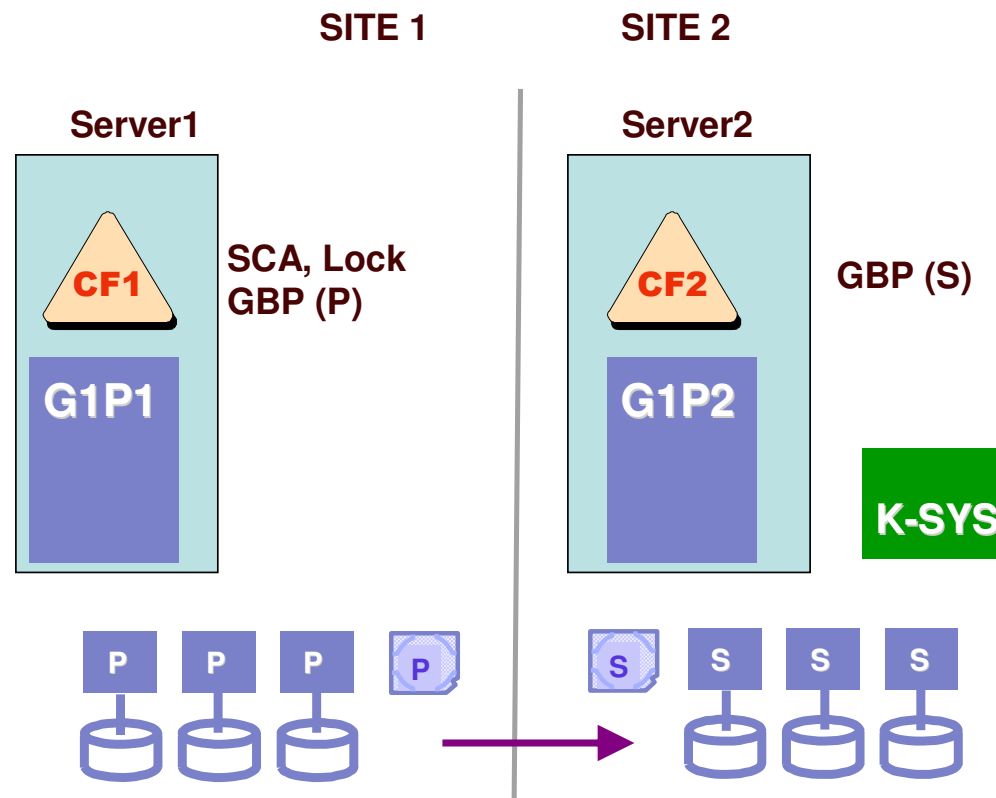

Environment 1: Single Site Workload Just PPRC

TPNO Transaction Resp Time

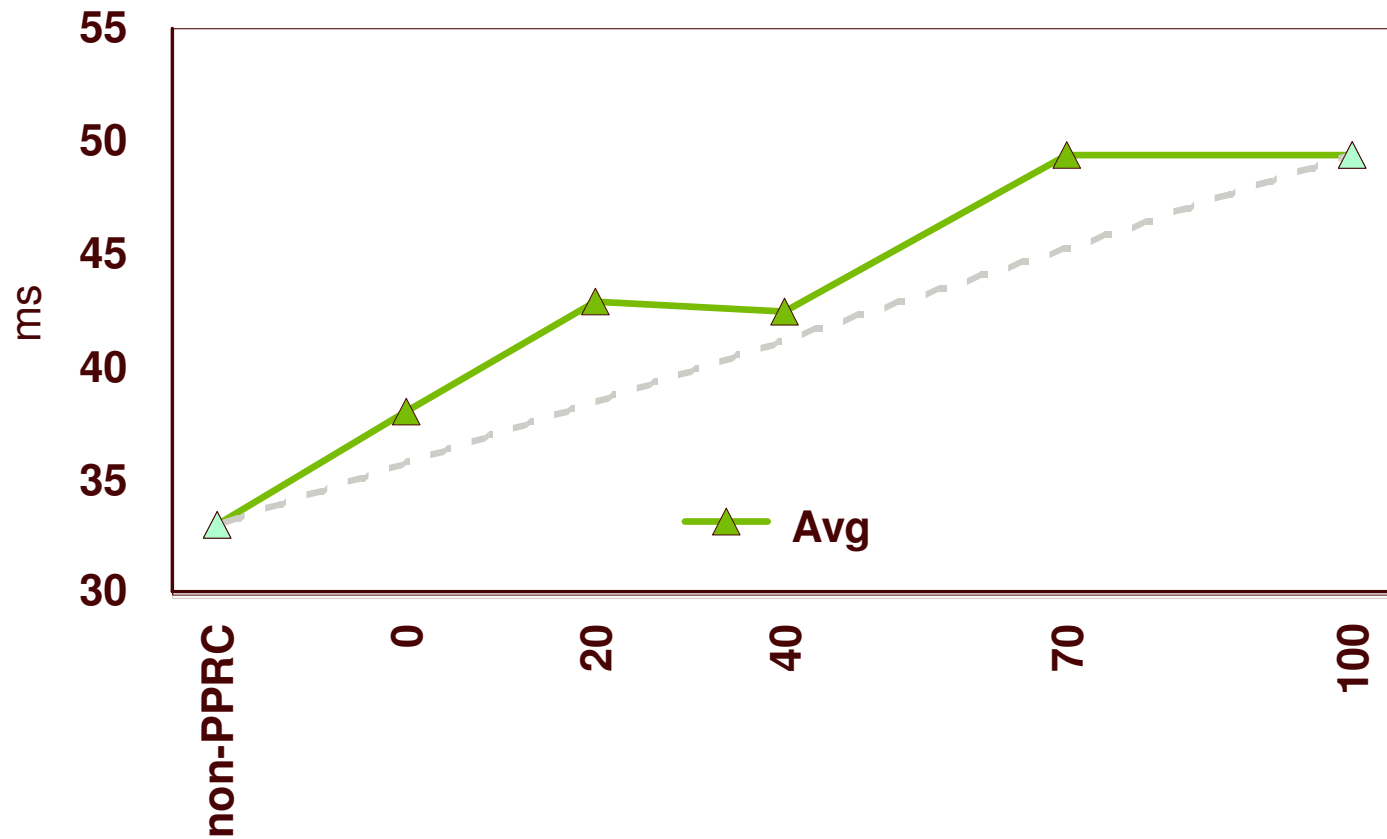

Environment 2: + DB2 GBP Duplexing

Avg TPNO Resp Time for both members

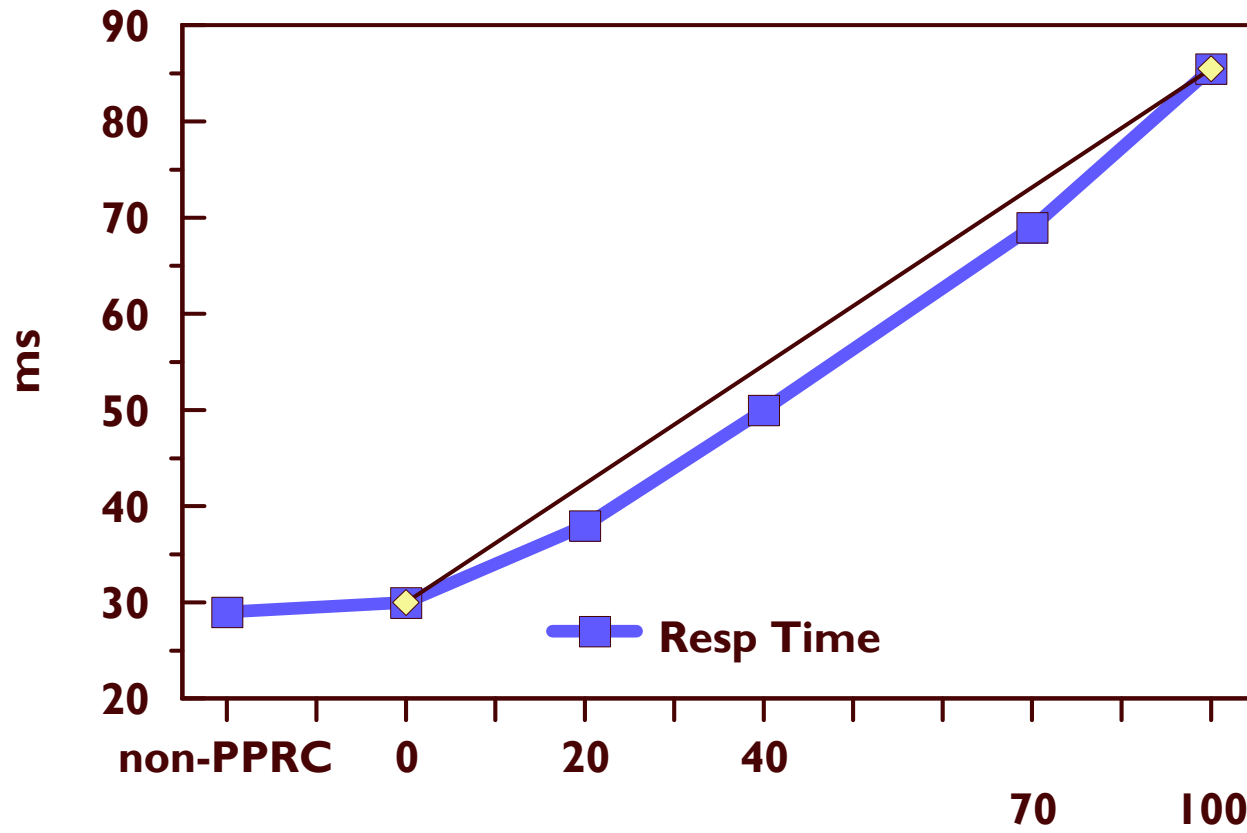

Environment 3: + Multi-site Parallel Sysplex

Adjusted TPNO Response Times ms / tran

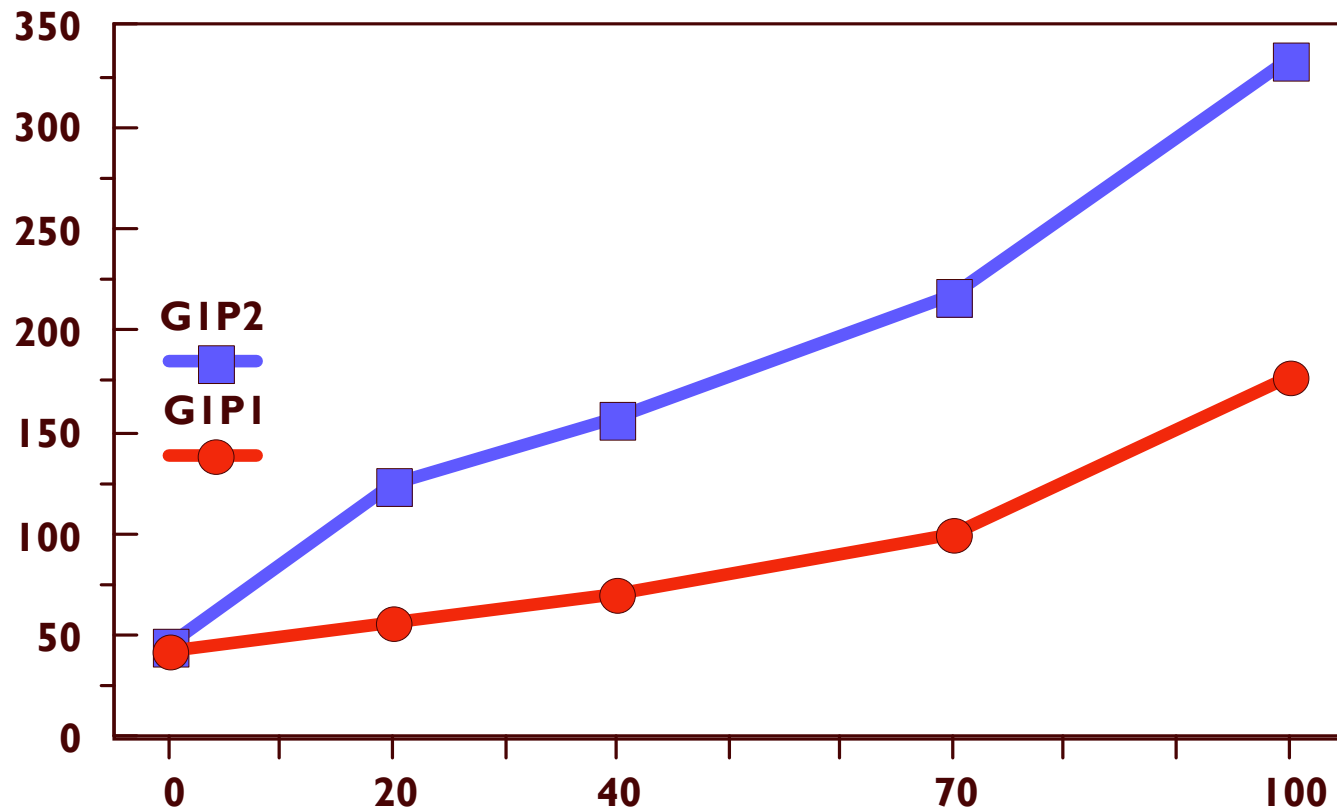

Sysplex in a single site (aka BRS configuration) PPRC across sites

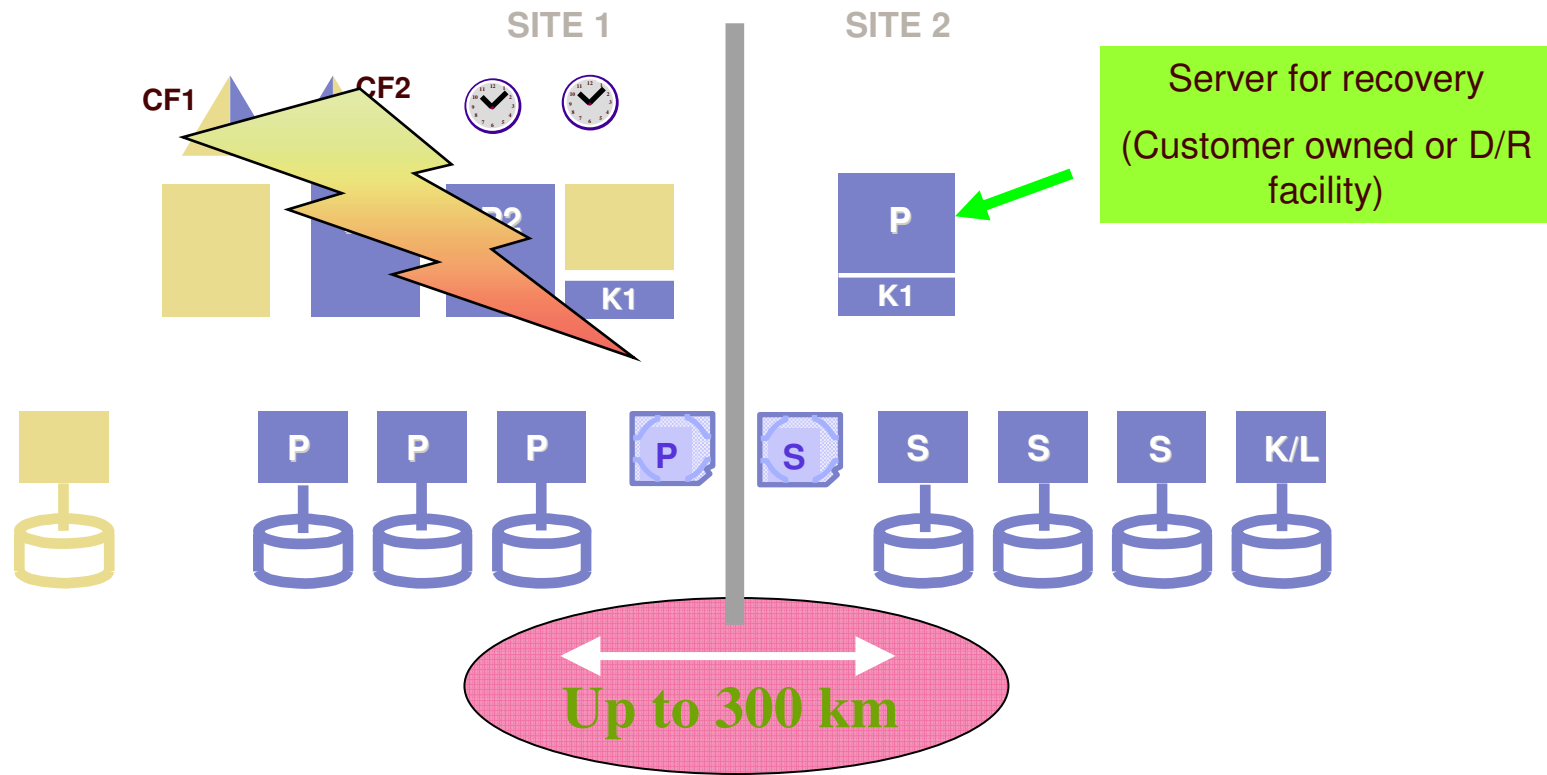

IPL K system in Site 2
GDPS automation restarts Production systems and applications
No Data Loss. Full data consistency

Enhanced Recovery Support for CF Duplexing GDPS V3.3

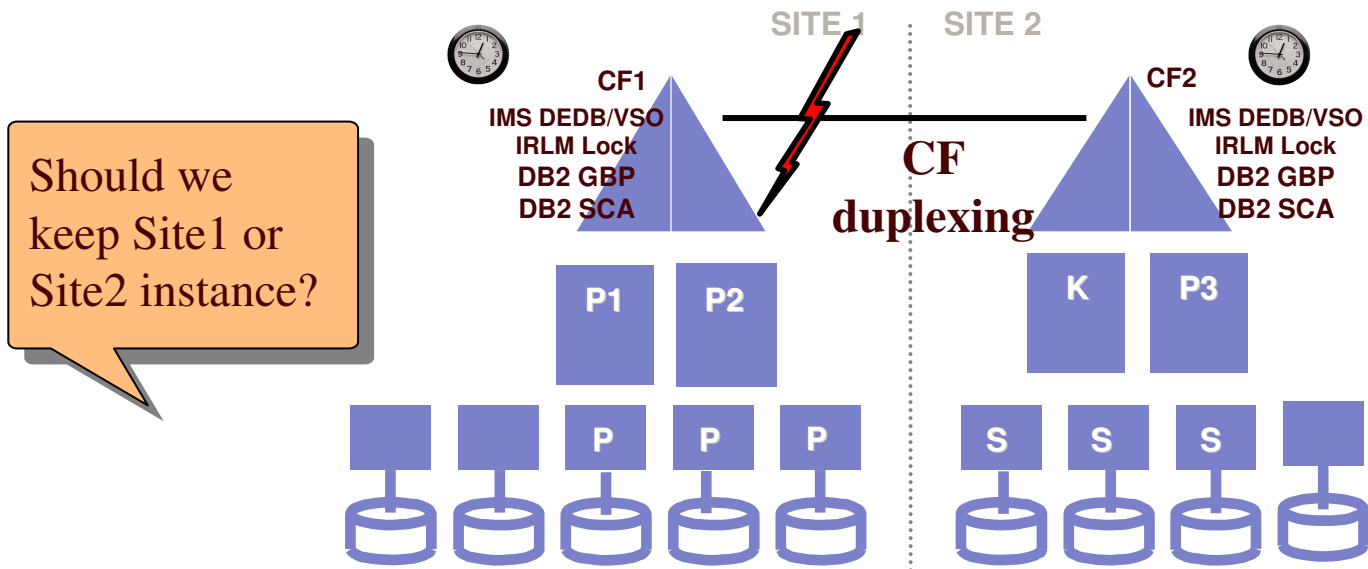

- Requires Freeze=STOP policy
- GDPS will recommend that structure instances in CF in same site as secondary disks be retained and used

***No special recovery actions (e.g. GRECP) required
Facilitates faster application restart (improved RTO)
Provides consistent recovery time***

GDPS/PPRC management of Open Systems LUNs

“Single Site” or 2 sites

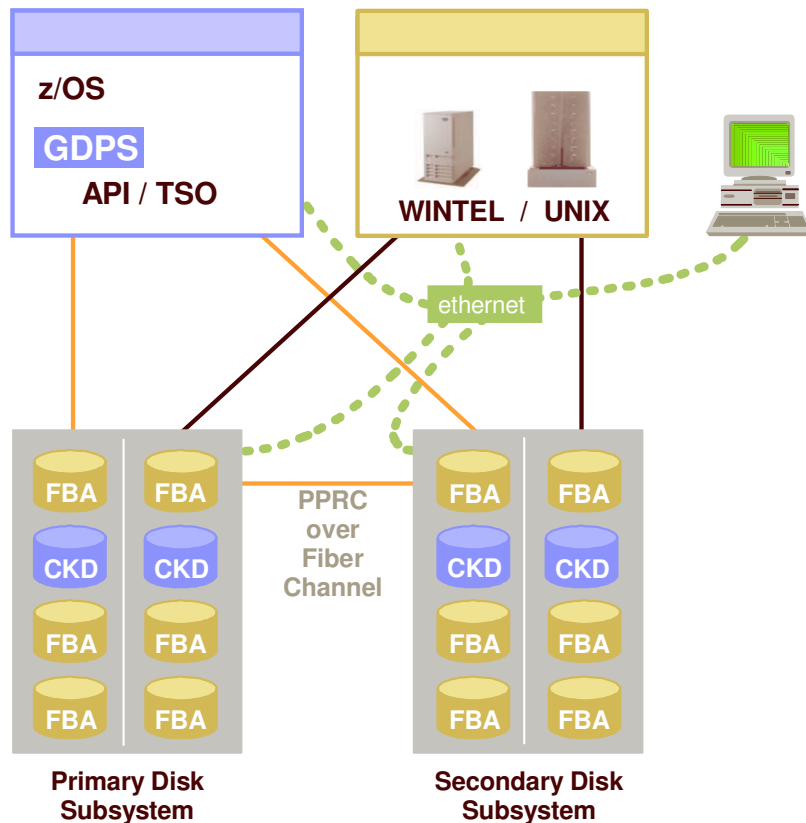

- Extends GDPS/PPRC technology to manage distributed applications across multiple platforms
 - z/OS and open systems data (Unix, NT, Linux)
- GDPS/PPRC running in a z/OS system manages the PPRC status of devices that belong to the other platforms
- Provides data consistency across both z/OS and/or open systems data when failures occur
- Support details
 - Supports x-platform or platform level Freeze
 - No GDPS Code running on open systems host – suspends reported through SNMP alert

Helps provide enterprise-wide Disaster Recovery with data consistency!

Coming Soon...

- GDPS interface to **any** Unix platforms
 - Work with other cluster manager products
 - Help manage any HW (and SW!) remote copy technology
 - Phased approach

GDPS/PPRC Multi Platform Resiliency for zSeries

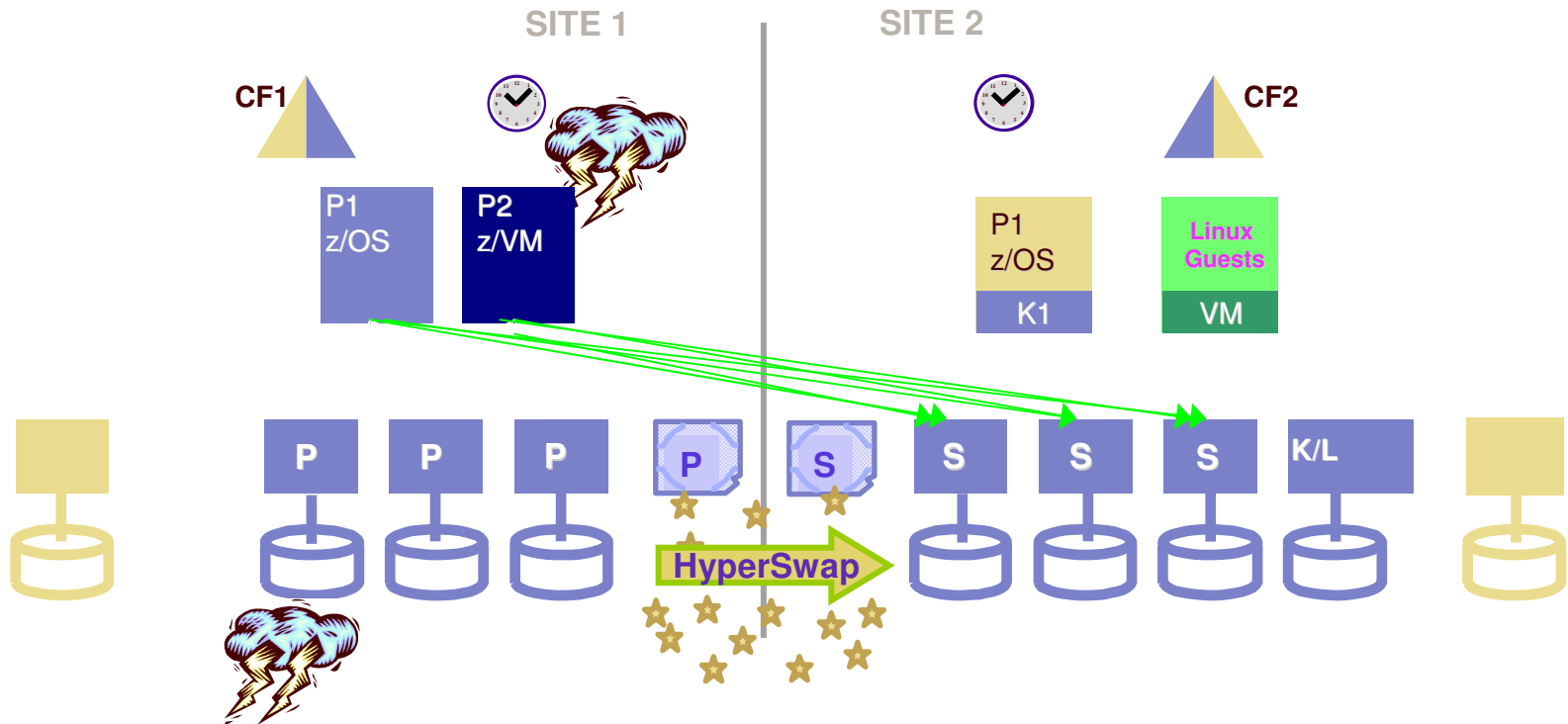

- ✓ Coordinated near-continuous availability and DR solution for z/OS and Linux guests running under z/VM
 - Valuable for customers with distributed applications
 - SAP application server running on Linux for zSeries
 - SAP DB sever running on z/OS
- ✓ Planned and Unplanned Reconfigurations

Multi-Platform Resiliency for ...

- If we can support Linux on zSeries...
 - Why not native Linux on zSeries?
 - Why not (native) Linux on other platforms?
 - Why not Unix on other platforms?
- Requires SCSI support



Unlimited Distance Disaster Recovery (2 sites)

- ✓ GDPS/XRC
- ✓ GDPS/Global Mirror

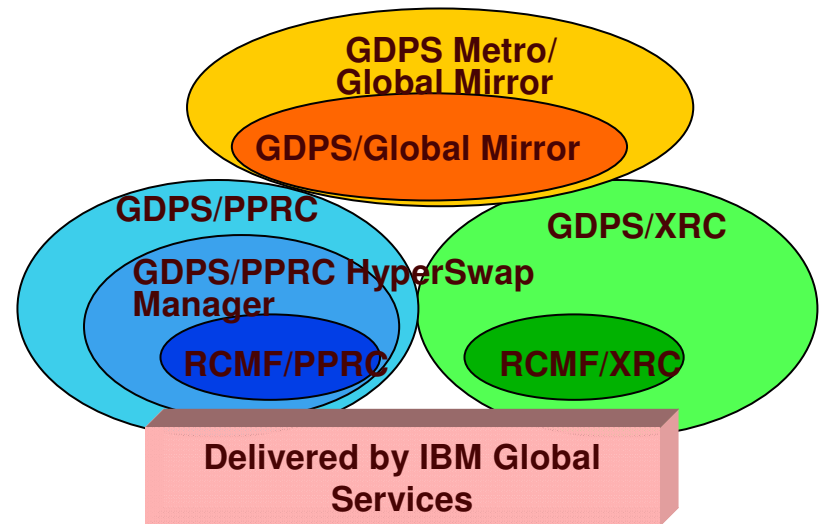

GDPS/XRC - Primary Site Failure

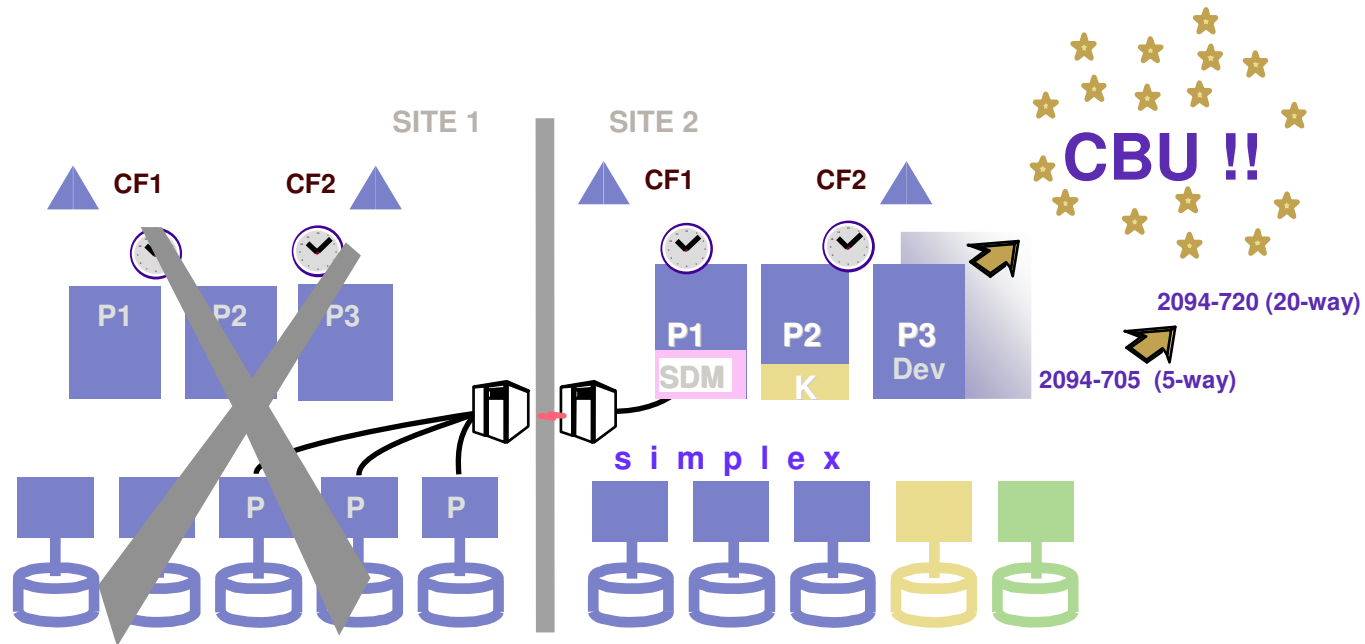

- Production system can be
 - No, Base, or Parallel Sysplex environment
 - SUSE Linux Enterprise Server (SLES) 8
- System Data Mover(s) must run in Base or Parallel Sysplex

Automates recovery of production environment
Automates invocation of CBU

GDPS Support for “XRC+”

GDPS V3.3 & z/OS R7

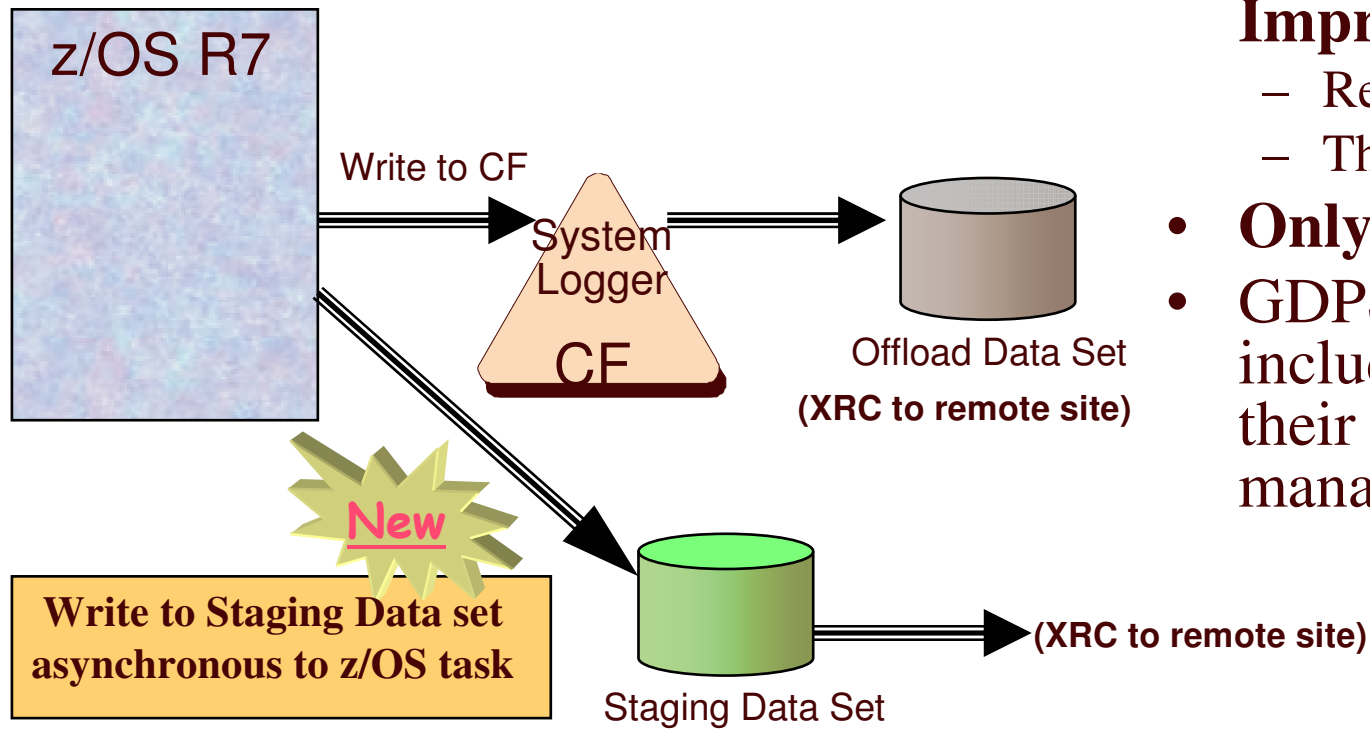

- **Performance Improvements**
 - Response Time
 - Throughput
- **Only with XRC**
- GDPS support will include the options in their setup for volume management.

*Improved throughput
for high volume logging applications*

XRC Scalability support GDPS V3.3+

- Increases the number of SDMs per LPAR from 5 to 20
- Adds a new concept called clustering for SDMs on the same LPAR
 - Up to 13 SDMs on the same LPAR can be clustered together
 - Up to 14 clusters can then be coupled together using the coupling mechanism
 - Increases architecture limit from 14 to 182 SDMs
- GDPS also performs SDM related actions in parallel within an SDM LPAR
 - For example XSTART and XRECOVER processing

XRC Scales

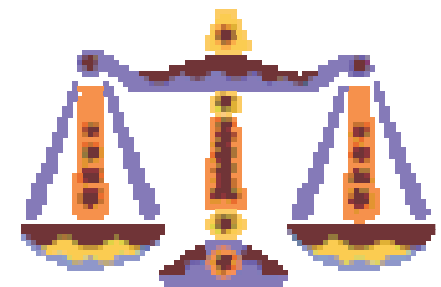

GDPS/Global Mirror – Site 1 Failure

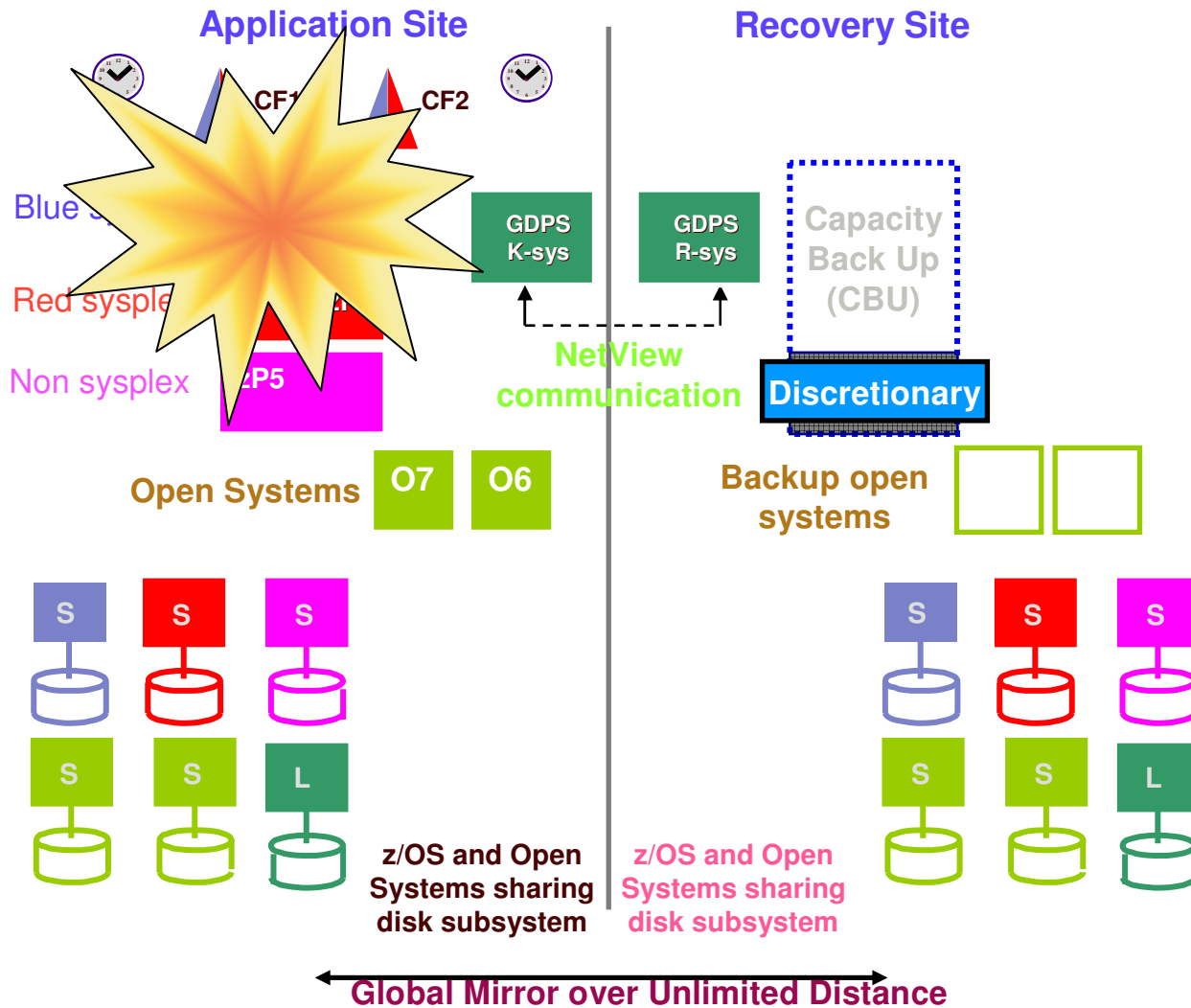

- **Application site can have single z/OS Systems, Open Systems, Systems in a Sysplex**
- **All data (z/OS and Open Systems) can be mirrored using Global Mirror**
- **K-sys activities**
 - Manages multiple Global Mirror sessions
 - Sends device info, scripts, alerts to R-sys
- **R-sys activities:**
 - Secondary disk recovery, CBU activation, activate backup LPARs, IPLs systems.

GDPS/Global Mirror – Site 1 Failure

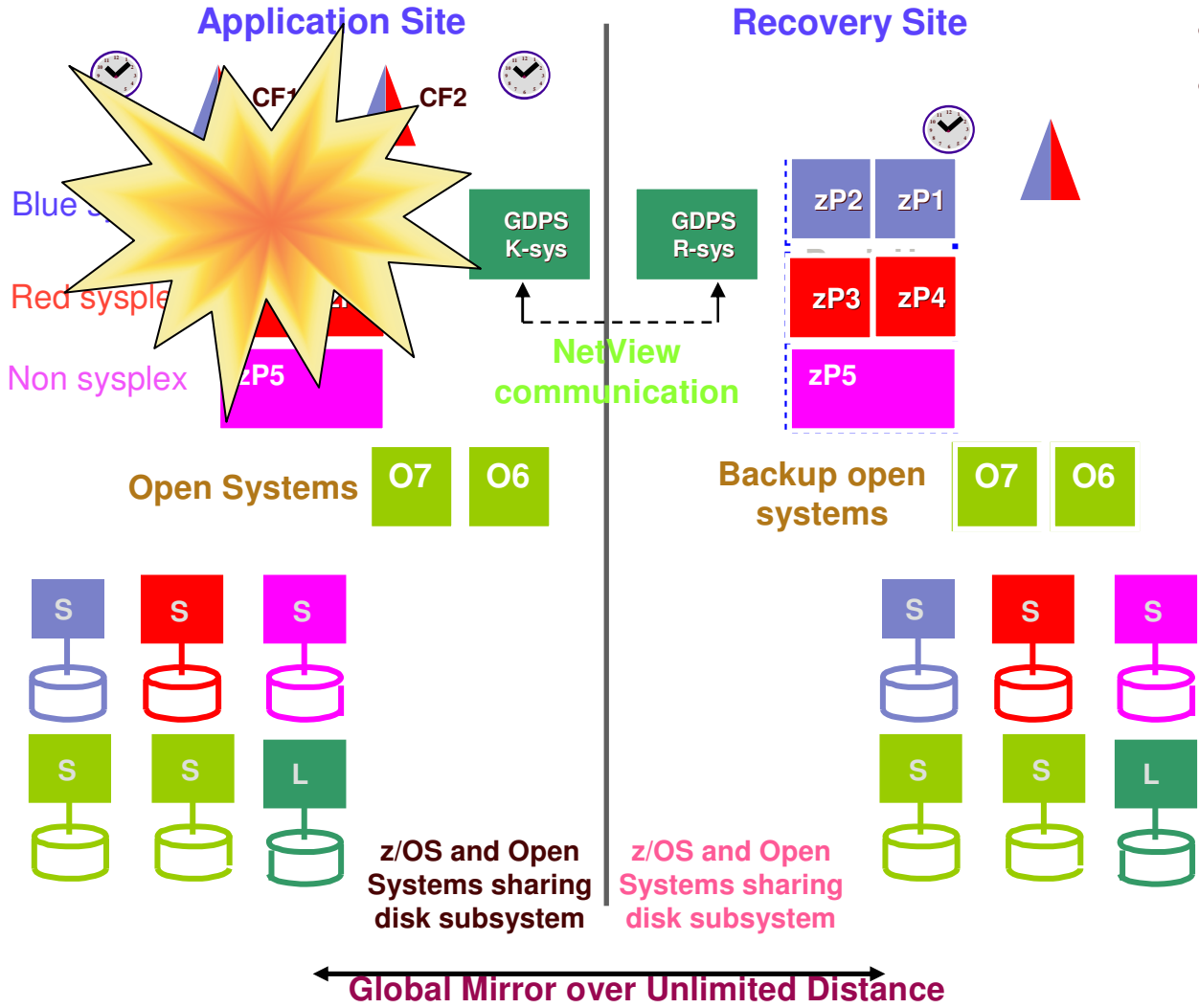

- **RTO < 1 hour**
- **RPO < 1 minute**
– (depends on bandwidth)

XRC & Global Mirror: Which One?

XRC	Global Mirror
Asynchronous. No app. impact	Asynchronous. No app. impact
Virtually unlimited distance	Virtually unlimited distance
zSeries Data <ul style="list-style-type: none"> • z/OS • Linux on zSeries LPAR or Guest • VM, VSE (consistent data if 1 CU) 	zSeries & Open Data
Requires additional MIPS on secondary site to support SDMs	Requires additional disk for additional FlashCopy version
Highly Scalable. Up to 285 coupled SDMs	Max 8 subsystems (w/o RPQ) 17 subsystems (with RPQ)
Supported by multiple vendors	Currently supported on IBM disk
Many customers and references. Many tools	Newer technology

GDPS/XRC & GDPS/Global Mirror: SOD

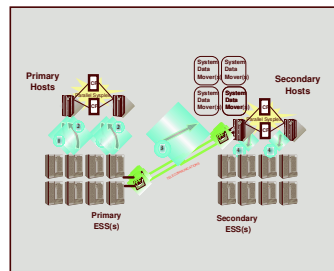

XRC

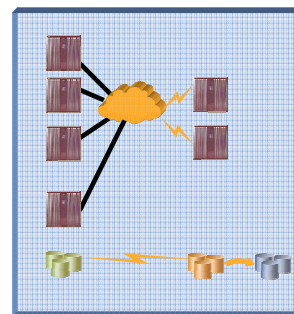
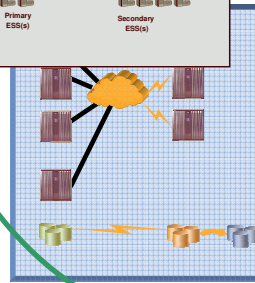
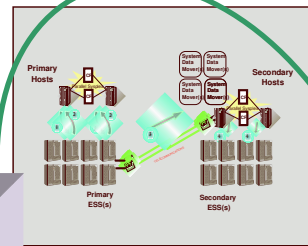

Global Mirror

Common
Restart
Point

Why choose? Do both!

- **Statement of Direction:**
Ability to form consistency groups from Global Mirror together with z/OS Global Mirror
- **Combine strengths of both:**
 - **z/OS Global Mirror:**
 - **z/OS and Linux on zSeries**
 - **Global Mirror for other open data**

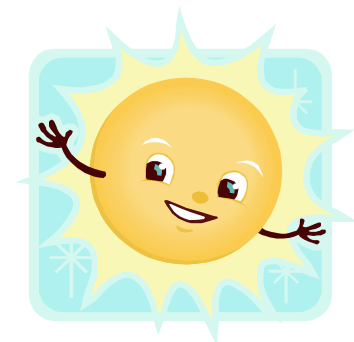

Continuous Availability and Disaster Recovery Solutions (3 site)

- ✓ Continuous Availability – Metro distance
- ✓ Disaster Recovery at unlimited distances

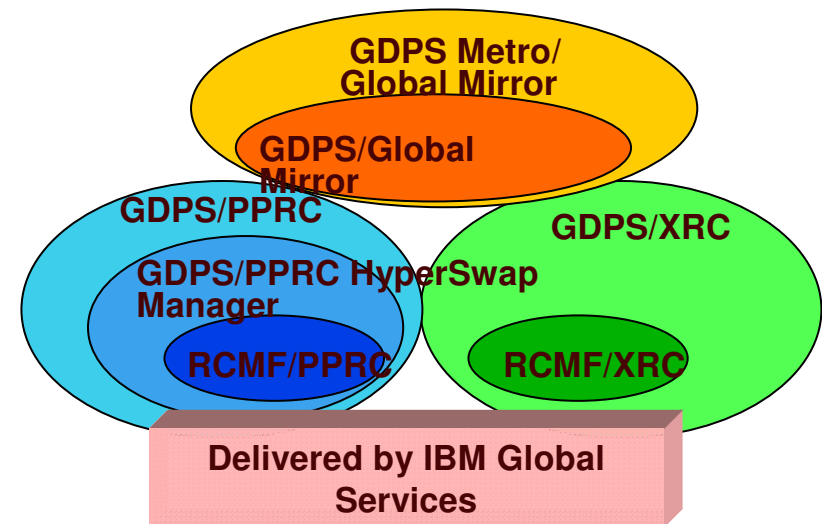

Continuous Availability and Disaster Recovery at unlimited distance (GDPS/PPRC & GDPS/XRC)

zSeries Solution

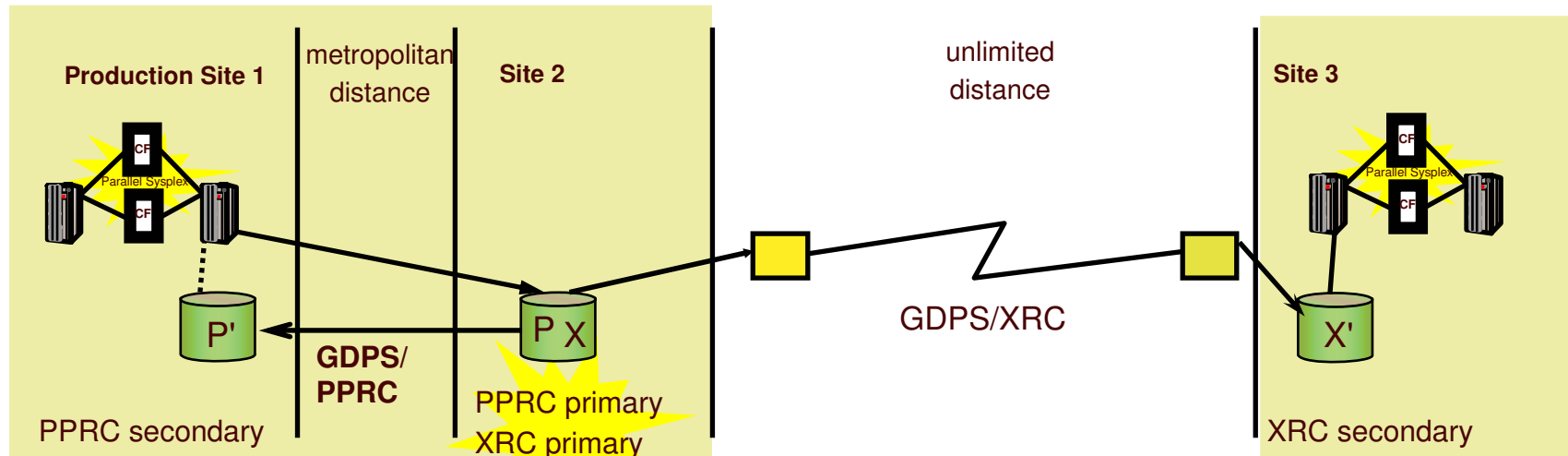

◀ Continuous Availability GDPS PPRC or GDPS/PPRC HM ▶

- Designed to provide continuous availability and no data loss between sites 1 and 2
- Sites 1 and 2 can be same building or campus distance to minimize performance impact
 - Site 2 servers optional

◀ Disaster/Recovery ▶

- Site 1 failure
 - ▶ Switch to Site 2 disk (if server exists on Site 2)
 - Site 3 can recover with no data loss in most instances
- Site 2 failure
 - ▶ Production continues in Site 1
- Site 1 and 2 failure
 - ▶ Failover to Site 3 with minimal data loss

Continuous Availability, No data loss, Unlimited Distance

z/OS Metro / Global Mirror (Future)

- If “B” copy lost, z/OS Global Mirror established with “A” copy
- When “B” disk available, resynchronize with just updates made
 - No need for full volume copy
 - Similar to PPRC Failover / Failback support

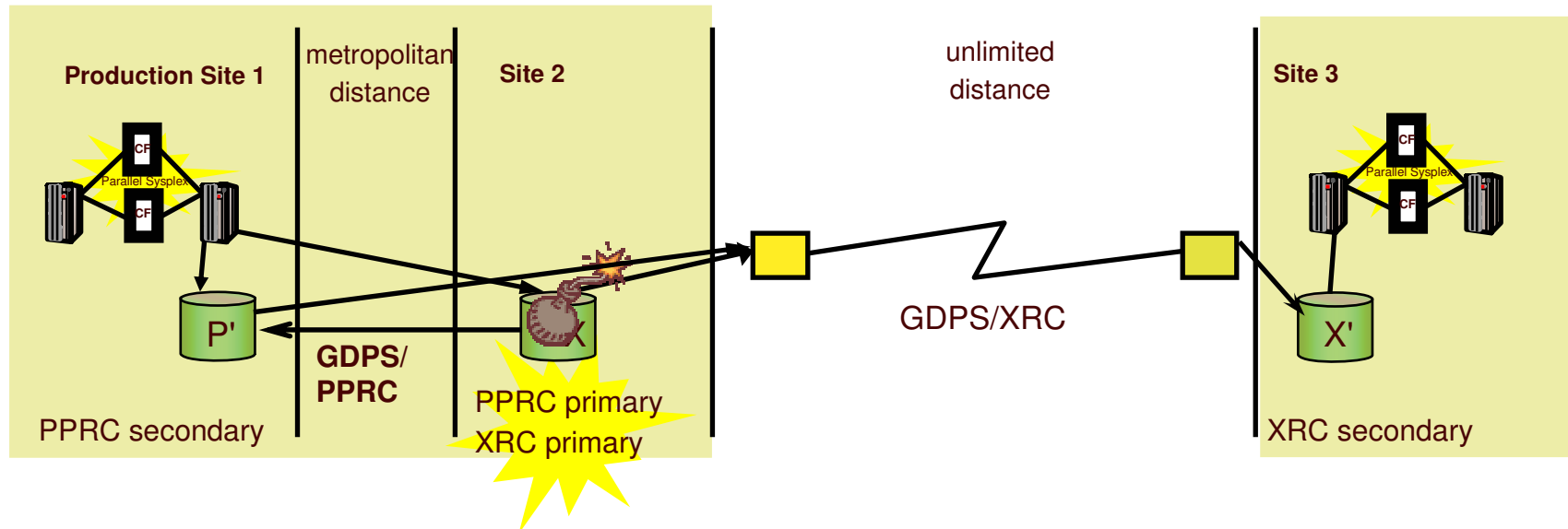

Continuous Availability and Disaster Recovery at unlimited distance (GDPS/Metro & Global Mirror)

zSeries and Open Solution

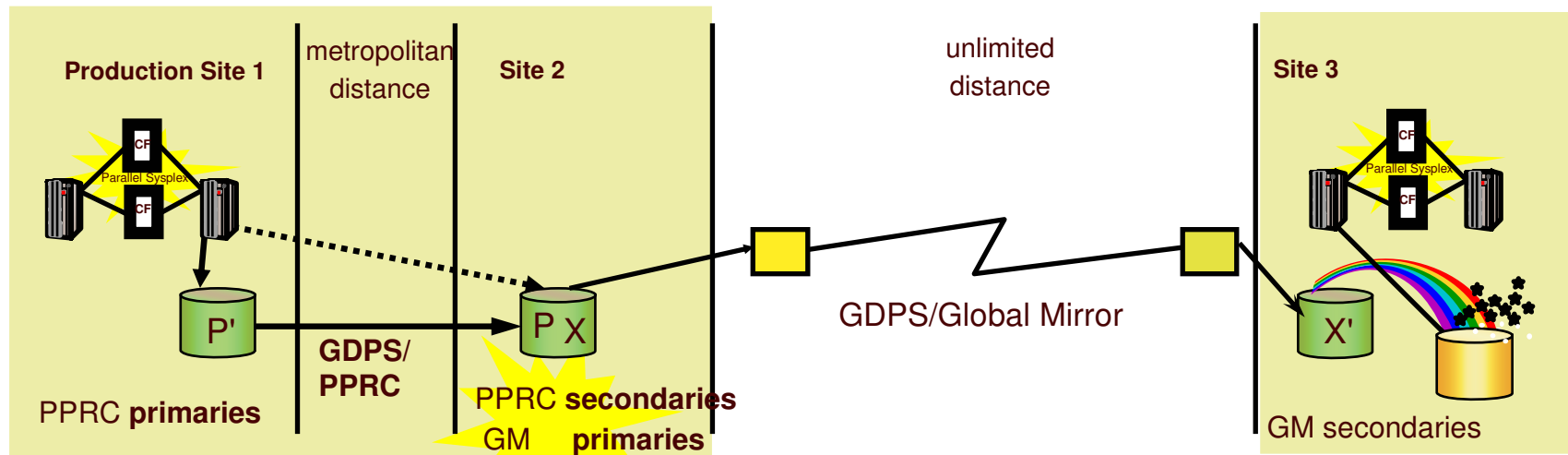

◀ Continuous Availability GDPS/PPRC ▶

- Designed to provide continuous availability and no data loss between sites 1 and 2
- Sites 1 and 2 can be same building or campus distance to minimize performance impact
 - Site 2 servers optional

◀ Disaster/Recovery ▶

- Site 1 failure
 - Switch to Site 2 disk (if server exists on Site 2)
 - Site 3 can recover with no data loss in most instances
- Site 2 failure
 - Production continues in Site 1
- Site 1 and 2 failure
 - Failover to Site 3 with minimal data loss

GDPS Managed coordinated solution for zSeries and open systems

Metro / Global Mirror (Future)

- If “B” copy lost, Global Mirror established with “A” copy
- When “B” disk available, resynchronize with just updates made
 - No need for full volume copy
 - Similar to PPRC Failover / Failback support

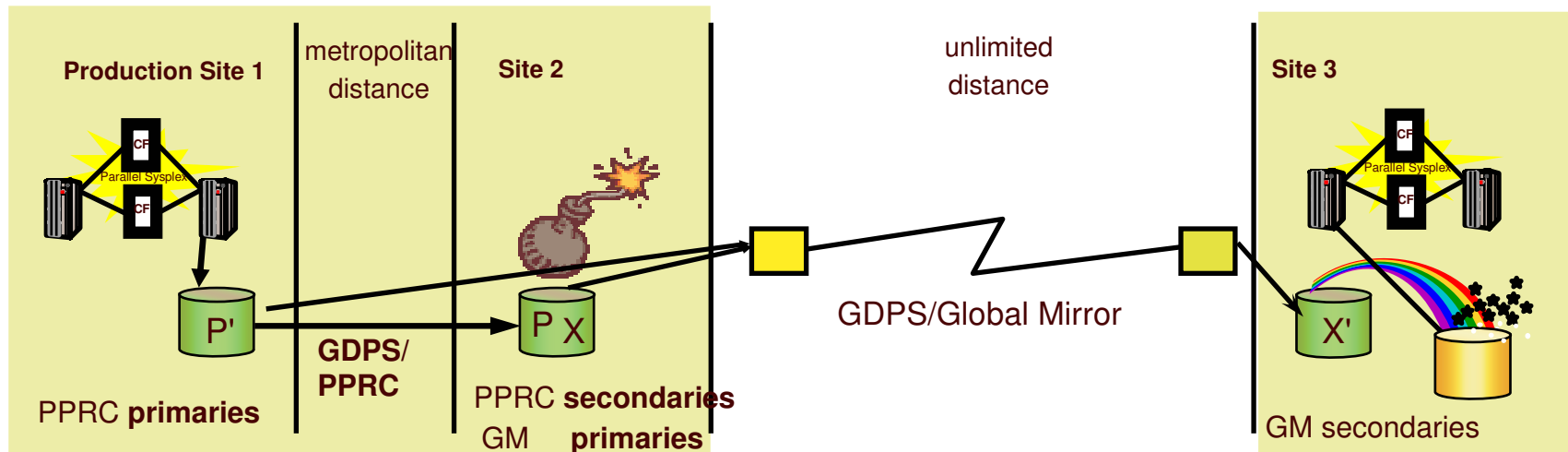

Future

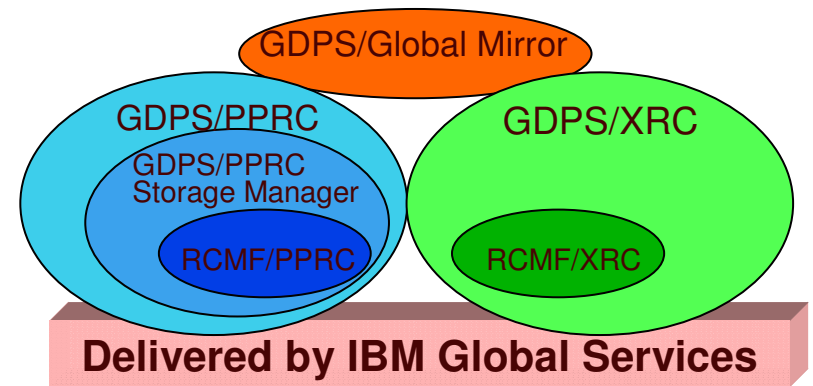

- ✓ GDPS/PPRC
- ✓ GDPS/XRC
- ✓ GDPS/Global Mirror
- ✓ 3-Site Solutions

IMS XRF Coexistence (GDPS V3.3 SPE)

- GDPS HyperSwap Support
 - GDPS disables HyperSwap before IMS/XRF performs **HW reserve**
 - When IMS releases Reserves, it tells GDPS to re-enable HyperSwap again
- IMS code supporting functionality: APAR PK22473.
 - IMS uses the z/OS RESERVE service.
 - Coordinates products sensitive to hardware reserves

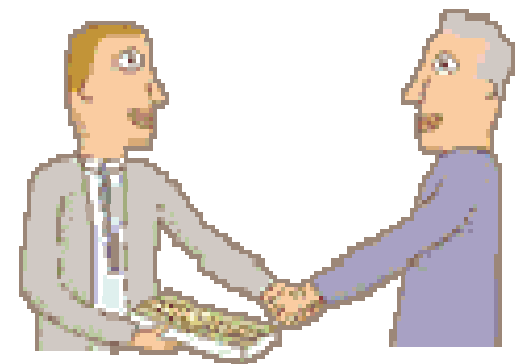

Zero suspend FlashCopy (Future GDPS Release)

- Consistent FlashCopy gives the possibility to FlashCopy XRC (or PPRC) secondary devices while the replication is still running
- Custom software is used to enable the FlashCopies to be issued in a very short timeframe
 - Single digit seconds for even a very large environment
- Currently available as a separate add-on for GDPS/XRC customers

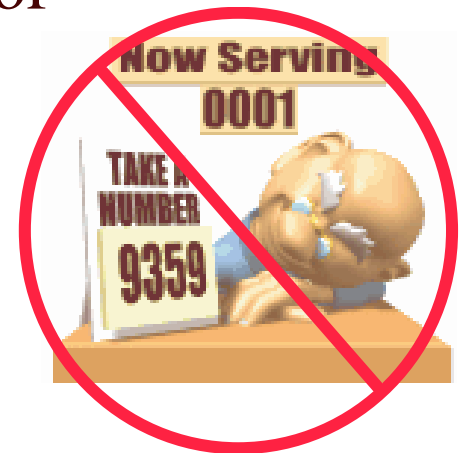

Zero Suspend FlashCopy...

- Before
 - Suspend XRC all volumes
 - FlashCopy secondary volumes (COPY/NOCOPY)
 - Resync XRC sessions (after 10s of minutes or longer)
 - Resync w/ FC active slows both FC and XRC. Under some conditions, can cause SDM delay and device blocking
- After
 - No XRC suspend, rather FREEZE on XRC control data set (20-30 seconds)
 - Logically establish FC
 - Remove constraint on CDS and allow XRC to continue
- Benefit
 - 10x, 20x or more faster
 - XRC is not suspended, no Resync needed
 - XRC continues as if nothing had happened

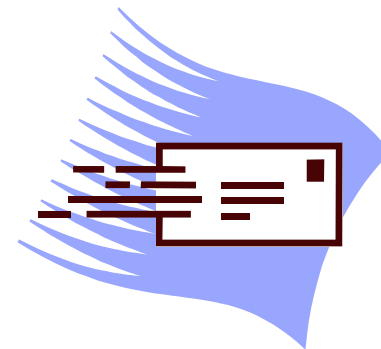

Multi-Reader for XRC (Future)

- **Secondary PAV / OA09238**
 - Multiple writers to update a single volume using dynamic PAVs
 - Provides greater parallelism in secondary I/O processing.
 - Results in lower RPO and reduces average session exposure and peak session exposure for heavily stressed configurations.
- **Multi-Reader**
 - Allows more parallelism in reading XRC sidefile entries from the XRC primary devices.

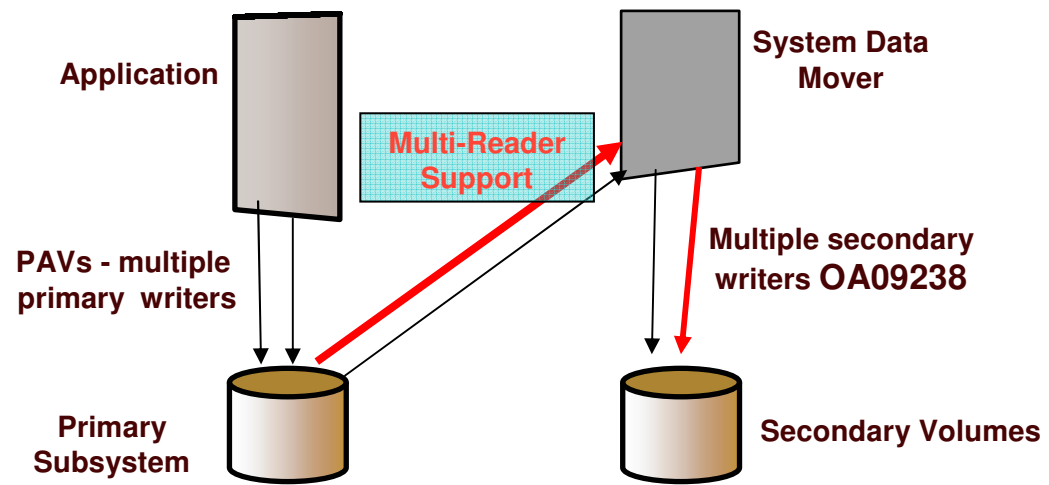

GDPS Global Mirror (Future)

- GDPS managed FlashCopy devices for testing purposes
- Remove the requirement to keep the R-Sys running continually in the remote location
 - Still required for recovery purposes and must be restarted to recover the environment

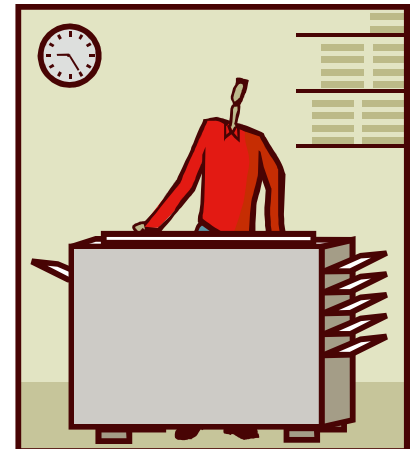

To Summarize

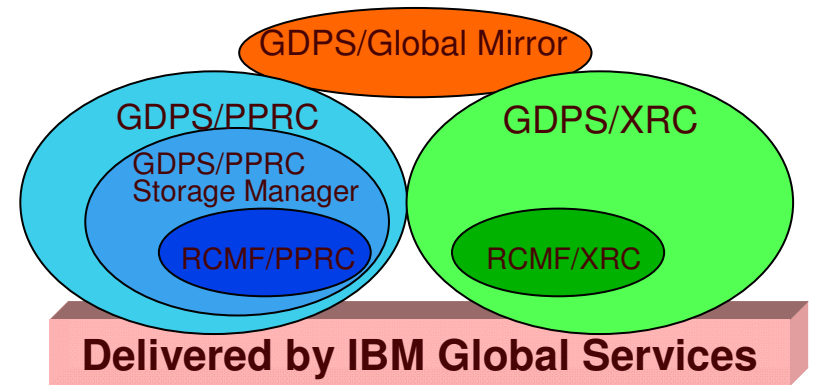

- ✓ GDPS V3.3
- ✓ Future planned items
- ✓ Future direction
- ✓ For More Information...

GDPS Enhancements (GDPS v3.3)

- **GDPS/PPRC HyperSwap Manager**
 - IOS Timing Trigger
- **GDPS/PPRC**
 - Enhanced Recovery Support (CF Duplexing)
 - Multi-Platform Resiliency for zSeries enhancements
- **GDPS/XRC**
 - XRC+ Support
 - Greater SDM Parallelism
 - Support for >14 SDMs
- **GDPS/Global Mirror**
 - Global Mirror Support
 - Metro/Global Mirror RPQ

GDPS Enhancements (post V3.3)

- **GDPS/PPRC HyperSwap Manager**
 - IMS/XRF Support (Coordinate Reserve / Release processing)
 - Subsystem granularity
- **GDPS/PPRC**
 - GDPS/PPRC Multi Platform Resiliency for zSeries
 - Phase 2: Stand-alone Linux on zSeries
- **GDPS/XRC**
 - Zero Suspend FlashCopy for GDPS/XRC
- **GDPS/Global Mirror**
 - “D” disk management
 - Optional “R-sys”
- **z/OS Metro / Global Mirror**
 - Incremental resynchronisation
- **STP (Sysplex Time Protocol)**

GDPS Directions

- **Common functions**
 - GUI Interface
- **CA / DR Extensions**
 - 3-site extensions
 - Expanding scalability
 - z/OS Healthchecker
- **Enterprise Data, Server, Workload Manager**
 - Active / Active
 - Coordinate with D/R tools for non-z platforms
 - AIX, HP-UX, MS, etc.
- **eBOD**
 - Policy driven configuration

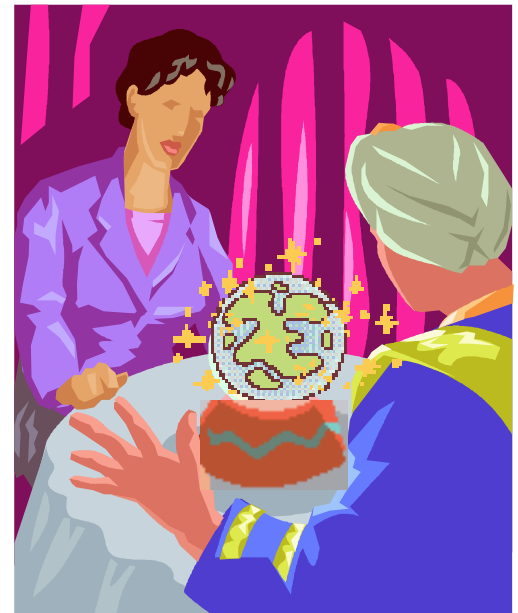

Additional Information



- **Detailed GDPS Presentation and Information e-mail:**
 - gdps@us.ibm.com
- **White Papers:**
 - *Business Continuity Considerations and the IBM eServer zSeries*
 - *GDPS - The Ultimate e-business Availability Solution* – GF22-5114
- **Publications:**
 - **(new)** GDPS Family of Offerings Introduction to Concepts and Capabilities - SG24-6374
 - *TotalStorage Disaster Recovery Solutions Redbook* – SG24-6547
 - *z/OS Advanced Copy Services* – SC35-0428
 - ESS Copy Services on zSeries Redpiece - SG24-5680
 - ESS Copy Services on Open Redpiece – SG24-5757
- **GDPS Services Offerings**
 - GDPS Announcement
 - GDPS/XRC Announcement

- www.ibm.com/systems/z/gdps

Additional Information ...

- **Attack of the clones: GDPS solutions for your heterogeneous environment**
 - NOSHIR DHONDY, DAVID PETERSEN, AND DAVID RAFTEN
- www.ibm.com/servers/eserver/zseries/zos/bkserv/hot_topics.html
- **GDPS Family - An Introduction to Concepts and Capabilities (SG24-6374)**
 - www.redbooks.ibm.com/redbooks/pdfs/sg246374.pdf



Business Continuity Services Offerings

- **GDPS Technical Consulting Workshop (TCW)**
 - **Designed to ensure the GDPS Availability & Recovery solution will meet the Client's business requirements as they relate to continuous availability and recovery. The workshop will look at the site-to-site connectivity necessary to implement GDPS and identify the high level tasks that will be needed to implement.**
- **Business Continuity Solution Workshop**
 - **This program is designed to introduce the elements of IBM's products and services that form a Business Continuity Solution. Your time will be divided between interactive presentations tailored to your specific requirements and "hands on labs" that allow you to actually experience the capabilities of each element. Over the course of three days at our Washington System Center you will explore topics such as: Disk and Tape Copy Services, Network Options, Server Considerations, System Performance Planning, and Implementation Services.**
- **BCRS Business Continuity Health Check**
 - **The Health Check is an independent review that creates an action plan addressing continuity issues such as existing capabilities, costs, future technology, and resource requirements.**
- **I/O Bandwidth Analysis**
 - **IBM will use trace data collected from the customer environment to determine the requirements to configure and implement Remote Copy. IBM will create a written report of the I/O Sizing and Bandwidth Analysis of your existing environment. The report will include an analysis of your full mainframe DASD environment, as well as an analysis of a subset of that environment representing the minimum DASD required to support Remote Copy.**

Additional Information

- **Questions?**

